

Technical Information

RIA15

Loop-powered 4 to 20 mA process indicator with optional HART® communication



Compact process indicator with very low voltage drop for universal use to display 4 to 20 mA/HART® signals

Application

- Display of 4 to 20 mA measured values or optionally up to four of a sensor's HART® process variables in all industries
- Use as primary or secondary HART® master
- Panel-mount housing or field housing as local display
- Scalable display value

Your benefits

- No external power supply required
- Voltage drop ≤ 1 V (HART® ≤ 1.9 V)
- 5-digit measured value display with 17 mm (0.67 in) digit height with dimension, bar graph and activatable backlighting
- Minimal installation depth
- Easy 3-key operation for configuring the device
- International approvals
ATEX, IECEx, FM, CSA
- SIL interference freeness according to EN 61508
- Marine approval

Function and system design

Measuring principle

The RIA15 process indicator is integrated in the 4 to 20 mA or HART® loop and transmits the measuring signal or HART® process variables in digital form. The process indicator does not require an external power supply. It is powered directly from the current loop.

The device meets the requirements of the HART® Communication Protocol Specifications and can be used with devices with HART® Revision ≥ 5.0 and higher.

The LC display is easy to read even in bright sunlight and enables 5-digit, scalable measured value display. In addition to measured value display, the associated value dimension and a bar graph can be easily configured with simple 3-key operation.

The device can also be operated with backlighting where necessary. In such cases pay attention to the higher voltage drop.

For certain Endress+Hauser sensors/transmitters, the RIA15 can be used to configure the sensors in addition to displaying measured values. For this, the RIA15 must be ordered with the corresponding option "Level" or "Analysis".

Measuring system

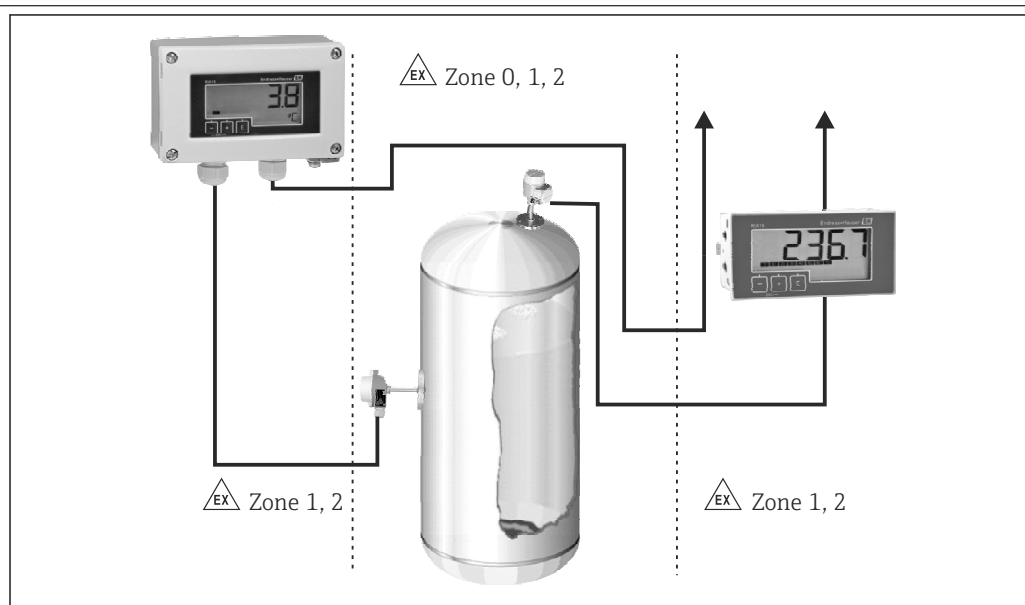

1 RIA15 as field and panel display

Input

Voltage drop	
Standard device with 4 to 20 mA communication	$\leq 1.0 \text{ V}$
Device with HART® communication	$\leq 1.9 \text{ V}$
Display lighting	additionally 2.9 V

HART® input impedance	
Rx =	40 k Ω
Cx =	2.3 nF

Measured variable

The input variable is either the 4 to 20 mA current signal or the HART® signal. HART® signals are not affected.

Measuring range 4 to 20 mA (scalable, reverse polarity protection)
 Max. input current 200 mA

Power supply

Terminal assignment

NOTICE

SELV/Class 2 device

- ▶ The device may only be powered by a power unit with an energy-limited circuit in accordance with IEC 61010-1: 'SELV or Class 2 circuit'.

Device destroyed if current too high

- ▶ Do not operate the device at a voltage source without a current limiter. Instead, operate the device only in the current loop with a transmitter.

Terminal	Description
+	Positive connection, current measurement
-	Negative connection, current measurement (without backlighting)
LED	Negative connection, current measurement (with backlighting)
□	Auxiliary terminals (electrically connected internally)
⊥	Functional grounding: <ul style="list-style-type: none"> ▪ Panel-mounted device: Terminal on the rear of the housing ▪ Field device: Terminal in the housing

Connection 4 to 20 mA

	Connection without backlighting	Connection with backlighting
Connection with transmitter power supply and transmitter	<p>1 Transmitter power supply</p>	<p>1 Transmitter power supply</p>
Connection with transmitter power supply and transmitter using the auxiliary terminal	<p>1 Transmitter power supply</p>	<p>1 Transmitter power supply</p>

	Connection without backlighting	Connection with backlighting
Connection with PLC and transmitter	<p>1 PLC</p> <p>A0019720</p>	<p>1 PLC</p> <p>A0019721</p>
Connection without transmitter power supply directly in the 4 to 20 mA circuit	<p>2 4 to 20 mA power source</p> <p>A0017708</p>	<p>2 4 to 20 mA power source</p> <p>A0017709</p>

HART® connection

	Circuit diagram / Description
2-wire sensor with process indicator and LPS, without backlighting	<p>1 Sensor 2 Power supply 3 HART® resistor</p> <p>A0019567</p>
2-wire sensor with process indicator and LPS, with backlighting	<p>1 Sensor 2 Power supply 3 HART® resistor</p> <p>A0019568</p>
4-wire sensor with process indicator and LPS, without backlighting	<p>1 HART® resistor 2 Current meter 3 Sensor 4 Power supply</p> <p>A0019570</p>

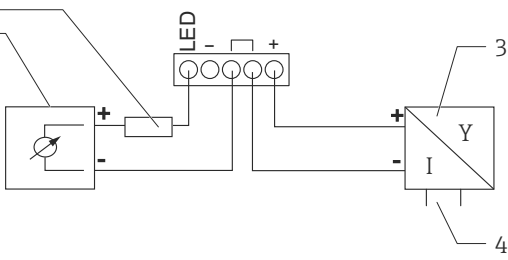
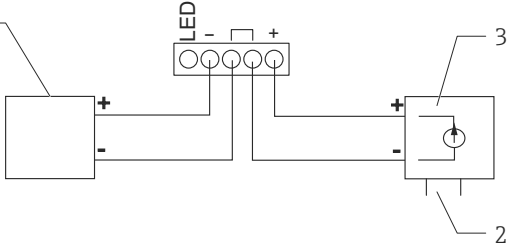
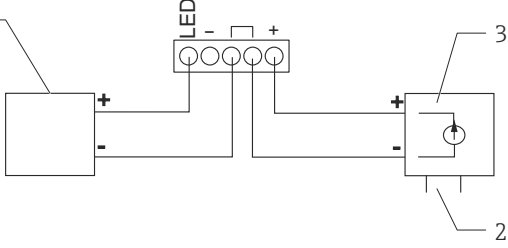
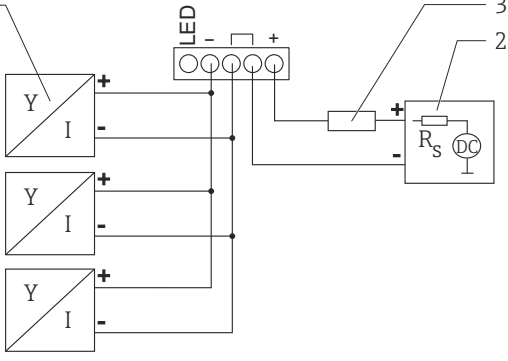
Circuit diagram / Description	
<p>4-wire sensor with process indicator and LPS, with backlighting</p>	 <p>1 HART® resistor 2 Current meter 3 Sensor 4 Power supply</p> <p style="text-align: right;">A0019571</p>
<p>Current output with process indicator and actuator (e.g. actuator valve), without backlighting</p>	 <p>1 Actuator 2 Power supply 3 Current output</p> <p style="text-align: right;">A0019573</p>
<p>Current output with process indicator and actuator (e.g. actuator valve), with backlighting</p>	 <p>1 Actuator 2 Power supply 3 Current output</p> <p style="text-align: right;">A0019574</p>
<p>Multidrop 2-wire sensors with process indicator and LPS</p>	 <p>1 Sensors 2 Power supply 3 HART® resistor</p> <p style="text-align: right;">A0019575</p>

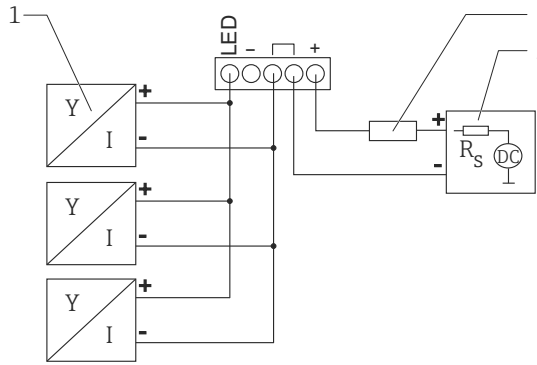
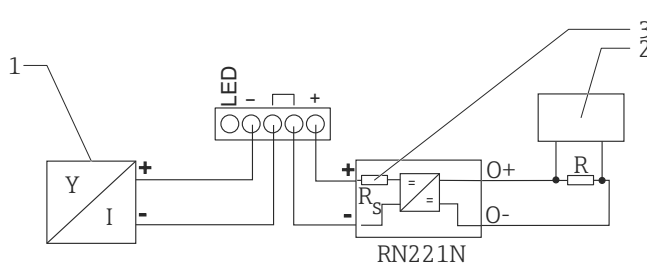
Circuit diagram / Description	
<p>Multidrop 2-wire sensors with process indicator and LPS, with backlighting</p>	 <p>1 Sensors 2 Power supply 3 HART® resistor</p> <p style="text-align: right;">A0019722</p>
<p>2-wire sensor with process indicator and active barrier RN221N as LPS</p>	 <p>1 Sensor 2 HART® primary master 3 HART® resistor</p> <p style="text-align: right;">A0019576</p>

i The 230 Ω HART® communication resistor in the signal line is always necessary in the case of a low-impedance power supply. It must be installed between the power supply and the indicator.

A HART® communication resistance module is available as an accessory → 14.

Connection with optional HART® communication resistance module

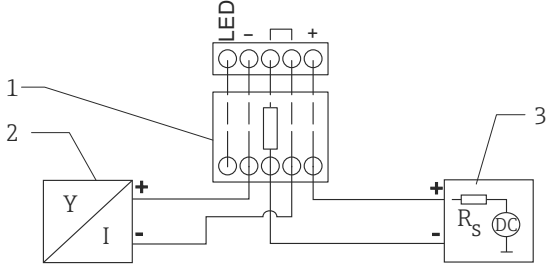
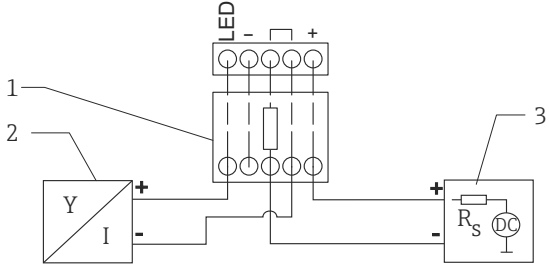
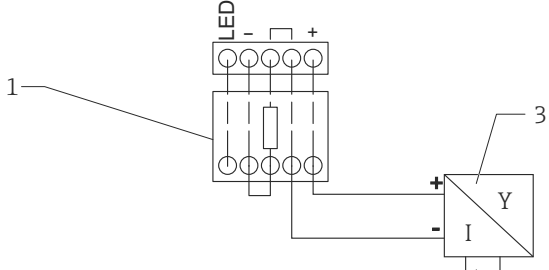
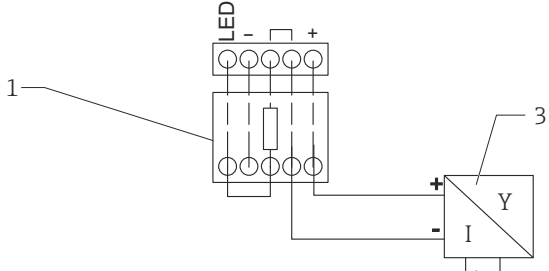
	Circuit diagram / Description
<p>2-wire sensor with process indicator and transmitter power supply, without backlighting</p>	 <p>1 HART® communication resistance module 2 Sensor 3 Power supply</p> <p style="text-align: right;">A0020839</p>
<p>2-wire sensor with process indicator and transmitter power supply, with backlighting</p>	 <p>1 HART® communication resistance module 2 Sensor 3 Power supply</p> <p style="text-align: right;">A0020840</p>
<p>4-wire sensor with process indicator and transmitter power supply, without backlighting</p>	 <p>1 HART® communication resistance module 2 Power supply 4-wire device 3 Sensor</p> <p style="text-align: right;">A0020837</p>
<p>4-wire sensor with process indicator and transmitter power supply, with backlighting</p>	 <p>1 HART® communication resistance module 2 Power supply 4-wire device 3 Sensor</p> <p style="text-align: right;">A0020838</p>

Wiring with switchable backlighting

An additional current-limited current source is required to implement switchable backlighting, e.g. active barrier RN221N. This current source is used to power the LED backlighting of up to 7 RIA15 process indicators without generating an additional voltage drop in the measurement loop. The backlighting can be switched on and off using an external switch.

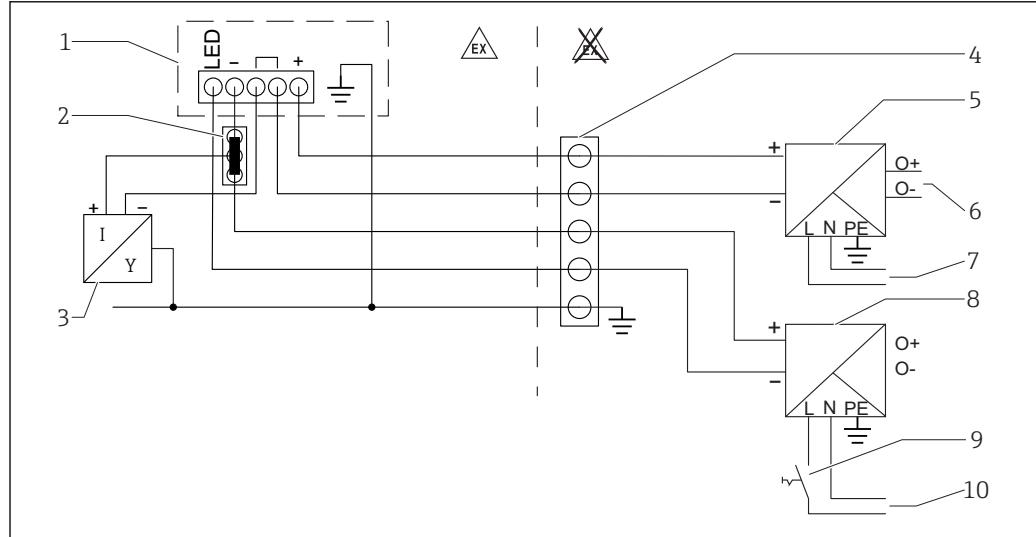

A002B248

- 1 Process indicator RIA15
- 2 3-wire connector, e.g. WAGO 221 series
- 3 2-wire sensor
- 4 Terminal block on DIN rail
- 5 Active barrier, e.g. RN221N
- 6 4 to 20 mA output to the control unit
- 7 Power supply
- 8 Current source, e.g. RN221N
- 9 Switch to activate backlighting
- 10 Power supply

Supply voltage

NOTICE

SELV/Class 2 device

- ▶ The device may only be powered by a power unit with an energy-limited circuit according to UL/EN/IEC 61010-1 Section 9.4 or Class 2 according to UL 1310: 'SELV or Class 2 circuit'.

The process indicator is loop-powered and does not require any external power supply. The voltage drop is ≤ 1 V in the standard version with 4 to 20 mA communication, ≤ 1.9 V with HART[®] communication and an additional 2.9 V if display lighting is used.

Performance characteristics

Reference operating conditions

Reference temperature 25 °C \pm 5 °C (77 °F \pm 9 °F)
 Humidity 20 to 60 % relative humidity

Maximum measured error

Input	Range	Measured error of measuring range
Current	4 to 20 mA Over range up to 22 mA	± 0.1 %

Resolution

Signal resolution > 13 bit

Influence of ambient temperature

< 0.02 %/K (0.01 %/°F) of measuring range

Warm-up period 10 minutes

Installation

Mounting location

Panel housing

The device is designed for use in a panel.

Required panel cutout 45x92 mm (1.77x3.62 in)

Field housing

The field housing version is designed for use in the field. The unit is mounted directly on a wall, or on a pipe with a diameter of up to 2 " with the aid of an optional mounting bracket. An optional weather protection cover protects the device from the effects of weather conditions.

Orientation

Panel housing

The orientation is horizontal.

Field housing

The device must be mounted in such a way that the cable entries point downwards.

Environment

Ambient temperature range

-40 to 60 °C (-40 to 140 °F)



At temperatures below -25 °C (-13 °F) the readability of the display can no longer be guaranteed.

Storage temperature

-40 to 85 °C (-40 to 185 °F)

Climate class

IEC 60654-1, Class B2

Operating altitude

Up to 5 000 m (16 400 ft) above MSL in accordance with IEC61010-1

Degree of protection

Panel housing

IP65 at front, IP20 at rear

Field housing

Aluminum housing: degree of protection IP66/67, NEMA 4x

Plastic housing: degree of protection IP66/67

Electromagnetic compatibility

- Interference immunity:
As per IEC61326 (Industrial Environments) / NAMUR NE 21
Maximum measured error < 1 % o. MR
- Interference emission:
As per IEC61326, Class B

Electrical safety

Class III, overvoltage protection category II, pollution degree 2

Mechanical construction

Design, dimensions

Panel-mount housing

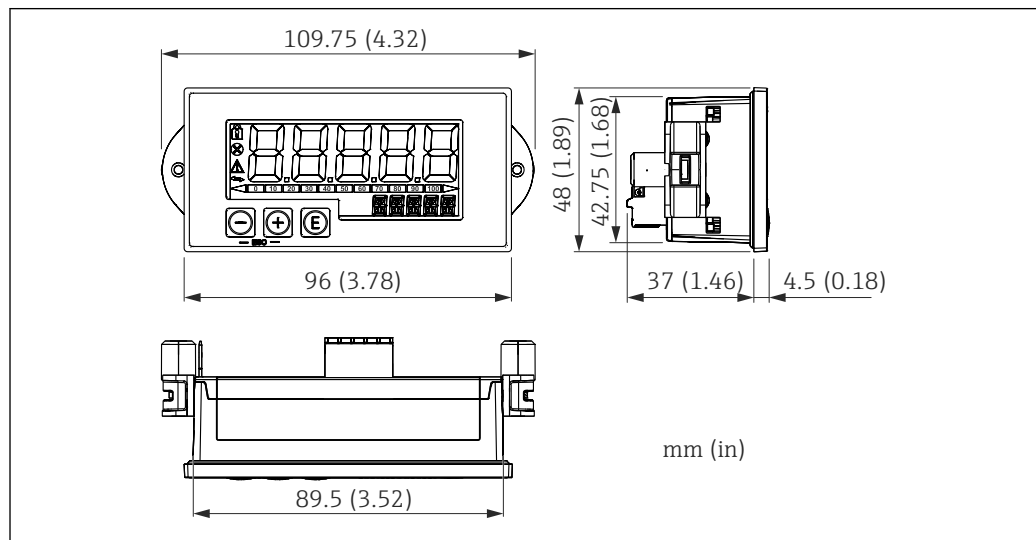

A0017721

2 Dimensions of the panel housing

Required panel cutout 45x92 mm (1.77x3.62 in), max. panel thickness 13 mm (0.51 in).

Field housing

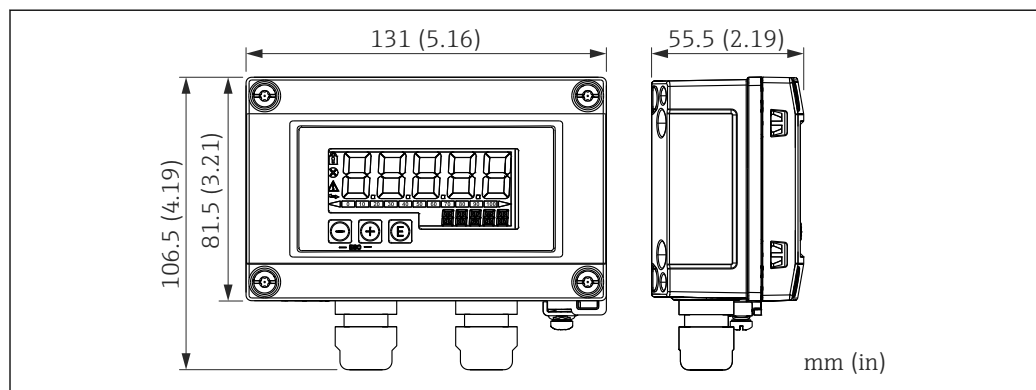

A0017722

3 Dimensions of the field housing incl. cable entries (M16)

Weight

Panel-mount housing

115 g (0.25 lb.)

Field housing

- Aluminum: 520 g (1.15 lb)
- Plastic: 300 g (0.66 lb)

Materials

Panel-mount housing

Front: aluminum

Rear panel: polycarbonate PC

Field housing

Aluminum or plastic (PBT with steel fibers, antistatic)

Operability

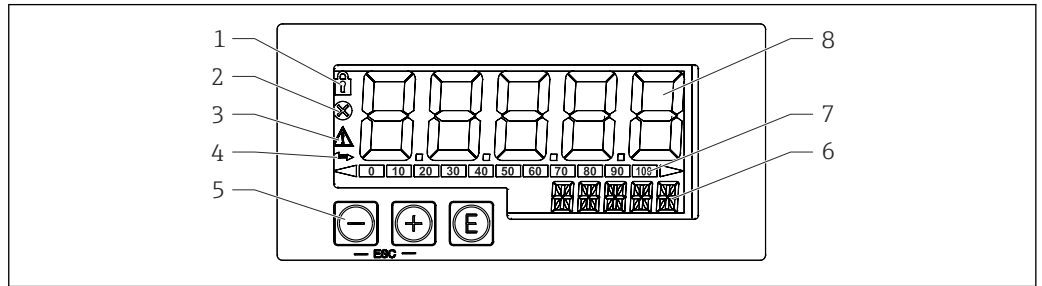

Local operation



4 Display and operating elements of the process indicator

- 1 Symbol: operating menu disabled
- 2 Symbol: error
- 3 Symbol: warning
- 4 Symbol: communication active (only for HART® option)
- 5 Operating keys "-", "+", "E"
- 6 14-segment display for unit/TAG
- 7 Bar graph with indicators for under range and over range
- 8 5-digit 7-segment display for measured value, digit height 17 mm (0.67 in), display range -19999 to 99999

The device is operated with the 3 operating keys on the front of the housing. The device setup can be disabled with a 4-digit user code. If the setup is disabled, a padlock symbol appears on the display when an operating parameter is selected.

 <small>A0017716</small>	Enter key; calling up the operating menu, confirming the option/setting parameters in the operating menu
 <small>A0017714</small>	Selecting and setting values in the operating menu; pressing the - and + keys simultaneously takes the user back up a menu level. The configured value is not saved (ESC)
 <small>A0017715</small>	

RIA15 in conjunction with the Micropilot FMR20

The RIA15 can be used for the basic commissioning of the Micropilot FMR20 radar level sensor.

The following settings can be made for the FMR20 via the 3 operating keys on the front of the RIA15:

- Unit
- Empty and full calibration
- Mapping area if the measured distance does not match the actual distance

The following order options are available to be able to use this function:

FMR20 product structure, feature 620 "Accessory enclosed":

- Option R4: "Remote display RIA15, non-hazardous"
- Option R5: "Remote display RIA15, hazardous"

RIA15 product structure, feature 030 "Input":

Option 3: "4 to 20 mA current signal + HART + level"

RIA15 in conjunction with the Waterpilot FMX21

The RIA15 can be used for the basic commissioning of the Waterpilot FMX21 hydrostatic level sensor.

The following settings can be made for the FMX21 via the 3 operating keys on the front of the RIA15:

- Pressure unit
- Level unit
- Temperature unit
- Zero adjustment (only for gauge pressure sensors)

- Empty and full pressure adjustment
- Empty and full level adjustment
- Reset to factory defaults

The following order options are available to be able to use this function:

FMX21 product structure, feature 620 "Accessory enclosed":

- Option R4: "Remote display RIA15, non-hazardous"
- Option R5: "Remote display RIA15, hazardous"

RIA15 product structure, feature 030 "Input":

Option 3: "4 to 20 mA current signal + HART + level"

RIA15 product structure, feature 620 "Accessory enclosed":

Option PF: "1 x cable gland M16 with pressure compensation membrane for FMX21"

RIA15 in conjunction with the Gammapiot FMG50

The RIA15 can be used for the basic commissioning of the Gammapiot FMG50 radar level sensor.

The following settings can be made for the FMG50 via the 3 operating keys on the front of the RIA15:

- Basic configuration of the "Level" operating mode (continuous level measurement)
- Basic configuration of the "Point Level" operating mode (point level detection)
- Basic configuration of the "Density" operating mode (density measurement)

The following order options are available to be able to use this function:

- FMG50 product structure
- RIA15 product structure, feature 030 "Input":
Option 3: "4 to 20 mA current signal + HART + level ... FMG50"

RIA15 in conjunction with the Proservo NMS8x servo tank gauging device

The RIA15 can be used for the basic commissioning of the Proservo NMS80, NMS81 and NMS83 servo tank gauging devices.

The following settings can be made for the NMS8x via the 3 operating keys on the front of the RIA15:

- Measuring command
- Measuring status
- Balance status

The following order options are available to be able to use this function:

- NMS8x product structure
- RIA15 product structure, feature 030 "Input":
Option 5: "4 to 20 mA current signal + HART + level ... NMS8x"

RIA15 in conjunction with the Liquiline CM82

The RIA15 can be used for the basic commissioning of the Liquiline CM82 transmitter.

The following settings can be made for the CM82 via the 3 operating keys on the front of the RIA15:

- Units for the connected sensor
- Current output range
- Diagnostic information

The following order options are available to be able to use this function:

CM82 product structure, feature 620 "Accessory enclosed":

- Option R4: "Remote display RIA15, non-hazardous"
- Option R5: "Remote display RIA15, hazardous"

RIA15 product structure, feature 030 "Input":

Option 4: "4 to 20 mA current signal + HART + analysis"

Certificates and approvals

CE mark

The product meets the requirements of the harmonized European standards. As such, it complies with the legal specifications of the EC directives. The manufacturer confirms successful testing of the product by affixing to it the CE-mark.

EAC mark

The product meets the legal requirements of the EEU guidelines. The manufacturer confirms the successful testing of the product by affixing the EAC mark.

Ex approval	Information about currently available Ex versions (ATEX, FM, CSA, etc.) can be supplied by your E+H Sales Center on request. All explosion protection data are given in a separate documentation which is available upon request.
Functional safety	SIL interference freeness according to EN61508 (optional)
Marine approval	Marine approval (optional)
HART® communication	The indicator is registered by the HART® Communication Foundation. The device meets the requirements of the HART® Communication Protocol Specifications, May 2008, Revision 7.1. This version is downwards compatible with all sensors/actuators with HART® versions ≥ 5.0.
Other standards and guidelines	<ul style="list-style-type: none"> ▪ IEC 60529: Degrees of protection provided by enclosures (IP code) ▪ IEC 61010-1: 2010 cor 2011 Safety requirements for electrical equipment for measurement, control and laboratory use ▪ NAMUR NE21, NE43 Association for Standards for Control and Regulation in the Chemical Industry

Ordering information

Detailed ordering information is available for your nearest sales organization www.addresses.endress.com or in the Product Configurator under www.endress.com :

1. Click Corporate
2. Select the country
3. Click Products
4. Select the product using the filters and search field
5. Open the product page

The Configuration button to the right of the product image opens the Product Configurator.



Product Configurator - the tool for individual product configuration

- Up-to-the-minute configuration data
- Depending on the device: Direct input of measuring point-specific information such as measuring range or operating language
- Automatic verification of exclusion criteria
- Automatic creation of the order code and its breakdown in PDF or Excel output format
- Ability to order directly in the Endress+Hauser Online Shop

Accessories

Various accessories, which can be ordered with the device or subsequently from Endress+Hauser, are available for the device. Detailed information on the order code in question is available from your local Endress+Hauser sales center or on the product page of the Endress+Hauser website: www.endress.com.

Device-specific accessories

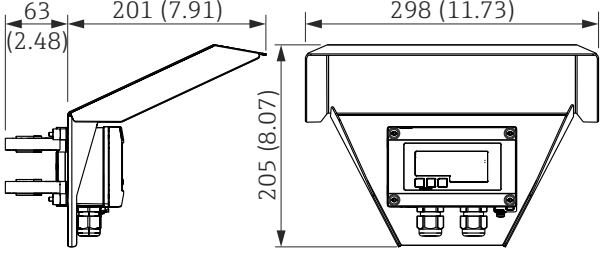
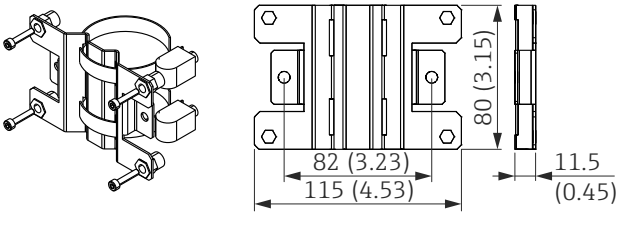
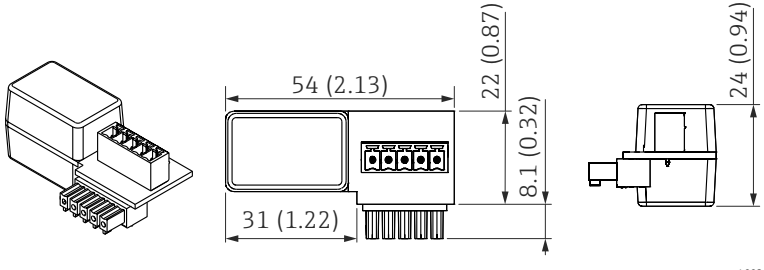
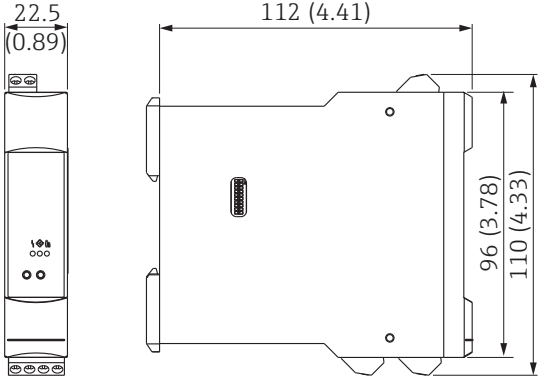
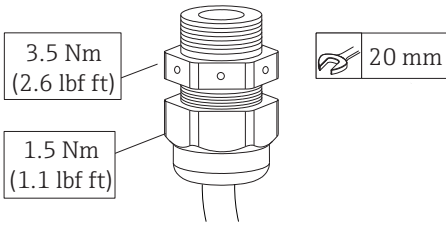
<p>Protective cover</p>	 <p>5 Dimensions of protective cover, engineering unit mm (in)</p> <p>A0017731</p>
<p>Mounting kit for wall/pipe mounting</p>	 <p>6 Dimensions of mounting bracket, engineering unit mm (in)</p> <p>A0017801</p>
<p>HART® communication resistance module</p>	 <p>7 Dimensions of communication resistance module, engineering unit mm (in)</p> <p>A0020858</p>
<p>Active barrier RN221N</p>	 <p>8 Dimensions of active barrier, engineering unit mm (in)</p> <p>For further information, see TI00073R/09/</p> <p>A0028251</p>
<p>M16 cable gland with integrated pressure compensation membrane</p>	 <p>3.5 Nm (2.6 lbf ft)</p> <p>1.5 Nm (1.1 lbf ft)</p> <p>20 mm</p> <p>A0036045</p>

Service-specific accessories

Accessories	Description
Applicator	<p>Software for selecting and sizing Endress+Hauser measuring devices:</p> <ul style="list-style-type: none"> ▪ Calculation of all the necessary data for identifying the optimum measuring device: e.g. pressure loss, accuracy or process connections. ▪ Graphic indication of the calculation results <p>Administration, documentation and access to all project-related data and parameters over the entire life cycle of a project.</p> <p>Applicator is available:</p> <ul style="list-style-type: none"> ▪ Via the Internet: https://wapps.endress.com/applicator ▪ On CD-ROM for local PC installation.
W@M	<p>Life cycle management for your plant</p> <p>W@M supports you with a wide range of software applications over the entire process: from planning and procurement, to the installation, commissioning and operation of the measuring devices. All the relevant device information, such as the device status, spare parts and device-specific documentation, is available for every device over the entire life cycle.</p> <p>The application already contains the data of your Endress+Hauser device. Endress+Hauser also takes care of maintaining and updating the data records.</p> <p>W@M is available:</p> <ul style="list-style-type: none"> ▪ Via the Internet: www.endress.com/lifecyclemanagement ▪ On CD-ROM for local PC installation.

Supplementary documentation

- System components and data manager - solutions to complete your measuring point:
FA00016K/09
- Operating Instructions for process indicator RIA15: BA01073K/09
Operating Instructions for process indicator RIA15 with HART® communication: BA01170K/09
Brief Operating Instructions for process indicator RIA15 with HART® communication:
KA01141K/09
- Ex-related additional documentation:
 - ATEX/IEC II2(1)G Ex ia IIC T6: XA01028R/09
 - CSA IS, NI: XA01056K/09
 - FM IS, NI: XA01097K/09
 - cCSAus IS, NI: XA01368K/09
- Micropilot FMR20:
Technical Information TI01267F
Operating Instructions: BA01578F
- Waterpilot FMX21:
Technical Information: TI00431P
Operating Instructions: BA00380P
- Liquiline CM82:
Technical Information: TI01397C
Operating Instructions: BA01845C

www.addresses.endress.com
