

Operating Instructions

Liquicap M

FMI52 HART

Capacitive
Continuous level measurement for liquids



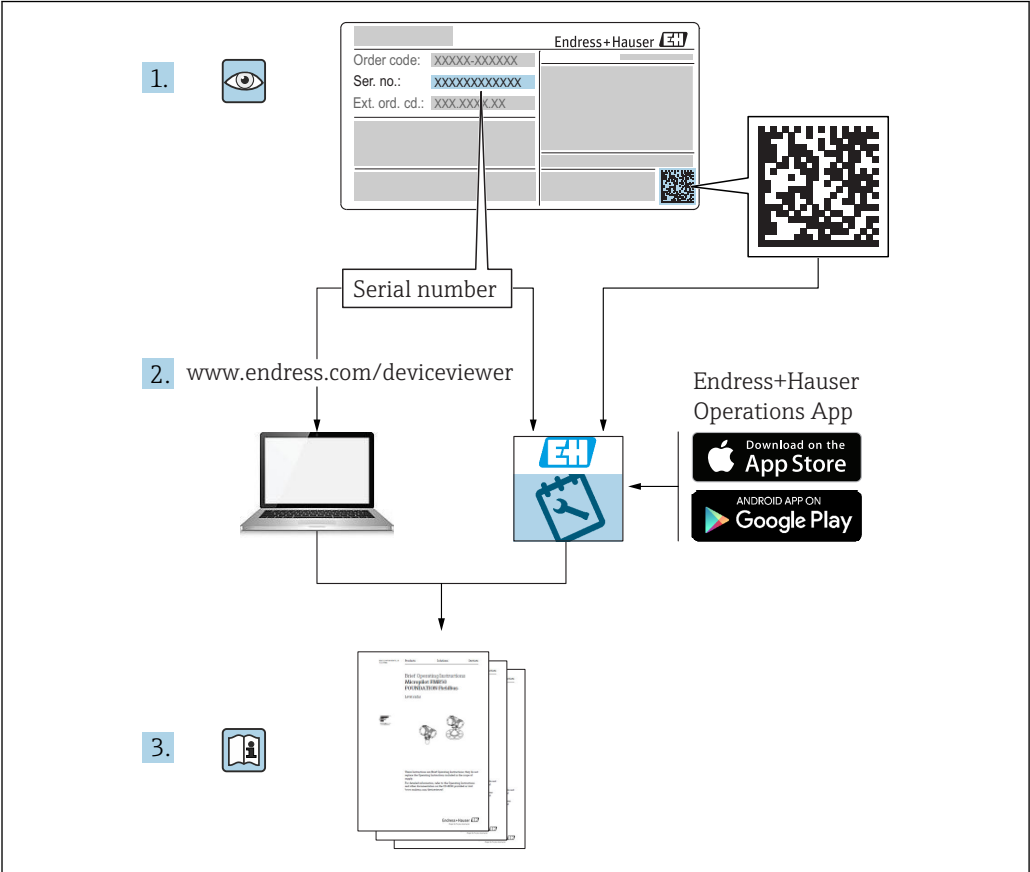

A0023555

Table of contents

1	About this document	6			
1.1	Document function	6			
1.2	Document conventions	6			
1.2.1	Safety symbols	6			
1.2.2	Electrical symbols	6			
1.2.3	Tool symbols	7			
1.2.4	Symbols for certain types of information and graphics	7			
1.3	Documentation	8			
1.3.1	Technical Information	8			
1.3.2	Certificates	8			
1.4	Registered trademarks	10			
2	Basic safety instructions	11			
2.1	Requirements for the personnel	11			
2.2	Workplace safety	11			
2.3	Operational safety	11			
2.3.1	Ex-area	11			
2.4	Product safety	11			
3	Incoming acceptance and product identification	12			
3.1	Incoming acceptance	12			
3.2	Product identification	12			
3.3	Storage and transport	12			
4	Mounting	13			
4.1	Quick installation guide	13			
4.2	Mounting requirements	14			
4.2.1	Mounting the sensor	14			
4.2.2	Measuring condition	14			
4.2.3	Minimum probe length for nonconductive media < 1 µS/cm	15			
4.2.4	Installation examples	15			
4.3	Probe with separate housing	17			
4.3.1	Extension heights: separate housing	18			
4.3.2	Wall bracket	19			
4.3.3	Wall mounting	19			
4.3.4	Pipe mounting	20			
4.3.5	Shortening the connecting cable	20			
4.4	Installation instructions	21			
4.4.1	Probe installation	22			
4.4.2	Aligning the housing	23			
4.4.3	Sealing the probe housing	23			
4.5	Post-installation check	23			
5	Electrical connection	24			
5.1	Connecting requirements	24			
5.1.1	Potential equalization	24			
5.1.2	Electromagnetic compatibility (EMC)	24			
5.1.3	Cable specification	24			
5.1.4	Connector	25			
5.1.5	Supply voltage	25			
5.2	Wiring and connecting	25			
5.2.1	Connection compartment	25			
5.2.2	Terminal assignment	27			
5.2.3	Connecting HART with other supply units	28			
5.3	Post-connection check	28			
6	Operation options	29			
6.1	Overview of operation options	29			
6.1.1	Display and operating elements at the FEI50H electronic insert	29			
6.1.2	Operation via the optional display and operating module	30			
6.1.3	The operating menu	32			
6.2	Error messages	35			
6.3	Locking and unlocking configuration	35			
6.3.1	Key locking	35			
6.3.2	Key unlocking	35			
6.3.3	Software locking	35			
6.4	Resetting to factory setting	36			
6.4.1	Using the reset	36			
6.4.2	Effects of a reset	36			
6.4.3	Performing a reset	36			
6.5	Operation via FieldCare Device Setup	36			
6.5.1	Function scope	36			
6.5.2	Source for device description files	36			
7	Commissioning	37			
7.1	Installation and function check	37			
7.2	Basic setup without the display or operating module	37			
7.2.1	Function switch: position 1. Operation	38			
7.2.2	Function switch: position 2. Carry out empty calibration - for empty tanks	38			
7.2.3	Function switch: position 2. Carry out empty calibration - for almost empty tanks	38			
7.2.4	Function switch: position 3. Carry out full calibration - for full tanks	39			
7.2.5	Function switch: position 3. Carry out full calibration - for almost full tanks	39			
7.2.6	Function switch: position 4. Measuring modes	40			
7.2.7	Function switch: position 5. Measuring range	40			
7.2.8	Function switch: position 6. Proof test - self-test	41			

7.2.9	Function switch: position 7. Reset - restore factory settings	41	8.1.2	Red LED flashing	74
7.2.10	Function switch: position 8. Download or upload sensor DAT (EEPROM)	41	8.2	System error messages	74
7.3	Menu: "Basic setup". Commissioning with display and operating module	42	8.2.1	Error signal	74
7.3.1	Initial commissioning	42	8.2.2	Last errors	74
7.3.2	Function: "Basic setup"	44	8.2.3	Types of error	74
7.3.3	Function: "Medium property"	45	8.2.4	Error codes	75
7.3.4	Operating mode: "Empty calibr." and function - "Wet"	45	8.3	Possible measuring errors	76
7.3.5	Operating mode: "Full calibr." and function - "Wet"	46	8.3.1	Measured value is incorrect	76
7.3.6	Operating mode: "Empty calibr." and function - "Dry"	46	8.4	Firmware history	77
7.3.7	Operating mode: "Full calibration" and function - "Dry" for conductive and nonconductive media	47	9	Maintenance	78
7.3.8	Operating mode: "Empty calibration" and function - "Dry" for "Interface" or "Unknown" medium properties	48	9.1	External cleaning	78
7.3.9	Operating mode: "Full calibration" and function - "Dry" for "Interface" or "Unknown" medium properties	48	9.2	Cleaning the probe	78
7.3.10	Function: "Output damping"	48	9.3	Seals	78
7.4	Menu: "Safety setting"	48	9.4	Endress+Hauser services	78
7.4.1	Function: "Safety settings"	50	10	Repair	79
7.4.2	Function: "Safety settings"	50	10.1	General notes	79
7.4.3	Function: "Safety settings"	51	10.2	Spare parts	79
7.4.4	Function: "Operating mode"	51	10.3	Repairing Ex-certified devices	79
7.4.5	Function: "Safety settings"	52	10.4	Replacement	80
7.4.6	Function: "Output on alarm"	52	10.5	Return	80
7.4.7	Function: "Proof test" - self-test	53	10.6	Disposal	80
7.5	Menu: "Linearization"	53	10.6.1	Removing the measuring device	80
7.5.1	Function: "Linearization"	55	10.6.2	Disposing of the measuring device	80
7.5.2	Function: "Linearization"	58	11	Accessories	81
7.6	Menu: "Output"	60	11.1	Protective cover	81
7.6.1	Submenu: "Extended calibr."	61	11.2	Commubox FXA195 HART	81
7.6.2	Submenu: "HART setting"	62	11.3	HAW56x surge arrester	81
7.6.3	Menu: "Simulation"	63	11.4	Weld-in adapter	81
7.7	Menu: "Device properties"	63	12	Technical data	82
7.7.1	Submenu: "Display"	66	12.1	Probe	82
7.7.2	Submenu: "Diagnosis"	67	12.1.1	Capacitance values of the probe	82
7.7.3	Submenu: "System parameters"	68	12.1.2	Additional capacitance	82
7.8	Operation	69	12.1.3	Probe lengths for continuous measurement in conductive liquids	82
7.9	FieldCare: operating program from Endress +Hauser	69	12.2	Performance characteristics	82
7.9.1	FieldCare	70	12.2.1	Reference operating conditions	82
7.9.2	Interface measurement	70	12.2.2	Maximum measured error	82
7.9.3	Dry calibration for interface measurement	71	12.2.3	Influence of ambient temperature	82
7.9.4	Wet calibration for interface measurement	72	12.2.4	Switch-on behavior	83
8	Diagnostics and troubleshooting	74	12.2.5	Measured value reaction time	83
8.1	Diagnostic information via LEDs	74	12.2.6	Output damping	83
8.1.1	Green LED flashing	74	12.2.7	Accuracy of factory calibration	83
			12.2.8	Resolution	84
			12.3	Input	85
			12.3.1	Measured variable	85
			12.3.2	Measuring range	85
			12.4	Output	85
			12.4.1	Output signal	85
			12.4.2	Signal on alarm	85
			12.4.3	Linearization	85
			12.5	Operating conditions: Environment	86
			12.5.1	Ambient temperature range	86

12.5.2	Climate class	86
12.5.3	Vibration resistance	86
12.5.4	Shock resistance	86
12.5.5	Degree of protection	86
12.6	Operating conditions: Process	87
12.6.1	Process temperature range	87
12.6.2	Process pressure limits	88
12.6.3	Pressure and temperature derating . .	89

1 About this document

1.1 Document function

These Operating Instructions contain all the information that is required in various phases of the life cycle of the device: from product identification, incoming acceptance and storage, to mounting, connection, operation and commissioning through to troubleshooting, maintenance and disposal.

These instructions provide all the information required for use of the software: from the product description, installation and use to system integration, operation, diagnostics and troubleshooting to software updates and disposal.

1.2 Document conventions

1.2.1 Safety symbols

DANGER

This symbol alerts you to a dangerous situation. Failure to avoid this situation will result in serious or fatal injury.

WARNING

This symbol alerts you to a dangerous situation. Failure to avoid this situation can result in serious or fatal injury.

CAUTION

This symbol alerts you to a dangerous situation. Failure to avoid this situation can result in minor or medium injury.

NOTICE

This symbol contains information on procedures and other facts which do not result in personal injury.

1.2.2 Electrical symbols



Alternating current



Direct current and alternating current



Direct current



Ground connection

A grounded terminal which, as far as the operator is concerned, is grounded via a grounding system.

Protective earth (PE)

Ground terminals that must be connected to ground prior to establishing any other connections.

The ground terminals are located on the interior and exterior of the device:

- Interior ground terminal: protective earth is connected to the mains supply.
- Exterior ground terminal: device is connected to the plant grounding system.

1.2.3 Tool symbols



Phillips head screwdriver



Flat blade screwdriver



Torx screwdriver



Allen key



Open-ended wrench

1.2.4 Symbols for certain types of information and graphics



Permitted

Procedures, processes or actions that are permitted



Preferred

Procedures, processes or actions that are preferred



Forbidden

Procedures, processes or actions that are forbidden



Tip

Indicates additional information



Reference to documentation



Reference to graphic



Notice or individual step to be observed

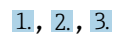

Series of steps



Result of a step



Operation via operating tool



Write-protected parameter

1, 2, 3, ...

Item numbers

A, B, C, ...

Views



Safety instructions

Observe the safety instructions contained in the associated Operating Instructions

1.3 Documentation

1.3.1 Technical Information

Liquicap M FMI52
TI01524F

1.3.2 Certificates

ATEX safety instructions

Liquicap M FMI52

- II 1/2 G Ex ia IIC T3...T6 Ga/Gb
II 1/2 G Ex ia IIB T3...T6 Ga/Gb
II 1/2 D Ex ia IIIC T90 °C Da/Db
XA00327F
- II 1/2 Ex ia/db IIC T6...T3 Ga/Gb
II 1/2 Ex ia/db eb IIC T6...T3 Ga/Gb
II 1/2 D Ex ia /tb IIIC T90 °C Da/Db
XA00328F
- Ga/Gb Ex ia IIC T3...T6
Zone 20/21 Ex iaD 20/Ex tD A21 IP65 T 90 °C
IECEX BVS 08.0027X
XA00423F
- II 3 G Ex nA IIC T6 Gc
II 3 G Ex nA nC IIC T5 Gc
II 3C D Ex tc IIIC T100 °C Dc
XA00346F

INMETRO safety instructions

Liquicap M FMI52

- Ex d [ia Ga] IIB T3...T6 Ga/Gb
Ex d [ia Ga] IIC T3...T6 Ga/Gb
Ex de [ia Ga] IIC T3...T6 Ga/Gb
XA01171F
- Ex ia IIC T* Ga/Gb
Ex ia IIB T* Ga/Gb
Ex ia IIIC T90 °C Da/Db IP66
XA01172F

NEPSI safety instructions

- Liquicap M FMI52
Ex ia IIC/IIB T3...T6 Ga/Gb
XA00417F
- Liquicap M FMI52
Ex d ia IIC/IIB T3/T4/T6 Ga/Gb
Ex d e ia IIC/IIB T3/T4/T6 Ga/Gb
XA00418F
- Liquicap M FMI52
Ex nA IIC T3...T6 Gc
Ex nA nC IIC T3...T6 Gc
XA00430F

Overfill protection DIBt (WHG)

Liquicap M FMI52
ZE00265F

Functional safety (SIL2)

Liquicap M FMI52
SD00198F

Control Drawings (CSA and FM)

- Liquicap M FMI52
FM IS
ZD00220F
- Liquicap M FMI52
CSA IS
ZD00221F
- Liquicap M FMI52
CSA XP
ZD00233F

1.4 Registered trademarks

HART®

Registered trademark of the FieldComm Group, Austin, USA

TRI CLAMP®

Registered trademark of Alfa Laval Inc., Kenosha, USA

2 Basic safety instructions

2.1 Requirements for the personnel

The personnel must fulfill the following requirements to carry out the necessary tasks:

- ▶ Are trained, qualified to perform specific functions and tasks.
- ▶ Are authorized by the plant owner or operator to perform specific tasks.
- ▶ Are familiar with federal or national regulations.
- ▶ Have read and understood the instructions in the manual and supplementary documentation.
- ▶ They follow instructions and comply with conditions.

2.2 Workplace safety

For work on and with the device:

- ▶ Wear the required protective equipment according to federal or national regulations.

2.3 Operational safety

When performing configuration, testing, and maintenance work on the device, alternative supervisory measures must be taken to guarantee the operational safety and process safety.

2.3.1 Ex-area

When using the measuring system in Ex-areas, the appropriate national standards and regulations must be observed. Separate Ex-documentation, which constitutes an integral part of this documentation, is supplied with the device. The installation procedures, connection data and safety instructions it contains must be observed.

- Make sure that the technical staff has adequate training.
- The special measuring and safety-related requirements for the measuring points must be observed.

2.4 Product safety

This measuring device is designed following good engineering practice to meet state-of-the-art safety requirements, has been tested, and left the factory in a condition in which it is safe to operate.

It meets general safety standards and legal requirements. It is compliant with the EC directives listed in the device-specific EC Declaration of Conformity. Endress+Hauser confirms this by affixing the CE mark to the device.

3 Incoming acceptance and product identification

3.1 Incoming acceptance

Check whether the packaging or content is damaged. Check that the goods delivered are complete and compare the scope of delivery with the information in your order.

3.2 Product identification

The measuring device can be identified in the following ways:

- nameplate data
- extended order code with a breakdown of the device features on the delivery note
- the serial number from nameplates in *W@M Device Viewer* (www.endress.com/deviceviewer: all of the information on the measuring device is displayed along with an overview of the scope of the technical documentation provided)
- the serial number on the nameplate into the *Endress+Hauser Operations App* or use the *Endress+Hauser Operations App* to scan the 2-D matrix code (QR Code) on the nameplate

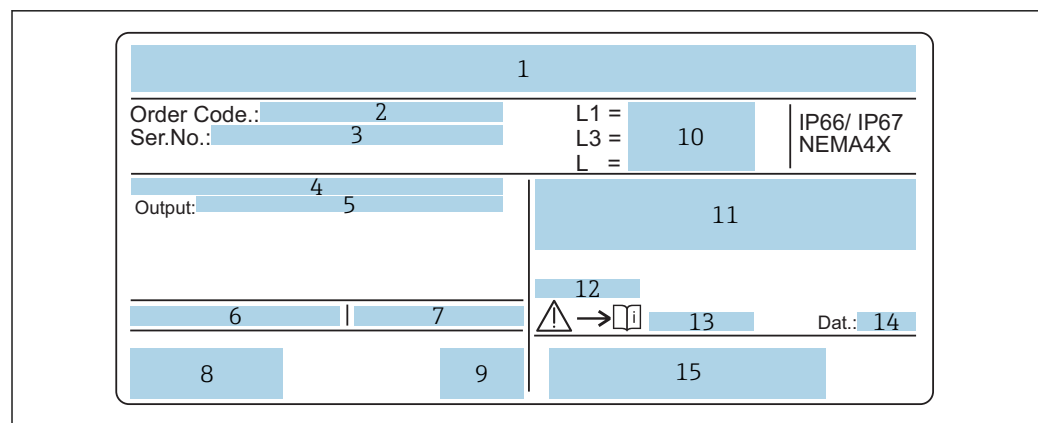

A0040359

1 The Liquicap M nameplate

- 2 Order number
- 3 Serial number
- 4 Electronic insert
- 5 Electronic insert output value
- 6 Ambient temperature at housing
- 7 Max. permissible pressure in tank
- 8 Safety certificates
- 9 Functional safety
- 10 Probe length values
- 11 ATEX approval
- 12 WHG approval (German Water Resources Act)
- 13 Safety information
- 14 Production date
- 15 Bar code

3.3 Storage and transport

For storage and transportation, pack the device in such a way as to protect it against impact. The original packaging offers the best protection for this. The permitted storage temperature is -50 to $+85$ °C (-58 to $+185$ °F) ± 5 °C (± 8 °F).

4 Mounting

4.1 Quick installation guide

A probe installation

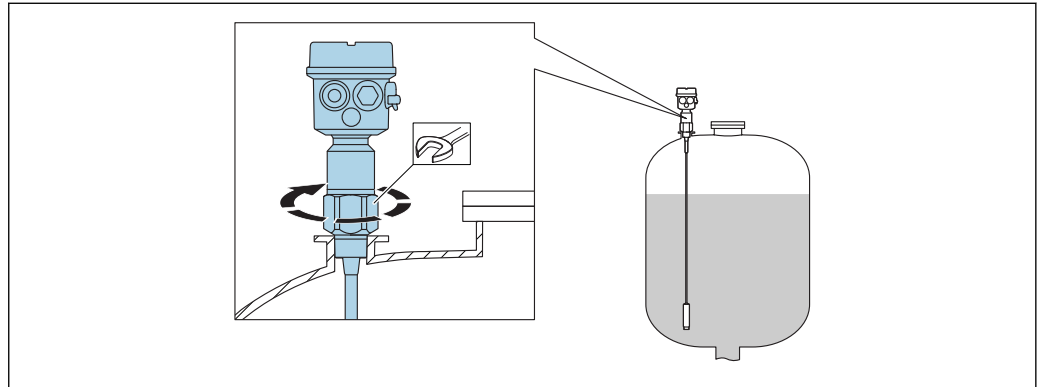

A0041919

1. Screw the probe onto the proper place.
2. Fasten the probe with proper torque in accordance with to thread size (see table below).

A ¹⁾	B ²⁾
G½	< 80 Nm (59.0 lbf ft)
G¾	< 100 Nm (73.7 lbf ft)
G1	< 180 Nm (132.8 lbf ft)
G1½	< 500 Nm (368.7 lbf ft)

- 1) Thread size
- 2) Torque

Aligning the housing

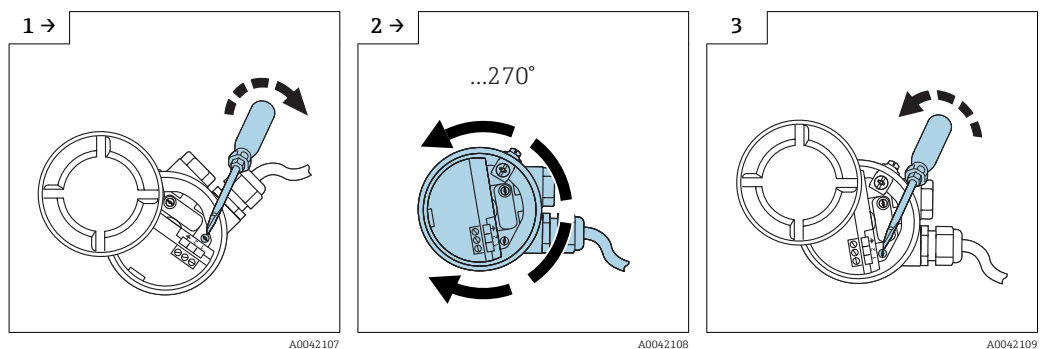

A0042107

A0042108

A0042109

i Tighten the clamping screw with torque < 1 Nm (0.74 lbf ft).

4.2 Mounting requirements

4.2.1 Mounting the sensor

The Liquicap M FMI52 can be installed vertically from above.

i Make sure that:

- the probe is not installed in the area of the filling curtain
- the probe is not in contact with the container wall
- the distance from the container floor is ≥ 10 mm (0.39 in)
- multiple probes are mounted next to each other at the minimum distance between the probes of 500 mm (19.7 in)
- the probe is at a sufficient distance from the agitator if using the probe in agitator tanks

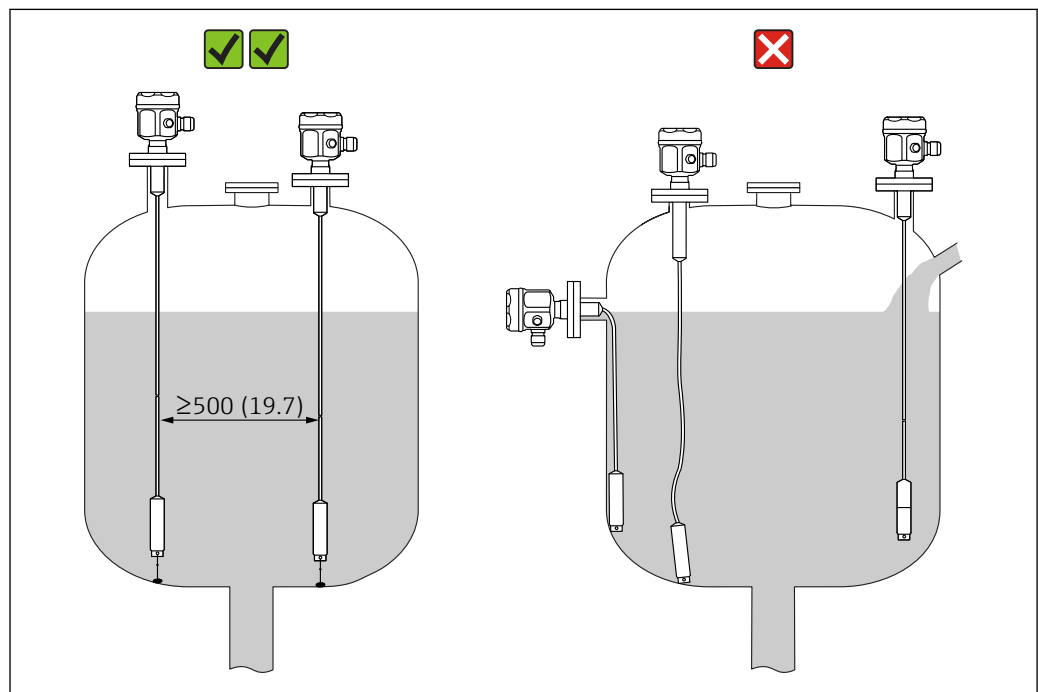

A0040578

Unit of measurement mm (in)

4.2.2 Measuring condition

Measuring range L1 is possible from the tip of the probe to the process connection.

Particularly suited for small containers.

Use a ground tube for nonconductive media.

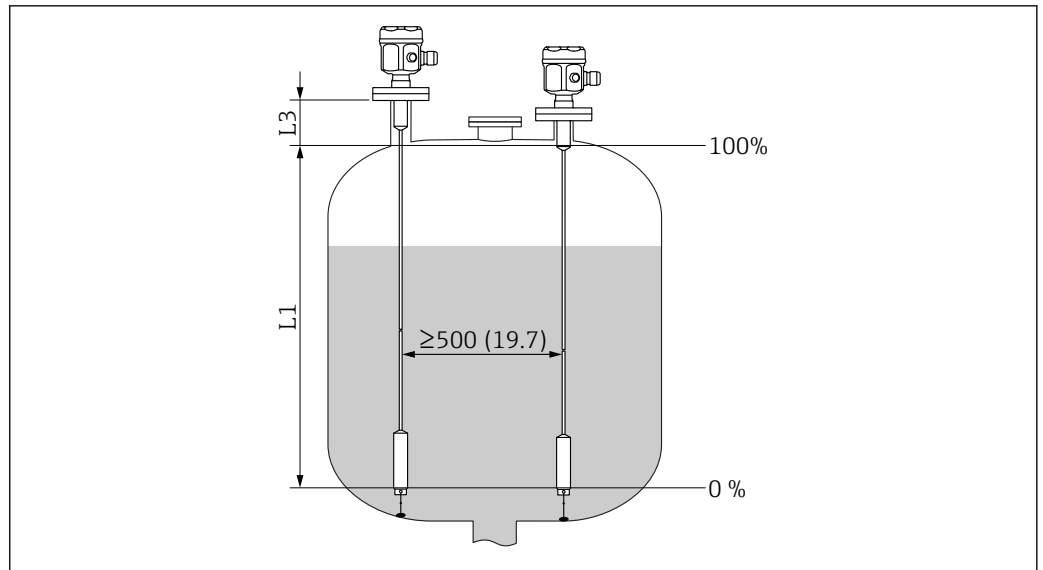

A0040579

Unit of measurement mm (in)

L1 Measuring range

L3 Inactive length

i When installing in a nozzle, use inactive length (L3).

The 0 % and 100 % calibration can be inverted.

4.2.3 Minimum probe length for nonconductive media < 1 $\mu\text{S}/\text{cm}$

The minimum probe length can be calculated using the formula:

$$l_{\min} = \frac{\Delta C_{\min}}{C_s \cdot (\epsilon_r - 1)}$$

A0040204

l_{\min} minimum probe length

ΔC_{\min} 5 pF

C_s probe capacitance in air

ϵ_r dielectric constant, e.g. oil = 2.0

4.2.4 Installation examples

Rope probes

The probe can be installed in:

- conductive tanks made from metal
- nonconductive tanks made from plastic

If the process connection of the probe is insulated from the metal tank using a seal material, then the ground connection on the probe housing must be connected to the tank using a short line.

If the probe is installed in a plastic tank, then a probe with the ground tube must be used. The probe housing must be grounded.

i A fully insulated rope probe may be neither shortened nor extended. Damaged insulation of the probe rope causes improper measurements.

The following application examples show the vertical installation for continuous level measurement.

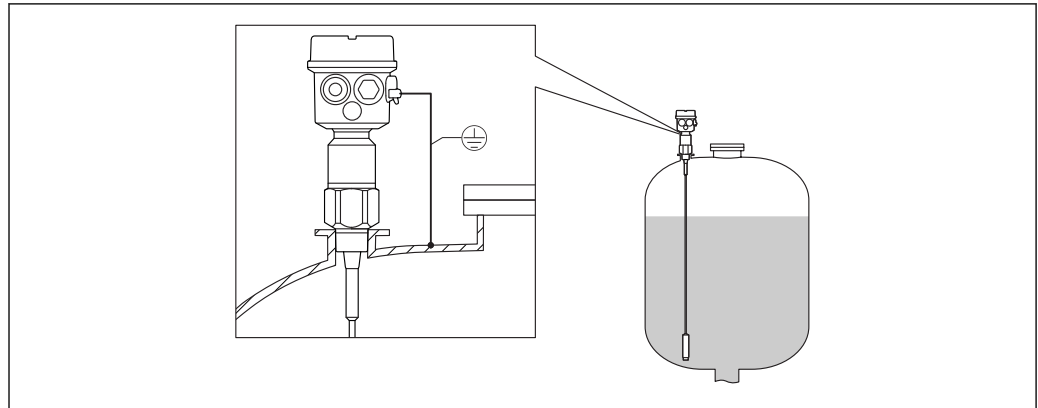

A0040451

2 Rope probe

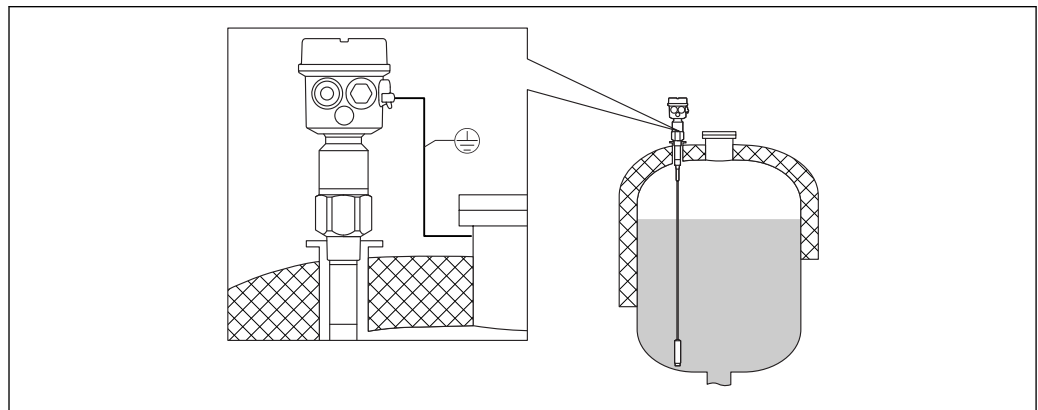

A0040452

3 A probe with the inactive length for the insulated tanks

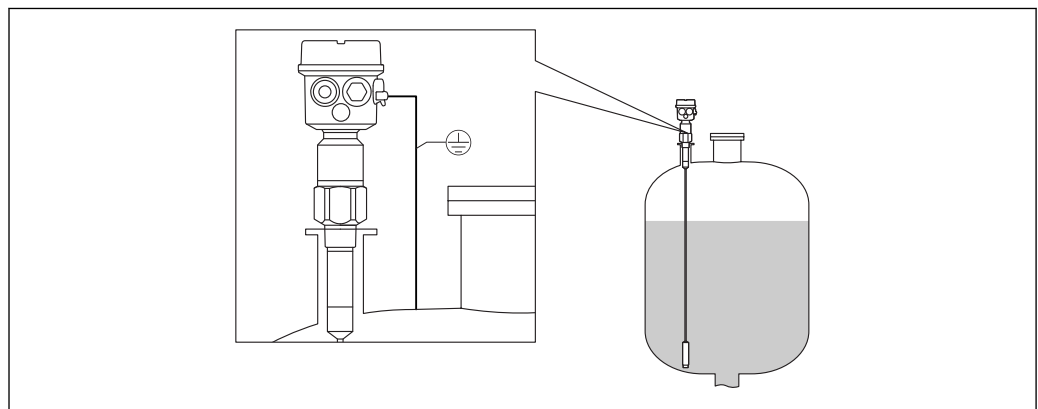

A0040453

4 A probe with fully insulated inactive length for mounting nozzles

Shortening the rope

 For a information about the shortening kit, see Brief Operating Instructions KA061F/00.

Tensioning weight with tension

The end of the probe needs to be secured if the probe would otherwise touch the silo wall or another part in the tank. This is what the internal thread in the probe weight is intended for. The bracing can be conductive or insulating to the tank wall.

To avoid too high a tensile load the rope should be loose or guyed with a spring. The maximum tensile load may not exceed 200 Nm (147.5 lbf ft).

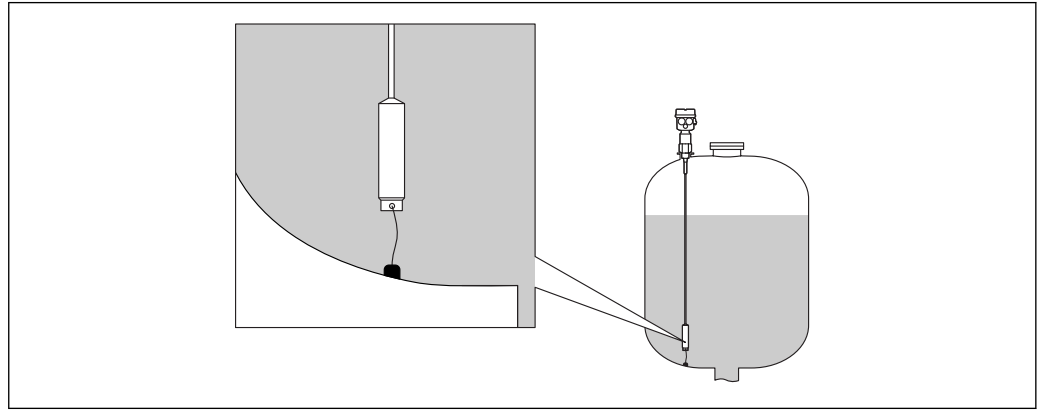

A0040462

4.3 Probe with separate housing

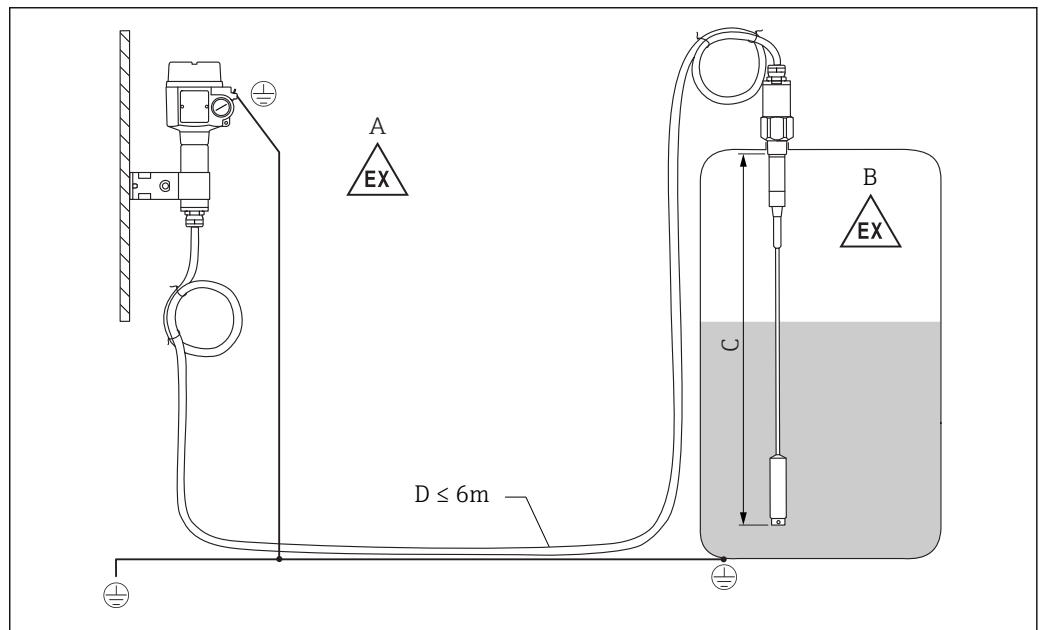

A0040473

5 Connection of the probe and separate housing

- A Explosive zone 1
- B Explosive zone 0
- D Rope length: max. 6 m (20 ft)

The maximum cable length D and rope length C cannot exceed 10 m (33 ft).

i The maximum cable length between the probe and separate housing is 6 m (20 ft). The required cable length must be indicated in the ordering process of a Liquicap M with separate housing.

If the cable connection has to be shortened or led through a wall, then it must be separated from the process connection.

4.3.1 Extension heights: separate housing

i The cable:

- has a minimum bending radius of $r \geq 100$ mm (3.94 in)
- diameter \varnothing 10.5 mm (0.41 in)
- outer jacket made of silicone, notch resistance

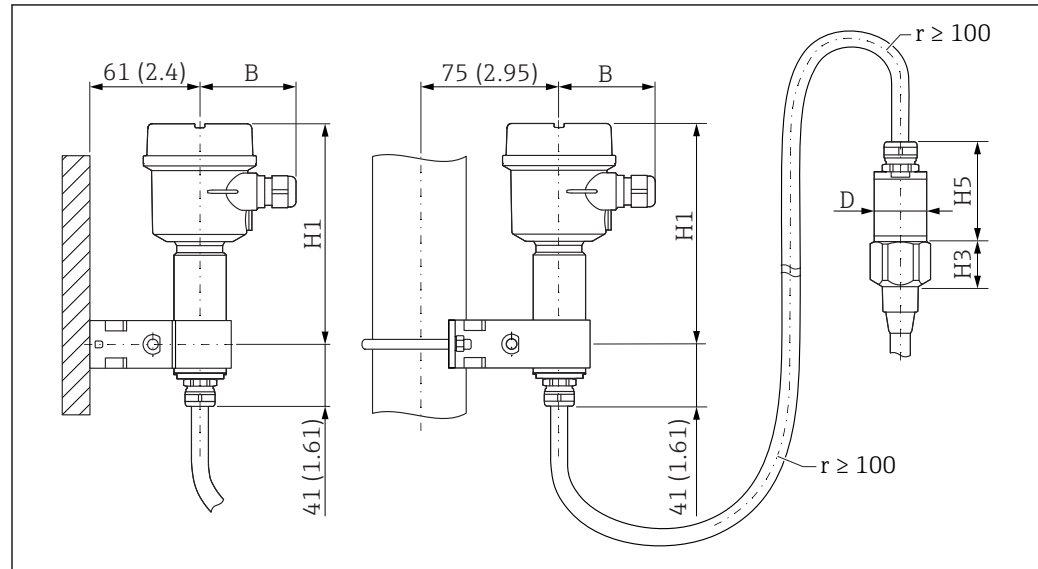

6 Housing side: wall mounting, pipe mounting, and sensor side. Unit of measurement mm (in)

The parameters value ¹⁾:

B parameter

- polyester housing (F16)
76 mm (2.99 in)
- stainless steel housing (F15)
64 mm (2.52 in)
- aluminum housing (F17)
65 mm (2.56 in)

H1 parameter

- polyester housing (F16)
172 mm (6.77 in)
- stainless steel housing (F15)
166 mm (6.54 in)
- aluminum housing (F17)
177 mm (6.97 in)

D parameter

- probes \varnothing 16 mm (0.63 in) rope, without fully insulated inactive length
 - 38 mm (1.5 in)
 - threads: G $\frac{3}{4}$ ", G1", NPT $\frac{3}{4}$ ", NPT1", Clamp 1", Clamp 1 $\frac{1}{2}$ ", Universal \varnothing 44 mm (1.73 in), flange < DN50, ANSI 2", 10K50
- probes \varnothing 16 mm (0.63 in) rope, without fully insulated inactive length
 - 50 mm (1.97 in)
 - threads: G1 $\frac{1}{2}$ ", NPT1 $\frac{1}{2}$ ", Clamp 2", DIN 11851, flange \geq DN50, ANSI 2", 10K50
- Probes \varnothing 22 mm (0.87 in) rope, with fully insulated inactive length
38 mm (1.5 in)

1) See parameters on the drawings.

H5 parameter

- probes $\varnothing 16$ mm (0.63 in) rope, without fully insulated inactive length
 - 66 mm (2.6 in)
 - threads: G $\frac{3}{4}$ ", G1", NPT $\frac{3}{4}$ ", NPT1", Clamp 1", Clamp 1 $\frac{1}{2}$ ", Universal $\varnothing 44$ mm (1.73 in), flange < DN50, ANSI 2", 10K50
- probes $\varnothing 16$ mm (0.63 in) rope, without fully insulated inactive length
 - 89 mm (3.5 in)
 - threads: G1 $\frac{1}{2}$ ", NPT1 $\frac{1}{2}$ ", Clamp 2", DIN 11851, flange \geq DN50, ANSI 2", 10K50
- probes $\varnothing 22$ mm (0.87 in) rope, with fully insulated inactive length 89 mm (3.5 in)

4.3.2 Wall bracket

 The wall bracket is part of the scope of delivery.

The wall bracket must be screwed first to the separate housing before you can use it as a drilling template.

The distance between the holes is reduced by screwing it to the separate housing.

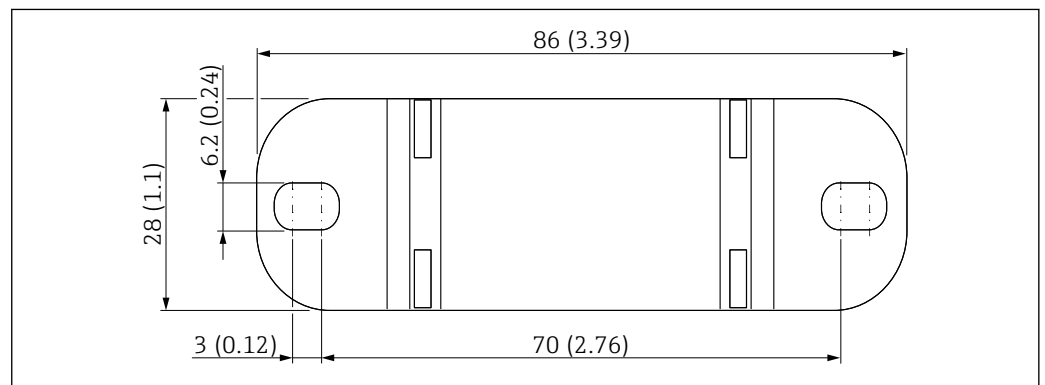

A003881

Unit of measurement mm (in)

4.3.3 Wall mounting

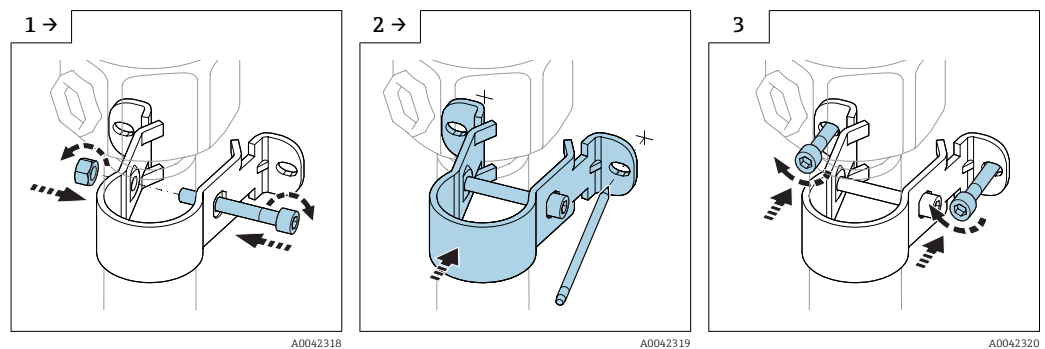

A0042318

A0042319

A0042320

4.3.4 Pipe mounting

i The maximum pipe diameter is 50.8 mm (2 in).

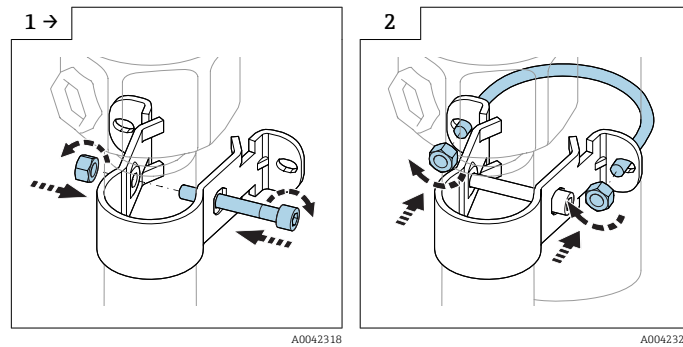

4.3.5 Shortening the connecting cable

NOTICE

Risk of damage to connections and cable.

- Make sure that neither the connecting cable nor the probe is turning with the pressing screw!

i Recalibration must be performed before commissioning.

The maximum connection length between the probe and the separate housing is 6 m (20 ft).

When ordering a device with separate housing, the desired length must be specified.

If the cable connection has to be shortened or led through a wall, it must be separated from the process connection.

Disconnecting the connection cable

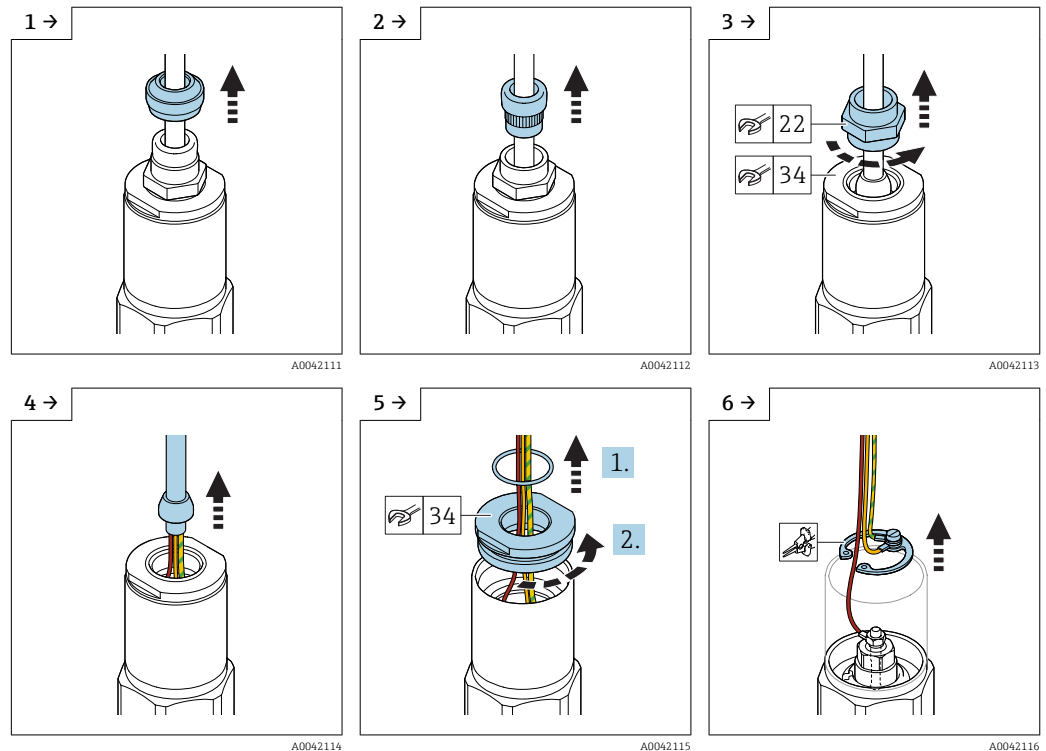

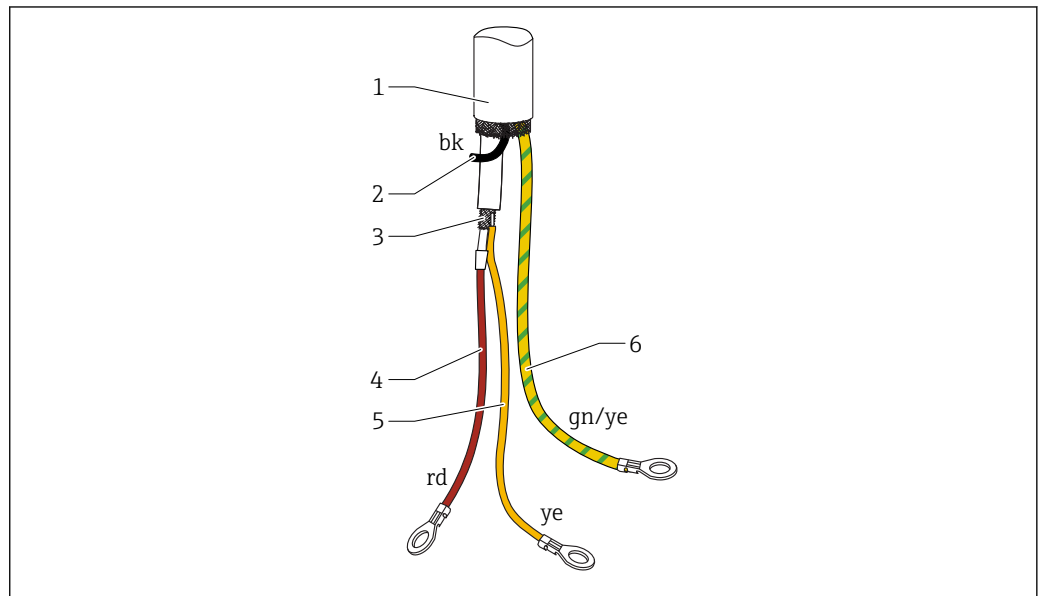
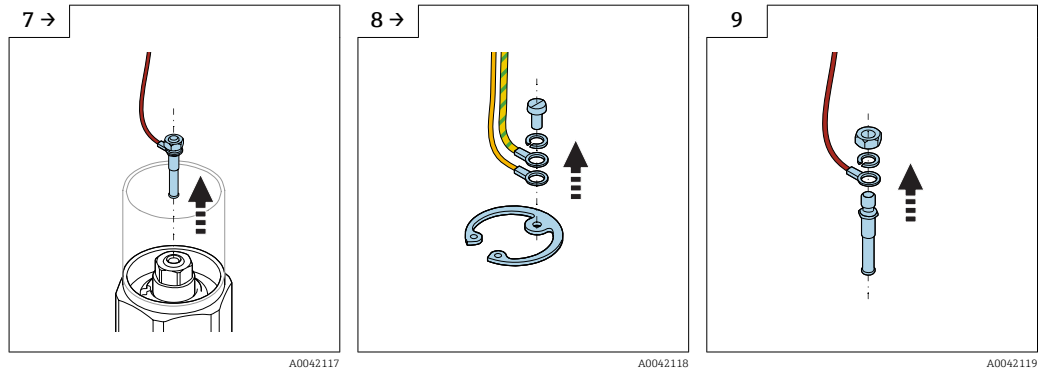

7 Cable connections

- 1 External screening (not required)
- 2 Strand black (bk) (not required)
- 3 Coaxial cable with central core a screening
- 4 Solder the red (rd) strand with the central core of the coaxial cable (probe)
- 5 Solder the strand with the screening of the yellow (ye) coaxial cable (ground)
- 6 Strand yellow and green (gn/ye) with a ring terminal

i We recommend reusing all strands with ring terminals in case of shortening the connecting cable.

To avoid the risk of short-circuiting when the strands are not to be reused, the connections of the new ring terminals fitted must be isolated with a heat shrinking sleeve.

Use heat-shrink tubes to insulate all soldered joints.

4.4 Installation instructions

NOTICE

Do not damage the probe insulation during installation!

- ▶ Check the rope insulation.

NOTICE

Do not screw the probe using the probe housing!

- ▶ Use an open-end wrench to screw the probe.

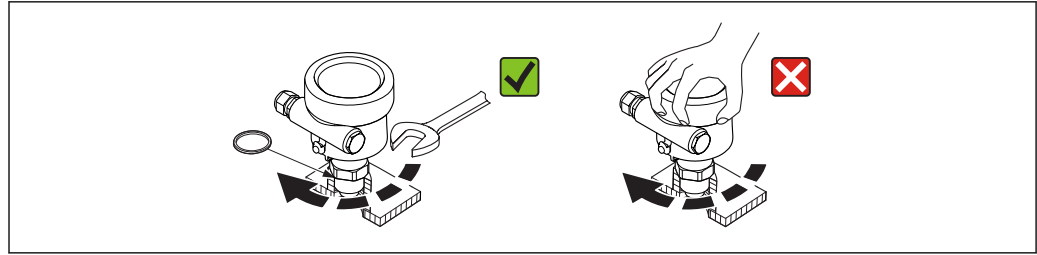

A0040476

4.4.1 Probe installation

Probe with thread

Cylindrical threads G $\frac{1}{2}$, G $\frac{3}{4}$, G1, G1 $\frac{1}{2}$

To be used with the elastomer fiber seal supplied or another chemically resistant seal. Make sure that the temperature resistance of a seal is correct.

i The following applies to probes with a parallel thread and supplied seal:

Thread G $\frac{1}{2}$

- for pressures up to 25 bar (362.5 psi): 25 Nm (18.4 lbf ft)
- maximum torque: 80 Nm (59.0 lbf ft)

Thread G $\frac{3}{4}$

- for pressures up to 25 bar (362.5 psi): 30 Nm (22.1 lbf ft)
- maximum torque: 100 Nm (73.8 lbf ft)

Thread G1

- for pressures up to 25 bar (362.5 psi): 50 Nm (36.9 lbf ft)
- maximum torque: 180 Nm (132.8 lbf ft)

Thread G1 $\frac{1}{2}$

- for pressures up to 100 bar (1450 psi): 300 Nm (221.3 lbf ft)
- maximum torque: 500 Nm (368.8 lbf ft)

Conical threads $\frac{1}{2}$ NPT, $\frac{3}{4}$ NPT, 1 NPT, 1 $\frac{1}{2}$ NPT

Wrap the thread with a suitable sealing material. Use conductive sealing material only.

Probe with Tri-Clamp, sanitary connection or flange

The process seal must meet the specifications of the application. Check the seal's resistance to temperature and medium.

If the flange is PTFE-clad, this generally suffices as the seal up to the permitted operating pressure.

Probe with PTFE-clad flange

i Use spring washers!

Depending on process pressure and process temperature, check and re-tighten the screws at regular intervals.

Recommended torque: 60 to 100 Nm (44.3 to 73.8 lbf ft).

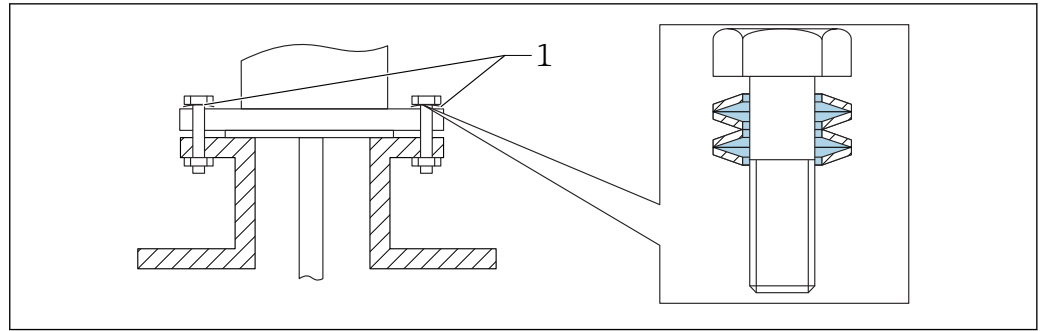

A0040477

1 Spring washer

4.4.2 Aligning the housing

The housing can be rotated 270° to align with the cable entry. To prevent moisture penetration, route the connecting cable downwards in front of the cable gland and secure it with a cable tie. This is particularly recommended for outdoor mounting.

Aligning the housing

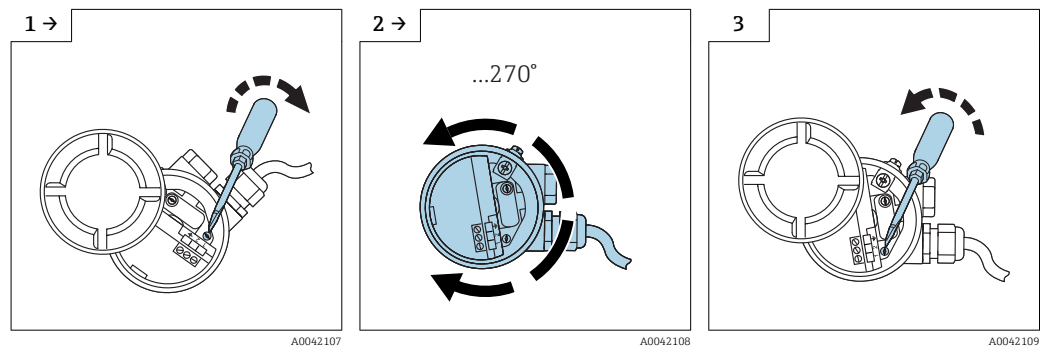

A0042107

A0042108

A0042109

i The clamping screw for aligning the housing type T13 is located in the electronics compartment.

4.4.3 Sealing the probe housing

Make sure that the cover is sealed. Water cannot enter into the device when performing installation, connection and configuration tasks. Always seal the housing cover and cable entries securely.

The O-ring seal on the housing cover is shipped with a coat of special lubricant applied. In this way, the cover can be sealed tight and the aluminum thread does not bite when screwing down.

Never use mineral oil-based grease as this destroys the O-ring.

4.5 Post-installation check

After installing the measuring device, carry out the following checks:

- Do a visual check for damages.
- Does the device meet the specifications at the measuring point with regard to process temperature and pressure, ambient temperature, measuring range?
- Has the process connection been tightened with the tightening torque?
- Check if the measuring points are correctly labeled.
- Is the device adequately protected against precipitation and direct sunlight?

5 Electrical connection

i Before connecting the power supply, note the following:

- the supply voltage must match the data specified on the nameplate
- switch off the supply voltage before connecting the device
- connect the potential equalization to the ground terminal on the sensor

i When using the probe in hazardous areas, the relevant national standards and the information in the safety instructions (XA) must be observed.

Use the specified cable gland only.

5.1 Connecting requirements

5.1.1 Potential equalization

⚠ DANGER

Risk of explosion!

- ▶ Connect the cable screen on the sensor side only!

Connect the potential equalization to the outer ground terminal of the housing (T13, F13, F16, F17, F27). In the case of the stainless steel housing F15, the ground terminal can also be located in the housing. For further safety instructions, please refer to the separate documentation for applications in hazardous areas.

5.1.2 Electromagnetic compatibility (EMC)

Interference emission to EN 61326, Electrical Equipment Class B. Interference immunity to EN 61326, Annex A (Industrial) and NAMUR Recommendation NE 21 (EMC).

Failure current is accordance to NAMUR NE43: FEI50H = 22 mA.

A standard commercial instrument cable can be used.

i Information on connecting shielded cables is provided in Technical Information TIO0241 "EMC test procedures".

5.1.3 Cable specification

Connect the electronic inserts by using commercially available instrument cables. If a potential equalization is present, and the shielded instrument cables are used, connect the shielding on both sides to optimize the shielding effect.

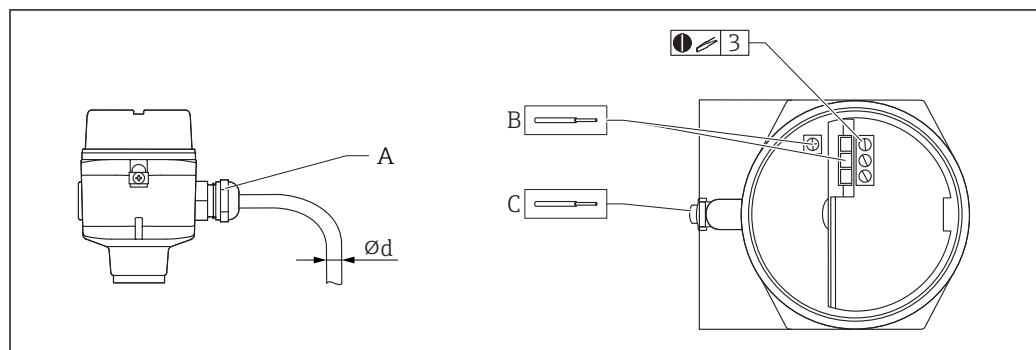

A Cable entry

B Electronic insert connections - cable size max. 2.5 mm² (14 AWG)

C The ground connection outside the housing, cable size max. 4 mm² (12 AWG)

Ød Cable diameter

A0040478

Cable entries

- nickel-plated brass
 $\varnothing d = 7$ to 10.5 mm (0.28 to 0.41 in)
- synthetic material
 $\varnothing d = 5$ to 10 mm (0.2 to 0.38 in)
- stainless steel
 $\varnothing d = 7$ to 12 mm (0.28 to 0.47 in)

5.1.4 Connector

For the version with a connector M12, the housing does not have to be opened for connecting the signal line.

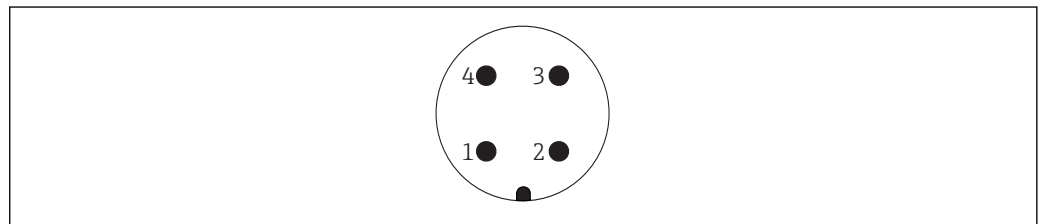
PIN assignment for M12 connector

A0011175

- 1 Positive potential
- 2 Not used
- 3 Negative potential
- 4 Ground

5.1.5 Supply voltage

All of the following voltages are terminal voltages directly at the device:

- 12.0 to 36.0 V_{DC} in the non-hazardous area
- 12.0 to 30.0 V_{DC} in the Ex ia hazardous area
- 14.4 to 30.0 V_{DC} in the Ex d hazardous area

5.2 Wiring and connecting**5.2.1 Connection compartment**

Depending on explosion protection, the connection compartment is available in the following variants:

Standard protection

- polyester housing F16
- stainless steel housing F15
- aluminum housing F17
- aluminum housing F13
- stainless steel housing F27
- aluminum housing T13, with the separate connection compartment

Ex ia protection

- polyester housing F16
- stainless steel housing F15
- aluminum housing F17
- aluminum housing F13
- stainless steel housing F27
- aluminum housing T13, with the separate connection compartment

Ex d protection

- aluminum housing F13
- stainless steel housing F27
- aluminum housing T13, with the separate connection compartment

Gas-tight process seal

- aluminum housing F13
- stainless steel housing F27
- aluminum housing T13, with the separate connection compartment

To connect the electronic insert to the power supply:

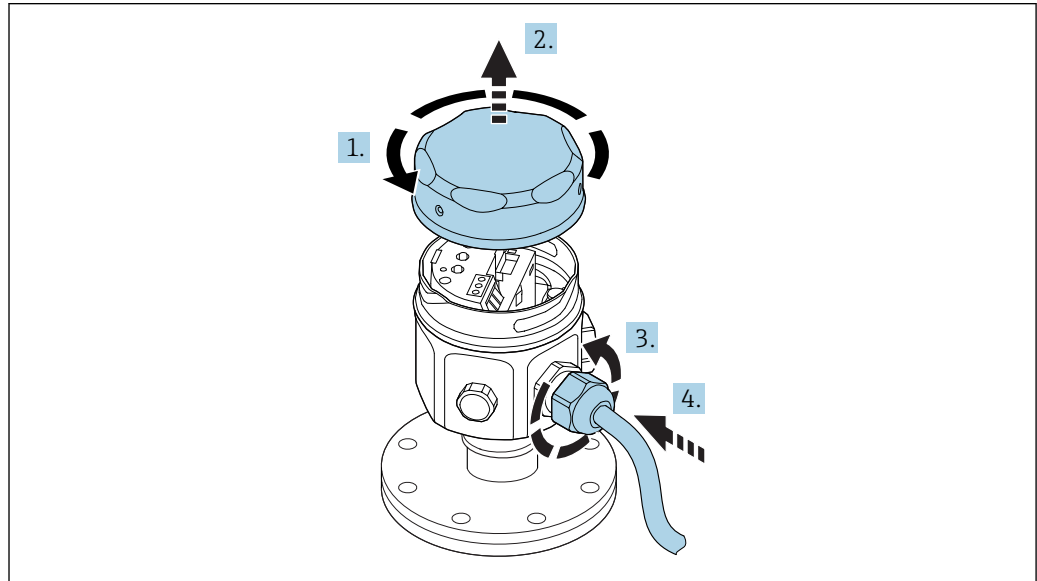

A0040635

1. Unscrew the housing cover.
2. Remove the housing cover.
3. Release the cable gland.
4. Insert the cable.

i Applies to the housing T13.

To connect the electronic insert to the power supply:

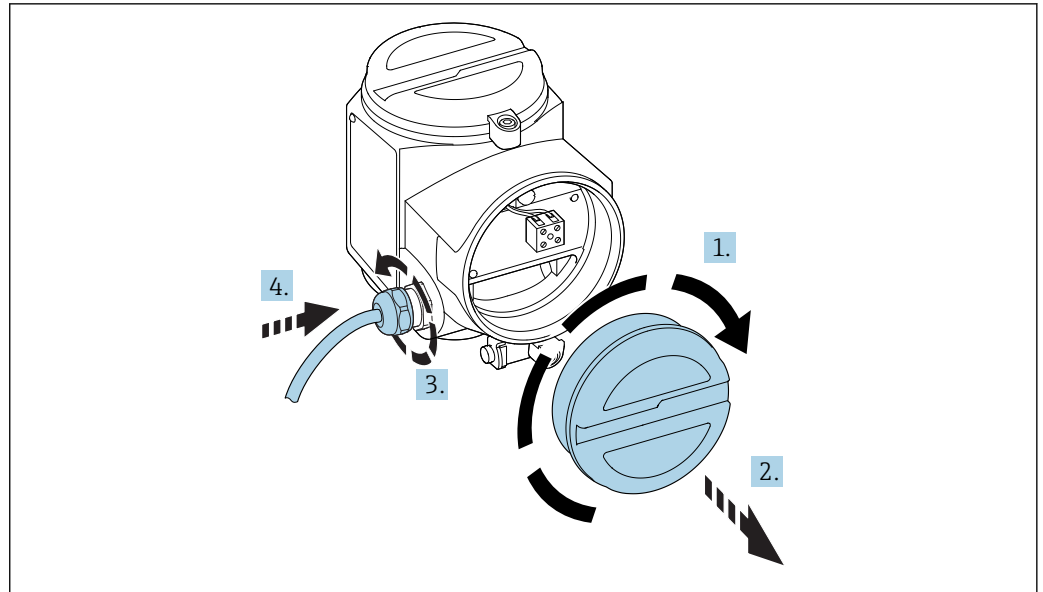

A0040637

1. Unscrew the housing cover.
2. Remove the housing cover.
3. Release the cable gland.
4. Insert the cable.

5.2.2 Terminal assignment

2-wire, 4 to 20 mA with HART

The twin-core connecting cable is connected to the screw terminals with conductor cross-section 0.5 to 2.5 mm² (20 to 13 AWG) in the connection compartment at the electronic insert. If the superimposed communication signal (HART) is used, a shielded cable must be used with the shielding connected at the sensor and power supply. Protective circuits against reverse polarity, HF influences, and overvoltage peaks are integrated.

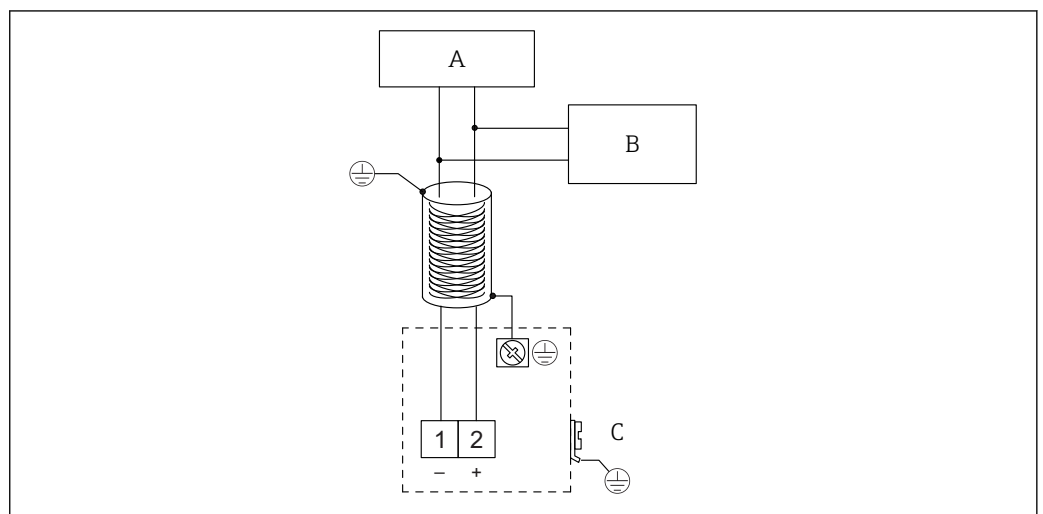

A0040479

- A Supply voltage, communication resistor 250 Ω
 B Commubox FXA195
 C Grounding terminal

5.2.3 Connecting HART with other supply units

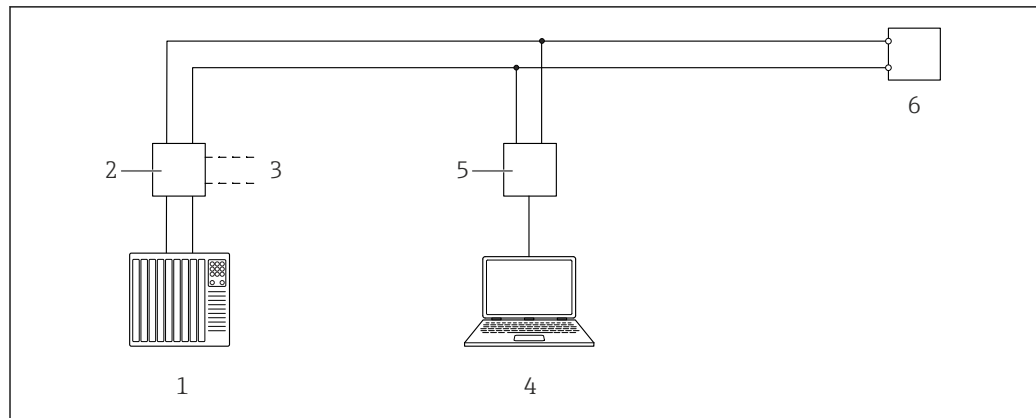

A0040750

 8 Remote control via HART protocol

- 1 PLC
- 2 Transmitter power supply unit e.g. RN221N with communication resistor
- 3 Connection output for Commubox FXA191, FXA195
- 4 Computer with control software (DeviceCare or FieldCare, AMS Device Manager, SIMATIC PDM)
- 5 Commubox FXA191 (RS232) or FXA195 (USB)
- 6 Transmitter

 If the HART communication resistor is not integrated with the supply unit, a 250 Ω communication resistor must be included in the 2-wire line.

5.3 Post-connection check

After wiring the measuring device, carry out the following checks:

- Is the terminal assignment correct?
- Is the cable gland sealed tight?
- Is the housing cover fully screwed?
- Is the device operational and is the green LED flashing when the device is on?

6 Operation options

6.1 Overview of operation options

This device can operate with:

- the operating elements at the FEI50H electronic insert
- the display and operating module
- the HART protocol with Commubox FXA195 and FieldCare operating program
- the HART handheld terminal DXR375

6.1.1 Display and operating elements at the FEI50H electronic insert

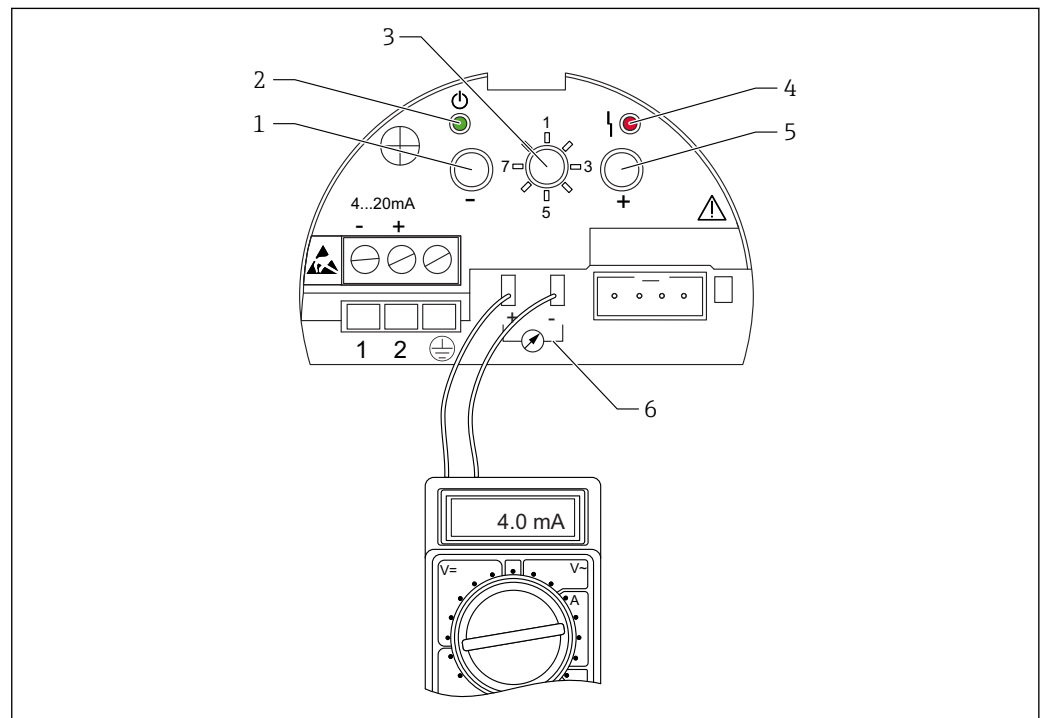

9 FEI50H electronic insert

- 1 Key
- 2 Green LED - operational status
- 3 Mode switch
- 4 Red LED - fault
- 5 Key
- 6 Current pick-off 4 to 20 mA

Function switch

- 1: Operation
select for normal operation
- 2: Empty calibration
select to set empty calibration
- 3: Full calibration
select to set full calibration
- 4: Measuring modes
select to choose between operation for media that form buildup (e.g. yogurt) or for media without buildup (e.g. water)

- 5: Measuring range
select the measuring range in pF for:
 - measuring range probe length < 6 m (20 ft) corresponds to 2 000 pF
 - measuring range probe length > 6 m (20 ft) corresponds to 4 000 pF
- 6: Self-test
select to activate the self-test
- 7: Reset - factory settings
select to restore the factory settings
- 8: Upload sensor DAT (EEPROM)
 - select to transfer the calibration values in the electronic insert to the sensor DAT (EEPROM) if replacing the probe
 - select to transfer the calibration values of the sensor DAT (EEPROM) to the electronics if replacing the electronic insert

Red LED - indicates a fault or malfunction

- flashes 5x per second
capacity at probe is too large, short-circuit at the probe or FEI50H is defective
- flashes 1x per second
the temperature in the electronic insert is outside the permitted temperature range

Key

press to execute the functions set via the function switch

Display connector

connector dedicated for optional onsite display and operating module

Current pick-off 4 to 20 mA

connect the multimeter for full or empty calibration without disconnecting the main circuit

Key

press to execute the functions set via the function switch

Green LED - indicates operation

- flashes 5x per second
the device operates
- flashes 1x per second
the device is in the calibration mode

6.1.2 Operation via the optional display and operating module

Display and operating elements

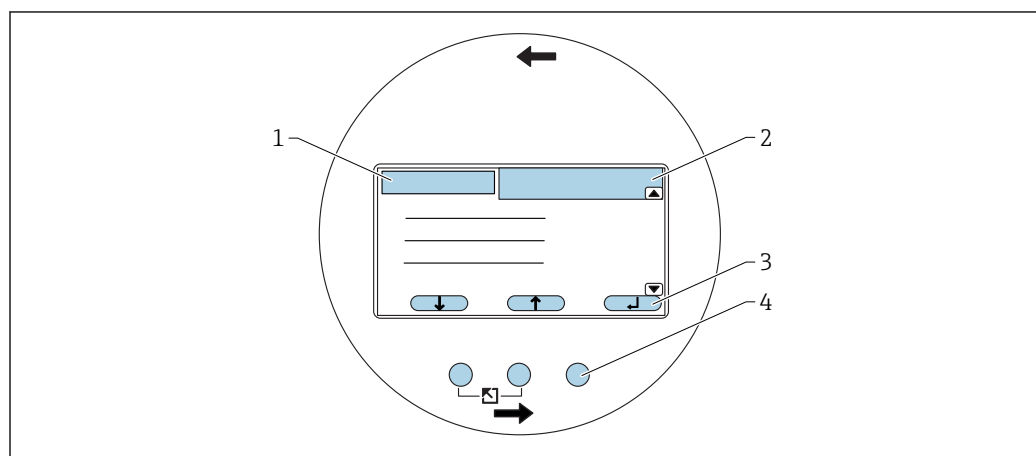



 10 Display and operating elements



- 1 Menu title
- 2 Item code of a displayed function
- 3 Key symbols
- 4 Hardware keys

Symbols on the display

Operating mode of the device









- **User** 
 - user parameters can be edited
- **Lock** 
 - all parameters are locked
- **Scrollbar** 
 - scroll up or down to access more functions

Locking state of the currently displayed parameter

- **Display parameter** 
 - the parameter cannot be edited in the current operating mode of the device
- **Write parameter** 
 - the parameter can be edited

Key symbols

The keys work as softkeys. This means that their function and meaning depend on the current position in the operating menu. The key functions are indicated by symbols in the bottom line of the display.

- **Down** 
 - moves the bar downwards in a picklist
- **Up** 
 - moves the bar upwards in a picklist
- **Enter** 
 - enter the selected submenu or selected function
 - confirm the edited function value
- **Previous function** 
 - go to the previous function within the function group
- **Next function** 
 - go to the next function within the function group
- **Confirm selection** 
 - select the option from the picklist
- **Increase value** 
 - increases the selected position of an alphanumeric function
- **Decrease value** 
 - decreases the selected position of an alphanumeric function
- **Error list** 
 - opens the list of the errors currently present
 - the symbol is inverted and flashes if a warning is present
 - the symbol appears constantly if an alarm is present

Hardware key combinations

The following hardware key combinations apply regardless of the menu item in question:

Escape

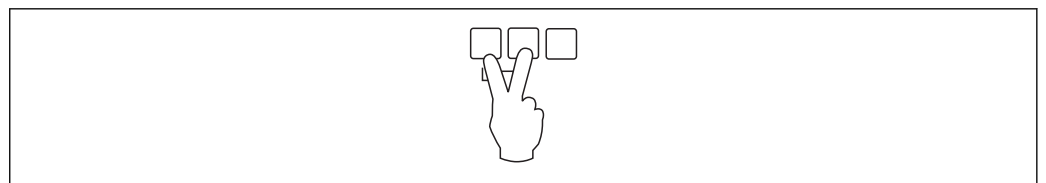

- 1 Due to editing a function: exits the editing mode for the current function
- 2 Due to navigating: returns to the next-highest menu level

Increase contrast

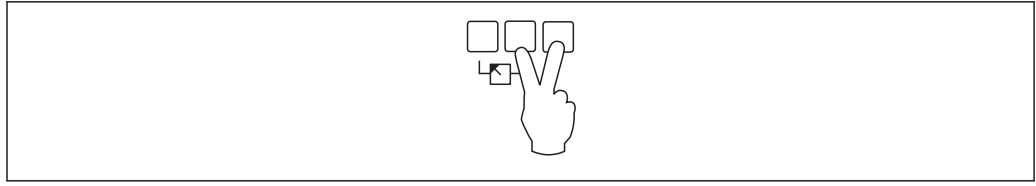

A0032710

Increases the contrast of the display module

Decrease contrast

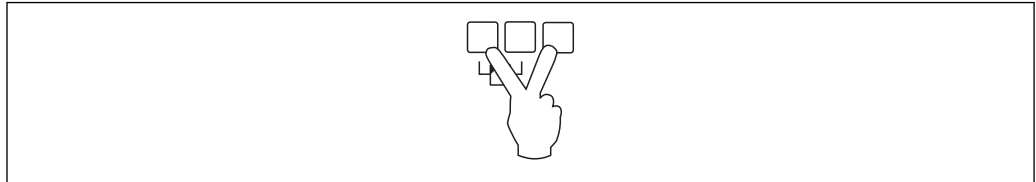

A0032711

Decreases the contrast of the display module

Locking and unlocking

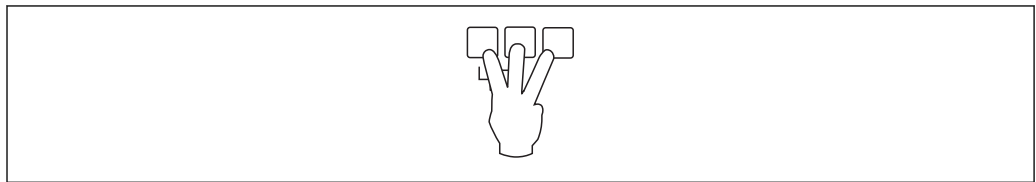

A0032712

- 1 Locks the device against parameter changes
- 2 Press all three keys to unlock the device

6.1.3 The operating menu

Function codes

The functions of Liquicap M are arranged in an operating menu. 5-digit item code is shown on the display for every function to aid orientation within the menu.

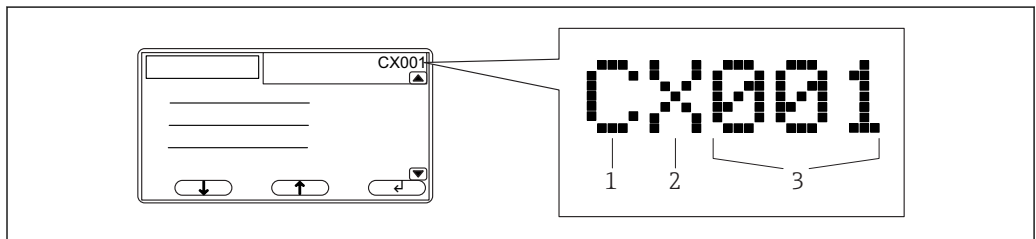

A0040486

- 1 Function group
- 2 Channel
- 3 Number of the function within the group

The first position refers to:

- C: Basic setup
- S: Safety setting
- L: Linearization
- O: Output
- D: Device properties

The second position refers to
the position is out of function

The third position refers to
the individual functions within the function group

Launching menus

 The display automatically switches to the main screen with the measured value, if the submenu is not chosen or the navigation key is not pressed for 15 minutes.

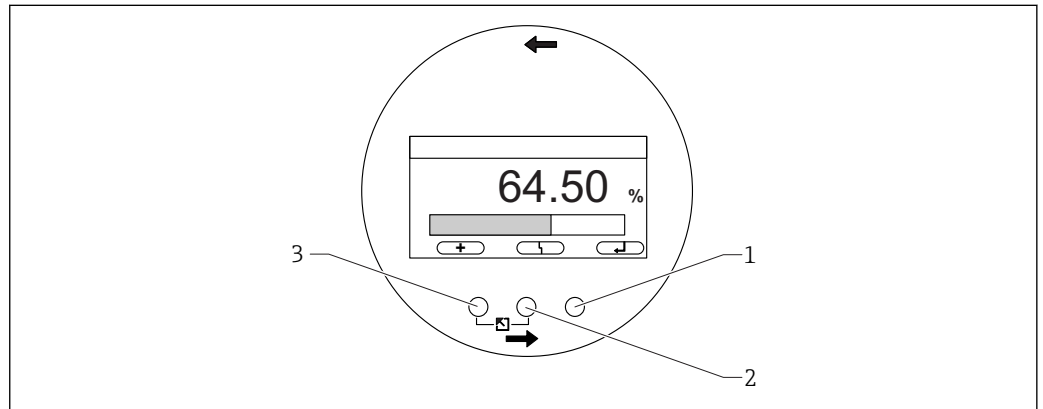

- 1 Main menu button
2 Actual errors button
3 Measured value button

Measured value

displays the measured value in %, mA or pF

Main menu

- contains all the parameters of Liquicap M, and is split into submenus
- the submenus contain additional submenus
- to overview the menu, submenus, and all functions →  37

Actual errors

- if an error is detected, the display shows related softkey symbol over the center key
- if the symbol flashes than a warning was detected
- if the symbol is displayed continuously then an alarm-type error was detected



 More information about the differences between "Alarm" and "Warning" →  74.

 Press the center key to display the currently pending errors list.

Selecting a submenu

- Press  or  to select the submenu.
- Press  to enter the selected menu.



If the submenu contains additional submenus, continue in the same manner until you reach the function level.







► Press  or  to select the function in submenu.

 Return to the next-highest menu level any time by pressing "Escape" →  31.

If the menu has only one submenu then the soft keys are not displayed.

Selecting a function and subfunction



If the function level has been reached, it is possible to navigate through the functions with  and . The current values of all the related subfunctions are displayed.

1. Press  or  to select the ordered function.
2. Press  to enter the selected function.
3. Press  or  to select the ordered subfunction.
4. Press  to enter the selected function.

 If the function has only one subfunction, than the soft keys are not displayed.

 Return to the next-highest menu level any time by pressing "Escape" →  31.

Editing functions with the picklist

1. Press  or  to select the ordered option.
2. Press  to select this option.







The new value is now transferred to the device.

Edit another subfunction in the same way.

 Return to the next-highest menu level any time by pressing "Escape" →  31.

Editing numeric and alphanumeric functions

If you select a numeric function like "Empty calibration", "Full calibration" or an alphanumeric function like "Device marking", the editor for numbers or alphanumeric characters opens.

1. Press  or  until this position shows the ordered value.
2. Press  to enter the value and go to the next position.
3. Repeat step for the next position.
4. Once all the necessary positions have been entered, press  or  until  appears at the marker.
5. Press  to transfer the entire value to the device.

Special functions when making entries

They also call up the following symbols for special editing tasks which make inputting information easier and make it possible to make corrections quickly.

In the editor for numbers and alphanumeric characters, the  and  keys not only call up numbers and letters.

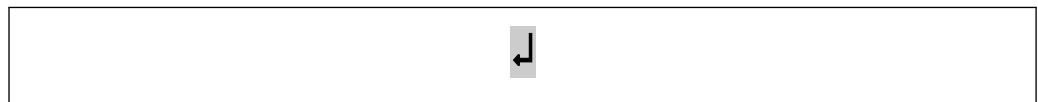

A0040580

 11 The number to the left of the marker is transferred to the device.



A0040581

 12 Exit the editor. The old function value remains.



A0040582

 13 The marker jumps to the next position.

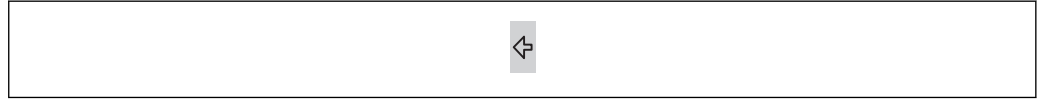

A0040583

 14 The marker jumps back to the previous position.



A0040584

 15 The current position and all positions to the right are deleted.

Return to the measured value display

Pressing the left and center key simultaneously has the following effect:

- it takes you from the editing mode to the display mode of the functions
- it takes you from the display mode of the functions to the submenu
- it takes you from the submenu to the main menu
- it takes you from the main menu to the measured value display

6.2 Error messages

If the automatic monitoring function of Liquicap M detects an error, the related softkey symbol  appears over the center key.

If the softkey symbol  is flashing, only "Warning"-type errors are present.

If the symbol  is displayed continuously, at least one "Alarm"-type error is present.

 Press the key in the center to display the currently pending errors list.

 To find information about the differences between "Alarm" and "Warning" →  74

6.3 Locking and unlocking configuration



6.3.1 Key locking

Press all three keys simultaneously. The device is then locked.

6.3.2 Key unlocking

Press all three keys simultaneously. The device is then unlocked.

6.3.3 Software locking

 Locking the device is described in "Safety settings" →  50.

In the menu, the current locking status of the device is displayed in the "Status" subfunction under "Safety settings" SAX01.

The following values can appear:

Unlocked

all parameters can be modified

Locked

The device is locked from the operating menu. It can only be enabled again by entering "100" in the "Safety settings" function. If an attempt is made to change a parameter, the device goes to the "Safety settings" function. "Key locking" is displayed in the "Status" subfunction. Press all the keys simultaneously. The device then goes back to the default settings and all parameters can be changed again.

Key locked

The device has been locked with the operating keys. It can only be enabled again by pressing all three keys simultaneously.



A key symbol is shown on the display when locked.

6.4 Resetting to factory setting



The reset can affect the measurement as the current values are overwritten by factory values: 0% (4 mA) and 100 % (20 mA).

6.4.1 Using the reset

A reset is always recommended if a device with an unknown history is used.

6.4.2 Effects of a reset

- all parameters are reset to the factory setting
- the linearization is reset to "linear"



The linearization table is retained and can be activated again where necessary.

The factory settings of the parameters are marked in bold in the menu overview.

For more information go to the chapter "Basic setup" → 30.

6.4.3 Performing a reset

To do a reset, enter the value "333" in the "Device properties → Diagnosis → Password reset / Reset" function.

6.5 Operation via FieldCare Device Setup

6.5.1 Function scope

FDT-based plant asset management tool from Endress+Hauser. It can configure all smart field devices in a system and helps you manage them. By using the status information, it is also a simple but effective way of checking their status and condition.





For additional information about FieldCare, see Operating Instructions BA00027S and BA00059S

Connection options: HART via Commubox FXA195 and the USB port of a computer

6.5.2 Source for device description files

- www.endress.com → Downloads
- CD-ROM (contact Endress+Hauser)
- DVD (contact Endress+Hauser)

7 Commissioning



 The device is operated via the electronic insert, the display or with FieldCare. If a display is attached to the electronic insert, the function keys  or  and the Mode switch at the electronic insert are deactivated. All other settings can be made using the function keys on the display or with FieldCare.

7.1 Installation and function check

Make sure that the post-installation check and final check have been completed before you start your measuring point:

- go to the chapter "Post-installation check" →  23
- go to the chapter "Post-connection check" →  28

7.2 Basic setup without the display or operating module

This section describes how to commission the device with the function switch and the operating keys  and  on the FEI50H electronic insert.

 On leaving the factory, Liquicap M devices are calibrated for media with a conductivity of $\geq 100 \mu\text{S}/\text{cm}$ for all water-based liquids such as acids and alkalis.

A recalibration is only necessary if the 0 to 100 % value should be adjusted to suit customer-specific requirements, the distance to the tank wall is $< 250 \text{ mm}$ (9.84 in) or if the liquid is not conductive.

Only the "Wet-type" calibration can be carried out without the display and operating module.

During the "Wet-type" calibration, the 0 % value or the 100 % value is adjusted to customer-specific requirements. This calibration can be carried out if the tank is empty, full or partially filled.

During full calibration, the probe must be covered by the liquid in the installed state.

An empty and full calibration must be performed.

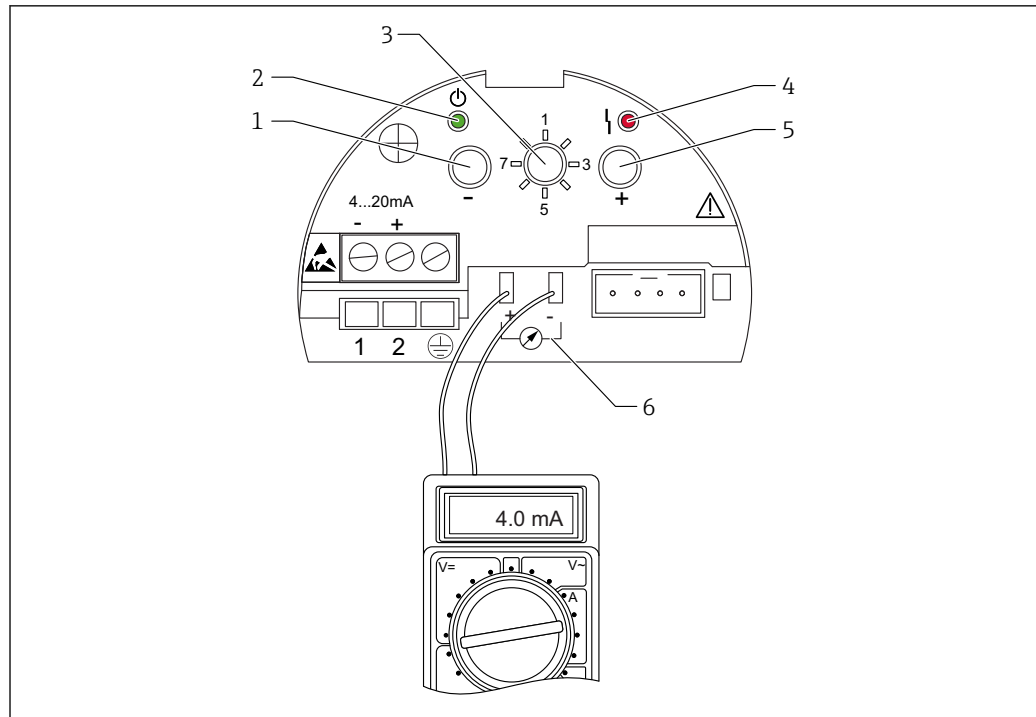

16 FEI50H electronic insert

- 1 Key \square
- 2 Green LED - operational status
- 3 Mode switch
- 4 Red LED - fault
- 5 Key \oplus
- 6 Current pick-off 4 to 20 mA

7.2.1 Function switch: position 1. Operation

In normal operation, the function switch must be set to position 1.

7.2.2 Function switch: position 2. Carry out empty calibration - for empty tanks

When the tank is empty (0 %), the empty calibration sets the signal current to the lower value of 4 mA. When empty calibration is completed, the electric current value of 4 mA is displayed at the ammeter.

To perform empty tank calibration:

1. Turn the function switch to position 2.
2. Press the \square and \oplus keys together for 2 s until the green or red LED flashes.
3. Release the two keys.
4. The flashing stops after 5 s.
 - ↳ Empty calibration is saved.

7.2.3 Function switch: position 2. Carry out empty calibration - for almost empty tanks

If possible, the exact tank level should be known and should not exceed < 30 %.

Exceeding the permitted tank level reduces the accuracy of the zero-point that corresponds to the empty tank. An ammeter must be connected to the current pick-off at the electronic insert. For example, the level was determined for 15 %, the electric current value that corresponds to that 15 % must be determined.

The lower current value can be adjusted with the \square and \oplus keys.

The following must also be considered:

- the lower current value means that the tank is empty, 0 % is 4 mA.
- the upper current value means that the tank is full, 100 % is 20 mA.
- this results in a measuring range of 16 mA for a change from 0 to 100 %. For example 0.16 mA increase in the current for every 1 % increase in the level.
- for a 15 % level, this is $15 \% \times 0.16 \text{ mA per } \%$ which equals the 2.4 mA. This must be added to 4 mA to obtain the current value to be set: $2.4 \text{ mA} + 4 \text{ mA} = 6.4 \text{ mA}$.

To perform empty tank calibration on a partially filled tank:

1. Turn the function switch to position 2.
2. Press the \square or \oplus keys for 2 s.
3. Set the desired current value ($>4 \text{ mA}$) using the multimeter connected.
4. Release the key.
 - ↳ Empty calibration is saved.

7.2.4 Function switch: position 3. Carry out full calibration - for full tanks

If the tank is full (100 %), the full calibration sets the signal current to the upper value of 20 mA. When empty calibration is completed, the current value of 20 mA is displayed at the ammeter.

To perform full tank calibration:

1. Turn the function switch to position 3.
2. Press the \square and \oplus keys together for 2 s until the green or red LED flashes.
3. Release the two keys again.
4. The flashing stops after 10 s.
 - ↳ Empty calibration is saved.

7.2.5 Function switch: position 3. Carry out full calibration - for almost full tanks

If possible, the exact level of the tank should be known and should be as large as possible ($> 70 \%$).

Too low level reduces the accuracy of the upper point which corresponds to the full tank. An ammeter must be connected to the current pick-off at the electronic insert.

For example, the level was determined for 90 %, the electric current value that corresponds to the level of 90 % must be determined. The upper current value can be adjusted with the \square and \oplus keys. The \oplus key increases the value, the \square key reduces the value.

The following must also be considered:

- the lower current value means that the tank is empty, 0 % is 4 mA.
- the upper current value means that the tank is full, 100 % is 20 mA.
- this results in a measuring range of 16 mA for a change from 0 to 100 %. For example 0.16 mA increase in the current for every 1 % increase in the level.
- for a 90 % level, this is $90 \% \times 0.16 \text{ mA per } \%$ which equals the 14.4 mA. This must be added to the 4 mA to obtain the current value to be set: $4 \text{ mA} + 14.4 \text{ mA} = 18.4 \text{ mA}$. It is possible to take the upper current value and then subtract $10 \% \times 0.16 \text{ mA per } \%$ which equals 1.6 mA from 20 mA.

To perform full calibration on a partially filled tank:

1. Turn the function switch to position 3.

2. Press \square or \oplus key for 2 s.
3. Connect the multimeter to the current pick-off.
4. Set the ordered electric current value < 20 mA.
5. Release the key.
 - ↳ The full calibration is saved.

7.2.6 Function switch: position 4. Measuring modes

i Before carrying out empty and full calibration, the medium properties must be configured. If the medium is conductive and tends to form buildup, the "Buildup" operating mode must be selected.

In this operating mode, the buildup on the probe rope is compensated.

The "No buildup" operating mode is set at the factory.

Subfunction: "Medium property"

The **No buildup** operating mode should be set for media that do not tend to form buildup on the probe rope (e.g. water, beverages). As of conductivity of $100 \mu\text{S}/\text{cm}$ like all water-based liquids such as acids, alkalis, the measured value is independent of the conductivity of the liquid (independent of concentration fluctuations).

In the **Buildup** operating mode, the buildup compensation function integrated into the software is activated. In this operating mode, the measured value is independent of the conductivity of the liquid as of conductivity of $1\,000 \mu\text{S}/\text{cm}$ (independent of concentration fluctuations).

This compensates measuring errors caused by conductive media sticking to the probe rope such as yogurt. This corresponds to buildup compensation.

To choose between media forming buildup and media not forming buildup:

1. Turn the function switch to position 4.
2. Press \oplus key for media that tend to form buildup.
 - ↳ The green LED confirms your entry by flashing three times.
3. Press \square key for media that do not form buildup.
 - ↳ The green LED confirms your entry by flashing three times.

7.2.7 Function switch: position 5. Measuring range

At the factory, the measuring range is always calibrated to the ordered probe length. If the electronic insert is used in another probe, the measuring range must be configured in accordance with the probe length.

To configure the measuring range $2\,000 \text{ pF}$ for probe length $< 6 \text{ m}$ (20 ft) or $4\,000 \text{ pF}$ for probe length $> 6 \text{ m}$ (20 ft):



1. Turn the function switch to position 5.
2. Press \square to set measuring range $2\,000 \text{ pF}$
 - ↳ The green LED flashes three times - the value is set.
3. Press \oplus to set measuring range $4\,000 \text{ pF}$
 - ↳ The green LED flashes three times - the value is set.

7.2.8 Function switch: position 6. Proof test - self-test

 Before and after the automatic proof test, it is essential to check whether the level value displayed corresponds to the actual level value ²⁾.

When the self-test is activated, the current output is set to 4 mA and follows a ramp function up to 22 mA. This test is completed after 40 s.

To activate the device self-test:





1. Turn the function switch to position 6.
2. Press  and  keys together to start the function test.
 - ↳ The green LED flashes quickly until the current error is reached. The red LED flashes until the test is completed.

 After the self-test, the device automatically returns to the operating mode.

7.2.9 Function switch: position 7. Reset - restore factory settings

 The reset can affect the measurement as the current values are overwritten by the factory values of calibration 0% (4 mA) and 100% (20 mA).

To restore the factory settings:

1. Disconnect the electronic insert from the power supply.
2. Turn the function switch to position 7.
3. Press and hold the  and  keys together while the device is being reconnected to the power supply.
 - ↳ Red LED flashes slowly and then starts to flash quickly.
4. Wait until the red LED stops flashing.
5. Release the  and  keys.

7.2.10 Function switch: position 8. Download or upload sensor DAT (EEPROM)

Calibration values can be transmitted with this function.

A distinction is made between two types:

- the sensor has been replaced and the electronic insert should continue to be used
- the electronic insert has been replaced but the sensor should continue to be used

The calibration values already set can be transferred from the sensor to the electronic insert or from the electronic insert to the sensor.

Download

To transfer the calibration values from the electronic insert to the sensor:

1. Turn the function switch to position 8.
2. Press the  key to start downloading from the electronic insert to the sensor.
 - ↳ The green LED flashes for 2 s, confirming your entry.

The device restarts.

Upload

To transfer the calibration values from the sensor to the electronic insert:

1. Turn the function switch to position 8.

2) This applies from version FW: V 01.03.00

2. Press the \oplus key to start uploading from the sensor to the electronic insert.
 - ↳ The green LED flashes for 2 s, confirming your entry.

The device restarts.

7.3 Menu: "Basic setup". Commissioning with display and operating module

i This section describes how to commission the Liquicap M, the display and the operating module. The procedure for commissioning through FieldCare, DeviceCare or FieldXpert handheld terminal is the same. More detailed information can be found in the Operating Instructions for FieldCare BA 224F/00 supplied together with the handheld terminal.

7.3.1 Initial commissioning





On the first power-up, you are requested to select the language for the display texts. After this selection, the measured value is displayed.

i If a reset is performed at the device and if the power supply is switched off and on again, the language of the display texts has to be selected again.

Menu structures: Main menu

The main menu is activated by means of the right Enter key \leftarrow .

The following menu headings appear. These are explained in more detail over the following pages:

- Basic setup →  44
- Safety setting →  50
- Linearization →  53
- Output →  60
- Device properties →  63

i Liquicap M devices are calibrated on leaving the factory for media with a conductivity of $\geq 100 \mu\text{S}/\text{cm}$. Recalibration is only necessary if the 0 % value or the 100 % value should be adjusted to suit customer-specific requirements, the distance to the tank wall is $< 250 \text{ mm}$ (9.84 in) or if the liquid is not conductive.

A distinction is generally made between two types of calibration:

- Wet calibration
 - During wet calibration, the probe must be covered by a liquid in the installed state. This calibration can be done if the tank is empty, full or partially full. Empty and full calibration must be performed.
- Dry calibration
 - During dry calibration, empty and full calibration can done without the probe being in contact with the liquid. The calibration values can be entered directly in units of length.

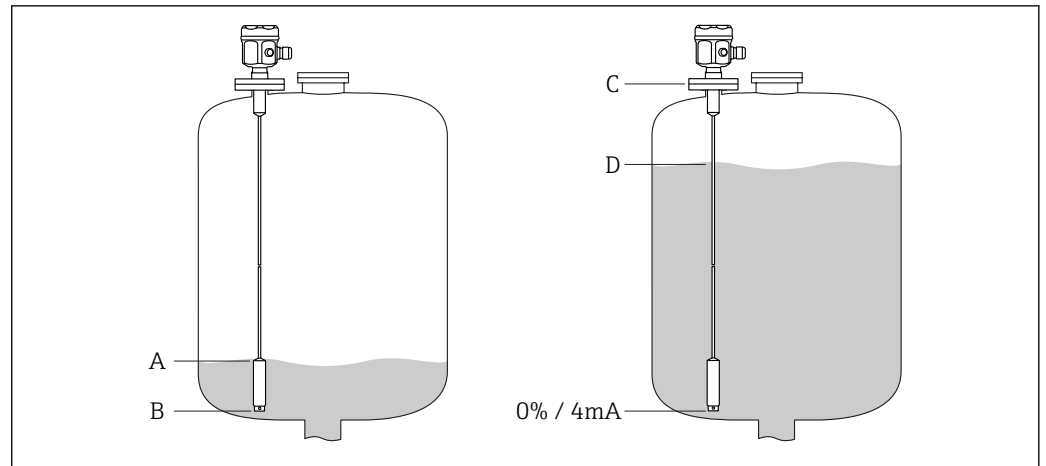

- A Customer specified 0% level (empty tank)
- B Factory setting for 0% level (empty tank)
- C Factory setting for 100% level (full tank)
- D Customer specified 100% level (full tank)

Configure the settings in the "Basic setup" menu:

 The factory settings are shown in bold.

Basic setup

- function: Basic setup
 - subfunction:
 - Medium property: **no buildup**, buildup
 - Cal. type: Dry, **Wet**
- function: Medium property ³⁾
 - subfunction: Medium property
 - **Conductive**
 - Nonconductive ⁴⁾
 - interface
 - unknown
 - subfunction: DC value ⁵⁾
 - Value
 - subfunction: Unit level ⁶⁾
 - **% (percentage)**
 - m
 - mm
 - ft
 - inch
- function: Empty calibr.
 - subfunction: Value empty
 - **0 %**
 - subfunction: Measure capacity
 - xxxx pF
 - subfunction: Confirm cal.:
 - **Yes**
- function: Full calibr.
 - subfunction: Value full
 - **100%**
 - subfunction: Measure capacity
 - xxxx pF
 - subfunction: Confirm cal.:
 - **Yes**
- function: Output damping
 - subfunction: Output damping
 - **1 s**

7.3.2 Function: "Basic setup"**Subfunction: "Medium property"**

The "No buildup" operating mode should be set for media that do not tend to form buildup on the probe rope, like water, beverages, etc. For conductivity of 100 $\mu\text{S}/\text{cm}$, the measured value is independent ⁷⁾ of the conductivity of the liquid.

In the "Buildup" operating mode, the buildup compensation function integrated with the software is activated. In this operating mode, the measured value is independent ⁷⁾ of the conductivity of the liquid conductivity of 1 000 $\mu\text{S}/\text{cm}$.

This compensates measuring errors caused by conductive media sticking to the probe rope such as yogurt. This corresponds to buildup compensation.

3) The function is displayed if the function value "Dry" was selected under the subfunction "Cal. type".

4) The function value can be selected only for probes with a ground tube.

5) The subfunction is displayed if the function value "Nonconductive" was selected under the subfunction "Medium property".

6) The subfunction is displayed if the function value "Nonconductive" or "Conductive" was selected under the subfunction "Medium property".

7) Independent of concentration fluctuations.

Subfunction: "Cal. type"

In the "Dry" "Cal. type" empty and full calibration can be carried out without the probe being in contact with the liquid. The calibration values can be entered directly in units of length.

In the "Wet" "Cal. Type", the probe must be covered by the liquid in the installed state for a full calibration. This calibration can also be carried out if the tank is partially full. Both the empty calibration and full calibration must be performed.

7.3.3 Function: "Medium property"

 This function is only displayed if the function value "Dry" was selected under the subfunction "Cal. type".

Subfunction: "Medium property"

The properties of the medium are entered here.

- "Nonconductive": the conductivity of the medium is $\leq 1 \mu\text{S}/\text{cm}$ - only with the ground tube
- "Conductive": the conductivity of the medium is $\geq 100 \mu\text{S}/\text{cm}$
- "Interface": the properties of the two media can be entered in the operating program of ToF Tool. The associated calibration values are then calculated
- "Unknown": the medium properties are not known. The capacitance values of the "Empty calibr." and "Full calibr." functions can be entered directly

Subfunction: "DC value"

 This subfunction is only displayed if the function value "Nonconductive" was selected under the subfunction "Medium property".

The dielectric constant for the liquid to be measured is entered here, go to the "Measuring condition" →  14.

Subfunction: "Unit level"

 This subfunction is only displayed if the function value "Conductive" or "Nonconductive" was selected under "Medium property".

The desired level unit for Basic setup is entered here.

7.3.4 Operating mode: "Empty calibr." and function - "Wet"

 The calibration data can be calculated with **CapCalc.xls**

With "Empty calibration", the 0% value or the 4 mA value is assigned to the level value.

 The procedure applies to the "Wet" type of calibration. Information on "Dry" calibration is provided below.

Subfunction: "Value empty"

The current level value is entered here, for example 5% partial filling → "Value empty" 5% or 0% partial filling → "Value empty" 0%.

 To keep the calibration error to a minimum, the level should be between 0% and 30%.

Subfunction: "Measure capacity"

The capacitance value currently measured is displayed here.

Subfunction: "Confirm cal."

In this function, empty calibration is confirmed and the "Measure capacity" currently measured is assigned to the percentage level value entered as "Value empty".

7.3.5 Operating mode: "Full calibr." and function - "Wet"

With "Full calibration", the 100% value or the 20 mA value is assigned to the level value.

i The procedure applies to the "Wet" type of calibration. Information on "Dry" calibration is provided further below.

Subfunction: "Value full"

The current level value is entered here, for example 90% partial filling → "Value full" 90% or 100% filling → "Value full" 100%.

i To keep the calibration error to a minimum, the level should be between 70% and 100%.

Subfunction: "Measure capacity"

The capacitance value currently measured is displayed here.

Subfunction: "Confirm cal."

Full calibration must be confirmed with this function.

7.3.6 Operating mode: "Empty calibr." and function - "Dry"

The "Empty" value can be entered directly in units of length if the medium property has been set to conductive or nonconductive.

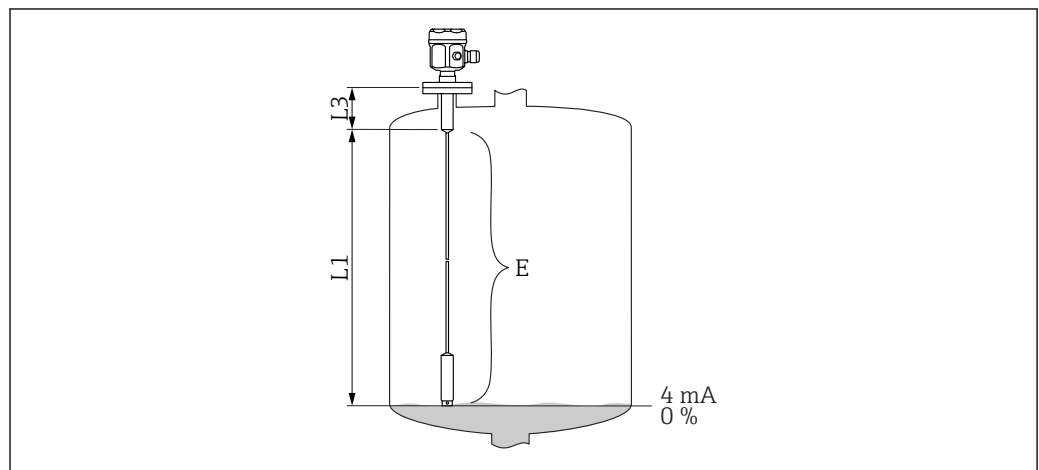
Subfunction: "Value empty", medium property for the conductive and nonconductive medium

L1 Active probe length.

L3 Thread length.

E The distance from the active probe rope to the desired zero-point.

Value E:

Empty calibration ≤ active probe length

$E \leq L1 - (\text{thread length } L3 + \text{plug})$

Thread length:

L3 for G1½ = 25 mm (0.98 in)

L3 for G <1½ = 19 mm (0.75 in)

Plug:

10 mm (0.39 in) rope = 10 mm (0.39 in)

16 mm (0.63 in) rope = 15 mm (0.59 in)

22 mm (0.87 in) rope = 15 mm (0.59 in)

Subfunction: "Cap. empty"

The calculated capacitance value is displayed here. This field cannot be edited.

Subfunction: "Confirm cal."

Empty calibration is confirmed with this subfunction.

7.3.7 Operating mode: "Full calibration" and function - "Dry" for conductive and nonconductive media

The "Full" value can be entered directly in units of length.

Subfunction: "Value full", medium property - conductive, nonconductive

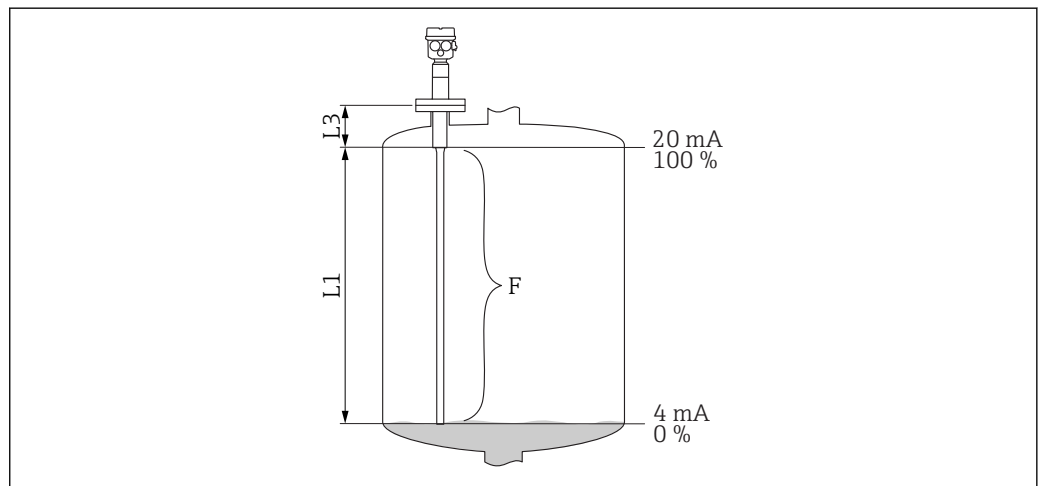

A0040523

L1 Active probe rope.

L3 Thread length.

F The distance from the zero-point to the desired 100% point.

Value full:

C ≤ Empty value

Subfunction: "Cap. full"

The calculated capacitance value is displayed here. This field cannot be edited.

Subfunction: "Confirm cal."

Full calibration is confirmed with this subfunction.

7.3.8 Operating mode: "Empty calibration" and function - "Dry" for "Interface" or "Unknown" medium properties

Subfunction: "Value empty"

This field displays 0% and cannot be edited.

Subfunction: "Cap. empty"

Enter the capacitance value, for example calculated with CapCalc.xls.

Subfunction: "Confirm cal."

Empty calibration must be confirmed with this subfunction.

7.3.9 Operating mode: "Full calibration" and function - "Dry" for "Interface" or "Unknown" medium properties

Subfunction: "Value full"

This field displays 100% and cannot be edited.

Subfunction: "Cap. full"

Enter the capacitance value, for example calculated with CapCalc.xls.

Subfunction: "Confirm cal."

Empty calibration must be confirmed with this subfunction.

7.3.10 Function: "Output damping"

With this function, you can set the reaction time of your measuring device to changes in the level. If surfaces are turbulent, a higher output damping should be selected.

7.4 Menu: "Safety setting"

Follow the settings in the "Safety settings" menu.



The factory settings are shown in bold.

Safety settings

- function: Safety settings
 - subfunction: Code
 - **100**
 - subfunction: Status
 - **Unlocked**
 - Locked
- function: Safety settings
 - subfunction: Operating mode
 - Standard
 - SIL/WHG
 - subfunction: Output damping
 - **1 s**
 - subfunction: Output 1
 - MAX
 - subfunction: Parameter okay
 - no
 - Yes
- function: Safety settings
 - subfunction: Cap. empty
 - x.xx pF
 - subfunction: Value empty
 - x.xxx%
 - subfunction: Cap. full
 - 2 000 pF
 - subfunction: Value full
 - 100.000%
 - subfunction: Parameter okay
 - no
 - Yes
- function: Operating mode
 - subfunction: Operating mode
 - **Standard**
 - SIL/WHG
 - subfunction: SIL op. mode ⁸⁾
 - **Unlocked**
 - Locked
 - subfunction: Status
 - **Unlocked**
 - Locked
- function: Output on alarm
 - subfunction: Output
 - **Max**
 - Hold
 - User-spec.
 - subfunction: Output value ⁹⁾
 - xx.xx mA
- function: Proof test
 - subfunction: Proof test
 - **Off**
 - On

8) The subfunction is displayed if the "SIL/WHG" option was selected under the "Operating mode" subfunction.

9) The subfunction is displayed if the "User-specific" option was selected under the "Output" subfunction.

7.4.1 Function: "Safety settings"

Subfunction: "Code"

With this subfunction, you can lock the device against unpermitted or unintentional changes.

Enter a number that is not equal 100 to lock the device. The parameters cannot be modified.

Enter 100 to unlock the device. Parameters can be modified again.

Subfunction: "Status"

This subfunction displays the current locking status of the device.

The following values can appear:

- Unlocked
All writeable parameters can be modified.
- Locked
The device has been locked via the operating menu. It can only be unlocked by entering "100" in the "Code" subfunction.

7.4.2 Function: "Safety settings"

Subfunction: "Operating mode"

This subfunction displays the set operating mode and cannot be edited.

Operating modes:

- Standard
- SIL/WHG

Subfunction: "Output damping"

This subfunction displays the output damping setting. Output damping is the time during which the measuring system reacts to changes in level of the liquid and is between 0 to 60 s.

Subfunction: "Output 1"

This subfunction displays the set value which the output assumes in an alarm condition.

Values:

- MAX (22 mA)
- Hold - the last value is held
- User-spec.

Subfunction: "Parameter okay"

With this subfunction, you confirm that the parameter values displayed under the "Safety settings II" function are correct.

 The "Parameter okay" subfunction has to be confirmed with "Yes" so the device can be locked for the SIL/WHG operating mode. In addition, the SIL/WHG function value has to be selected for the "Operating mode" subfunction and "Locked" must be set for the "Status" subfunction. The device can be unlocked using the special release code. The release code is "7452".

7.4.3 Function: "Safety settings"

Subfunction: "Cap. empty"

This subfunction displays the measured capacitance during empty calibration in pF.

Subfunction: "Value empty"

This subfunction displays the empty calibration value in %.

Subfunction: "Cap. full"

This subfunction displays the measured capacitance during full calibration in pF.

Subfunction: "Value full"

This subfunction displays the full calibration value in %.

Subfunction: "Parameter okay"

With this subfunction, you confirm that the parameter values displayed under the "Safety settings II" function are correct.



The "Parameter okay" subfunction has to be confirmed with "Yes" so the device can be locked for the SIL/WHG operating mode. In addition, the SIL/WHG function value has to be selected for the "Operating mode" subfunction and "Locked" must be set for the "Status" subfunction. The device can be unlocked using the special release code. The release code is "7452".

7.4.4 Function: "Operating mode"

Subfunction: "Operating mode"

With this subfunction, you can switch from the Standard operating mode to the SIL/WHG operating mode:

- Standard
- SIL/WHG

The following parameters are set to defined values in the "SIL/WHG" operating mode:

- Output damping: Output damping is fixed at 1 s.
- Output on alarm: The "Output on alarm" function is fixed at 22 mA.

In the "SIL/WHG" operating mode, cyclic self-monitoring of the device is like a memory test, processor test, current output, etc.

Subfunction: "SIL operating mode"

You can lock or unlock the device in this subfunction. No parameters can be changed in the locked state.

Subfunction: "Status"

This subfunction displays the current locking status of the device.

The following values can appear:

- Unlocked
All writeable parameters can be modified.
- Locked
The device has been locked via the operating menu.



The device can be only unlocked by entering "100" in the subfunction "Code" → 50.

7.4.5 Function: "Safety settings"

Subfunction: "Operating mode"

The "Standard" or "SIL/WHG" operating mode entered is displayed here.

Subfunction: "Output damping"

The output damping entered is displayed here.

Subfunction: "Value empty"

The capacitance of the empty calibration is displayed here.

Subfunction: "Value full"

The capacitance of the full calibration is displayed here.

Subfunction: "Parameter okay"

With this subfunction, you confirm that the parameter values displayed under the "Safety settings II" function are correct.

 The "Parameter okay" subfunction has to be confirmed with "Yes" so the device can be locked for the SIL/WHG operating mode. In addition, the SIL/WHG function value has to be selected for the "Operating mode" subfunction and "Locked" must be set for the "Status" subfunction. The device can be unlocked using the special release code. The release code is "7452".

7.4.6 Function: "Output on alarm"

Subfunction: "Output"

This function determines the value the output in question assumes when an alarm condition occurs.

Options:

- Max
22 mA
- Hold
the last value is retained
- User-spec.
as defined in the "Output value" subfunction

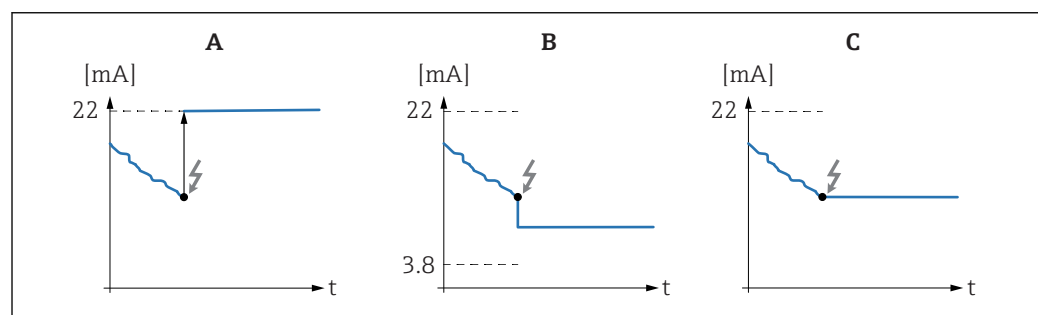

A0040524

- A Output current flow in "Max" setting
 B Output current flow in "Hold" setting
 C Output current flow in "User spec." setting

Subfunction: "Output value" - only for "Output" and "User-specific"

In this function, specify the user-specific value the current output should assume in an alarm condition.

Value range: 3.8 to 22 mA.

7.4.7 Function: "Proof test" - self-test

From version FW: V 01.03.00:

- before and after the automatic proof test, it is essential to check whether the level value displayed corresponds to the actual level value
- after the self-test, the device automatically returns to the operating mode

Subfunction: "Proof test"

With this subfunction, you activate the device self-test. All electronic components relevant to the function are tested. Within 40 s, the current output goes through the range of 4 to 22 mA.

7.5 Menu: "Linearization"

"Linearization" is used for converting the level to any unit. You can determine the volume or the mass in a tank of any shape. Liquicap M makes various linearization modes available for situations that occur frequently. Furthermore, a linearization table can be entered for tanks and containers of any shape.



The number and type of subfunctions depend on the type of linearization selected. Only the "Type" and "Mode" subfunctions are always available.

You can make the following settings in the "Linearization" menu.



The factory settings are shown in bold.

Linearization

- function: Linearization
 - subfunction: Type
 - None
 - **Linear**
 - Horizontal cyl ¹⁰⁾
 - Sphere ¹⁰⁾
 - Pyramid bottom ¹¹⁾
 - Conical bottom ¹¹⁾
 - Angled bottom ¹¹⁾
 - Table
 - subfunction: Mode
 - **level**
 - Ullage
 - subfunction: Simulation
 - **Sim. off**
 - Sim. level
 - Sim. volume
 - subfunction: Sim. level value or Sim. vol. value ¹²⁾
 - xx.x%

10) If you enter a value for this function, you must also enter a value for the "Diameter" subfunction in another step.

11) If you enter a value for this function, you must also enter a value for the "Intermed. height" subfunction in another step.

12) The function is displayed if the "Sim. off" option was not selected under the "Simulation" subfunction.

- function: Linearization
 - subfunction: Customer unit
 - % (percentage)
 - l
 - hl
 - m³
 - dm³
 - cm³
 - ft³
 - usgal
 - igal
 - kg
 - t
 - lb
 - ton
 - m³
 - ft³
 - mm
 - inch
 - user-spec.
 - subfunction: Customized text ¹³⁾
 - subfunction: Diameter ¹⁴⁾
 - xxxx m
 - subfunction: Intermed. height ¹⁵⁾
 - xx m
 - subfunction: Edit ¹⁶⁾
 - **Read:** Table No.: 1, Input level: x m, Input volume: %
 - **Manual:** Table No.: 1, Input level: x m, Input volume: %
 - **Semi-automat.:** Table No.: 1, Input level: x m, Input volume: %
 - Delete
 - subfunction: Status table ¹⁶⁾
 - **Enabled**
 - Disabled
 - subfunction: Max. scale ¹⁶⁾
 - **100 %**

7.5.1 Function: "Linearization"

Subfunction: "Type"

Select the type of linearization in this subfunction.

Options:

- None

In this type of linearization, the measured level is not converted but instead is output linearly in the level unit selected →  45.
- Linear

In this type of linearization, the measured value output is linear to the measured level.

13) The function is displayed if the "User-spec." option was selected under the "Customer unit" subfunction.

14) The function is displayed if the "Horizontal cyl" or "Sphere" option was selected under the "Type" subfunction.

15) The function is displayed if the "Pyramid bottom", "Conical bottom" or "Angled bottom" option was selected under the "Type" subfunction.

16) The function is displayed if the "Table" option was selected under the "Type" subfunction

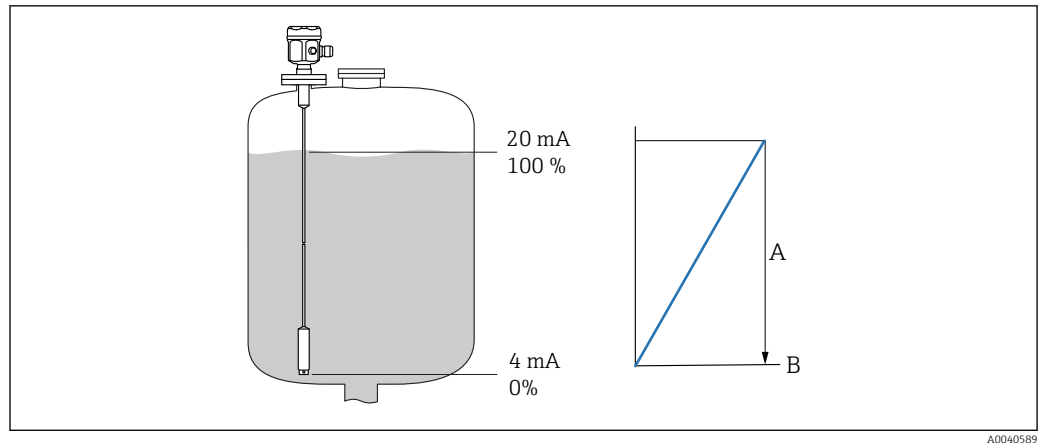

A The maximum tank content.

The following parameters must be specified:

- the unit for the linearized value
- the maximum tank contents measured in a customer unit

Options:

- Horizontal cyl.
- Sphere

In these types of linearization, the volume in a spherical tank or in a horizontal cylindrical tank is calculated from the liquid level.

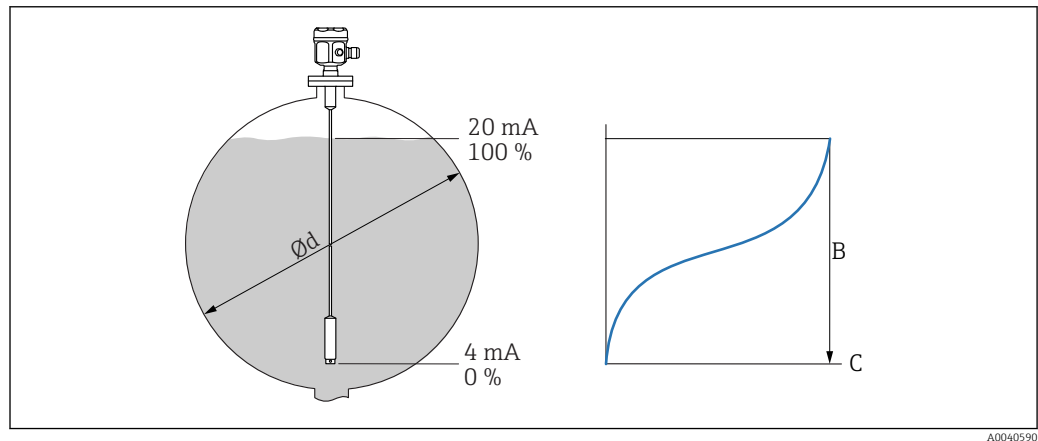

$\varnothing d$ The cylindrical or spherical tank diameter

C The maximum tank content

The following parameters must be specified:

- the unit for the linearized value
- the tank diameter
- the maximum tank contents measured in a customer unit

Options:

- Pyramid bottom
- Conical bottom
- Angled bottom

In these types of linearization, the volume in a spherical tank or in a horizontal cylindrical tank is calculated from the liquid level.

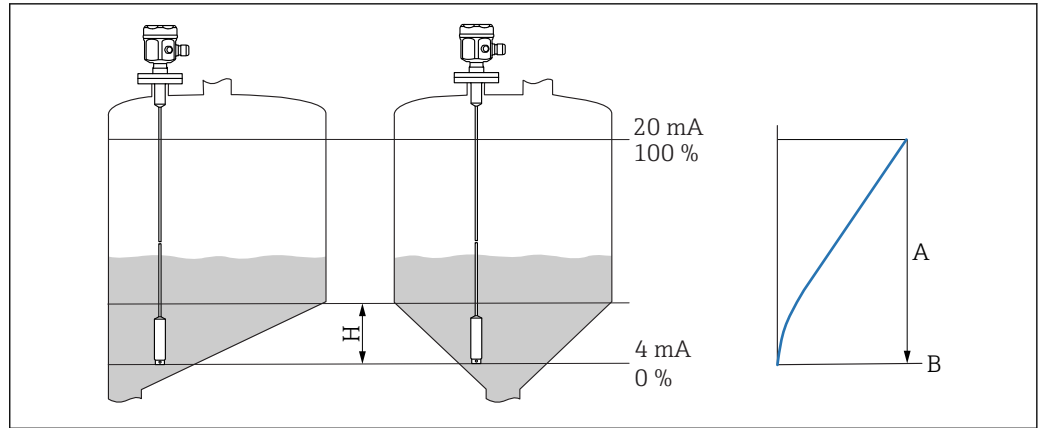

A0040591

B The maximum tank content
H The intermediate height

The following parameters must be specified:

- the unit for the linearized value
- The intermediate height in accordance with the diagram
- the maximum tank contents measured in a customer unit

Options:

Table

In this type of linearization, the measured value is calculated using a linearization table. The table can comprise up to 32 "Level - Volume" value pairs. The table must be monotone.

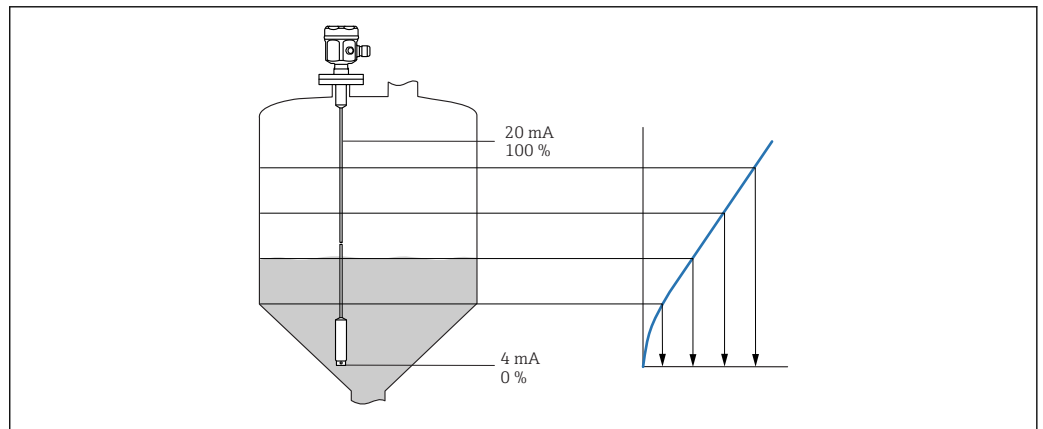

A0040592

The following parameters must be specified:

- the unit for the linearized value
- the linearization table

Subfunction: "Mode"

In this subfunction, specify whether the measurement should refer to level A or to the empty area B.

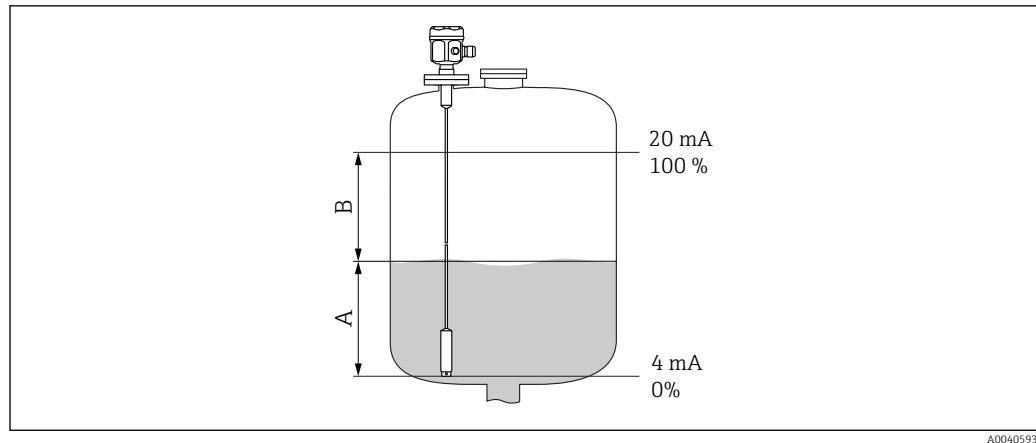

A Filled area
B Empty area

Subfunction: "Simulation"

In this subfunction, you can simulate the level or the volume by entering a level under "Sim. level value" or a volume under "Sim. vol. value".

Subfunction: "Sim. level value" or "Sim. vol. value"

In this subfunction, you can enter the level or volume value to be simulated.

7.5.2 Function: "Linearization"

Subfunction: "Customer unit"

In this subfunction, enter the desired unit for the linearized values, for example: kg, m³, ft³.

Subfunction: "Customized text"

In this subfunction, enter your specific name for the unit. The measured value indicated in the main screen will then be displayed in this unit.

Subfunction: "Diameter"

In this subfunction, specify the diameter of the horizontal cylindrical tank or the spherical tank. Subfunction is available only for the "dry" type of basic setup.

Subfunction: "Intermed. height"

In this function, specify the intermediate height H (☑ → ☑ 55) of the container in question. The probe length L1 must be entered here in the event of a wet calibration.

Subfunction: "Edit"

Use this function to enter, modify or read the linearization table.

The following options are available:

- Read
The table editor is opened. The existing table can be read but not edited.
- Manual
The table editor is opened. Table values can be entered or modified.
- Semi-automat.
The table editor is opened. The level value is read in automatically. The related measured value must be entered by the user.
- Delete
The linearization table is deleted.



 The linearization table can only be edited if it is disabled.

The table editor

A	B	C
1	0,0000	0,0000
2	0,0000	0,0000
3	0,0000	0,0000
...	0,0000	0,0000

A0040751





- A Row number
- B Level column
- C Value column



1. Press  to go to the next row.
2. Press  to go to the previous row.
3. Press  to open marked row for editing.

A	B	C
1	0,0000	0,0000
2	0,0000	0,0000
3	0,0000	0,0000
...	0,0000	0,0000

A0040752

- A Row number
- B Level column
- C Value column

1. Press  or  to navigate within the table.
2. Press  or  to navigate on No. column.
3. Press  to "Delete", "Insert" or "Move" the entire row.

 You can return to the previous step by pressing **Escape** →  31.

Subfunction: "Status table"

In this function, you can specify whether the linearization table should be used or not.

Options:

- Enabled
The table is used.
- Disabled
The table is not used. The measured value is output linearly with regard to the level unit.

Subfunction: "Max. scale"

In this function, specify the maximum contents of the tank in the customer unit.

7.6 Menu: "Output"

You can make the following settings in the "Output" menu:

 The factory settings are shown in bold.

Submenu: Extended calibr.

- function: Extended calibr.
 - subfunction: Measuring range
 - **2 000 pF**
 - 4 000 pF
 - subfunction: Sensor DAT Stat.
 - **OK**
 - subfunction: Sensor DAT
 - **Upload**
 - Download
- function: Output / Calculat
 - subfunction: Curr. turn down
 - On
 - **Off**
 - subfunction: Turn down 4 mA ¹⁷⁾
 - **0%**
 - subfunction: Turn down 20 mA ¹⁷⁾
 - **100%**
 - subfunction: 4 mA threshold
 - On
 - **Off**

Submenu: HART setting

- function: HART setting
 - subfunction: HART address
 - 0
 - subfunction: No. of preambles
 - 5
 - subfunction: Short TAG HART
 - TAG
- subfunction: Output / Calculat
 - - Current span
 - **4 to 20 mA**
 - Fix. curr. HART
 - subfunction: mA value ¹⁸⁾
 - **4 mA**

Submenu: Simulation

- function: Simulation
 - **Off**
 - On
- function: Simulation value ¹⁹⁾
 - xx.xx mA

17) This function is only displayed if the "On" option was selected under the "Curr. turn down" subfunction.

18) This function is only displayed if the function value "Fix. curr. HART" was selected under the "Current span" subfunction.

19) This function is only displayed if the "On" option was selected under the "Simulation" function.

7.6.1 Submenu: "Extended calibr."

Function: "Extended calibr."

In this function, you can specify the measuring range.

Subfunction: "Measuring range"

Specify the measuring range in this subfunction.

- $C_A = 0$ to 2 000 pF for probe length < 6 m (20 ft)
- $C_A = 0$ to 4 000 pF for probe length > 6 m (20 ft)

 At the factory, the measuring range is always calibrated to the probe length ordered. If the electronic insert is used in another probe, the measuring range must be configured in accordance with the probe length.

Function: "Output/Calculat."

Subfunction: "Sensor DAT stat."

This subfunction shows the status of the sensor DAT.

- OK - sensor DAT is ready for use
- Error - sensor DAT is not ready for use or missing

Subfunction: "Sensor DAT"

Calibration values can be transmitted with this function. A distinction is made between two types:

- the sensor has been replaced and the electronic insert should continue to be used
- the electronic insert has been replaced but the sensor should continue to be used

For these instances, the calibration values already set can be transferred from the sensor to the electronic insert or from the electronic insert to the sensor.

Upload

To transfer the calibration values from the sensor to the electronic insert.

Download

To transfer the calibration values from the electronic insert to the sensor.

Subfunction: "Curr. turn down"

 This subfunction is not available for "Current span", "Fix. curr. HART".

This function can switch on the current turn down. The current output refers only to a freely definable part of the measuring range. This is then magnified when displayed.

Subfunction: "Turn down 4 mA"

 This subfunction is available only for "Curr. turn down", "On".

Enter the measured value at which the current should be 4 mA.

Subfunction: "Turn down 20 mA"

 This subfunction is available only for "Curr. turn down", "On".

Enter the measured value at which the current should be 20 mA.

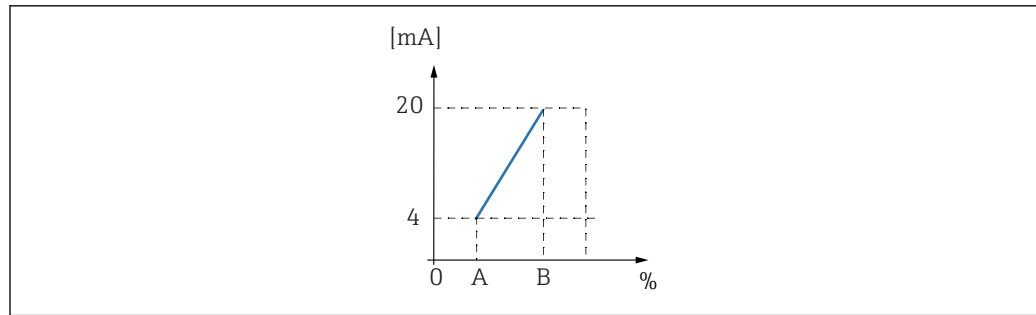

A0040572

- A Turn down 4 mA
- B Turn down 20 mA

Subfunction: "4 mA threshold" - for Current span = 4 to 20 mA

It is possible to switch on the 4 mA threshold in this subfunction. The 4 mA threshold means that the current never is below, 4 mA even if the measured value is negative.

Options:

- Off
The threshold is switched off. Currents under 4 mA can occur.
- On
The threshold is switched on. The current is never below 4 mA.

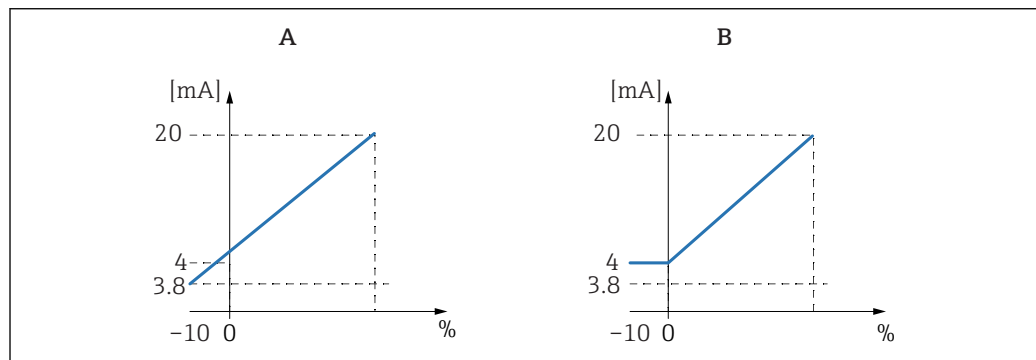

A0040573

- A 4 mA threshold off.
- B 4 mA threshold on.

7.6.2 Submenu: "HART setting"

Function: "HART settings"

Subfunction: "HART address"

In this subfunction, specify the HART communication address for the device.

Possible values:

- for standard operation: 0
- for multidrop operation: 1 - 15

 In multidrop operation, the output current is 4 mA as standard. However, it can be changed in the "mA value" function.

Subfunction: "No. of preambles"

In this subfunction, specify the number of preambles for the HART protocol. Increase the value if there are communication problems on the lines.

Subfunction: "Short TAG HART"

Here, you can enter the TAG name for HART communication in the device.

Function: Output / Calculat.*Subfunction: "Current span"*

In this subfunction, select the current span to which the measuring range should be mapped.

Options:

- 4 to 20 mA
the measuring range 0 to 100 % is mapped to the 4 to 20 mA current span
- Fix. curr. HART
a fixed current is an output. Its value can be specified in the "mA value" subfunction. The measured value is only transmitted via the HART signal

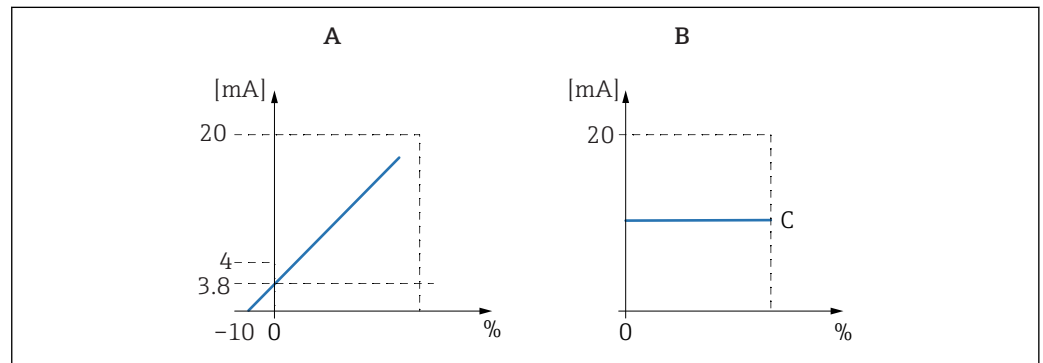

- A Current span = 4 to 20 mA.
 B Current span = fix. curr. HART.
 C mA value

7.6.3 Menu: "Simulation"**Function: "Simulation"***Subfunction: "Simulation"*

This function switches on or off the simulation of output current.

Options:

- Off
The device is not in the simulation mode. The device is in the measuring mode.
- On
The device is in the simulation mode. A measured value is not output. Instead, the current output assumes the value defined in the "Simulation value" subfunction.

Subfunction: "Simulation value" - only for "Simulation On" mode

Specify the current value to be simulated in this function.

7.7 Menu: "Device properties"

 The factory settings are shown in bold.

You can configure the following settings in the "Device properties" menu:

submenu: Display

- function: Language
 - **English**
 - Deutsch
 - Francais
 - Espanol
 - Italiano
 - Nederlands
- function: Display format
 - subfunction: Format
 - Decimal**
 - ft-in-1/16"
 - subfunction: No of decimals
 - x
 - x.x
 - **x.xx**
 - x.xxx
 - subfunction: Sep. character
 - **(dot)**
 - ,
 - subfunction: Back to home
 - 900 s

submenu: Diagnostics

- function: Actual error
 - subfunction: Actual error 1
 -
 - subfunction: Actual error 2
 -
 - subfunction: Actual error 3
 -
- function: Last error
 - subfunction: reset errorlist
 - Keep
 - Delete
 - Last error 2
 -
 - Last error 3
 -
- function: Password / reset
 - subfunction: Reset
 - 12345
 - subfunction: Status
 - **Unlocked**
- function: Electronic temp.
 - Electronic temp.
 - xx.x °C
 - Max. temp.
 - xx.x °C
 - Min. temp.
 - xx.x °C
 - Temperature unit
 - °C
 - °F
 - K
 - Min / Max temp.
 - **Keep**
 - Delete
 - Reset Min.
 - Reset Max.
- function: Measure capacity
 - subfunction: Measure capacity
 - xxxx.xx pF
 - subfunction: Max. capacity val
 - xxxx.xx pF
 - Min / Max capacity
 - **Keep**
 - Delete
 - Reset Min.
 - Reset Max.

submenu: System parameters

- function: Device information
 - subfunction: Device designation
 - Liquicap-FMI5x
 - subfunction: Serial No.
 -
 - subfunction: EC Serial No.
 - xxxxxxxxxxxx
 - subfunction: Device marking
 - FMI51- OrderCode
- function: Device information
 - subfunction: Dev. rev
 - x
 - subfunction: Software version
 - V01.zz.zz.zzz
 - subfunction: DD version
 - xx
- function: Device information
 - subfunction: Working hour
 - xxxxx h
 - subfunction: Current run time
 - 000d00h00m
- subfunction: Probe length
 - Probe length
 - xxx mm
 - Sensitivity
 - 0.0

7.7.1 Submenu: "Display"**Function: "Language"**

Select the language for the display and operating module.

Options:

- English
- Deutsch
- Français
- Español
- Italiano
- Nederlands

Function: "Display format"

The "Display format" refers to how the measured value is displayed.

Subfunction: "Format"

Select the display format for displaying numbers.

Options:

- Decimal
- ft-in-1/16"

Subfunction: "No. of decimals"

Select the number of places after the decimal point for displaying numbers.

Options:

- x
- x.x
- x.xx
- x.xxx

Subfunction: "Sep. character"

Select the separator for displaying decimal numbers.

Options:

- . (dot)
- , (comma)

7.7.2 Submenu: "Diagnosis"

Function: "Actual error"

With this function, you can call up the list of all currently pending errors. The errors are arranged by priority.

If you select an error, a text field appears with a brief description of the error.

Error code list →  75

Function: "Last error"

With this function, you can call up the list of all rectified errors. The option of resetting the error list with "Reset error list" is also available. It overwrites the last three error codes with 0.

Function: "Password / reset"

This function restores the factory settings. All parameters are reset to factory settings.

Subfunction: "Reset"

 The factory settings are bold in the menu overview.

Enter the reset code "333" or "7864" to reset all the parameters to the factory settings.

During a "333" reset, linearization is reset to "linear". However, any linearization table available is retained and can be activated again where necessary.

During a "7864" reset, linearization is reset to "linear" and the linearization table is deleted.

The subfunctions are also reset:

- "Electronic temp."
- "Max. temp."
- "Max. capacity val."
- "Min. capacity val."
- "Min/Max capacity"

Function: "Electronic temp."

This function displays the temperature measured by the electronic insert.

Subfunction: "Electronic temp."

The subfunction displays the current electronics temperature.

Subfunction: "Max. temp."

The subfunction displays the highest temperature value measured by the device.

Subfunction: "Min. temp."

The subfunction displays the lowest temperature value measured by the device.

Subfunction: "Temperature unit"

The subfunction determines the temperature unit.

Options:

- °C
- °F
- K

Subfunction: "Min/Max temp."

The subfunction resets the "Min/Max temp."

Function: "Measure capacity"

This function displays measuring capacities that were measured by the electronic insert during operation.

Subfunction: "Measure capacity"

This subfunction displays the currently measured capacity.

Subfunction: "Max. capacity val."

This subfunction displays the highest capacitance value measured by the device.

Subfunction: "Min. capacity val."

This subfunction displays the lowest capacitance value measured by the device.

Subfunction: "Min/Max capacity"

The subfunction resets the "Min. or Max. capacity".

7.7.3 Submenu: "System parameters"



All functions listed in this section can be viewed only.

Function: "Device information"

This function displays all device information with which the device can be identified.

Subfunction: "Device marking"

This subfunction displays the device name e.g. Liquicap M-FMI51.

Subfunction: "Serial No."

This subfunction displays the serial number of the device that was assigned in the factory.

Subfunction: "EC Serial No."

This subfunction displays the serial number of the electronic insert.

Subfunction: "Device marking"

This subfunction displays the device marking and the order code.

Subfunction: "Dev. rev"

This subfunction displays the version of the electronic-hardware.

Subfunction: "Software version"

This subfunction displays the software version of the device that was assigned in the factory.

Subfunction: "DD version"

This function indicates the DD version with which this device can be operated using FieldCare.

Subfunction: "Working hour"

This subfunction displays the number of operating hours.

Subfunction: "Current run time"

This subfunction displays the "current run time" of the device. The first three digits display the number of days, followed by "d". The next two digits display the hours, followed by "h". The last two digits indicate the minutes. This subfunction displays the "current run time" of the device. The first three digits display the number of days, followed by "d". The next two digits display the hours, followed by "h". The last two digits indicate the minutes.

Function: "Probe length"

In this function, more probe information can be displayed.

Subfunction: "Probe length"

You can read the current probe length in this subfunction.

Probe length (L1) = A – (thread length – plug)

More information are provided →  46.

Subfunction: "Sensitivity"

You can read off the current sensitivity in mm/pF in this subfunction.

7.8 Operation

After Basic setup, Liquicap M outputs the measured value via:

- the display and operating module
- the current output ²⁰⁾
- the digital HART signal

7.9 FieldCare: operating program from Endress+Hauser

The FieldCare operating program is Endress+Hauser plant asset management tool based on FDT technology. It is possible to use FieldCare to configure all Endress+Hauser devices as well as third-party devices which support the FDT standard. The following operating systems are supported:

- Windows 7 Professional SP1 (x32+x64)
- Windows 7 Ultimate SP1 (x32+x64)
- Windows 7 Enterprise SP1 (x32+x64)
- Windows Server 2008 R2 SP2
- Windows 8.1
- Windows 8.1 Professional
- Windows 8.1 Enterprise
- Windows 10 Professional
- Windows 10 Enterprise

²⁰⁾ The entire measuring range (0 to 100 %) is then mapped to the range (4 to 20 mA) of the current output.

FieldCare supports the following functions:

- configuration of transmitters in online operation
- tank linearization
- loading and saving device data by upload and download
- documentation of the measuring point

Connection options:

HART via Commubox FXA195 and the USB port of a computer.

 After reinstalling FieldCare, or by clicking a link in the Help menu, a video can be activated that explains the possible applications of the program in just a few minutes.

7.9.1 FieldCare

Function scope

FDT-based plant asset management tool from Endress+Hauser. It can configure all smart field devices in a system and helps you manage them. By using the status information, it is also a simple but effective way of checking their status and condition.

 For additional information about FieldCare, see Operating Instructions BA00027S and BA00059S

Connection options: HART via Commubox FXA195 and the USB port of a computer

Source for device description files

- www.endress.com → Downloads
- CD-ROM (contact Endress+Hauser)
- DVD (contact Endress+Hauser)

7.9.2 Interface measurement

If there are different media in the container like water and oil, the capacitance values for "Empty calibration" and "Full calibration" can be calculated.

CapCalc.xls is a capacitance calculation program in FieldCare which can be used to calculate the calibration values for level measurement and interface measurement.

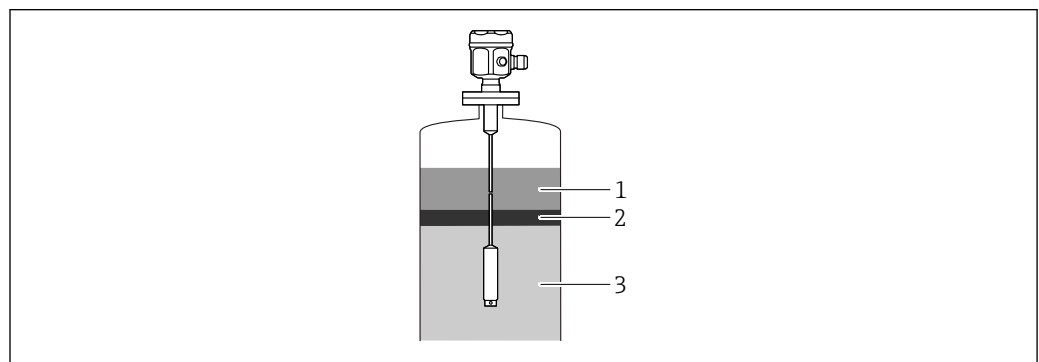

- 1 Nonconductive medium $< 1 \mu\text{S}/\text{cm}$, $DC < 5$
- 2 Emulsion
- 3 Conductive medium $\geq 100 \mu\text{S}/\text{cm}$

The program calculates the calibration values on the basis of the entered data. The secure functioning of interface measurement can already be determined at this time. The

calculated calibration values can be transmitted to the FEI50H electronic insert via the display or FieldCare.

 Capacitance interface measurement is also suitable for very pronounced emulsion layers. The emulsion layer average is always measured.

7.9.3 Dry calibration for interface measurement

Calculating the calibration data with CapCalc

1.

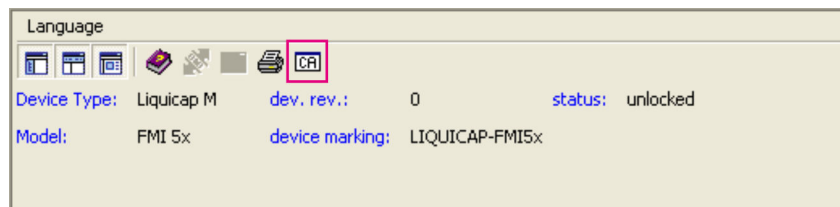

Click the "CA" button in the toolbar to start CapCalc.

2.

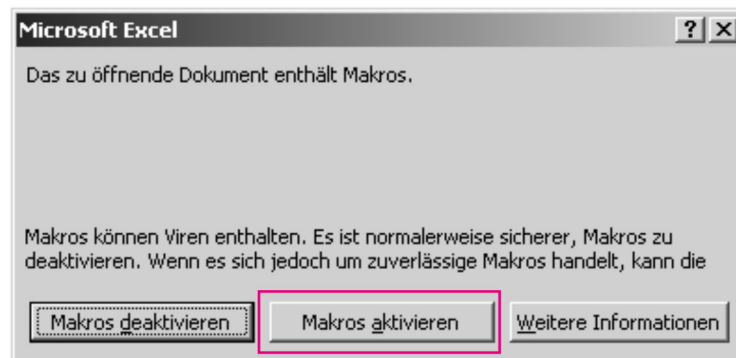

Click "Activate macros" button.

3.

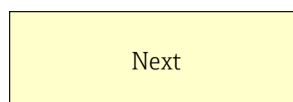

Click the "Next" button in the top right.

Editing the probe and application-specific data

Editing the probe and application-specific data.

1.

Endress+Hauser GmbH+Co.KG
Hauptstraße 1
79689 Maulburg
Germany

Endress+Hauser People for Process Automation

19.01.2007

Customer: Muster GmbH+Co.KG
Customer-No.: X0815
Street: Musterstraße 5
ZIP-Code/Town: 12345
Musterstadt

Attention: Hans Mustermann
Phone: 0815 - 12345
Fax: 0815 - 6789
Reference: Trennschichtmessung
Tag: 1122334455

Probe type FMI51, rod 10mm, PTFE or PFA

Probe diameter: 8 mm
Probe diameter with isolation: 10 mm
DC-value of isolation: 1,9
Base capacity: 27,07 pF
Auxiliary capacities: 0 pF

Probe length L1: 1000 mm
inactive length L3: 0 mm
Value Empty E: 1000 mm
Value Full F: 500 mm
Wall distance: 250 mm

Medium top

Name: oil
Conductivity: 0,01 µS/cm
Dielectric constant: 2,1

Calibration data level

Medium bottom

Name: water
Conductivity: 180 µS/cm
Dielectric constant: 80,4

Calibration data level

Calibration data interface measurement

Click the "Probe type" button.

2. Select the probe type.
3. Enter the length probe L1 in accordance with the nameplate.
4. Enter the inactive length L3 in accordance with the nameplate.
5. Enter the "Value empty E".
6. Enter the "Value full F".
7. Enter the "Wall distance".
8. Enter the conductivity value of the medium in the "Medium top".
9. Enter the dielectric constant value of the medium in the "Medium top".
10. Enter the conductivity value of the medium in the "Medium bottom".
11. Enter the dielectric constant value of the medium in the "Medium bottom".
12. Click the "Calibration data interface measurement" button to obtain the capacitance values for the calibration.
 - ↳ The capacitance values for empty calibration and full calibration are calculated and displayed as a result.

Use the "DC handbook" button to transfer the DC values and the conductivity of the corresponding media to the calculation program, if the medium properties are not known.

7.9.4 Wet calibration for interface measurement

This chapter describes the wet calibration procedure for "Empty calibration" and "Full calibration".

Empty calibration

1. Fill the container with the top medium.

2. Perform "Empty calibration 0%" regarding procedure →  37.

 If it is not possible to fill the tank, perform the "Empty calibration" with the probe exposed in the air, however expect a calibration inaccuracy approximately 2.5 % per meter. The water and oil are the reference media.

Full calibration

1. Fill the container with the bottom medium.

2. Perform "Full calibration 100%" regarding procedure →  37.

The empty and full calibration is completed and all data are saved in the electronic insert and DAT sensor.

8 Diagnostics and troubleshooting

The operating status of the device is indicated by the LEDs on the electronic insert.

8.1 Diagnostic information via LEDs

8.1.1 Green LED flashing

Green LED indicates operation:

- flashes every 5 s
the device is in the operation mode
- flashes once per 1 s
the device is in the calibration mode
- flashes 4x:
the device confirms a parameter change, function switch position 4, 5, 6

8.1.2 Red LED flashing

 To analyze the errors find the list in the chapter "Error codes" →  75

Red LED indicates a fault.

- Warning: LED flashes 5x per second
 - capacitance at probe is too high
 - probe insulation break detection
 - FEI50H is defective
- Alarm: LED flashes 1x per second
the temperature in the electronic insert is over the permitted range

8.2 System error messages

8.2.1 Error signal

Errors occurring during commissioning or during operation are displayed as follows:

- error symbol, error code and error description on the display and operating module
- current output, can be set:
 - Max: 110%, 22 mA
 - Hold - last value is retained
 - User-spec. value

8.2.2 Last errors

This function enables to call up a list of most recent errors.

8.2.3 Types of error

The alarm is represented by the symbol  which appears on the display. An error message is also shown on the display.

The output signal assumes a value that can be specified with the "Output on alarm" function:

- Max: 110%, 22 mA
- Hold - last value is retained
- User-spec. value

The warning is represented by the flashing symbol  which appears on the display. An error message is shown on the display.

The device continues measuring.

8.2.4 Error codes

The error codes shown on the display are 4-digit codes:

Position 1: Type of error

- A - alarm
- W - warning



Positions 2-4:

refers to the error in accordance to with the error list

Alarm codes

- A 101, A 102, A 110, A 152
Checksum error
- total reset and recalibration is necessary
- A 106
Downloading - please wait
wait until the downloading is complete
- A 111, A 112, A 113, A 114, A 115, A 155, A 164, A 171, A 404, A 405, A 407, A 408, A 409, A 410, A 411, A 412, A 413, A 414, A 415, A 416, A 417, A 418, A 421, A 422, A 423, A 424
Electronics defective
- switch the device off and then on
- if the error persists contact Endress+Hauser Service
- A 116
Download error
- repeat download or perform a total reset
- A 426
Data of Sensor-DAT (EEPROM) not consistent
- repeat download from the electronic insert or perform a total reset
- A 427
Current output not calibrated
- repeat download or perform a total reset
- A 1121
current output not calibrated
- contact Endress+Hauser-Service
- A 400
Measured capacitance too high
- change measuring range, verify probe
- A 403
Measured capacitance too low
- verify probe
- A 420
No sensor DAT (EEPROM) available
- exchange sensor
- A 428
Probe insulation break detection
- verify probe
- A 1601
Linearization curve not monotone for level
- re-enter linearization
- A 1604
Calibration faulty
- correct calibration

Warning codes

- W103, W153
Initializing - Please wait
- if the message does not disappear after a few seconds replace the electronics
 - W153
Initializing
- if the message does not disappear after a few seconds replace the electronics
 - W 425
Warning insulation defective
- check insulation
 - W 429
Proof test active
- wait until the proof test is completed
 - W 1601
Linearization curve not monotone for level
- re-enter linearization
 - W 1611
Level linearization points
- enter additional linearization points
 - W 1662
The temperature at electronic insert too high (max. temp. at sensor exceeded)
- lower ambient temperature by suitable measures
 - W 430
Data of probe and electronic insert not compatible
- check probe, perform a total reset
 - W 1671
Linearization table entered incorrectly
- re-adjust table
 - W 1681
Current outside measuring range
- perform basic setup and check linearization
 - W 1683
Current turn down calibration faulty
- repeat calibration
 - W 1801
Level simulation switched on
- switch off level simulation
 - W 1802
Simulation switched on
- switch off simulation
 - W 1806
The current output is in simulation mode
- set the current output to normal mode
 - W 511
The electronic insert has lost calibration data
- contact Endress+Hauser-Service
-  If none of the proposed remedial measures achieves the desired result, perform the reset →  41

8.3 Possible measuring errors

8.3.1 Measured value is incorrect

If the measured values are incorrect, follow this procedure:

1. Verify empty and full calibration.
2. Clean the probe.

3. Verify the probe.
4. Change the installation position. Do not mount probe in a filling curtain.
5. Check ground from process connection to the tank wall. $R < 1 \Omega$.
6. For conductive media, check the probe insulation. $R > 800 \text{ k}\Omega$.
7. Increase output damping, if the surface is turbulent.

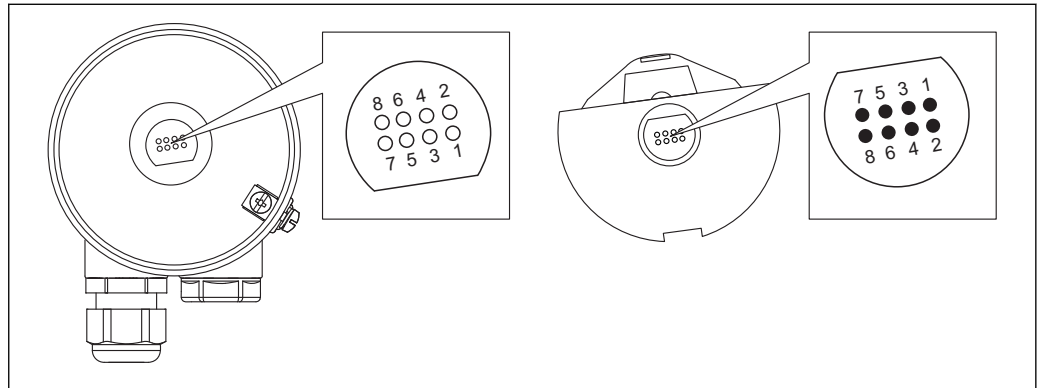

A0040621

17 Electronic insert contacts

- 1 Guard
- 2 SDA_TXD
- 3 GND
- 4 GND EEPROM
- 5 GND
- 6 DVCC 3 V_{DC}
- 7 Probe
- 8 SCL_RXD

8.4 Firmware history

Firmware V 01.00.zz / 08.2005

Updates:

- original-firmware
- operable with FieldCare version 2.08.00 and higher

Firmware V 01.03.zz / 02.2007

Updates:

expansion feature suitable for SIL 2 applications

9 Maintenance

No special maintenance work is required for the Liquicap M level transmitter.

9.1 External cleaning

Do not use a corrosive or aggressive cleaning agent to clean the housing surface and seals.

9.2 Cleaning the probe

Depending on the application, buildup of contamination or soiling can form on the probe rope. A high level of material buildup can affect the measurement result.

The regular cleaning of the probe rope is recommended if the medium tends to create a high level of buildup.

Make sure that the insulation of the probe rope is not damaged if hosing down or during mechanical cleaning.

Make sure that the probe rope insulation is resistant to cleaning agents.

9.3 Seals

The process seals of the sensor must be replaced periodically, especially when using molded aseptic seals!

The intervals between seal replacement depend on the frequency of the cleaning cycles and on the fluid and cleaning temperature.

9.4 Endress+Hauser services

Endress+Hauser offers a wide range of services.



Your Endress+Hauser Sales Center can provide detailed information on the services.

10 Repair

10.1 General notes

The Endress+Hauser repair and conversion concept provides the following:

- The measuring devices have a modular design.
- Spare parts are grouped into logical kits with the associated Installation Instructions.
- Repairs are carried out by Endress+Hauser Service or by appropriately trained customers.
- Certified devices can only be converted to other certified devices by Endress+Hauser Service or at the factory.

10.2 Spare parts

Find spare parts

Check whether it is possible to use the spare part for the measuring device.

1. Launch the Endress+Hauser Device Viewer via a web browser:
www.endress.com/deviceviewer
2. Enter the order code or the product root in the respective field.
 - ↳ Once the order code or the product root has been entered, all the suitable spare parts are listed.
The product status is displayed.
Available drawings of the spare parts are displayed.
3. Locate the order code of the spare part set (on the product label on the package).
 - ↳ **NOTE!**
The order code of the spare part set (on the product label on the package) can differ from the production number (on the label directly on the spare part)!
4. Check whether the order code of the spare part set appears in the list of the spare parts displayed:
 - ↳ **YES:** The spare part set may be used for the measuring device.
NO: The spare part set may not be used for the measuring device.
If you have any questions please contact your Endress+Hauser Service organization.
5. On the **Spare parts** tab click the PDF symbol in the **MH** column.
 - ↳ The Installation Instructions attached to the listed spare part are opened as a PDF file and can also be saved as a PDF file.
6. Click one of the drawings shown on the **Spare part drawings** tab.
 - ↳ The corresponding exploded drawing is opened as a PDF file and can also be saved as a PDF file.

10.3 Repairing Ex-certified devices

If repairing Ex-certified devices remember that:

- Ex-certified devices may only be repaired by experienced and skilled staff or by Endress+Hauser Service
- observe all applicable standards, certificates, national Ex-area regulations and all Safety Instructions (XA)
- use only genuine spare parts from Endress+Hauser
- note the device designation on the nameplate to order the spare parts
- replace the component by the same type
- carry out the replacing in accordance with the instructions

- carry out the individual test for the device
- change the device only with a device certificated by Endress+Hauser
- report every change and repair of the device

10.4 Replacement

After replacing a Liquicap M or the electronic insert, the calibration values must be transferred to the replacement device.

Options:

- if the probe is replaced, the calibration values in the electronic insert can be transferred to the sensor DAT (EEPROM) module via a manual download
- if the electronic insert is replaced, the calibration values of the sensor DAT (EEPROM) module can be transferred to the electronics via a manual upload

It is possible to restart the device without having to carry out a new calibration →  61.

10.5 Return

The requirements for safe device return can vary depending on the device type and national legislation.

1. Refer to the website for more information:
<http://www.endress.com/support/return-material>
2. Return the device if repairs or a factory calibration are required, or if the wrong device was ordered or delivered.

10.6 Disposal

10.6.1 Removing the measuring device

1. Switch off the device.

WARNING

Danger to personnel from process conditions.

- ▶ Beware of hazardous process conditions such as pressure in the measuring device, high temperatures or aggressive fluids.

2. Carry out the mounting and connection steps from the "Mounting the measuring device" and "Connecting the measuring device" sections in reverse order. Observe the safety instructions.

10.6.2 Disposing of the measuring device

WARNING

Danger to personnel and environment from fluids that are hazardous to health.

- ▶ Ensure that the measuring device and all cavities are free of fluid residues that are hazardous to health or the environment, e.g. substances that have permeated into crevices or diffused through plastic.

Observe the following notes during disposal:

- ▶ Observe valid federal/national regulations.
- ▶ Ensure proper separation and reuse of the device components.

11 Accessories

11.1 Protective cover

Protective cover for F13, F17 and F27 housing
order number: 71040497

Protective cover for F16 housing
order number: 71127760

11.2 Commubox FXA195 HART

For intrinsically safe HART communication with FieldCare via the RS232C interface or USB.

11.3 HAW56x surge arrester

Surge arrester for limiting overvoltage in signal lines and components is described in Brief Operating Instructions: KA00130R.

11.4 Weld-in adapter

All available weld-in adapters are described in the document TI00426F.

The documentation is available in the Download section on Endress+Hauser web site:
www.endress.com

12 Technical data

12.1 Probe

12.1.1 Capacitance values of the probe

The basic capacitance of the probe is approximately 18 pF.

12.1.2 Additional capacitance

Mount the probe at a minimum distance of 50 mm (1.97 in) from a conductive container wall:

approximately 1.0 pF/100 mm (3.94 in) in the air for a rope probe

Fully insulated probe rope in water:

approximately 19 pF/100 mm (3.94 in)

12.1.3 Probe lengths for continuous measurement in conductive liquids

The maximum length of the rope probe is:

- < 6 m (20 ft) for capacitive range 0 to 2 000 pF.
- > 6 m (20 ft) for capacitive range 0 to 4 000 pF.

12.2 Performance characteristics

12.2.1 Reference operating conditions

Room temperature:

+20 °C (+68 °F) ±5 °C (±8 °F)

Span:

- standard measuring range
5 to 2 000 pF
- extended measuring range
5 to 4 000 pF
- span for reference - corresponds to approximately 1 m (3.3 ft) probe length
5 to 4 000 pF

12.2.2 Maximum measured error

Non-repeatability (reproducibility) as per DIN 61298-2:
maximum ±0.1 %

Non-linearity for limit point setting (linearity) as per DIN 61298-2:
maximum ±0.5 %

12.2.3 Influence of ambient temperature

Electronic insert

< 0.06 %/10 K related to the full-scale value

Separate housing

change in capacitance of connecting cable 0.015 pF / m per K

12.2.4 Switch-on behavior

14 s, the stable measured value after the switch-on procedure, a start-up in safe status
22 mA

12.2.5 Measured value reaction time

Operating mode: $t_1 \leq 0.3$ s

SIL operating mode: $t_1 \leq 0.5$ s

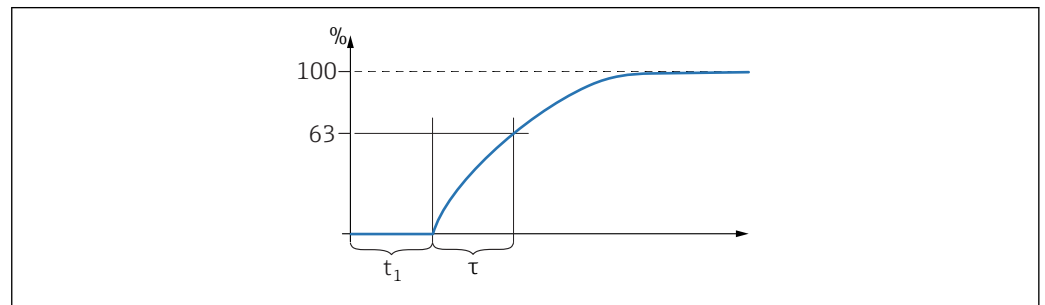

τ Output damping

t_1 Deadtime

12.2.6 Output damping

The output damping affects the speed at which the display and the current output react to changes in the level.

The factory setting for output damping $\tau = 1$ s 0 to 60 s can be set.

12.2.7 Accuracy of factory calibration

Empty calibration (0 %) and full calibration (100 %):

- probe length < 2 m (6.6 ft)
≤ 5 mm (0.2 in)
- probe length > 2 m (6.6 ft)
approximately ≤ 2 %

Reference conditions for the factory calibration:

- medium conductivity ≥ 100 $\mu\text{S}/\text{cm}$
- minimum distance to tank wall = 250 mm (9.84 in)

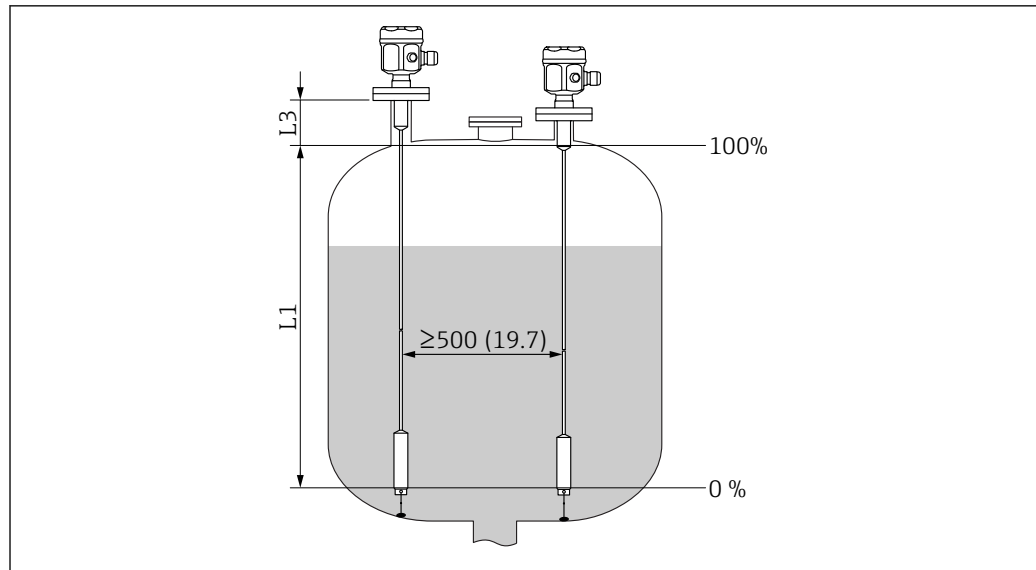

Unit of measurement mm (in)

L1 Measuring range from the tip of the probe to the process connection

L3 The inactive length



In an installed state, recalibration is only necessary when:

- the 0 % or the 100 % values have to be adjusted specifically for the customer
- the liquid is not conductive
- the probe distance to the tank wall is < 250 mm (9.84 in)

12.2.8 Resolution

Analog in % (4 to 20 mA)

- 11 bit/ 2 048 steps, 8 μ A
- the resolution of the electronics can be directly converted to units of length of the probe
e.g. rope probe length is 1 000 mm, resolution equals 1 000 mm/2048 = 0.48 mm

12.3 Input

12.3.1 Measured variable

Continuous measurement of change in capacitance between the probe rope and container wall, depending on the level of a liquid.

The probe covered -> high capacitance.

The probe not covered -> low capacitance.

12.3.2 Measuring range

- measuring frequency:
500 kHz
- span ΔC
 - recommended: 25 to 4 000 pF
 - possible: 2 to 4 000 pF
- final capacitance C_E :
max. 4 000 pF
- adjustable initial capacitance C_A :
 - < 6 m (20 ft) 0 to 2 000 pF
 - > 6 m (20 ft) 0 to 4 000 pF

12.4 Output

12.4.1 Output signal

FEI50H (4 to 20 mA / HART version 5)

3.8 to 20.5 mA with HART protocol

12.4.2 Signal on alarm

FEI50H (4 to 20 mA / HART version 5)

Fault diagnosis can be called up via:

- red LED on the local display
- error symbol on the local display
- plain text on the display
- current output 22 mA
- digital interface: HART status error message

12.4.3 Linearization

FEI50H (4 to 20 mA / HART version 5)

The Liquicap M linearization function enables conversion of the measured value into any desired length or volume units. Linearization tables for volume calculation of horizontal cylindrical tanks and spherical tanks are pre-programmed. Any other tables with up to 32 value pairs can be input manually or semi-automatically.

12.5 Operating conditions: Environment

12.5.1 Ambient temperature range

- F16 housing: -40 to +70 °C (-40 to +158 °F)
- remaining housing: -50 to +70 °C (-58 to +158 °F)
- observe derating
- use a protective cover, when operating outdoors

12.5.2 Climate class

DIN EN 60068-2-38/IEC 68-2-38: Z/AD check

12.5.3 Vibration resistance

DIN EN 60068-2-64/IEC 68-2-64: 20 to 2 000 Hz, 0.01 g²/Hz

12.5.4 Shock resistance

DIN EN 60068-2-27/IEC 68-2-27: 30g acceleration

12.5.5 Degree of protection

-  All protection degree regarding EN60529.
NEMA4X protection degree regarding NEMA250.

Polyester housing F16

Protection degree:

- IP66
- IP67
- NEMA 4X

Stainless steel housing F15

Protection degree:

- IP66
- IP67
- NEMA 4X

Aluminum housing F17

Protection degree:

- IP66
- IP67
- NEMA 4X

Aluminum housing F13 with gas-tight process seal

Protection degree:

- IP66
- IP68 ²¹⁾
- NEMA 4X

Stainless steel housing F27 with gas-tight process seal

Protection degree:

- IP66
- IP67
- IP68 ²¹⁾
- NEMA 4X

21) Only with M20 cable entry or G½ thread.

Aluminum housing T13 with gas-tight process seal and separate connection compartment (Ex d)

Protection degree:

- IP66
- IP68 ²¹⁾
- NEMA 4X

Separate housing

Protection degree:

- IP66
- IP68 ²¹⁾
- NEMA 4X

12.6 Operating conditions: Process

12.6.1 Process temperature range

The following diagrams apply for:

- insulation
 - PTFE
 - PFA
 - FEP
- standard applications outside hazardous areas

i The temperature is restricted to $T_a -40\text{ °C}$ (-40 °F) when the polyester housing F16 is used or if additional option B is selected: free from paint-wetting impairment substances, only FMI51.

Probe with compact housing

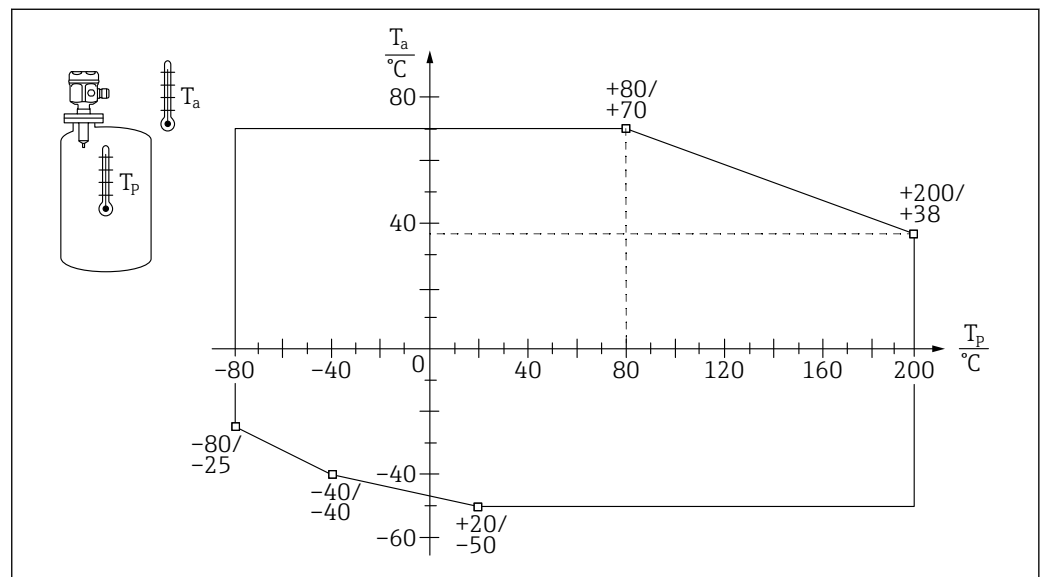

T_a Ambient temperature

T_p Process temperature

Probe with separate housing

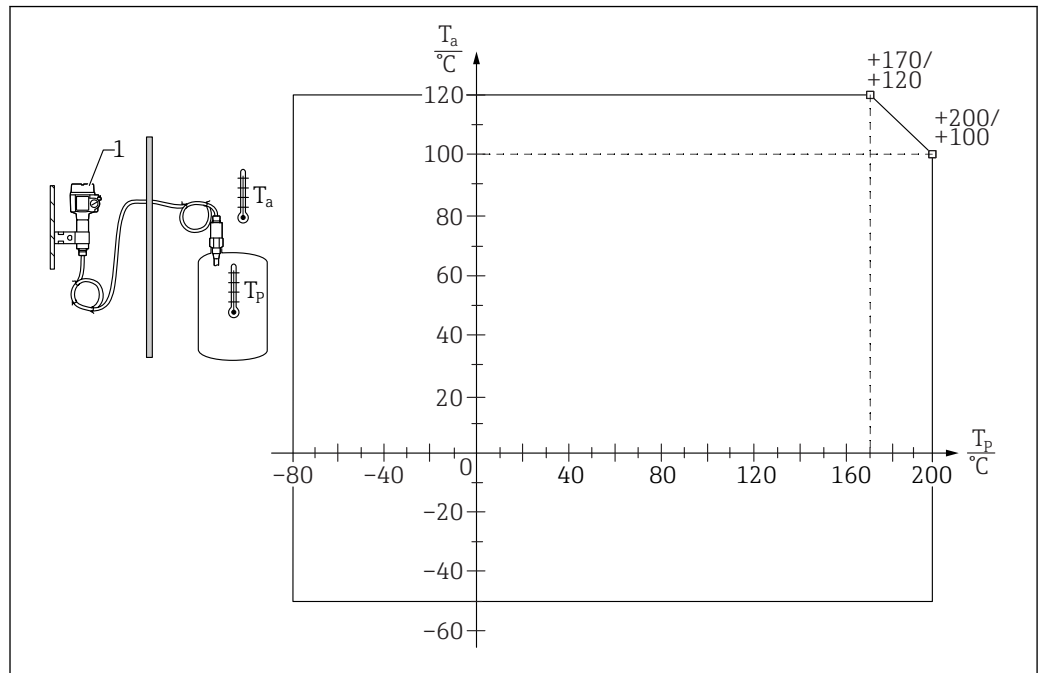

A0040624

T_a Ambient temperature

T_p Process temperature

1 The permitted ambient temperature at the separate housing is the same as indicated for the compact housing.

Influence of process temperature

Error in case of fully insulated probes typically 0.13 %/K related to the full-scale value.

12.6.2 Process pressure limits

Probe Ø10 mm (0.39 in) including insulation

-1 to 25 bar (-14.5 to 362.5 psi)

Probe Ø16 mm (0.63 in) including insulation

- -1 to 100 bar (-14.5 to 1450 psi)
- in regards to an inactive length, the maximum permitted process pressure is 63 bar (913.5 psi)
- for CRN approval and inactive length: the maximum permitted process pressure is 32 bar (464 psi)

Probe Ø22 mm (0.87 in) including insulation

-1 to 50 bar (-14.5 to 725 psi)

Refer to the following standards for the pressure values permitted at higher temperatures:

- EN 1092-1: 2005 Table, Appendix G2
With regard to its resistance and temperature property, the material 1.4435 is identical to 1.4404 (AISI 316L) which is grouped under 13E0 in EN 1092-1 Tab. 18. The chemical composition of the two materials can be identical.
- ASME B 16.5a - 1998 Tab. 2-2.2 F316
- ASME B 16.5a - 1998 Tab. 2.3.8 N10276
- JIS B 2220

The lowest value from the derating curves of the device and the selected flange applies.

12.6.3 Pressure and temperature derating

For process connections 1/2", 3/4", 1", flanges <DN50, <ANSI 2", <JIS 10K and process connections 3/4", 1", flanges <DN50, <ANSI 2", <JIS 10K

Rope insulation: PTFE, PFA

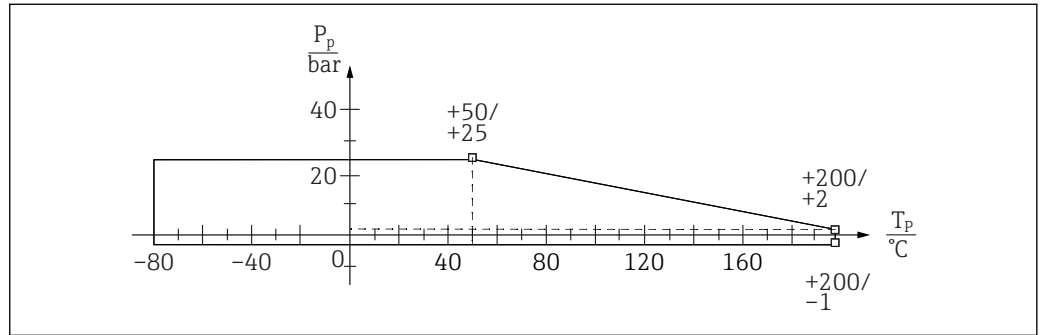

P_p Process pressure
 T_p Process temperature

For process connections 1 1/2", flanges <DN50, <ANSI 2", <JIS 10K

Rope insulation: PTFE, PFA

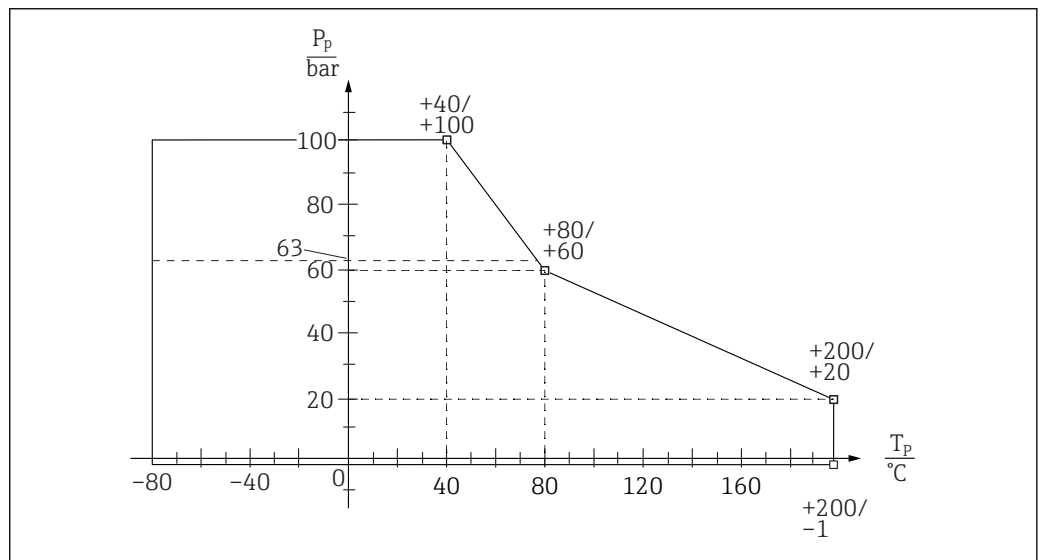

P_p Process pressure
 T_p Process temperature
 63 Process pressure for probes with an inactive length

With a fully insulated inactive length

Rope insulation: PTFE, PFA

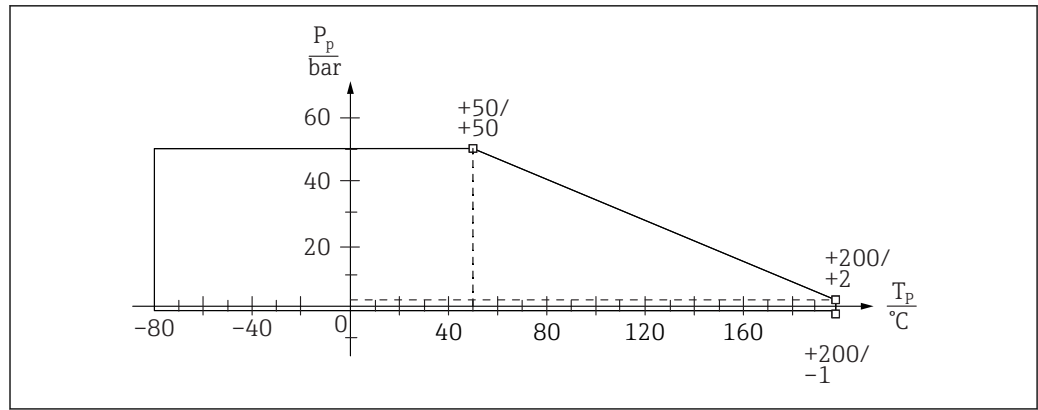

A0040627

P_p Process pressure
 T_p Process temperature



71473464

www.addresses.endress.com
