

Operating Instructions Proline Promag W 300 HART

Electromagnetic flowmeter

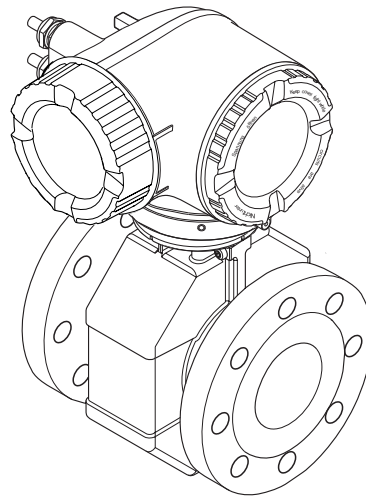

- Make sure the document is stored in a safe place such that it is always available when working on or with the device.
- To avoid danger to individuals or the facility, read the "Basic safety instructions" section carefully, as well as all other safety instructions in the document that are specific to working procedures.
- The manufacturer reserves the right to modify technical data without prior notice. Your Endress+Hauser Sales Center will supply you with current information and updates to these instructions.

Table of contents

1	About this document	6	6	Installation	21
1.1	Document function	6	6.1	Installation conditions	21
1.2	Symbols	6	6.1.1	Mounting position	21
1.2.1	Safety symbols	6	6.1.2	Environment and process requirements	23
1.2.2	Electrical symbols	6	6.1.3	Special mounting instructions	26
1.2.3	Communication symbols	6	6.2	Mounting the measuring device	26
1.2.4	Tool symbols	7	6.2.1	Required tools	26
1.2.5	Symbols for certain types of information	7	6.2.2	Preparing the measuring device	26
1.2.6	Symbols in graphics	7	6.2.3	Mounting the sensor	26
1.3	Documentation	8	6.2.4	Turning the transmitter housing	33
1.3.1	Standard documentation	8	6.2.5	Turning the display module	34
1.3.2	Supplementary device-dependent documentation	8	6.3	Post-installation check	35
1.4	Registered trademarks	8	7	Electrical connection	36
2	Safety instructions	9	7.1	Connection conditions	36
2.1	Requirements for the personnel	9	7.1.1	Required tools	36
2.2	Designated use	9	7.1.2	Requirements for connecting cable	36
2.3	Workplace safety	10	7.1.3	Terminal assignment	39
2.4	Operational safety	10	7.1.4	Preparing the measuring device	39
2.5	Product safety	10	7.2	Connecting the measuring device	39
2.6	IT security	11	7.2.1	Connecting the transmitter	39
2.7	Device-specific IT security	11	7.2.2	Connecting the remote display and operating module DKX001	42
2.7.1	Protecting access via hardware write protection	11	7.3	Ensuring potential equalization	42
2.7.2	Protecting access via a password	11	7.3.1	Requirements	42
2.7.3	Access via Web server	12	7.3.2	Connection example, standard scenario	42
2.7.4	Access via OPC-UA	13	7.3.3	Connection example in special situations	43
2.7.5	Access via service interface (CDI-RJ45)	13	7.4	Special connection instructions	44
3	Product description	14	7.4.1	Connection examples	44
3.1	Product design	14	7.5	Ensuring the degree of protection	48
4	Incoming acceptance and product identification	15	7.6	Post-connection check	49
4.1	Incoming acceptance	15	8	Operation options	50
4.2	Product identification	15	8.1	Overview of operation options	50
4.2.1	Transmitter nameplate	16	8.2	Structure and function of the operating menu	51
4.2.2	Sensor nameplate	17	8.2.1	Structure of the operating menu	51
4.2.3	Symbols on measuring device	18	8.2.2	Operating philosophy	52
5	Storage and transport	19	8.3	Access to the operating menu via the local display	53
5.1	Storage conditions	19	8.3.1	Operational display	53
5.2	Transporting the product	19	8.3.2	Navigation view	54
5.2.1	Measuring devices without lifting lugs	19	8.3.3	Editing view	56
5.2.2	Measuring devices with lifting lugs	20	8.3.4	Operating elements	58
5.2.3	Transporting with a fork lift	20	8.3.5	Opening the context menu	58
5.3	Packaging disposal	20	8.3.6	Navigating and selecting from list	60
			8.3.7	Calling the parameter directly	60
			8.3.8	Calling up help text	61
			8.3.9	Changing the parameters	61
			8.3.10	User roles and related access authorization	62

8.3.11	Disabling write protection via access code	62	10.5.7	Configuration management	113
8.3.12	Enabling and disabling the keypad lock	63	10.5.8	Using parameters for device administration	115
8.4	Access to the operating menu via the Web browser	63	10.6	Simulation	116
8.4.1	Function range	63	10.7	Protecting settings from unauthorized access	119
8.4.2	Prerequisites	64	10.7.1	Write protection via access code ...	119
8.4.3	Establishing a connection	65	10.7.2	Write protection via write protection switch	121
8.4.4	Logging on	67	11	Operation	122
8.4.5	User interface	68	11.1	Reading the device locking status	122
8.4.6	Disabling the Web server	69	11.2	Adjusting the operating language	122
8.4.7	Logging out	69	11.3	Configuring the display	122
8.5	Access to the operating menu via the operating tool	70	11.4	Reading measured values	122
8.5.1	Connecting the operating tool	70	11.4.1	"Process variables" submenu	122
8.5.2	Field Xpert SFX350, SFX370	73	11.4.2	"Totalizer" submenu	123
8.5.3	FieldCare	73	11.4.3	"Input values" submenu	124
8.5.4	DeviceCare	75	11.4.4	Output values	125
8.5.5	AMS Device Manager	75	11.5	Adapting the measuring device to the process conditions	127
8.5.6	SIMATIC PDM	76	11.6	Performing a totalizer reset	127
8.5.7	Field Communicator 475	76	11.6.1	Function scope of the "Control Totalizer" parameter	128
9	System integration	77	11.6.2	Function scope of the "Reset all totalizers" parameter	128
9.1	Overview of device description files	77	11.7	Showing data logging	128
9.1.1	Current version data for the device ...	77	12	Diagnostics and troubleshooting ..	132
9.1.2	Operating tools	77	12.1	General troubleshooting	132
9.2	Measured variables via HART protocol	77	12.2	Diagnostic information via light emitting diodes	134
9.3	Other settings	79	12.2.1	Transmitter	134
10	Commissioning	81	12.3	Diagnostic information on local display	136
10.1	Function check	81	12.3.1	Diagnostic message	136
10.2	Switching on the measuring device	81	12.3.2	Calling up remedial measures	138
10.3	Setting the operating language	81	12.4	Diagnostic information in the Web browser .	138
10.4	Configuring the measuring device	81	12.4.1	Diagnostic options	138
10.4.1	Defining the tag name	83	12.4.2	Calling up remedy information	139
10.4.2	Setting the system units	83	12.5	Diagnostic information in FieldCare or DeviceCare	140
10.4.3	Displaying the I/O configuration ...	84	12.5.1	Diagnostic options	140
10.4.4	Configuring the status input	85	12.5.2	Calling up remedy information	141
10.4.5	Configuring the current input	86	12.6	Adapting the diagnostic information	141
10.4.6	Configuring the current output	87	12.6.1	Adapting the diagnostic behavior ...	141
10.4.7	Configuring the pulse/frequency/switch output	90	12.6.2	Adapting the status signal	141
10.4.8	Configuring the local display	96	12.7	Overview of diagnostic information	142
10.4.9	Configuring the low flow cut off	97	12.8	Pending diagnostic events	146
10.4.10	Configuring empty pipe detection ...	99	12.9	Diagnostic list	147
10.4.11	Configuring the HART input	99	12.10	Event logbook	147
10.4.12	Configuring the relay output	101	12.10.1	Reading out the event logbook	147
10.4.13	Configuring the double pulse output	103	12.10.2	Filtering the event logbook	148
10.5	Advanced settings	105	12.10.3	Overview of information events ...	148
10.5.1	Using the parameter to enter the access code	106	12.11	Resetting the measuring device	150
10.5.2	Carrying out a sensor adjustment ...	106	12.11.1	Function scope of the "Device reset" parameter	150
10.5.3	Configuring the totalizer	106	12.12	Device information	150
10.5.4	Carrying out additional display configurations	108	12.13	Firmware history	153
10.5.5	Performing electrode cleaning	111			
10.5.6	WLAN configuration	112			

12.14	Device history and compatibility	154
13	Maintenance	155
13.1	Maintenance tasks	155
13.1.1	Exterior cleaning	155
13.1.2	Interior cleaning	155
13.1.3	Replacing seals	155
13.2	Measuring and test equipment	155
13.3	Endress+Hauser services	155
14	Repair	156
14.1	General notes	156
14.1.1	Repair and conversion concept	156
14.1.2	Notes for repair and conversion	156
14.2	Spare parts	156
14.3	Endress+Hauser services	156
14.4	Return	156
14.5	Disposal	156
14.5.1	Removing the measuring device	156
14.5.2	Disposing of the measuring device	157
15	Accessories	158
15.1	Device-specific accessories	158
15.1.1	For the transmitter	158
15.1.2	For the sensor	159
15.2	Communication-specific accessories	159
15.3	Service-specific accessories	160
15.4	System components	160
16	Technical data	161
16.1	Application	161
16.2	Function and system design	161
16.3	Input	161
16.4	Output	167
16.5	Power supply	173
16.6	Performance characteristics	174
16.7	Installation	176
16.8	Environment	176
16.9	Process	177
16.10	Mechanical construction	179
16.11	Human interface	188
16.12	Certificates and approvals	192
16.13	Application packages	193
16.14	Accessories	194
16.15	Supplementary documentation	194
Index		197

1 About this document

1.1 Document function

These Operating Instructions contain all the information that is required in various phases of the life cycle of the device: from product identification, incoming acceptance and storage, to mounting, connection, operation and commissioning through to troubleshooting, maintenance and disposal.

1.2 Symbols

1.2.1 Safety symbols

DANGER

This symbol alerts you to a dangerous situation. Failure to avoid this situation will result in serious or fatal injury.

WARNING

This symbol alerts you to a dangerous situation. Failure to avoid this situation can result in serious or fatal injury.





CAUTION

This symbol alerts you to a dangerous situation. Failure to avoid this situation can result in minor or medium injury.



NOTICE



This symbol contains information on procedures and other facts which do not result in personal injury.

1.2.2 Electrical symbols



Symbol	Meaning
	Direct current
	Alternating current
	Direct current and alternating current
	Ground connection A grounded terminal which, as far as the operator is concerned, is grounded via a grounding system.
	Protective Earth (PE) A terminal which must be connected to ground prior to establishing any other connections. The ground terminals are situated inside and outside the device: <ul style="list-style-type: none"> ▪ Inner ground terminal: Connects the protective earth to the mains supply. ▪ Outer ground terminal: Connects the device to the plant grounding system.

1.2.3 Communication symbols













Symbol	Meaning
	Wireless Local Area Network (WLAN) Communication via a wireless, local network.
	LED Light emitting diode is off.

Symbol	Meaning
	LED Light emitting diode is on.
	LED Light emitting diode is flashing.



1.2.4 Tool symbols



Symbol	Meaning
	Flat blade screwdriver
	Allen key
	Open-ended wrench

1.2.5 Symbols for certain types of information

Symbol	Meaning
	Permitted Procedures, processes or actions that are permitted.
	Preferred Procedures, processes or actions that are preferred.
	Forbidden Procedures, processes or actions that are forbidden.
	Tip Indicates additional information.
	Reference to documentation.
	Reference to page.
	Reference to graphic.
	Notice or individual step to be observed.
	Series of steps.
	Result of a step.
	Help in the event of a problem.
	Visual inspection.

1.2.6 Symbols in graphics



Symbol	Meaning
1, 2, 3, ...	Item numbers
	Series of steps
A, B, C, ...	Views
A-A, B-B, C-C, ...	Sections
	Hazardous area

Symbol	Meaning
	Safe area (non-hazardous area)
	Flow direction

1.3 Documentation

 For an overview of the scope of the associated Technical Documentation, refer to the following:

- *W@M Device Viewer* (www.endress.com/deviceviewer): Enter the serial number from nameplate
- *Endress+Hauser Operations App*: Enter the serial number from the nameplate or scan the 2D matrix code (QR code) on the nameplate

 Detailed list of the individual documents along with the documentation code
→  194

1.3.1 Standard documentation

Document type	Purpose and content of the document
Technical Information	Planning aid for your device The document contains all the technical data on the device and provides an overview of the accessories and other products that can be ordered for the device.
Sensor Brief Operating Instructions	Guides you quickly to the 1st measured value - Part 1 The Sensor Brief Operating Instructions are aimed at specialists with responsibility for installing the measuring device. <ul style="list-style-type: none"> ▪ Incoming acceptance and product identification ▪ Storage and transport ▪ Installation
Transmitter Brief Operating Instructions	Guides you quickly to the 1st measured value - Part 2 The Transmitter Brief Operating Instructions are aimed at specialists with responsibility for commissioning, configuring and parameterizing the measuring device (until the first measured value). <ul style="list-style-type: none"> ▪ Product description ▪ Installation ▪ Electrical connection ▪ Operation options ▪ System integration ▪ Commissioning ▪ Diagnostic information
Description of Device Parameters	Reference for your parameters The document provides a detailed explanation of each individual parameter in the Expert operating menu. The description is aimed at those who work with the device over the entire life cycle and perform specific configurations.

1.3.2 Supplementary device-dependent documentation

Additional documents are supplied depending on the device version ordered: Always comply strictly with the instructions in the supplementary documentation. The supplementary documentation is an integral part of the device documentation.

1.4 Registered trademarks

HART®

Registered trademark of the FieldComm Group, Austin, Texas, USA

2 Safety instructions

2.1 Requirements for the personnel

The personnel for installation, commissioning, diagnostics and maintenance must fulfill the following requirements:

- ▶ Trained, qualified specialists must have a relevant qualification for this specific function and task.
- ▶ Are authorized by the plant owner/operator.
- ▶ Are familiar with federal/national regulations.
- ▶ Before starting work, read and understand the instructions in the manual and supplementary documentation as well as the certificates (depending on the application).
- ▶ Follow instructions and comply with basic conditions.

The operating personnel must fulfill the following requirements:

- ▶ Are instructed and authorized according to the requirements of the task by the facility's owner-operator.
- ▶ Follow the instructions in this manual.

2.2 Designated use

Application and media

The measuring device described in these Brief Operating Instructions is intended only for flow measurement of liquids with a minimum conductivity of 5 $\mu\text{S}/\text{cm}$.

Depending on the version ordered, the measuring device can also measure potentially explosive, flammable, poisonous and oxidizing media.

Measuring devices for use in hazardous areas, in hygienic applications or where there is an increased risk due to process pressure, are labeled accordingly on the nameplate.

To ensure that the measuring device remains in proper condition for the operation time:

- ▶ Keep within the specified pressure and temperature range.
- ▶ Only use the measuring device in full compliance with the data on the nameplate and the general conditions listed in the Operating Instructions and supplementary documentation.
- ▶ Based on the nameplate, check whether the ordered device is permitted for the intended use in the hazardous area (e.g. explosion protection, pressure vessel safety).
- ▶ Use the measuring device only for media to which the process-wetted materials are sufficiently resistant.
- ▶ If the ambient temperature of the measuring device is outside the atmospheric temperature, it is absolutely essential to comply with the relevant basic conditions as specified in the device documentation. →  8
- ▶ Protect the measuring device permanently against corrosion from environmental influences.

Incorrect use

Non-designated use can compromise safety. The manufacturer is not liable for damage caused by improper or non-designated use.

WARNING

Danger of breakage due to corrosive or abrasive fluids and ambient conditions!

- ▶ Verify the compatibility of the process fluid with the sensor material.
- ▶ Ensure the resistance of all fluid-wetted materials in the process.
- ▶ Keep within the specified pressure and temperature range.

NOTICE**Verification for borderline cases:**

- ▶ For special fluids and fluids for cleaning, Endress+Hauser is glad to provide assistance in verifying the corrosion resistance of fluid-wetted materials, but does not accept any warranty or liability as minute changes in the temperature, concentration or level of contamination in the process can alter the corrosion resistance properties.

Residual risks**⚠ WARNING**

The electronics and the medium may cause the surfaces to heat up. This presents a burn hazard!

- ▶ For elevated fluid temperatures, ensure protection against contact to prevent burns.

2.3 Workplace safety

For work on and with the device:

- ▶ Wear the required personal protective equipment according to federal/national regulations.

For welding work on the piping:

- ▶ Do not ground the welding unit via the measuring device.

If working on and with the device with wet hands:

- ▶ Due to the increased risk of electric shock, gloves must be worn.

2.4 Operational safety

Risk of injury.

- ▶ Operate the device in proper technical condition and fail-safe condition only.
- ▶ The operator is responsible for interference-free operation of the device.

Conversions to the device

Unauthorized modifications to the device are not permitted and can lead to unforeseeable dangers.

- ▶ If, despite this, modifications are required, consult with Endress+Hauser.

Repair

To ensure continued operational safety and reliability,

- ▶ Carry out repairs on the device only if they are expressly permitted.
- ▶ Observe federal/national regulations pertaining to repair of an electrical device.
- ▶ Use original spare parts and accessories from Endress+Hauser only.

2.5 Product safety

This measuring device is designed in accordance with good engineering practice to meet state-of-the-art safety requirements, has been tested, and left the factory in a condition in which it is safe to operate.

It meets general safety standards and legal requirements. It also complies with the EU directives listed in the device-specific EU Declaration of Conformity. Endress+Hauser confirms this by affixing the CE mark to the device.





2.6 IT security

Our warranty is valid only if the device is installed and used as described in the Operating Instructions. The device is equipped with security mechanisms to protect it against any inadvertent changes to the settings.

IT security measures, which provide additional protection for the device and associated data transfer, must be implemented by the operators themselves in line with their security standards.

2.7 Device-specific IT security

The device offers a range of specific functions to support protective measures on the operator's side. These functions can be configured by the user and guarantee greater in-operation safety if used correctly. An overview of the most important functions is provided in the following section.

Function/interface	Factory setting	Recommendation
Write protection via hardware write protection switch →  11	Not enabled.	On an individual basis following risk assessment.
Access code (also applies for Web server login or FieldCare connection) →  12	Not enabled (0000).	Assign a customized access code during commissioning.
WLAN (order option in display module)	Enabled.	On an individual basis following risk assessment.
WLAN security mode	Enabled (WPA2-PSK)	Do not change.
WLAN passphrase (password) →  12	Serial number	Assign an individual WLAN passphrase during commissioning.
WLAN mode	Access Point	On an individual basis following risk assessment.
Web server →  12	Enabled.	On an individual basis following risk assessment.
CDI-RJ45 service interface →  13	–	On an individual basis following risk assessment.

2.7.1 Protecting access via hardware write protection

Write access to the device parameters via the local display, Web browser or operating tool (e.g. FieldCare, DeviceCare) can be disabled via a write protection switch (DIP switch on the motherboard). When hardware write protection is enabled, only read access to the parameters is possible.

Hardware write protection is disabled when the device is delivered →  121.

2.7.2 Protecting access via a password

Different passwords are available to protect write access to the device parameters or access to the device via the WLAN interface.

- **User-specific access code**
Protect write access to the device parameters via the local display, Web browser or operating tool (e.g. FieldCare, DeviceCare). Access authorization is clearly regulated through the use of a user-specific access code.
- **WLAN passphrase**
The network key protects a connection between an operating unit (e.g. notebook or tablet) and the device via the WLAN interface which can be ordered as an option.
- **Infrastructure mode**
When the device is operated in infrastructure mode, the WLAN passphrase corresponds to the WLAN passphrase configured on the operator side.

User-specific access code

Write access to the device parameters via the local display, Web browser or operating tool (e.g. FieldCare, DeviceCare) can be protected by the modifiable, user-specific access code (→  119).

When the device is delivered, the device does not have an access code and is equivalent to 0000 (open).

WLAN passphrase: Operation as WLAN access point

A connection between an operating unit (e.g. notebook or tablet) and the device via the WLAN interface (→  72), which can be ordered as an optional extra, is protected by the network key. The WLAN authentication of the network key complies with the IEEE 802.11 standard.

When the device is delivered, the network key is pre-defined depending on the device. It can be changed via the **WLAN settings** submenu in the **WLAN passphrase** parameter (→  113).

Infrastructure mode

A connection between the device and WLAN access point is protected by means of an SSID and passphrase on the system side. Please contact the relevant system administrator for access.

General notes on the use of passwords



- The access code and network key supplied with the device should be changed during commissioning.
- Follow the general rules for generating a secure password when defining and managing the access code or network key.
- The user is responsible for the management and careful handling of the access code and network key.
- For information on configuring the access code or on what to do if you lose the password, see the "Write protection via access code" section →  119

2.7.3 Access via Web server

The device can be operated and configured via a Web browser with the integrated Web server (→  63). The connection is via the service interface (CDI-RJ45) or the WLAN interface.

The Web server is enabled when the device is delivered. The Web server can be disabled if necessary (e.g. after commissioning) via the **Web server functionality** parameter.

The device and status information can be hidden on the login page. This prevents unauthorized access to the information.

 For detailed information on device parameters, see:
The "Description of Device Parameters" document →  195.

2.7.4 Access via OPC-UA

The device can communicate with OPC UA clients using the "OPC UA Server" application package.

The OPC UA server integrated in the device can be accessed via the WLAN access point using the WLAN interface - which can be ordered as an optional extra - or the service interface (CDI- RJ45) via Ethernet network. Access rights and authorization as per separate configuration.

The following Security Modes are supported as per the OPC UA Specification (IEC 62541):

- None
- Basic128Rsa15 – signed
- Basic128Rsa15 – signed and encrypted

2.7.5 Access via service interface (CDI-RJ45)

The device can be connected to a network via the service interface (CDI-RJ45). Device-specific functions guarantee the secure operation of the device in a network.

The use of relevant industrial standards and guidelines that have been defined by national and international safety committees, such as IEC/ISA62443 or the IEEE, is recommended. This includes organizational security measures such as the assignment of access authorization as well as technical measures such as network segmentation.



Transmitters with an Ex de approval may not be connected via the service interface (CDI-RJ45)!

Order code for "Approval transmitter + sensor", options (Ex de): BA, BB, C1, C2, GA, GB, MA, MB, NA, NB

3 Product description

The device consists of a transmitter and a sensor.

The device is available as a compact version:

The transmitter and sensor form a mechanical unit.

3.1 Product design

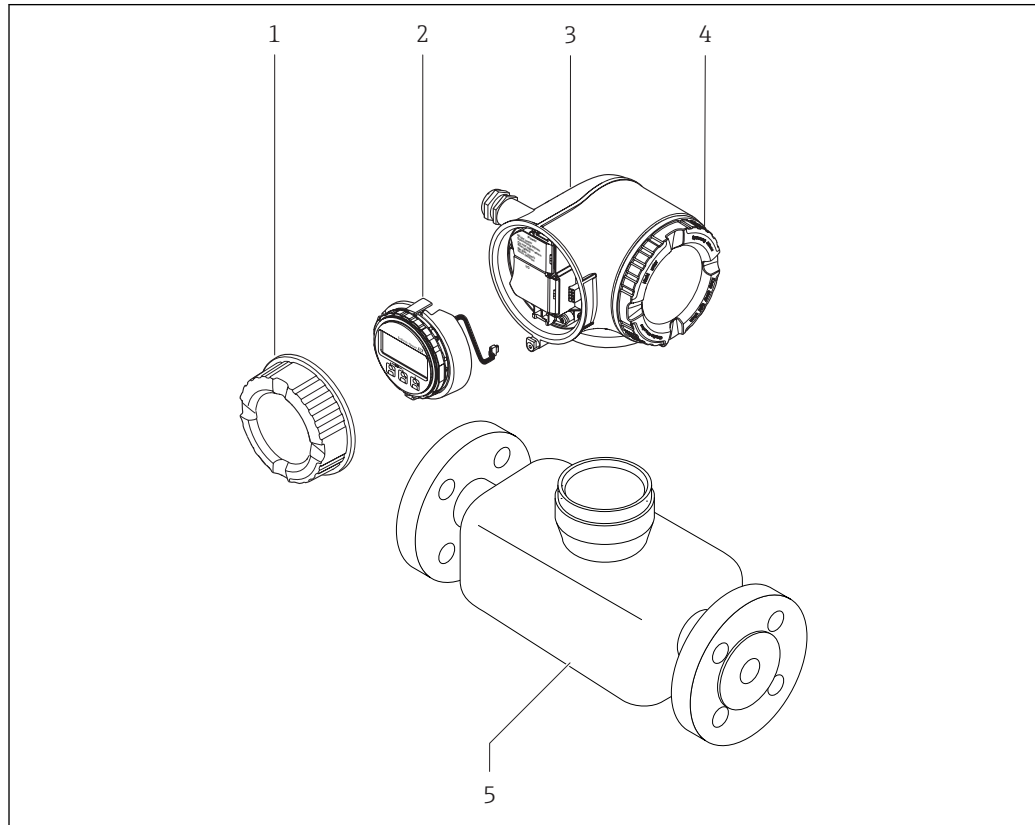

A0029586

☐ 1 *Important components of a measuring device*

- 1 *Connection compartment cover*
- 2 *Display module*
- 3 *Transmitter housing*
- 4 *Electronics compartment cover*
- 5 *Sensor*

4 Incoming acceptance and product identification

4.1 Incoming acceptance

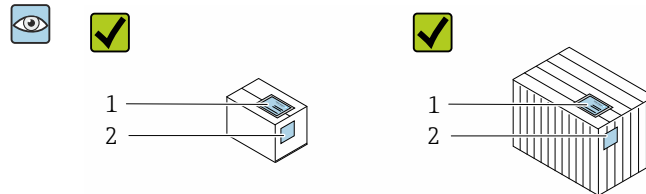

Are the order codes on the delivery note (1) and the product sticker (2) identical?

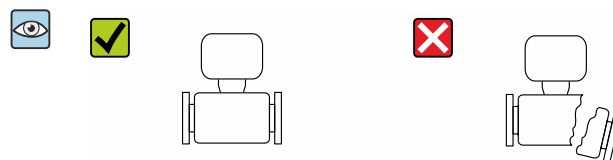
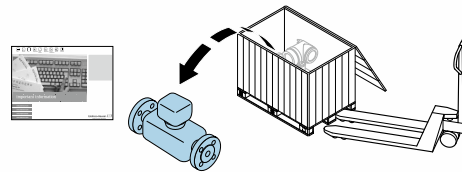

Are the goods undamaged?

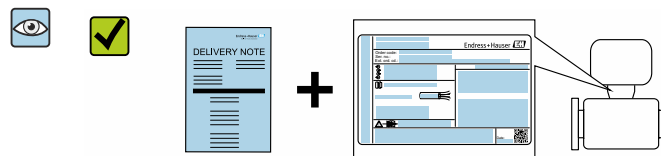

Do the nameplate data match the ordering information on the delivery note?

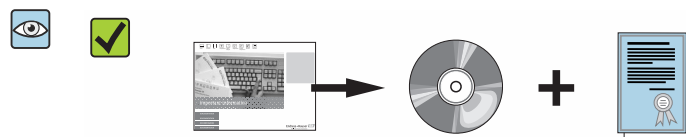

Is the document folder present with accompanying documents?
Is the optional CD-ROM with the Technical Documentation present?

- i** ■ If one of the conditions is not satisfied, contact your Endress+Hauser Sales Center.
- Depending on the device version, the CD-ROM might not be part of the delivery!
The Technical Documentation is available via the Internet or via the *Endress+Hauser Operations App*, see the "Product identification" section → 16.

4.2 Product identification

The following options are available for identification of the device:

- Nameplate specifications
- Order code with breakdown of the device features on the delivery note
- Enter serial numbers from nameplates in the *W@M Device Viewer* (www.endress.com/deviceviewer): All information about the device is displayed.
- Enter the serial number from nameplates in the *Endress+Hauser Operations App* or scan the 2-D matrix code (QR code) on the nameplate using the *Endress+Hauser Operations App*: All information about the device is displayed.

For an overview of the scope of the associated Technical Documentation, refer to the following:

- The "Additional standard documentation on the device" → 8 and "Supplementary device-dependent documentation" → 8 sections
- The *W@M Device Viewer*: enter the serial number from the nameplate (www.endress.com/deviceviewer)
- The *Endress+Hauser Operations App*: Enter the serial number from the nameplate or scan the 2-D matrix code (QR code) on the nameplate.

4.2.1 Transmitter nameplate

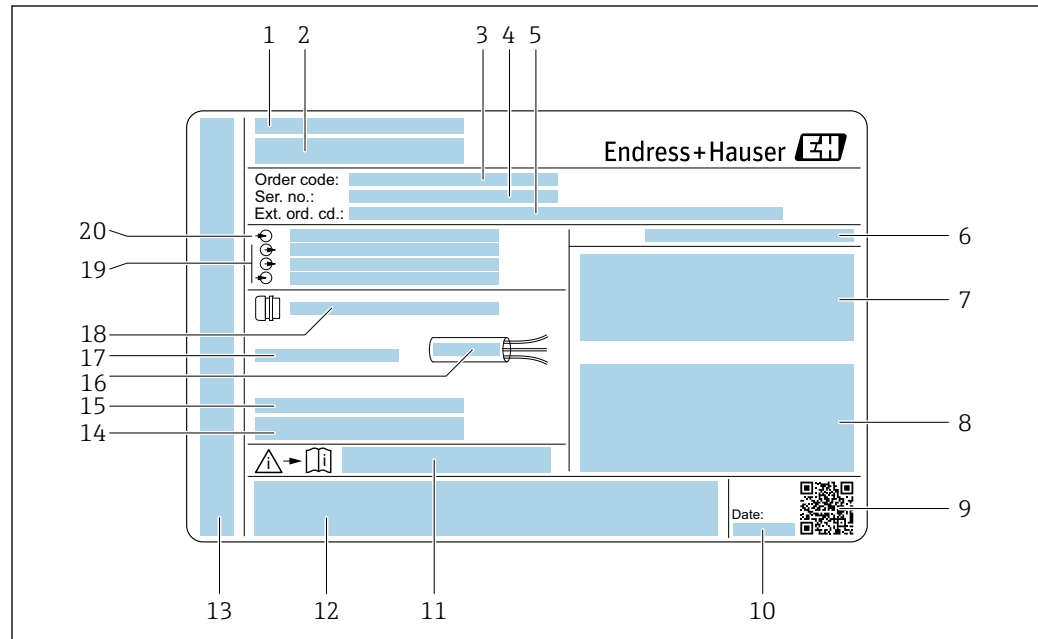

A0029192

2 Example of a transmitter nameplate

- 1 Manufacturing location
- 2 Name of the transmitter
- 3 Order code
- 4 Serial number (ser. no.)
- 5 Extended order code (Ext. ord. cd.)
- 6 Degree of protection
- 7 Space for approvals: use in hazardous areas
- 8 Electrical connection data: available inputs and outputs
- 9 2-D matrix code
- 10 Manufacturing date: year-month
- 11 Document number of safety-related supplementary documentation
- 12 Space for approvals and certificates: e.g. CE mark, C-Tick
- 13 Space for degree of protection of connection and electronics compartment when used in hazardous areas
- 14 Firmware version (FW) and device revision (Dev.Rev.) from the factory
- 15 Space for additional information in the case of special products
- 16 Permitted temperature range for cable
- 17 Permitted ambient temperature (T_a)
- 18 Information on cable gland
- 19 Available inputs and outputs, supply voltage
- 20 Electrical connection data: supply voltage

4.2.2 Sensor nameplate

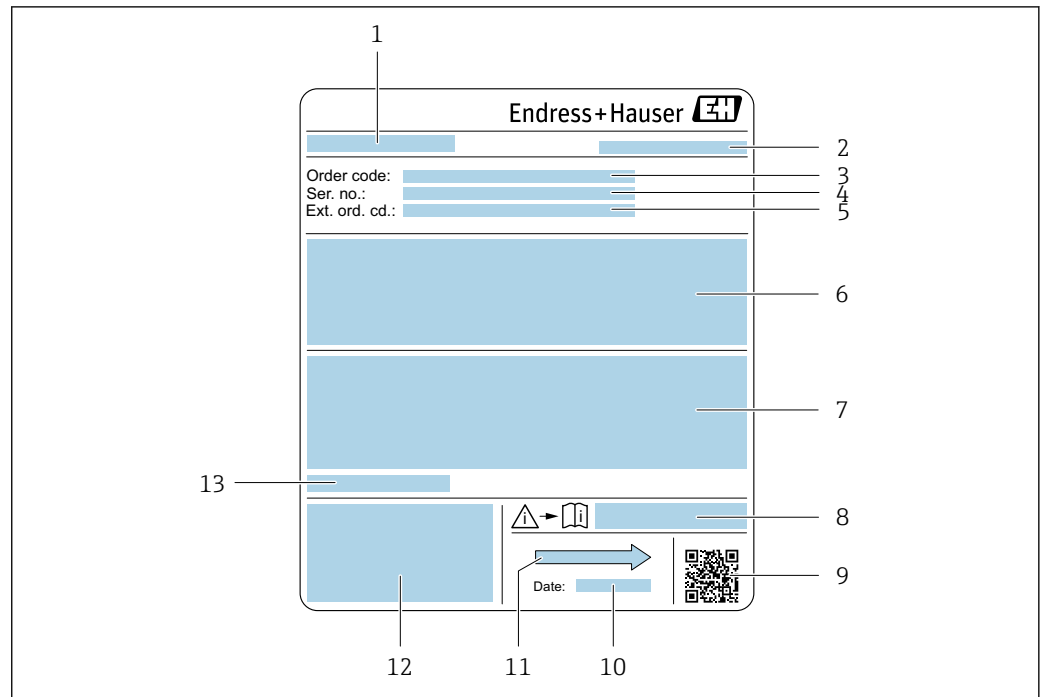

A0029205

 3 Example of sensor nameplate

- 1 Name of the sensor
- 2 Place of manufacture
- 3 Order code
- 4 Serial number (ser. no.)
- 5 Extended order code (Ext. ord. cd.)
- 6 Flow; nominal diameter of the sensor; pressure rating; nominal pressure; system pressure; fluid temperature range; material of liner and electrodes
- 7 Approval information for explosion protection, Pressure Equipment Directive and degree of protection
- 8 Document number of safety-related supplementary documentation
- 9 2-D matrix code
- 10 Manufacturing date: year-month
- 11 Flow direction
- 12 CE mark, C-Tick
- 13 Permitted ambient temperature (T_a)



Order code

The measuring device is reordered using the order code.

Extended order code

- The device type (product root) and basic specifications (mandatory features) are always listed.
- Of the optional specifications (optional features), only the safety and approval-related specifications are listed (e.g. LA). If other optional specifications are also ordered, these are indicated collectively using the # placeholder symbol (e.g. #LA#).
- If the ordered optional specifications do not include any safety and approval-related specifications, they are indicated by the + placeholder symbol (e.g. XXXXXX-ABCDE+).

4.2.3 Symbols on measuring device

Symbol	Meaning
	WARNING! This symbol alerts you to a dangerous situation. Failure to avoid this situation can result in serious or fatal injury.
	Reference to documentation Refers to the corresponding device documentation.
	Protective ground connection A terminal which must be connected to ground prior to establishing any other connections.

5 Storage and transport

5.1 Storage conditions

Observe the following notes for storage:

- ▶ Store in the original packaging to ensure protection from shock.
- ▶ Do not remove protective covers or protective caps installed on process connections. They prevent mechanical damage to the sealing surfaces and contamination in the measuring tube.
- ▶ Protect from direct sunlight to avoid unacceptably high surface temperatures.
- ▶ Select a storage location where moisture cannot collect in the measuring device as fungus and bacteria infestation can damage the lining.
- ▶ Store in a dry and dust-free place.
- ▶ Do not store outdoors.

Storage temperature →  176

5.2 Transporting the product

Transport the measuring device to the measuring point in the original packaging.

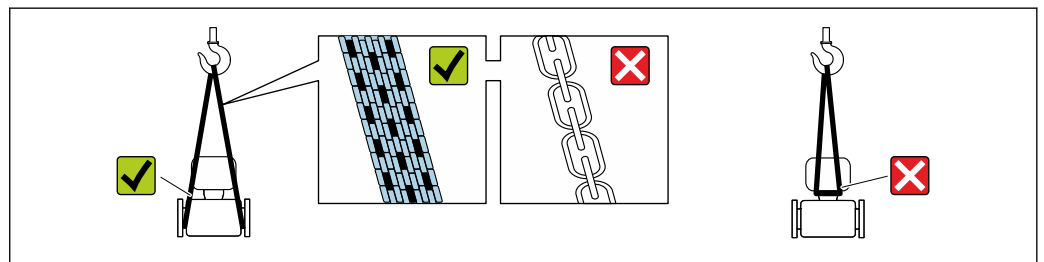

A0029252

-  Do not remove protective covers or caps installed on process connections. They prevent mechanical damage to the sealing surfaces and contamination in the measuring tube.

5.2.1 Measuring devices without lifting lugs

WARNING

Center of gravity of the measuring device is higher than the suspension points of the webbing slings.

Risk of injury if the measuring device slips.

- ▶ Secure the measuring device against slipping or turning.
- ▶ Observe the weight specified on the packaging (stick-on label).

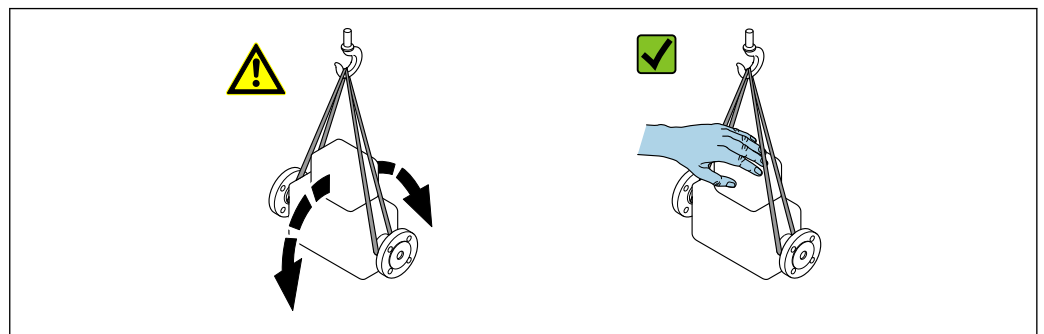

A0029214

5.2.2 Measuring devices with lifting lugs

⚠ CAUTION

Special transportation instructions for devices with lifting lugs

- ▶ Only use the lifting lugs fitted on the device or flanges to transport the device.
- ▶ The device must always be secured at two lifting lugs at least.

5.2.3 Transporting with a fork lift

If transporting in wood crates, the floor structure enables the crates to be lifted lengthwise or at both sides using a forklift.

⚠ CAUTION

Risk of damaging the magnetic coil

- ▶ If transporting by forklift, do not lift the sensor by the metal casing.
- ▶ This would buckle the casing and damage the internal magnetic coils.

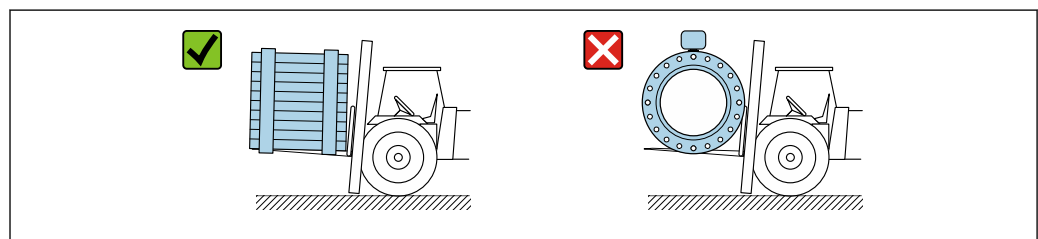

A0029319

5.3 Packaging disposal

All packaging materials are environmentally friendly and 100 % recyclable:

- Outer packaging of device
 - Polymer stretch wrap that complies with EU Directive 2002/95/EC (RoHS)
- Packaging
 - Wooden crate treated in accordance with ISPM 15 standard, confirmed by IPPC logo
 - Cardboard box in accordance with European packaging guideline 94/62EC, recyclability confirmed by Resy symbol
- Carrying and securing materials
 - Disposable plastic pallet
 - Plastic straps
 - Plastic adhesive strips
- Filler material
 - Paper pads

6 Installation

6.1 Installation conditions

6.1.1 Mounting position

Mounting location

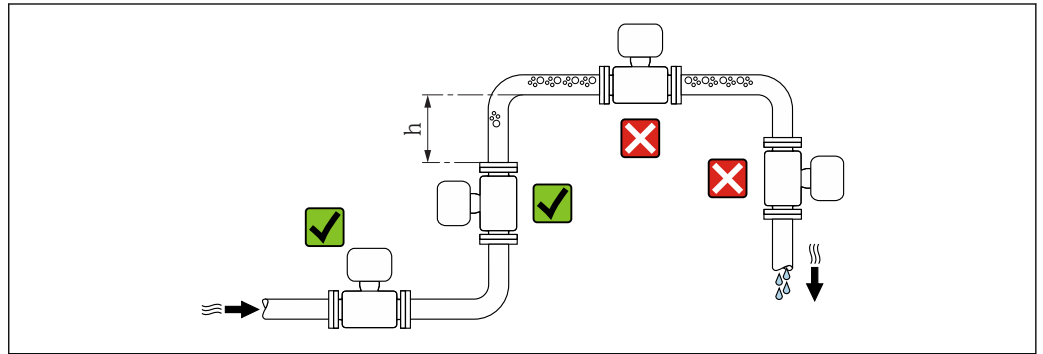

A0029343

Preferably install the sensor in an ascending pipe, and ensure a sufficient distance to the next pipe elbow: $h \geq 2 \times DN$.

 Distance $h \geq 2 \times DN$ not necessary with order code for "Design", option C, H, I.

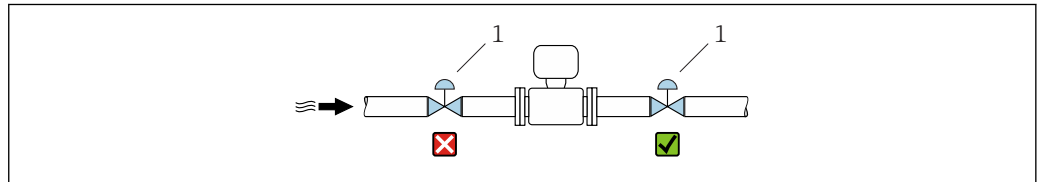

A0033017

 4 Installation of the sensor after a control valve is not recommended

1 Control valve

Installation in down pipes

Install a siphon with a vent valve downstream of the sensor in down pipes whose length $h \geq 5 \text{ m}$ (16.4 ft). This precaution is to avoid low pressure and the consequent risk of damage to the measuring tube. This measure also prevents the system losing prime.

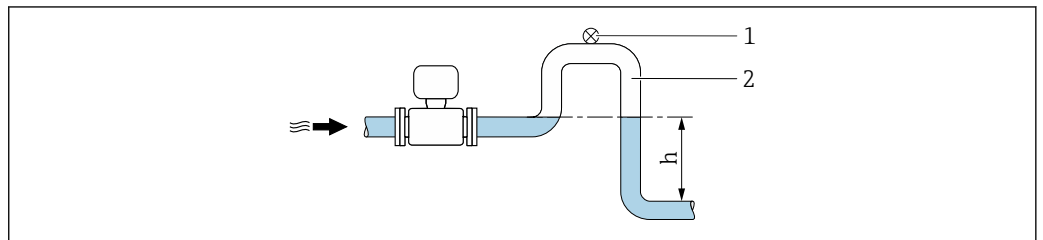

A0028981

 5 Installation in a down pipe

1 Vent valve

2 Pipe siphon

h Length of down pipe

Installation in partially filled pipes

A partially filled pipe with a gradient necessitates a drain-type configuration.

i No inlet runs necessary with order code for "Design", option C, H, I

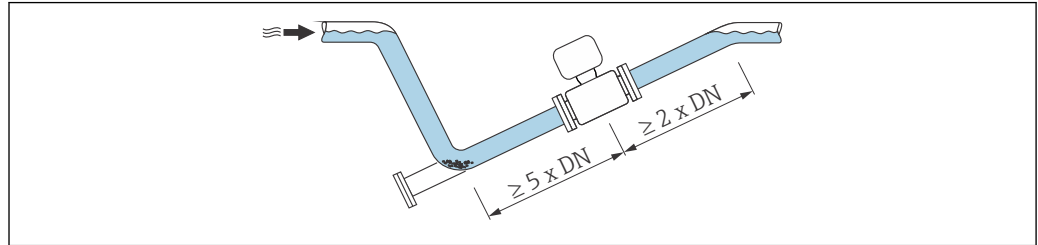

A0029257

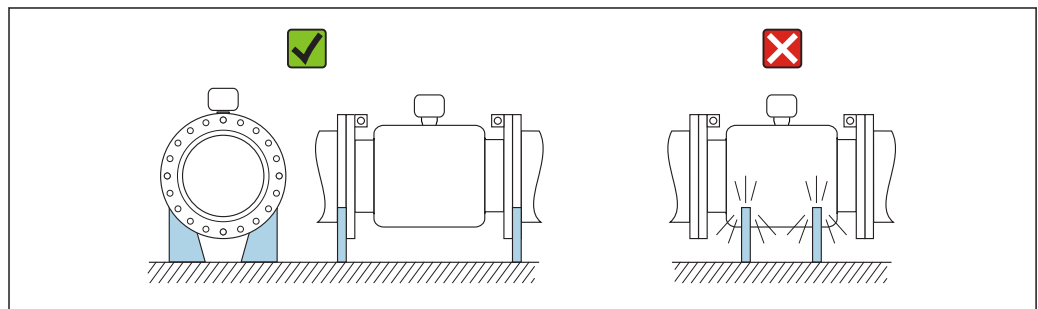

For heavy sensors DN ≥ 350 (14")



A0016276

Orientation

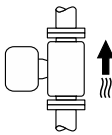
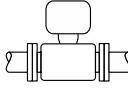
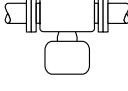
The direction of the arrow on the sensor nameplate helps you to install the sensor according to the flow direction (direction of medium flow through the piping).

Orientation		Recommendation
A	Vertical orientation	 A0015591 ✓✓
B	Horizontal orientation, transmitter at top	 A0015589 ✓✓ ¹⁾
C	Horizontal orientation, transmitter at bottom	 A0015590 ✓✓ ^{2) 3)} ✗ ⁴⁾
D	Horizontal orientation, transmitter at side	 A0015592 ✗

- 1) Applications with low process temperatures may decrease the ambient temperature. To maintain the minimum ambient temperature for the transmitter, this orientation is recommended.
- 2) Applications with high process temperatures may increase the ambient temperature. To maintain the maximum ambient temperature for the transmitter, this orientation is recommended.
- 3) To prevent the electronics module from overheating in the case of a sharp rise in temperature (e.g. CIP or SIP processes), install the device with the transmitter component pointing downwards.
- 4) With the empty pipe detection function switched on: empty pipe detection only works if the transmitter housing is pointing upwards.

Horizontal

- Ideally, the measuring electrode plane should be horizontal. This prevents brief insulation of the measuring electrodes by entrained air bubbles.
- Empty pipe detection only works if the transmitter housing is pointing upwards as otherwise there is no guarantee that the empty pipe detection function will actually respond to a partially filled or empty measuring tube.

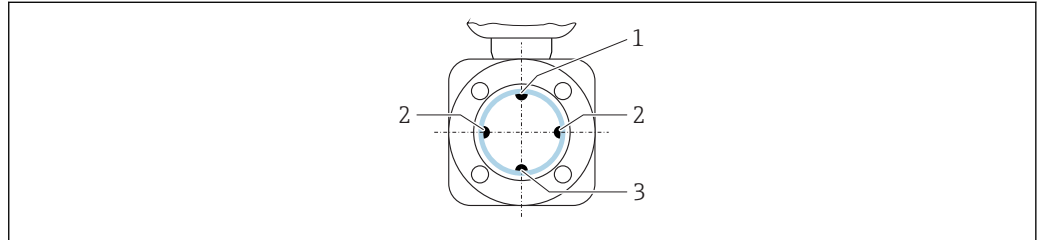

A0029344

- 1 EPD electrode for empty pipe detection
- 2 Measuring electrodes for signal detection
- 3 Reference electrode for potential equalization

Inlet and outlet runs

If possible, install the sensor upstream from fittings such as valves, T-pieces or elbows. Observe the following inlet and outlet runs to comply with accuracy specifications:

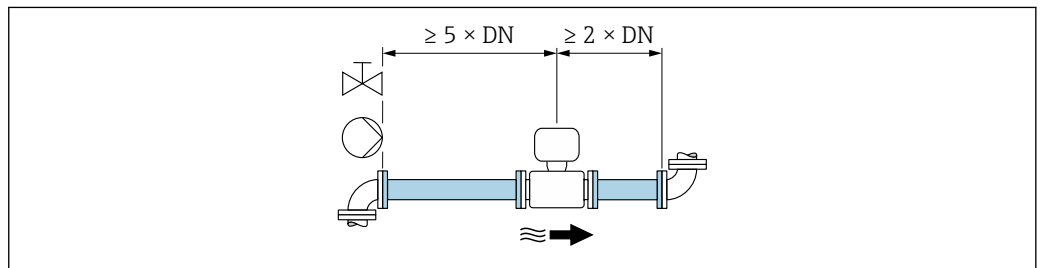

A0028997

For sensors with the order code for "Design", option C , H, I , no inlet or outlet runs need to be taken into account.

Installation dimensions



For the dimensions and installation lengths of the device, see the "Technical Information" document, "Mechanical construction" section.

6.1.2 Environment and process requirements

Ambient temperature range

Transmitter	Standard: -40 to +60 °C (-40 to +140 °F)
Local display	-20 to +60 °C (-4 to +140 °F), the readability of the display may be impaired at temperatures outside the temperature range.
Sensor	<ul style="list-style-type: none"> ■ Process connection material, carbon steel: -10 to +60 °C (+14 to +140 °F) ■ Process connection material, stainless steel: -40 to +60 °C (-40 to +140 °F)
Liner	Do not exceed or fall below the permitted temperature range of the liner .

If operating outdoors:

- Install the measuring device in a shady location.
- Avoid direct sunlight, particularly in warm climatic regions.
- Avoid direct exposure to weather conditions.

System pressure

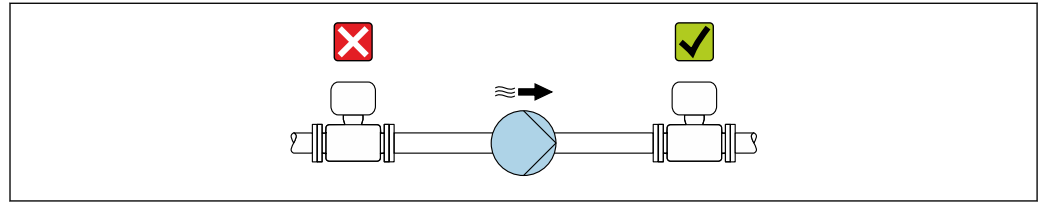

A0028777

Never install the sensor on the pump suction side in order to avoid the risk of low pressure, and thus damage to the liner.

- i** Furthermore, install pulse dampers if reciprocating, diaphragm or peristaltic pumps are used.
- i**
 - Information on the liner's resistance to partial vacuum → 177
 - Information on the shock resistance of the measuring system
 - Information on the vibration resistance of the measuring system

Vibrations

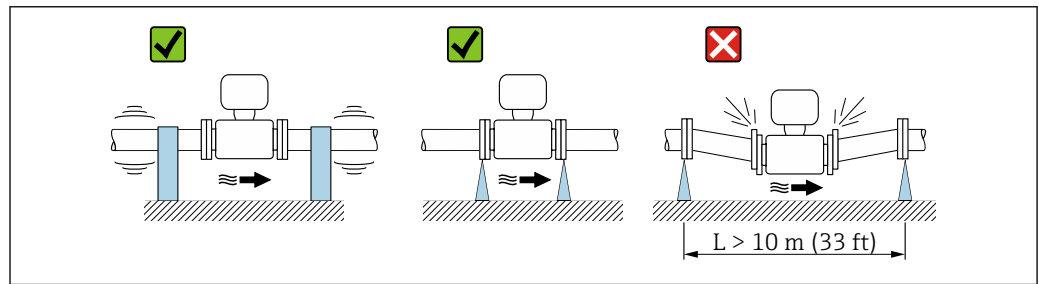

A0029004

6 Measures to prevent vibration of the device

In the event of very strong vibrations, the pipe and sensor must be supported and fixed.

It is also advisable to mount the sensor and transmitter separately.

- i**
 - Information on the shock resistance of the measuring system
 - Information on the vibration resistance of the measuring system

Thermal insulation

If process fluids are very hot, it is necessary to insulate pipes in order to reduce energy loss and to prevent individuals from accidentally coming into contact with hot pipes. Please observe the applicable standards and guidelines for insulating pipes.

⚠ WARNING

Electronics overheating on account of thermal insulation!

- ▶ The housing support is used for heat dissipation and must be completely free (i.e. uncovered). At the very maximum, the sensor insulation may extend as far as the upper edge of the two sensor half-shells.

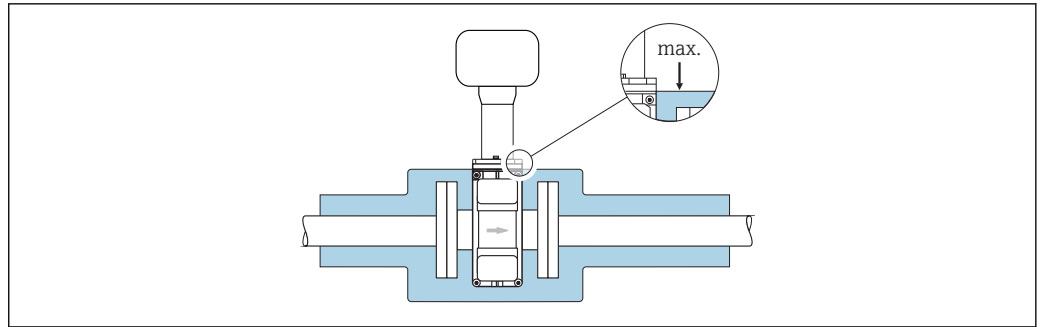

A0031216

Adapters

Suitable adapters to DIN EN 545 (double-flange reducers) can be used to install the sensor in larger-diameter pipes. The resultant increase in the rate of flow improves measuring accuracy with very slow-moving fluids. The nomogram shown here can be used to calculate the pressure loss caused by reducers and expanders.

i The nomogram only applies to liquids with a viscosity similar to that of water.

1. Calculate the ratio of the diameters d/D .
2. From the nomogram read off the pressure loss as a function of flow velocity (downstream from the reduction) and the d/D ratio.

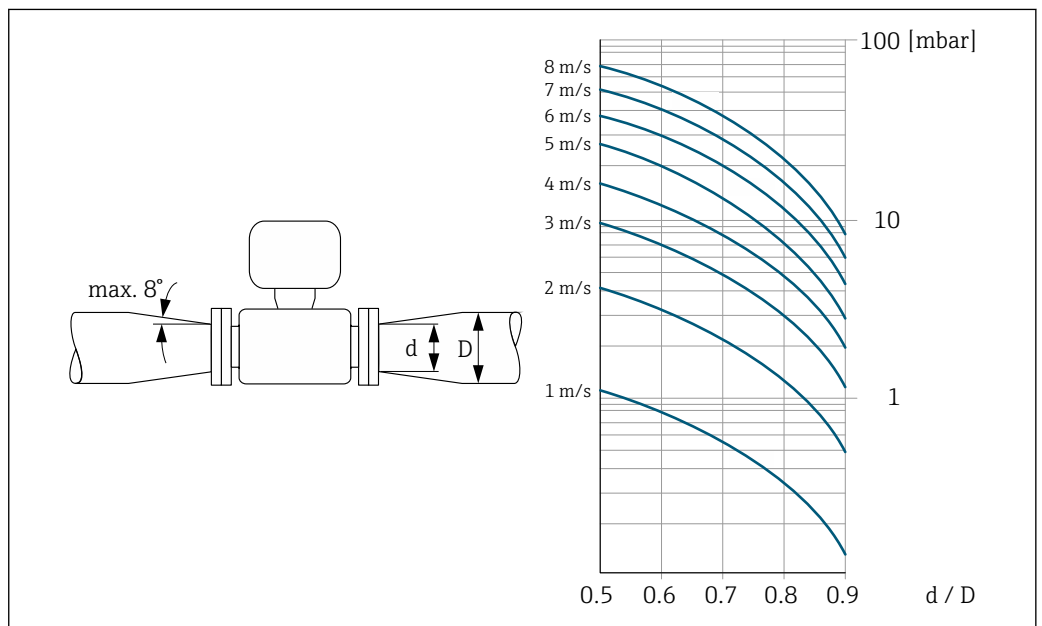

A0029002

6.1.3 Special mounting instructions

Protective cover

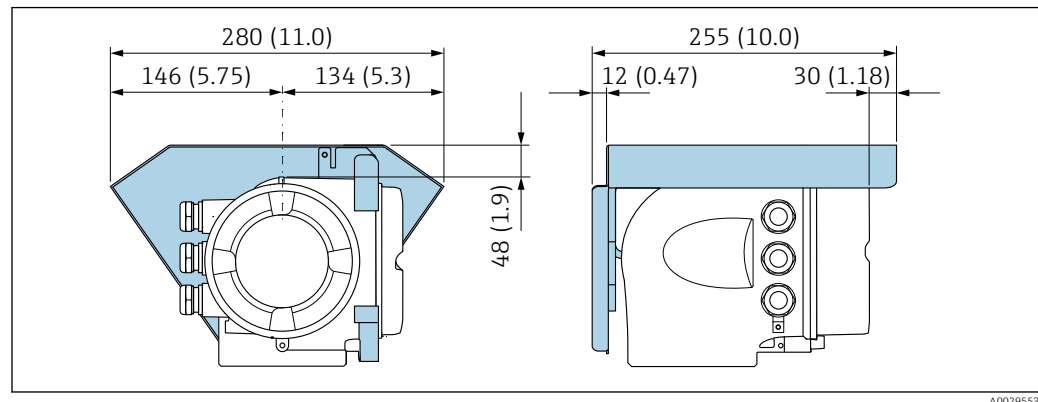

A0029553

6.2 Mounting the measuring device

6.2.1 Required tools

For sensor

For flanges and other process connections: Corresponding mounting tools

6.2.2 Preparing the measuring device

1. Remove all remaining transport packaging.
2. Remove any protective covers or protective caps present from the sensor.
3. Remove stick-on label on the electronics compartment cover.

6.2.3 Mounting the sensor

⚠ WARNING

Danger due to improper process sealing!

- ▶ Ensure that the inside diameters of the gaskets are greater than or equal to that of the process connections and piping.
 - ▶ Ensure that the gaskets are clean and undamaged.
 - ▶ Install the gaskets correctly.
1. Ensure that the direction of the arrow on the sensor matches the flow direction of the medium.
 2. To ensure compliance with device specifications, install the measuring device between the pipe flanges in a way that it is centered in the measurement section.
 3. If using ground disks, comply with the Installation Instructions provided.
 4. Observe required screw tightening torques → 27.

5. Install the measuring device or turn the transmitter housing so that the cable entries do not point upwards.

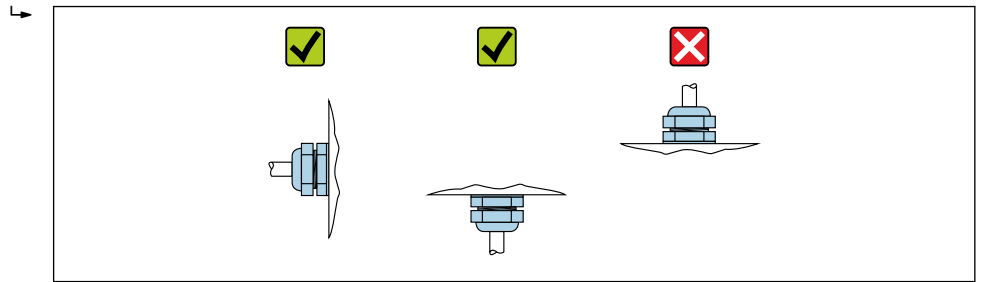

A0029263

Mounting the seals

⚠ CAUTION

An electrically conductive layer could form on the inside of the measuring tube!

Risk of measuring signal short circuit.

- ▶ Do not use electrically conductive sealing compounds such as graphite.

Comply with the following instructions when installing seals:

1. Make sure that the seals do not protrude into the piping cross-section.
2. For DIN flanges: only use seals according to DIN EN 1514-1.
3. For "hard rubber" liner: additional seals are **always** required.
4. For "polyurethane" liner: generally additional seals are **not** required.

Mounting the ground cable/ground disks

Comply with the information on potential equalization and detailed mounting instructions for the use of ground cables/ground disks → 42.

Screw tightening torques

Please note the following:

- The screw tightening torques listed below apply only to lubricated threads and to pipes not subjected to tensile stress.
- Tighten the screws uniformly and in diagonally opposite sequence.
- Overtightening the screws will deform the sealing faces or damage the seals.

i Nominal screw tightening torques → 32

Maximum screw tightening torques

Maximum screw tightening torques for EN 1092-1 (DIN 2501)

Nominal diameter		Pressure rating [bar]	Screws [mm]	Flange thickness [mm]	Max. screw tightening torque [Nm]		
[mm]	[in]				HG	PUR	PTFE
25	1	PN 40	4 × M12	18	–	15	26
32	–	PN 40	4 × M16	18	–	24	41
40	1 ½	PN 40	4 × M16	18	–	31	52
50	2	PN 40	4 × M16	20	48	40	65
65 ¹⁾	–	PN 16	8 × M16	18	32	27	44
65	–	PN 40	8 × M16	22	32	27	44
80	3	PN 16	8 × M16	20	40	34	53
		PN 40	8 × M16	24	40	34	53

Nominal diameter		Pressure rating [bar]	Screws [mm]	Flange thickness [mm]	Max. screw tightening torque [Nm]		
[mm]	[in]				HG	PUR	PTFE
100	4	PN 16	8 × M16	20	43	36	57
		PN 40	8 × M20	24	59	50	79
125	-	PN 16	8 × M16	22	56	48	75
		PN 40	8 × M24	26	83	71	112
150	6	PN 16	8 × M20	22	74	63	99
		PN 40	8 × M24	28	104	88	137
200	8	PN 10	8 × M20	24	106	91	141
		PN 16	12 × M20	24	70	61	94
		PN 25	12 × M24	30	104	92	139
250	10	PN 10	12 × M20	26	82	71	110
		PN 16	12 × M24	26	98	85	132
		PN 25	12 × M27	32	150	134	201
300	12	PN 10	12 × M20	26	94	81	126
		PN 16	12 × M24	28	134	118	179
		PN 25	16 × M27	34	153	138	204
350	14	PN 6	12 × M20	22	111	120	-
		PN 10	16 × M20	26	112	118	-
		PN 16	16 × M24	30	152	165	-
		PN 25	16 × M30	38	227	252	-
400	16	PN 6	16 × M20	22	90	98	-
		PN 10	16 × M24	26	151	167	-
		PN 16	16 × M27	32	193	215	-
		PN 25	16 × M33	40	289	326	-
450	18	PN 6	16 × M20	22	112	126	-
		PN 10	20 × M24	28	153	133	-
		PN 16	20 × M27	40	198	196	-
		PN 25	20 × M33	46	256	253	-
500	20	PN 6	20 × M20	24	119	123	-
		PN 10	20 × M24	28	155	171	-
		PN 16	20 × M30	34	275	300	-
		PN 25	20 × M33	48	317	360	-
600	24	PN 6	20 × M24	30	139	147	-
		PN 10	20 × M27	28	206	219	-
600	24	PN 16	20 × M33	36	415	443	-
600	24	PN 25	20 × M36	58	431	516	-
700	28	PN 6	24 × M24	24	148	139	-
		PN 10	24 × M27	30	246	246	-
		PN 16	24 × M33	36	278	318	-
		PN 25	24 × M39	46	449	507	-
800	32	PN 6	24 × M27	24	206	182	-
		PN 10	24 × M30	32	331	316	-

Nominal diameter		Pressure rating	Screws	Flange thickness	Max. screw tightening torque [Nm]		
[mm]	[in]				[bar]	[mm]	HG
		PN 16	24 × M36	38	369	385	-
		PN 25	24 × M45	50	664	721	-
900	36	PN 6	24 × M27	26	230	637	-
		PN 10	28 × M30	34	316	307	-
		PN 16	28 × M36	40	353	398	-
		PN 25	28 × M45	54	690	716	-
1000	40	PN 6	28 × M27	26	218	208	-
		PN 10	28 × M33	34	402	405	-
		PN 16	28 × M39	42	502	518	-
		PN 25	28 × M52	58	970	971	-
1200	48	PN 6	32 × M30	28	319	299	-
		PN 10	32 × M36	38	564	568	-
		PN 16	32 × M45	48	701	753	-
1400	-	PN 6	36 × M33	32	430	-	-
		PN 10	36 × M39	42	654	-	-
		PN 16	36 × M45	52	729	-	-
1600	-	PN 6	40 × M33	34	440	-	-
		PN 10	40 × M45	46	946	-	-
		PN 16	40 × M52	58	1007	-	-
1800	72	PN 6	44 × M36	36	547	-	-
		PN 10	44 × M45	50	961	-	-
		PN 16	44 × M52	62	1108	-	-
2000	-	PN 6	48 × M39	38	629	-	-
		PN 10	48 × M45	54	1047	-	-
		PN 16	48 × M56	66	1324	-	-
2200	-	PN 6	52 × M39	42	698	-	-
		PN 10	52 × M52	58	1217	-	-
2400	-	PN 6	56 × M39	44	768	-	-
		PN 10	56 × M52	62	1229	-	-

1) Sizing as per EN 1092-1 (not DIN 2501)

Maximum screw tightening torques for ASME B16.5

Nominal diameter		Pressure rating	Screws	Max. screw tightening torque					
[mm]	[in]			[psi]	[in]	HG		PUR	
						[Nm]	[lbf · ft]	[Nm]	[lbf · ft]
25	1	Class 150	4 × ½	-	-	7	5		
25	1	Class 300	4 × 5/8	-	-	8	6		
40	1 ½	Class 150	4 × ½	-	-	10	7		
40	1 ½	Class 300	4 × ¾	-	-	15	11		
50	2	Class 150	4 × 5/8	35	26	22	16		

Nominal diameter		Pressure rating [psi]	Screws [in]	Max. screw tightening torque			
[mm]	[in]			HG		PUR	
				[Nm]	[lbf · ft]	[Nm]	[lbf · ft]
50	2	Class 300	8 × 5/8	18	13	11	8
80	3	Class 150	4 × 5/8	60	44	43	32
80	3	Class 300	8 × 3/4	38	28	26	19
100	4	Class 150	8 × 5/8	42	31	31	23
100	4	Class 300	8 × 3/4	58	43	40	30
150	6	Class 150	8 × 3/4	79	58	59	44
150	6	Class 300	12 × 3/4	70	52	51	38
200	8	Class 150	8 × 3/4	107	79	80	59
250	10	Class 150	12 × 7/8	101	74	75	55
300	12	Class 150	12 × 7/8	133	98	103	76
350	14	Class 150	12 × 1	135	100	158	117
400	16	Class 150	16 × 1	128	94	150	111
450	18	Class 150	16 × 1 1/8	204	150	234	173
500	20	Class 150	20 × 1 1/8	183	135	217	160
600	24	Class 150	20 × 1 1/4	268	198	307	226

Maximum screw tightening torques for JIS B2220

Nominal diameter [mm]	Pressure rating [bar]	Screws [mm]	Max. screw tightening torque [Nm]	
			HG	PUR
25	10K	4 × M16	–	19
25	20K	4 × M16	–	19
32	10K	4 × M16	–	22
32	20K	4 × M16	–	22
40	10K	4 × M16	–	24
40	20K	4 × M16	–	24
50	10K	4 × M16	40	33
50	20K	8 × M16	20	17
65	10K	4 × M16	55	45
65	20K	8 × M16	28	23
80	10K	8 × M16	29	23
80	20K	8 × M20	42	35
100	10K	8 × M16	35	29
100	20K	8 × M20	56	48
125	10K	8 × M20	60	51
125	20K	8 × M22	91	79
150	10K	8 × M20	75	63
150	20K	12 × M22	81	72
200	10K	12 × M20	61	52
200	20K	12 × M22	91	80
250	10K	12 × M22	100	87

Nominal diameter [mm]	Pressure rating [bar]	Screws [mm]	Max. screw tightening torque [Nm]	
			HG	PUR
250	20K	12 × M24	159	144
300	10K	16 × M22	74	63
300	20K	16 × M24	138	124

Maximum screw tightening torques for AWWA C207, Class D

Nominal diameter		Screws [in]	Max. screw tightening torque			
[mm]	[in]		HG		PUR	
			[Nm]	[lbf · ft]	[Nm]	[lbf · ft]
700	28	28 × 1 ¼	247	182	292	215
750	30	28 × 1 ¼	287	212	302	223
800	32	28 × 1 ½	394	291	422	311
900	36	32 × 1 ½	419	309	430	317
1000	40	36 × 1 ½	420	310	477	352
–	42	36 × 1 ½	528	389	518	382
–	48	44 × 1 ½	552	407	531	392
–	54	44 × 1 ¾	730	538	–	–
–	60	52 × 1 ¾	758	559	–	–
–	66	52 × 1 ¾	946	698	–	–
–	72	60 × 1 ¾	975	719	–	–
–	78	64 × 2	853	629	–	–
–	84	64 × 2	931	687	–	–
–	90	64 × 2 ¼	1048	773	–	–

Maximum screw tightening torques for AS 2129, Table E

Nominal diameter [mm]	Screws [mm]	Max. screw tightening torque [Nm]	
		HG	PUR
50	4 × M16	32	–
80	4 × M16	49	–
100	8 × M16	38	–
150	8 × M20	64	–
200	8 × M20	96	–
250	12 × M20	98	–
300	12 × M24	123	–
350	12 × M24	203	–
400	12 × M24	226	–
450	16 × M24	226	–
500	16 × M24	271	–
600	16 × M30	439	–
700	20 × M30	355	–
750	20 × M30	559	–

Nominal diameter [mm]	Screws [mm]	Max. screw tightening torque [Nm]	
		HG	PUR
800	20 × M30	631	-
900	24 × M30	627	-
1000	24 × M30	634	-
1200	32 × M30	727	-

Maximum screw tightening torques for AS 4087, PN 16

Nominal diameter [mm]	Screws [mm]	Max. screw tightening torque [Nm]	
		HG	PUR
50	4 × M16	32	-
80	4 × M16	49	-
100	4 × M16	76	-
150	8 × M20	52	-
200	8 × M20	77	-
250	8 × M20	147	-
300	12 × M24	103	-
350	12 × M24	203	-
375	12 × M24	137	-
400	12 × M24	226	-
450	12 × M24	301	-
500	16 × M24	271	-
600	16 × M27	393	-
700	20 × M27	330	-
750	20 × M30	529	-
800	20 × M33	631	-
900	24 × M33	627	-
1000	24 × M33	595	-
1200	32 × M33	703	-

Nominal screw tightening torques

Nominal screw tightening torques for EN 1092-1 (DIN 2501); calculated according to EN 1591-1:2014 for flanges according to EN 1092-1:2013

Nominal diameter		Pressure rating [bar]	Screws [mm]	Flange thickness [mm]	Nom. screw tightening torque [Nm]		
[mm]	[in]				HG	PUR	PTFE
1000	40	PN 6	28 × M27	38	175	185	-
		PN 10	28 × M33	44	350	360	-
		PN 16	28 × M39	59	630	620	-
		PN 25	28 × M52	63	1300	1290	-
1200	48	PN 6	32 × M30	42	235	250	-
		PN 10	32 × M36	55	470	480	-
		PN 16	32 × M45	78	890	900	-

Nominal diameter		Pressure rating [bar]	Screws [mm]	Flange thickness [mm]	Nom. screw tightening torque [Nm]		
[mm]	[in]				HG	PUR	PTFE
1400	-	PN 6	36 × M33	56	300	-	-
		PN 10	36 × M39	65	600	-	-
		PN 16	36 × M45	84	1050	-	-
1600	-	PN 6	40 × M33	63	340	-	-
		PN 10	40 × M45	75	810	-	-
		PN 16	40 × M52	102	1420	-	-
1800	72	PN 6	44 × M36	69	430	-	-
		PN 10	44 × M45	85	920	-	-
		PN 16	44 × M52	110	1600	-	-
2000	-	PN 6	48 × M39	74	530	-	-
		PN 10	48 × M45	90	1040	-	-
		PN 16	48 × M56	124	1900	-	-
2200	-	PN 6	52 × M39	81	580	-	-
		PN 10	52 × M52	100	1290	-	-
2400	-	PN 6	56 × M39	87	650	-	-
		PN 10	56 × M52	110	1410	-	-

Nominal screw tightening torques for JIS B2220

Nominal diameter [mm]	Pressure rating [bar]	Screws [mm]	Nom. screw tightening torque [Nm]	
			HG	PUR
350	10K	16 × M22	109	109
	20K	16 × M30×3	217	217
400	10K	16 × M24	163	163
	20K	16 × M30×3	258	258
450	10K	16 × M24	155	155
	20K	16 × M30×3	272	272
500	10K	16 × M24	183	183
	20K	16 × M30×3	315	315
600	10K	16 × M30	235	235
	20K	16 × M36×3	381	381
700	10K	16 × M30	300	300
750	10K	16 × M30	339	339

6.2.4 Turning the transmitter housing

To provide easier access to the connection compartment or display module, the transmitter housing can be turned.

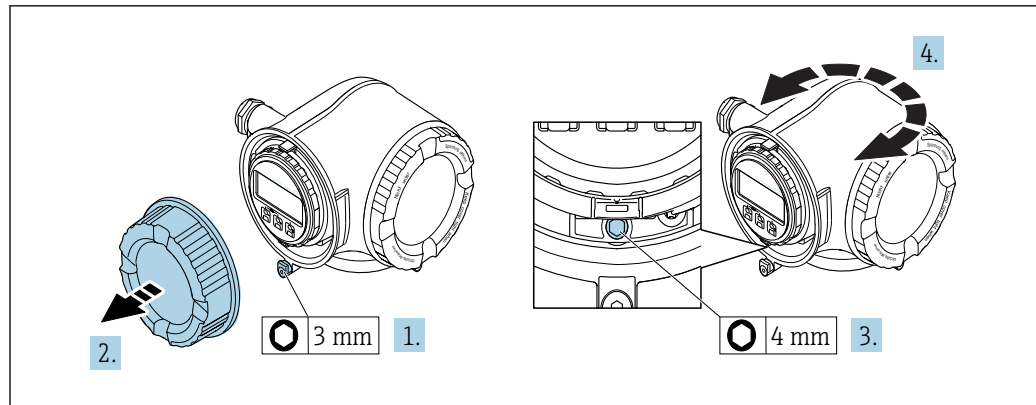

A0029993

1. Depending on the device version: Loosen the securing clamp of the connection compartment cover.
2. Unscrew the connection compartment cover.
3. Release the fixing screw.
4. Turn the housing to the desired position.
5. Firmly tighten the securing screw.
6. Screw on the connection compartment cover
7. Depending on the device version: Attach the securing clamp of the connection compartment cover.

6.2.5 Turning the display module

The display module can be turned to optimize display readability and operability.

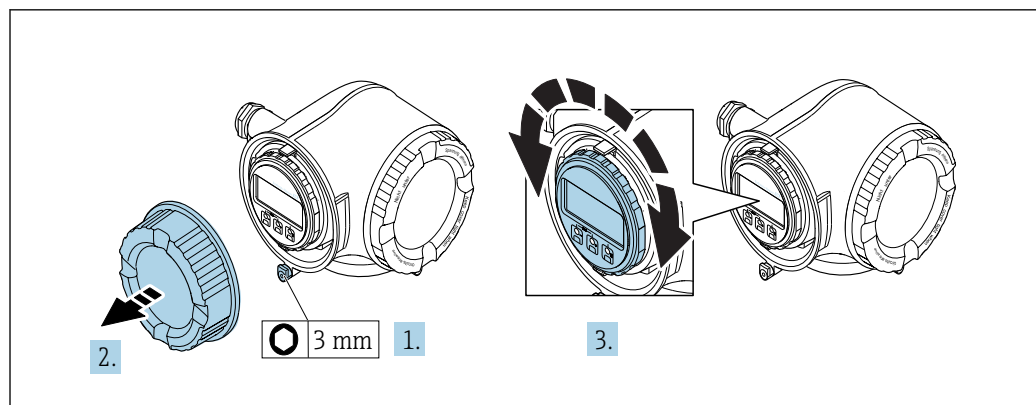

A0030035

1. Depending on the device version: Loosen the securing clamp of the connection compartment cover.
2. Unscrew the connection compartment cover.
3. Turn the display module to the desired position: max. $8 \times 45^\circ$ in each direction.
4. Screw on the connection compartment cover.
5. Depending on the device version: Attach the securing clamp of the connection compartment cover.

6.3 Post-installation check

Is the device undamaged (visual inspection)?	<input type="checkbox"/>
Does the measuring device conform to the measuring point specifications? For example: <ul style="list-style-type: none"> ▪ Process temperature ▪ Process pressure (refer to the section on "Pressure-temperature ratings" in the "Technical Information" document) ▪ Ambient temperature ▪ Measuring range 	<input type="checkbox"/>
Has the correct orientation for the sensor been selected ? <ul style="list-style-type: none"> ▪ According to sensor type ▪ According to medium temperature ▪ According to medium properties (outgassing, with entrained solids) 	<input type="checkbox"/>
Does the arrow on the sensor nameplate match the direction of flow of the fluid through the piping ?	<input type="checkbox"/>
Are the measuring point identification and labeling correct (visual inspection)?	<input type="checkbox"/>
Is the device adequately protected from precipitation and direct sunlight?	<input type="checkbox"/>
Have the fixing screws been tightened with the correct tightening torque?	<input type="checkbox"/>

7 Electrical connection

NOTICE

The measuring device does not have an internal circuit breaker.

- ▶ For this reason, assign the measuring device a switch or power-circuit breaker so that the power supply line can be easily disconnected from the mains.
- ▶ Although the measuring device is equipped with a fuse, additional overcurrent protection (maximum 10 A) should be integrated into the system installation.

7.1 Connection conditions

7.1.1 Required tools

- For cable entries: Use corresponding tools
- For securing clamp: Allen key 3 mm
- Wire stripper
- When using stranded cables: Crimper for wire end ferrule
- For removing cables from terminal: Flat blade screwdriver ≤ 3 mm (0.12 in)

7.1.2 Requirements for connecting cable

The connecting cables provided by the customer must fulfill the following requirements.

Electrical safety

In accordance with applicable federal/national regulations.

Protective ground cable

Cable ≥ 2.08 mm² (14 AWG)

The grounding impedance must be less than 1 Ω .

Permitted temperature range

- The installation guidelines that apply in the country of installation must be observed.
- The cables must be suitable for the minimum and maximum temperatures to be expected.

Power supply cable

Standard installation cable is sufficient.

Signal cable

Current output 4 to 20 mA HART

A shielded cable is recommended. Observe grounding concept of the plant.

Current output 0/4 to 20 mA

Standard installation cable is sufficient.

Pulse/frequency/switch output

Standard installation cable is sufficient.

Double pulse output

Standard installation cable is sufficient.

Relay output

Standard installation cable is sufficient.

Current input 0/4 to 20 mA

Standard installation cable is sufficient.

Status input

Standard installation cable is sufficient.

Cable diameter

- Cable glands supplied:
M20 × 1.5 with cable Ø 6 to 12 mm (0.24 to 0.47 in)
- Spring-loaded terminals: Suitable for strands and strands with ferrules.
Conductor cross-section 0.2 to 2.5 mm² (24 to 12 AWG).

Requirements for the connecting cable – Remote display and operating module DKX001*Optionally available connecting cable*

A cable is supplied depending on the order option

- Order code for measuring device: order code **030** for "Display; operation", option **O** or
- Order code for measuring device: order code **030** for "Display; operation", option **M** and
- Order code for DKX001: order code **040** for "Cable", option **A, B, D, E**

Standard cable	2 × 2 × 0.34 mm ² (22 AWG) PVC cable with common shield (2 pairs, pair-stranded)
Flame resistance	According to DIN EN 60332-1-2
Oil-resistance	According to DIN EN 60811-2-1
Shielding	Tin-plated copper-braid, optical cover ≥ 85 %
Capacitance: core/shield	≤200 pF/m
L/R	≤24 μH/Ω
Available cable length	5 m (15 ft)/10 m (35 ft)/20 m (65 ft)/30 m (100 ft)
Operating temperature	When mounted in a fixed position: -50 to +105 °C (-58 to +221 °F); when cable can move freely: -25 to +105 °C (-13 to +221 °F)

Standard cable - customer-specific cable

No cable is supplied, and it must be provided by the customer (up to max. 300 m (1 000 ft)) for the following order option:

Order code for DKX001: Order code **040** for "Cable", option **1** "None, provided by customer, max 300 m"

A standard cable can be used as the connecting cable.

Standard cable	4 cores (2 pairs); pair-stranded with common shield
Shielding	Tin-plated copper-braid, optical cover ≥ 85 %
Capacitance: core/shield	Maximum 1 000 nF for Zone 1, Class I, Division 1
L/R	Maximum 24 μH/Ω for Zone 1, Class I, Division 1
Cable length	Maximum 300 m (1 000 ft), see the following table



Cross-section	Max. cable length for use in Non-hazardous area, Ex Zone 2, Class I, Division 2 Ex Zone 1, Class I, Division 1
0.34 mm ² (22 AWG)	80 m (270 ft)
0.50 mm ² (20 AWG)	120 m (400 ft)
0.75 mm ² (18 AWG)	180 m (600 ft)
1.00 mm ² (17 AWG)	240 m (800 ft)
1.50 mm ² (15 AWG)	300 m (1 000 ft)

7.1.3 Terminal assignment

Transmitter: supply voltage, input/outputs

The terminal assignment of the inputs and outputs depends on the individual order version of the device. The device-specific terminal assignment is documented on an adhesive label in the terminal cover.

Supply voltage		Input/output 1		Input/output 2		Input/output 3	
1 (+)	2 (-)	26 (+)	27 (-)	24 (+)	25 (-)	22 (+)	23 (-)
Device-specific terminal assignment: adhesive label in terminal cover.							

 Terminal assignment of the remote display and operating module →  42.

7.1.4 Preparing the measuring device

NOTICE

Insufficient sealing of the housing!

Operational reliability of the measuring device could be compromised.

► Use suitable cable glands corresponding to the degree of protection.

1. Remove dummy plug if present.
2. If the measuring device is supplied without cable glands:
Provide suitable cable gland for corresponding connecting cable.
3. If the measuring device is supplied with cable glands:
Observe requirements for connecting cables →  36.

7.2 Connecting the measuring device

NOTICE

Limitation of electrical safety due to incorrect connection!

- Have electrical connection work carried out by appropriately trained specialists only.
- Observe applicable federal/national installation codes and regulations.
- Comply with local workplace safety regulations.
- Always connect the protective ground cable \ominus before connecting additional cables.
- For use in potentially explosive atmospheres, observe the information in the device-specific Ex documentation.

7.2.1 Connecting the transmitter

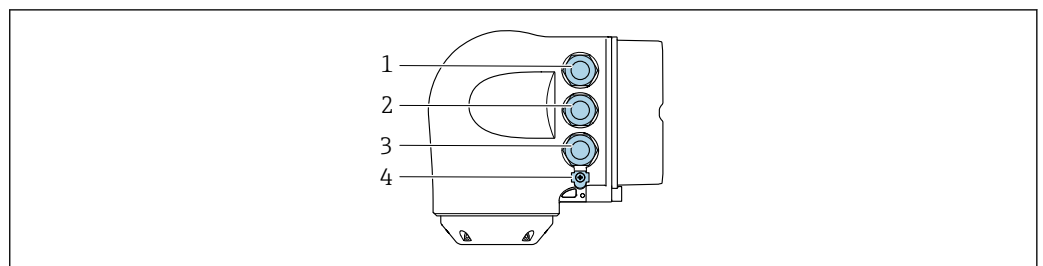

- 1 Terminal connection for supply voltage
- 2 Terminal connection for signal transmission, input/output
- 3 Terminal connection for signal transmission, input/output or terminal connection for network connection via service interface (CDI-RJ45); optional: connection for external WLAN antenna or remote display and operating module DKX001
- 4 Protective earth (PE)

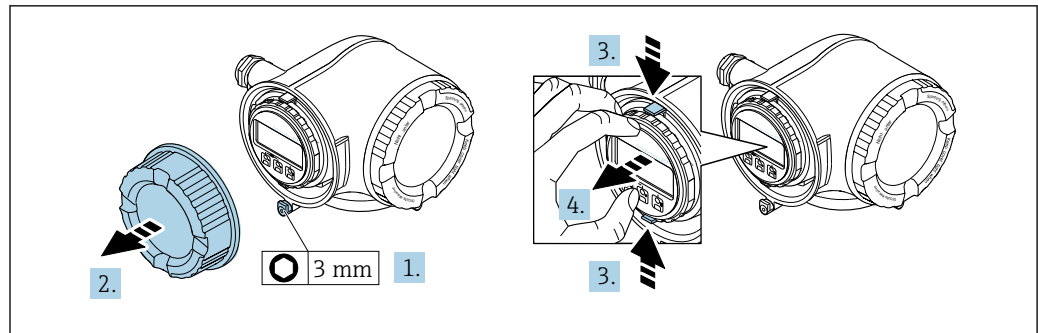

A0029813

1. Loosen the securing clamp of the connection compartment cover.
2. Unscrew the connection compartment cover.
3. Squeeze the tabs of the display module holder together.
4. Remove the display module holder.

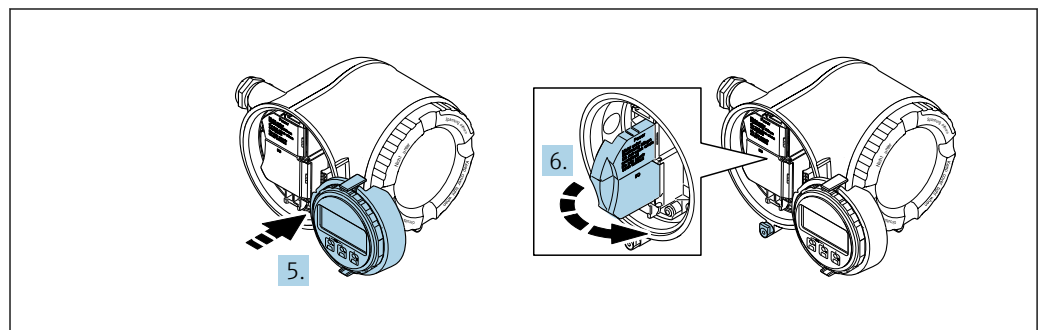

A0029814

5. Attach the holder to the edge of the electronics compartment.
6. Open the terminal cover.

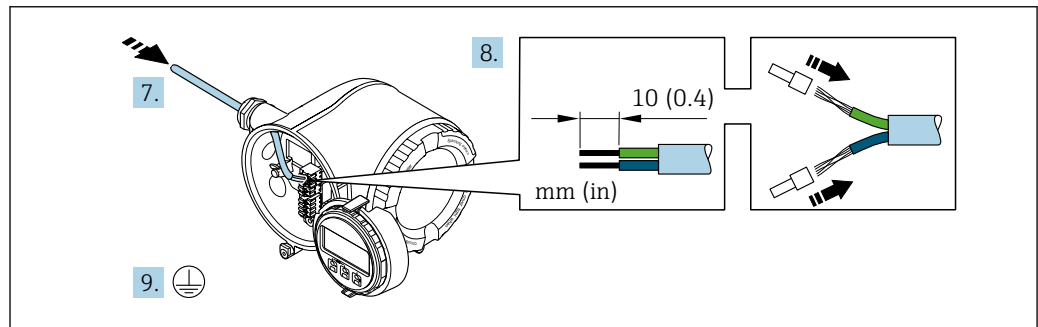

A0029815

7. Push the cable through the cable entry . To ensure tight sealing, do not remove the sealing ring from the cable entry.
8. Strip the cable and cable ends. In the case of stranded cables, also fit ferrules.
9. Connect the protective ground.

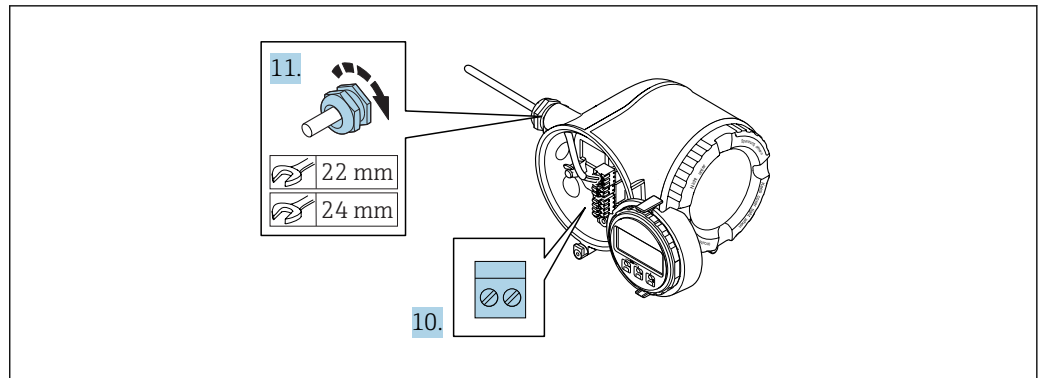

A0029816

10. Connect the cable in accordance with the terminal assignment .
 - ↳ **Signal cable terminal assignment:** The device-specific terminal assignment is documented on an adhesive label in the terminal cover.
 - Supply voltage terminal assignment:** Adhesive label in the terminal cover or → 39.
11. Firmly tighten the cable glands.
 - ↳ This concludes the cable connection process.
12. Close the terminal cover.
13. Fit the display module holder in the electronics compartment.
14. Screw on the connection compartment cover.
15. Secure the securing clamp of the connection compartment cover.

Removing a cable

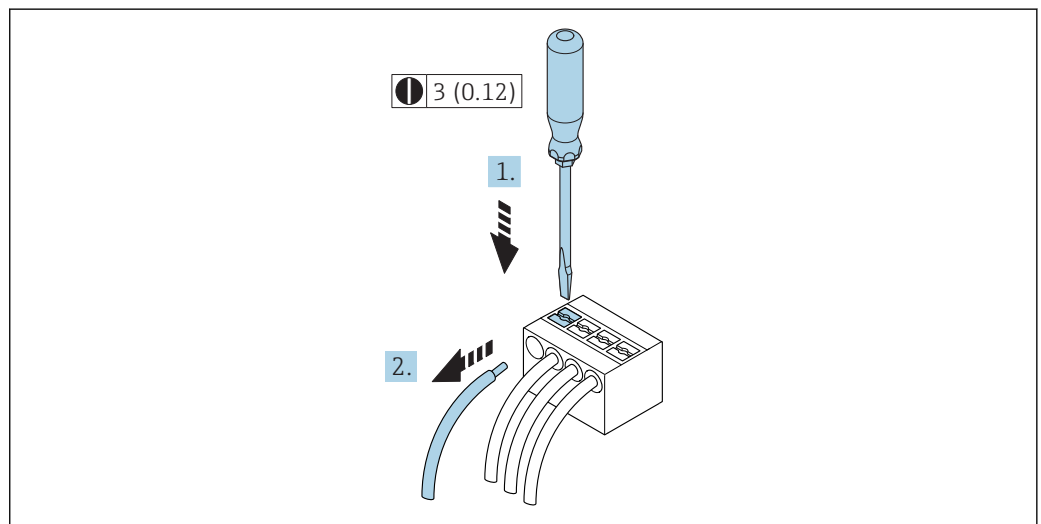

A0029598

7 Engineering unit mm (in)

1. To remove a cable from the terminal, use a flat-blade screwdriver to push the slot between the two terminal holes
2. while simultaneously pulling the cable end out of the terminal.

7.2.2 Connecting the remote display and operating module DKX001

i The remote display and operating module DKX001 is available as an optional extra → 158.

- The measuring device is always supplied with a dummy cover when the remote display and operating module DKX001 is ordered directly with the measuring device. Display or operation at the transmitter is not possible in this case.
- If ordered subsequently, the remote display and operating module DKX001 may not be connected at the same time as the existing measuring device display module. Only one display or operation unit may be connected to the transmitter at any one time.

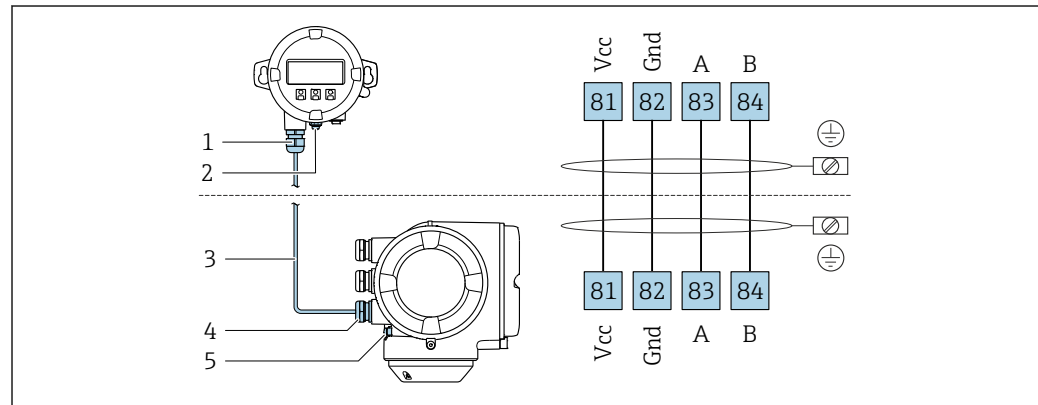

A0027518

- 1 Remote display and operating module DKX001
- 2 Protective earth (PE)
- 3 Connecting cable
- 4 Measuring device
- 5 Protective earth (PE)

7.3 Ensuring potential equalization

7.3.1 Requirements

CAUTION

Electrode damage can result in the complete failure of the device!

- ▶ Same electrical potential for the fluid and sensor
- ▶ Company-internal grounding concepts
- ▶ Pipe material and grounding

7.3.2 Connection example, standard scenario

Metal, grounded pipe

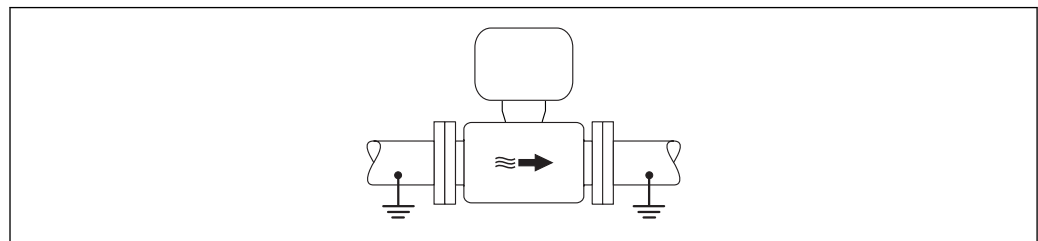

A0016315

- 8** Potential equalization via measuring tube

7.3.3 Connection example in special situations

Unlined and ungrounded metal pipe

This connection method also applies in situations where:

- The customary potential equalization is not used
- Equalizing currents are present

Ground cable	Copper wire, at least 6 mm ² (0.0093 in ²)
---------------------	---

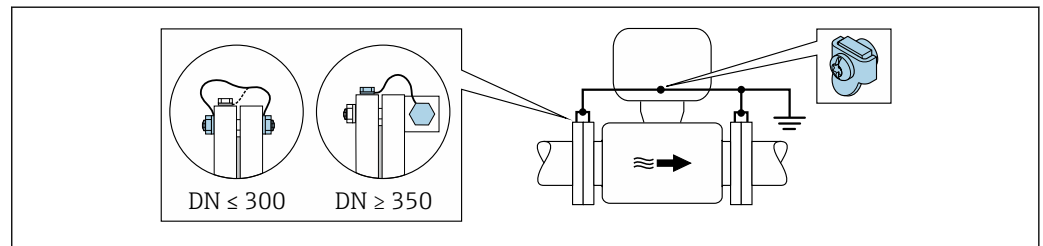

9 Potential equalization via ground terminal and pipe flanges

1. Connect both sensor flanges to the pipe flange via a ground cable and ground them.
2. If $DN \leq 300$ (12"): Mount the ground cable directly on the conductive flange coating of the sensor with the flange screws.
3. If $DN \geq 350$ (14"): Mount the ground cable directly on the metal transport bracket. Observe screw tightening torques: see the Sensor Brief Operating Instructions.
4. Connect the connection housing of the transmitter or sensor to ground potential by means of the ground terminal provided for the purpose.

Plastic pipe or pipe with insulating liner

This connection method also applies in situations where:

- The customary potential equalization is not used
- Equalizing currents are present

Ground cable	Copper wire, at least 6 mm ² (0.0093 in ²)
---------------------	---

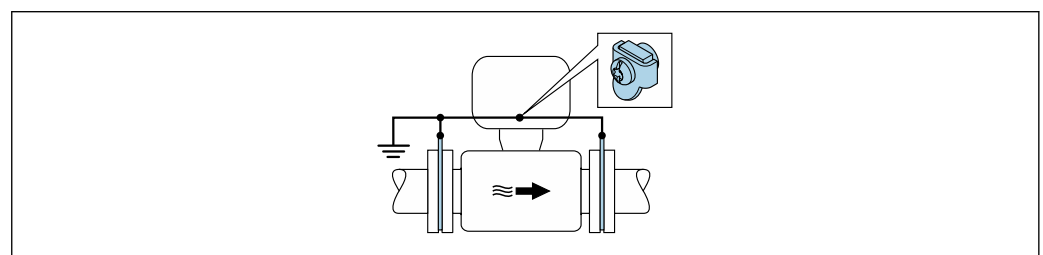

10 Potential equalization via ground terminal and ground disks

1. Connect the ground disks to the ground terminal via the ground cable.
2. Connect the ground disks to ground potential.

Pipe with a cathodic protection unit

This connection method is only used if the following two conditions are met:

- Metal pipe without liner or pipe with electrically conductive liner
- Cathodic protection is integrated in the personal protection equipment

Ground cable	Copper wire, at least 6 mm ² (0.0093 in ²)
---------------------	---

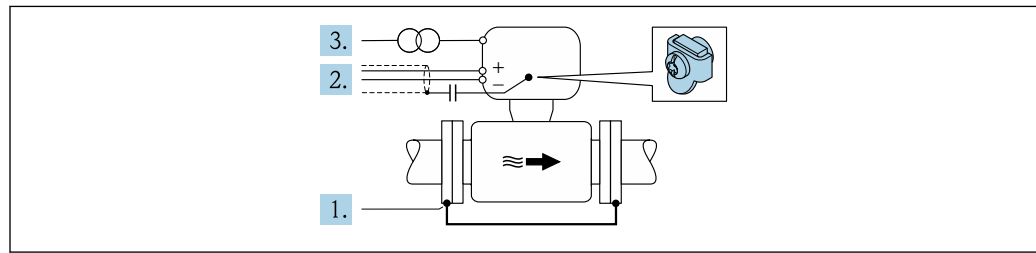

A0029340

Prerequisite: The sensor is installed in the pipe in a way that provides electrical insulation.

1. Connect the two flanges of the pipe to one another via a ground cable.
2. Guide the shield of the signal lines through a capacitor.
3. Connect the measuring device to the power supply such that it is floating in relation to the protective ground (isolation transformer).

7.4 Special connection instructions

7.4.1 Connection examples

Current output 4 to 20 mA HART

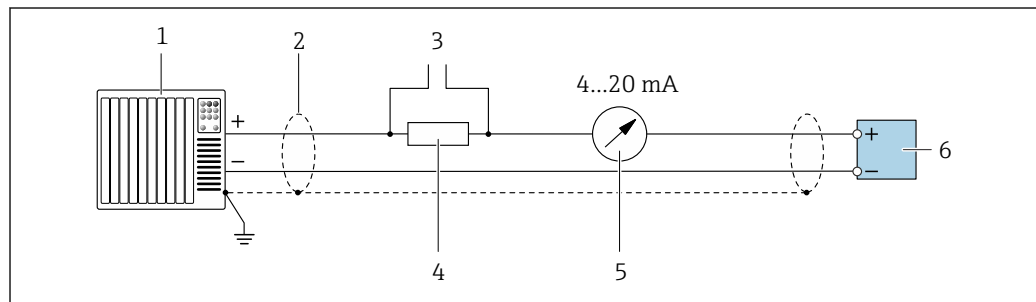

A0029055

11 Connection example for 4 to 20 mA HART current output (active)

- 1 Automation system with current input (e.g. PLC)
- 2 Cable shield provided at one end. The cable shield must be grounded at both ends to comply with EMC requirements; observe cable specifications
- 3 Connection for HART operating devices → 70
- 4 Resistor for HART communication ($\geq 250 \Omega$); observe maximum load → 167
- 5 Analog display unit: observe maximum load → 167
- 6 Transmitter

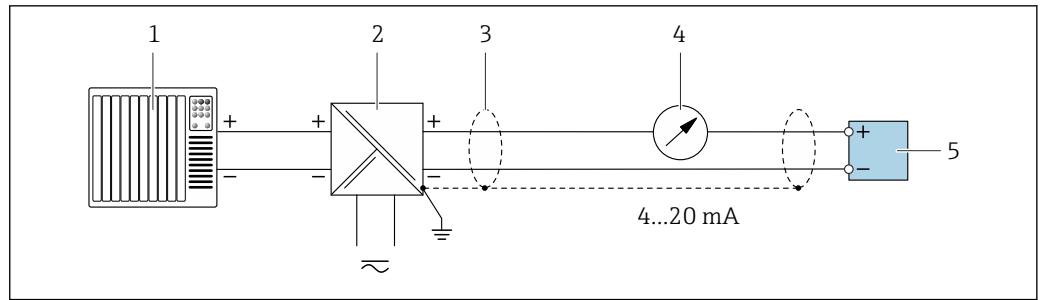

A0028762

12 Connection example for 4 to 20 mA HART current output (passive)

- 1 Automation system with current input (e.g. PLC)
- 2 Power supply
- 3 Cable shield provided at one end. The cable shield must be grounded at both ends to comply with EMC requirements; observe cable specifications
- 4 Analog display unit: observe maximum load → 167
- 5 Transmitter

HART input

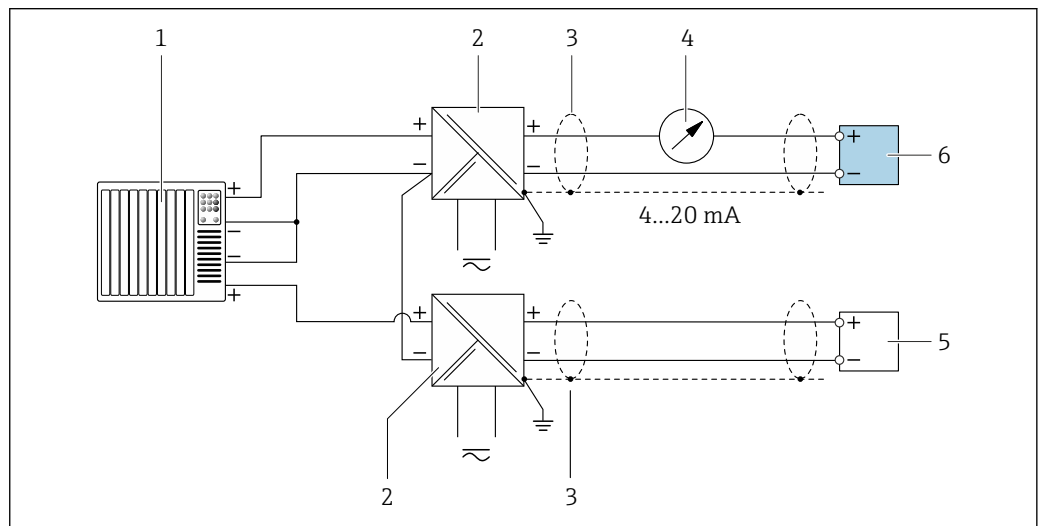

A0028763

13 Connection example for HART input with a common negative (passive)

- 1 Automation system with HART output (e.g. PLC)
- 2 Active barrier for power supply (e.g. RN221N)
- 3 Cable shield provided at one end. The cable shield must be grounded at both ends to comply with EMC requirements; observe cable specifications
- 4 Analog display unit: observe maximum load → 167
- 5 Pressure measuring device (e.g. Cerabar M, Cerabar S): see requirements
- 6 Transmitter

Current output 4-20 mA

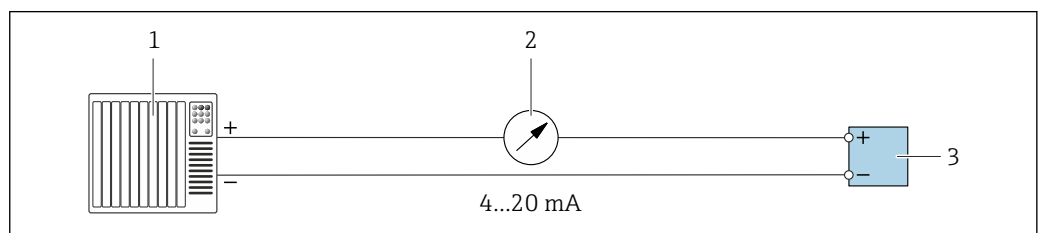

A0028758

14 Connection example for 4-20 mA current output (active)

- 1 Automation system with current input (e.g. PLC)
- 2 Analog display unit: observe maximum load → 167
- 3 Transmitter

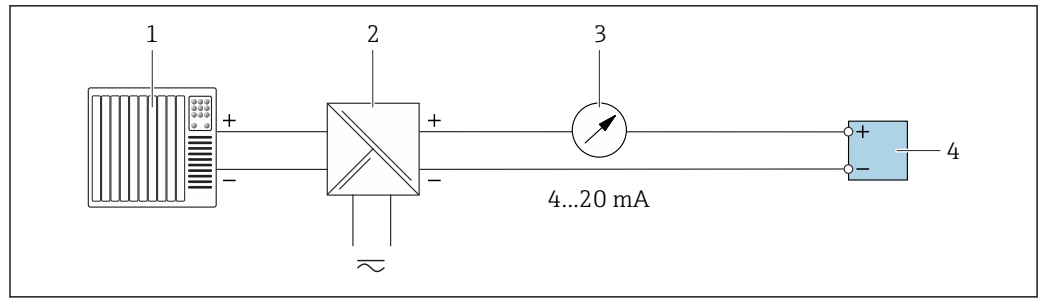

A0028759

15 Connection example for 4-20 mA current output (passive)

- 1 Automation system with current input (e.g. PLC)
- 2 Active barrier for power supply (e.g. RN221N)
- 3 Analog display unit: observe maximum load → 167
- 4 Transmitter

Pulse/frequency output

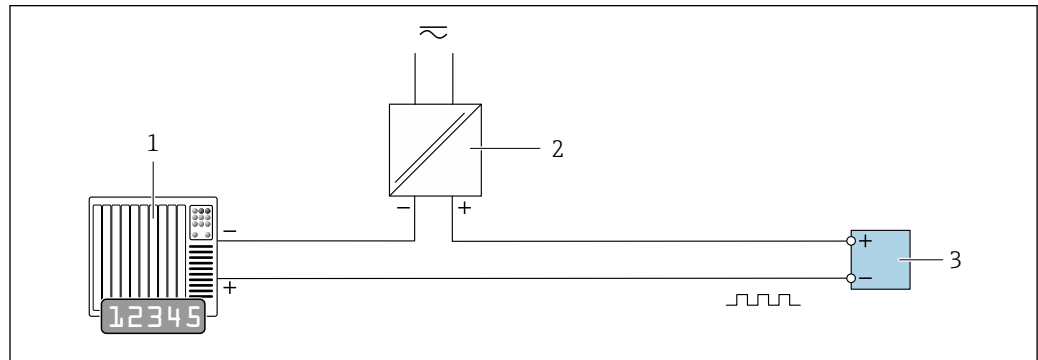

A0028761

16 Connection example for pulse/frequency output (passive)

- 1 Automation system with pulse/frequency input (e.g. PLC)
- 2 Power supply
- 3 Transmitter: Observe input values → 169

Switch output

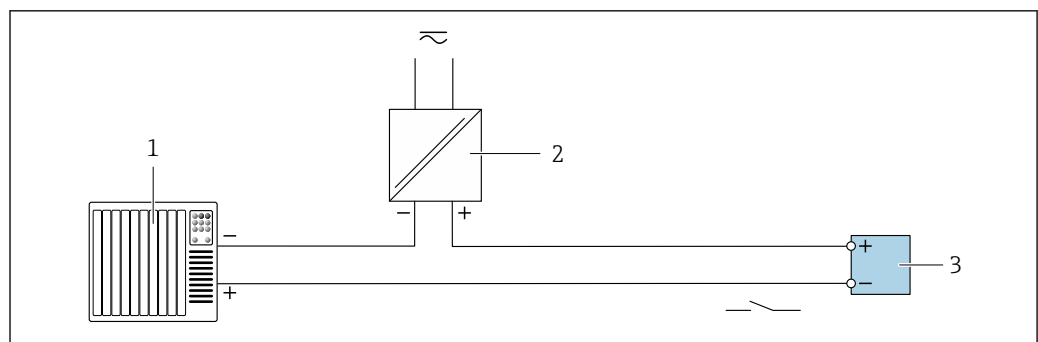

A0028760

17 Connection example for switch output (passive)

- 1 Automation system with switch input (e.g. PLC)
- 2 Power supply
- 3 Transmitter: Observe input values → 169

Double pulse output

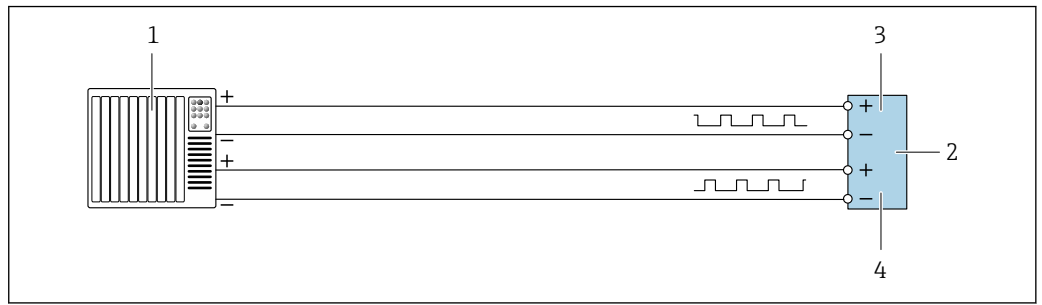

A0029280

18 Connection example for double pulse output (active)

- 1 Automation system with double pulse input (e.g. PLC)
- 2 Transmitter: Observe input values → 170
- 3 Double pulse output
- 4 Double pulse output (slave), phase-shifted

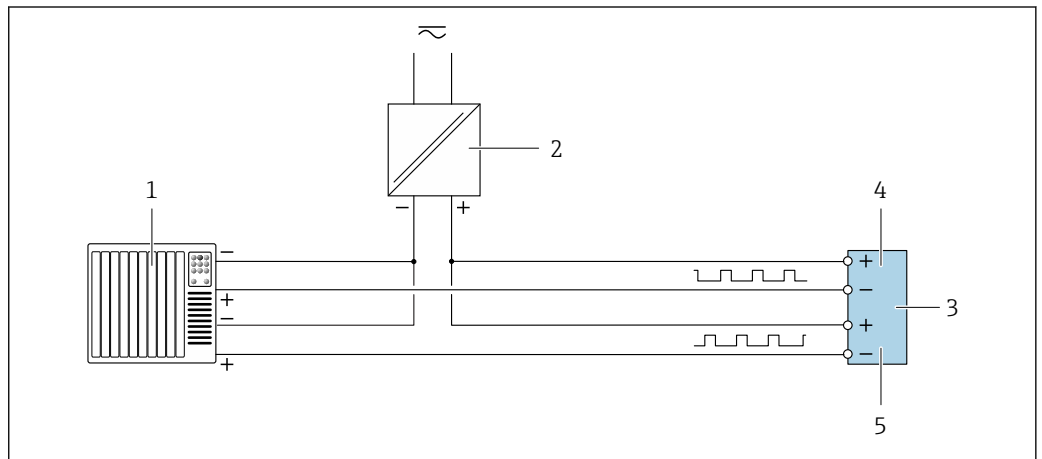

A0029279

19 Connection example for double pulse output (passive)

- 1 Automation system with double pulse input (e.g. PLC)
- 2 Power supply
- 3 Transmitter: Observe input values → 170
- 4 Double pulse output
- 5 Double pulse output (slave), phase-shifted

Relay output

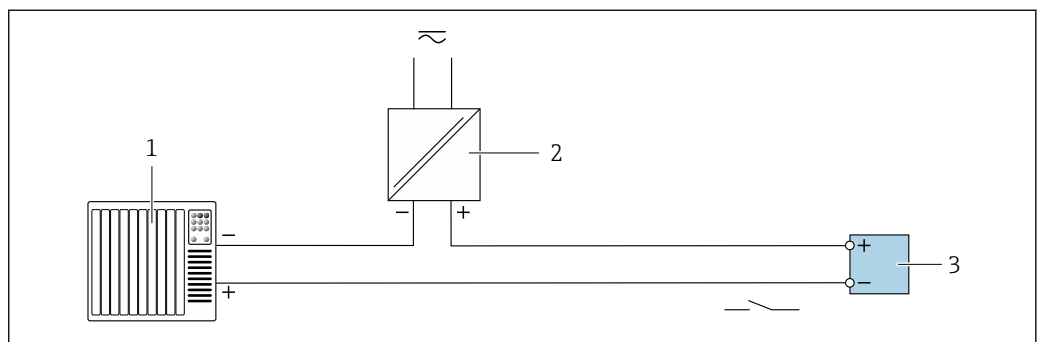

A0028760

20 Connection example for relay output (passive)

- 1 Automation system with relay input (e.g. PLC)
- 2 Power supply
- 3 Transmitter: Observe input values → 170

Current input

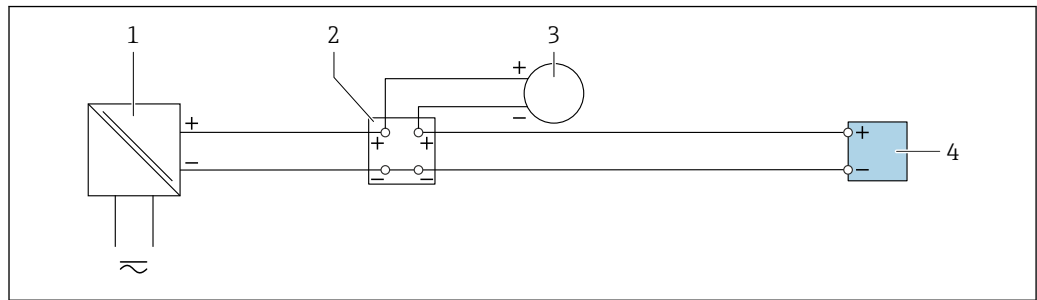

A0028915

21 Connection example for 4 to 20 mA current input

- 1 Power supply
- 2 Terminal box
- 3 External measuring device (to read in pressure or temperature, for instance)
- 4 Transmitter

Status input

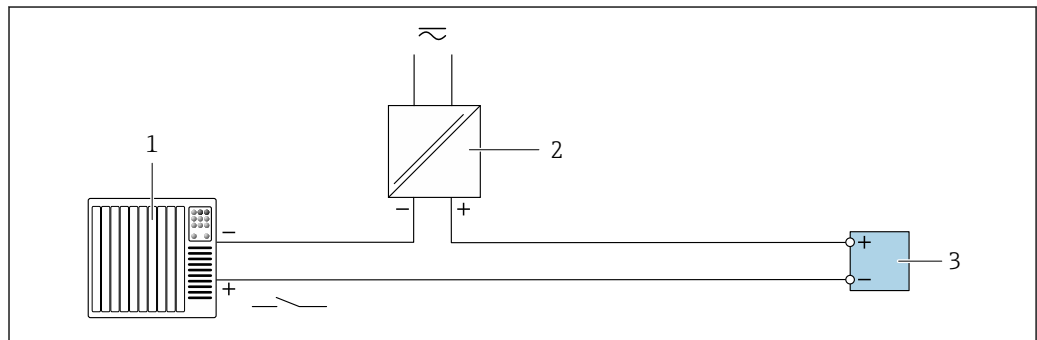

A0028764

22 Connection example for status input

- 1 Automation system with status output (e.g. PLC)
- 2 Power supply
- 3 Transmitter

7.5 Ensuring the degree of protection

The measuring device fulfills all the requirements for the IP66/67 degree of protection, Type 4X enclosure.

To guarantee IP66/67 degree of protection, Type 4X enclosure, carry out the following steps after the electrical connection:

1. Check that the housing seals are clean and fitted correctly.
2. Dry, clean or replace the seals if necessary.
3. Tighten all housing screws and screw covers.
4. Firmly tighten the cable glands.

- 5. To ensure that moisture does not enter the cable entry:
Route the cable so that it loops down before the cable entry ("water trap").

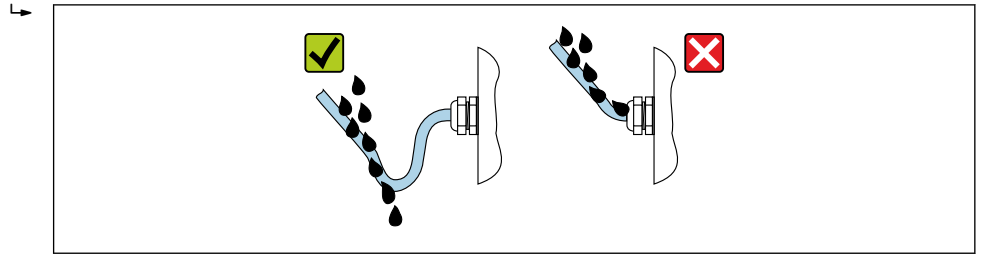

A0029278

- 6. Insert dummy plugs into unused cable entries.

7.6 Post-connection check

Are cables or the device undamaged (visual inspection)?	<input type="checkbox"/>
Do the cables used meet the requirements?	<input type="checkbox"/>
Do the cables have adequate strain relief?	<input type="checkbox"/>
Are all the cable glands installed, firmly tightened and leak-tight? Cable run with "water trap" → 48?	<input type="checkbox"/>
If supply voltage is present, do values appear on the display module?	<input type="checkbox"/>
Is the potential equalization established correctly ?	<input type="checkbox"/>

8 Operation options

8.1 Overview of operation options

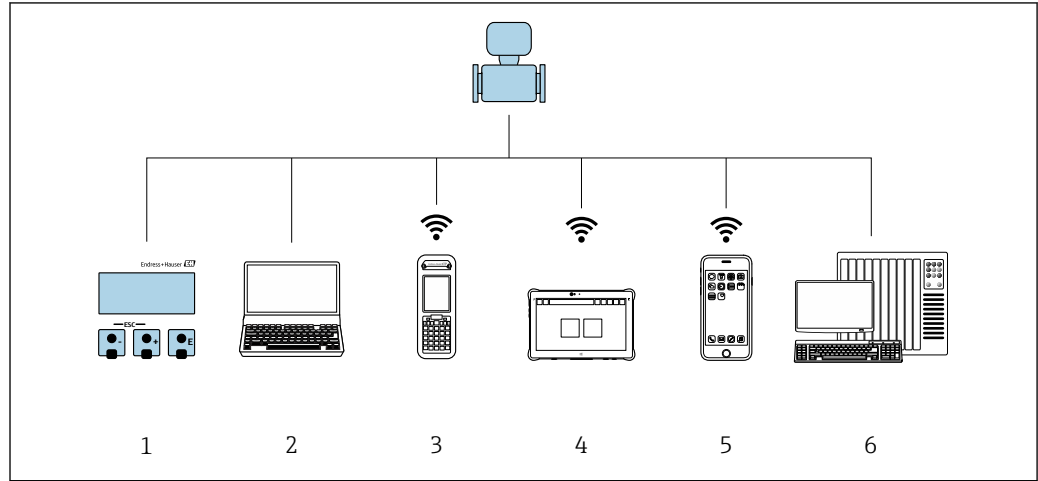



A0034513

- 1 Local operation via display module
- 2 Computer with Web browser (e.g. Internet Explorer) or with operating tool (e.g. FieldCare, DeviceCare, AMS Device Manager, SIMATIC PDM)
- 3 Field Xpert SFX350 or SFX370
- 4 Field Xpert SMT70
- 5 Mobile handheld terminal
- 6 Control system (e.g. PLC)

8.2 Structure and function of the operating menu

8.2.1 Structure of the operating menu

 For an overview of the operating menu for experts: "Description of Device Parameters" document supplied with the device →  195

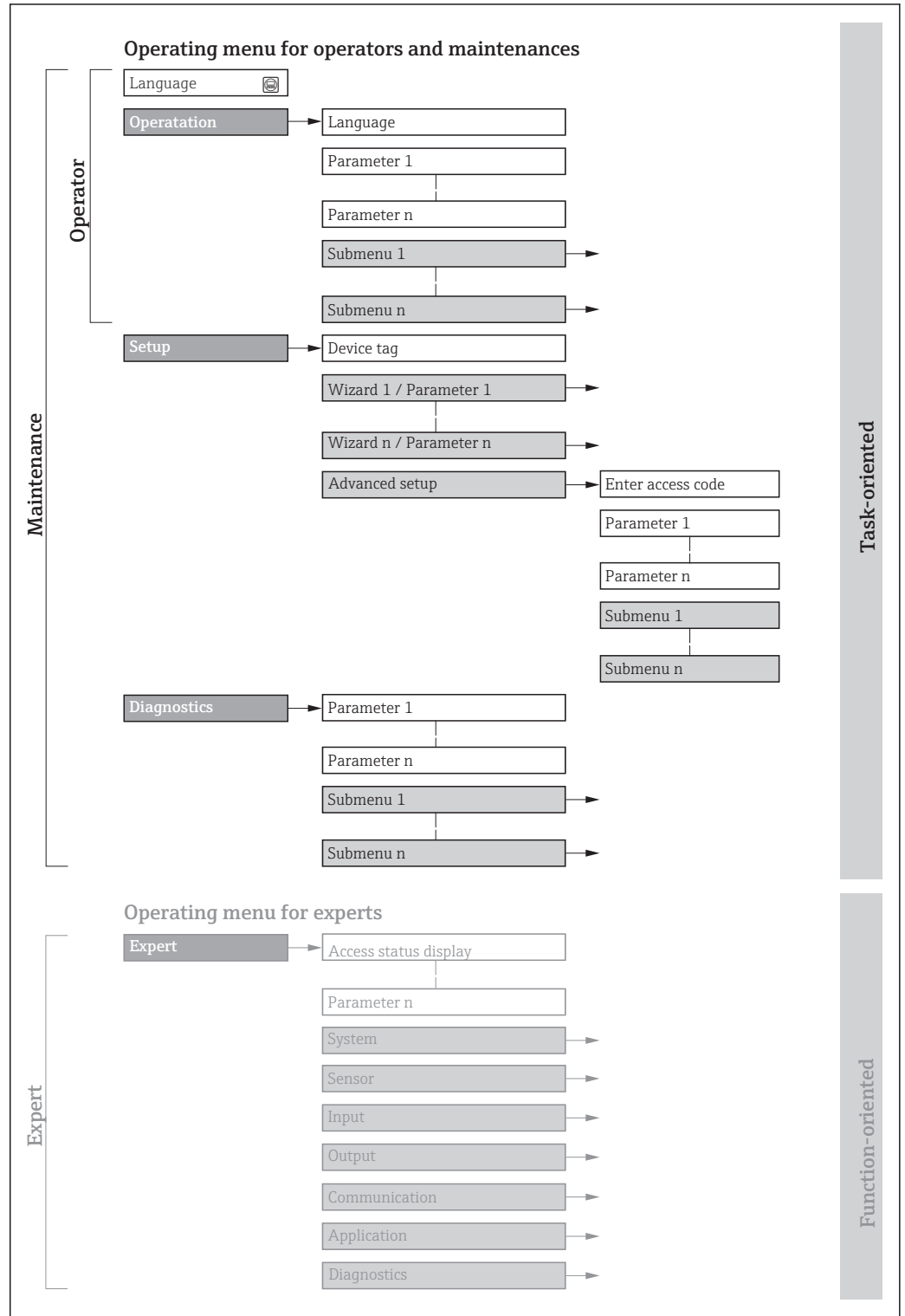

 23 Schematic structure of the operating menu

A0018237-EN

8.2.2 Operating philosophy

The individual parts of the operating menu are assigned to certain user roles (operator, maintenance etc.). Each user role contains typical tasks within the device lifecycle.

Menu/parameter		User role and tasks	Content/meaning
Language	task-oriented	Role "Operator", "Maintenance" Tasks during operation: <ul style="list-style-type: none"> ▪ Configuring the operational display ▪ Reading measured values 	<ul style="list-style-type: none"> ▪ Defining the operating language ▪ Defining the Web server operating language ▪ Resetting and controlling totalizers
Operation			<ul style="list-style-type: none"> ▪ Configuring the operational display (e.g. display format, display contrast) ▪ Resetting and controlling totalizers
Setup		"Maintenance" role Commissioning: <ul style="list-style-type: none"> ▪ Configuration of the measurement ▪ Configuration of the inputs and outputs ▪ Configuration of the communication interface 	Wizards for fast commissioning: <ul style="list-style-type: none"> ▪ Setting the system units ▪ Displaying the I/O/configuration ▪ Configuring the inputs ▪ Configuring the outputs ▪ Configuration of the operational display ▪ Setting the low flow cut off ▪ Configuring empty pipe detection Advanced setup <ul style="list-style-type: none"> ▪ For more customized configuration of the measurement (adaptation to special measuring conditions) ▪ Configuration of totalizers ▪ Configuration of electrode cleaning (optional) ▪ Configuring the WLAN settings ▪ Administration (define access code, reset measuring device)
Diagnostics		"Maintenance" role Fault elimination: <ul style="list-style-type: none"> ▪ Diagnostics and elimination of process and device errors ▪ Measured value simulation 	Contains all parameters for error detection and analyzing process and device errors: <ul style="list-style-type: none"> ▪ Diagnostic list Contains up to 5 currently pending diagnostic messages. ▪ Event logbook Contains event messages that have occurred. ▪ Device information Contains information for identifying the device. ▪ Measured values Contains all current measured values. ▪ Data logging submenu with "Extended HistorOM" order option Storage and visualization of measured values ▪ Heartbeat The functionality of the device is checked on demand and the verification results are documented. ▪ Simulation Is used to simulate measured values or output values.
Expert	function-oriented	Tasks that require detailed knowledge of the function of the device: <ul style="list-style-type: none"> ▪ Commissioning measurements under difficult conditions ▪ Optimal adaptation of the measurement to difficult conditions ▪ Detailed configuration of the communication interface ▪ Error diagnostics in difficult cases 	Contains all the parameters of the device and makes it possible to access these parameters directly using an access code. The structure of this menu is based on the function blocks of the device: <ul style="list-style-type: none"> ▪ System Contains all higher-order device parameters which do not concern the measurement or the communication interface. ▪ Sensor Configuration of the measurement. ▪ Input Configuration of the status input. ▪ Output Configuration of the analog current outputs as well as the pulse/frequency and switch output. ▪ Communication Configuration of the digital communication interface and the Web server. ▪ Application Configuration of the functions that go beyond the actual measurement (e.g. totalizer). ▪ Diagnostics Error detection and analysis of process and device errors and for device simulation and Heartbeat Technology.

8.3 Access to the operating menu via the local display

8.3.1 Operational display

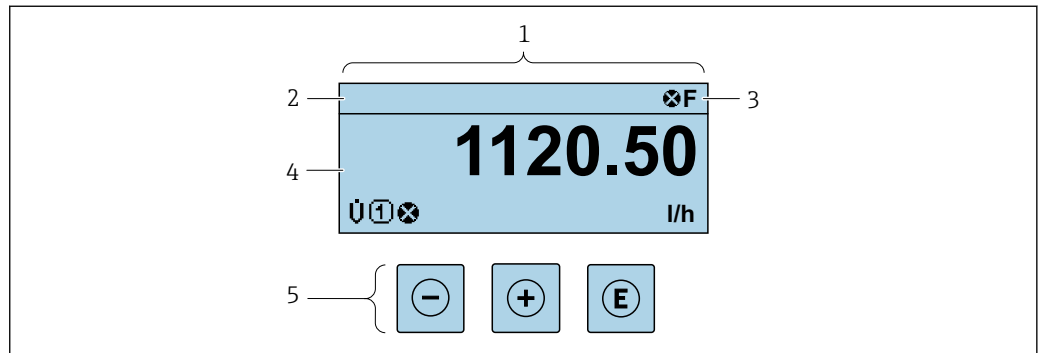

A0029346

- 1 Operational display
- 2 Device tag → 83
- 3 Status area
- 4 Display area for measured values (4-line)
- 5 Operating elements → 58

Status area

The following symbols appear in the status area of the operational display at the top right:

- Status signals → 136
 - **F**: Failure
 - **C**: Function check
 - **S**: Out of specification
 - **M**: Maintenance required
- Diagnostic behavior → 137
 - : Alarm
 - : Warning
- : Locking (the device is locked via the hardware)
- : Communication (communication via remote operation is active)

Display area

In the display area, each measured value is prefaced by certain symbol types for further description:

	Measured variable	Measurement channel number	Diagnostic behavior
	↓	↓	↓
Example			

Appears only if a diagnostics event is present for this measured variable.

Measured values

Symbol	Meaning
U	Volume flow
G	Conductivity

	Mass flow
	Totalizer The measurement channel number indicates which of the three totalizers is displayed.
	Output The measurement channel number indicates which of the outputs is displayed.
	Status input

Measurement channel numbers

Symbol	Meaning
	Measurement channel 1 to 4
The measurement channel number is displayed only if more than one channel is present for the same measured variable type (e.g. Totalizer 1 to 3).	

Diagnostic behavior

The diagnostic behavior pertains to a diagnostic event that is relevant to the displayed measured variable. For information on the symbols → 137

The number and display format of the measured values can be configured via the **Format display** parameter (→ 97).

8.3.2 Navigation view



In the submenu	In the wizard
<p>Diagram showing a submenu with a navigation path (1) at the top, a status area (3) with '0091-1', a display area (4) with 'Access stat.disp' and 'Operator', and operating elements (5) at the bottom: minus, plus, and E buttons.</p>	<p>Diagram showing a wizard with a navigation path (1) at the top, a status area (3) with 'S', a display area (4) with 'Curr. output 1' and 'Volume flow', and operating elements (5) at the bottom: minus, plus, and E buttons.</p>
<p>1 Navigation view 2 Navigation path to current position 3 Status area 4 Display area for navigation 5 Operating elements → 58</p>	

Navigation path

The navigation path - displayed at the top left in the navigation view - consists of the following elements:

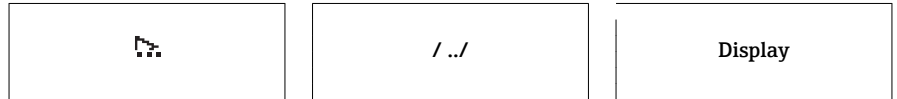
	<ul style="list-style-type: none"> In the submenu: Display symbol for menu In the wizard: Display symbol for wizard 	Omission symbol for operating menu levels in between	Name of current <ul style="list-style-type: none"> Submenu Wizard Parameters
	↓	↓	↓
Examples		/ .. /	Display





 For more information about the icons in the menu, refer to the "Display area" section →  55

Status area





The following appears in the status area of the navigation view in the top right corner:

- In the submenu
 - The direct access code for the parameter you are navigating to (e.g. 0022-1)
 - If a diagnostic event is present, the diagnostic behavior and status signal
- In the wizard
 - If a diagnostic event is present, the diagnostic behavior and status signal





-  ▪ For information on the diagnostic behavior and status signal →  136
- For information on the function and entry of the direct access code →  60

Display area

Menus

Symbol	Meaning
	Operation Appears: <ul style="list-style-type: none"> ▪ In the menu next to the "Operation" selection ▪ At the left in the navigation path in the Operation menu
	Setup Appears: <ul style="list-style-type: none"> ▪ In the menu next to the "Setup" selection ▪ At the left in the navigation path in the Setup menu
	Diagnostics Appears: <ul style="list-style-type: none"> ▪ In the menu next to the "Diagnostics" selection ▪ At the left in the navigation path in the Diagnostics menu
	Expert Appears: <ul style="list-style-type: none"> ▪ In the menu next to the "Expert" selection ▪ At the left in the navigation path in the Expert menu



Submenus, wizards, parameters

Symbol	Meaning
	Submenu
	Wizard
	Parameters within a wizard  No display symbol exists for parameters in submenus.

Locking

Symbol	Meaning
	Parameter locked When displayed in front of a parameter name, indicates that the parameter is locked. <ul style="list-style-type: none"> ▪ By a user-specific access code ▪ By the hardware write protection switch

Wizard operation

Symbol	Meaning
	Switches to the previous parameter.
	Confirms the parameter value and switches to the next parameter.
	Opens the editing view of the parameter.

8.3.3 Editing view

Numeric editor

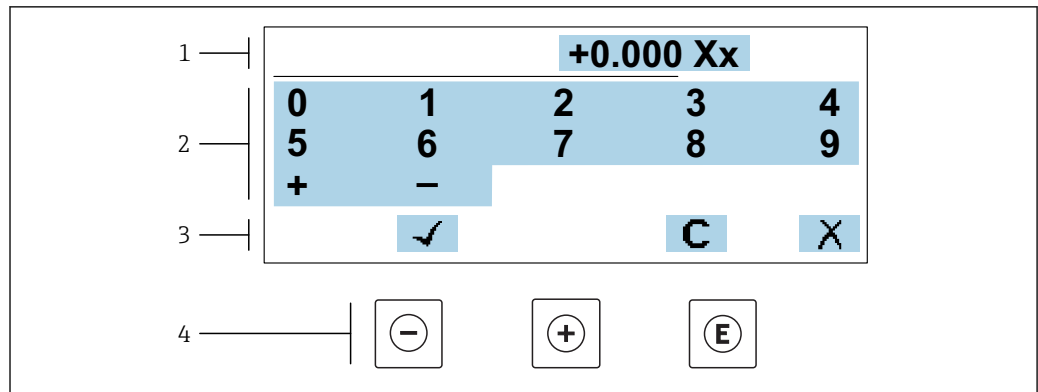

A0034250

24 For entering values in parameters (e.g. limit values)

- 1 Entry display area
- 2 Input screen
- 3 Confirm, delete or reject entry
- 4 Operating elements

Text editor

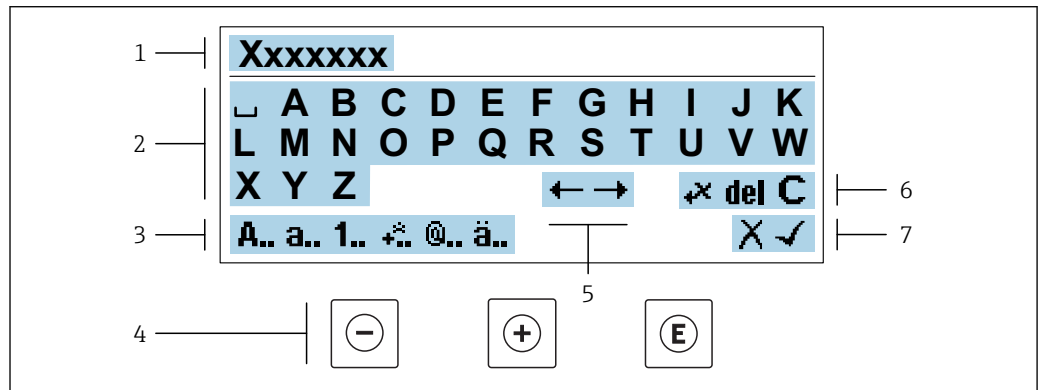





A0034114

25 For entering text in parameters (e.g. tag name)

- 1 Entry display area
- 2 Current input screen
- 3 Change input screen
- 4 Operating elements
- 5 Move entry position
- 6 Delete entry
- 7 Reject or confirm entry





Using the operating elements in the editing view

Operating key(s)	Meaning
	Minus key Move the entry position to the left.
	Plus key Move the entry position to the right.
	Enter key <ul style="list-style-type: none"> ▪ Press the key briefly: confirm your selection. ▪ Press the key for 2 s: confirm the entry.
	Escape key combination (press keys simultaneously) Close the editing view without accepting the changes.





Input screens

Symbol	Meaning
A..	Upper case
a..	Lower case
1..	Numbers
+..	Punctuation marks and special characters: = + - * / ² ³ ¼ ½ ¾ () < > { }
@..	Punctuation marks and special characters: ' " ^ . , ; : ? ! % μ ° € \$ £ ¥ § @ # / \ ~ & _
ä..	Umlauts and accents

Controlling data entries

Symbol	Meaning
	Move entry position
	Reject entry
	Confirm entry
	Delete character immediately to the left of the entry position
del	Delete character immediately to the right of the entry position
C	Clear all the characters entered

8.3.4 Operating elements

Operating key(s)	Meaning
	<p>Minus key</p> <p><i>In a menu, submenu</i> Moves the selection bar upwards in a picklist.</p> <p><i>With a Wizard</i> Confirms the parameter value and goes to the previous parameter.</p> <p><i>With a text and numeric editor</i> Move the entry position to the left.</p>
	<p>Plus key</p> <p><i>In a menu, submenu</i> Moves the selection bar downwards in a picklist.</p> <p><i>With a Wizard</i> Confirms the parameter value and goes to the next parameter.</p> <p><i>With a text and numeric editor</i> Move the entry position to the right.</p>
	<p>Enter key</p> <p><i>For operational display</i> Pressing the key briefly opens the operating menu.</p> <p><i>In a menu, submenu</i></p> <ul style="list-style-type: none"> ▪ Pressing the key briefly: <ul style="list-style-type: none"> ▪ Opens the selected menu, submenu or parameter. ▪ Starts the wizard. ▪ If help text is open, closes the help text of the parameter. ▪ Pressing the key for 2 s for parameter: <ul style="list-style-type: none"> ▪ If present, opens the help text for the function of the parameter. <p><i>With a Wizard</i> Opens the editing view of the parameter.</p> <p><i>With a text and numeric editor</i></p> <ul style="list-style-type: none"> ▪ Press the key briefly: confirm your selection. ▪ Press the key for 2 s: confirm the entry.
	<p>Escape key combination (press keys simultaneously)</p> <p><i>In a menu, submenu</i></p> <ul style="list-style-type: none"> ▪ Pressing the key briefly: <ul style="list-style-type: none"> ▪ Exits the current menu level and takes you to the next higher level. ▪ If help text is open, closes the help text of the parameter. ▪ Pressing the key for 2 s returns you to the operational display ("home position"). <p><i>With a Wizard</i> Exits the wizard and takes you to the next higher level.</p> <p><i>With a text and numeric editor</i> Close the editing view without accepting the changes.</p>
	<p>Minus/Enter key combination (press the keys simultaneously)</p> <ul style="list-style-type: none"> ▪ If the keypad lock is active: <ul style="list-style-type: none"> ▪ Press the key for 3 s: deactivate the keypad lock. ▪ If the keypad lock is not active: <ul style="list-style-type: none"> ▪ Press the key for 3 s: the context menu opens along with the option for activating the keypad lock.



8.3.5 Opening the context menu

Using the context menu, the user can call up the following menus quickly and directly from the operational display:

- Setup
- Data backup
- Simulation



Calling up and closing the context menu

The user is in the operational display.

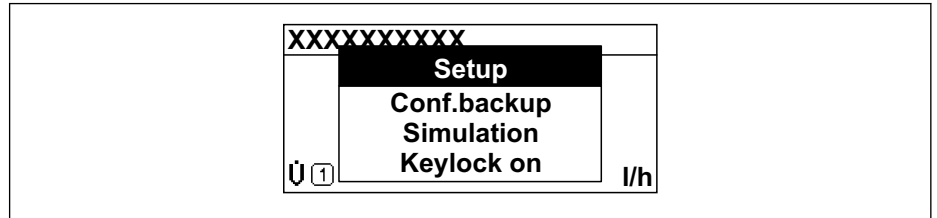

1. Press the  and  keys for longer than 3 seconds.
 - ↳ The context menu opens.



A0034608-EN

2. Press  +  simultaneously.
 - ↳ The context menu is closed and the operational display appears.

Calling up the menu via the context menu

1. Open the context menu.
2. Press  to navigate to the desired menu.
3. Press  to confirm the selection.
 - ↳ The selected menu opens.

8.3.6 Navigating and selecting from list

Different operating elements are used to navigate through the operating menu. The navigation path is displayed on the left in the header. Icons are displayed in front of the individual menus. These icons are also shown in the header during navigation.

i For an explanation of the navigation view with symbols and operating elements → 54

Example: Setting the number of displayed measured values to "2 values"

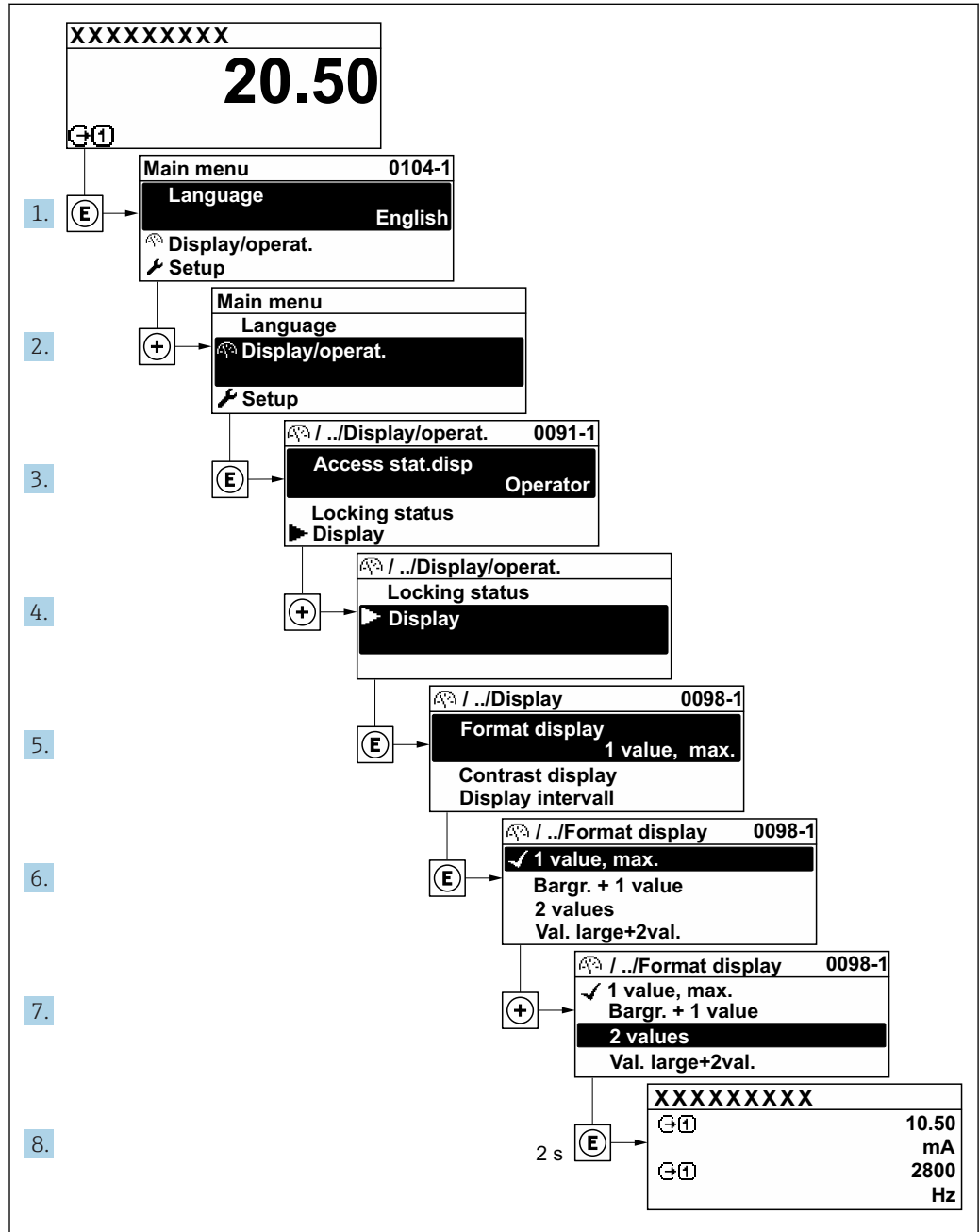

A0029562-EN

8.3.7 Calling the parameter directly

A parameter number is assigned to every parameter to be able to access a parameter directly via the onsite display. Entering this access code in the **Direct access** parameter calls up the desired parameter directly.

Navigation path

Expert → Direct access

The direct access code consists of a 5-digit number (at maximum) and the channel number, which identifies the channel of a process variable: e.g. 00914-2. In the navigation view, this appears on the right-hand side in the header of the selected parameter.

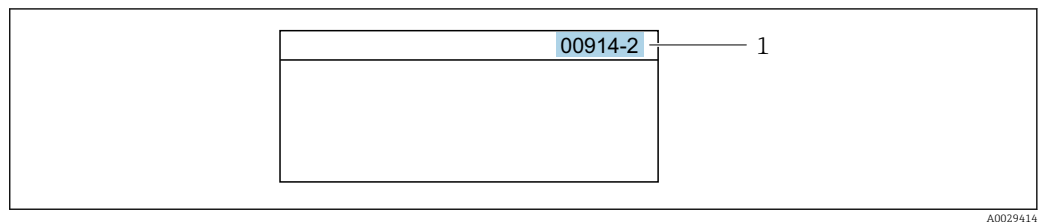

1 Direct access code

Note the following when entering the direct access code:

- The leading zeros in the direct access code do not have to be entered.
Example: Enter "914" instead of "00914"
- If no channel number is entered, channel 1 is accessed automatically.
Example: Enter 00914 → **Assign process variable** parameter
- If a different channel is accessed: Enter the direct access code with the corresponding channel number.
Example: Enter 00914-2 → **Assign process variable** parameter



For the direct access codes of the individual parameters, see the "Description of Device Parameters" document for the device

8.3.8 Calling up help text

Help text is available for some parameters and can be called up from the navigation view. The help text provides a brief explanation of the parameter function and thereby supports swift and safe commissioning.



Calling up and closing the help text

The user is in the navigation view and the selection bar is on a parameter.

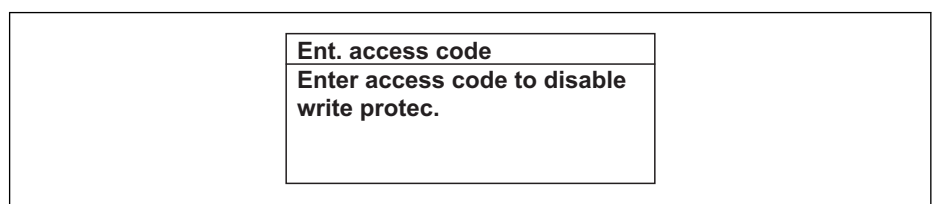
1. Press  for 2 s.
↳ The help text for the selected parameter opens.



 26 Example: Help text for parameter "Enter access code"

2. Press  +  simultaneously.
↳ The help text is closed.

8.3.9 Changing the parameters

Parameters can be changed via the numeric editor or text editor.

- Numeric editor: Change values in a parameter, e.g. specifications for limit values.
- Text editor: Enter text in a parameter, e.g. tag name.

A message is displayed if the value entered is outside the permitted value range.

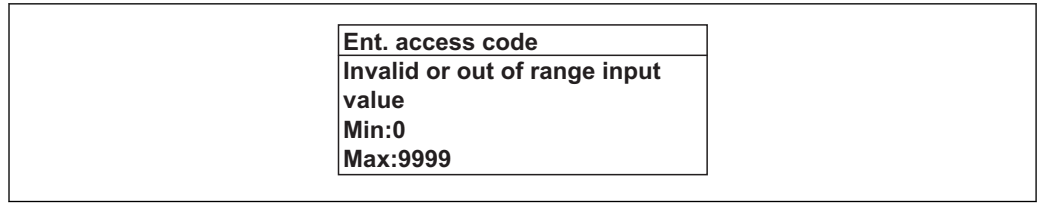

A0014049-EN

i For a description of the editing view - consisting of the text editor and numeric editor - with symbols → 56, for a description of the operating elements → 58

8.3.10 User roles and related access authorization

The two user roles "Operator" and "Maintenance" have different write access to the parameters if the customer defines a user-specific access code. This protects the device configuration via the local display from unauthorized access → 119.

Defining access authorization for user roles

An access code is not yet defined when the device is delivered from the factory. Access authorization (read and write access) to the device is not restricted and corresponds to the "Maintenance" user role.

- ▶ Define the access code.
 - ↳ The "Operator" user role is redefined in addition to the "Maintenance" user role. Access authorization differs for the two user roles.

Access authorization to parameters: "Maintenance" user role

Access code status	Read access	Write access
An access code has not yet been defined (factory setting).	✓	✓
After an access code has been defined.	✓	✓ ¹⁾

1) The user only has write access after entering the access code.

Access authorization to parameters: "Operator" user role

Access code status	Read access	Write access
After an access code has been defined.	✓	-- ¹⁾

1) Despite the defined access code, certain parameters can always be modified and thus are excepted from the write protection, as they do not affect the measurement. Refer to the "Write protection via access code" section

i The user role with which the user is currently logged on is indicated by the **Access status** parameter. Navigation path: Operation → Access status

8.3.11 Disabling write protection via access code

If the -symbol appears on the local display in front of a parameter, the parameter is write-protected by a user-specific access code and its value cannot be changed at the moment using local operation → 119.

Parameter write protection via local operation can be disabled by entering the user-specific access code in the **Enter access code** parameter (→ 106) via the respective access option.

1. After you press , the input prompt for the access code appears.

2. Enter the access code.
 - ↳ The -symbol in front of the parameters disappears; all previously write-protected parameters are now re-enabled.

8.3.12 Enabling and disabling the keypad lock



The keypad lock makes it possible to block access to the entire operating menu via local operation. As a result, it is no longer possible to navigate through the operating menu or change the values of individual parameters. Users can only read the measured values on the operational display.

The keypad lock is switched on and off via the context menu.

Switching on the keypad lock



-  The keypad lock is switched on automatically:
- If the device has not been operated via the display for > 1 minute.
 - Each time the device is restarted.

To activate the keylock manually:

1. The device is in the measured value display.
Press the  and  keys for 3 seconds.
 - ↳ A context menu appears.
2. In the context menu select the **Keylock on** option.
 - ↳ The keypad lock is switched on.

-  If the user attempts to access the operating menu while the keypad lock is active, the **Keylock on** message appears.

Switching off the keypad lock

- ▶ The keypad lock is switched on.
Press the  and  keys for 3 seconds.
 - ↳ The keypad lock is switched off.

8.4 Access to the operating menu via the Web browser

8.4.1 Function range

Thanks to the integrated Web server, the device can be operated and configured via a Web browser and via a service interface (CDI-RJ45) or via a WLAN interface. The structure of the operating menu is the same as for the local display. In addition to the measured values, status information on the device is also displayed and allows the user to monitor the status of the device. Furthermore the device data can be managed and the network parameters can be configured.

A device that has a WLAN interface (can be ordered as an option) is required for the WLAN connection: order code for "Display; operation", option G "4-line, illuminated; touch control + WLAN". The device acts as an Access Point and enables communication by computer or a mobile handheld terminal.

-  For additional information on the Web server, refer to the Special Documentation for the device

8.4.2 Prerequisites



Computer hardware

Hardware	Interface	
	CDI-RJ45	WLAN
Interface	The computer must have an RJ45 interface.	The operating unit must have a WLAN interface.
Connection	Standard Ethernet cable with RJ45 connector.	Connection via Wireless LAN.
Screen	Recommended size: ≥12" (depends on the screen resolution)	

Computer software



Software	Interface	
	CDI-RJ45	WLAN
Recommended operating systems	<ul style="list-style-type: none"> ▪ Microsoft Windows 7 or higher. ▪ Mobile operating systems: <ul style="list-style-type: none"> ▪ iOS ▪ Android <p> Microsoft Windows XP is supported.</p>	
Web browsers supported	<ul style="list-style-type: none"> ▪ Microsoft Internet Explorer 8 or higher ▪ Microsoft Edge ▪ Mozilla Firefox ▪ Google Chrome ▪ Safari 	

Computer settings



Settings	Interface	
	CDI-RJ45	WLAN
User rights	Appropriate user rights (e.g. administrator rights) for TCP/IP and proxy server settings are necessary (for adjusting the IP address, subnet mask etc.).	
Proxy server settings of the Web browser	The Web browser setting <i>Use a Proxy Server for Your LAN</i> must be deselected .	
JavaScript	<p>JavaScript must be enabled.</p> <p> If JavaScript cannot be enabled: enter <code>http://192.168.1.212/basic.html</code> in the address line of the Web browser. A fully functional but simplified version of the operating menu structure starts in the Web browser.</p> <p> When installing a new firmware version: To enable correct data display, clear the temporary memory (cache) of the Web browser under Internet options.</p>	
Network connections	Only the active network connections to the measuring device should be used.	
	Switch off all other network connections such as WLAN.	Switch off all other network connections.

 In the event of connection problems: →  133

Measuring device: Via CDI-RJ45 service interface

Device	CDI-RJ45 service interface
Measuring device	The measuring device has an RJ45 interface.
Web server	Web server must be enabled; factory setting: ON  For information on enabling the Web server →  69

Measuring device: via WLAN interface

Device	WLAN interface
Measuring device	The measuring device has a WLAN antenna: <ul style="list-style-type: none"> ▪ Transmitter with integrated WLAN antenna ▪ Transmitter with external WLAN antenna
Web server	Web server and WLAN must be enabled; factory setting: ON  For information on enabling the Web server →  69

8.4.3 Establishing a connection

Via service interface (CDI-RJ45)

Preparing the measuring device

1. Depending on the housing version:
Release the securing clamp or securing screw of the housing cover.
2. Depending on the housing version:
Unscrew or open the housing cover.
3. The location of the connection socket depends on the measuring device and the communication protocol:
Connect the computer to the RJ45 connector via the standard Ethernet connecting cable .

Configuring the Internet protocol of the computer

The following information refers to the default Ethernet settings of the device.

IP address of the device: 192.168.1.212 (factory setting)

1. Switch on the measuring device.
2. Connect to the computer using a cable →  71.
3. If a 2nd network card is not used, close all the applications on the notebook.
 - ↳ Applications requiring Internet or a network, such as e-mail, SAP applications, Internet or Windows Explorer.
4. Close any open Internet browsers.
5. Configure the properties of the Internet protocol (TCP/IP) as defined in the table:

IP address	192.168.1.XXX; for XXX all numerical sequences except: 0, 212 and 255 → e.g. 192.168.1.213
Subnet mask	255.255.255.0
Default gateway	192.168.1.212 or leave cells empty

Via WLAN interface

Configuring the Internet protocol of the mobile terminal

NOTICE

If the WLAN connection is lost during the configuration, settings made may be lost.

- ▶ Make sure that the WLAN connection is not disconnected while configuring the device.

NOTICE

In principle, avoid simultaneous access to the measuring device via the service interface (CDI-RJ45) and the WLAN interface from the same mobile terminal. This could cause a network conflict.

- ▶ Only activate one service interface (CDI-RJ45 service interface or WLAN interface).
- ▶ If simultaneous communication is necessary: configure different IP address ranges, e.g. 192.168.0.1 (WLAN interface) and 192.168.1.212 (CDI-RJ45 service interface).

Preparing the mobile terminal

- ▶ Enable WLAN reception on the mobile terminal.

Establishing a connection from the mobile terminal to the measuring device

1. In the WLAN settings of the mobile terminal:
Select the measuring device using the SSID (e.g. EH_Promag_300_A802000).
2. If necessary, select the WPA2 encryption method.
3. Enter the password: serial number of the measuring device ex-works (e.g. L100A802000).
 - ↳ LED on display module flashes: it is now possible to operate the measuring device with the Web browser, FieldCare or DeviceCare.

 The serial number can be found on the nameplate.

 To ensure the safe and swift assignment of the WLAN network to the measuring point, it is advisable to change the SSID name. It should be possible to clearly assign the new SSID name to the measuring point (e.g. tag name) because it is displayed as the WLAN network.

Disconnecting

- ▶ After configuring the device:
Terminate the WLAN connection between the operating unit and measuring device.

Starting the Web browser

1. Start the Web browser on the computer.

2. Enter the IP address of the Web server in the address line of the Web browser:
192.168.1.212
↳ The login page appears.

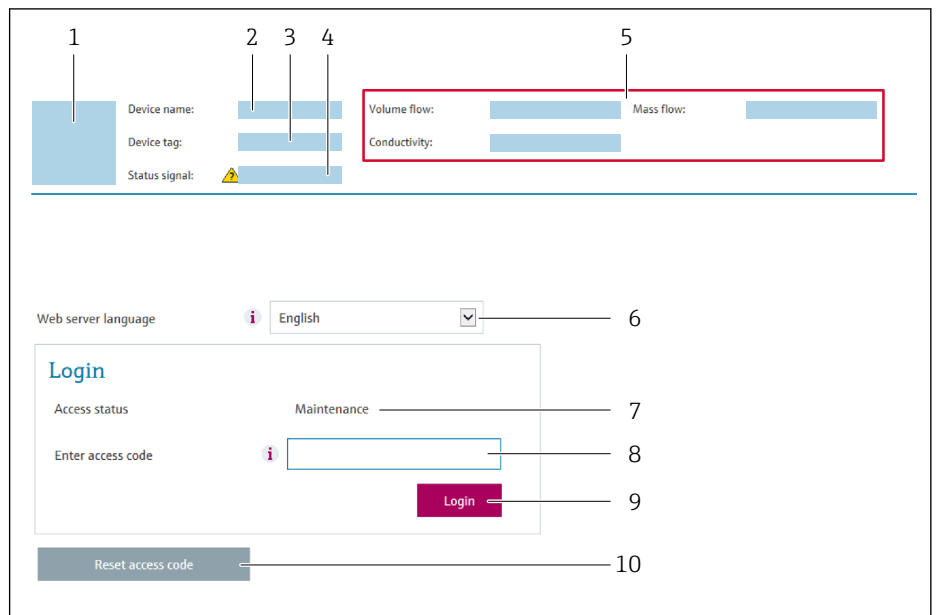

A0029417

- 1 Picture of device
- 2 Device name
- 3 Device tag (→ 83)
- 4 Status signal
- 5 Current measured values
- 6 Operating language
- 7 User role
- 8 Access code
- 9 Login
- 10 Reset access code (→ 116)

i If a login page does not appear, or if the page is incomplete → 133

8.4.4 Logging on

1. Select the preferred operating language for the Web browser.
2. Enter the user-specific access code.
3. Press **OK** to confirm your entry.

Access code	0000 (factory setting); can be changed by customer
--------------------	--

i If no action is performed for 10 minutes, the Web browser automatically returns to the login page.

8.4.5 User interface

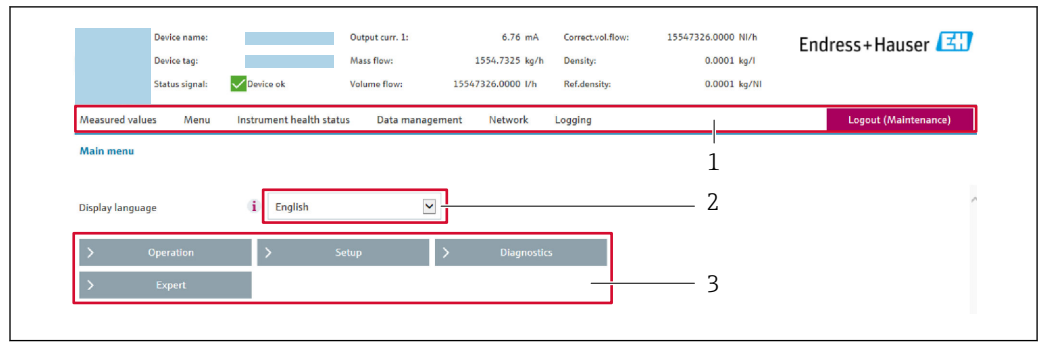

- 1 Function row
- 2 Local display language
- 3 Navigation area

Header

The following information appears in the header:

- Device name
- Device tag
- Device status with status signal → 📄 139
- Current measured values

Function row

Functions	Meaning
Measured values	Displays the measured values of the measuring device
Menu	<ul style="list-style-type: none"> ■ Access to the operating menu from the measuring device ■ The structure of the operating menu is the same as for the local display  For detailed information on the structure of the operating menu, see the Operating Instructions for the measuring device
Device status	Displays the diagnostic messages currently pending, listed in order of priority
Data management	Data exchange between PC and measuring device: <ul style="list-style-type: none"> ■ Device configuration: <ul style="list-style-type: none"> ■ Load settings from the device (XML format, save configuration) ■ Save settings to the device (XML format, restore configuration) ■ Logbook - Export Event logbook (.csv file) ■ Documents - Export documents: <ul style="list-style-type: none"> ■ Export backup data record (.csv file, create documentation of the measuring point configuration) ■ Verification report (PDF file, only available with the "Heartbeat Verification" application package) ■ Firmware update - Flashing a firmware version
Network configuration	Configuration and checking of all the parameters required for establishing the connection to the measuring device: <ul style="list-style-type: none"> ■ Network settings (e.g. IP address, MAC address) ■ Device information (e.g. serial number, firmware version)
Logout	End the operation and call up the login page

Navigation area

If a function is selected in the function bar, the submenus of the function open in the navigation area. The user can now navigate through the menu structure.

Working area

Depending on the selected function and the related submenus, various actions can be performed in this area:

- Configuring parameters
- Reading measured values
- Calling up help text
- Starting an upload/download

8.4.6 Disabling the Web server

The Web server of the measuring device can be switched on and off as required using the **Web server functionality** parameter.

Navigation

"Expert" menu → Communication → Web server

Parameter overview with brief description

Parameter	Description	Selection	Factory setting
Web server functionality	Switch the Web server on and off.	<ul style="list-style-type: none"> ■ Off ■ HTML Off ■ On 	On

Function scope of the "Web server functionality" parameter

Option	Description
Off	<ul style="list-style-type: none"> ■ The web server is completely disabled. ■ Port 80 is locked.
On	<ul style="list-style-type: none"> ■ The complete functionality of the web server is available. ■ JavaScript is used. ■ The password is transferred in an encrypted state. ■ Any change to the password is also transferred in an encrypted state.

Enabling the Web server

If the Web server is disabled it can only be re-enabled with the **Web server functionality** parameter via the following operating options:

- Via local display
- Via Bedientool "FieldCare"
- Via "DeviceCare" operating tool

8.4.7 Logging out

 Before logging out, perform a data backup via the **Data management** function (upload configuration from device) if necessary.

1. Select the **Logout** entry in the function row.
 - ↳ The home page with the Login box appears.
2. Close the Web browser.
3. If no longer needed:
 - Reset modified properties of the Internet protocol (TCP/IP) →  65.

8.5 Access to the operating menu via the operating tool

The structure of the operating menu in the operating tools is the same as for operation via the local display.

8.5.1 Connecting the operating tool

Via HART protocol

This communication interface is available in device versions with a HART output.

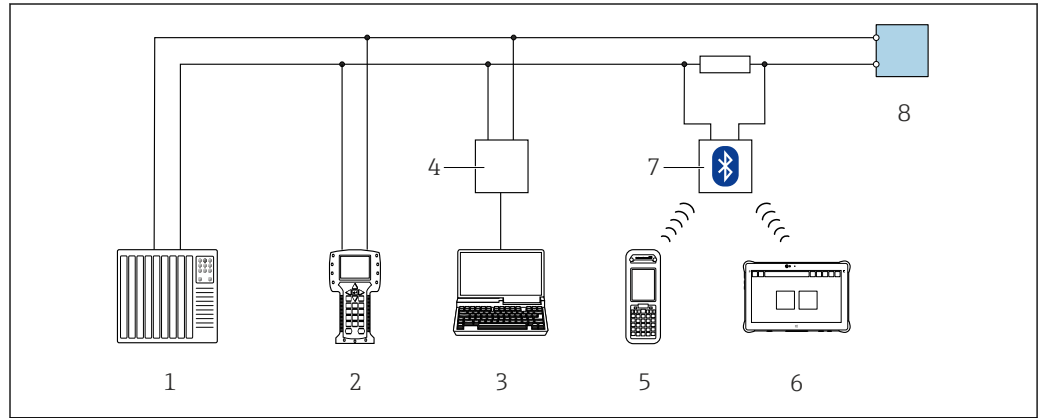

27 Options for remote operation via HART protocol (active)

- 1 Control system (e.g. PLC)
- 2 Field Communicator 475
- 3 Computer with Web browser (e.g. Internet Explorer) for access to the integrated device Web server or computer with an operating tool (e.g. FieldCare, DeviceCare, AMS Device Manager, SIMATIC PDM) with COM DTM "CDI Communication TCP/IP"
- 4 Commubox FXA 195 (USB)
- 5 Field Xpert SFX350 or SFX370
- 6 Field Xpert SMT70
- 7 VIATOR Bluetooth modem with connecting cable
- 8 Transmitter

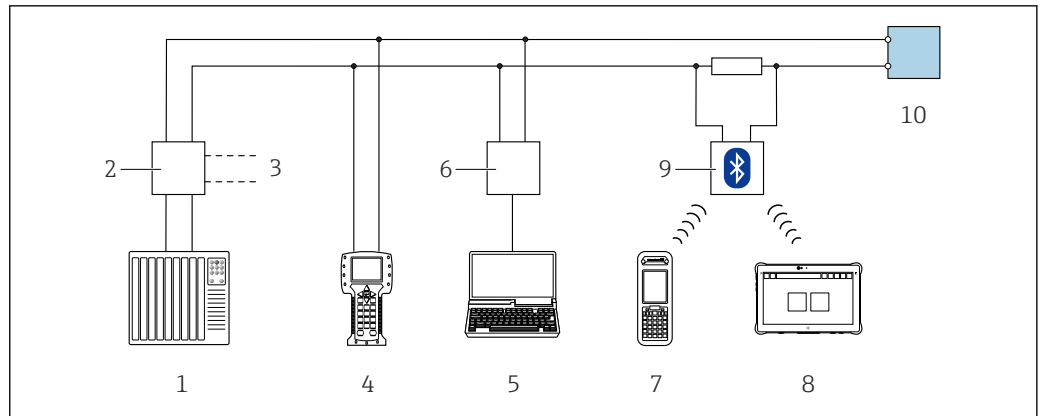

A0028746

28 Options for remote operation via HART protocol (passive)

- 1 Control system (e.g. PLC)
- 2 Transmitter power supply unit, e.g. RN221N (with communication resistor)
- 3 Connection for Commubox FXA195 and Field Communicator 475
- 4 Field Communicator 475
- 5 Computer with Web browser (e.g. Internet Explorer) for access to the integrated device Web server or computer with an operating tool (e.g. FieldCare, DeviceCare, AMS Device Manager, SIMATIC PDM) with COM DTM "CDI Communication TCP/IP"
- 6 Commubox FXA195 (USB)
- 7 Field Xpert SFX350 or SFX370
- 8 Field Xpert SMT70
- 9 VIATOR Bluetooth modem with connecting cable
- 10 Transmitter

Service interface

Via service interface (CDI-RJ45)

A point-to-point connection can be established to configure the device onsite. With the housing open, the connection is established directly via the service interface (CDI-RJ45) of the device.

i An adapter for RJ45 and the M12 connector is optionally available:
Order code for "Accessories", option **NB**: "Adapter RJ45 M12 (service interface)"

The adapter connects the service interface (CDI-RJ45) to an M12 connector mounted in the cable entry. Therefore the connection to the service interface can be established via an M12 connector without opening the device.

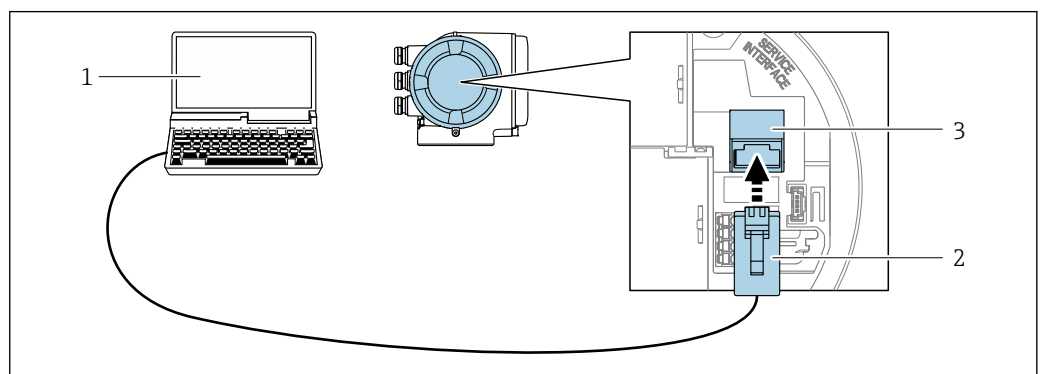

A0027563

29 Connection via service interface (CDI-RJ45)

- 1 Computer with Web browser (e.g. Microsoft Internet Explorer, Microsoft Edge) for accessing the integrated device Web server or with "FieldCare", "DeviceCare" operating tool with COM DTM "CDI Communication TCP/IP"
- 2 Standard Ethernet connecting cable with RJ45 connector
- 3 Service interface (CDI-RJ45) of the measuring device with access to the integrated Web server

Via WLAN interface

The optional WLAN interface is available on the following device version:

Order code for "Display; operation", option G "4-line, illuminated; touch control + WLAN"

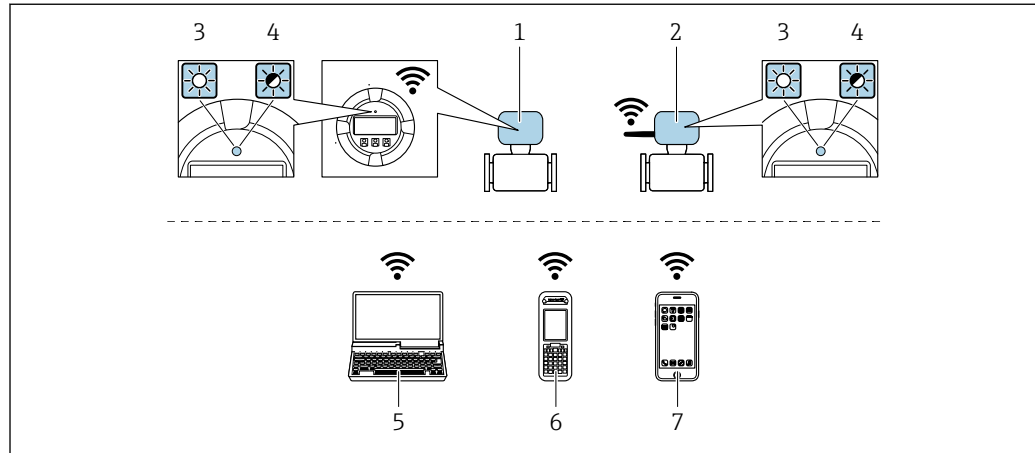

A0034570

- 1 Transmitter with integrated WLAN antenna
- 2 Transmitter with external WLAN antenna
- 3 LED lit constantly: WLAN reception is enabled on measuring device
- 4 LED flashing: WLAN connection established between operating unit and measuring device
- 5 Computer with WLAN interface and Web browser (e.g. Microsoft Internet Explorer, Microsoft Edge) for accessing the integrated device Web server or with operating tool (e.g. FieldCare, DeviceCare)
- 6 Mobile handheld terminal with WLAN interface and Web browser (e.g. Microsoft Internet Explorer, Microsoft Edge) for accessing the integrated device Web server or operating tool (e.g. FieldCare, DeviceCare)
- 7 Smart phone or tablet (e.g. Field Xpert SMT70)

Function	WLAN: IEEE 802.11 b/g (2.4 GHz)
Encryption	WPA2-PSK AES-128 (in accordance with IEEE 802.11i)
Configurable WLAN channels	1 to 11
Degree of protection	IP67
Available antennas	<ul style="list-style-type: none"> ▪ Internal antenna ▪ External antenna (optional) <p>In the event of poor transmission/reception conditions at the place of installation.</p> <p> Only one antenna active in each case!</p>
Range	<ul style="list-style-type: none"> ▪ Internal antenna: typically 10 m (32 ft) ▪ External antenna: typically 50 m (164 ft)
Materials (external antenna)	<ul style="list-style-type: none"> ▪ Antenna: ASA plastic (acrylic ester-styrene-acrylonitrile) and nickel-plated brass ▪ Adapter: Stainless steel and nickel-plated brass ▪ Cable: Polyethylene ▪ Connector: Nickel-plated brass ▪ Angle bracket: Stainless steel

Configuring the Internet protocol of the mobile terminal

NOTICE

If the WLAN connection is lost during the configuration, settings made may be lost.

- ▶ Make sure that the WLAN connection is not disconnected while configuring the device.

NOTICE

In principle, avoid simultaneous access to the measuring device via the service interface (CDI-RJ45) and the WLAN interface from the same mobile terminal. This could cause a network conflict.

- ▶ Only activate one service interface (CDI-RJ45 service interface or WLAN interface).
- ▶ If simultaneous communication is necessary: configure different IP address ranges, e.g. 192.168.0.1 (WLAN interface) and 192.168.1.212 (CDI-RJ45 service interface).

Preparing the mobile terminal

- ▶ Enable WLAN reception on the mobile terminal.

Establishing a connection from the mobile terminal to the measuring device

1. In the WLAN settings of the mobile terminal:
Select the measuring device using the SSID (e.g. EH_Promag_300_A802000).
2. If necessary, select the WPA2 encryption method.
3. Enter the password: serial number of the measuring device ex-works (e.g. L100A802000).
 - ↳ LED on display module flashes: it is now possible to operate the measuring device with the Web browser, FieldCare or DeviceCare.



The serial number can be found on the nameplate.



To ensure the safe and swift assignment of the WLAN network to the measuring point, it is advisable to change the SSID name. It should be possible to clearly assign the new SSID name to the measuring point (e.g. tag name) because it is displayed as the WLAN network.

Disconnecting

- ▶ After configuring the device:
Terminate the WLAN connection between the operating unit and measuring device.

8.5.2 Field Xpert SFX350, SFX370**Function range**

Field Xpert SFX350 and Field Xpert SFX370 are mobile computers for commissioning and maintenance. They enable efficient device configuration and diagnostics for HART and FOUNDATION Fieldbus devices in the **non-hazardous area** (SFX350, SFX370) and **hazardous area** (SFX370).



For details, see Operating Instructions BA01202S



Source for device description files

See information → 77

8.5.3 FieldCare**Function scope**

FDT-based plant asset management tool from Endress+Hauser. It can configure all smart field devices in a system and helps you manage them. By using the status information, it is also a simple but effective way of checking their status and condition.

Access is via:

- HART protocol
- CDI-RJ45 service interface →  71
- WLAN interface →  72

Typical functions:

- Configuring parameters of transmitters
- Loading and saving device data (upload/download)
- Documentation of the measuring point
- Visualization of the measured value memory (line recorder) and event logbook

 For additional information about FieldCare, see Operating Instructions BA00027S and BA00059S

Source for device description files

See information →  77

Establishing a connection

1. Start FieldCare and launch the project.
2. In the network: Add a device.
 - ↳ The **Add device** window opens.
3. Select the **CDI Communication TCP/IP** option from the list and press **OK** to confirm.
4. Right-click **CDI Communication TCP/IP** and select the **Add device** option in the context menu that opens.
5. Select the desired device from the list and press **OK** to confirm.
 - ↳ The **CDI Communication TCP/IP (Configuration)** window opens.
6. Enter the device address in the **IP address** field: 192.168.1.212 and press **Enter** to confirm.
7. Establish the online connection to the device.

 For additional information, see Operating Instructions BA00027S and BA00059S

User interface

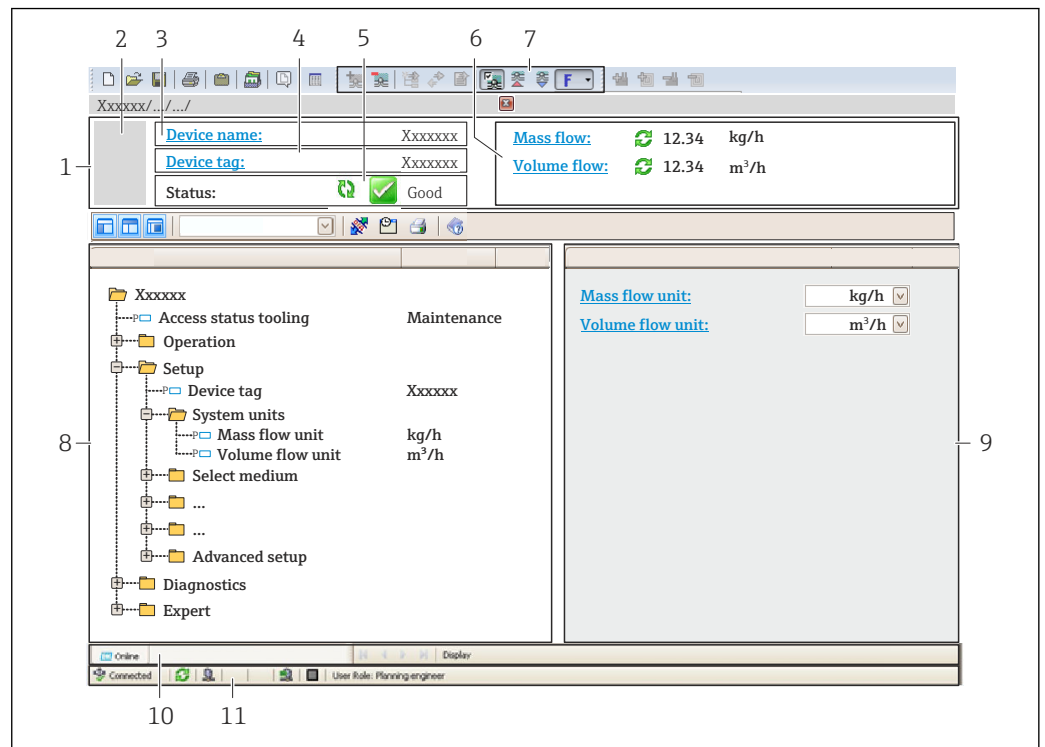

A0021051-EN

- 1 Header
- 2 Picture of device
- 3 Device name
- 4 Device tag
- 5 Status area with status signal → 139
- 6 Display area for current measured values
- 7 Edit toolbar with additional functions such as save/restore, event list and create documentation
- 8 Navigation area with operating menu structure
- 9 Working area
- 10 Range of action
- 11 Status area

8.5.4 DeviceCare

Function scope

Tool to connect and configure Endress+Hauser field devices.

The fastest way to configure Endress+Hauser field devices is with the dedicated "DeviceCare" tool. Together with the device type managers (DTMs) it presents a convenient, comprehensive solution.

 For details, see Innovation Brochure IN01047S

Source for device description files

See information → 77

8.5.5 AMS Device Manager

Function scope

Program from Emerson Process Management for operating and configuring measuring devices via HART protocol.

Source for device description files

See data →  77

8.5.6 SIMATIC PDM**Function scope**

SIMATIC PDM is a standardized, manufacturer-independent program from Siemens for the operation, configuration, maintenance and diagnosis of intelligent field devices via HART protocol.

Source for device description files

See data →  77

8.5.7 Field Communicator 475**Function scope**

Industrial handheld terminal from Emerson Process Management for remote configuration and measured value display via HART protocol.

Source for device description files

See data →  77

9 System integration

9.1 Overview of device description files

9.1.1 Current version data for the device

Firmware version	01.05.zz	<ul style="list-style-type: none"> ▪ On the title page of the Operating Instructions ▪ On the transmitter nameplate ▪ Firmware version Diagnostics → Device information → Firmware version
Release date of firmware version	08.2019	---
Manufacturer ID	0x11	Manufacturer ID Diagnostics → Device information → Manufacturer ID
Device type ID	0x3C	Device type Diagnostics → Device information → Device type
HART protocol revision	7	HART revision Expert → Communication → HART output → Information → HART revision
Device revision	1	<ul style="list-style-type: none"> ▪ On the transmitter nameplate ▪ Device revision Diagnostics → Device information → Device revision



For an overview of the different firmware versions for the device → 153

9.1.2 Operating tools

The suitable device description file for the individual operating tools is listed in the table below, along with information on where the file can be acquired.

Operating tool via HART protocol	Sources for obtaining device descriptions
FieldCare	<ul style="list-style-type: none"> ▪ www.endress.com → Download Area ▪ CD-ROM (contact Endress+Hauser) ▪ DVD (contact Endress+Hauser)
DeviceCare	<ul style="list-style-type: none"> ▪ www.endress.com → Download Area ▪ CD-ROM (contact Endress+Hauser) ▪ DVD (contact Endress+Hauser)
<ul style="list-style-type: none"> ▪ Field Xpert SFX350 ▪ Field Xpert SFX370 	Use update function of handheld terminal
AMS Device Manager (Emerson Process Management)	www.endress.com → Download Area
SIMATIC PDM (Siemens)	www.endress.com → Download Area
Field Communicator 475 (Emerson Process Management)	Use update function of handheld terminal

9.2 Measured variables via HART protocol

The following measured variables (HART device variables) are assigned to the dynamic variables at the factory:

Dynamic variables	Measured values (HART device variables)
Primary dynamic variable (PV)	Volume flow
Secondary dynamic variable (SV)	Totalizer 1
Tertiary dynamic variable (TV)	Totalizer 2
Quaternary dynamic variable (QV)	Totalizer 3

The assignment of the measured variables to the dynamic variables can be modified and assigned as desired via local operation and the operating tool using the following parameters:

- Expert → Communication → HART output → Output → Assign PV
- Expert → Communication → HART output → Output → Assign SV
- Expert → Communication → HART output → Output → Assign TV
- Expert → Communication → HART output → Output → Assign QV

The following measured variables can be assigned to the dynamic variables:

Measured variables for PV (primary dynamic variable)

- Off
- Volume flow
- Mass flow
- Corrected volume flow
- Flow velocity
- Conductivity ¹⁾
- Electronic temperature

Measured variables for SV, TV, QV (secondary, tertiary and quaternary dynamic variable)

- Volume flow
- Mass flow
- Corrected volume flow
- Flow velocity
- Conductivity ²⁾
- Electronic temperature
- Totalizer 1
- Totalizer 2
- Totalizer 3



The range of options increases if the measuring device has one or more application packages.

Device variables

The device variables are permanently assigned. A maximum of 8 device variables can be transmitted:

- 0 = volume flow
- 1 = mass flow
- 2 = corrected volume flow
- 3 = flow velocity
- 4 = conductivity
- 7 = electronic temperature
- 8 = totalizer 1
- 9 = totalizer 2
- 10 = totalizer 3

1) Visibility depends on order options or device settings

2) Visibility depends on order options or device settings

9.3 Other settings

Burst mode functionality in accordance with HART 7 Specification:

Navigation

"Expert" menu → Communication → HART output → Burst configuration → Burst configuration 1 to n

▶ Burst configuration

▶ Burst configuration 1 to n

Burst mode 1 to n	→ ⓘ 79
Burst command 1 to n	→ ⓘ 79
Burst variable 0	→ ⓘ 80
Burst variable 1	→ ⓘ 80
Burst variable 2	→ ⓘ 80
Burst variable 3	→ ⓘ 80
Burst variable 4	→ ⓘ 80
Burst variable 5	→ ⓘ 80
Burst variable 6	→ ⓘ 80
Burst variable 7	→ ⓘ 80
Burst trigger mode	→ ⓘ 80
Burst trigger level	→ ⓘ 80
Min. update period	→ ⓘ 80
Max. update period	→ ⓘ 80

Parameter overview with brief description

Parameter	Description	Selection / User entry	Factory setting
Burst mode 1 to n	Activate the HART burst mode for burst message X.	<ul style="list-style-type: none"> ■ Off ■ On 	Off
Burst command 1 to n	Select the HART command that is sent to the HART master.	<ul style="list-style-type: none"> ■ Command 1 ■ Command 2 ■ Command 3 ■ Command 9 ■ Command 33 ■ Command 48 	Command 2

Parameter	Description	Selection / User entry	Factory setting
Burst variable 0	For HART command 9 and 33: select the HART device variable or the process variable.	<ul style="list-style-type: none"> ■ Volume flow ■ Mass flow ■ Corrected volume flow ■ Flow velocity ■ Conductivity* ■ Electronic temperature ■ Totalizer 1 ■ Totalizer 2 ■ Totalizer 3 ■ Density ■ HART input ■ Percent of range ■ Measured current ■ Primary variable (PV) ■ Secondary variable (SV) ■ Tertiary variable (TV) ■ Quaternary variable (QV) ■ Not used 	Volume flow
Burst variable 1	For HART command 9 and 33: select the HART device variable or the process variable.	See the Burst variable 0 parameter.	Not used
Burst variable 2	For HART command 9 and 33: select the HART device variable or the process variable.	See the Burst variable 0 parameter.	Not used
Burst variable 3	For HART command 9 and 33: select the HART device variable or the process variable.	See the Burst variable 0 parameter.	Not used
Burst variable 4	For HART command 9: select the HART device variable or the process variable.	See the Burst variable 0 parameter.	Not used
Burst variable 5	For HART command 9: select the HART device variable or the process variable.	See the Burst variable 0 parameter.	Not used
Burst variable 6	For HART command 9: select the HART device variable or the process variable.	See the Burst variable 0 parameter.	Not used
Burst variable 7	For HART command 9: select the HART device variable or the process variable.	See the Burst variable 0 parameter.	Not used
Burst trigger mode	Select the event that triggers burst message X.	<ul style="list-style-type: none"> ■ Continuous ■ Window* ■ Rising* ■ Falling* ■ On change 	Continuous
Burst trigger level	Enter the burst trigger value. Together with the option selected in the Burst trigger mode parameter the burst trigger value determines the time of burst message X.	Signed floating-point number	–
Min. update period	Enter the minimum time span between two burst commands of burst message X.	Positive integer	1 000 ms
Max. update period	Enter the maximum time span between two burst commands of burst message X.	Positive integer	2 000 ms

* Visibility depends on order options or device settings

10 Commissioning

10.1 Function check

Before commissioning the measuring device:

- ▶ Make sure that the post-installation and post-connection checks have been performed.
- "Post-installation check" checklist → 35
- "Post-connection check" checklist → 49

10.2 Switching on the measuring device

- ▶ After a successful function check, switch on the measuring device.
 - ↳ After a successful startup, the local display switches automatically from the startup display to the operational display.

If nothing appears on the local display or a diagnostic message is displayed, refer to the section on "Diagnostics and troubleshooting" → 132.

10.3 Setting the operating language

Factory setting: English or ordered local language

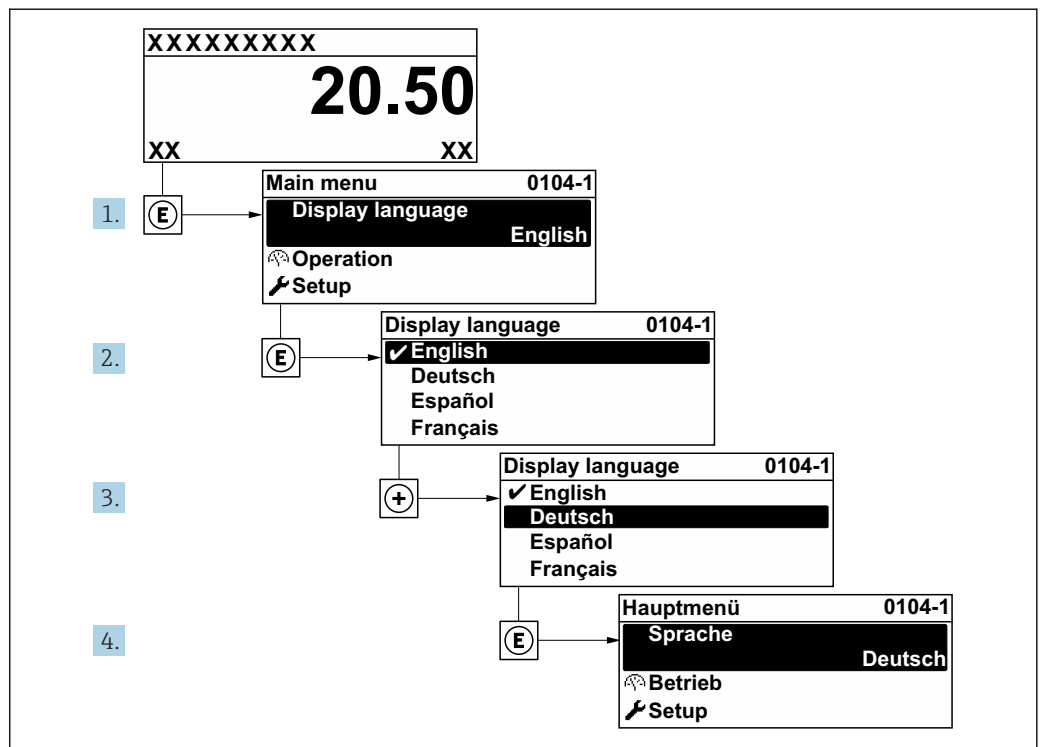

30 Taking the example of the local display

A0029420

10.4 Configuring the measuring device

- The **Setup** menu with its guided wizards contains all the parameters needed for standard operation.
- Navigation to the **Setup** menu

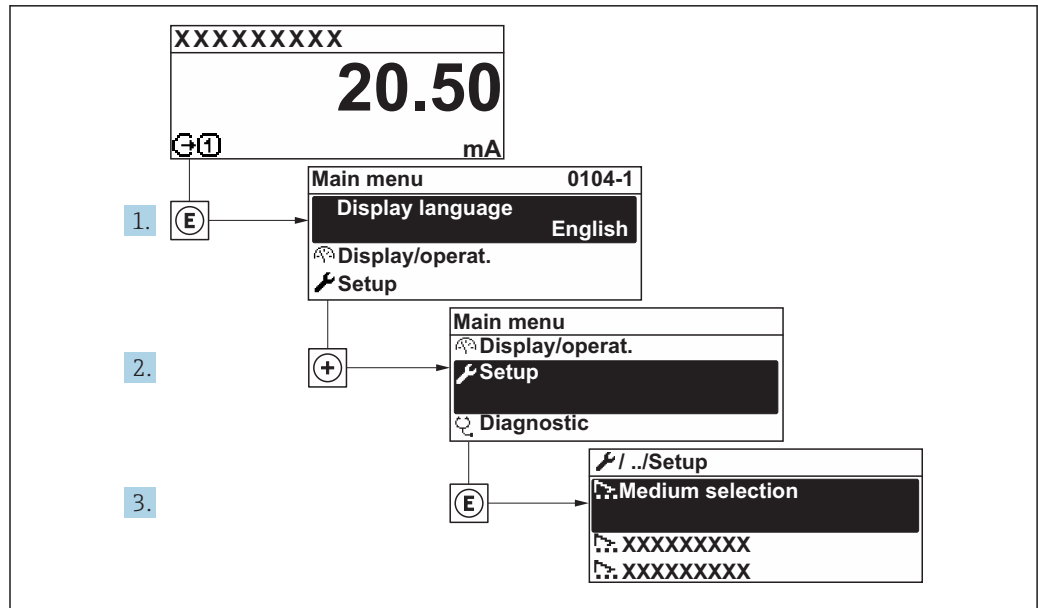

A0032222-EN

31 Taking the example of the local display

i The number of submenus and parameters can vary depending on the device version. Certain submenus and parameters in these submenus are not described in the Operation Instructions. Instead a description is provided in the Special Documentation for the device (→ "Supplementary documentation" section).

🔧 Setup	
Device tag	→ 83
▶ System units	→ 83
▶ I/O configuration	→ 84
▶ Current input 1 to n	→ 86
▶ Status input 1 to n	→ 85
▶ Current output 1 to n	→ 87
▶ Pulse/frequency/switch output 1 to n	→ 90
▶ Relay output 1 to n	→ 101
▶ Double pulse output	→ 103
▶ Display	→ 96
▶ Low flow cut off	→ 97

▶ Empty pipe detection	→ 99
▶ Advanced setup	→ 105

10.4.1 Defining the tag name

To enable fast identification of the measuring point within the system, you can enter a unique designation using the **Device tag** parameter and thus change the factory setting.

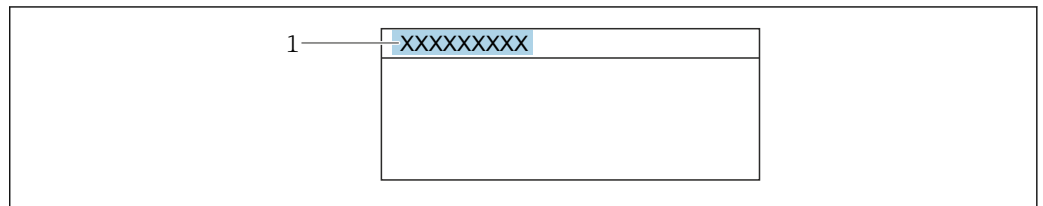

32 Header of the operational display with tag name

1 Tag name

i Enter the tag name in the "FieldCare" operating tool → 75

Navigation

"Setup" menu → Device tag

Parameter overview with brief description

Parameter	Description	User entry	Factory setting
Device tag	Enter the name for the measuring point.	Max. 32 characters, such as letters, numbers or special characters (e.g. @, %, /).	Promag

10.4.2 Setting the system units

In the **System units** submenu the units of all the measured values can be set.

i The number of submenus and parameters can vary depending on the device version. Certain submenus and parameters in these submenus are not described in the Operation Instructions. Instead a description is provided in the Special Documentation for the device (→ "Supplementary documentation" section).

Navigation

"Setup" menu → System units

▶ System units	
Volume flow unit	→ 84
Volume unit	→ 84
Conductivity unit	
Temperature unit	→ 84

Mass flow unit	→ 84
Mass unit	→ 84
Density unit	→ 84
Corrected volume flow unit	
Corrected volume unit	

Parameter overview with brief description

Parameter	Description	Selection	Factory setting
Volume flow unit	Select volume flow unit. <i>Result</i> The selected unit applies for: <ul style="list-style-type: none"> ▪ Output ▪ Low flow cut off ▪ Simulation process variable 	Unit choose list	Country-specific: <ul style="list-style-type: none"> ▪ l/h ▪ gal/min (us)
Volume unit	Select volume unit.	Unit choose list	Country-specific: <ul style="list-style-type: none"> ▪ m³ ▪ gal (us)
Temperature unit	Select temperature unit. <i>Result</i> The selected unit applies for: <ul style="list-style-type: none"> ▪ Temperature parameter ▪ Maximum value parameter ▪ Minimum value parameter ▪ External temperature parameter ▪ Maximum value parameter ▪ Minimum value parameter 	Unit choose list	Country-specific: <ul style="list-style-type: none"> ▪ °C ▪ °F
Mass flow unit	Select mass flow unit. <i>Result</i> The selected unit applies for: <ul style="list-style-type: none"> ▪ Output ▪ Low flow cut off ▪ Simulation process variable 	Unit choose list	Country-specific: <ul style="list-style-type: none"> ▪ kg/h ▪ lb/min
Mass unit	Select mass unit.	Unit choose list	Country-specific: <ul style="list-style-type: none"> ▪ kg ▪ lb
Density unit	Select density unit. <i>Result</i> The selected unit applies for: <ul style="list-style-type: none"> ▪ Output ▪ Simulation process variable 	Unit choose list	Country-specific: <ul style="list-style-type: none"> ▪ kg/l ▪ lb/ft³

10.4.3 Displaying the I/O configuration

The **I/O configuration** submenu guides the user systematically through all the parameters in which the configuration of the I/O modules is displayed.

Navigation
 "Setup" menu → I/O configuration

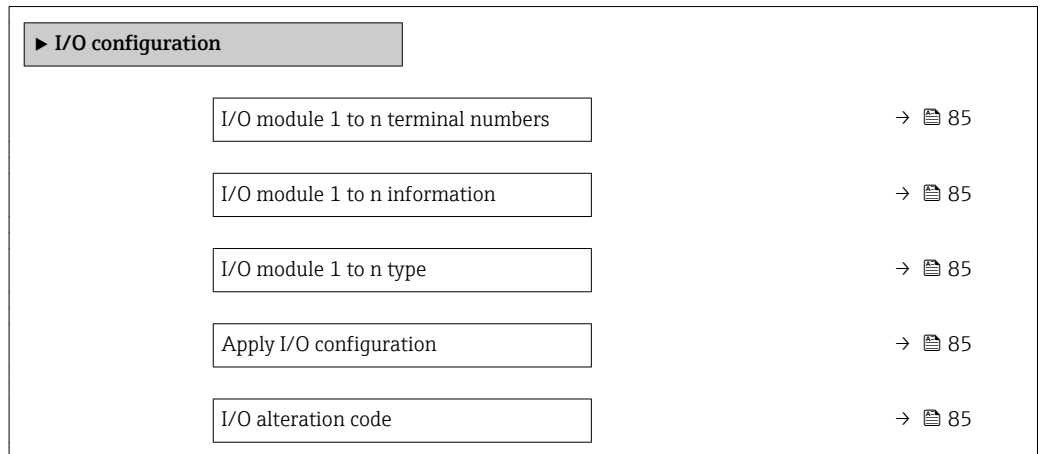

Parameter overview with brief description

Parameter	Description	User interface / Selection / User entry	Factory setting
I/O module 1 to n terminal numbers	Shows the terminal numbers used by the I/O module.	<ul style="list-style-type: none"> ■ Not used ■ 26-27 (I/O 1) ■ 24-25 (I/O 2) ■ 22-23 (I/O 3) 	–
I/O module 1 to n information	Shows information of the plugged I/O module.	<ul style="list-style-type: none"> ■ Not plugged ■ Invalid ■ Not configurable ■ Configurable ■ HART 	–
I/O module 1 to n type	Shows the I/O module type.	<ul style="list-style-type: none"> ■ Off ■ Current output * ■ Current input * ■ Status input * ■ Pulse/frequency/switch output * ■ Double pulse output * ■ Relay output * 	Off
Apply I/O configuration	Apply parameterization of the freely configurable I/O module.	<ul style="list-style-type: none"> ■ No ■ Yes 	No
I/O alteration code	Enter the code in order to change the I/O configuration.	Positive integer	0

* Visibility depends on order options or device settings

10.4.4 Configuring the status input

The **Status input** submenu guides the user systematically through all the parameters that have to be set for configuring the status input.

Navigation

"Setup" menu → Status input

► Status input 1 to n	
Assign status input	→ 86
Terminal number	→ 86
Active level	→ 86
Terminal number	→ 86
Response time status input	→ 86
Terminal number	→ 86

Parameter overview with brief description

Parameter	Description	User interface / Selection / User entry	Factory setting
Terminal number	Shows the terminal numbers used by the status input module.	<ul style="list-style-type: none"> ▪ Not used ▪ 24-25 (I/O 2) ▪ 22-23 (I/O 3) 	–
Assign status input	Select function for the status input.	<ul style="list-style-type: none"> ▪ Off ▪ Reset totalizer 1 ▪ Reset totalizer 2 ▪ Reset totalizer 3 ▪ Reset all totalizers ▪ Flow override 	Off
Active level	Define input signal level at which the assigned function is triggered.	<ul style="list-style-type: none"> ▪ High ▪ Low 	High
Response time status input	Define the minimum amount of time the input signal level must be present before the selected function is triggered.	5 to 200 ms	50 ms

10.4.5 Configuring the current input

The "**Current input**" wizard guides the user systematically through all the parameters that have to be set for configuring the current input.

Navigation

"Setup" menu → Current input

► Current input 1 to n	
Terminal number	→ 87
Signal mode	→ 87
0/4 mA value	→ 87

20 mA value	→ 87
Current span	→ 87
Failure mode	→ 87
Failure value	→ 87

Parameter overview with brief description

Parameter	Prerequisite	Description	User interface / Selection / User entry	Factory setting
Terminal number	–	Shows the terminal numbers used by the current input module.	<ul style="list-style-type: none"> Not used 24-25 (I/O 2) 22-23 (I/O 3) 	–
Signal mode	The measuring device is not approved for use in the hazardous area with type of protection Ex-i.	Select the signal mode for the current input.	<ul style="list-style-type: none"> Passive* Active* 	Active
0/4 mA value	–	Enter 4 mA value.	Signed floating-point number	0
20 mA value	–	Enter 20 mA value.	Signed floating-point number	Depends on country and nominal diameter
Current span	–	Select current range for process value output and upper/lower level for alarm signal.	<ul style="list-style-type: none"> 4...20 mA (4...20.5 mA) 4...20 mA NAMUR (3.8...20.5 mA) 4...20 mA US (3.9...20.8 mA) 0...20 mA (0...20.5 mA) 	Country-specific: <ul style="list-style-type: none"> 4...20 mA NAMUR (3.8...20.5 mA) 4...20 mA US (3.9...20.8 mA)
Failure mode	–	Define input behavior in alarm condition.	<ul style="list-style-type: none"> Alarm Last valid value Defined value 	Alarm
Failure value	In the Failure mode parameter, the Defined value option is selected.	Enter value to be used by the device if input value from external device is missing.	Signed floating-point number	0

* Visibility depends on order options or device settings









10.4.6 Configuring the current output

The **Current output** wizard guides you systematically through all the parameters that have to be set for configuring the current output.

Navigation







"Setup" menu → Current output

▶ Current output 1 to n	
Terminal number	→ 88

Signal mode	→  88
Assign current output 1 to n	→  88
Current span	→  88
0/4 mA value	→  89
20 mA value	→  89
Fixed current	→  89
Damping output 1 to n	→  89
Failure mode	→  89
Failure current	→  89

Parameter overview with brief description

Parameter	Prerequisite	Description	User interface / Selection / User entry	Factory setting
Terminal number	–	Shows the terminal numbers used by the current output module.	<ul style="list-style-type: none"> ▪ Not used ▪ 26-27 (I/O 1) ▪ 24-25 (I/O 2) ▪ 22-23 (I/O 3) 	–
Signal mode	–	Select the signal mode for the current output.	<ul style="list-style-type: none"> ▪ Active * ▪ Passive * 	Active
Assign current output 1 to n	–	Select process variable for current output.	<ul style="list-style-type: none"> ▪ Off * ▪ Volume flow ▪ Mass flow ▪ Corrected volume flow ▪ Flow velocity ▪ Conductivity * ▪ Electronic temperature ▪ Reference electrode potential against PE * ▪ Coil current shot time * ▪ Noise * ▪ Coating measured value * ▪ Test point 1 ▪ Test point 2 ▪ Test point 3 	Volume flow
Current span	–	Select current range for process value output and upper/lower level for alarm signal.	<ul style="list-style-type: none"> ▪ 4...20 mA NAMUR (3.8...20.5 mA) ▪ 4...20 mA US (3.9...20.8 mA) ▪ 4...20 mA (4...20.5 mA) ▪ 0...20 mA (0...20.5 mA) ▪ Fixed current 	Country-specific: <ul style="list-style-type: none"> ▪ 4...20 mA NAMUR (3.8...20.5 mA) ▪ 4...20 mA US (3.9...20.8 mA)

Parameter	Prerequisite	Description	User interface / Selection / User entry	Factory setting
0/4 mA value	In the Current span parameter (→  88), one of the following options is selected: <ul style="list-style-type: none"> ▪ 4...20 mA NAMUR (3.8...20.5 mA) ▪ 4...20 mA US (3.9...20.8 mA) ▪ 4...20 mA (4... 20.5 mA) ▪ 0...20 mA (0... 20.5 mA) 	Enter 4 mA value.	Signed floating-point number	Country-specific: <ul style="list-style-type: none"> ▪ 0 l/h ▪ 0 gal/min (us)
20 mA value	One of the following options is selected in the Current span parameter (→  88): <ul style="list-style-type: none"> ▪ 4...20 mA NAMUR (3.8...20.5 mA) ▪ 4...20 mA US (3.9...20.8 mA) ▪ 4...20 mA (4... 20.5 mA) ▪ 0...20 mA (0... 20.5 mA) 	Enter 20 mA value.	Signed floating-point number	Depends on country and nominal diameter
Fixed current	The Fixed current option is selected in the Current span parameter (→  88).	Defines the fixed output current.	0 to 22.5 mA	22.5 mA
Damping output 1 to n	A process variable is selected in the Assign current output parameter (→  88) and one of the following options is selected in the Current span parameter (→  88): <ul style="list-style-type: none"> ▪ 4...20 mA NAMUR (3.8...20.5 mA) ▪ 4...20 mA US (3.9...20.8 mA) ▪ 4...20 mA (4... 20.5 mA) ▪ 0...20 mA (0... 20.5 mA) 	Set reaction time for output signal to fluctuations in the measured value.	0.0 to 999.9 s	1.0 s
Failure mode	A process variable is selected in the Assign current output parameter (→  88) and one of the following options is selected in the Current span parameter (→  88): <ul style="list-style-type: none"> ▪ 4...20 mA NAMUR (3.8...20.5 mA) ▪ 4...20 mA US (3.9...20.8 mA) ▪ 4...20 mA (4... 20.5 mA) ▪ 0...20 mA (0... 20.5 mA) 	Define output behavior in alarm condition.	<ul style="list-style-type: none"> ▪ Min. ▪ Max. ▪ Last valid value ▪ Actual value ▪ Defined value 	Max.
Failure current	The Defined value option is selected in the Failure mode parameter.	Enter current output value in alarm condition.	0 to 22.5 mA	22.5 mA

* Visibility depends on order options or device settings

10.4.7 Configuring the pulse/frequency/switch output

The **Pulse/frequency/switch output** wizard guides you systematically through all the parameters that can be set for configuring the selected output type.

Navigation

"Setup" menu → Advanced setup → Pulse/frequency/switch output

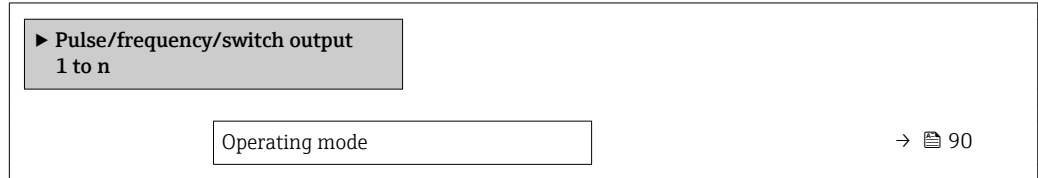

Parameter overview with brief description

Parameter	Description	Selection	Factory setting
Operating mode	Define the output as a pulse, frequency or switch output.	<ul style="list-style-type: none"> ■ Pulse ■ Frequency ■ Switch 	Pulse





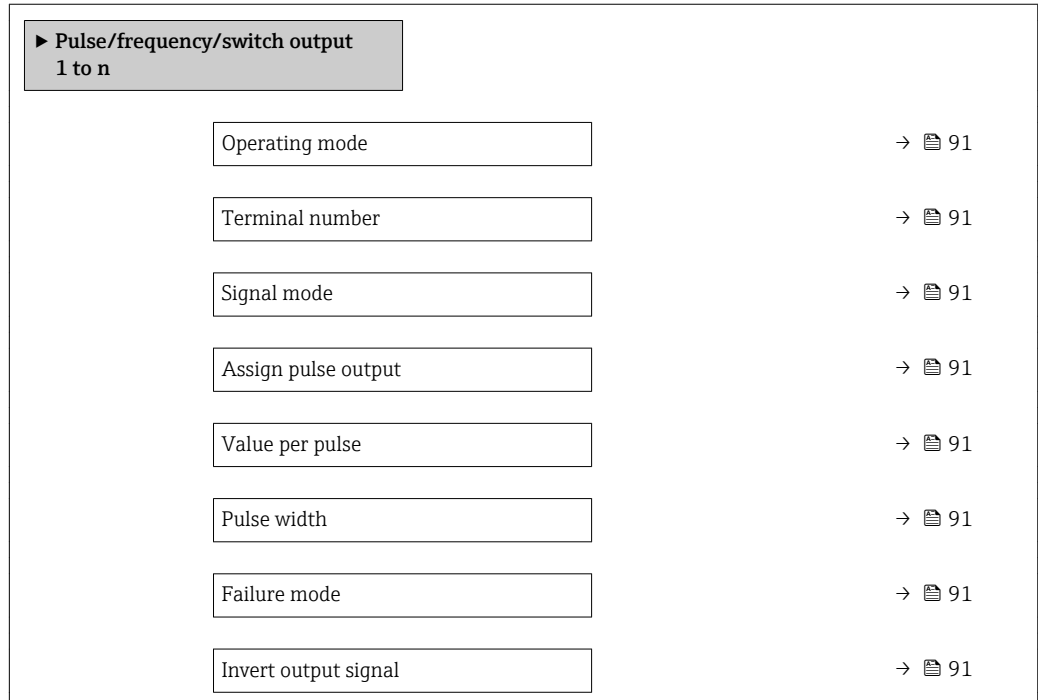

Configuring the pulse output

Navigation

"Setup" menu → Pulse/frequency/switch output



Parameter overview with brief description

Parameter	Prerequisite	Description	Selection / User interface / User entry	Factory setting
Operating mode	–	Define the output as a pulse, frequency or switch output.	<ul style="list-style-type: none"> ■ Pulse ■ Frequency ■ Switch 	Pulse
Terminal number	–	Shows the terminal numbers used by the PFS output module.	<ul style="list-style-type: none"> ■ Not used ■ 24-25 (I/O 2) ■ 22-23 (I/O 3) 	–
Signal mode	–	Select the signal mode for the PFS output.	<ul style="list-style-type: none"> ■ Passive ■ Active ■ Passive NAMUR 	Passive
Assign pulse output 1 to n	The Pulse option is selected in the Operating mode parameter parameter.	Select process variable for pulse output.	<ul style="list-style-type: none"> ■ Off ■ Volume flow ■ Mass flow ■ Corrected volume flow 	Off
Pulse scaling	The Pulse option is selected in the Operating mode parameter (→  90) and a process variable is selected in the Assign pulse output parameter (→  91).	Enter quantity for measured value at which a pulse is output.	Positive floating point number	Depends on country and nominal diameter
Pulse width	The Pulse option is selected in the Operating mode parameter (→  90) and a process variable is selected in the Assign pulse output parameter (→  91).	Define time width of the output pulse.	0.05 to 2 000 ms	100 ms
Failure mode	The Pulse option is selected in the Operating mode parameter (→  90) and a process variable is selected in the Assign pulse output parameter (→  91).	Define output behavior in alarm condition.	<ul style="list-style-type: none"> ■ Actual value ■ No pulses 	No pulses
Invert output signal	–	Invert the output signal.	<ul style="list-style-type: none"> ■ No ■ Yes 	No

Configuring the frequency output

Navigation

"Setup" menu → Pulse/frequency/switch output

▶ **Pulse/frequency/switch output 1 to n**

Operating mode

→  92

Terminal number







→  92

Signal mode



→  92

Assign frequency output

→  92

Minimum frequency value	→  92
Maximum frequency value	→  93
Measuring value at minimum frequency	→  93
Measuring value at maximum frequency	→  93
Failure mode	→  93
Failure frequency	→  93
Invert output signal	→  93

Parameter overview with brief description

Parameter	Prerequisite	Description	Selection / User interface / User entry	Factory setting
Operating mode	–	Define the output as a pulse, frequency or switch output.	<ul style="list-style-type: none"> ▪ Pulse ▪ Frequency ▪ Switch 	Pulse
Terminal number	–	Shows the terminal numbers used by the PFS output module.	<ul style="list-style-type: none"> ▪ Not used ▪ 24-25 (I/O 2) ▪ 22-23 (I/O 3) 	–
Signal mode	–	Select the signal mode for the PFS output.	<ul style="list-style-type: none"> ▪ Passive ▪ Active ▪ Passive NAMUR 	Passive
Assign frequency output	The Frequency option is selected in the Operating mode parameter (→  90).	Select process variable for frequency output.	<ul style="list-style-type: none"> ▪ Off ▪ Volume flow ▪ Mass flow ▪ Corrected volume flow ▪ Flow velocity* ▪ Conductivity* ▪ Electronic temperature ▪ Noise* ▪ Coil current shot time* ▪ Reference electrode potential against PE* ▪ Coating measured value* ▪ Test point 1 ▪ Test point 2 ▪ Test point 3 	Off
Minimum frequency value	The Frequency option is selected in the Operating mode parameter (→  90) and a process variable is selected in the Assign frequency output parameter (→  92).	Enter minimum frequency.	0.0 to 10 000.0 Hz	0.0 Hz

Parameter	Prerequisite	Description	Selection / User interface / User entry	Factory setting
Maximum frequency value	The Frequency option is selected in the Operating mode parameter (→ 90) and a process variable is selected in the Assign frequency output parameter (→ 92).	Enter maximum frequency.	0.0 to 10000.0 Hz	10000.0 Hz
Measuring value at minimum frequency	The Frequency option is selected in the Operating mode parameter (→ 90) and a process variable is selected in the Assign frequency output parameter (→ 92).	Enter measured value for minimum frequency.	Signed floating-point number	Depends on country and nominal diameter
Measuring value at maximum frequency	The Frequency option is selected in the Operating mode parameter (→ 90) and a process variable is selected in the Assign frequency output parameter (→ 92).	Enter measured value for maximum frequency.	Signed floating-point number	Depends on country and nominal diameter
Failure mode	The Frequency option is selected in the Operating mode parameter (→ 90) and a process variable is selected in the Assign frequency output parameter (→ 92).	Define output behavior in alarm condition.	<ul style="list-style-type: none"> ■ Actual value ■ Defined value ■ 0 Hz 	0 Hz
Failure frequency	The Frequency option is selected in the Operating mode parameter (→ 90) and a process variable is selected in the Assign frequency output parameter (→ 92).	Enter frequency output value in alarm condition.	0.0 to 12500.0 Hz	0.0 Hz
Invert output signal	–	Invert the output signal.	<ul style="list-style-type: none"> ■ No ■ Yes 	No

* Visibility depends on order options or device settings

Configuring the switch output

Navigation

"Setup" menu → Pulse/frequency/switch output

► Pulse/frequency/switch output 1 to n	
Operating mode	→ 94
Terminal number	→ 94
Signal mode	→ 94
Switch output function	→ 95
Assign diagnostic behavior	→ 95
Assign limit	→ 95
Assign flow direction check	→ 95
Assign status	→ 95
Switch-on value	→ 95
Switch-off value	→ 95
Switch-on delay	→ 95
Switch-off delay	→ 96
Failure mode	→ 96
Invert output signal	→ 96

Parameter overview with brief description

Parameter	Prerequisite	Description	Selection / User interface / User entry	Factory setting
Operating mode	–	Define the output as a pulse, frequency or switch output.	<ul style="list-style-type: none"> ▪ Pulse ▪ Frequency ▪ Switch 	Pulse
Terminal number	–	Shows the terminal numbers used by the PFS output module.	<ul style="list-style-type: none"> ▪ Not used ▪ 24-25 (I/O 2) ▪ 22-23 (I/O 3) 	–
Signal mode	–	Select the signal mode for the PFS output.	<ul style="list-style-type: none"> ▪ Passive ▪ Active ▪ Passive NAMUR 	Passive

Parameter	Prerequisite	Description	Selection / User interface / User entry	Factory setting
Switch output function	The Switch option is selected in the Operating mode parameter.	Select function for switch output.	<ul style="list-style-type: none"> ▪ Off ▪ On ▪ Diagnostic behavior ▪ Limit ▪ Flow direction check ▪ Status 	Off
Assign diagnostic behavior	<ul style="list-style-type: none"> ▪ In the Operating mode parameter, the Switch option is selected. ▪ In the Switch output function parameter, the Diagnostic behavior option is selected. 	Select diagnostic behavior for switch output.	<ul style="list-style-type: none"> ▪ Alarm ▪ Alarm or warning ▪ Warning 	Alarm
Assign limit	<ul style="list-style-type: none"> ▪ The Switch option is selected in the Operating mode parameter. ▪ The Limit option is selected in the Switch output function parameter. 	Select process variable for limit function.	<ul style="list-style-type: none"> ▪ Off ▪ Volume flow ▪ Mass flow ▪ Corrected volume flow ▪ Flow velocity ▪ Conductivity* ▪ Totalizer 1 ▪ Totalizer 2 ▪ Totalizer 3 ▪ Electronic temperature 	Volume flow
Assign flow direction check	<ul style="list-style-type: none"> ▪ The Switch option is selected in the Operating mode parameter. ▪ The Flow direction check option is selected in the Switch output function parameter. 	Select process variable for flow direction monitoring.	<ul style="list-style-type: none"> ▪ Off ▪ Volume flow ▪ Mass flow ▪ Corrected volume flow 	Volume flow
Assign status	<ul style="list-style-type: none"> ▪ The Switch option is selected in the Operating mode parameter. ▪ The Status option is selected in the Switch output function parameter. 	Select device status for switch output.	<ul style="list-style-type: none"> ▪ Empty pipe detection ▪ Low flow cut off 	Empty pipe detection
Switch-on value	<ul style="list-style-type: none"> ▪ The Switch option is selected in the Operating mode parameter. ▪ The Limit option is selected in the Switch output function parameter. 	Enter measured value for the switch-on point.	Signed floating-point number	Country-specific: <ul style="list-style-type: none"> ▪ 0 l/h ▪ 0 gal/min (us)
Switch-off value	<ul style="list-style-type: none"> ▪ The Switch option is selected in the Operating mode parameter. ▪ The Limit option is selected in the Switch output function parameter. 	Enter measured value for the switch-off point.	Signed floating-point number	Country-specific: <ul style="list-style-type: none"> ▪ 0 l/h ▪ 0 gal/min (us)
Switch-on delay	<ul style="list-style-type: none"> ▪ The Switch option is selected in the Operating mode parameter. ▪ The Limit option is selected in the Switch output function parameter. 	Define delay for the switch-on of status output.	0.0 to 100.0 s	0.0 s

Parameter	Prerequisite	Description	Selection / User interface / User entry	Factory setting
Switch-off delay	<ul style="list-style-type: none"> ▪ The Switch option is selected in the Operating mode parameter. ▪ The Limit option is selected in the Switch output function parameter. 	Define delay for the switch-off of status output.	0.0 to 100.0 s	0.0 s
Failure mode	–	Define output behavior in alarm condition.	<ul style="list-style-type: none"> ▪ Actual status ▪ Open ▪ Closed 	Open
Invert output signal	–	Invert the output signal.	<ul style="list-style-type: none"> ▪ No ▪ Yes 	No

* Visibility depends on order options or device settings

10.4.8 Configuring the local display

The **Display** wizard guides you systematically through all the parameters that can be configured for configuring the local display.

Navigation

"Setup" menu → Display

► Display	
Format display	→ 97
Value 1 display	→ 97
0% bargraph value 1	→ 97
100% bargraph value 1	→ 97
Value 2 display	→ 97
Value 3 display	→ 97
0% bargraph value 3	→ 97
100% bargraph value 3	→ 97
Value 4 display	→ 97

Parameter overview with brief description

Parameter	Prerequisite	Description	Selection / User entry	Factory setting
Format display	A local display is provided.	Select how measured values are shown on the display.	<ul style="list-style-type: none"> ■ 1 value, max. size ■ 1 bargraph + 1 value ■ 2 values ■ 1 value large + 2 values ■ 4 values 	1 value, max. size
Value 1 display	A local display is provided.	Select the measured value that is shown on the local display.	<ul style="list-style-type: none"> ■ Volume flow ■ Mass flow ■ Corrected volume flow ■ Flow velocity ■ Totalizer 1 ■ Totalizer 2 ■ Totalizer 3 ■ Current output 1 * ■ Current output 2 * ■ Current output 3 * ■ Electronic temperature ■ Noise * ■ Coil current shot time * ■ Reference electrode potential against PE * ■ Coating measured value * ■ Test point 1 ■ Test point 2 ■ Test point 3 	Volume flow
0% bargraph value 1	A local display is provided.	Enter 0% value for bar graph display.	Signed floating-point number	Country-specific: <ul style="list-style-type: none"> ■ 0 l/h ■ 0 gal/min (us)
100% bargraph value 1	A local display is provided.	Enter 100% value for bar graph display.	Signed floating-point number	Depends on country and nominal diameter
Value 2 display	A local display is provided.	Select the measured value that is shown on the local display.	For the picklist, see the Value 2 display parameter (→ 97)	None
Value 3 display	A local display is provided.	Select the measured value that is shown on the local display.	For the picklist, see the Value 2 display parameter (→ 97)	None
0% bargraph value 3	A selection was made in the Value 3 display parameter.	Enter 0% value for bar graph display.	Signed floating-point number	Country-specific: <ul style="list-style-type: none"> ■ 0 l/h ■ 0 gal/min (us)
100% bargraph value 3	A selection was made in the Value 3 display parameter.	Enter 100% value for bar graph display.	Signed floating-point number	0
Value 4 display	A local display is provided.	Select the measured value that is shown on the local display.	For the picklist, see the Value 2 display parameter (→ 97)	None

* Visibility depends on order options or device settings

10.4.9 Configuring the low flow cut off

The **Low flow cut off** wizard systematically guides the user through all the parameters that must be set to configure low flow cut off.

Navigation

"Setup" menu → Low flow cut off

▶ Low flow cut off	
Assign process variable	→ 98
On value low flow cutoff	→ 98
Off value low flow cutoff	→ 98
Pressure shock suppression	→ 98

Parameter overview with brief description

Parameter	Prerequisite	Description	Selection / User entry	Factory setting
Assign process variable	–	Select process variable for low flow cut off.	<ul style="list-style-type: none"> ▪ Off ▪ Volume flow ▪ Mass flow ▪ Corrected volume flow 	Volume flow
On value low flow cutoff	A process variable is selected in the Assign process variable parameter (→ 98).	Enter on value for low flow cut off.	Positive floating-point number	Depends on country and nominal diameter
Off value low flow cutoff	A process variable is selected in the Assign process variable parameter (→ 98).	Enter off value for low flow cut off.	0 to 100.0 %	50 %
Pressure shock suppression	A process variable is selected in the Assign process variable parameter (→ 98).	Enter time frame for signal suppression (= active pressure shock suppression).	0 to 100 s	0 s

10.4.10 Configuring empty pipe detection

The **Empty pipe detection** submenu contains parameters that must be configured for the configuration of empty pipe detection.

Navigation

"Setup" menu → Empty pipe detection

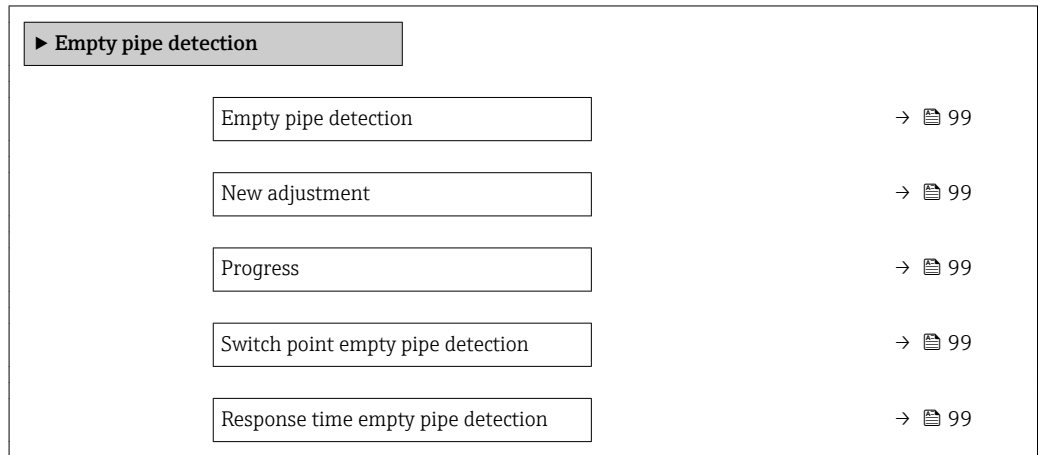

Parameter overview with brief description

Parameter	Prerequisite	Description	Selection / User interface / User entry	Factory setting
Empty pipe detection	–	Switch empty pipe detection on and off.	<ul style="list-style-type: none"> ■ Off ■ On 	Off
New adjustment	The On option is selected in the Empty pipe detection parameter.	Select type of adjustment.	<ul style="list-style-type: none"> ■ Cancel ■ Empty pipe adjust ■ Full pipe adjust 	Cancel
Progress	The On option is selected in the Empty pipe detection parameter.	Shows the progress.	<ul style="list-style-type: none"> ■ Ok ■ Busy ■ Not ok 	–
Switch point empty pipe detection	The On option is selected in the Empty pipe detection parameter.	Enter hysteresis in %, below this value the measuring tube will detected as empty.	0 to 100 %	50 %
Response time empty pipe detection	A process variable is selected in the Assign process variable parameter (→ 99).	Enter the time before diagnostic message S862 'Pipe empty' is displayed for empty pipe detection.	0 to 100 s	1 s







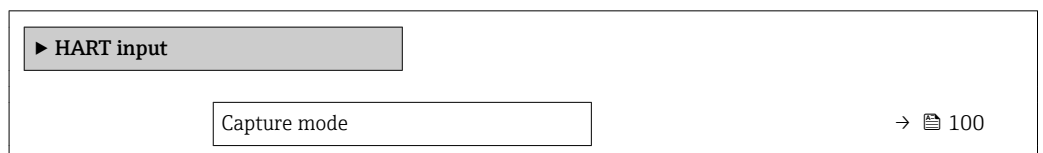

10.4.11 Configuring the HART input

The **HART input** wizard contains all the parameters that must be configured for the configuration of the HART input.

Navigation

"Setup" menu → HART input



Device ID	→  100
Device type	→  100
Manufacturer ID	→  100
Burst command	→  100
Slot number	→  100
Timeout	→  101
Failure mode	→  101
Failure value	→  101

"Configuration" submenu

Navigation

"Expert" menu → Communication → HART input → Configuration

Parameter overview with brief description

Parameter	Prerequisite	Description	Selection / User entry	Factory setting
Capture mode	–	Select capture mode via burst or master communication.	<ul style="list-style-type: none"> ▪ Off ▪ Burst network ▪ Master network 	Off
Device ID	The Master network option is selected in the Capture mode parameter.	Enter device ID of external device.	6-digit value: <ul style="list-style-type: none"> ▪ Via local operation: enter as hexadecimal or decimal number ▪ Via operating tool: enter as decimal number 	0
Device type	In the Capture mode parameter, the Master network option is selected.	Enter device type of external device.	2-digit hexadecimal number	0x00
Manufacturer ID	The Master network option is selected in the Capture mode parameter.	Enter manufacture ID of external device.	2-digit value: <ul style="list-style-type: none"> ▪ Via local operation: enter as hexadecimal or decimal number ▪ Via operating tool: enter as decimal number 	0
Burst command	The Burst network option or the Master network option are selected in the Capture mode parameter.	Select command to read in external process variable.	<ul style="list-style-type: none"> ▪ Command 1 ▪ Command 3 ▪ Command 9 ▪ Command 33 	Command 1
Slot number	The Burst network option or the Master network option is selected in the Capture mode parameter.	Define position of external process variable in burst command.	1 to 8	1

Parameter	Prerequisite	Description	Selection / User entry	Factory setting
Timeout	The Burst network option or the Master network option is selected in the Capture mode parameter.	Enter deadline for process variable of external device.  If the waiting time is exceeded, the diagnostic message F410 Data transfer is displayed.	1 to 120 s	5 s
Failure mode	In the Capture mode parameter, the Burst network option or Master network option is selected.	Define behavior if external process variable is missed.	<ul style="list-style-type: none"> ▪ Alarm ▪ Last valid value ▪ Defined value 	Alarm
Failure value	The following conditions are met: <ul style="list-style-type: none"> ▪ In the Capture mode parameter, the Burst network option or Master network option is selected. ▪ In the Failure mode parameter, the Defined value option is selected. 	Enter value to be used by the device if input value from external device is missing.	Signed floating-point number	0

"Input" submenu

Navigation

"Expert" menu → Communication → HART input → Input

Parameter overview with brief description

Parameter	Description	User interface
Value	Shows the value of the device variable recorded by the HART input.	Signed floating-point number
Status	Shows the status of the device variable recorded by the HART input.	<ul style="list-style-type: none"> ▪ Manual/Fixed ▪ Good ▪ Poor accuracy ▪ Bad





10.4.12 Configuring the relay output





The **Relay output** wizard guides the user systematically through all the parameters that have to be set for configuring the relay output.

Navigation

"Setup" menu → Relay output 1 to n

▶ RelaisOutput 1 to n

Switch output function	→  102
Assign flow direction check	→  102
Assign limit	→  102
Assign diagnostic behavior	→  102

Assign status	→  102
Switch-off value	→  102
Switch-on value	→  102
Failure mode	→  103

Parameter overview with brief description

Parameter	Prerequisite	Description	Selection / User interface / User entry	Factory setting
Relay output function	–	Select the function for the relay output.	<ul style="list-style-type: none"> ▪ Closed ▪ Open ▪ Diagnostic behavior ▪ Limit ▪ Flow direction check ▪ Digital Output 	Closed
Terminal number	–	Shows the terminal numbers used by the relay output module.	<ul style="list-style-type: none"> ▪ Not used ▪ 24-25 (I/O 2) ▪ 22-23 (I/O 3) 	–
Assign flow direction check	In the Relay output function parameter, the Flow direction check option is selected.	Select process variable for flow direction monitoring.	<ul style="list-style-type: none"> ▪ Off ▪ Volume flow ▪ Mass flow ▪ Corrected volume flow 	Volume flow
Assign limit	The Limit option is selected in the Relay output function parameter.	Select process variable for limit function.	<ul style="list-style-type: none"> ▪ Off ▪ Volume flow ▪ Mass flow ▪ Corrected volume flow ▪ Flow velocity* ▪ Conductivity* ▪ Totalizer 1 ▪ Totalizer 2 ▪ Totalizer 3 ▪ Electronic temperature 	Volume flow
Assign diagnostic behavior	In the Relay output function parameter, the Diagnostic behavior option is selected.	Select diagnostic behavior for switch output.	<ul style="list-style-type: none"> ▪ Alarm ▪ Alarm or warning ▪ Warning 	Alarm
Assign status	In the Relay output function parameter, the Digital Output option is selected.	Select device status for switch output.	<ul style="list-style-type: none"> ▪ Partially filled pipe detection ▪ Low flow cut off 	Partially filled pipe detection
Switch-off value	In the Relay output function parameter, the Limit option is selected.	Enter measured value for the switch-off point.	Signed floating-point number	Country-specific: <ul style="list-style-type: none"> ▪ 0 l/h ▪ 0 gal(us)/min
Switch-off delay	In the Relay output function parameter, the Limit option is selected.	Define delay for the switch-off of status output.	0.0 to 100.0 s	0.0 s
Switch-on value	The Limit option is selected in the Relay output function parameter.	Enter measured value for the switch-on point.	Signed floating-point number	Country-specific: <ul style="list-style-type: none"> ▪ 0 l/h ▪ 0 gal(us)/min

Parameter	Prerequisite	Description	Selection / User interface / User entry	Factory setting
Switch-on delay	In the Relay output function parameter, the Limit option is selected.	Define delay for the switch-on of status output.	0.0 to 100.0 s	0.0 s
Failure mode	–	Define output behavior in alarm condition.	<ul style="list-style-type: none"> ▪ Actual status ▪ Open ▪ Closed 	Open

* Visibility depends on order options or device settings

10.4.13 Configuring the double pulse output

The **Double pulse output** submenu guides the user systematically through all the parameters that have to be set for configuring the double pulse output.

Navigation

"Setup" menu → Double pulse output

▶ Double pulse output

Master terminal number	→ ⓘ 103
Slave terminal number	→ ⓘ 103
Signal mode	→ ⓘ 103
Assign pulse output 1	→ ⓘ 104
Measuring mode	→ ⓘ 104
Value per pulse	→ ⓘ 104
Pulse width	→ ⓘ 104
Failure mode	→ ⓘ 104
Invert output signal	→ ⓘ 104

Parameter overview with brief description

Parameter	Description	Selection / User interface / User entry	Factory setting
Signal mode	Select the signal mode for the double pulse output.	<ul style="list-style-type: none"> ▪ Passive ▪ Active ▪ Passive NAMUR 	Passive
Master terminal number	Shows the terminal numbers used by the master of the double pulse output module.	<ul style="list-style-type: none"> ▪ Not used ▪ 24-25 (I/O 2) ▪ 22-23 (I/O 3) 	–
Slave terminal number	Shows the terminal numbers used by the slave of the double pulse output module.	<ul style="list-style-type: none"> ▪ Not used ▪ 24-25 (I/O 2) ▪ 22-23 (I/O 3) 	–

Parameter	Description	Selection / User interface / User entry	Factory setting
Assign pulse output 1	Select process variable for pulse output.	<ul style="list-style-type: none"> ■ Off ■ Volume flow ■ Mass flow ■ Corrected volume flow 	Off
Measuring mode	Select measuring mode for pulse output.	<ul style="list-style-type: none"> ■ Forward flow ■ Forward/Reverse flow ■ Reverse flow ■ Reverse flow compensation 	Forward flow
Value per pulse	Enter measured value at which a pulse is output.	Signed floating-point number	Depends on country and nominal diameter
Pulse width	Define time width of the output pulse.	0.5 to 2 000 ms	0.5 ms
Failure mode	Define output behavior in alarm condition.	<ul style="list-style-type: none"> ■ Actual value ■ No pulses 	No pulses
Invert output signal	Invert the output signal.	<ul style="list-style-type: none"> ■ No ■ Yes 	No

10.5 Advanced settings

The **Advanced setup** submenu together with its submenus contains parameters for specific settings.

Navigation to the "Advanced setup" submenu

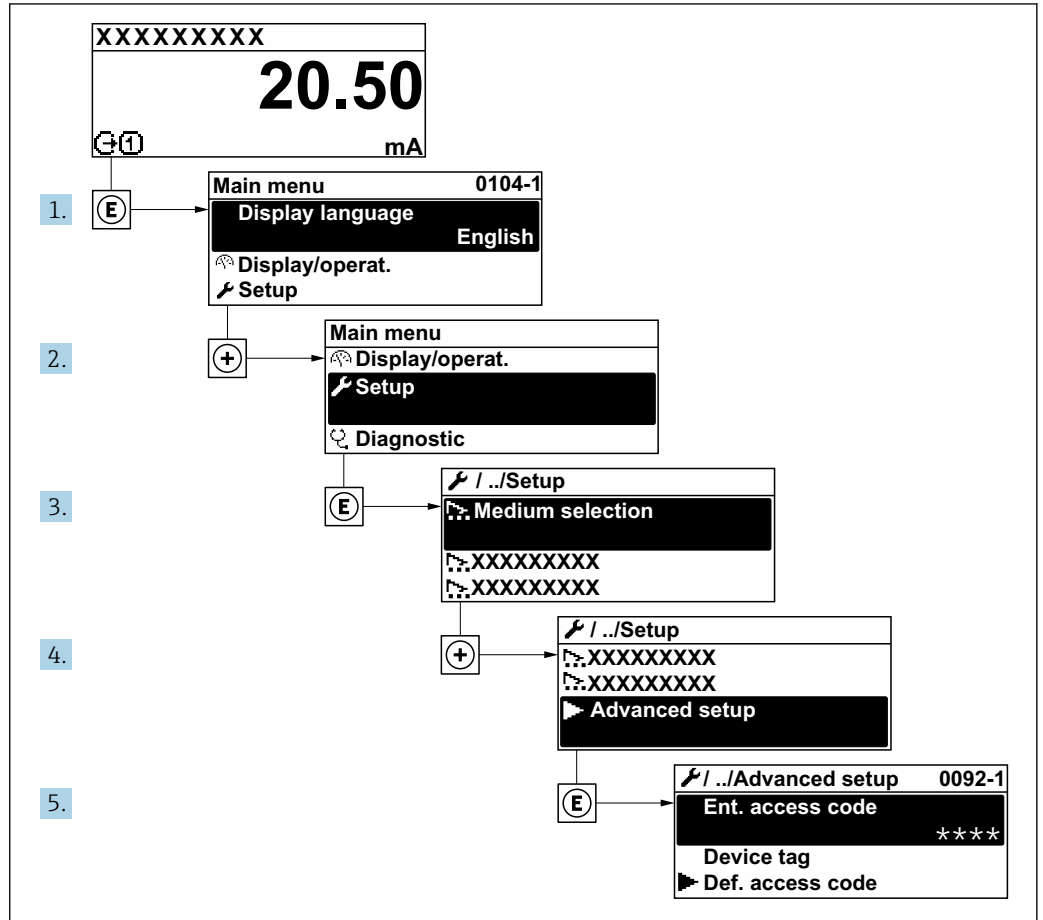

A003223-EN

i The number of submenus can vary depending on the device version. Some submenus are not dealt with in the Operating Instructions. These submenus and the parameters they contain are explained in the Special Documentation for the device.

Navigation

"Setup" menu → Advanced setup

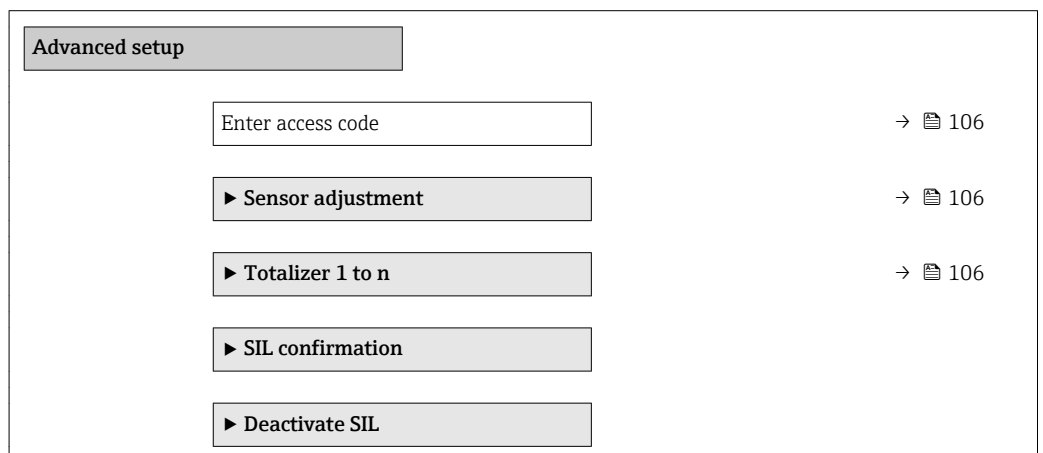

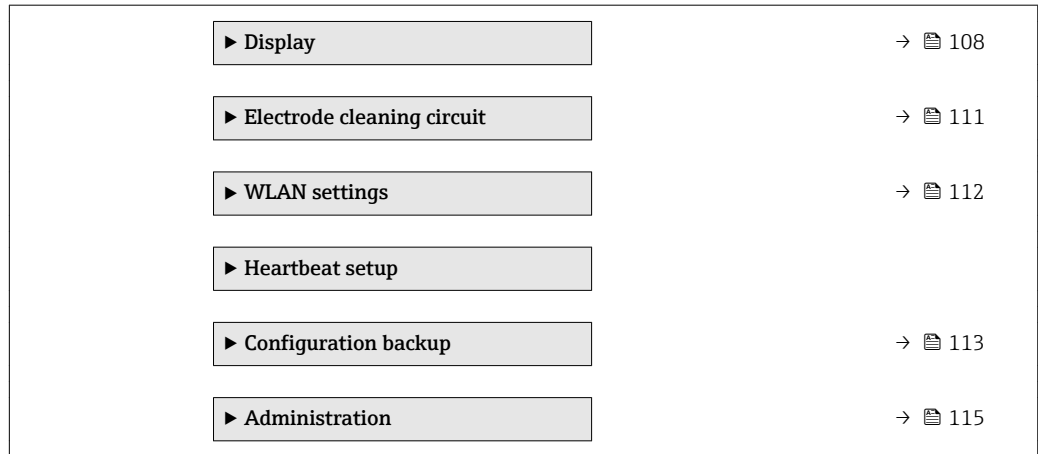

10.5.1 Using the parameter to enter the access code

Navigation

"Setup" menu → Advanced setup

Parameter overview with brief description

Parameter	Description	User entry
Enter access code	Enter access code to disable write protection of parameters.	Max. 16-digit character string comprising numbers, letters and special characters

10.5.2 Carrying out a sensor adjustment

The **Sensor adjustment** submenu contains parameters that pertain to the functionality of the sensor.

Navigation

"Setup" menu → Advanced setup → Sensor adjustment

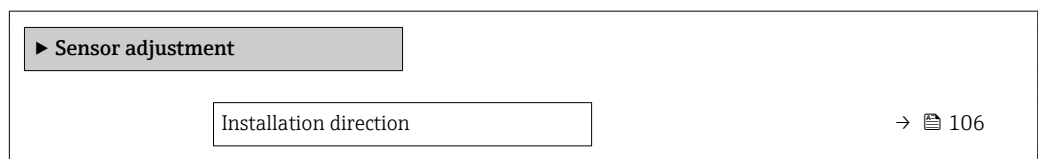

Parameter overview with brief description

Parameter	Description	Selection	Factory setting
Installation direction	Set sign of flow direction to match the direction of the arrow on the sensor.	<ul style="list-style-type: none"> ▪ Flow in arrow direction ▪ Flow against arrow direction 	Flow in arrow direction

10.5.3 Configuring the totalizer

In the **"Totalizer 1 to n"** submenu the individual totalizer can be configured.

Navigation

"Setup" menu → Advanced setup → Totalizer 1 to n

▶ Totalizer 1 to n	
Assign process variable	→ ⓘ 107
Unit totalizer 1 to n	→ ⓘ 107
Totalizer operation mode	→ ⓘ 107
Failure mode	→ ⓘ 107

Parameter overview with brief description

Parameter	Prerequisite	Description	Selection	Factory setting
Assign process variable	–	Select process variable for totalizer.	<ul style="list-style-type: none"> ▪ Off ▪ Volume flow ▪ Mass flow ▪ Corrected volume flow 	Volume flow
Unit totalizer 1 to n	A process variable is selected in the Assign process variable parameter (→ ⓘ 107) of the Totalizer 1 to n submenu.	Select process variable totalizer unit.	Unit choose list	1
Totalizer operation mode	A process variable is selected in the Assign process variable parameter (→ ⓘ 107) of the Totalizer 1 to n submenu.	Select totalizer calculation mode.	<ul style="list-style-type: none"> ▪ Net flow total ▪ Forward flow total ▪ Reverse flow total 	Net flow total
Failure mode	A process variable is selected in the Assign process variable parameter (→ ⓘ 107) of the Totalizer 1 to n submenu.	Define totalizer behavior in alarm condition.	<ul style="list-style-type: none"> ▪ Stop ▪ Actual value ▪ Last valid value 	Stop

10.5.4 Carrying out additional display configurations



In the **Display** submenu you can set all the parameters associated with the configuration of the local display.

Navigation

"Setup" menu → Advanced setup → Display

► Display	
Format display	→ 109
Value 1 display	→ 109
0% bargraph value 1	→ 109
100% bargraph value 1	→ 109
Decimal places 1	→ 109
Value 2 display	→ 109
Decimal places 2	→ 109
Value 3 display	→ 109
0% bargraph value 3	→ 109
100% bargraph value 3	→ 109
Decimal places 3	→ 110
Value 4 display	→ 110
Decimal places 4	→ 110
Display language	→ 110
Display interval	→ 110
Display damping	→ 110
Header	→ 110
Header text	→ 110
Separator	→ 111
Backlight	→ 111

Parameter overview with brief description

Parameter	Prerequisite	Description	Selection / User entry	Factory setting
Format display	A local display is provided.	Select how measured values are shown on the display.	<ul style="list-style-type: none"> ■ 1 value, max. size ■ 1 bargraph + 1 value ■ 2 values ■ 1 value large + 2 values ■ 4 values 	1 value, max. size
Value 1 display	A local display is provided.	Select the measured value that is shown on the local display.	<ul style="list-style-type: none"> ■ Volume flow ■ Mass flow ■ Corrected volume flow ■ Flow velocity ■ Totalizer 1 ■ Totalizer 2 ■ Totalizer 3 ■ Current output 1 * ■ Current output 2 * ■ Current output 3 * ■ Electronic temperature ■ Noise * ■ Coil current shot time * ■ Reference electrode potential against PE * ■ Coating measured value * ■ Test point 1 ■ Test point 2 ■ Test point 3 	Volume flow
0% bargraph value 1	A local display is provided.	Enter 0% value for bar graph display.	Signed floating-point number	Country-specific: <ul style="list-style-type: none"> ■ 0 l/h ■ 0 gal/min (us)
100% bargraph value 1	A local display is provided.	Enter 100% value for bar graph display.	Signed floating-point number	Depends on country and nominal diameter
Decimal places 1	A measured value is specified in the Value 1 display parameter.	Select the number of decimal places for the display value.	<ul style="list-style-type: none"> ■ x ■ x.x ■ x.xx ■ x.xxx ■ x.xxxx 	x.xx
Value 2 display	A local display is provided.	Select the measured value that is shown on the local display.	For the picklist, see the Value 2 display parameter (→  97)	None
Decimal places 2	A measured value is specified in the Value 2 display parameter.	Select the number of decimal places for the display value.	<ul style="list-style-type: none"> ■ x ■ x.x ■ x.xx ■ x.xxx ■ x.xxxx 	x.xx
Value 3 display	A local display is provided.	Select the measured value that is shown on the local display.	For the picklist, see the Value 2 display parameter (→  97)	None
0% bargraph value 3	A selection was made in the Value 3 display parameter.	Enter 0% value for bar graph display.	Signed floating-point number	Country-specific: <ul style="list-style-type: none"> ■ 0 l/h ■ 0 gal/min (us)
100% bargraph value 3	A selection was made in the Value 3 display parameter.	Enter 100% value for bar graph display.	Signed floating-point number	0

Parameter	Prerequisite	Description	Selection / User entry	Factory setting
Decimal places 3	A measured value is specified in the Value 3 display parameter.	Select the number of decimal places for the display value.	<ul style="list-style-type: none"> ▪ x ▪ x.x ▪ x.xx ▪ x.xxx ▪ x.xxxx 	x.xx
Value 4 display	A local display is provided.	Select the measured value that is shown on the local display.	For the picklist, see the Value 2 display parameter (→ 97)	None
Decimal places 4	A measured value is specified in the Value 4 display parameter.	Select the number of decimal places for the display value.	<ul style="list-style-type: none"> ▪ x ▪ x.x ▪ x.xx ▪ x.xxx ▪ x.xxxx 	x.xx
Display language	A local display is provided.	Set display language.	<ul style="list-style-type: none"> ▪ English ▪ Deutsch ▪ Français ▪ Español ▪ Italiano ▪ Nederlands ▪ Portuguesa ▪ Polski ▪ русский язык (Russian) ▪ Svenska ▪ Türkçe ▪ 中文 (Chinese) ▪ 日本語 (Japanese) ▪ 한국어 (Korean) ▪ العربية (Arabic) * ▪ Bahasa Indonesia ▪ ภาษาไทย (Thai) * ▪ tiếng Việt (Vietnamese) ▪ čeština (Czech) 	English (alternatively, the ordered language is preset in the device)
Display interval	A local display is provided.	Set time measured values are shown on display if display alternates between values.	1 to 10 s	5 s
Display damping	A local display is provided.	Set display reaction time to fluctuations in the measured value.	0.0 to 999.9 s	0.0 s
Header	A local display is provided.	Select header contents on local display.	<ul style="list-style-type: none"> ▪ Device tag ▪ Free text 	Device tag
Header text	In the Header parameter, the Free text option is selected.	Enter display header text.	Max. 12 characters such as letters, numbers or special characters (e.g. @, %, /)	-----

Parameter	Prerequisite	Description	Selection / User entry	Factory setting
Separator	A local display is provided.	Select decimal separator for displaying numerical values.	<ul style="list-style-type: none"> ▪ . (point) ▪ , (comma) 	. (point)
Backlight	One of the following conditions is met: <ul style="list-style-type: none"> ▪ Order code for "Display; operation", option F "4-line, illum.; touch control" ▪ Order code for "Display; operation", option G "4-line, illum.; touch control +WLAN" ▪ Order code for "Display; operation", option O "Separate 4-line display, illum.; 10m/30ft cable; touch control" 	Switch the local display backlight on and off.	<ul style="list-style-type: none"> ▪ Disable ▪ Enable 	Enable

* Visibility depends on order options or device settings

10.5.5 Performing electrode cleaning

The **Electrode cleaning circuit** submenu contains parameters that must be configured for the configuration of electrode cleaning.

 The submenu is only available if the device was ordered with electrode cleaning.

Navigation

"Setup" menu → Advanced setup → Electrode cleaning circuit

▶ Electrode cleaning circuit	
Electrode cleaning circuit	→ ⓘ 111
ECC duration	→ ⓘ 111
ECC recovery time	→ ⓘ 112
ECC cleaning cycle	→ ⓘ 112
ECC Polarity	→ ⓘ 112

Parameter overview with brief description

Parameter	Prerequisite	Description	Selection / User entry / User interface	Factory setting
Electrode cleaning circuit	For the following order code: "Application package", option EC "ECC electrode cleaning"	Enable the cyclic electrode cleaning circuit.	<ul style="list-style-type: none"> ▪ Off ▪ On 	Off
ECC duration	For the following order code: "Application package", option EC "ECC electrode cleaning"	Enter the duration of electrode cleaning in seconds.	0.01 to 30 s	2 s

Parameter	Prerequisite	Description	Selection / User entry / User interface	Factory setting
ECC recovery time	For the following order code: "Application package", option EC "ECC electrode cleaning"	Define recovery time after electrode cleaning. During this time the current output values will be held at last valid value.	1 to 600 s	60 s
ECC cleaning cycle	For the following order code: "Application package", option EC "ECC electrode cleaning"	Enter the pause duration between electrode cleaning cycles.	0.5 to 168 h	0.5 h
ECC Polarity	For the following order code: "Application package", option EC "ECC electrode cleaning"	Select the polarity of the electrode cleaning circuit.	<ul style="list-style-type: none"> ■ Positive ■ Negative 	Depends on the electrode material: <ul style="list-style-type: none"> ■ Platinum: Negative option ■ Tantalum, Alloy C22, stainless steel: Positive option

10.5.6 WLAN configuration

The **WLAN Settings** submenu guides the user systematically through all the parameters that have to be set for the WLAN configuration.

Navigation

"Setup" menu → Advanced setup → WLAN settings

▶ WLAN settings

→ ⓘ 113

→ ⓘ 113

→ ⓘ 113

→ ⓘ 113

→ ⓘ 113

<input style="width: 80%; height: 20px;" type="text" value="Connection state"/>
<input style="width: 80%; height: 20px;" type="text" value="Received signal strength"/>

Parameter overview with brief description

Parameter	Prerequisite	Description	User entry / Selection	Factory setting
WLAN IP address	–	Enter IP address of the WLAN interface of the device.	4 octet: 0 to 255 (in the particular octet)	192.168.1.212
Network security	–	Select the security type of the WLAN network.	<ul style="list-style-type: none"> ■ Unsecured ■ WPA2-PSK ■ EAP-PEAP with MSCHAPv2 * ■ EAP-PEAP MSCHAPv2 no server authentic. * ■ EAP-TLS * 	WPA2-PSK
WLAN passphrase	The WPA2-PSK option is selected in the Security type parameter.	Enter the network key (8 to 32 characters). The network key supplied with the device should be changed during commissioning for security reasons.	8 to 32-digit character string comprising numbers, letters and special characters (without spaces)	Serial number of the measuring device (e.g. L100A802000)
Assign SSID name	–	Select which name will be used for SSID: device tag or user-defined name.	<ul style="list-style-type: none"> ■ Device tag ■ User-defined 	User-defined
SSID name	<ul style="list-style-type: none"> ■ The User-defined option is selected in the Assign SSID name parameter. ■ The WLAN access point option is selected in the WLAN mode parameter. 	Enter the user-defined SSID name (max. 32 characters). The user-defined SSID name may only be assigned once. If the SSID name is assigned more than once, the devices can interfere with one another.	Max. 32-digit character string comprising numbers, letters and special characters	EH_device designation_last 7 digits of the serial number (e.g. EH_Promag_300_A 802000)
Apply changes	–	Use changed WLAN settings.	<ul style="list-style-type: none"> ■ Cancel ■ Ok 	Cancel

* Visibility depends on order options or device settings

10.5.7 Configuration management

After commissioning, you can save the current device configuration or restore the previous device configuration.

You can do so using the **Configuration management** parameter and the related options found in the **Configuration backup** submenu.

Navigation

"Setup" menu → Advanced setup → Configuration backup

<input style="width: 80%; height: 20px;" type="button" value="► Configuration backup"/>
<input style="width: 80%; height: 20px;" type="text" value="Operating time"/> → 114

Last backup	→ ⓘ 114
Configuration management	→ ⓘ 114
Backup state	→ ⓘ 114
Comparison result	→ ⓘ 114

Parameter overview with brief description

Parameter	Description	User interface / Selection	Factory setting
Operating time	Indicates how long the device has been in operation.	Days (d), hours (h), minutes (m) and seconds (s)	–
Last backup	Shows when the last data backup was saved to HistoROM backup.	Days (d), hours (h), minutes (m) and seconds (s)	–
Configuration management	Select action for managing the device data in the HistoROM backup.	<ul style="list-style-type: none"> ▪ Cancel ▪ Execute backup ▪ Restore * ▪ Compare * ▪ Clear backup data 	Cancel
Backup state	Shows the current status of data saving or restoring.	<ul style="list-style-type: none"> ▪ None ▪ Backup in progress ▪ Restoring in progress ▪ Delete in progress ▪ Compare in progress ▪ Restoring failed ▪ Backup failed 	None
Comparison result	Comparison of current device data with HistoROM backup.	<ul style="list-style-type: none"> ▪ Settings identical ▪ Settings not identical ▪ No backup available ▪ Backup settings corrupt ▪ Check not done ▪ Dataset incompatible 	Check not done

* Visibility depends on order options or device settings

Function scope of the "Configuration management" parameter

Options	Description
Cancel	No action is executed and the user exits the parameter.
Execute backup	A backup copy of the current device configuration is saved from the HistoROM backup to the memory of the device. The backup copy includes the transmitter data of the device.
Restore	The last backup copy of the device configuration is restored from the device memory to the device's HistoROM backup. The backup copy includes the transmitter data of the device.

Options	Description
Compare	The device configuration saved in the device memory is compared with the current device configuration of the HistoROM backup.
Clear backup data	The backup copy of the device configuration is deleted from the memory of the device.

 **HistoROM backup**
 A HistoROM is a "non-volatile" device memory in the form of an EEPROM.

 While this action is in progress, the configuration cannot be edited via the local display and a message on the processing status appears on the display.

10.5.8 Using parameters for device administration

The **Administration** submenu systematically guides the user through all the parameters that can be used for device administration purposes.

Navigation

"Setup" menu → Advanced setup → Administration

▶ Administration		
▶ Define access code		→ ⓘ 115
▶ Reset access code		→ ⓘ 116
Device reset		→ ⓘ 116

Using the parameter to define the access code

Navigation

"Setup" menu → Advanced setup → Administration → Define access code

▶ Define access code		
Define access code		→ ⓘ 115
Confirm access code		→ ⓘ 115

Parameter overview with brief description

Parameter	Description	User entry
Define access code	Restrict write-access to parameters to protect the configuration of the device against unintentional changes.	Max. 16-digit character string comprising numbers, letters and special characters
Confirm access code	Confirm the entered access code.	Max. 16-digit character string comprising numbers, letters and special characters

Using the parameter to reset the access code

Navigation

"Setup" menu → Advanced setup → Administration → Reset access code

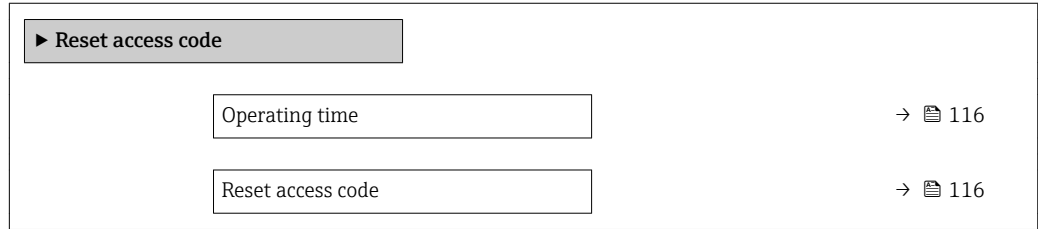

Parameter overview with brief description

Parameter	Description	User interface / User entry	Factory setting
Operating time	Indicates how long the device has been in operation.	Days (d), hours (h), minutes (m) and seconds (s)	-
Reset access code	Reset access code to factory settings.  For a reset code, contact your Endress+Hauser service organization. The reset code can only be entered via: <ul style="list-style-type: none"> ▪ Web browser ▪ DeviceCare, FieldCare (via service interface CDI-RJ45) ▪ Fieldbus 	Character string comprising numbers, letters and special characters	0x00

Using the parameter to reset the device

Navigation

"Setup" menu → Advanced setup → Administration

Parameter overview with brief description

Parameter	Description	Selection	Factory setting
Device reset	Reset the device configuration - either entirely or in part - to a defined state.	<ul style="list-style-type: none"> ▪ Cancel ▪ To delivery settings ▪ Restart device ▪ Restore S-DAT backup * 	Cancel

* Visibility depends on order options or device settings

10.6 Simulation



The **Simulation** submenu enables you to simulate, without a real flow situation, various process variables in the process and the device alarm mode and to verify downstream signal chains (switching valves or closed-control loops).

Navigation

"Diagnostics" menu → Simulation

► Simulation	
Assign simulation process variable	→ 118
Process variable value	→ 118
Status input simulation 1 to n	→ 118
Input signal level 1 to n	→ 118
Current input 1 to n simulation	→ 118
Value current input 1 to n	→ 118
Current output 1 to n simulation	→ 118
Value current output 1 to n	→ 118
Frequency output simulation 1 to n	→ 118
Frequency value 1 to n	→ 118
Pulse output simulation 1 to n	→ 118
Pulse value 1 to n	→ 118
Switch output simulation 1 to n	→ 118
Switch status 1 to n	→ 118
Relay output 1 to n simulation	→ 118
Switch status 1 to n	→ 118
Pulse output simulation	→ 119
Pulse value	→ 119
Device alarm simulation	→ 119
Diagnostic event category	→ 119
Diagnostic event simulation	→ 119

Parameter overview with brief description



Parameter	Prerequisite	Description	Selection / User entry / User interface	Factory setting
Assign simulation process variable	–	Select a process variable for the simulation process that is activated.	<ul style="list-style-type: none"> ▪ Off ▪ Volume flow ▪ Mass flow ▪ Corrected volume flow ▪ Flow velocity* ▪ Conductivity* 	Off
Process variable value	A process variable is selected in the Assign simulation process variable parameter (→  118).	Enter the simulation value for the selected process variable.	Depends on the process variable selected	0
Status input simulation 1 to n	–	Switch simulation of the status input on and off.	<ul style="list-style-type: none"> ▪ Off ▪ On 	Off
Input signal level 1 to n	In the Status input simulation parameter, the On option is selected.	Select the signal level for the simulation of the status input.	<ul style="list-style-type: none"> ▪ High ▪ Low 	High
Current input 1 to n simulation	–	Switch simulation of the current input on and off.	<ul style="list-style-type: none"> ▪ Off ▪ On 	Off
Value current input 1 to n	In the Current input 1 to n simulation parameter, the On option is selected.	Enter the current value for simulation.	0 to 22.5 mA	0 mA
Current output 1 to n simulation	–	Switch the simulation of the current output on and off.	<ul style="list-style-type: none"> ▪ Off ▪ On 	Off
Value current output 1 to n	In the Current output 1 to n simulation parameter, the On option is selected.	Enter the current value for simulation.	3.59 to 22.5 mA	3.59 mA
Frequency output simulation 1 to n	In the Operating mode parameter, the Frequency option is selected.	Switch the simulation of the frequency output on and off.	<ul style="list-style-type: none"> ▪ Off ▪ On 	Off
Frequency value 1 to n	In the Frequency output simulation 1 to n parameter, the On option is selected.	Enter the frequency value for the simulation.	0.0 to 12 500.0 Hz	0.0 Hz
Pulse output simulation 1 to n	In the Operating mode parameter, the Pulse option is selected.	Set and switch off the pulse output simulation.  For Fixed value option: Pulse width parameter (→  91) defines the pulse width of the pulses output.	<ul style="list-style-type: none"> ▪ Off ▪ Fixed value ▪ Down-counting value 	Off
Pulse value 1 to n	In the Pulse output simulation 1 to n parameter, the Down-counting value option is selected.	Enter the number of pulses for simulation.	0 to 65 535	0
Switch output simulation 1 to n	In the Operating mode parameter, the Switch option is selected.	Switch the simulation of the switch output on and off.	<ul style="list-style-type: none"> ▪ Off ▪ On 	Off
Switch status 1 to n	–	Select the status of the status output for the simulation.	<ul style="list-style-type: none"> ▪ Open ▪ Closed 	Open
Relay output 1 to n simulation	–	Switch simulation of the relay output on and off.	<ul style="list-style-type: none"> ▪ Off ▪ On 	Off
Switch status 1 to n	The On option is selected in the Switch output simulation 1 to n parameter parameter.	Select status of the relay output for the simulation.	<ul style="list-style-type: none"> ▪ Open ▪ Closed 	Open

Parameter	Prerequisite	Description	Selection / User entry / User interface	Factory setting
Pulse output simulation	–	Set and switch off the pulse output simulation.  For Fixed value option: Pulse width parameter defines the pulse width of the pulses output.	<ul style="list-style-type: none"> ▪ Off ▪ Fixed value ▪ Down-counting value 	Off
Pulse value	In the Pulse output simulation parameter, the Down-counting value option is selected.	Set and switch off the pulse output simulation.	0 to 65535	0
Device alarm simulation	–	Switch the device alarm on and off.	<ul style="list-style-type: none"> ▪ Off ▪ On 	Off
Diagnostic event category	–	Select a diagnostic event category.	<ul style="list-style-type: none"> ▪ Sensor ▪ Electronics ▪ Configuration ▪ Process 	Process
Diagnostic event simulation	–	Select a diagnostic event to simulate this event.	<ul style="list-style-type: none"> ▪ Off ▪ Diagnostic event picklist (depends on the category selected) 	Off
Logging interval	–	Define the logging interval tlog for data logging. This value defines the time interval between the individual data points in the memory.	1.0 to 3 600.0 s	–

* Visibility depends on order options or device settings

10.7 Protecting settings from unauthorized access

The following write protection options exist in order to protect the configuration of the measuring device from unintentional modification:



- Protect access to parameters via access code →  119
- Protect access to local operation via key locking →  63
- Protect access to measuring device via write protection switch →  121

10.7.1 Write protection via access code



The effects of the user-specific access code are as follows:

- Via local operation, the parameters for the measuring device configuration are write-protected and their values can no longer be changed.
- Device access is protected via the Web browser, as are the parameters for the measuring device configuration.
- Device access is protected via FieldCare or DeviceCare (via CDI-RJ45 service interface), as are the parameters for the measuring device configuration.

Defining the access code via local display

1. Navigate to the **Define access code** parameter (→  115).
2. Define a max. 16-digit character string comprising numbers, letters and special characters as the access code.
3. Enter the access code again in the **Confirm access code** parameter (→  115) to confirm the code.
 - ↳ The -symbol appears in front of all write-protected parameters.

The device automatically locks the write-protected parameters again if a key is not pressed for 10 minutes in the navigation and editing view. The device locks the write-protected parameters automatically after 60 s if the user skips back to the operational display mode from the navigation and editing view.



- i** ■ If parameter write protection is activated via an access code, it can also only be deactivated via this access code →  62.
- The user role with which the user is currently logged on via the local display →  62 is indicated by the **Access status** parameter. Navigation path: Operation → Access status

Parameters which can always be modified via the local display

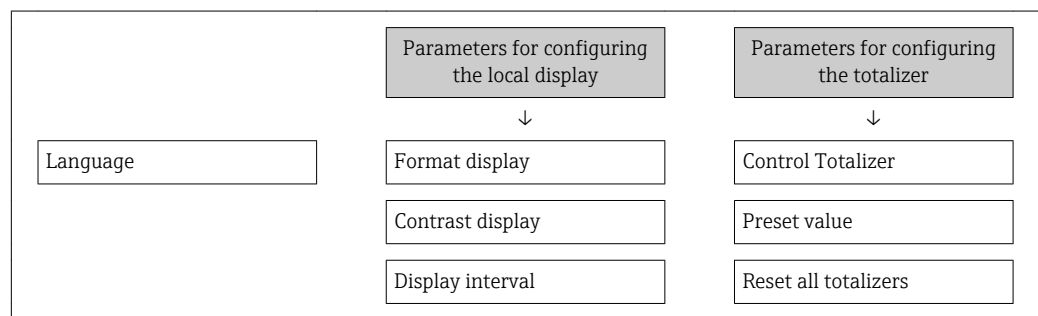
Certain parameters that do not affect the measurement are excepted from parameter write protection via the local display. Despite the user-specific access code, they can always be modified, even if the other parameters are locked.



Defining the access code via the Web browser

1. Navigate to the **Define access code** parameter (→  115).
2. Define a max. 16-digit numeric code as an access code.
3. Enter the access code again in the **Confirm access code** parameter (→  115) to confirm the code.
 - ↳ The Web browser switches to the login page.

i If no action is performed for 10 minutes, the Web browser automatically returns to the login page.



- i** ■ If parameter write protection is activated via an access code, it can also only be deactivated via this access code →  62.
- The user role with which the user is currently logged on via Web browser is indicated by the **Access status** parameter. Navigation path: Operation → Access status

Resetting the access code

If you misplace the user-specific access code, it is possible to reset the code to the factory setting. A reset code must be entered for this purpose. The user-specific access code can then be defined again afterwards.

Via Web browser, FieldCare, DeviceCare (via CDI-RJ45 service interface), fieldbus

i For a reset code, contact your Endress+Hauser service organization.

1. Navigate to the **Reset access code** parameter (→  116).
2. Enter the reset code.
 - ↳ The access code has been reset to the factory setting **0000**. It can be redefined →  119.

10.7.2 Write protection via write protection switch

Unlike parameter write protection via a user-specific access code, this allows write access to the entire operating menu - except for the **"Contrast display" parameter** - to be locked.

The parameter values are now read only and cannot be edited any more (exception **"Contrast display" parameter**):

- Via local display
- Via HART protocol

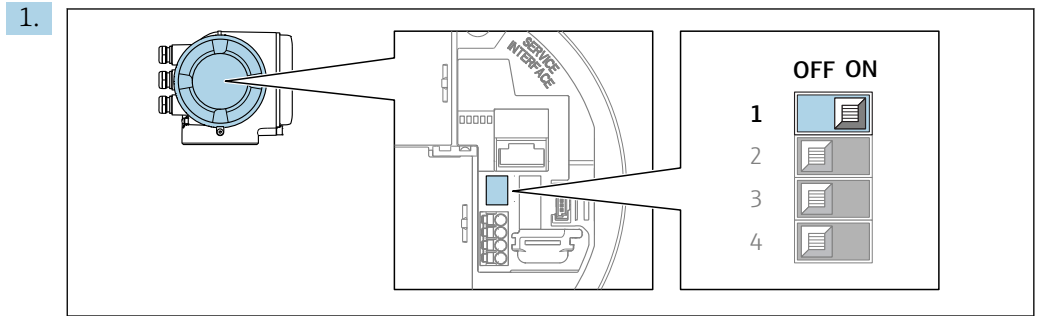

Setting the write protection (WP) switch on the main electronics module to the **ON** position enables hardware write protection.

- ↳ In the **Locking status** parameter the **Hardware locked** option is displayed → 122. In addition, on the local display the -symbol appears in front of the parameters in the header of the operational display and in the navigation view.

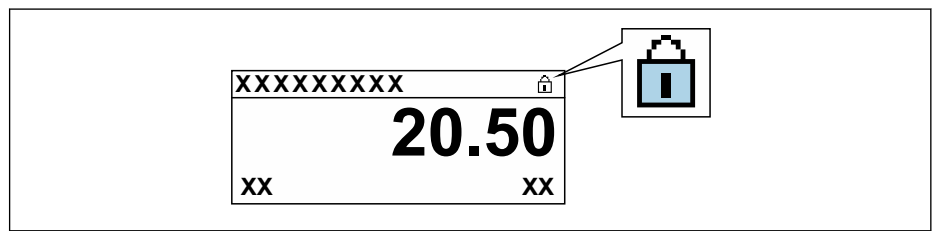

2. Setting the write protection (WP) switch on the main electronics module to the **OFF** position (factory setting) disables hardware write protection.

- ↳ No option is displayed in the **Locking status** parameter → 122. On the local display, the -symbol disappears from in front of the parameters in the header of the operational display and in the navigation view.

11 Operation

11.1 Reading the device locking status

Device active write protection: **Locking status** parameter

Operation → Locking status

Function scope of the "Locking status" parameter

Options	Description
None	The access status displayed in the Access status parameter applies → 62. Only appears on local display.
Hardware locked	The DIP switch for hardware locking is activated on the PCB board. This locks write access to the parameters (e.g. via local display or operating tool) → 121.
SIL locked	The SIL mode is enabled. This locks write access to the parameters (e.g. via local display or operating tool).
Temporarily locked	Write access to the parameters is temporarily locked on account of internal processes running in the device (e.g. data upload/download, reset etc.). Once the internal processing has been completed, the parameters can be changed once again.

11.2 Adjusting the operating language

 Detailed information:

- To configure the operating language → 81
- For information on the operating languages supported by the measuring device → 188

11.3 Configuring the display

Detailed information:

- On the basic settings for the local display → 96
- On the advanced settings for the local display → 108

11.4 Reading measured values

With the **Measured values** submenu, it is possible to read all the measured values.

11.4.1 "Process variables" submenu

The **Process variables** submenu contains all the parameters needed to display the current measured values for each process variable.

Navigation

"Diagnostics" menu → Measured values → Process variables

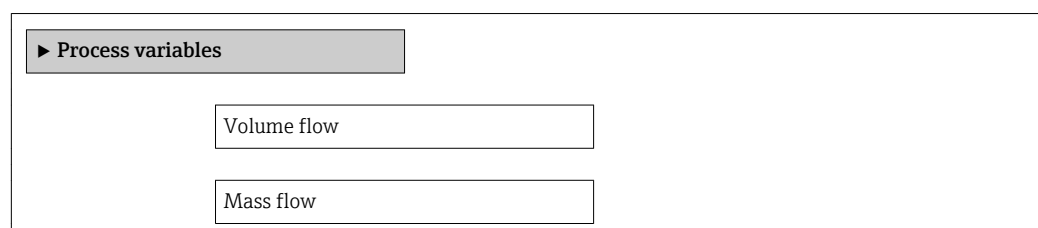

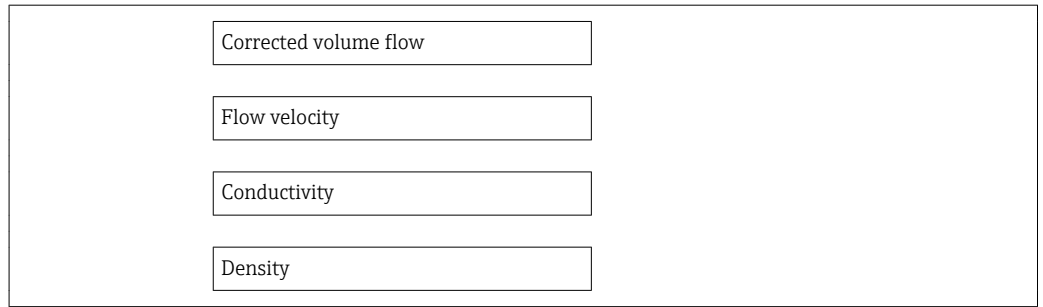

Parameter overview with brief description

Parameter	Description	User interface
Volume flow	Displays the volume flow that is currently measured. <i>Dependency</i> The unit is taken from the Volume flow unit parameter (→ 84).	Signed floating-point number
Mass flow	Displays the mass flow currently calculated. <i>Dependency</i> The unit is taken from the Mass flow unit parameter (→ 84).	Signed floating-point number
Corrected volume flow	Displays the corrected volume flow that is currently calculated. <i>Dependency</i> The unit is taken from the Corrected volume flow unit parameter.	Signed floating-point number
Flow velocity	Displays the flow velocity that is currently calculated.	Signed floating-point number
Conductivity	Displays the conductivity that is currently measured. <i>Dependency</i> The unit is taken from the Conductivity unit parameter.	Signed floating-point number
Density	Displays the current fixed density or density read in from an external device. <i>Dependency</i> The unit is taken from the Density unit parameter.	Signed floating-point number

11.4.2 "Totalizer" submenu

The **Totalizer** submenu contains all the parameters needed to display the current measured values for every totalizer.

Navigation

"Diagnostics" menu → Measured values → Totalizer

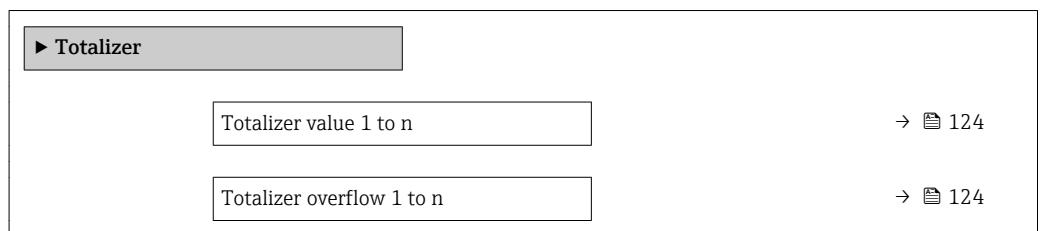

Parameter overview with brief description

Parameter	Prerequisite	Description	User interface
Totalizer value 1 to n	A process variable is selected in the Assign process variable parameter (→ 107) of the Totalizer 1 to n submenu.	Displays the current totalizer counter value.	Signed floating-point number
Totalizer overflow 1 to n	A process variable is selected in the Assign process variable parameter (→ 107) of the Totalizer 1 to n submenu.	Displays the current totalizer overflow.	Integer with sign

11.4.3 "Input values" submenu

The **Input values** submenu guides you systematically to the individual input values.

Navigation

"Diagnostics" menu → Measured values → Input values

▶ Input values	
▶ Current input 1 to n	→ 124
▶ Status input 1 to n	→ 124

Input values of current input

The **Current input 1 to n** submenu contains all the parameters needed to display the current measured values for every current input.

Navigation

"Diagnostics" menu → Measured values → Input values → Current input 1 to n

▶ Current input 1 to n	
Measured values 1 to n	→ 124
Measured current 1 to n	→ 124

Parameter overview with brief description

Parameter	Description	User interface
Measured values 1 to n	Displays the current input value.	Signed floating-point number
Measured current 1 to n	Displays the current value of the current input.	0 to 22.5 mA

Input values of status input

The **Status input 1 to n** submenu contains all the parameters needed to display the current measured values for every status input.

Navigation

"Diagnostics" menu → Measured values → Input values → Status input 1 to n

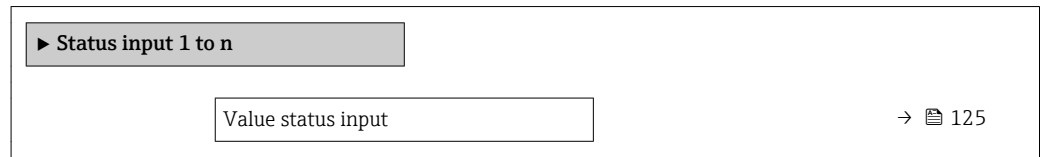

Parameter overview with brief description

Parameter	Description	User interface
Value status input	Shows the current input signal level.	<ul style="list-style-type: none"> ■ High ■ Low

11.4.4 Output values

The **Output values** submenu contains all the parameters needed to display the current measured values for every output.

Navigation

"Diagnostics" menu → Measured values → Output values

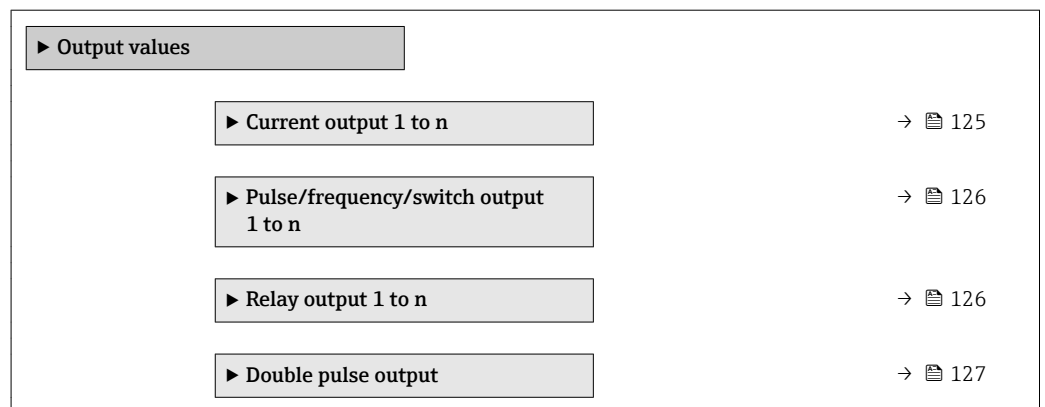

Output values of current output

The **Value current output** submenu contains all the parameters needed to display the current measured values for every current output.

Navigation

"Diagnostics" menu → Measured values → Output values → Value current output 1 to n

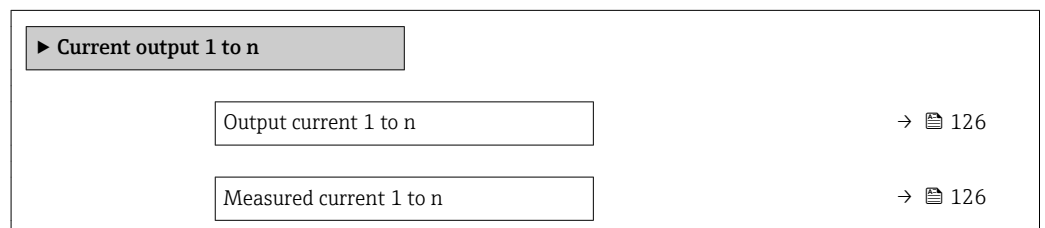

Parameter overview with brief description

Parameter	Description	User interface
Output current 1	Displays the current value currently calculated for the current output.	3.59 to 22.5 mA
Measured current	Displays the current value currently measured for the current output.	0 to 30 mA

Output values for pulse/frequency/switch output

The **Pulse/frequency/switch output 1 to n** submenu contains all the parameters needed to display the current measured values for every pulse/frequency/switch output.

Navigation

"Diagnostics" menu → Measured values → Output values → Pulse/frequency/switch output 1 to n

▶ Pulse/frequency/switch output 1 to n		
Output frequency 1 to n		→ 126
Pulse output 1 to n		→ 126
Switch status 1 to n		→ 126

Parameter overview with brief description

Parameter	Prerequisite	Description	User interface
Output frequency 1 to n	In the Operating mode parameter, the Frequency option is selected.	Displays the value currently measured for the frequency output.	0.0 to 12 500.0 Hz
Pulse output 1 to n	The Pulse option is selected in the Operating mode parameter parameter.	Displays the pulse frequency currently output.	Positive floating-point number
Switch status 1 to n	The Switch option is selected in the Operating mode parameter.	Displays the current switch output status.	<ul style="list-style-type: none"> ■ Open ■ Closed

Output values for relay output

The **Relay output 1 to n** submenu contains all the parameters needed to display the current measured values for every relay output.

Navigation

"Diagnostics" menu → Measured values → Output values → Relay output 1 to n

▶ Relay output 1 to n		
Switch status		→ 127
Switch cycles		→ 127
Max. switch cycles number		→ 127

Parameter overview with brief description

Parameter	Description	User interface
Switch status	Shows the current relay switch status.	<ul style="list-style-type: none"> ■ Open ■ Closed
Switch cycles	Shows number of all performed switch cycles.	Positive integer
Max. switch cycles number	Shows the maximal number of guaranteed switch cycles.	Positive integer

Output values for double pulse output

The **Double pulse output** submenu contains all the parameters needed to display the current measured values for every double pulse output.

Navigation

"Diagnostics" menu → Measured values → Output values → Double pulse output

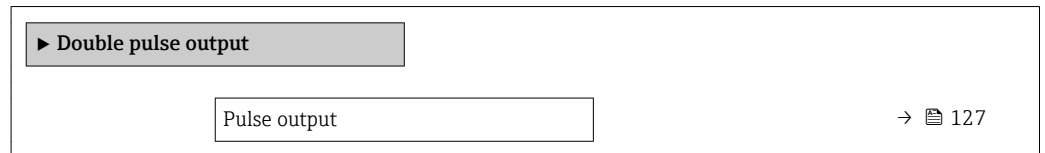

Parameter overview with brief description

Parameter	Description	User interface
Pulse output	Shows the currently output pulse frequency.	Positive floating-point number

11.5 Adapting the measuring device to the process conditions

The following are available for this purpose:

- Basic settings using the **Setup** menu (→ 📄 81)
- Advanced settings using the **Advanced setup** submenu (→ 📄 105)

11.6 Performing a totalizer reset

The totalizers are reset in the **Operation** submenu:



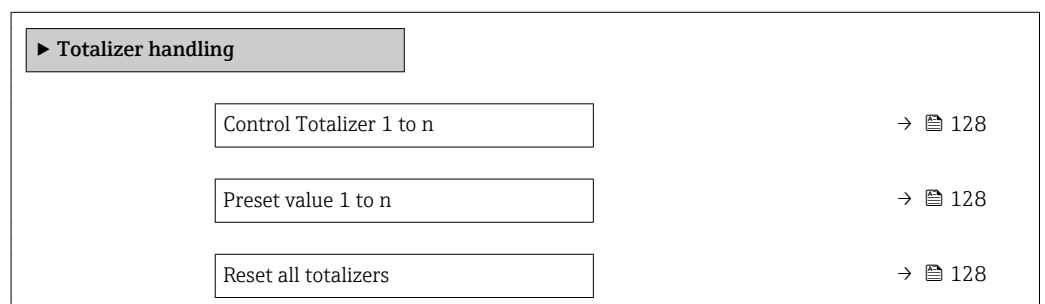

- Control Totalizer
- Reset all totalizers

Navigation

"Operation" menu → Totalizer handling



Parameter overview with brief description

Parameter	Prerequisite	Description	Selection / User entry	Factory setting
Control Totalizer 1 to n	A process variable is selected in the Assign process variable parameter (→  107) of the Totalizer 1 to n submenu.	Control totalizer value.	<ul style="list-style-type: none"> ■ Totalize ■ Reset + hold * ■ Preset + hold * ■ Reset + totalize ■ Preset + totalize * ■ Hold * 	Totalize
Preset value 1 to n	A process variable is selected in the Assign process variable parameter (→  107) of the Totalizer 1 to n submenu.	Specify start value for totalizer. <i>Dependency</i>  The unit of the selected process variable is specified for the totalizer in the Unit totalizer parameter (→  107).	Signed floating-point number	0 1
Reset all totalizers	–	Reset all totalizers to 0 and start.	<ul style="list-style-type: none"> ■ Cancel ■ Reset + totalize 	Cancel

* Visibility depends on order options or device settings

11.6.1 Function scope of the "Control Totalizer" parameter



Options	Description
Totalize	The totalizer is started or continues running.
Reset + hold	The totaling process is stopped and the totalizer is reset to 0.
Preset + hold	The totaling process is stopped and the totalizer is set to its defined start value from the Preset value parameter.
Reset + totalize	The totalizer is reset to 0 and the totaling process is restarted.
Preset + totalize	The totalizer is set to the defined start value from the Preset value parameter and the totaling process is restarted.
Hold	Totalizing is stopped.

11.6.2 Function scope of the "Reset all totalizers" parameter

Options	Description
Cancel	No action is executed and the user exits the parameter.
Reset + totalize	Resets all totalizers to 0 and restarts the totaling process. This deletes all the flow values previously totalized.

11.7 Showing data logging

The **Extended HistoROM** application package must be enabled in the device (order option) for the **Data logging** submenu to appear. This contains all the parameters for the measured value history.

-  Data logging is also available via:
- Plant Asset Management Tool FieldCare →  73.
 - Web browser

Function range

- A total of 1000 measured values can be stored
- 4 logging channels
- Adjustable logging interval for data logging
- Displays the measured value trend for each logging channel in the form of a chart

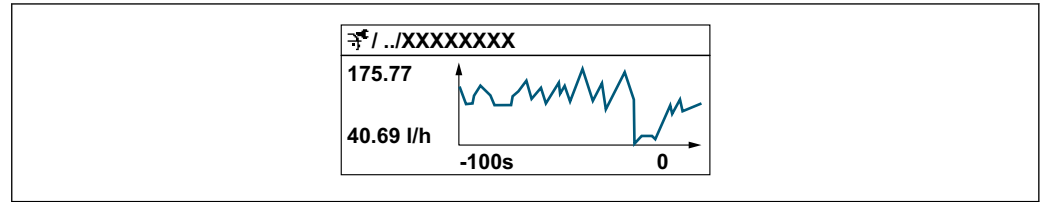

A0094352

- x-axis: depending on the number of channels selected displays 250 to 1000 measured values of a process variable.
- y-axis: displays the approximate measured value span and constantly adapts this to the ongoing measurement.

i If the length of the logging interval or the assignment of the process variables to the channels is changed, the content of the data logging is deleted.

Navigation





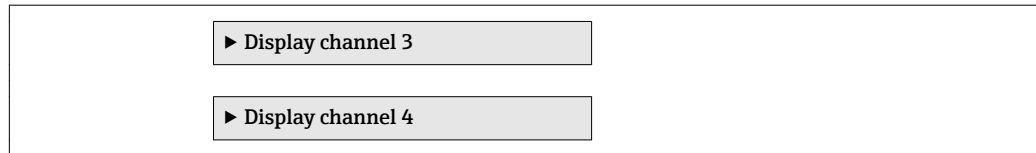

"Diagnostics" menu → Data logging

▶ **Data logging**

Assign channel 1	→ 130
Assign channel 2	→ 130
Assign channel 3	→ 130
Assign channel 4	→ 130
Logging interval	→ 130
Clear logging data	→ 131
Data logging	→ 131
Logging delay	→ 131
Data logging control	→ 131
Data logging status	→ 131
Entire logging duration	→ 131
▶ Display channel 1	
▶ Display channel 2	



Parameter overview with brief description

Parameter	Prerequisite	Description	Selection / User entry / User interface	Factory setting
Assign channel 1	The Extended HistoROM application package is available.	Assign process variable to logging channel.	<ul style="list-style-type: none"> ▪ Off ▪ Volume flow ▪ Mass flow ▪ Corrected volume flow ▪ Flow velocity* ▪ Conductivity* ▪ Electronic temperature ▪ Current output 1* ▪ Current output 2* ▪ Current output 3* ▪ Noise* ▪ Coil current shot time* ▪ Reference electrode potential against PE* ▪ Coating measured value* ▪ Test point 1 ▪ Test point 2 ▪ Test point 3 	Off
Assign channel 2	The Extended HistoROM application package is available.  The software options currently enabled are displayed in the Software option overview parameter.	Assign process variable to logging channel.	Picklist, see Assign channel 1 parameter (→  130)	Off
Assign channel 3	The Extended HistoROM application package is available.  The software options currently enabled are displayed in the Software option overview parameter.	Assign process variable to logging channel.	Picklist, see Assign channel 1 parameter (→  130)	Off
Assign channel 4	The Extended HistoROM application package is available.  The software options currently enabled are displayed in the Software option overview parameter.	Assign process variable to logging channel.	Picklist, see Assign channel 1 parameter (→  130)	Off
Logging interval	The Extended HistoROM application package is available.	Define the logging interval for data logging. This value defines the time interval between the individual data points in the memory.	0.1 to 3 600.0 s	1.0 s

Parameter	Prerequisite	Description	Selection / User entry / User interface	Factory setting
Clear logging data	The Extended HistoROM application package is available.	Clear the entire logging data.	<ul style="list-style-type: none"> ■ Cancel ■ Clear data 	Cancel
Data logging	–	Select the data logging method.	<ul style="list-style-type: none"> ■ Overwriting ■ Not overwriting 	Overwriting
Logging delay	In the Data logging parameter, the Not overwriting option is selected.	Enter the time delay for measured value logging.	0 to 999 h	0 h
Data logging control	In the Data logging parameter, the Not overwriting option is selected.	Start and stop measured value logging.	<ul style="list-style-type: none"> ■ None ■ Delete + start ■ Stop 	None
Data logging status	In the Data logging parameter, the Not overwriting option is selected.	Displays the measured value logging status.	<ul style="list-style-type: none"> ■ Done ■ Delay active ■ Active ■ Stopped 	Done
Entire logging duration	In the Data logging parameter, the Not overwriting option is selected.	Displays the total logging duration.	Positive floating-point number	0 s

* Visibility depends on order options or device settings

12 Diagnostics and troubleshooting

12.1 General troubleshooting

For local display

Error	Possible causes	Solution
Local display dark and no output signals	Supply voltage does not match the value indicated on the nameplate.	Apply the correct supply voltage → 39.
Local display dark and no output signals	The polarity of the supply voltage is wrong.	Correct the polarity.
Local display dark and no output signals	No contact between connecting cables and terminals.	Check the connection of the cables and correct if necessary.
Local display dark and no output signals	Terminals are not plugged into the I/O electronics module correctly. Terminals are not plugged into the main electronics module correctly.	Check terminals.
Local display dark and no output signals	I/O electronics module is defective. Main electronics module is defective.	Order spare part → 156.
Local display is dark, but signal output is within the valid range	Display is set too bright or too dark.	<ul style="list-style-type: none"> ▪ Set the display brighter by simultaneously pressing $\square + \square$. ▪ Set the display darker by simultaneously pressing $\square + \square$.
Local display is dark, but signal output is within the valid range	The cable of the display module is not plugged in correctly.	Insert the plug correctly into the main electronics module and display module.
Local display is dark, but signal output is within the valid range	Display module is defective.	Order spare part → 156.
Backlighting of local display is red	Diagnostic event with "Alarm" diagnostic behavior has occurred.	Take remedial measures → 142
Text on local display appears in a foreign language and cannot be understood.	Incorrect operating language is configured.	<ol style="list-style-type: none"> 1. Press $\square + \square$ for 2 s ("home position"). 2. Press \square. 3. Set the desired language in the Display language parameter (→ 110).
Message on local display: "Communication Error" "Check Electronics"	Communication between the display module and the electronics is interrupted.	<ul style="list-style-type: none"> ▪ Check the cable and the connector between the main electronics module and display module. ▪ Order spare part → 156.

For output signals

Error	Possible causes	Solution
Signal output outside the valid range	Main electronics module is defective.	Order spare part → 156.
Signal output outside the valid current range ($< 3.6 \text{ mA}$ or $> 22 \text{ mA}$)	Main electronics module is defective. I/O electronics module is defective.	Order spare part → 156.

Error	Possible causes	Solution
Device shows correct value on local display, but signal output is incorrect, though in the valid range.	Configuration error	Check and correct the parameter configuration.
Device measures incorrectly.	Configuration error or device is operated outside the application.	1. Check and correct parameter configuration. 2. Observe limit values specified in the "Technical Data".

For access

Error	Possible causes	Solution
No write access to parameters	Hardware write protection enabled	Set the write protection switch on main electronics module to the OFF position → 121.
No write access to parameters	Current user role has limited access authorization	1. Check user role → 62. 2. Enter correct customer-specific access code → 62.
No connection via HART protocol	Communication resistor missing or incorrectly installed.	Install the communication resistor (250 Ω) correctly. Observe the maximum load → 167.
No connection via HART protocol	Commubox <ul style="list-style-type: none"> ▪ Connected incorrectly ▪ Configured incorrectly ▪ Drivers not installed correctly ▪ USB interface on computer configured incorrectly 	Observe the documentation for the Commubox.  FXA195 HART: Document "Technical Information" TI00404F
Not connecting to Web server	Web server disabled	Using the "FieldCare" or "DeviceCare" operating tool, check whether the Web server of the measuring device is enabled, and enable it if necessary → 69.
	Incorrect setting for the Ethernet interface of the computer	1. Check the properties of the Internet protocol (TCP/IP) → 65 → 65. 2. Check the network settings with the IT manager.
Not connecting to Web server	Incorrect IP address	Check the IP address: 192.168.1.212 → 65 → 65
Not connecting to Web server	Incorrect WLAN access data	<ul style="list-style-type: none"> ▪ Check WLAN network status. ▪ Log on to the device again using WLAN access data. ▪ Verify that WLAN is enabled on the measuring device and operating device → 65.
	WLAN communication disabled	–
Not connecting to Web server, FieldCare or DeviceCare	No WLAN network available	<ul style="list-style-type: none"> ▪ Check if WLAN reception is present: LED on display module is lit blue ▪ Check if WLAN connection is enabled: LED on display module flashes blue ▪ Switch on instrument function.
Network connection not present or unstable	WLAN network is weak.	<ul style="list-style-type: none"> ▪ Operating device is outside of reception range: Check network status on operating device. ▪ To improve network performance, use an external WLAN antenna.

Error	Possible causes	Solution
	Parallel WLAN and Ethernet communication	<ul style="list-style-type: none"> Check network settings. Temporarily enable only the WLAN as an interface.
Web browser frozen and operation no longer possible	Data transfer active	Wait until data transfer or current action is finished.
	Connection lost	<ol style="list-style-type: none"> Check cable connection and power supply. Refresh the Web browser and restart if necessary.
Content of Web browser incomplete or difficult to read	Not using optimum version of Web server.	<ol style="list-style-type: none"> Use the correct Web browser version → 64. Clear the Web browser cache and restart the Web browser.
	Unsuitable view settings.	Change the font size/display ratio of the Web browser.
No or incomplete display of contents in the Web browser	<ul style="list-style-type: none"> JavaScript not enabled JavaScript cannot be enabled 	<ol style="list-style-type: none"> Enable JavaScript. Enter http://XXX.XXX.X.XXX/basic.html as the IP address.
Operation with FieldCare or DeviceCare via CDI-RJ45 service interface (port 8000)	Firewall of computer or network is preventing communication	Depending on the settings of the firewall used on the computer or in the network, the firewall must be adapted or disabled to allow FieldCare/DeviceCare access.
Flashing of firmware with FieldCare or DeviceCare via CDI-RJ45 service interface (via port 8000 or TFTP ports)	Firewall of computer or network is preventing communication	Depending on the settings of the firewall used on the computer or in the network, the firewall must be adapted or disabled to allow FieldCare/DeviceCare access.

12.2 Diagnostic information via light emitting diodes

12.2.1 Transmitter

Different LEDs in the transmitter provide information on the device status.

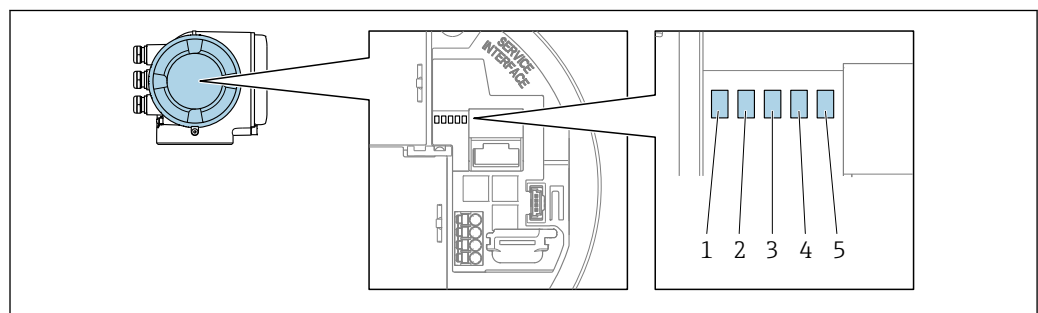

A0029629

- 1 Supply voltage
- 2 Device status
- 3 Not used
- 4 Communication
- 5 Service interface (CDI) active

LED	Color	Meaning
1 Supply voltage	Off	Supply voltage is off or too low.
	Green	Supply voltage is ok.

LED	Color	Meaning
2 Device status (normal operation)	Off	Firmware error
	Green	Device status is ok.
	Flashing green	Device is not configured.
	Red	A diagnostic event with "Alarm" diagnostic behavior has occurred.
	Flashing red	A diagnostic event with "Warning" diagnostic behavior has occurred.
	Flashing red/green	The device restarts.
2 Device status (during start-up)	Flashes red slowly	If > 30 seconds: problem with the boot loader.
	Flashes red quickly	If > 30 seconds: compatibility problem when reading the firmware.
3 Not used	–	–
4 Communication	Off	Communication not active.
	White	Communication active.
5 Service interface (CDI)	Off	Not connected or no connection established.
	Yellow	Connected and connection established.
	Flashing yellow	Service interface active.

12.3 Diagnostic information on local display

12.3.1 Diagnostic message

Faults detected by the self-monitoring system of the measuring device are displayed as a diagnostic message in alternation with the operational display.

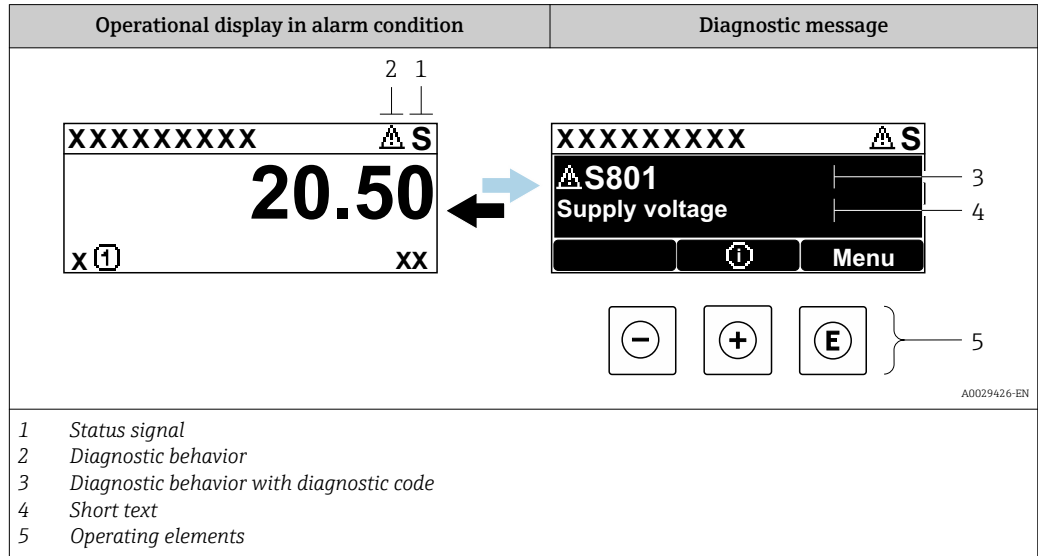

If two or more diagnostic events are pending simultaneously, only the message of the diagnostic event with the highest priority is shown.

- i** Other diagnostic events that have occurred can be displayed in the **Diagnostics** menu:
 - Via parameter → 146
 - Via submenus → 147



Status signals

The status signals provide information on the state and reliability of the device by categorizing the cause of the diagnostic information (diagnostic event).

- i** The status signals are categorized according to VDI/VDE 2650 and NAMUR Recommendation NE 107: F = Failure, C = Function Check, S = Out of Specification, M = Maintenance Required

Symbol	Meaning
F	Failure A device error has occurred. The measured value is no longer valid.
C	Function check The device is in service mode (e.g. during a simulation).
S	Out of specification The device is operated: <ul style="list-style-type: none"> ▪ Outside its technical specification limits (e.g. outside the process temperature range) ▪ Outside of the configuration carried out by the user (e.g. maximum flow in parameter 20 mA value)
M	Maintenance required Maintenance is required. The measured value remains valid.

Diagnostic behavior



Symbol	Meaning
	Alarm <ul style="list-style-type: none"> Measurement is interrupted. Signal outputs and totalizers assume the defined alarm condition. A diagnostic message is generated.
	Warning Measurement is resumed. The signal outputs and totalizers are not affected. A diagnostic message is generated.

Diagnostic information

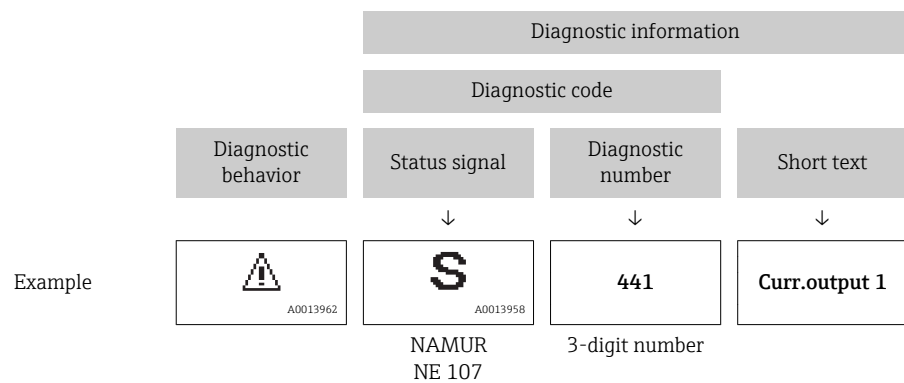
The fault can be identified using the diagnostic information. The short text helps you by providing information about the fault. In addition, the corresponding symbol for the diagnostic behavior is displayed in front of the diagnostic information on the local display.



Operating elements

Key	Meaning
	Plus key <i>In a menu, submenu</i> Opens the message about remedy information.
	Enter key <i>In a menu, submenu</i> Opens the operating menu.

12.3.2 Calling up remedial measures

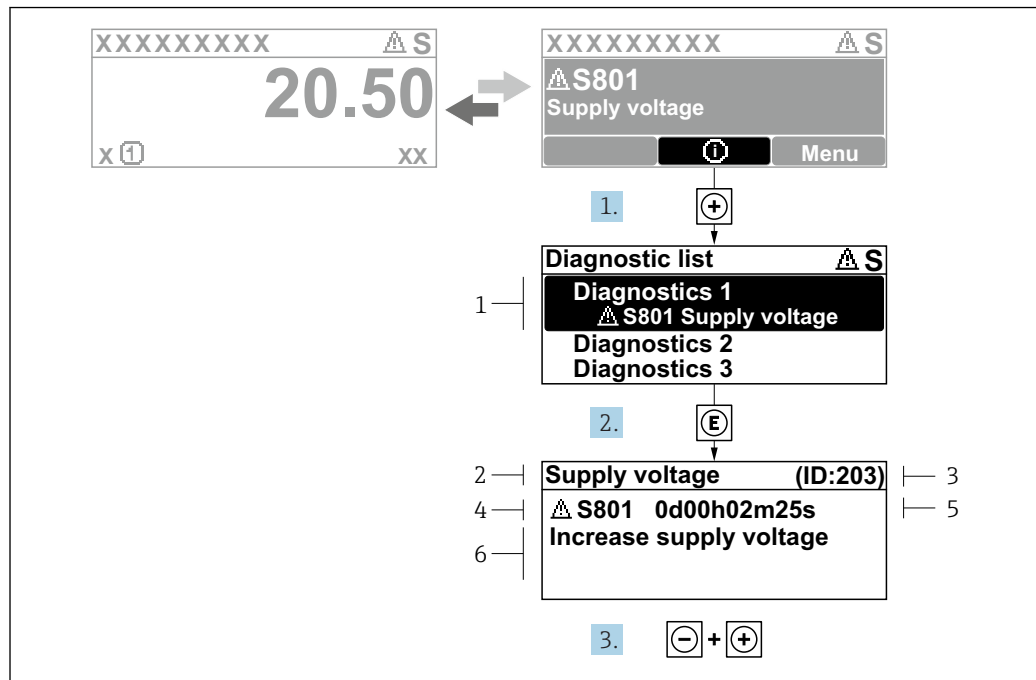

33 Message about remedial measures

- 1 Diagnostic information
- 2 Short text
- 3 Service ID
- 4 Diagnostic behavior with diagnostic code
- 5 Operation time of occurrence
- 6 Remedial measures

1. The user is in the diagnostic message.
Press **+** (i symbol).
↳ The **Diagnostic list** submenu opens.
2. Select the desired diagnostic event with **+** or **-** and press **E**.
↳ The message about the remedial measures opens.
3. Press **-** + **+** simultaneously.
↳ The message about the remedial measures closes.

The user is in the **Diagnostics** menu at an entry for a diagnostics event, e.g. in the **Diagnostic list** submenu or **Previous diagnostics** parameter.

1. Press **E**.
↳ The message for the remedial measures for the selected diagnostic event opens.
2. Press **-** + **+** simultaneously.
↳ The message for the remedial measures closes.

12.4 Diagnostic information in the Web browser

12.4.1 Diagnostic options

Any faults detected by the measuring device are displayed in the Web browser on the home page once the user has logged on.

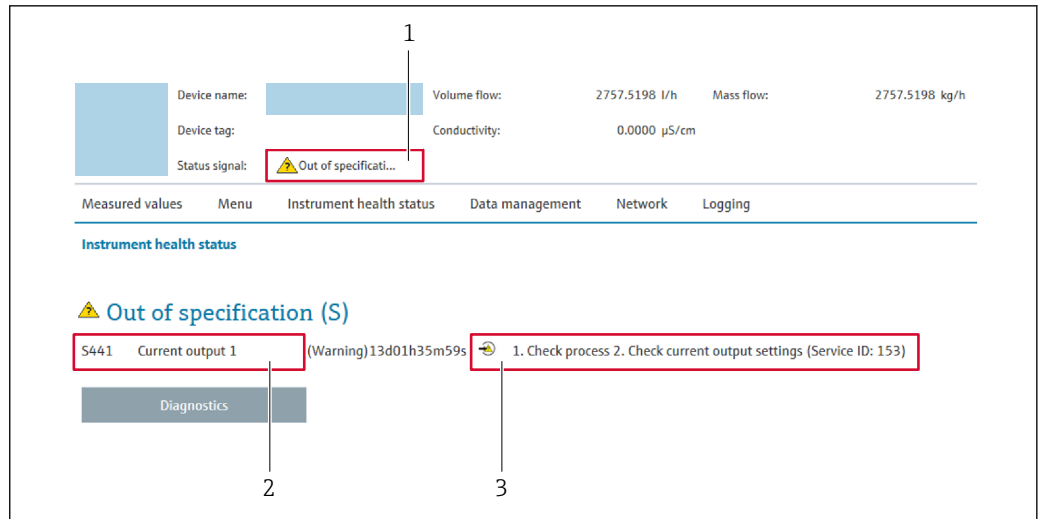

- 1 Status area with status signal
- 2 Diagnostic information
- 3 Remedy information with Service ID

i In addition, diagnostic events which have occurred can be shown in the **Diagnostics** menu:

- Via parameter → 146
- Via submenu → 147

Status signals

The status signals provide information on the state and reliability of the device by categorizing the cause of the diagnostic information (diagnostic event).

Symbol	Meaning
	Failure A device error has occurred. The measured value is no longer valid.
	Function check The device is in service mode (e.g. during a simulation).
	Out of specification The device is operated: <ul style="list-style-type: none"> ▪ Outside its technical specification limits (e.g. outside the process temperature range) ▪ Outside of the configuration carried out by the user (e.g. maximum flow in parameter 20 mA value)
	Maintenance required Maintenance is required. The measured value is still valid.

i The status signals are categorized in accordance with VDI/VDE 2650 and NAMUR Recommendation NE 107.

12.4.2 Calling up remedy information

Remedy information is provided for every diagnostic event to ensure that problems can be rectified quickly. These measures are displayed in red along with the diagnostic event and the related diagnostic information.

12.5 Diagnostic information in FieldCare or DeviceCare

12.5.1 Diagnostic options

Any faults detected by the measuring device are displayed on the home page of the operating tool once the connection has been established.

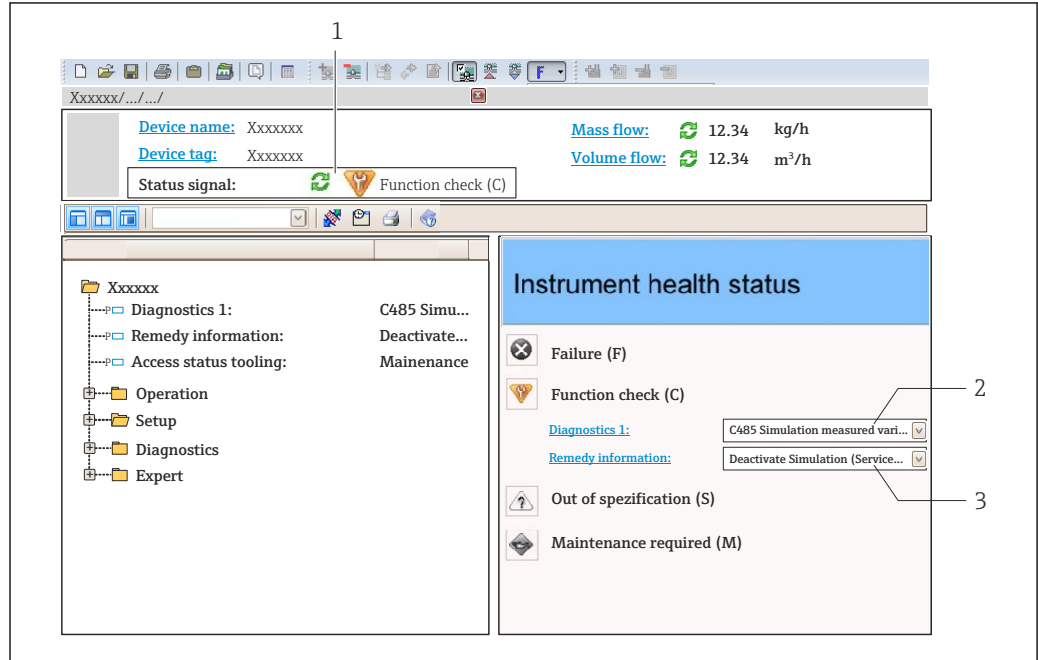

- 1 Status area with status signal → 136
- 2 Diagnostic information → 137
- 3 Remedy information with Service ID

i In addition, diagnostic events which have occurred can be shown in the **Diagnostics** menu:

- Via parameter → 146
- Via submenu → 147

Diagnostic information

The fault can be identified using the diagnostic information. The short text helps you by providing information about the fault. In addition, the corresponding symbol for the diagnostic behavior is displayed in front of the diagnostic information on the local display.

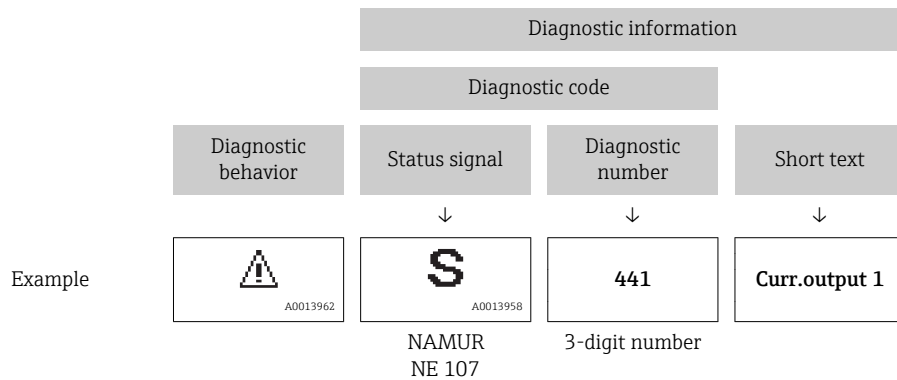

12.5.2 Calling up remedy information

Remedy information is provided for every diagnostic event to ensure that problems can be rectified quickly:

- On the home page
Remedy information is displayed in a separate field below the diagnostics information.
- In the **Diagnostics** menu
Remedy information can be called up in the working area of the user interface.

The user is in the **Diagnostics** menu.

1. Call up the desired parameter.
2. On the right in the working area, mouse over the parameter.
 - ↳ A tool tip with remedy information for the diagnostic event appears.

12.6 Adapting the diagnostic information

12.6.1 Adapting the diagnostic behavior

Each item of diagnostic information is assigned a specific diagnostic behavior at the factory. The user can change this assignment for specific diagnostic information in the **Diagnostic behavior** submenu.

Expert → System → Diagnostic handling → Diagnostic behavior

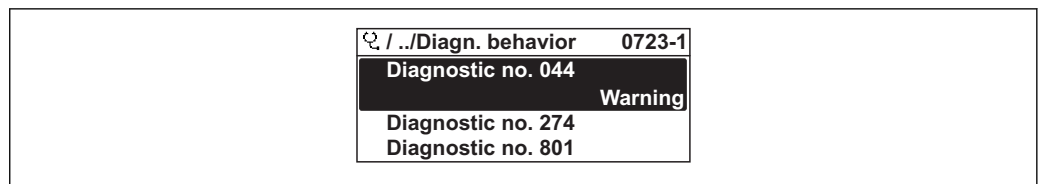

A0014048-EN

34 Taking the example of the local display

You can assign the following options to the diagnostic number as the diagnostic behavior:

Options	Description
Alarm	The device stops measurement. The signal outputs and totalizers assume the defined alarm condition. A diagnostic message is generated. The background lighting changes to red.
Warning	The device continues to measure. The signal outputs and totalizers are not affected. A diagnostic message is generated.
Logbook entry only	The device continues to measure. The diagnostic message is displayed only in the Event logbook submenu (Event list submenu) and is not displayed in alternation with the operational display.
Off	The diagnostic event is ignored, and no diagnostic message is generated or entered.

12.6.2 Adapting the status signal

Each item of diagnostic information is assigned a specific status signal at the factory. The user can change this assignment for specific diagnostic information in the **Diagnostic event category** submenu.

Expert → Communication → Diagnostic event category

Available status signals

Configuration as per HART 7 Specification (Condensed Status), in accordance with NAMUR NE107.

Symbol	Meaning
F <small>A0013956</small>	Failure A device error is present. The measured value is no longer valid.
C <small>A0013959</small>	Function check The device is in service mode (e.g. during a simulation).
S <small>A0013958</small>	Out of specification The device is being operated: <ul style="list-style-type: none"> ▪ Outside its technical specification limits (e.g. outside the process temperature range) ▪ Outside of the configuration carried out by the user (e.g. maximum flow in parameter 20 mA value)
M <small>A0013957</small>	Maintenance required Maintenance is required. The measured value is still valid.
N <small>A0023076</small>	Has no effect on the condensed status.

12.7 Overview of diagnostic information

 The amount of diagnostic information and the number of measured variables affected increase if the measuring device has one or more application packages.

 In the case of some items of diagnostic information, the status signal and the diagnostic behavior can be changed. Change the diagnostic information →  141

Diagnostic number	Short text	Remedy instructions	Status signal [from the factory]	Diagnostic behavior [from the factory]
Diagnostic of sensor				
043	Sensor short circuit	1. Check sensor cable and sensor 2. Execute Heartbeat Verification 3. Replace sensor cable or sensor	S	Warning ¹⁾
082	Data storage	1. Check module connections 2. Contact service	F	Alarm
083	Memory content	1. Restart device 2. Restore HistoROM S-DAT backup ('Device reset' parameter) 3. Replace HistoROM S-DAT	F	Alarm
168	Coating detected	Clean measuring tube	M	Warning
169	Conductivity measurement failed	1. Check grounding conditions 2. Deactivate conductivity measurement	M	Warning
170	Coil resistance	Check ambient and process temperature	F	Alarm
180	Temperature sensor defective	1. Check sensor connections 2. Replace sensor cable or sensor 3. Turn off temperature measurement	F	Warning
181	Sensor connection	1. Check sensor cable and sensor 2. Execute Heartbeat Verification 3. Replace sensor cable or sensor	F	Alarm

Diagnostic number	Short text	Remedy instructions	Status signal [from the factory]	Diagnostic behavior [from the factory]
Diagnostic of electronic				
201	Device failure	1. Restart device 2. Contact service	F	Alarm
242	Software incompatible	1. Check software 2. Flash or change main electronics module	F	Alarm
252	Modules incompatible	1. Check electronic modules 2. Check if correct modules are available (e.g. NEx, Ex) 3. Replace electronic modules	F	Alarm
252	Modules incompatible	1. Check if correct electronic modul is plugged 2. Replace electronic module	F	Alarm
262	Sensor electronic connection faulty	1. Check or replace connection cable between sensor electronic module (ISEM) and main electronics 2. Check or replace ISEM or main electronics	F	Alarm
270	Main electronic failure	Change main electronic module	F	Alarm
271	Main electronic failure	1. Restart device 2. Change main electronic module	F	Alarm
272	Main electronic failure	1. Restart device 2. Contact service	F	Alarm
273	Main electronic failure	Change electronic	F	Alarm
275	I/O module 1 to n defective	Change I/O module	F	Alarm
276	I/O module 1 to n faulty	1. Restart device 2. Change I/O module	F	Alarm
283	Memory content	1. Reset device 2. Contact service	F	Alarm
302	Device verification active	Device verification active, please wait.	C	Warning
303	I/O 1 to n configuration changed	1. Apply I/O module configuration (parameter 'Apply I/O configuration') 2. Afterwards reload device description and check wiring	M	Warning
311	Electronic failure	1. Do not reset device 2. Contact service	M	Warning
332	Writing in HistoROM backup failed	Replace user interface board Ex d/XP: replace transmitter	F	Alarm
361	I/O module 1 to n faulty	1. Restart device 2. Check electronic modules 3. Change I/O Modul or main electronics	F	Alarm
372	Sensor electronic (ISEM) faulty	1. Restart device 2. Check if failure recurs 3. Replace sensor electronic module (ISEM)	F	Alarm
373	Sensor electronic (ISEM) faulty	1. Transfer data or reset device 2. Contact service	F	Alarm

Diagnostic number	Short text	Remedy instructions	Status signal [from the factory]	Diagnostic behavior [from the factory]
375	I/O- 1 to n communication failed	1. Restart device 2. Check if failure recurs 3. Replace module rack inclusive electronic modules	F	Alarm
376	Sensor electronic (ISEM) faulty	1. Replace sensor electronic module (ISEM) 2. Turn off diagnostic message	S	Warning ¹⁾
377	Sensor electronic (ISEM) faulty	1. Activate empty pipe detection 2. Check partial filled pipe and installation direction 3. Check sensor cabling 4. Deactivate diagnostic 377	S	Warning ¹⁾
378	Supply voltage ISEM faulty	Check supply voltage to the ISEM	F	Alarm
382	Data storage	1. Insert T-DAT 2. Replace T-DAT	F	Alarm
383	Memory content	1. Restart device 2. Delete T-DAT via 'Reset device' parameter 3. Replace T-DAT	F	Alarm
387	HistoROM data faulty	Contact service organization	F	Alarm
512	Sensor electronic (ISEM) faulty	1. Check ECC recovery time 2. Turn off ECC	F	Alarm
Diagnostic of configuration				
330	Flash file invalid	1. Update firmware of device 2. Restart device	M	Warning
331	Firmware update failed	1. Update firmware of device 2. Restart device	F	Warning
410	Data transfer	1. Check connection 2. Retry data transfer	F	Alarm
412	Processing download	Download active, please wait	C	Warning
431	Trim 1 to n	Carry out trim	C	Warning
437	Configuration incompatible	1. Restart device 2. Contact service	F	Alarm
438	Dataset	1. Check data set file 2. Check device configuration 3. Up- and download new configuration	M	Warning
441	Current output 1 to n	1. Check process 2. Check current output settings	S	Warning ¹⁾
442	Frequency output 1 to n	1. Check process 2. Check frequency output settings	S	Warning ¹⁾
443	Pulse output 1 to n	1. Check process 2. Check pulse output settings	S	Warning ¹⁾
444	Current input 1 to n	1. Check process 2. Check current input settings	S	Warning ¹⁾
453	Flow override	Deactivate flow override	C	Warning
484	Failure mode simulation	Deactivate simulation	C	Alarm
485	Measured variable simulation	Deactivate simulation	C	Warning

Diagnostic number	Short text	Remedy instructions	Status signal [from the factory]	Diagnostic behavior [from the factory]
486	Current input 1 to n simulation	Deactivate simulation	C	Warning
491	Current output 1 to n simulation	Deactivate simulation	C	Warning
492	Simulation frequency output 1 to n	Deactivate simulation frequency output	C	Warning
493	Simulation pulse output 1 to n	Deactivate simulation pulse output	C	Warning
494	Switch output simulation 1 to n	Deactivate simulation switch output	C	Warning
495	Diagnostic event simulation	Deactivate simulation	C	Warning
496	Status input simulation	Deactivate simulation status input	C	Warning
502	CT activation/deactivation failed	Follow the sequence of the custody transfer activation/deactivation: First authorized user login, then set the DIP switch on the main electronic module	C	Warning
511	ISEM settings faulty	1. Check measuring period and integration time 2. Check sensor properties	C	Alarm
520	I/O 1 to n hardware configuration invalid	1. Check I/O hardware configuration 2. Replace wrong I/O module 3. Plug the module of double pulse output on correct slot	F	Alarm
530	Electrode cleaning is running	Turn off ECC	C	Warning
531	Empty pipe adjustment faulty	Execute EPD adjustment	S	Warning ¹⁾
537	Configuration	1. Check IP addresses in network 2. Change IP address	F	Warning
540	Custody transfer mode failed	1. Power off device and toggle DIP switch 2. Deactivate custody transfer mode 3. Reactivate custody transfer mode 4. Check electronic components	F	Alarm
543	Double pulse output	1. Check process 2. Check pulse output settings	S	Warning ¹⁾
593	Double pulse output simulation	Deactivate simulation pulse output	C	Warning
594	Relay output simulation	Deactivate simulation switch output	C	Warning
599	Custody transfer logbook full	1. Deactivate custody transfer mode 2. Clear custody transfer logbook (all 30 entries) 3. Activate custody transfer mode	F	Warning
Diagnostic of process				
803	Current loop	1. Check wiring 2. Change I/O module	F	Alarm
832	Electronic temperature too high	Reduce ambient temperature	S	Warning ¹⁾
833	Electronic temperature too low	Increase ambient temperature	S	Warning ¹⁾





Diagnostic number	Short text	Remedy instructions	Status signal [from the factory]	Diagnostic behavior [from the factory]
834	Process temperature too high	Reduce process temperature	S	Warning ¹⁾
835	Process temperature too low	Increase process temperature	S	Warning ¹⁾
842	Process limit	Low flow cut off active! 1. Check low flow cut off configuration	S	Warning ¹⁾
882	Input signal	1. Check input configuration 2. Check external device or process conditions	F	Alarm
937	Sensor symmetry	1. Eliminate external magnetic field near sensor 2. Turn off diagnostic message	S	Warning ¹⁾
938	EMC interference	1. Check ambient conditions regarding EMC influence 2. Turn off diagnostic message	F	Alarm ¹⁾
961	Electrode potential out of specification	1. Check process conditions 2. Check ambient conditions	S	Warning ¹⁾
962	Pipe empty	1. Perform full pipe adjustment 2. Perform empty pipe adjustment 3. Turn off empty pipe detection	S	Warning ¹⁾



1) Diagnostic behavior can be changed.

12.8 Pending diagnostic events

The **Diagnostics** menu allows the user to view the current diagnostic event and the previous diagnostic event separately.





 To call up the measures to rectify a diagnostic event:

- Via local display →  138
- Via Web browser →  139
- Via "FieldCare" operating tool →  141
- Via "DeviceCare" operating tool →  141

 Other pending diagnostic events can be displayed in the **Diagnostic list** submenu →  147

Navigation

"Diagnostics" menu

 Diagnostics	
Actual diagnostics	→  147
Previous diagnostics	→  147
Operating time from restart	→  147
Operating time	→  147

Parameter overview with brief description

Parameter	Prerequisite	Description	User interface
Actual diagnostics	A diagnostic event has occurred.	Shows the current occurred diagnostic event along with its diagnostic information.  If two or more messages occur simultaneously, the message with the highest priority is shown on the display.	Symbol for diagnostic behavior, diagnostic code and short message.
Previous diagnostics	Two diagnostic events have already occurred.	Shows the diagnostic event that occurred prior to the current diagnostic event along with its diagnostic information.	Symbol for diagnostic behavior, diagnostic code and short message.
Operating time from restart	–	Shows the time the device has been in operation since the last device restart.	Days (d), hours (h), minutes (m) and seconds (s)
Operating time	–	Indicates how long the device has been in operation.	Days (d), hours (h), minutes (m) and seconds (s)

12.9 Diagnostic list

Up to 5 currently pending diagnostic events can be displayed in the **Diagnostic list** submenu along with the associated diagnostic information. If more than 5 diagnostic events are pending, the events with the highest priority are shown on the display.

Navigation path



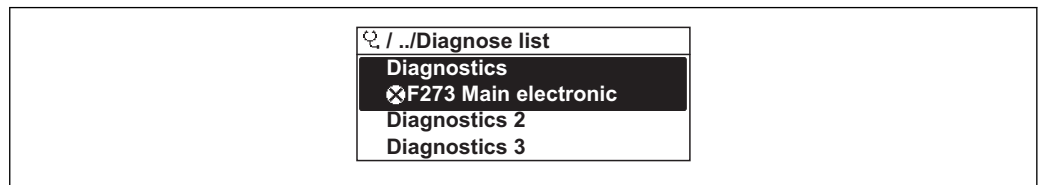

Diagnostics → Diagnostic list



A0014006-EN

 35 Taking the example of the local display

 To call up the measures to rectify a diagnostic event:

- Via local display →  138
- Via Web browser →  139
- Via "FieldCare" operating tool →  141
- Via "DeviceCare" operating tool →  141

12.10 Event logbook

12.10.1 Reading out the event logbook

A chronological overview of the event messages that have occurred is provided in the **Events list** submenu.

Navigation path

Diagnostics menu → **Event logbook** submenu → Event list

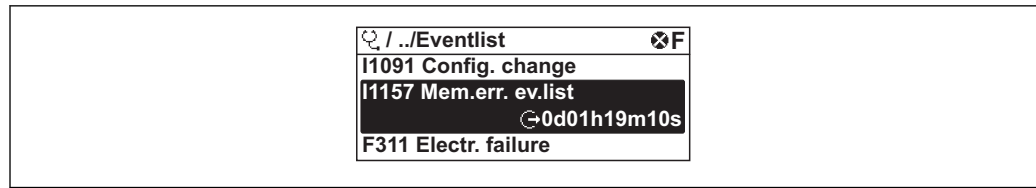

A0014008-EN

36 Taking the example of the local display

- A maximum of 20 event messages can be displayed in chronological order.
- If the **Extended HistoROM** application package (order option) is enabled in the device, the event list can contain up to 100 entries .

The event history includes entries for:

- Diagnostic events → 142
- Information events → 148

In addition to the operation time of its occurrence, each event is also assigned a symbol that indicates whether the event has occurred or is ended:

- Diagnostic event
 - : Occurrence of the event
 - : End of the event
- Information event
 - : Occurrence of the event

To call up the measures to rectify a diagnostic event:

- Via local display → 138
- Via Web browser → 139
- Via "FieldCare" operating tool → 141
- Via "DeviceCare" operating tool → 141

For filtering the displayed event messages → 148

12.10.2 Filtering the event logbook

Using the **Filter options** parameter you can define which category of event message is displayed in the **Events list** submenu.

Navigation path

Diagnostics → Event logbook → Filter options

Filter categories

- All
- Failure (F)
- Function check (C)
- Out of specification (S)
- Maintenance required (M)
- Information (I)

12.10.3 Overview of information events

Unlike a diagnostic event, an information event is displayed in the event logbook only and not in the diagnostic list.

Info number	Info name
I1000	----- (Device ok)
I1079	Sensor changed
I1089	Power on
I1090	Configuration reset
I1091	Configuration changed

Info number	Info name
I1092	HistoROM backup deleted
I1137	Electronic changed
I1151	History reset
I1155	Reset electronic temperature
I1156	Memory error trend
I1157	Memory error event list
I1256	Display: access status changed
I1264	Safety sequence aborted
I1278	I/O module restarted
I1335	Firmware changed
I1351	Empty pipe detection adjustment failure
I1353	Empty pipe detection adjustment ok
I1361	Web server: login failed
I1397	Fieldbus: access status changed
I1398	CDI: access status changed
I1443	Coating thickness not determined
I1444	Device verification passed
I1445	Device verification failed
I1457	Measurement error verification failed
I1459	I/O module verification failed
I1461	Sensor verification failed
I1462	Sensor electronic module verific. failed
I1512	Download started
I1513	Download finished
I1514	Upload started
I1515	Upload finished
I1517	Custody transfer active
I1518	Custody transfer inactive
I1554	Safety sequence started
I1555	Safety sequence confirmed
I1556	Safety mode off
I1618	I/O module 2 replaced
I1619	I/O module 3 replaced
I1621	I/O module 4 replaced
I1622	Calibration changed
I1624	Reset all totalizers
I1625	Write protection activated
I1626	Write protection deactivated
I1627	Web server: login successful
I1628	Display: login successful
I1629	CDI: login successful
I1631	Web server access changed
I1632	Display: login failed

Info number	Info name
I1633	CDI: login failed
I1634	Reset to factory settings
I1635	Reset to delivery settings
I1639	Max. switch cycles number reached
I1643	Custody transfer logbook cleared
I1649	Hardware write protection activated
I1650	Hardware write protection deactivated
I1651	Custody transfer parameter changed
I1712	New flash file received
I1725	Sensor electronic module (ISEM) changed
I1726	Configuration backup failed

12.11 Resetting the measuring device

Using the **Device reset** parameter (→ ⓘ 116) it is possible to reset the entire device configuration or some of the configuration to a defined state.

12.11.1 Function scope of the "Device reset" parameter

Options	Description
Cancel	No action is executed and the user exits the parameter.
To delivery settings	Every parameter for which a customer-specific default setting was ordered is reset to this customer-specific value. All other parameters are reset to the factory setting.
Restart device	The restart resets every parameter whose data are in the volatile memory (RAM) to the factory setting (e.g. measured value data). The device configuration remains unchanged.
Restore S-DAT backup	Restore the data that are saved on the S-DAT. The data record is restored from the electronics memory to the S-DAT.  This option is displayed only in an alarm condition.

12.12 Device information

The **Device information** submenu contains all parameters that display different information for device identification.





Navigation

"Diagnostics" menu → Device information

▶ Device information	
Device tag	→ ⓘ 151
Serial number	→ ⓘ 151
Firmware version	→ ⓘ 151

Device name	→ ⓘ 151
Manufacturer	
Order code	→ ⓘ 151
Extended order code 1	→ ⓘ 151
Extended order code 2	→ ⓘ 151
Extended order code 3	→ ⓘ 152
ENP version	→ ⓘ 152
Device revision	→ ⓘ 152
Device ID	→ ⓘ 152
Device type	→ ⓘ 152
Manufacturer ID	→ ⓘ 152





Parameter overview with brief description

Parameter	Description	User interface	Factory setting
Device tag	Shows name of measuring point.	Max. 32 characters, such as letters, numbers or special characters (e.g. @, %, /).	Promag
Serial number	Shows the serial number of the measuring device.	Max. 11-digit character string comprising letters and numbers.	-
Firmware version	Shows the device firmware version installed.	Character string in the format xx.yy.zz	-
Device name	Shows the name of the transmitter.  The name can be found on the nameplate of the transmitter.	Promag 300/500	-
Order code	Shows the device order code.  The order code can be found on the nameplate of the sensor and transmitter in the "Order code" field.	Character string composed of letters, numbers and certain punctuation marks (e.g. /).	-
Extended order code 1	Shows the 1st part of the extended order code.  The extended order code can also be found on the nameplate of the sensor and transmitter in the "Ext. ord. cd." field.	Character string	-
Extended order code 2	Shows the 2nd part of the extended order code.  The extended order code can also be found on the nameplate of the sensor and transmitter in the "Ext. ord. cd." field.	Character string	-

Parameter	Description	User interface	Factory setting
Extended order code 3	Shows the 3rd part of the extended order code.  The extended order code can also be found on the nameplate of the sensor and transmitter in the "Ext. ord. cd." field.	Character string	–
ENP version	Shows the version of the electronic nameplate (ENP).	Character string	2.02.00
Device revision	Shows the device revision with which the device is registered with the HART Communication Foundation.	2-digit hexadecimal number	6
Device ID	Shows the device ID for identifying the device in a HART network.	6-digit hexadecimal number	–
Device type	Shows the device type with which the measuring device is registered with the HART Communication Foundation.	2-digit hexadecimal number	0x3A (for Promag 300)
Manufacturer ID	Shows the manufacturer ID device is registered with the HART Communication Foundation.	2-digit hexadecimal number	0x11 (for Endress+Hauser)

12.13 Firmware history

Release date	Firmware version	Order code for "Firmware version"	Firmware changes	Documentation type	Documentation
09.2019	01.05.zz	Option 64	Various improvements	Operating Instructions	BA01918D/06/EN/01.19
10.2017	01.01.zz	Option 68	<ul style="list-style-type: none"> ▪ OPC-UA with Security new ▪ Local display - enhanced performance and data entry via text editor ▪ Optimized keypad lock for local display ▪ Web server feature update <ul style="list-style-type: none"> ▪ Support for trend data function ▪ Heartbeat function enhanced to include detailed results (page 3/4 of the report) ▪ Device configuration as PDF (parameter log, similar to FDT print) ▪ Network capability of Ethernet (service) interface ▪ Comprehensive Heartbeat feature update ▪ Local display - support for WLAN infrastructure mode ▪ Implementation of reset code 	Operating Instructions	
08.2016	01.00.zz	Option 76	Original firmware	Operating Instructions	

-  It is possible to flash the firmware to the current version or the previous version using the service interface. For the compatibility of the firmware version, see the "Device history and compatibility" section →  154
-  For the compatibility of the firmware version with the previous version, the installed device description files and operating tools, observe the information about the device in the "Manufacturer's information" document.
-  The manufacturer's information is available:
 - In the Download Area of the Endress+Hauser web site: www.endress.com → Downloads

- Specify the following details:
 - Product root: e.g. 5W3B
The product root is the first part of the order code: see the nameplate on the device.
 - Text search: Manufacturer's information
 - Media type: Documentation – Technical Documentation

12.14 Device history and compatibility

The device model is documented in the order code on the nameplate of the device (e.g. 8F3BXX-XXX...XXA1-XXXXXX).

Device model	Release	Change compared with earlier model	Compatibility with earlier model
A2	09.2019	I/O module with enhanced performance and functionality: see device firmware 01.05.zz →  153	No
A1	02.2019	–	–

13 Maintenance

13.1 Maintenance tasks

No special maintenance work is required.

13.1.1 Exterior cleaning

When cleaning the exterior of measuring devices, always use cleaning agents that do not attack the surface of the housing or the seals.

WARNING

Cleaning agents can damage the plastic transmitter housing!

- ▶ Do not use high-pressure steam.
- ▶ Only use the permitted cleaning agents specified.

Permitted cleaning agents for the plastic transmitter housing

- Commercially available household cleaners
- Methyl alcohol or isopropyl alcohol
- Mild soap solutions

13.1.2 Interior cleaning

No interior cleaning is planned for the device.

13.1.3 Replacing seals

The sensor's seals (particularly aseptic molded seals) must be replaced periodically.

The interval between changes depends on the frequency of the cleaning cycles, the cleaning temperature and the medium temperature.

Replacement seals (accessory part) →  194

13.2 Measuring and test equipment

Endress+Hauser offers a wide variety of measuring and test equipment, such as W@M or device tests.

 Your Endress+Hauser Sales Center can provide detailed information on the services.

List of some of the measuring and testing equipment: →  158

13.3 Endress+Hauser services

Endress+Hauser offers a wide variety of services for maintenance such as recalibration, maintenance service or device tests.

 Your Endress+Hauser Sales Center can provide detailed information on the services.

14 Repair

14.1 General notes

14.1.1 Repair and conversion concept

The Endress+Hauser repair and conversion concept provides for the following:



- The measuring devices have a modular design.
- Spare parts are grouped into logical kits with the associated Installation Instructions.
- Repairs are carried out by Endress+Hauser Service or by appropriately trained customers.
- Certified devices can only be converted to other certified devices by Endress+Hauser Service or at the factory.

14.1.2 Notes for repair and conversion

For repair and modification of a measuring device, observe the following notes:

- ▶ Use only original Endress+Hauser spare parts.
- ▶ Carry out the repair according to the Installation Instructions.
- ▶ Observe the applicable standards, federal/national regulations, Ex documentation (XA) and certificates.
- ▶ Document every repair and each conversion and enter them into the *W@M* life cycle management database.

14.2 Spare parts

 Measuring device serial number:
Can be read out via the **Serial number** parameter (→  151) in the **Device information** submenu.

14.3 Endress+Hauser services

Endress+Hauser offers a wide range of services.

 Your Endress+Hauser Sales Center can provide detailed information on the services.

14.4 Return

The requirements for safe device return can vary depending on the device type and national legislation.

1. Refer to the website for more information:
<http://www.endress.com/support/return-material>
2. Return the device if repairs or a factory calibration are required, or if the wrong device was ordered or delivered.

14.5 Disposal

14.5.1 Removing the measuring device

1. Switch off the device.

⚠ WARNING**Danger to persons from process conditions.**

- ▶ Beware of hazardous process conditions such as pressure in the measuring device, high temperatures or aggressive fluids.
2. Carry out the mounting and connection steps from the "Mounting the measuring device" and "Connecting the measuring device" sections in reverse order. Observe the safety instructions.

14.5.2 Disposing of the measuring device

⚠ WARNING**Danger to personnel and environment from fluids that are hazardous to health.**

- ▶ Ensure that the measuring device and all cavities are free of fluid residues that are hazardous to health or the environment, e.g. substances that have permeated into crevices or diffused through plastic.

Observe the following notes during disposal:











- ▶ Observe valid federal/national regulations.
- ▶ Ensure proper separation and reuse of the device components.

15 Accessories

Various accessories, which can be ordered with the device or subsequently from Endress+Hauser, are available for the device. Detailed information on the order code in question is available from your local Endress+Hauser sales center or on the product page of the Endress+Hauser website: www.endress.com.

15.1 Device-specific accessories





15.1.1 For the transmitter

Accessories	Description
Proline 300 transmitter	<p>Transmitter for replacement or storage. Use the order code to define the following specifications:</p> <ul style="list-style-type: none"> ▪ Approvals ▪ Output ▪ Input ▪ Display/operation ▪ Housing ▪ Software <p> Order code: 5X3BXX</p> <p> Installation Instructions EA01263D</p>
Remote display and operating module DKX001	<ul style="list-style-type: none"> ▪ If ordered directly with the measuring device: Order code for "Display; operation", option O "Remote display 4-line illum.; 10 m (30 ft) Cable; touch control" ▪ If ordered separately: <ul style="list-style-type: none"> ▪ Measuring device: order code for "Display; operation", option M "W/o, prepared for remote display" ▪ DKX001: Via the separate product structure DKX001 ▪ If ordered subsequently: DKX001: Via the separate product structure DKX001 <p>Mounting bracket for DKX001</p> <ul style="list-style-type: none"> ▪ If ordered directly: order code for "Accessory enclosed", option RA "Mounting bracket, pipe 1/2" ▪ If ordered subsequently: order number: 71340960 <p>Connecting cable (replacement cable) Via the separate product structure: DKX002</p> <p> Further information on display and operating module DKX001 →  189.</p> <p> Special Documentation SD01763D</p>
External WLAN antenna	<p>External WLAN antenna with 1.5 m (59.1 in) connecting cable and two angle brackets. Order code for "Accessory enclosed", option P8 "Wireless antenna wide area".</p> <p> <ul style="list-style-type: none"> ▪ The external WLAN antenna is not suitable for use in hygienic applications. ▪ Further information on the WLAN interface →  72. </p> <p> Order number: 71351317</p> <p> Installation Instructions EA01238D</p>
Protective cover	<p>Is used to protect the measuring device from the effects of the weather: e.g. rainwater, excess heating from direct sunlight.</p> <p> Order number: 71343505</p> <p> Installation Instructions EA01160D</p>
Ground cable	Set, consisting of two ground cables for potential equalization.



15.1.2 For the sensor

Accessories	Description
Ground disks	<p>Are used to ground the medium in lined measuring tubes to ensure proper measurement.</p> <p> For details, see Installation Instructions EA00070D</p>



15.2 Communication-specific accessories

Accessories	Description
Commubox FXA195 HART	<p>For intrinsically safe HART communication with FieldCare via the USB interface.</p> <p> Technical Information TI00404F</p>
HART Loop Converter HMX50	<p>Is used to evaluate and convert dynamic HART process variables to analog current signals or limit values.</p> <p> <ul style="list-style-type: none"> ▪ Technical Information TI00429F ▪ Operating Instructions BA00371F </p>
Fieldgate FXA42	<p>Is used to transmit the measured values of connected 4 to 20 mA analog measuring devices, as well as digital measuring devices</p> <p> <ul style="list-style-type: none"> ▪ Technical Information TI01297S ▪ Operating Instructions BA01778S ▪ Product page: www.endress.com/fxa42 </p>
Field Xpert SMT70	<p>The Field Xpert SMT70 tablet PC for device configuration enables mobile plant asset management in hazardous and non-hazardous areas. It is suitable for commissioning and maintenance staff to manage field instruments with a digital communication interface and to record progress.</p> <p>This tablet PC is designed as an all-in-one solution with a preinstalled driver library and is an easy-to-use, touch-sensitive tool which can be used to manage field instruments throughout their entire life cycle.</p> <p> <ul style="list-style-type: none"> ▪ Technical Information TI01342S ▪ Operating Instructions BA01709S ▪ Product page: www.endress.com/smt70 </p>
Field Xpert SMT77	<p>The Field Xpert SMT77 tablet PC for device configuration enables mobile plant asset management in areas categorized as Ex Zone 1.</p> <p> <ul style="list-style-type: none"> ▪ Technical Information TI01418S ▪ Operating Instructions BA01923S ▪ Product page: www.endress.com/smt77 </p>

15.3 Service-specific accessories

Accessories	Description
Applicator	<p>Software for selecting and sizing Endress+Hauser measuring devices:</p> <ul style="list-style-type: none"> Choice of measuring devices for industrial requirements Calculation of all the necessary data for identifying the optimum flowmeter: e.g. nominal diameter, pressure loss, flow velocity and accuracy. Graphic illustration of the calculation results Determination of the partial order code, administration, documentation and access to all project-related data and parameters over the entire life cycle of a project. <p>Applicator is available:</p> <ul style="list-style-type: none"> Via the Internet: https://portal.endress.com/webapp/applicator As a downloadable DVD for local PC installation.
W@M	<p>W@M Life Cycle Management</p> <p>Improved productivity with information at your fingertips. Data relevant to a plant and its components is generated from the first stages of planning and during the asset's complete life cycle.</p> <p>W@M Life Cycle Management is an open and flexible information platform with online and on-site tools. Instant access for your staff to current, in-depth data shortens your plant's engineering time, speeds up procurement processes and increases plant uptime.</p> <p>Combined with the right services, W@M Life Cycle Management boosts productivity in every phase. For more information, visit www.endress.com/lifecyclemanagement</p>
FieldCare	<p>FDT-based plant asset management tool from Endress+Hauser. It can configure all smart field units in your system and helps you manage them. By using the status information, it is also a simple but effective way of checking their status and condition.</p> <p> Operating Instructions BA00027S and BA00059S</p>
DeviceCare	<p>Tool to connect and configure Endress+Hauser field devices.</p> <p> Innovation brochure IN01047S</p>

15.4 System components

Accessories	Description
Memograph M graphic data manager	<p>The Memograph M graphic data manager provides information on all the relevant measured variables. Measured values are recorded correctly, limit values are monitored and measuring points analyzed. The data are stored in the 256 MB internal memory and also on a SD card or USB stick.</p> <p> <ul style="list-style-type: none"> Technical Information TI00133R Operating Instructions BA00247R </p>
iTEMP	<p>The temperature transmitters can be used in all applications and are suitable for the measurement of gases, steam and liquids. They can be used to read in the medium temperature.</p> <p> "Fields of Activity" document FA00006T</p>

16 Technical data

16.1 Application

The measuring device is only suitable for flow measurement of liquids with a minimum conductivity of 5 $\mu\text{S}/\text{cm}$.

Depending on the version ordered, the measuring device can also measure potentially explosive, flammable, poisonous and oxidizing media.

To ensure that the device remains in proper operating condition for its service life, use the measuring device only for media against which the process-wetted materials are sufficiently resistant.

16.2 Function and system design

Measuring principle	Electromagnetic flow measurement on the basis of <i>Faraday's law of magnetic induction</i> .
Measuring system	The device consists of a transmitter and a sensor. The device is available as a compact version: The transmitter and sensor form a mechanical unit. For information on the structure of the device →  14

16.3 Input

Measured variable	<p>Direct measured variables</p> <ul style="list-style-type: none"> ▪ Volume flow (proportional to induced voltage) ▪ Electrical conductivity <p>Calculated measured variables</p> <p>Mass flow</p>
-------------------	---

Measuring range	Typically $v = 0.01$ to 10 m/s (0.03 to 33 ft/s) with the specified accuracy Electrical conductivity: $\geq 5 \mu\text{S}/\text{cm}$ for liquids in general
-----------------	--

Flow characteristic values in SI units: DN 25 to 125 (1 to 4")

Nominal diameter		Recommended flow min./max. full scale value ($v \sim 0.3/10$ m/s) [dm ³ /min]	Factory settings		
[mm]	[in]		Full scale value current output ($v \sim 2.5$ m/s) [dm ³ /min]	Pulse value (~ 2 pulse/s) [dm ³]	Low flow cut off ($v \sim 0.04$ m/s) [dm ³ /min]
25	1	9 to 300	75	0.5	1
32	–	15 to 500	125	1	2
40	1 ½	25 to 700	200	1.5	3
50	2	35 to 1 100	300	2.5	5
65	–	60 to 2 000	500	5	8
80	3	90 to 3 000	750	5	12

Nominal diameter		Recommended flow min./max. full scale value (v ~ 0.3/10 m/s) [dm ³ /min]	Factory settings		
[mm]	[in]		Full scale value current output (v ~ 2.5 m/s) [dm ³ /min]	Pulse value (~ 2 pulse/s) [dm ³]	Low flow cut off (v ~ 0.04 m/s) [dm ³ /min]
100	4	145 to 4 700	1200	10	20
125	-	220 to 7 500	1850	15	30

Flow characteristic values in SI units: DN 150 to 2400 (6 to 90")

Nominal diameter		Recommended flow min./max. full scale value (v ~ 0.3/10 m/s) [m ³ /h]	Factory settings		
[mm]	[in]		Full scale value current output (v ~ 2.5 m/s) [m ³ /h]	Pulse value (~ 2 pulse/s) [m ³]	Low flow cut off (v ~ 0.04 m/s) [m ³ /h]
150	6	20 to 600	150	0.025	2.5
200	8	35 to 1 100	300	0.05	5
250	10	55 to 1 700	500	0.05	7.5
300	12	80 to 2 400	750	0.1	10
350	14	110 to 3 300	1000	0.1	15
375	15	140 to 4 200	1200	0.15	20
400	16	140 to 4 200	1200	0.15	20
450	18	180 to 5 400	1500	0.25	25
500	20	220 to 6 600	2000	0.25	30
600	24	310 to 9 600	2500	0.3	40
700	28	420 to 13 500	3500	0.5	50
750	30	480 to 15 000	4000	0.5	60
800	32	550 to 18 000	4500	0.75	75
900	36	690 to 22 500	6000	0.75	100
1000	40	850 to 28 000	7000	1	125
-	42	950 to 30 000	8000	1	125
1200	48	1 250 to 40 000	10000	1.5	150
-	54	1 550 to 50 000	13000	1.5	200
1400	-	1 700 to 55 000	14000	2	225
-	60	1 950 to 60 000	16000	2	250
1600	-	2 200 to 70 000	18000	2.5	300
-	66	2 500 to 80 000	20500	2.5	325
1800	72	2 800 to 90 000	23000	3	350
-	78	3 300 to 100 000	28500	3.5	450
2000	-	3 400 to 110 000	28500	3.5	450
-	84	3 700 to 125 000	31000	4.5	500
2200	-	4 100 to 136 000	34000	4.5	540
-	90	4 300 to 143 000	36000	5	570
2400	-	4 800 to 162 000	40000	5.5	650

Flow characteristic values in SI units: DN 50 to 300 (2 to 12") for order code for "Design", option C "Fixed flange, without inlet/outlet runs"

Nominal diameter		Recommended flow min./max. full scale value (v ~ 0.12/5 m/s)	Factory settings		
[mm]	[in]		Full scale value current output (v ~ 2.5 m/s)	Pulse value (~ 4 pulse/s)	Low flow cut off (v ~ 0.01 m/s)
		[m ³ /h]	[m ³ /h]	[m ³]	[m ³ /h]
50	2	15 to 600 dm ³ /min	300 dm ³ /min	1.25 dm ³	1.25 dm ³ /min
65	–	25 to 1000 dm ³ /min	500 dm ³ /min	2 dm ³	2 dm ³ /min
80	3	35 to 1500 dm ³ /min	750 dm ³ /min	3 dm ³	3.25 dm ³ /min
100	4	60 to 2400 dm ³ /min	1200 dm ³ /min	5 dm ³	4.75 dm ³ /min
125	–	90 to 3700 dm ³ /min	1850 dm ³ /min	8 dm ³	7.5 dm ³ /min
150	6	145 to 5400 dm ³ /min	2500 dm ³ /min	10 dm ³	11 dm ³ /min
200	8	220 to 9400 dm ³ /min	5000 dm ³ /min	20 dm ³	19 dm ³ /min
250	10	20 to 850	500	0.03	1.75
300	12	35 to 1300	750	0.05	2.75

Flow characteristic values in US units: 1 to 48" (DN 25 to 1200)

Nominal diameter		Recommended flow min./max. full scale value (v ~ 0.3/10 m/s)	Factory settings		
[in]	[mm]		Full scale value current output (v ~ 2.5 m/s)	Pulse value (~ 2 pulse/s)	Low flow cut off (v ~ 0.04 m/s)
		[gal/min]	[gal/min]	[gal]	[gal/min]
1	25	2.5 to 80	18	0.2	0.25
–	32	4 to 130	30	0.2	0.5
1 ½	40	7 to 185	50	0.5	0.75
2	50	10 to 300	75	0.5	1.25
–	65	16 to 500	130	1	2
3	80	24 to 800	200	2	2.5
4	100	40 to 1250	300	2	4
–	125	60 to 1950	450	5	7
6	150	90 to 2650	600	5	12
8	200	155 to 4850	1200	10	15
10	250	250 to 7500	1500	15	30
12	300	350 to 10600	2400	25	45
14	350	500 to 15000	3600	30	60
15	375	600 to 19000	4800	50	60
16	400	600 to 19000	4800	50	60
18	450	800 to 24000	6000	50	90
20	500	1000 to 30000	7500	75	120
24	600	1400 to 44000	10500	100	180
28	700	1900 to 60000	13500	125	210
30	750	2150 to 67000	16500	150	270
32	800	2450 to 80000	19500	200	300

Nominal diameter		Recommended flow min./max. full scale value (v ~ 0.3/10 m/s)	Factory settings		
[in]	[mm]		Full scale value current output (v ~ 2.5 m/s)	Pulse value (~ 2 pulse/s)	Low flow cut off (v ~ 0.04 m/s)
		[gal/min]	[gal/min]	[gal]	[gal/min]
36	900	3 100 to 100 000	24000	225	360
40	1000	3 800 to 125 000	30000	250	480
42	-	4 200 to 135 000	33000	250	600
48	1200	5 500 to 175 000	42000	400	600

Flow characteristic values in US units: 54 to 90" (DN 1400 to 2400)



Nominal diameter		Recommended flow min./max. full scale value (v ~ 0.3/10 m/s)	Factory settings		
[in]	[mm]		Full scale value current output (v ~ 2.5 m/s)	Pulse value (~ 2 pulse/s)	Low flow cut off (v ~ 0.04 m/s)
		[Mgal/d]	[Mgal/d]	[Mgal]	[Mgal/d]
54	-	9 to 300	75	0.0005	1.3
-	1400	10 to 340	85	0.0005	1.3
60	-	12 to 380	95	0.0005	1.3
-	1600	13 to 450	110	0.0008	1.7
66	-	14 to 500	120	0.0008	2.2
72	1800	16 to 570	140	0.0008	2.6
78	-	18 to 650	175	0.0010	3.0
-	2000	20 to 700	175	0.0010	2.9
84	-	24 to 800	190	0.0011	3.2
-	2200	26 to 870	210	0.0012	3.4
90	-	27 to 910	220	0.0013	3.6
-	2400	31 to 1030	245	0.0014	4.1

Flow characteristic values in US units: 2 to 12" (DN 50 to 300) for order code for "Design", option C "Fixed flange, without inlet/outlet runs"

Nominal diameter		Recommended flow min./max. full scale value (v ~ 0.12/5 m/s)	Factory settings		
[in]	[mm]		Full scale value current output (v ~ 2.5 m/s)	Pulse value (~ 4 pulse/s)	Low flow cut off (v ~ 0.01 m/s)
		[gal/min]	[gal/min]	[gal]	[gal/min]
2	50	4 to 160	75	0.3	0.35
-	65	7 to 260	130	0.5	0.6
3	80	10 to 400	200	0.8	0.8
4	100	16 to 650	300	1.2	1.25
-	125	24 to 1000	450	1.8	2
6	150	40 to 1400	600	2.5	3
8	200	60 to 2 500	1200	5	5

Nominal diameter		Recommended flow min./max. full scale value (v ~ 0.12/5 m/s)	Factory settings		
			Full scale value current output (v ~ 2.5 m/s)	Pulse value (~ 4 pulse/s)	Low flow cut off (v ~ 0.01 m/s)
[in]	[mm]	[gal/min]	[gal/min]	[gal]	[gal/min]
10	250	90 to 3 700	1 500	6	8
12	300	155 to 5 700	2 400	9	12

Recommended measuring range

 Flow limit →  178

Operable flow range Over 1000 : 1

Input signal

External measured values

To increase the accuracy of certain measured variables or to calculate the mass flow, the automation system can continuously write different measured values to the measuring device:

- Medium temperature enables temperature-compensated conductivity measurement (e.g. iTEMP)
- Reference density for calculating the mass flow

 Various pressure transmitters and temperature measuring devices can be ordered from Endress+Hauser: see "Accessories" section →  160

It is recommended to read in external measured values to calculate the corrected volume flow.

HART protocol

The measured values are written from the automation system to the measuring device via the HART protocol. The pressure transmitter must support the following protocol-specific functions:

- HART protocol
- Burst mode

Current input

The measured values are written from the automation system to the measuring device via the current input →  165.

Current input 0/4 to 20 mA

Current input	0/4 to 20 mA (active/passive)
Current span	<ul style="list-style-type: none"> ■ 4 to 20 mA (active) ■ 0/4 to 20 mA (passive)
Resolution	1 µA
Voltage drop	Typically: 0.6 to 2 V for 3.6 to 22 mA (passive)
Maximum input voltage	≤ 30 V (passive)
Open-circuit voltage	≤ 28.8 V (active)
Possible input variables	<ul style="list-style-type: none"> ■ Temperature ■ Density

Status input

Maximum input values	<ul style="list-style-type: none">▪ DC -3 to 30 V▪ If status input is active (ON): $R_i > 3 \text{ k}\Omega$
Response time	Configurable: 5 to 200 ms
Input signal level	<ul style="list-style-type: none">▪ Low signal: DC -3 to +5 V▪ High signal: DC 12 to 30 V
Assignable functions	<ul style="list-style-type: none">▪ Off▪ Reset the individual totalizers separately▪ Reset all totalizers▪ Flow override

16.4 Output

Output signal

Current output 4 to 20 mA HART

Order code	"Output; Input 1" (20): Option BA: current output 4 to 20 mA HART
Signal mode	Can be set to: <ul style="list-style-type: none"> ▪ Active ▪ Passive
Current range	Can be set to: <ul style="list-style-type: none"> ▪ 4 to 20 mA NAMUR ▪ 4 to 20 mA US ▪ 4 to 20 mA ▪ 0 to 20 mA (only with signal mode active) ▪ Fixed current value
Open-circuit voltage	DC 28.8 V (active)
Maximum input voltage	DC 30 V (passive)
Load	250 to 700 Ω
Resolution	0.38 μ A
Damping	Configurable: 0 to 999 s
Assignable measured variables	<ul style="list-style-type: none"> ▪ Volume flow ▪ Mass flow ▪ Corrected volume flow ▪ Flow velocity ▪ Conductivity ▪ Electronics temperature

Current output 4 to 20 mA HART Ex i

Order code	"Output; Input 1" (20) can be set to: <ul style="list-style-type: none"> ▪ Option CA: current output 4 to 20 mA HART Ex i passive ▪ Option CC: current output 4 to 20 mA HART Ex i active
Signal mode	Depending on the ordered variant.
Current range	Can be set to: <ul style="list-style-type: none"> ▪ 4 to 20 mA NAMUR ▪ 4 to 20 mA US ▪ 4 to 20 mA ▪ 0 to 20 mA (only with signal mode active) ▪ Fixed current value
Open-circuit voltage	DC 21.8 V (active)
Maximum input voltage	DC 30 V (passive)
Load	<ul style="list-style-type: none"> ▪ 250 to 400 Ω (active) ▪ 250 to 700 Ω (passive)
Resolution	0.38 μ A
Damping	Configurable: 0 to 999 s
Assignable measured variables	<ul style="list-style-type: none"> ▪ Volume flow ▪ Mass flow ▪ Corrected volume flow ▪ Flow velocity ▪ Conductivity ▪ Electronics temperature

Current output 4 to 20 mA

Order code	"Output; Input 2" (21), "Output; Input 3" (022): Option B: current output 4 to 20 mA
Signal mode	Can be set to: <ul style="list-style-type: none"> ■ Active ■ Passive
Current range	Can be set to: <ul style="list-style-type: none"> ■ 4 to 20 mA NAMUR ■ 4 to 20 mA US ■ 4 to 20 mA ■ 0 to 20 mA (only with signal mode active) ■ Fixed current value
Maximum output values	22.5 mA
Open-circuit voltage	DC 28.8 V (active)
Maximum input voltage	DC 30 V (passive)
Load	0 to 700 Ω
Resolution	0.38 μA
Damping	Configurable: 0 to 999 s
Assignable measured variables	<ul style="list-style-type: none"> ■ Volume flow ■ Mass flow ■ Corrected volume flow ■ Flow velocity ■ Conductivity ■ Electronics temperature

Current output 4 to 20 mA Ex i passive

Order code	"Output; Input 2" (21), "Output; Input 3" (022): Option C: current output 4 to 20 mA Ex i passive
Signal mode	Passive
Current range	Can be set to: <ul style="list-style-type: none"> ■ 4 to 20 mA NAMUR ■ 4 to 20 mA US ■ 4 to 20 mA ■ Fixed current value
Maximum output values	22.5 mA
Maximum input voltage	DC 30 V
Load	0 to 700 Ω
Resolution	0.38 μA
Damping	Configurable: 0 to 999 s
Assignable measured variables	<ul style="list-style-type: none"> ■ Volume flow ■ Mass flow ■ Corrected volume flow ■ Flow velocity ■ Conductivity ■ Electronics temperature

Pulse/frequency/switch output

Function	Can be set to pulse, frequency or switch output
Version	Open collector Can be set to: <ul style="list-style-type: none"> ■ Active ■ Passive ■ Passive NAMUR  Ex-i, passive
Maximum input values	DC 30 V, 250 mA (passive)
Open-circuit voltage	DC 28.8 V (active)
Voltage drop	For 22.5 mA: ≤ DC 2 V
Pulse output	
Maximum input values	DC 30 V, 250 mA (passive)
Maximum output current	22.5 mA (active)
Open-circuit voltage	DC 28.8 V (active)
Pulse width	Configurable: 0.05 to 2 000 ms
Maximum pulse rate	10 000 Impulse/s
Pulse value	Adjustable
Assignable measured variables	<ul style="list-style-type: none"> ■ Volume flow ■ Mass flow ■ Corrected volume flow
Frequency output	
Maximum input values	DC 30 V, 250 mA (passive)
Maximum output current	22.5 mA (active)
Open-circuit voltage	DC 28.8 V (active)
Output frequency	Adjustable: end value frequency 2 to 10 000 Hz ($f_{\max} = 12\,500$ Hz)
Damping	Configurable: 0 to 999 s
Pulse/pause ratio	1:1
Assignable measured variables	<ul style="list-style-type: none"> ■ Volume flow ■ Mass flow ■ Corrected volume flow ■ Flow velocity ■ Conductivity ■ Electronics temperature
Switch output	
Maximum input values	DC 30 V, 250 mA (passive)
Open-circuit voltage	DC 28.8 V (active)
Switching behavior	Binary, conductive or non-conductive
Switching delay	Configurable: 0 to 100 s

Number of switching cycles	Unlimited
Assignable functions	<ul style="list-style-type: none"> ▪ Off ▪ On ▪ Diagnostic behavior ▪ Limit value: <ul style="list-style-type: none"> ▪ Off ▪ Volume flow ▪ Mass flow ▪ Corrected volume flow ▪ Flow velocity ▪ Conductivity ▪ Totalizer 1-3 ▪ Electronics temperature ▪ Flow direction monitoring ▪ Status <ul style="list-style-type: none"> ▪ Empty pipe detection ▪ Low flow cut off

Double pulse output

Function	Double pulse
Version	Open collector Can be set to: <ul style="list-style-type: none"> ▪ Active ▪ Passive ▪ Passive NAMUR
Maximum input values	DC 30 V, 250 mA (passive)
Open-circuit voltage	DC 28.8 V (active)
Voltage drop	For 22.5 mA: ≤ DC 2 V
Output frequency	Configurable: 0 to 1000 Hz
Damping	Configurable: 0 to 999 s
Pulse/pause ratio	1:1
Assignable measured variables	<ul style="list-style-type: none"> ▪ Volume flow ▪ Mass flow ▪ Corrected volume flow ▪ Flow velocity ▪ Conductivity ▪ Electronics temperature

Relay output

Function	Switch output
Version	Relay output, galvanically isolated
Switching behavior	Can be set to: <ul style="list-style-type: none"> ▪ NO (normally open), factory setting ▪ NC (normally closed)

Maximum switching capacity (passive)	<ul style="list-style-type: none"> ▪ DC 30 V, 0.1 A ▪ AC 30 V, 0.5 A
Assignable functions	<ul style="list-style-type: none"> ▪ Off ▪ On ▪ Diagnostic behavior ▪ Limit value: <ul style="list-style-type: none"> ▪ Off ▪ Volume flow ▪ Mass flow ▪ Corrected volume flow ▪ Flow velocity ▪ Conductivity ▪ Totalizer 1-3 ▪ Electronic temperature ▪ Flow direction monitoring ▪ Status <ul style="list-style-type: none"> ▪ Empty pipe detection ▪ Low flow cut off

User-configurable input/output

One specific input or output is assigned to a user-configurable input/output (configurable I/O) during device commissioning.

The following inputs and outputs are available for assignment:

- Choice of current output: 4 to 20 mA (active), 0/4 to 20 mA (passive)
- Pulse/frequency/switch output
- Choice of current input: 4 to 20 mA (active), 0/4 to 20 mA (passive)
- Status input

Signal on alarm

Depending on the interface, failure information is displayed as follows:

Current output 0/4 to 20 mA

4 to 20 mA

Failure mode	Choose from: <ul style="list-style-type: none"> ▪ 4 to 20 mA in accordance with NAMUR recommendation NE 43 ▪ 4 to 20 mA in accordance with US ▪ Min. value: 3.59 mA ▪ Max. value: 22.5 mA ▪ Freely definable value between: 3.59 to 22.5 mA ▪ Actual value ▪ Last valid value
---------------------	--

0 to 20 mA

Failure mode	Choose from: <ul style="list-style-type: none"> ▪ Maximum alarm: 22 mA ▪ Freely definable value between: 0 to 20.5 mA
---------------------	---

Pulse/frequency/switch output

Pulse output	
Failure mode	Choose from: <ul style="list-style-type: none"> ▪ Actual value ▪ No pulses
Frequency output	

Failure mode	Choose from: <ul style="list-style-type: none"> ▪ Actual value ▪ 0 Hz ▪ Defined value (f_{\max} 2 to 12 500 Hz)
Switch output	
Failure mode	Choose from: <ul style="list-style-type: none"> ▪ Current status ▪ Open ▪ Closed

Relay output

Failure mode	Choose from: <ul style="list-style-type: none"> ▪ Current status ▪ Open ▪ Closed
---------------------	---

Local display

Plain text display	With information on cause and remedial measures
Backlight	Red backlighting indicates a device error.

 Status signal as per NAMUR recommendation NE 107

Interface/protocol



- Via digital communication:
 - HART protocol
- Via service interface
 - CDI-RJ45 service interface
 - WLAN interface

Plain text display	With information on cause and remedial measures
---------------------------	---

Web browser

Plain text display	With information on cause and remedial measures
---------------------------	---

Light emitting diodes (LED)

Status information	Status indicated by various light emitting diodes The following information is displayed depending on the device version: <ul style="list-style-type: none"> ▪ Supply voltage active ▪ Data transmission active ▪ Device alarm/error has occurred  Diagnostic information via light emitting diodes →  134
---------------------------	--

Low flow cut off The switch points for low flow cut off are user-selectable.

Galvanic isolation The outputs are galvanically isolated from one another and from earth (PE).

Protocol-specific data	Manufacturer ID	0x11
	Device type ID	0x3C
	HART protocol revision	7
	Device description files (DTM, DD)	Information and files under: www.endress.com
	HART load	Min. 250 Ω
	System integration	Information on system integration →  77. <ul style="list-style-type: none"> ▪ Measured variables via HART protocol ▪ Burst Mode functionality

16.5 Power supply

Terminal assignment →  39

Supply voltage	Order code for "Power supply"	Terminal voltage		Frequency range
	Option D	DC24 V	±20%	–
	Option E	AC100 to 240 V	–15...+10%	50/60 Hz, ±4 Hz
	Option I	DC24 V	±20%	–
		AC100 to 240 V	–15...+10%	50/60 Hz, ±4 Hz

Power consumption **Transmitter**
Max. 10 W (active power)

switch-on current	Max. 36 A (<5 ms) as per NAMUR Recommendation NE 21
--------------------------	---

Current consumption **Transmitter**

- Max. 400 mA (24 V)
- Max. 200 mA (110 V, 50/60 Hz; 230 V, 50/60 Hz)

Power supply failure

- Totalizers stop at the last value measured.
- Depending on the device version, the configuration is retained in the device memory or in the pluggable data memory (HistoROM DAT).
- Error messages (incl. total operated hours) are stored.

Electrical connection →  39

Potential equalization →  42

terminals Spring-loaded terminals: Suitable for strands and strands with ferrules.
Conductor cross-section 0.2 to 2.5 mm² (24 to 12 AWG).

- Cable entries
- Cable gland: M20 × 1.5 with cable Ø 6 to 12 mm (0.24 to 0.47 in)
 - Thread for cable entry:
 - NPT ½"
 - G ½"
 - M20

Cable specification →  36

16.6 Performance characteristics

- Reference operating conditions
- Error limits following DIN EN 29104, in future ISO 20456
 - Water, typically: +15 to +45 °C (+59 to +113 °F); 0.5 to 7 bar (73 to 101 psi)
 - Data as indicated in the calibration protocol
 - Accuracy based on accredited calibration rigs according to ISO 17025

Maximum measured error o.r. = of reading

Error limits under reference operating conditions

Volume flow

- ±0.5 % o.r. ± 1 mm/s (0.04 in/s)
- Optional: ±0.2 % o.r. ± 2 mm/s (0.08 in/s)

Order code for "Design"	Installation <i>with</i> inlet and outlet runs max. measured error		Installation <i>without</i> inlet and outlet runs max. measured error
	0.5 %	0.2 %	0.5 %
Options D, E, F, G (standard)	✓	✓	not recommended
Options C, H, I (0 x DN)	✓	✓	✓

 Fluctuations in the supply voltage do not have any effect within the specified range.

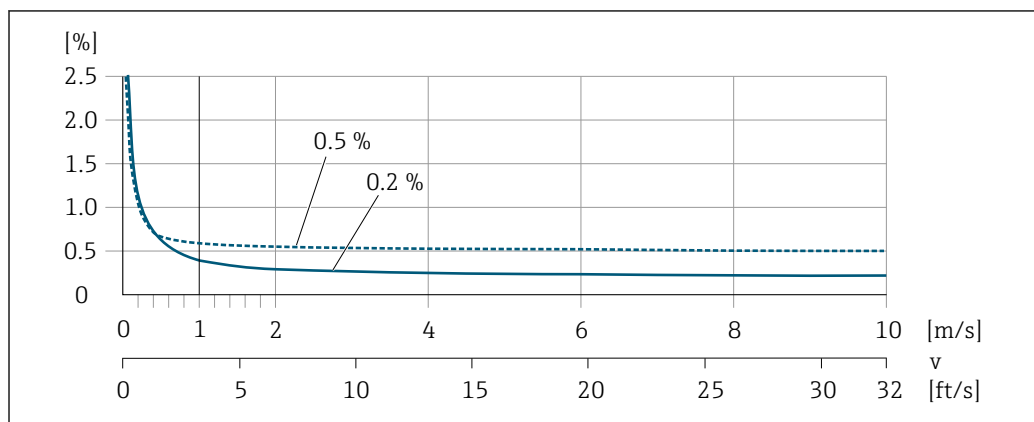

 37 Maximum measured error in % o.r.

Flat Spec

For Flat Spec in the range $v_{0.5}$ ($v_{0.2}$) up to v_{max} the measured error is constant.

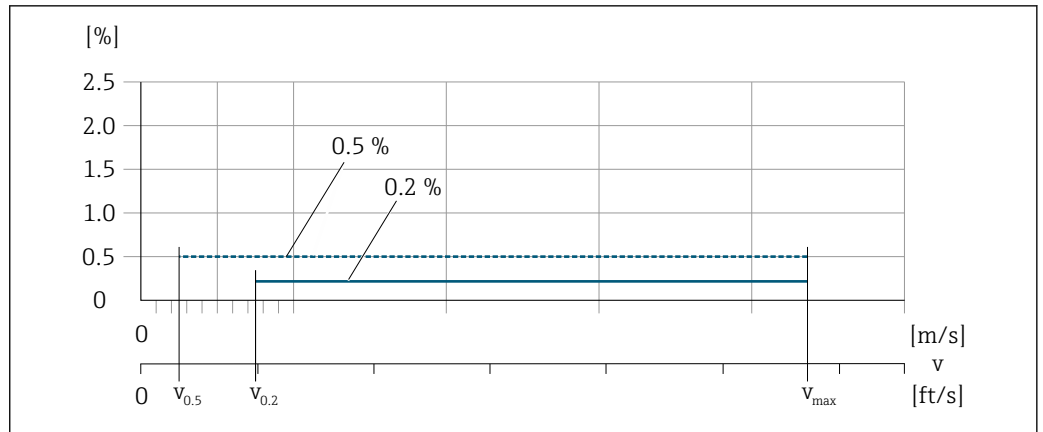

38 Flat Spec in % o.r.

Flat Spec flow values 0.5 %

Nominal diameter		v _{0.5}		v _{max}	
[mm]	[in]	[m/s]	[ft/s]	[m/s]	[ft/s]
25 to 600	1 to 24	0.5	1.64	10	32
50 to 300 ¹⁾	2 to 12	0.25	0.82	5	16

1) Order code for "Design", option C

Flat Spec flow values 0.2 %

Nominal diameter		v _{0.2}		v _{max}	
[mm]	[in]	[m/s]	[ft/s]	[m/s]	[ft/s]
25 to 600	1 to 24	1.5	4.92	10	32
50 to 300 ¹⁾	2 to 12	0.6	1.97	4	13

1) Order code for "Design", option C

Electrical conductivity

Max. measured error not specified.

Accuracy of outputs

The outputs have the following base accuracy specifications.

Current output

Accuracy	±5 µA
----------	-------

Pulse/frequency output

o.r. = of reading

Accuracy	Max. ±50 ppm o.r. (over the entire ambient temperature range)
----------	---

Repeatability o.r. = of reading

Volume flow

Max. ±0.1 % o.r. ± 0.5 mm/s (0.02 in/s)

Electrical conductivity

Max. ± 5 % o.r.

Influence of ambient temperature

Current output

Temperature coefficient	Max. 1 $\mu\text{A}/^\circ\text{C}$
-------------------------	-------------------------------------

Pulse/frequency output

Temperature coefficient	No additional effect. Included in accuracy.
-------------------------	---

16.7 Installation

Chapter "Mounting requirements" →  21

16.8 Environment

Ambient temperature range

→  23

Storage temperature

The storage temperature corresponds to the operating temperature range of the transmitter and the sensor →  23.

- Protect the measuring device against direct sunlight during storage in order to avoid unacceptably high surface temperatures.
- Select a storage location where moisture cannot collect in the measuring device as fungus or bacteria infestation can damage the liner.
- If protection caps or protective covers are mounted these should never be removed before installing the measuring device.

Degree of protection

Measuring device

- As standard: IP66/67, type 4X enclosure
- When housing is open: IP20, type 1 enclosure
- Display module: IP20, type 1 enclosure

External WLAN antenna

IP67

Vibration- and shock-resistance

Vibration sinusoidal, in accordance with IEC 60068-2-6

- 2 to 8.4 Hz, 3.5 mm peak
- 8.4 to 2 000 Hz, 1 g peak

Vibration broad-band random, according to IEC 60068-2-64

- 10 to 200 Hz, 0.003 g^2/Hz
- 200 to 2 000 Hz, 0.001 g^2/Hz
- Total: 1.54 g rms

Shock half-sine, according to IEC 60068-2-27

6 ms 30 g

Rough handling shocks according to IEC 60068-2-31

Mechanical load

- Protect the transmitter housing against mechanical effects, such as shock or impact; the use of the remote version is sometimes preferable.
- Never use the transmitter housing as a ladder or climbing aid.

Electromagnetic compatibility (EMC)
 As per IEC/EN 61326 and NAMUR Recommendation 21 (NE 21)
 Details are provided in the Declaration of Conformity.

16.9 Process

Medium temperature range

- 0 to +80 °C (+32 to +176 °F) for hard rubber, DN 50 to 2400 (2 to 90")
- -20 to +50 °C (-4 to +122 °F) for polyurethane, DN 25 to 1200 (1 to 48")
- -20 to +90 °C (-4 to +194 °F) for PTFE, DN 25 to 300 (1 to 12")

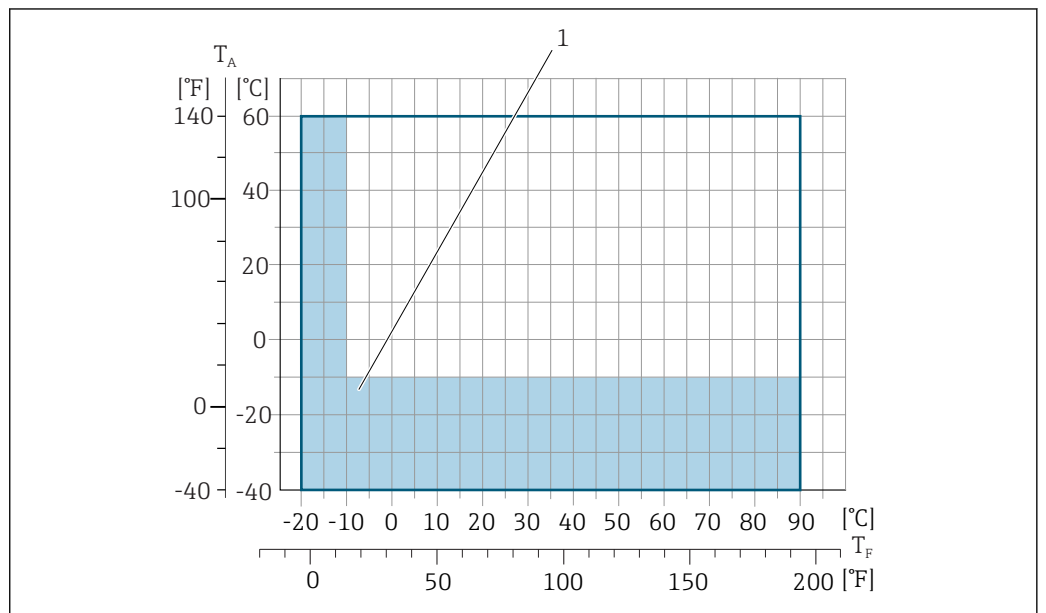

T_A Ambient temperature range
 T_F Medium temperature
 1 Colored area: the ambient temperature range of -10 to -40 °C (+14 to -40 °F) and the fluid temperature range of -10 to -20 °C (+14 to -4 °F) applies to stainless flanges only

Conductivity ≥ 5 μS/cm for liquids in general.

Pressure-temperature ratings
 An overview of the pressure-temperature ratings for the process connections is provided in the "Technical Information" document

Pressure tightness *Liner: hard rubber*

Nominal diameter		Limit values for absolute pressure in [mbar] ([psi]) for medium temperatures:		
[mm]	[in]	+25 °C (+77 °F)	+50 °C (+122 °F)	+80 °C (+176 °F)
50 ... 2400	2 ... 90	0 (0)	0 (0)	0 (0)

Liner: polyurethane

Nominal diameter		Limit values for absolute pressure in [mbar] ([psi]) for medium temperatures:	
[mm]	[in]	+25 °C (+77 °F)	+50 °C (+122 °F)
25 ... 1200	1 ... 48	0 (0)	0 (0)

Liner: PTFE

Nominal diameter		Limit values for absolute pressure in [mbar] ([psi]) for medium temperatures:	
[mm]	[in]	+25 °C (+77 °F)	+90 °C (+194 °F)
25	1	0 (0)	0 (0)
40	2	0 (0)	0 (0)
50	2	0 (0)	0 (0)
65	2 ½	0 (0)	40 (0.58)
80	3	0 (0)	40 (0.58)
100	4	0 (0)	135 (2.0)
125	5	135 (2.0)	240 (3.5)
150	6	135 (2.0)	240 (3.5)
200	8	200 (2.9)	290 (4.2)
250	10	330 (4.8)	400 (5.8)
300	12	400 (5.8)	500 (7.3)

Flow limit

The diameter of the pipe and the flow rate determine the nominal diameter of the sensor. The optimum velocity of flow is between 2 to 3 m/s (6.56 to 9.84 ft/s). Also match the velocity of flow (v) to the physical properties of the fluid:

- v < 2 m/s (6.56 ft/s): for abrasive fluids (e.g. potter's clay, lime milk, ore slurry)
- v > 2 m/s (6.56 ft/s): for fluids producing buildup (e.g. wastewater sludge)



A necessary increase in the flow velocity can be achieved by reducing the sensor nominal diameter.



For an overview of the full scale values for the measuring range, see the "Measuring range" section

Pressure loss

- No pressure loss occurs if the sensor is installed in a pipe with the same nominal diameter.
- Pressure losses for configurations incorporating adapters according to DIN EN 545
→ 25

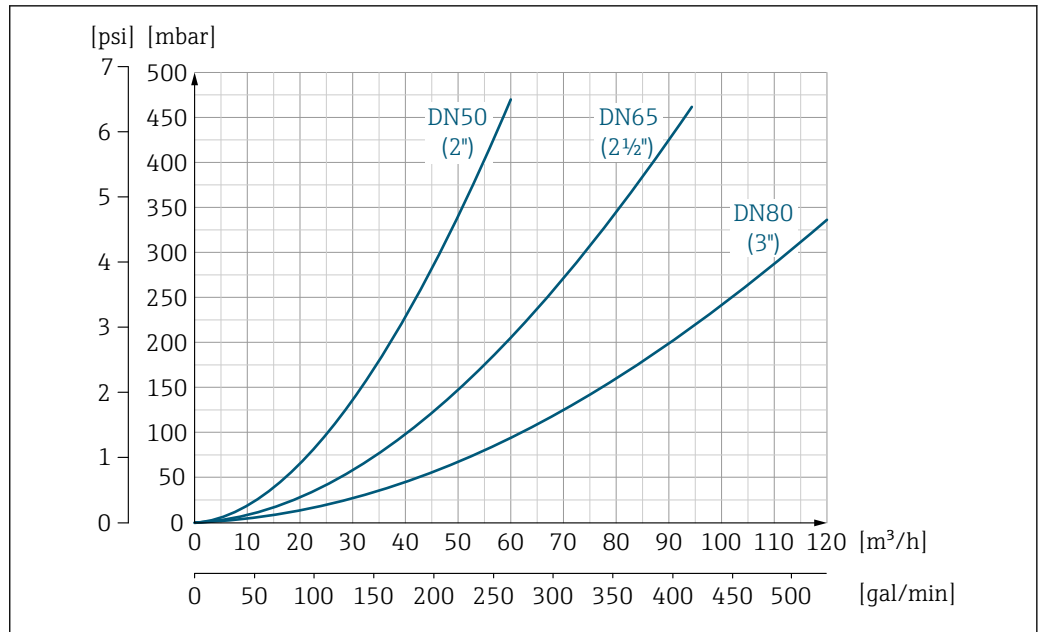

39 Pressure loss DN 50 to 80 (2 to 3") for order code for "Design", option C "fixed flange, without inlet/outlet runs"

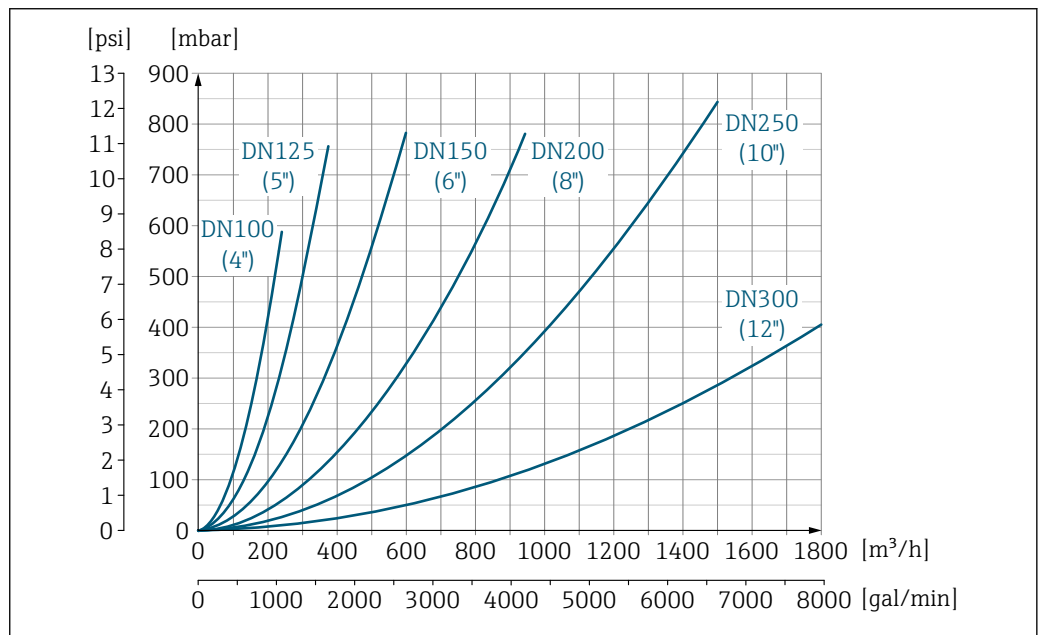

40 Pressure loss DN 100 to 300 (4 to 12") for order code for "Design", option C "fixed flange, without inlet/outlet runs"

System pressure → 24

Vibrations → 24

16.10 Mechanical construction

Design, dimensions



For the dimensions and installation lengths of the device, see the "Technical Information" document, "Mechanical construction" section.

Weight

All values (weight exclusive of packaging material) refer to devices with flanges of the standard pressure rating.

The weight may be lower than indicated depending on the pressure rating and design. Weight specifications including transmitter as per order code for "Housing", option A "Aluminum, coated".

Different values due to different transmitter versions:

Transmitter version for the hazardous area

(Order code for "Housing", option A "Aluminum, coated"; Ex d): +2 kg (+4.4 lbs)

Weight in SI units

Order code for "Design", options C, D, E DN 25 to 400, DN 1" to 16"				
Nominal diameter		Reference values		
		EN (DIN), AS, JIS		ASME (Class 150)
[mm]	[in]	Pressure rating	[kg]	[kg]
25	1	PN 40	10	5
32	-	PN 40	11	-
40	1 ½	PN 40	12	7
50	2	PN 40	13	9
65	-	PN 16	13	-
80	3	PN 16	15	14
100	4	PN 16	18	19
125	-	PN 16	25	-
150	6	PN 16	31	33
200	8	PN 10	52	52
250	10	PN 10	81	90
300	12	PN 10	95	129
350	14	PN 6	106	172
375	15	PN 6	121	-
400	16	PN 6	121	203

Order code for "Design", options F ≥ DN 450 (18")				
Nominal diameter		Reference values		
		EN (DIN) (PN16)	AS (PN 16)	ASME (Class 150), AWWA (Class D)
[mm]	[in]	[kg]	[kg]	[kg]
450	18	142	138	191
500	20	182	186	228
600	24	227	266	302
700	28	291	369	266
-	30	-	447	318
800	32	353	524	383
900	36	444	704	470
1000	40	566	785	587
-	42	-	-	670

Order code for "Design", options F ≥ DN 450 (18")				
Nominal diameter		Reference values		
		EN (DIN) (PN16)	AS (PN 16)	ASME (Class 150), AWWA (Class D)
[mm]	[in]	[kg]	[kg]	[kg]
1200	48	843	1229	901
-	54	-	-	1273
1400	-	1204	-	-
-	60	-	-	1594
1600	-	1845	-	-
-	66	-	-	2131
1800	72	2357	-	2568
-	78	2929	-	3113
2000	-	2929	-	3113
-	84	-	-	3755
2200	-	3422	-	-
-	90	-	-	4797
2400	-	4094	-	-

Order code for "Design", options G ≥ DN 450 (18")				
Nominal diameter		Reference values		
		EN (DIN) (PN 6)	ASME (Class 150), AWWA (Class D)	
[mm]	[in]	[kg]	[kg]	
450	18	161	255	
500	20	156	285	
600	24	208	405	
700	28	304	400	
-	30	-	460	
800	32	357	550	
900	36	485	800	
1000	40	589	900	
-	42	-	1100	
1200	48	850	1400	
-	54	850	2200	
1400	-	1300	-	
-	60	-	2700	
1600	-	1845	-	
-	66	-	3700	
1800	72	2357	4100	
-	78	2929	4600	
2000	-	2929	-	

Weight in US units

Order code for "Design", options C, D, E DN 25 to 400, DN 1" to 16"		
Nominal diameter		Reference values ASME (Class 150)
[mm]	[in]	[lb]
25	1	11
32	-	-
40	1 ½	15
50	2	20
65	-	-
80	3	31
100	4	42
125	-	-
150	6	73
200	8	115
250	10	198
300	12	284
350	14	379
375	15	-
400	16	448

Order code for "Design", options F ≥ DN 450 (18")		
Nominal diameter		Reference values ASME (Class 150), AWWA (Class D)
[mm]	[in]	[lb]
450	18	421
500	20	503
600	24	666
700	28	587
-	30	701
800	32	845
900	36	1036
1000	40	1294
-	42	1477
1200	48	1987
-	54	2807
1400	-	-
-	60	3515
1600	-	-
-	66	4699
1800	72	5662
-	78	6864

Order code for "Design", options F ≥ DN 450 (18")		
Nominal diameter		Reference values ASME (Class 150), AWWA (Class D)
[mm]	[in]	[lb]
2000	-	6864
-	84	8280
2200	-	-
-	90	10 577
2400	-	-

Order code for "Design", options G ≥ DN 450 (18")		
Nominal diameter		Reference values ASME (Class 150), AWWA (Class D)
[mm]	[in]	[lb]
450	18	562
500	20	628
600	24	893
700	28	882
-	30	1014
800	32	1213
900	36	1764
1000	40	1984
-	42	2426
1200	48	3087
-	54	4851
1400	-	-
-	60	5954
1600	-	-
-	66	8158
1800	72	9040
-	78	10 143
2000	-	-

Measuring tube specification

Nominal diameter		EN (DIN)	Pressure rating			Measuring tube internal diameter					
			ASME AWWA	AS 2129 AS 4087	JIS	Hard rubber		Polyurethane		PTFE	
[mm]	[in]					[mm]	[in]	[mm]	[in]	[mm]	[in]
25	1	PN 40	Class 150	-	20K	-	-	24	0.94	25	0.98
32	-	PN 40	-	-	20K	-	-	32	1.26	34	1.34
40	1 ½	PN 40	Class 150	-	20K	-	-	38	1.50	40	1.57
50	2	PN 40	Class 150	Table E, PN 16	10K	50	1.97	50	1.97	52	2.05

Nominal diameter		Pressure rating				Measuring tube internal diameter					
		EN (DIN)	ASME AWWA	AS 2129 AS 4087	JIS	Hard rubber		Polyurethane		PTFE	
[mm]	[in]					[mm]	[in]	[mm]	[in]	[mm]	[in]
50 ¹⁾	2	PN 40	Class 150	Table E, PN 16	10K	32	1.26	-	-	-	-
65	-	PN 16	-	-	10K	66	2.60	66	2.60	68	2.68
65 ¹⁾	-	PN 16	-	-	10K	38	1.50	-	-	-	-
80	3	PN 16	Class 150	Table E, PN 16	10K	79	3.11	79	3.11	80	3.15
80 ¹⁾	3	PN 16	Class 150	Table E, PN 16	10K	50	1.97	-	-	-	-
100	4	PN 16	Class 150	Table E, PN 16	10K	102	4.02	102	4.02	104	4.09
100 ¹⁾	4	PN 16	Class 150	Table E, PN 16	10K	66	2.60	-	-	-	-
125	-	PN 16	-	-	10K	127	5.00	127	5.00	130	5.12
125 ¹⁾	-	PN 16	-	-	10K	79	3.11	-	-	-	-
150	6	PN 16	Class 150	Table E, PN 16	10K	156	6.14	156	6.14	156	6.14
150 ¹⁾	6	PN 16	Class 150	Table E, PN 16	10K	102	4.02	-	-	-	-
200	8	PN 10	Class 150	Table E, PN 16	10K	204	8.03	204	8.03	202	7.95
200 ¹⁾	8	PN 16	Class 150	Table E, PN 16	10K	127	5.00	-	-	-	-
250	10	PN 10	Class 150	Table E, PN 16	10K	258	10.2	258	10.2	256	10.08
250 ¹⁾	10	PN 16	Class 150	Table E, PN 16	10K	156	6.14	-	-	-	-
300	12	PN 10	Class 150	Table E, PN 16	10K	309	12.2	309	12.2	306	12.05
300 ¹⁾	12	PN 16	Class 150	Table E, PN 16	10K	204	8.03	-	-	-	-
350	14	PN 6	Class 150	Table E, PN 16	10K	337	13.3	342	13.5	-	-
375	15	-	-	PN 16	10K	389	15.3	-	-	-	-
400	16	PN 6	Class 150	Table E, PN 16	10K	387	15.2	392	15.4	-	-
450	18	PN 6	Class 150	-	10K	436	17.1	437	17.2	-	-
500	20	PN 6	Class 150	Table E, PN 16	10K	487	19.1	492	19.4	-	-
600	24	PN 6	Class 150	Table E, PN 16	10K	589	23.0	594	23.4	-	-
700	28	PN 6	Class D	Table E, PN 16	10K	688	27.1	692	27.2	-	-
750	30	-	Class D	Table E, PN 16	10K	737	29.1	742	29.2	-	-
800	32	PN 6	Class D	Table E, PN 16	-	788	31.0	794	31.3	-	-
900	36	PN 6	Class D	Table E, PN 16	-	889	35.0	891	35.1	-	-
1000	40	PN 6	Class D	Table E, PN 16	-	991	39.0	994	39.1	-	-
-	42	-	Class D	-	-	1043	41.1	1043	41.1	-	-
1200	48	PN 6	Class D	Table E, PN 16	-	1191	46.9	1197	47.1	-	-
-	54	-	Class D	-	-	1339	52.7	-	-	-	-
1400	-	PN 6	-	-	-	1402	55.2	-	-	-	-
-	60	-	Class D	-	-	1492	58.7	-	-	-	-
1600	-	PN 6	-	-	-	1600	63.0	-	-	-	-
-	66	-	Class D	-	-	1638	64.5	-	-	-	-
1800	72	PN 6	-	-	-	1786	70.3	-	-	-	-
-	78	-	Class D	-	-	1989	78.3	-	-	-	-
2000	-	PN 6	-	-	-	1989	78.3	-	-	-	-
-	84	-	Class D	-	-	2099	84.0	-	-	-	-
2200	-	PN 6	-	-	-	2194	87.8	-	-	-	-

Nominal diameter		Pressure rating				Measuring tube internal diameter					
		EN (DIN)	ASME AWWA	AS 2129 AS 4087	JIS	Hard rubber		Polyurethane		PTFE	
[mm]	[in]					[mm]	[in]	[mm]	[in]	[mm]	[in]
-	90	-	Class D	-	-	2246	89.8	-	-	-	-
2400	-	PN 6	-	-	-	2391	94.1	-	-	-	-

1) Order code for "Design", option C

Materials

Transmitter housing

Order code for "Housing":

Option **A** "Aluminum, coated": aluminum, AlSi10Mg, coated

Window material

Order code for "Housing":

Option **A** "Aluminum, coated": glass

Cable entries/cable glands

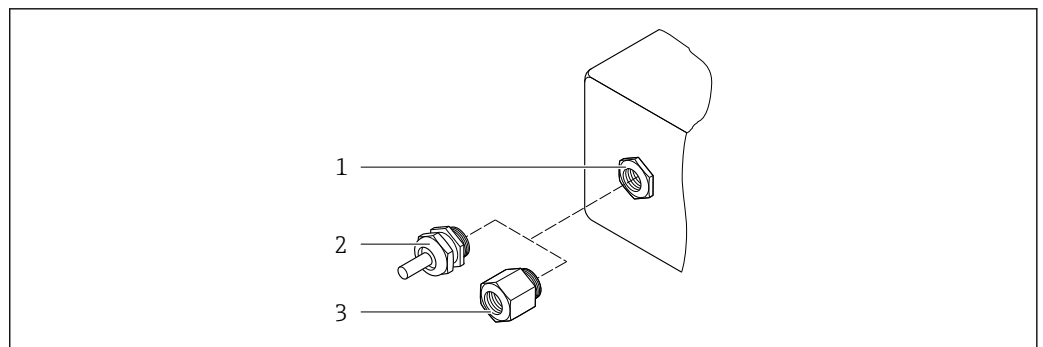

41 Possible cable entries/cable glands

1 Female thread M20 × 1.5

2 Cable gland M20 × 1.5

3 Adapter for cable entry with internal thread G ½" or NPT ½"

Order code for "Housing", option A "Aluminum, coated"

The various cable entries are suitable for hazardous and non-hazardous areas.

Cable entry/cable gland	Material
Coupling M20 × 1.5	Non-Ex: plastic
	Z2, D2, Ex d/de: brass with plastic
Adapter for cable entry with internal thread G ½"	Nickel-plated brass
Adapter for cable entry with internal thread NPT ½"	

Sensor housing

- DN 25 to 300 (1 to 12")
Aluminum half-shell housing, aluminum, AlSi10Mg, coated
- DN 350 to 2400 (14 to 90")
Fully welded carbon steel housing with protective varnish

Measuring tubes

- DN 25 to 600 (1 to 24")
Stainless steel: 1.4301, 1.4306, 304, 304L
- DN 700 to 2400 (28 to 90")
Stainless steel: 1.4301, 304



Liner

- DN 25 to 300 (1 to 12"): PTFE
- DN 25 to 1200 (1 to 48"): polyurethane
- DN 50 to 2400 (2 to 90"): hard rubber

Electrodes

- Stainless steel, 1.4435 (316L)
- Alloy C22, 2.4602 (UNS N06022)
- Tantalum

Process connections

-  For flanges made of carbon steel:
 - DN ≤ 300 (12"): with Al/Zn protective coating or protective varnish
 - DN ≥ 350 (14"): protective varnish
-  All carbon steel lap joint flanges are supplied with a hot-dip galvanized finish.

EN 1092-1 (DIN 2501)

Fixed flange

- Carbon steel:
 - DN ≤ 300: S235JRG2, S235JR+N, P245GH, A105, E250C
 - DN 350 to 2400: P245GH, S235JRG2, A105, E250C
- Stainless steel:
 - DN ≤ 300: 1.4404, 1.4571, F316L
 - DN 350 to 600: 1.4571, F316L, 1.4404
 - DN 700 to 1000: 1.4404, F316L

Lap joint flange

- Carbon steel DN ≤ 300: S235JRG2, A105, E250C
- Stainless steel DN ≤ 300: 1.4306, 1.4404, 1.4571, F316L

Lap joint flange, stamped plate

- Carbon steel DN ≤ 300: S235JRG2 similar to S235JR+AR or 1.0038
- Stainless steel DN ≤ 300: 1.4301 similar to 304

ASME B16.5

Fixed flange, lap joint flange

- Carbon steel: A105
- Stainless steel: F316L

JIS B2220

- Carbon steel: A105, A350 LF2
- Stainless steel: F316L

AWWA C207

Carbon steel: A105, P265GH, A181 Class 70, E250C, S275JR

AS 2129

Carbon steel: A105, E250C, P235GH, P265GH, S235JRG2

AS 4087

Carbon steel: A105, P265GH, S275JR

Seals

As per DIN EN 1514-1, form IBC

Accessories

Protective cover

Stainless steel, 1.4404 (316L)

External WLAN antenna

- Antenna: ASA plastic (acrylic ester-styrene-acrylonitrile) and nickel-plated brass
- Adapter: Stainless steel and nickel-plated brass
- Cable: Polyethylene
- Plug: Nickel-plated brass
- Angle bracket: Stainless steel

Ground disks

- Stainless steel, 1.4435 (316L)
- Alloy C22, 2.4602 (UNS N06022)
- Tantalum

Fitted electrodes

Measurement, reference and empty pipe detection electrodes available as standard with:

- 1.4435 (316L)
- Alloy C22, 2.4602 (UNS N06022)
- Tantalum

Process connections

- EN 1092-1 (DIN 2501)
 - DN ≤ 300: fixed flange (PN 10/16/25/40) = Form A, lap joint flange (PN 10/16), lap joint flange, stamped plate (PN 10) = Form A
 - DN ≥ 350: fixed flange (PN 6/10/16/25) = flat face (Form B)
 - DN 450 to 2400: fixed flange (PN 6/10/16) = flat face (Form B)
- ASME B16.5
 - DN 350 to 2400 (14 to 90"): fixed flange (Class 150)
 - DN 25 to 600 (1 to 24"): lap joint flange (Class 150)
 - DN 25 to 150 (1 to 6"): fixed flange (Class 300)
- JIS B2220
 - DN 50 to 750: fixed flange (10K)
 - DN 25 to 600: fixed flange (20K)
- AWWA C207
 - DN 48 to 90": fixed flange (Class D)
- AS 2129
 - DN 50 to 1200: fixed flange (Table E)
- AS 4087
 - DN 50 to 1200): fixed flange (PN 16)



For information on the different materials used in the process connections → 186

Surface roughness

Electrodes with 1.4435 (316L); Alloy C22, 2.4602 (UNS N06022); tantalum:
 ≤ 0.3 to 0.5 μm (11.8 to 19.7 μin)
 (All data relate to parts in contact with fluid)

16.11 Human interface

Languages

Can be operated in the following languages:



- Via local operation
English, German, French, Spanish, Italian, Dutch, Portuguese, Polish, Russian, Turkish, Chinese, Japanese, Korean, Bahasa (Indonesian), Vietnamese, Czech, Swedish
- Via Web browser
English, German, French, Spanish, Italian, Dutch, Portuguese, Polish, Russian, Turkish, Chinese, Japanese, Korean, Bahasa (Indonesian), Vietnamese, Czech, Swedish
- Via "FieldCare", "DeviceCare" operating tool: English, German, French, Spanish, Italian, Chinese, Japanese

Local operation

Via display module

Equipment:

- Order code for "Display; operation", option F "4-line, illuminated, graphic display; touch control"
- Order code for "Display; operation", option G "4-line, illuminated, graphic display; touch control + WLAN"

 Information about WLAN interface →  72

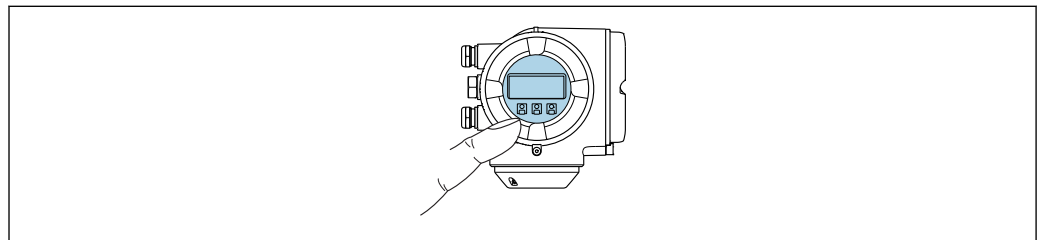



A0026785

 42 Operation with touch control



Display elements

- 4-line, illuminated, graphic display
- White background lighting; switches to red in event of device errors
- Format for displaying measured variables and status variables can be individually configured
- Permitted ambient temperature for the display: -20 to +60 °C (-4 to +140 °F)
The readability of the display may be impaired at temperatures outside the temperature range.

Operating elements

- External operation via touch control (3 optical keys) without opening the housing: , , 
- Operating elements also accessible in the various zones of the hazardous area

Via remote display and operating module DKX001

 The remote display and operating module DKX001 is available as an optional extra →  158.

- The measuring device is always supplied with a dummy cover when the remote display and operating module DKX001 is ordered directly with the measuring device. Display or operation at the transmitter is not possible in this case.
- If ordered subsequently, the remote display and operating module DKX001 may not be connected at the same time as the existing measuring device display module. Only one display or operation unit may be connected to the transmitter at any one time.

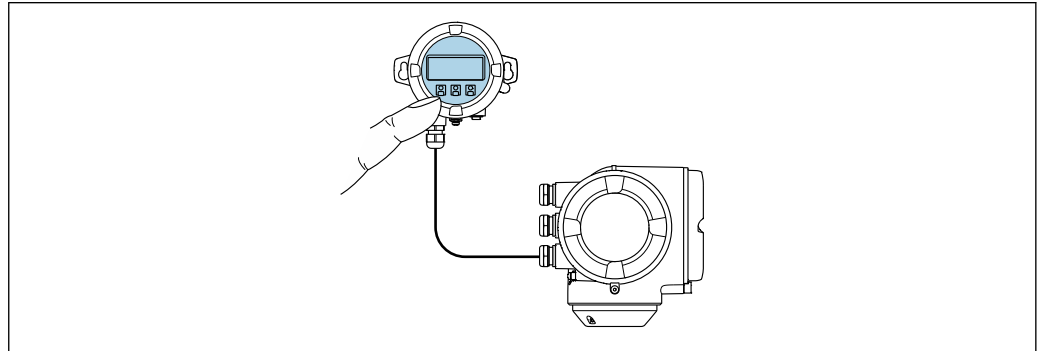

A0026786

 43 Operation via remote display and operating module DKX001

Display and operating elements

The display and operating elements correspond to those of the display module →  188.

Housing material

Transmitter housing		Remote display and operating module
Order code for "Housing"	Material	Material
Option A "Aluminum, coated"	AlSi10Mg, coated	AlSi10Mg, coated

Cable entry

Corresponds to the choice of transmitter housing, order code for "Electrical connection".

Connecting cable

→  37

Dimensions





Information on the dimensions:

"Mechanical construction" section of the "Technical Information" document.

Remote operation →  70

Service interface →  71

Supported operating tools Different operating tools can be used for local or remote access to the measuring device. Depending on the operating tool used, access is possible with different operating units and via a variety of interfaces.

Supported operating tools	Operating unit	Interface	Additional information
Web browser	Notebook, PC or tablet with Web browser	<ul style="list-style-type: none"> ■ CDI-RJ45 service interface ■ WLAN interface 	Special Documentation for device
DeviceCare SFE100	Notebook, PC or tablet with Microsoft Windows system	<ul style="list-style-type: none"> ■ CDI-RJ45 service interface ■ WLAN interface ■ Fieldbus protocol 	→  160
FieldCare SFE500	Notebook, PC or tablet with Microsoft Windows system	<ul style="list-style-type: none"> ■ CDI-RJ45 service interface ■ WLAN interface ■ Fieldbus protocol 	→  160
Device Xpert	Field Xpert SFX 100/350/370	HART and FOUNDATION Fieldbus fieldbus protocol	Operating Instructions BA01202S Device description files: Use update function of handheld terminal

 Other operating tools based on FDT technology with a device driver such as DTM/iDTM or DD/EDD can be used for device operation. These operating tools are available from the individual manufacturers. Integration into the following operating tools, among others, is supported:

- FactoryTalk AssetCentre (FTAC) by Rockwell Automation → www.rockwellautomation.com
- Process Device Manager (PDM) by Siemens → www.siemens.com
- Asset Management Solutions (AMS) by Emerson → www.emersonprocess.com
- FieldCommunicator 375/475 by Emerson → www.emersonprocess.com
- Field Device Manager (FDM) by Honeywell → www.honeywellprocess.com
- FieldMate by Yokogawa → www.yokogawa.com
- PACTWare → www.pactware.com

The associated device description files are available at: www.endress.com → Downloads

Web server

Thanks to the integrated Web server, the device can be operated and configured via a Web browser and via a service interface (CDI-RJ45) or via a WLAN interface. The structure of the operating menu is the same as for the local display. In addition to the measured values, status information on the device is also displayed and allows the user to monitor the status of the device. Furthermore the device data can be managed and the network parameters can be configured.



A device that has a WLAN interface (can be ordered as an option) is required for the WLAN connection: order code for "Display; operation", option G "4-line, illuminated; touch control + WLAN". The device acts as an Access Point and enables communication by computer or a mobile handheld terminal.

Supported functions

Data exchange between the operating unit (such as a notebook for example) and the measuring device:

- Upload the configuration from the measuring device (XML format, configuration backup)
- Save the configuration to the measuring device (XML format, restore configuration)
- Export event list (.csv file)
- Export parameter settings (.csv file or PDF file, document the measuring point configuration)
- Export the Heartbeat verification log (PDF file, only available with the "Heartbeat Verification" application package)

- Flash firmware version for device firmware upgrade, for instance
- Download driver for system integration
- Visualize up to 1000 saved measured values (only available with the **Extended HistoROM** application package →  193)

 Web server special documentation →  196

HistoROM data management

The measuring device features HistoROM data management. HistoROM data management comprises both the storage and import/export of key device and process data, making operation and servicing far more reliable, secure and efficient.

 When the device is delivered, the factory settings of the configuration data are stored as a backup in the device memory. This memory can be overwritten with an updated data record, for example after commissioning.

Additional information on the data storage concept

There are different types of data storage units in which device data are stored and used by the device:

	Device memory	T-DAT	S-DAT
Available data	<ul style="list-style-type: none"> ▪ Event logbook such as diagnostic events for example ▪ Parameter data record backup ▪ Device firmware package 	<ul style="list-style-type: none"> ▪ Measured value logging ("Extended HistoROM" order option) ▪ Current parameter data record (used by firmware at run time) ▪ Peakhold indicator (min/max values) ▪ Totalizer values 	<ul style="list-style-type: none"> ▪ Sensor data: nominal diameter etc. ▪ Serial number ▪ Calibration data ▪ Device configuration (e.g. SW options, fixed I/O or multi I/O)
Storage location	Fixed on the user interface board in the connection compartment	Attachable to the user interface board in the connection compartment	In the sensor plug in the transmitter neck part

Data backup

Automatic

- The most important device data (sensor and transmitter) are automatically saved in the DAT modules
- If the transmitter or measuring device is replaced: once the T-DAT containing the previous device data has been exchanged, the new measuring device is ready for operation again immediately without any errors
- If the sensor is replaced: once the sensor has been replaced, new sensor data are transferred from the S-DAT in the measuring device and the measuring device is ready for operation again immediately without any errors
- If exchanging the electronics module (e.g. I/O electronics module): Once the electronics module has been replaced, the software of the module is compared against the current device firmware. The module software is upgraded or downgraded where necessary. The electronics module is available for use immediately afterwards and no compatibility problems occur.

Manual

Additional parameter data record (complete parameter settings) in the integrated device memory HistoROM backup for:

- Data backup function
Backup and subsequent restoration of a device configuration in the device memory HistoROM backup
- Data comparison function
Comparison of the current device configuration with the device configuration saved in the device memory HistoROM backup

Data transfer

Manual

Transfer of a device configuration to another device using the export function of the specific operating tool, e.g. with FieldCare, DeviceCare or Web server: to duplicate the configuration or to store in an archive (e.g. for backup purposes)

Event list

Automatic

- Chronological display of up to 20 event messages in the events list
- If the **Extended HistoROM** application package (order option) is enabled: up to 100 event messages are displayed in the events list along with a time stamp, plain text description and remedial measures
- The events list can be exported and displayed via a variety of interfaces and operating tools e.g. DeviceCare, FieldCare or Web server

Data logging

Manual

If the **Extended HistoROM** application package (order option) is enabled:

- Record up to 1 000 measured values via 1 to 4 channels
- User configurable recording interval
- Record up to 250 measured values via each of the 4 memory channels
- Export the measured value log via a variety of interfaces and operating tools e.g. FieldCare, DeviceCare or web server

16.12 Certificates and approvals

 Currently available certificates and approvals can be called up via the product configurator.

CE mark	The device meets the legal requirements of the applicable EU Directives. These are listed in the corresponding EU Declaration of Conformity along with the standards applied. Endress+Hauser confirms successful testing of the device by affixing to it the CE mark.
RCM-tick symbol	The measuring system meets the EMC requirements of the "Australian Communications and Media Authority (ACMA)".
Ex approval	The devices are certified for use in hazardous areas and the relevant safety instructions are provided in the separate "Safety Instructions" (XA) document. Reference is made to this document on the nameplate.
Drinking water approval	<ul style="list-style-type: none"> ▪ ACS ▪ KTW/W270 ▪ NSF 61 ▪ WRAS BS 6920
HART certification	<p>HART interface</p> <p>The measuring device is certified and registered by the FieldComm Group. The measuring system meets all the requirements of the following specifications:</p> <ul style="list-style-type: none"> ▪ Certified according to HART 7 ▪ The device can also be operated with certified devices of other manufacturers (interoperability)

Radio approval

The measuring device has radio approval.



For detailed information regarding radio approval, see Special Documentation

Other standards and guidelines

- EN 60529
Degrees of protection provided by enclosures (IP code)
- EN 61010-1
Safety requirements for electrical equipment for measurement, control and laboratory use - general requirements
- IEC/EN 61326
Emission in accordance with Class A requirements. Electromagnetic compatibility (EMC requirements).
- NAMUR NE 21
Electromagnetic compatibility (EMC) of industrial process and laboratory control equipment
- NAMUR NE 32
Data retention in the event of a power failure in field and control instruments with microprocessors
- NAMUR NE 43
Standardization of the signal level for the breakdown information of digital transmitters with analog output signal.
- NAMUR NE 53
Software of field devices and signal-processing devices with digital electronics
- NAMUR NE 105
Specifications for integrating fieldbus devices in engineering tools for field devices
- NAMUR NE 107
Self-monitoring and diagnosis of field devices
- NAMUR NE 131
Requirements for field devices for standard applications
- ETSI EN 300 328
Guidelines for 2.4 GHz radio components.
- EN 301489
Electromagnetic compatibility and radio spectrum matters (ERM).

16.13 Application packages

Many different application packages are available to enhance the functionality of the device. Such packages might be needed to address safety aspects or specific application requirements.



The application packages can be ordered with the device or subsequently from Endress+Hauser. Detailed information on the order code in question is available from your local Endress+Hauser sales center or on the product page of the Endress+Hauser website: www.endress.com.

Diagnostics functions



Package	Description
Extended HistoROM	<p>Comprises extended functions concerning the event log and the activation of the measured value memory.</p> <p>Event log: Memory volume is extended from 20 message entries (standard version) to up to 100 entries.</p> <p>Data logging (line recorder):</p> <ul style="list-style-type: none"> ■ Memory capacity for up to 1000 measured values is activated. ■ 250 measured values can be output via each of the 4 memory channels. The recording interval can be defined and configured by the user. ■ Measured value logs can be accessed via the local display or operating tool e.g. FieldCare, DeviceCare or Web server.

Package	Description
Heartbeat Verification +Monitoring	<p>Heartbeat Verification Meets the requirement for traceable verification to DIN ISO 9001:2008 Chapter 7.6 a) "Control of monitoring and measuring equipment".</p> <ul style="list-style-type: none"> ▪ Functional testing in the installed state without interrupting the process. ▪ Traceable verification results on request, including a report. ▪ Simple testing process via local operation or other operating interfaces. ▪ Clear measuring point assessment (pass/fail) with high test coverage within the framework of manufacturer specifications. ▪ Extension of calibration intervals according to operator's risk assessment. <p>Heartbeat Monitoring Continuously supplies data, which are characteristic of the measuring principle, to an external condition monitoring system for the purpose of preventive maintenance or process analysis. These data enable the operator to:</p> <ul style="list-style-type: none"> ▪ Draw conclusions - using these data and other information - about the impact process influences (such as corrosion, abrasion, buildup etc.) have on the measuring performance over time. ▪ Schedule servicing in time. ▪ Monitor the process or product quality, e.g. gas pockets.

Package	Description
Electrode cleaning circuit (ECC)	The electrode cleaning circuit (ECC) function has been developed to have a solution for applications where magnetite (Fe ₃ O ₄) deposits frequently occur (e.g. hot water). Since magnetite is highly conductive this build up leads to measuring errors and ultimately to the loss of signal. The application package is designed to AVOID build up of highly conductive matter and thin layers (typical of magnetite).

Package	Description
OPC-UA-Server	<p>The application package provides the user with an integrated OPC-UA server for comprehensive instrument services for IoT and SCADA applications.</p> <p> Special Documentation for the "OPC-UA-Server" application package →  196.</p>

16.14 Accessories

 Overview of accessories available for order →  158

16.15 Supplementary documentation

 For an overview of the scope of the associated Technical Documentation, refer to the following:

- *W@M Device Viewer* (www.endress.com/deviceviewer): Enter the serial number from nameplate
- *Endress+Hauser Operations App*: Enter the serial number from the nameplate or scan the 2D matrix code (QR code) on the nameplate

Standard documentation **Brief Operating Instructions**

Brief Operating Instructions for the sensor

Measuring device	Documentation code
Proline Promag W	KA01266D

Brief Operating Instructions for transmitter

Measuring device	Documentation code
Proline 300	KA01308D

Technical Information

Measuring device	Documentation code
Promag W 300	TI01414D

Description of device parameters

Measuring device	Documentation code
Promag 300	GP01051D

Device-dependent
additional documentation

Safety instructions

Safety instructions for electrical equipment for hazardous areas.

Contents	Documentation code
ATEX/IECEX Ex d/Ex de	XA01414D
ATEX/IECEX Ex ec	XA01514D
cCSAus XP	XA01515D
cCSAus Ex d/ Ex de	XA01516D
cCSAus Ex nA	XA01517D
INMETRO Ex d/Ex de	XA01518D
INMETRO Ex ec	XA01519D
NEPSI Ex d/Ex de	XA01520D
NEPSI Ex nA	XA01521D
EAC Ex d/Ex de	XA01656D
EAC Ex nA	XA01657D
JPN Ex d	XA01775D

Remote display and operating module DKX001

Contents	Documentation code
ATEX/IECEX Ex i	XA01494D
ATEX/IECEX Ex ec	XA01498D
cCSAus IS	XA01499D
cCSAus Ex nA	XA01513D
INMETRO Ex i	XA01500D
INMETRO Ex ec	XA01501D
NEPSI Ex i	XA01502D
NEPSI Ex nA	XA01503D

Special Documentation

Contents	Documentation code
Information on the Pressure Equipment Directive	SD01614D
Radio approvals for WLAN interface for A309/A310 display module	SD01793D
Remote display and operating module DKX001	SD01763D
OPC-UA Server	SD02043D

Contents	Documentation code
Heartbeat Technology	SD01640D
Web server	SD01654D

Installation Instructions

Content	Comment
Installation instructions for spare part sets and accessories	<ul style="list-style-type: none"> ▪ Access the overview of all the available spare part sets via <i>W@M Device Viewer</i> → 📄 156 ▪ Accessories available for order with Installation Instructions → 📄 158

Index

A

- About this document 6
- Access authorization to parameters
 - Read access 62
 - Write access 62
- Access code 62
 - Incorrect input 62
- Adapters 25
- Adapting the diagnostic behavior 141
- Adapting the status signal 141
- Ambient temperature
 - Influence 176
- Ambient temperature range 23
- AMS Device Manager 75
 - Function 75
- Application 161
- Applicator 161
- Approvals 192

B

- Burst mode 79

C

- Cable entries
 - Technical data 174
- Cable entry
 - Degree of protection 48
- CE mark 10, 192
- Certificates 192
- Checklist
 - Post-connection check 49
 - Post-installation check 35
- Cleaning
 - Exterior cleaning 155
 - Interior cleaning 155
- Commissioning 81
 - Advanced settings 105
 - Configuring the measuring device 81
- Communication-specific data 77
- Compatibility 154
- Conductivity 177
- Connecting cable 36, 37
- Connecting the measuring device 39
- Connecting the signal cables 39
- Connecting the supply voltage cables 39
- Connection
 - see Electrical connection
- Connection examples, potential equalization 42, 43
- Connection preparations 39
- Connection tools 36
- Context menu
 - Calling up 58
 - Closing 58
 - Explanation 58
- Current consumption 173

D

- Declaration of Conformity 10
- Define access code 119, 120
- Degree of protection 48, 176
- Designated use 9
- Device components 14
- Device description files 77
- Device documentation
 - Supplementary documentation 8
- Device history 154
- Device locking, status 122
- Device name
 - Sensor 17
 - Transmitter 16
- Device repair 156
- Device revision 77
- Device type ID 77
- DeviceCare 75
 - Device description file 77
- Diagnostic behavior
 - Explanation 137
 - Symbols 137
- Diagnostic information
 - Design, description 137, 140
 - DeviceCare 140
 - FieldCare 140
 - Light emitting diodes 134
 - Local display 136
 - Overview 142
 - Remedial measures 142
 - Web browser 138
- Diagnostic list 147
- Diagnostic message 136
- Diagnostics
 - Symbols 136
- DIP switches
 - see Write protection switch
- Direct access 60
- Direct access code 55
- Disabling write protection 119
- Display
 - see Onsite display
- Display and operating module DKX001 189
- Display area
 - For operational display 53
 - In the navigation view 55
- Display values
 - For locking status 122
- Disposal 156
- Document
 - Function 6
 - Symbols 6
- Document function 6
- Down pipe 21
- Drinking water approval 192

- E**
- ECC 111
 - Editing view 56
 - Input screen 57
 - Using operating elements 57
 - Electrical connection
 - CommuBox FXA195 (USB) 70
 - Computer with Web browser (e.g. Internet Explorer) 70
 - Degree of protection 48
 - Field Communicator 475 70
 - Field Xpert SFX350/SFX370 70
 - Field Xpert SMT70 70
 - Measuring device 36
 - Operating tool (e.g. FieldCare, AMS Device Manager, SIMATIC PDM) 70
 - Operating tools
 - Via HART protocol 70
 - Via service interface (CDI-RJ45) 71
 - Via WLAN interface 72
 - VIATOR Bluetooth modem 70
 - Web server 71
 - WLAN interface 72
 - Electromagnetic compatibility 177
 - Electronics module 14
 - Enabling write protection 119
 - Enabling/disabling the keypad lock 63
 - Endress+Hauser services
 - Maintenance 155
 - Repair 156
 - Environment
 - Ambient temperature range 23
 - Mechanical load 177
 - Storage temperature 176
 - Vibration- and shock-resistance 176
 - Error messages
 - see Diagnostic messages
 - Event list 147
 - Event logbook 147
 - Ex approval 192
 - Extended order code
 - Sensor 17
 - Transmitter 16
 - Exterior cleaning 155
- F**
- Field Communicator
 - Function 76
 - Field Communicator 475 76
 - Field of application
 - Residual risks 10
 - Field Xpert
 - Function 73
 - Field Xpert SFX350 73
 - FieldCare 73
 - Device description file 77
 - Establishing a connection 74
 - Function 73
 - User interface 75
 - Filtering the event logbook 148
 - Firmware
 - Release date 77
 - Version 77
 - Firmware history 153
 - Fitted electrodes 187
 - Flow direction 22
 - Flow limit 178
 - Function check 81
 - Function range
 - Field Xpert 73
 - Function scope
 - AMS Device Manager 75
 - Field Communicator 76
 - Field Communicator 475 76
 - SIMATIC PDM 76
 - Functions
 - see Parameters
- G**
- Galvanic isolation 172
- H**
- Hardware write protection 121
 - HART certification 192
 - HART input
 - Settings 99
 - HART protocol
 - Device variables 77
 - Measured values 77
 - Heavy sensors 22
 - Help text
 - Calling up 61
 - Closing 61
 - Explanation 61
 - HistoROM 113
- I**
- Identifying the measuring device 15
 - Incoming acceptance 15
 - Influence
 - Ambient temperature 176
 - Inlet runs 23
 - Input 161
 - Inspection
 - Installation 35
 - Received goods 15
 - Inspection check
 - Connection 49
 - Installation 21
 - Installation conditions
 - Adapters 25
 - Down pipe 21
 - Heavy sensors 22
 - Inlet and outlet runs 23
 - Installation dimensions 23
 - Mounting location 21
 - Orientation 22
 - Partially filled pipe 22

- System pressure 24
 - Thermal insulation 24
 - Vibrations 24
 - Installation dimensions 23
 - Interior cleaning 155
- L**
- Languages, operation options 188
 - Line recorder 128
 - Local display 188
 - Navigation view 54
 - see Diagnostic message
 - see In alarm condition
 - see Operational display
 - Low flow cut off 172
- M**
- Main electronics module 14
 - Maintenance tasks 155
 - Replacing seals 155
 - Managing the device configuration 113
 - Manufacturer ID 77
 - Manufacturing date 16, 17
 - Materials 185
 - Maximum measured error 174
 - Measured values
 - Calculated 161
 - Measured 161
 - see Process variables
 - Measuring and test equipment 155
 - Measuring device
 - Configuration 81
 - Conversion 156
 - Disposal 157
 - Integrating via communication protocol 77
 - Mounting the sensor 26
 - Mounting the ground cable/ground disks 27
 - Mounting the seals 27
 - Screw tightening torques 27
 - Screw tightening torques, maximum 27
 - Screw tightening torques, nominal 32
 - Preparing for electrical connection 39
 - Preparing for mounting 26
 - Removing 156
 - Repairs 156
 - Structure 14
 - Switch-on 81
 - Measuring principle 161
 - Measuring range 161
 - Measuring system 161
 - Measuring tube specification 183
 - Mechanical load 177
 - Medium temperature range 177
 - Menu
 - Diagnostics 146
 - Setup 83
 - Menus
 - For measuring device configuration 81
 - For specific settings 105
 - Mounting dimensions
 - see Installation dimensions
 - Mounting location 21
 - Mounting preparations 26
 - Mounting tools 26
- N**
- Nameplate
 - Sensor 17
 - Transmitter 16
 - Navigation path (navigation view) 54
 - Navigation view
 - In the submenu 54
 - In the wizard 54
 - Numeric editor 56
- O**
- Onsite display
 - Numeric editor 56
 - Text editor 56
 - Operable flow range 165
 - Operating elements 58, 137
 - Operating keys
 - see Operating elements
 - Operating menu
 - Menus, submenus 51
 - Structure 51
 - Submenus and user roles 52
 - Operating philosophy 52
 - Operation 122
 - Operation options 50
 - Operational display 53
 - Operational safety 10
 - Order code 16, 17
 - Orientation (vertical, horizontal) 22
 - Outlet runs 23
 - Output 167
 - Output signal 167
- P**
- Packaging disposal 20
 - Parameter
 - Changing 61
 - Entering values or text 61
 - Parameter settings
 - Administration (Submenu) 116
 - Advanced setup (Submenu) 106
 - Burst configuration 1 to n (Submenu) 79
 - Configuration (Submenu) 100
 - Configuration backup (Submenu) 113
 - Current input 86
 - Current input (Wizard) 86
 - Current input 1 to n (Submenu) 124
 - Current output 87
 - Current output (Wizard) 87
 - Data logging (Submenu) 128
 - Define access code (Wizard) 115
 - Device information (Submenu) 150
 - Diagnostics (Menu) 146

- Display (Submenu) 108
 - Display (Wizard) 96
 - Double pulse output 103
 - Double pulse output (Submenu) 103, 127
 - Electrode cleaning circuit (Submenu) 111
 - Empty pipe detection (Wizard) 99
 - I/O configuration 84
 - I/O configuration (Submenu) 84
 - Input (Submenu) 101
 - Low flow cut off (Wizard) 97
 - Process variables (Submenu) 122
 - Pulse/frequency/switch output 90
 - Pulse/frequency/switch output (Wizard) 90, 91, 94
 - Pulse/frequency/switch output 1 to n (Submenu) 126
 - Relay output 101
 - Relay output 1 to n (Submenu) 126
 - Relay output 1 to n (Wizard) 101
 - Reset access code (Submenu) 116
 - Sensor adjustment (Submenu) 106
 - Setup (Menu) 83
 - Simulation (Submenu) 116
 - Status input 85
 - Status input (Submenu) 85
 - Status input 1 to n (Submenu) 124
 - System units (Submenu) 83
 - Totalizer (Submenu) 123
 - Totalizer 1 to n (Submenu) 106
 - Totalizer handling (Submenu) 127
 - Value current output 1 to n (Submenu) 125
 - Web server (Submenu) 69
 - WLAN settings (Wizard) 112
 - Partially filled pipe 22
 - Performance characteristics 174
 - Post-connection check (checklist) 49
 - Post-installation check 81
 - Post-installation check (checklist) 35
 - Potential equalization 42
 - Power consumption 173
 - Power supply failure 173
 - Pressure loss 178
 - Pressure tightness 177
 - Pressure-temperature ratings 177
 - Process conditions
 - Conductivity 177
 - Flow limit 178
 - Medium temperature 177
 - Pressure loss 178
 - Pressure tightness 177
 - Process connections 187
 - Product safety 10
 - Protecting parameter settings 119
- R**
- Radio approval 193
 - RCM-tick symbol 192
 - Read access 62
 - Reading measured values 122
 - Recalibration 155
 - Reference operating conditions 174
 - Registered trademarks 8
 - Remedial measures
 - Calling up 138
 - Closing 138
 - Remote operation 189
 - Repair 156
 - Repair of a device 156
 - Repairs
 - Notes 156
 - Repeatability 175
 - Replacement
 - Device components 156
 - Replacing seals 155
 - Requirements for personnel 9
 - Return 156
- S**
- Safety 9
 - Screw tightening torques 27
 - Maximum 27
 - Nominal 32
 - Sensor
 - Mounting 26
 - Serial number 16, 17
 - Setting the operating language 81
 - Settings
 - Adapting the measuring device to the process conditions 127
 - Administration 115
 - Advanced display configurations 108
 - Current input 86
 - Current output 87
 - Device reset 150
 - Double pulse output 103
 - Electrode cleaning circuit (ECC) 111
 - Empty pipe detection (EPD) 99
 - HART input 99
 - I/O configuration 84
 - Local display 96
 - Low flow cut off 97
 - Managing the device configuration 113
 - Operating language 81
 - Pulse output 90
 - Pulse/frequency/switch output 90, 91
 - Relay output 101
 - Resetting the totalizer 127
 - Sensor adjustment 106
 - Simulation 116
 - Status input 85
 - Switch output 94
 - System units 83
 - Tag name 83
 - Totalizer 106
 - Totalizer reset 127
 - WLAN 112
 - Showing data logging 128
 - Signal on alarm 171
 - SIMATIC PDM 76
 - Function 76

- Software release 77
 - Spare part 156
 - Spare parts 156
 - Special connection instructions 44
 - Standards and guidelines 193
 - Status area
 - For operational display 53
 - In the navigation view 55
 - Status signals 136, 139
 - Storage concept 191
 - Storage conditions 19
 - Storage temperature 19
 - Storage temperature range 176
 - Structure
 - Measuring device 14
 - Operating menu 51
 - Submenu
 - Administration 115, 116
 - Advanced setup 105, 106
 - Burst configuration 1 to n 79
 - Configuration 100
 - Configuration backup 113
 - Current input 1 to n 124
 - Data logging 128
 - Device information 150
 - Display 108
 - Double pulse output 103, 127
 - Electrode cleaning circuit 111
 - Event list 147
 - HART input 99
 - I/O configuration 84
 - Input 101
 - Input values 124
 - Output values 125
 - Overview 52
 - Process variables 122
 - Pulse/frequency/switch output 1 to n 126
 - Relay output 1 to n 126
 - Reset access code 116
 - Sensor adjustment 106
 - Simulation 116
 - Status input 85
 - Status input 1 to n 124
 - System units 83
 - Totalizer 123
 - Totalizer 1 to n 106
 - Totalizer handling 127
 - Value current output 1 to n 125
 - Web server 69
 - Supplementary documentation 194
 - Supply voltage 173
 - Surface roughness 187
 - Switch output 170
 - Symbols
 - Controlling data entries 57
 - For communication 53
 - For diagnostic behavior 53
 - For locking 53
 - For measured variable 53
 - For measurement channel number 53
 - For menus 55
 - For parameters 55
 - For status signal 53
 - For submenu 55
 - For wizard 55
 - In the status area of the local display 53
 - Input screen 57
 - Operating elements 57
 - System design
 - Measuring system 161
 - see Measuring device design
 - System integration 77
 - System pressure 24
- T**
- Technical data, overview 161
 - Temperature range
 - Ambient temperature range for display 188
 - Storage temperature 19
 - Terminal assignment 39
 - terminals 173
 - Text editor 56
 - Thermal insulation 24
 - Tool tip
 - see Help text
 - Tools
 - Electrical connection 36
 - For mounting 26
 - Transport 19
 - Totalizer
 - Configuration 106
 - Transmitter
 - Turning the display module 34
 - Turning the housing 33
 - Transporting the measuring device 19
 - Troubleshooting
 - General 132
 - Turning the display module 34
 - Turning the electronics housing
 - see Turning the transmitter housing
 - Turning the transmitter housing 33
- U**
- Use of the measuring device
 - Borderline cases 9
 - Incorrect use 9
 - see Designated use
 - User interface
 - Current diagnostic event 146
 - Previous diagnostic event 146
 - User roles 52
- V**
- Version data for the device 77
 - Vibration- and shock-resistance 176
 - Vibrations 24
- W**
- W@M 155, 156

- W@M Device Viewer 15, 156
- Weight
 - Transport (notes) 19
- Wizard
 - Current input 86
 - Current output 87
 - Define access code 115
 - Display 96
 - Empty pipe detection 99
 - Low flow cut off 97
 - Pulse/frequency/switch output 90, 91, 94
 - Relay output 1 to n 101
 - WLAN settings 112
- WLAN settings 112
- Workplace safety 10
- Write access 62
- Write protection
 - Via access code 119
 - Via write protection switch 121
- Write protection switch 121

www.addresses.endress.com
