

Operating Instructions

CCS51D

Digital sensor with Memosens technology for determining free chlorine

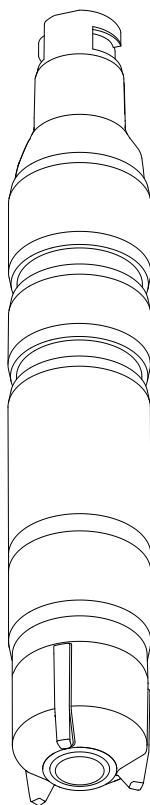





Table of contents







1	About this document	4	11	Accessories	43
1.1	Warnings	4	11.1	Maintenance kit CCV05	43
1.2	Symbols used	4	11.2	Device-specific accessories	43
2	Basic safety instructions	6	12	Technical data	45
2.1	Requirements for personnel	6	12.1	Input	45
2.2	Designated use	6	12.2	Performance characteristics	45
2.3	Occupational safety	6	12.3	Environment	46
2.4	Operational safety	7	12.4	Process	47
2.5	Product safety	7	12.5	Mechanical construction	48
3	Product description	8	13	Installation and operation in hazardous environment Class I Div. 2	49
3.1	Product design	8			
4	Incoming acceptance and product identification	14	Index		51
4.1	Incoming acceptance	14			
4.2	Product identification	14			
5	Installation	17			
5.1	Installation conditions	17			
5.2	Mounting the sensor	19			
5.3	Post-installation check	27			
6	Electrical connection	28			
6.1	Connecting the sensor	28			
6.2	Ensuring the degree of protection	28			
6.3	Post-connection check	29			
7	Commissioning	30			
7.1	Function check	30			
7.2	Sensor polarization	30			
7.3	Sensor calibration	30			
8	Diagnostics and troubleshooting	32			
9	Maintenance	34			
9.1	Maintenance schedule	34			
9.2	Maintenance tasks	35			
10	Repair	42			
10.1	Spare parts	42			
10.2	Return	42			
10.3	Disposal	42			

1 About this document



1.1 Warnings

Structure of information	Meaning
 <p>Causes (/consequences) If necessary, Consequences of non-compliance (if applicable) ▶ Corrective action</p>	<p>This symbol alerts you to a dangerous situation. Failure to avoid the dangerous situation will result in a fatal or serious injury.</p>
 <p>Causes (/consequences) If necessary, Consequences of non-compliance (if applicable) ▶ Corrective action</p>	<p>This symbol alerts you to a dangerous situation. Failure to avoid the dangerous situation can result in a fatal or serious injury.</p>
 <p>Causes (/consequences) If necessary, Consequences of non-compliance (if applicable) ▶ Corrective action</p>	<p>This symbol alerts you to a dangerous situation. Failure to avoid this situation can result in minor or more serious injuries.</p>
 <p>Cause/situation If necessary, Consequences of non-compliance (if applicable) ▶ Action/note</p>	<p>This symbol alerts you to situations which may result in damage to property.</p>

1.2 Symbols used

Symbol	Meaning
	Additional information, tips
	Permitted or recommended
	Not permitted or not recommended
	Reference to device documentation
	Reference to page
	Reference to graphic
	Result of a step

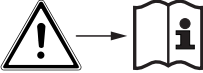
1.2.1 Symbols on the device

Symbol	Meaning
	Reference to device documentation
	Minimum immersion depth

2 Basic safety instructions

2.1 Requirements for personnel

Installation, commissioning, operation and maintenance of the measuring system may be carried out only by specially trained technical personnel.

- ▶ The technical personnel must be authorized by the plant operator to carry out the specified activities.
- ▶ The electrical connection may be performed only by an electrical technician.
- ▶ The technical personnel must have read and understood these Operating Instructions and must follow the instructions contained therein.
- ▶ Measuring point faults may be repaired only by authorized and specially trained personnel.



Repairs not described in the Operating Instructions provided must be carried out only directly at the manufacturer's site or by the service organization.

2.2 Designated use

Drinking water, process water and bathing water must be disinfected through the addition of appropriate disinfectants such as inorganic chlorine compounds. The dosing quantity must be adapted to continuously fluctuating operating conditions. Too low concentrations in the water could jeopardize the effectiveness of the disinfection. Too high concentrations can lead to signs of corrosion and have an adverse effect on the taste and smell, while also generating unnecessary costs.

The sensor was specifically developed for this application and is designed for continuous measurement of free chlorine in water. In conjunction with measuring and control equipment, it allows optimal control of disinfection.

Use of the device for any purpose other than that described, poses a threat to the safety of people and of the entire measuring system and is therefore not permitted.

The manufacturer is not liable for damage caused by improper or non-designated use.

2.2.1 Hazardous environment in accordance with cCSAus NI Cl. I, Div. 2¹⁾

- ▶ Pay attention to the control drawing and the specified application conditions in the appendix of these Operating Instructions, and follow the instructions.

2.3 Occupational safety

As the user, you are responsible for complying with the following safety conditions:

- Installation guidelines
- Local standards and regulations
- Regulations for explosion protection

1) Only if connected to CM44x(R)-CD*

Electromagnetic compatibility

- The product has been tested for electromagnetic compatibility in accordance with the applicable international standards for industrial applications.
- The electromagnetic compatibility indicated applies only to a product that has been connected in accordance with these Operating Instructions.

2.4 Operational safety

Before commissioning the entire measuring point:

1. Verify that all connections are correct.
2. Ensure that electrical cables and hose connections are undamaged.
3. Do not operate damaged products, and protect them against unintentional operation.
4. Label damaged products as defective.

During operation:

- ▶ If faults cannot be rectified:
products must be taken out of service and protected against unintentional operation.

2.4.1 Special instructions

- ▶ Do not operate the sensors under process conditions where it is expected that osmotic conditions will cause electrolyte components to pass through the membrane and into the process.

Use of the sensor for its intended purpose in liquids with a conductivity of at least 10 nS/cm can be classified as safe in terms of the application.

2.5 Product safety

The product is designed to meet state-of-the-art safety requirements, has been tested, and left the factory in a condition in which it is safe to operate. The relevant regulations and international standards have been observed.

3 Product description

3.1 Product design

The sensor consists of the following functional units:

- Membrane cap (measuring chamber with membrane)
 - Separates the inner amperometric system from the medium
 - With robust PVDF membrane and pressure relief valve
 - With special support grid between working electrode and membrane for a defined and consistent electrolyte film and thus a relatively constant indication even at varying pressures and flows
- Sensor shaft with
 - Large counter electrode
 - Working electrode embedded in plastic
 - Embedded temperature sensor

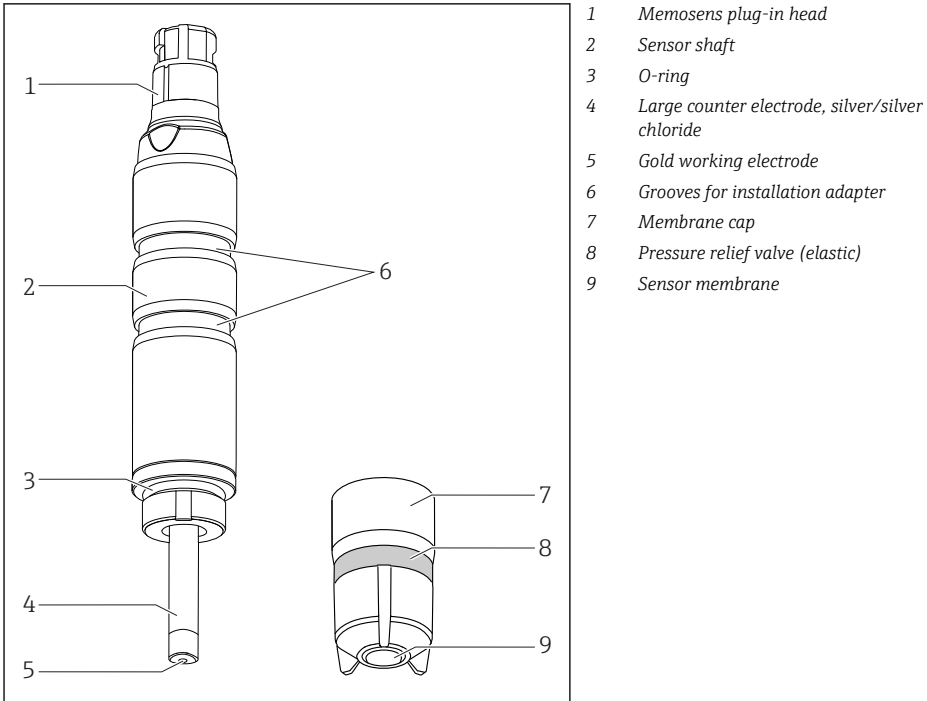

A0034227

1 Sensor structure

3.1.1 Measuring principle

Free chlorine is determined via hypochlorous acid (HOCl) according to the amperometric measuring principle.

The hypochlorous acid (HOCl) contained in the medium diffuses through the sensor membrane and is reduced to chloride ions (Cl^-) at the gold working electrode. At the silver counter electrode, silver is oxidized to silver chloride. Electron donation at the gold working electrode and electron acceptance at the silver counter electrode causes a current to flow which is proportional to the concentration of free chlorine in the medium at constant conditions.

The concentration of hypochlorous acid (HOCl) depends on the pH value. An additional pH measurement should be used to compensate for this dependency.

The transmitter uses the current signal in nA to calculate the measured variable for concentration in mg/l (ppm).

3.1.2 Effects on the measured signal

pH value

pH dependency

Molecular chlorine (Cl_2) is present at pH values < 4 . Consequently, hypochlorous acid (HOCl) and hypochlorite (OCl^-) remain as components of free chlorine within the range of pH 4 to 11. As hypochlorous acid splits up (dissociates) with an increasing pH value to form hypochlorite ions (OCl^-) and hydrogen ions (H^+), the amounts of the individual components of free effective chlorine change with the pH value. For example, if the proportion of hypochlorous acid is 97 % at pH 6, it drops to approx. 3 % at pH 9.

With amperometric measurement using the chlorine sensor, only the amount of hypochlorous acid (HOCl) is selectively measured. This works as a powerful disinfectant in an aqueous solution. Hypochlorite (OCl^-), however, is an extremely weak disinfectant. Therefore, when used as a disinfectant at higher pH values, the effectiveness of chlorine is limited. Since hypochlorite ions cannot diffuse through the sensor membrane, the sensor does not record this part.

pH value	Result
< 4	Chlorine is produced if chloride (Cl^-) is present in the medium at the same time causing an increase in the measured value.
4 to 9	pH compensation works perfectly in this range. A pH-compensated concentration value can be specified.
> 9	The measured signal is very weak in this range as the level of hypochlorous acid present is very low. The determined concentration value depends mainly on other conditions of the measuring point.

pH compensation of chlorine sensor signal

To calibrate and verify the chlorine measuring system, a colorimetric reference measurement must be carried out using the DPD method. Free chlorine reacts with diethyl-p-phenylendiamine to form a red dye. The intensity of the red color increases proportionally to the chlorine content. For the DPD test, the sample is buffered to a specified pH value. Therefore, the pH value of the sample is not taken into account in the DPD measurement. Due to the buffer function in the DPD method, all components of free effective chlorine (HOCl and OCl^-) are detected and thus the total free chlorine is measured.

The chlorine sensor only measures the hypochlorous acid. If you select pH compensation in the transmitter, the sum of hypochlorous acid and hypochlorite is calculated from the measured signal and the pH value. This value corresponds to the DPD measurement.

 When free chlorine is measured with pH compensation switched on, always perform calibration in pH-compensated mode.

When you use pH compensation, the measured chlorine value displayed and output by the device corresponds to the DPD value even if the pH value changes. If no pH compensation is used, the chlorine value of the DPD measurement corresponds only to the chlorine value of the sensor at the same pH value with respect to the calibration. Without pH compensation, the chlorine measuring system must be recalibrated when the pH value changes.

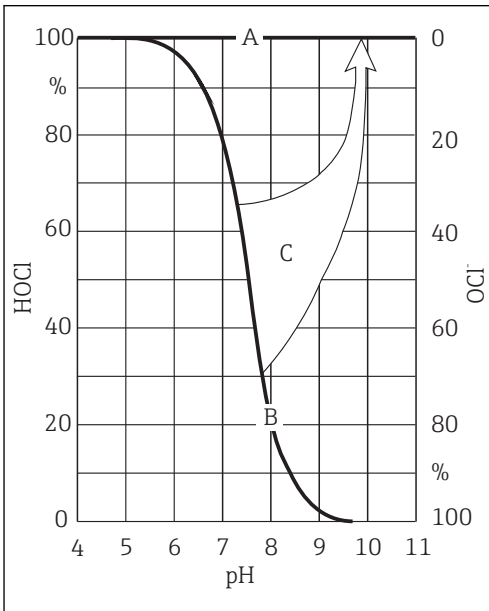

A0002017

2 Principle of pH compensation

- A Measured value with pH compensation
- B Measured value without pH compensation
- C pH compensation

Accuracy of pH compensation

The accuracy of the pH-compensated measured chlorine value is derived from the sum of several individual deviations (free chlorine, pH, temperature, DPD measurement etc.).

High levels of hypochlorous acid (HOCl) during chlorine calibration have a positive effect on accuracy, whereas low levels of hypochlorous acid have a negative effect. The inaccuracy of the pH-compensated measured chlorine value increases the greater the pH difference

between measuring mode and chlorine calibration or the more inaccurate the underlying individual measured values are.

Calibration taking into account the pH value

For the DPD test, the sample is buffered to a specified pH value. In contrast to this, amperometric measurement determines only the HOCl component.

During operation, pH compensation is effective up to a pH value of 9. However, there is virtually no hypochlorous acid (HOCl) left at this pH value, and the measured current is very low. pH compensation has the effect of increasing the measured HOCl value to the actual value of the free chlorine. Calibration of the entire measuring system is practicable only if the medium has a pH value of up to pH 8.

Above these pH values, the total error of the measuring system is unacceptably high.

Flow

The minimum flow velocity at the membrane-covered measuring cell is 15 cm/s (0.5 ft/s).

- When using the Flowfit CCA151 flow assembly, the minimum flow velocity corresponds to a volume flow of 5 l/h (1.3 gal/h). The pH value for compensation must be provided in another way.
- When using the CCA250 flow assembly, the minimum flow velocity corresponds to a volume flow of 30 l/h (7.9 gal/h) (upper edge of float at the height of the red bar mark).

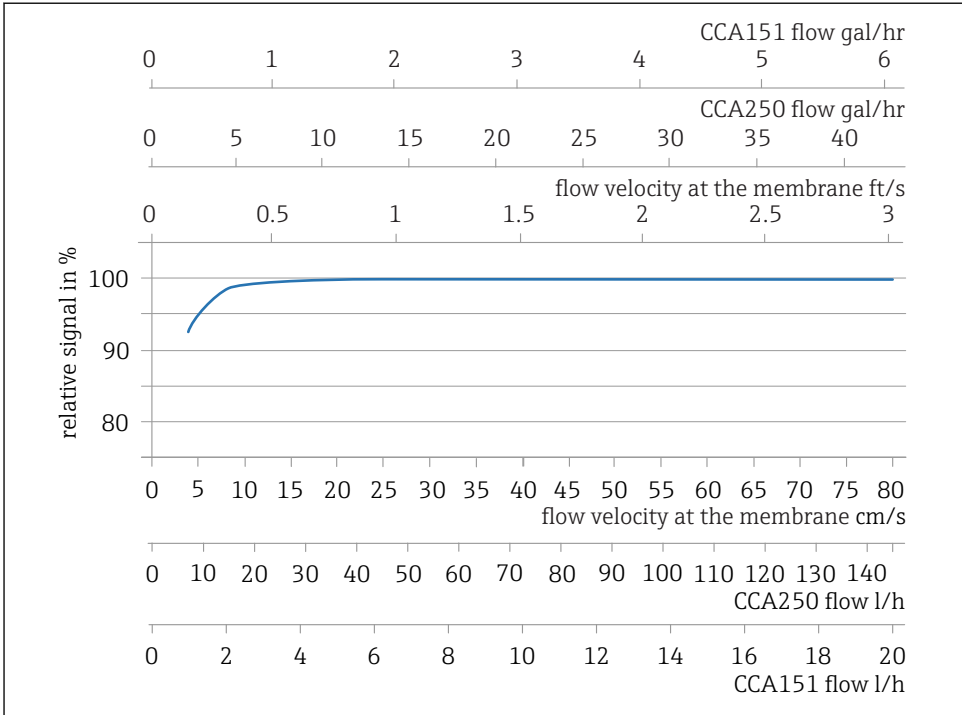

A0042802

3 Correlation between slope of electrode and flow velocity at the membrane/volume flow in assembly

At higher flow rates, the measured signal is virtually flow-independent. However, if the flow rate falls below the specified value, the measured signal depends on the flow.

The installation of an INS proximity switch in the assembly enables reliable detection of this invalid operating status, thus triggering an alarm or causing the dosing process to be switched off if necessary.

Below the minimum flow rate, the sensor current is more sensitive to flow fluctuations. For abrasive media, it is recommended not to exceed the minimum flow. If suspended solids are present, which may form deposits, the maximum flow rate is recommended.

Temperature

Changes in the temperature of the medium affect the measured value:

- Increases in temperature result in a higher measured value (approx. 4 % per K)
- Decreases in temperature result in a lower measured value.

Use of the sensor in combination with the Liquiline enables automatic temperature compensation (ATC). Recalibration in the case of temperature changes is not necessary.

1. If automatic temperature compensation is disabled at the transmitter, the temperature must be maintained at a constant level following calibration.
2. Otherwise, recalibrate the sensor.

In the event of normal and slow changes in temperature (0.3 K / minute), the internal temperature sensor is sufficient. In the event of very rapid temperature fluctuations with high amplitude (2 K / minute), an external temperature sensor is necessary to ensure maximum accuracy.



For detailed information on the use of external temperature sensors, see the Operating Instructions for the transmitter.

Cross-sensitivities ²⁾

There are cross-sensitivities for: chlorine dioxide, ozone, free bromine.

There are no cross-sensitivities for: H₂O₂, peracetic acid.

2) The listed substances have been tested with different concentrations. An additive effect has not been investigated.

4 Incoming acceptance and product identification

4.1 Incoming acceptance

1. Verify that the packaging is undamaged.
 - ↳ Notify the supplier of any damage to the packaging.
Keep the damaged packaging until the issue has been resolved.
2. Verify that the contents are undamaged.
 - ↳ Notify the supplier of any damage to the delivery contents.
Keep the damaged goods until the issue has been resolved.
3. Check that the delivery is complete and nothing is missing.
 - ↳ Compare the shipping documents with your order.
4. Pack the product for storage and transportation in such a way that it is protected against impact and moisture.
 - ↳ The original packaging offers the best protection.
Make sure to comply with the permitted ambient conditions.

If you have any questions, please contact your supplier or your local Sales Center.

4.2 Product identification

4.2.1 Nameplate

The nameplate provides you with the following information on your device:

- Manufacturer identification
- Extended order code
- Serial number
- Safety information and warnings
- Certificate information

► Compare the information on the nameplate with the order.

4.2.2 Product page

www.endress.com/ccs51d

4.2.3 Interpreting the order code

The order code and serial number of your product can be found in the following locations:

- On the nameplate
- In the delivery papers

Obtaining information on the product

1. Go to www.endress.com.
2. Call up the site search (magnifying glass).
3. Enter a valid serial number.

4. Search.

- ↳ The product structure is displayed in a popup window.

5. Click on the product image in the popup window.

- ↳ A new window (**Device Viewer**) opens. All of the information relating to your device is displayed in this window as well as the product documentation.

4.2.4 Manufacturer address

Endress+Hauser Conducta GmbH+Co. KG
Dieselstraße 24
D-70839 Gerlingen

4.2.5 Scope of delivery

The delivery comprises:

- Disinfection sensor (membrane-covered, Ø25 mm) with protection cap (ready for use)
- Bottle with electrolyte (50 ml (1.69 fl.oz))
- Replacement membrane cap in protection cap
- Operating Instructions
- Manufacturer inspection certificate

4.2.6 Certificates and approvals

Marine approvals

A selection of the devices and sensors have type approval for marine applications, issued by the following classification societies: ABS (American Bureau of Shipping), BV (Bureau Veritas), DNV-GL (Det Norske Veritas-Germanischer Lloyd) and LR (Lloyd's Register). Details of the order codes of the approved devices and sensors, and the installation and ambient conditions, are provided in the relevant certificates for marine applications on the product page on the Internet.

EAC

The product has been certified according to guidelines TP TC 004/2011 and TP TC 020/2011 which apply in the European Economic Area (EEA). The EAC conformity mark is affixed to the product.

Ex approvals³⁾

cCSAus NI Cl. I, Div. 2

This product complies with the requirements defined in:

- UL 61010-1
- ANSI/ISA 12.12.01
- FM 3600
- FM 3611

3) Only if connected to CM44x(R)-CD*

- CSA C22.2 NO. 61010-1-12
- CSA C22.2 NO. 213-16
- Control drawing: 401204

5 Installation

5.1 Installation conditions

5.1.1 Orientation

Do not install upside-down!

- ▶ Install the sensor in an assembly, support or appropriate process connection at an angle of at least 15° to the horizontal.
- ▶ Other angles of inclination are not permitted.
- ▶ Follow the instructions for installing the sensor in the Operating Instructions of the assembly used.

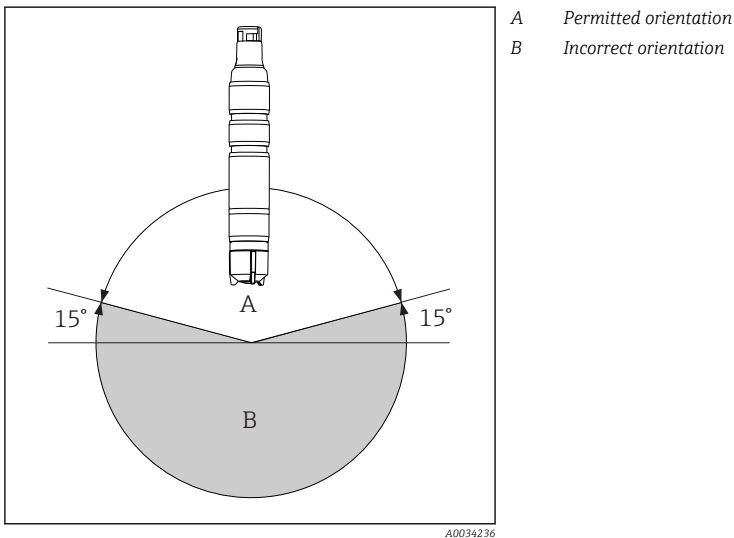

5.1.2 Immersion depth

50 mm (1.97 in)

5.1.3 Dimensions

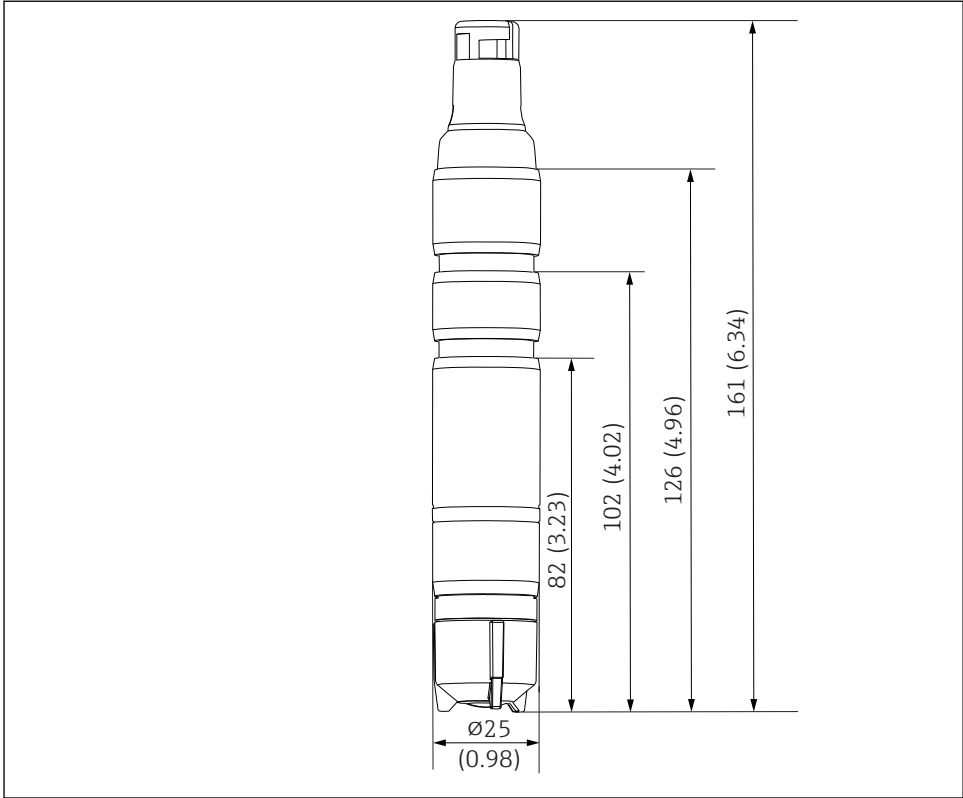

A0034238

4 Dimensions in mm (in)

5.2 Mounting the sensor

5.2.1 Measuring system

A complete measuring system comprises:

- Disinfection sensor CCS51D (membrane-covered, Ø25 mm) with corresponding installation adapter
- Flowfit CCA250 flow assembly
- Measuring cable CYK10, CYK20
- Transmitter, e.g. Liquiline CM44x with firmware version 01.07.03 or higher or CM44xR with firmware version 01.07.03 or higher
- Optional: pH sensor CPS31D
- Optional: extension cable CYK11
- Optional: proximity switch
- Optional: Flowfit CCA151 flow assembly (if the pH value is provided in another way)
- Optional: Flexdip CYA112

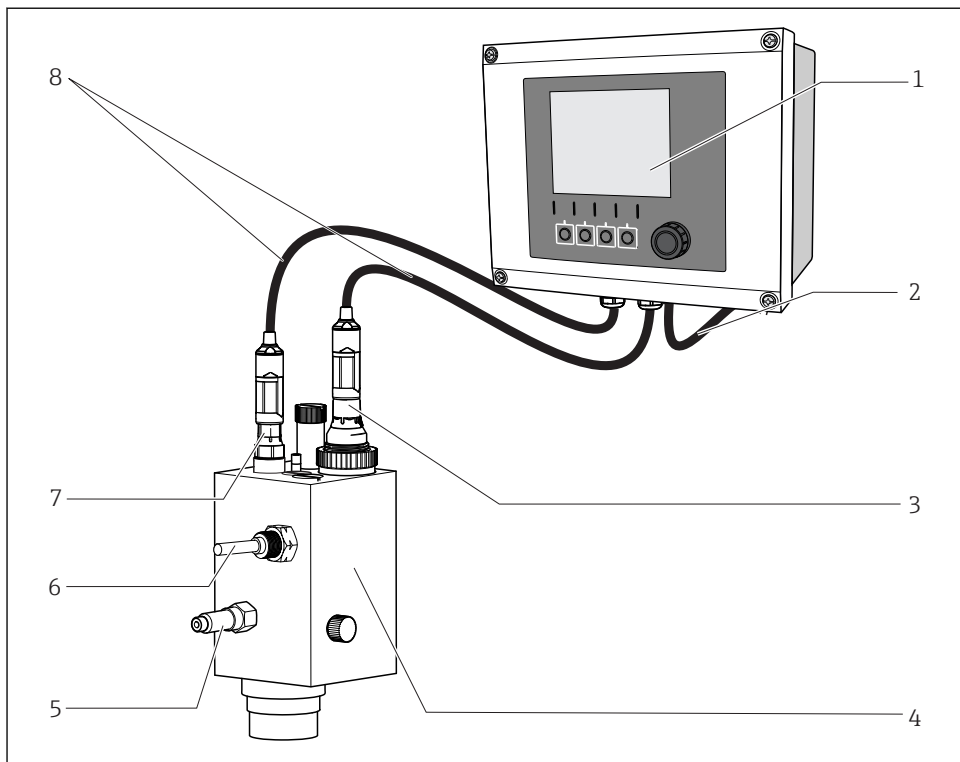

A0007341

5 Example of a measuring system

- 1 Liquiline CM44x transmitter
- 2 Power cable for transmitter
- 3 Disinfection sensor CCS51D (membrane-covered, $\varnothing 25$ mm)
- 4 Flowfit CCA250 flow assembly
- 5 Inlet to Flowfit CCA250 flow assembly
- 6 Proximity switch (optional)
- 7 CPS31D pH sensor
- 8 Measuring cable CYK10

5.2.2 Preparing the sensor

Removing protection cap from sensor

NOTICE

Negative pressure causes damage to the sensor's membrane cap

► If the protection cap is attached, carefully remove it from sensor.

1. When supplied to the customer and when in storage, the sensor is fitted with a protection cap: First release just the top part of the protection cap by turning it.

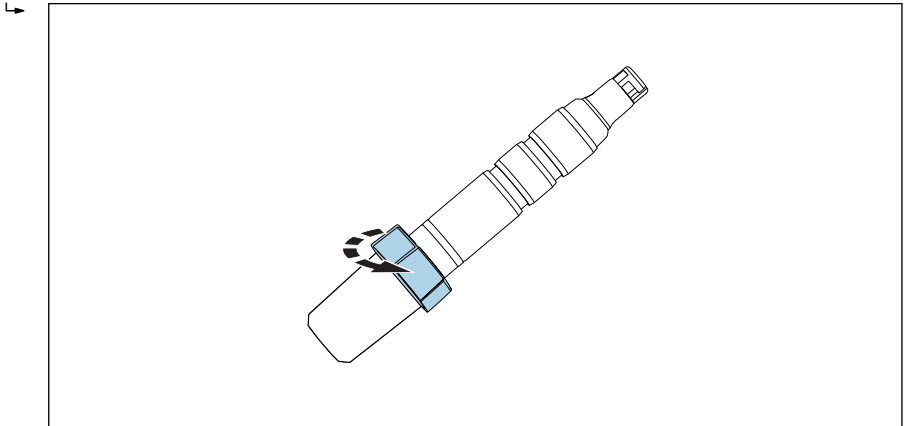

A0034263

 6 Releasing top part of protection cap by turning

2. Carefully remove protection cap from sensor.

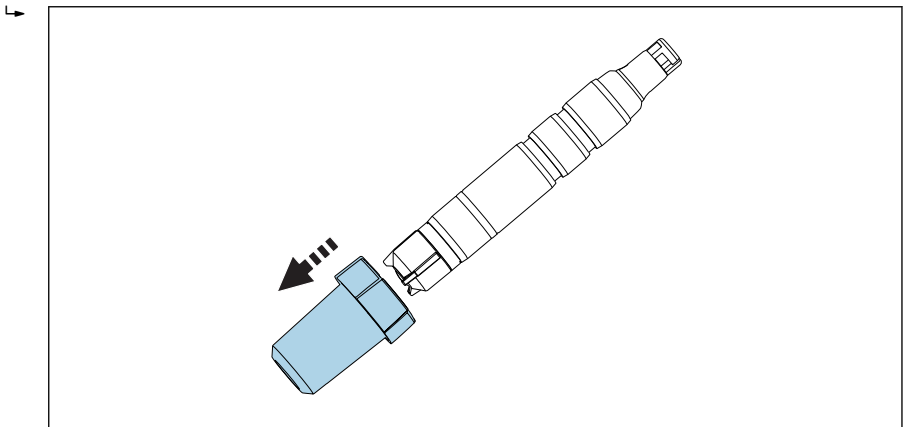

A0034350

 7 Carefully remove protection cap

5.2.3 Installing sensor in CCA151 assembly

- i** The disinfection sensor (membrane-covered, $\varnothing 25$ mm) is designed for installation in the Flowfit CCA151 flow assembly if the pH value for compensation is provided in another way.

Please note the following during installation:

- ▶ The volume flow must be at least 5 l/h (1.3 gal/h).
- ▶ If the medium is fed back into an overflow basin, pipe or similar, the resulting counterpressure on the sensor may not exceed 1 bar (14.5 psi) (2 bar abs. (29 psi abs.)) and must remain constant.
- ▶ Avoid negative pressure at the sensor, e.g. due to medium being returned to the suction side of a pump.
- ▶ To avoid buildup, heavily contaminated water should also be filtered.

Preparing the assembly

1. The assembly is supplied to the customer with a union nut screwed onto the assembly: unscrew union nut from assembly.

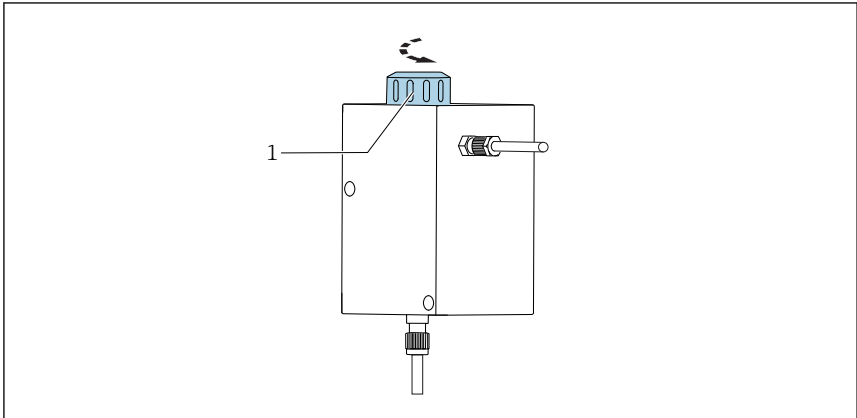

A0034262

8 Flowfit CCA151 flow assembly

1 Union nut

2. The assembly is supplied to the customer with a dummy plug inserted in the assembly: remove dummy plug from assembly.

Equipping sensor with adapter

The required adapter (clamping ring, thrust collar and O-ring) can be ordered as a mounted sensor accessory or as a separate accessory → 44.

1. First slide the clamping ring, then the thrust collar, and then the O-ring from the membrane cap towards the sensor head and into the lower groove.

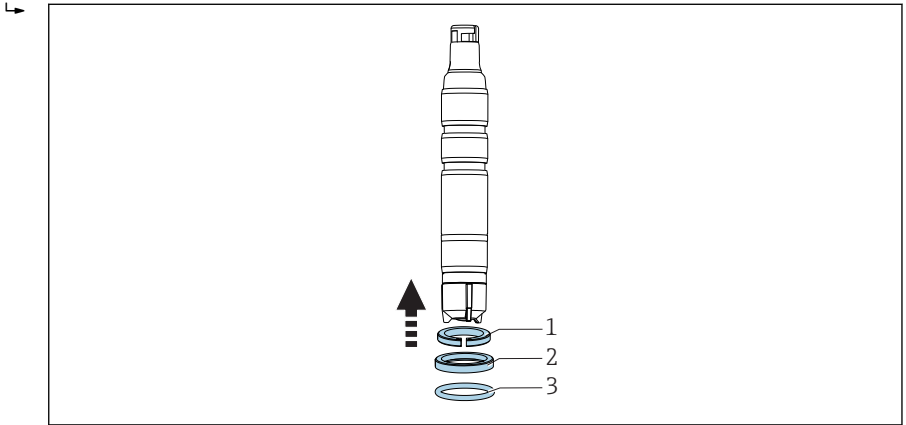

A0034247

- 9 Slide clamping ring (1), thrust collar (2) and O-ring (3) upwards from the membrane cap to the sensor shaft and into the lower groove.

Installing sensor in assembly

2. Slide sensor with adapter for Flowfit CCA151 into the opening in the assembly.

3. Screw union nut onto assembly on block.

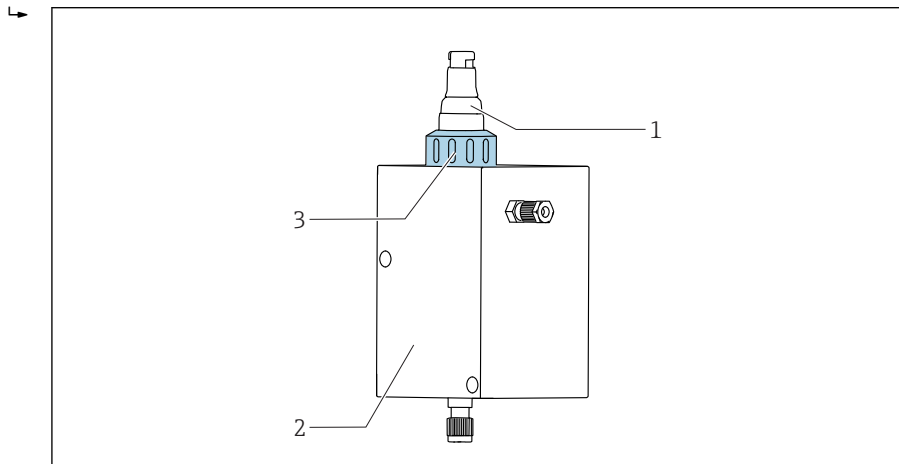

A0034261

10 Flowfit CCA151 flow assembly

- 1 Disinfection sensor
- 2 Flowfit CCA151 flow assembly
- 3 Union nut for securing a disinfection sensor

5.2.4 Installing sensor in CCA250 assembly

The sensor can be installed in the Flowfit CCA250 flow assembly. In addition to allowing the installation of a chlorine or chlorine dioxide sensor, this also allows the simultaneous operation of a pH and an ORP sensor for example. A needle valve controls the volume flow in the range of 30 to 120 l/h (7.9 to 31.7 gal/h).

Please note the following during installation:

- ▶ The volume flow must be at least 30 l/h (7.9 gal/h). If the flow drops below this value or stops completely, this can be detected by an inductive proximity switch and used to trigger an alarm with locking of the dosage pumps.
- ▶ If the medium is fed back into an overflow basin, pipe or similar, the resulting counterpressure on the sensor may not exceed 1 bar (14.5 psi) (2 bar abs. (29 psi abs.)) and must remain constant.
- ▶ Negative pressure at the sensor, e.g. due to medium being returned to the suction side of a pump, must be avoided.

Equipping sensor with adapter

The required adapter can be ordered as a mounted sensor accessory or as a separate accessory. →  44

1. Slide adapter for Flowfit CCA250 from the sensor head up to the stop on the sensor.

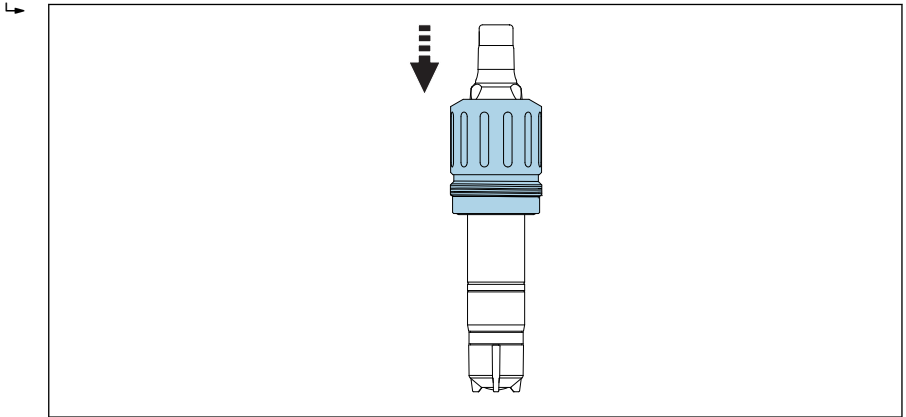

A0034245

 11 Slide on adapter for Flowfit CCA250.

2. Fix the adapter with the 2 stud screws supplied and an Allen screw (2 mm).

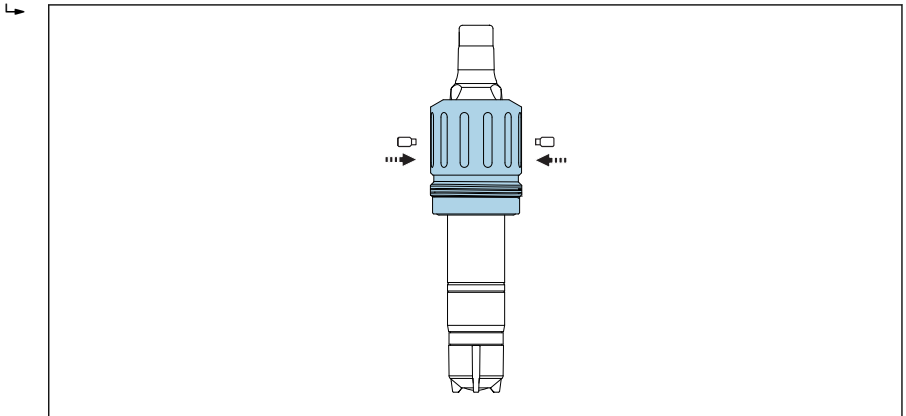

A0041320

3. Screw the sensor into the assembly.



For detailed information on "Installing sensor in Flowfit CCA250 assembly", see Operating Instructions for assembly

5.2.5 Installing sensor in other flow assemblies

When using other flow assemblies, please ensure the following:



- ▶ A flow velocity of at least 15 cm/s (0.49 ft/s) must always be ensured at the membrane.

- ▶ The flow direction is upwards. Transported air bubbles must be removed so that they do not collect in front of the membrane.
- ▶ The flow must be directed to the membrane.

 Pay attention to the additional installation instructions in the Operating Instructions for the assembly.

5.2.6 Installing sensor in immersion assembly CYA112

Alternatively, the sensor can be installed in an immersion assembly with a G1 threaded connection.

 Ensure sufficient flow towards the sensor when using the immersion assembly →  11.

Equipping sensor with adapter

The required adapter can be ordered as a mounted sensor accessory or as a separate accessory. →  44

1. Slide adapter for Flexdip CYA112 from the sensor head up to the stop on the sensor.

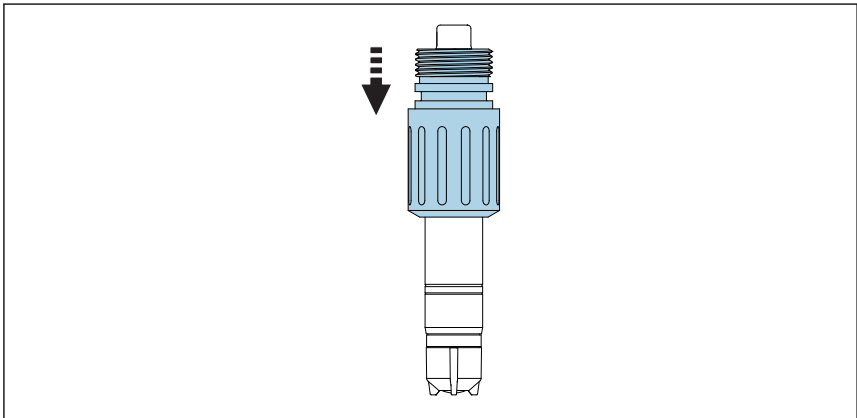

A0034246

-  12 Slide on adapter for Flexdip CYA112.

2. Fix the adapter with the 2 stud screws supplied and an Allen screw (2 mm).

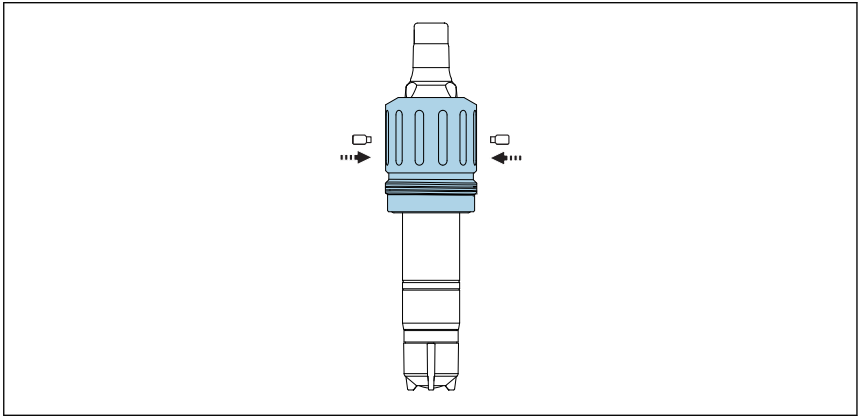

A0041320

3. Screw the sensor into the assembly. The use of a quick release fastener is recommended.



For detailed information on "Installing sensor in Flexdip CYA112 assembly", see Operating Instructions for assembly

5.3 Post-installation check

1. Is the adapter locked in place and unable to move freely?
2. Is the sensor installed in an assembly and not freely suspended from the cable?
 - ↳ Install the sensor in an assembly or directly via the process connection.
3. Is the membrane cap leak-tight?
 - ↳ Screw tight or replace.
4. Is the membrane intact and lying flat: Is the membrane bulging slightly (not flat)?
5. Is there electrolyte in the membrane cap?
 - ↳ If necessary, refill the membrane cap with electrolyte.

6 Electrical connection

⚠ CAUTION

Device is live

Incorrect connection may result in injury!

- ▶ The electrical connection may be performed only by an electrical technician.
- ▶ The electrical technician must have read and understood these Operating Instructions and must follow the instructions contained therein.
- ▶ **Prior** to commencing connection work, ensure that no voltage is present on any cable.

6.1 Connecting the sensor

The electrical connection to the transmitter is established using measuring cable CYK10 or CYK20.

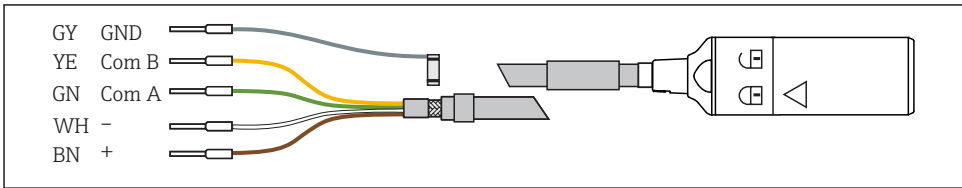

A0024019

13 Measuring cable CYK10 /CYK20

- ▶ To extend the cable, use measuring cable CYK11. The maximum cable length is 100 m (328 ft).

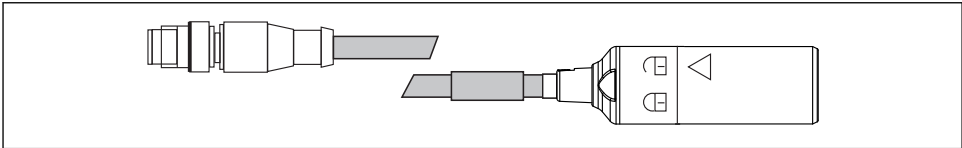

A0018861

14 Electrical connection, M12 plug

6.2 Ensuring the degree of protection

Only the mechanical and electrical connections which are described in these instructions and which are necessary for the required, designated use, may be carried out on the device delivered.

- ▶ Exercise care when carrying out the work.

Otherwise, the individual types of protection (Ingress Protection (IP), electrical safety, EMC interference immunity) agreed for this product can no longer be guaranteed due, for example to covers being left off or cable (ends) that are loose or insufficiently secured.

6.3 Post-connection check

Device condition and specifications	Notes
Are the sensor, assembly, or cables free from damage on the outside?	Visual inspection
Electrical connection	Notes
Are the mounted cables strain-relieved and not twisted?	
Is a sufficient length of the cable cores stripped, and are the cores positioned in the terminal correctly?	Check the fit (by pulling gently)
Are all the screw terminals properly tightened?	Tighten
Are all the cable entries installed, tightened and sealed?	For lateral cable entries, make sure the cables loop downwards to allow water to drip off
Are all cable entries installed downwards or mounted laterally?	

7 Commissioning

7.1 Function check

Prior to initial commissioning, ensure that:

- The sensor is correctly installed.
- The electrical connection is correct.
- There is sufficient electrolyte in the membrane cap and the transmitter is not displaying a warning about electrolyte depletion.



Please note the information on the safety data sheet to ensure safe use of the electrolyte.



Always keep the sensor moist after commissioning.

⚠ WARNING

Escaping process medium

Risk of injury from high pressure, high temperatures or chemical hazards

- ▶ Before applying pressure to an assembly with cleaning system, ensure that the system has been connected correctly.
- ▶ Do not install the assembly in the process if you cannot reliably establish the correct connection.

7.2 Sensor polarization

The voltage applied by the transmitter between the working electrode and counter electrode polarizes the surface of the working electrode. Therefore, after switching on the transmitter with the sensor connected, you must wait until the polarization period has elapsed before starting calibration.

To achieve a stable display value, the sensor requires the following polarization periods:

Initial commissioning	60 min
Recommissioning	30 min

7.3 Sensor calibration

Reference measurement according to the DPD method

To calibrate the measuring system, carry out a colorimetric comparison measurement in accordance with the DPD method. Chlorine reacts with diethyl-*p*-phenyldiamine (DPD) producing a red dye, the intensity of the red color being proportional to the chlorine content. Measure the intensity of the red color using a photometer (e. g. PF-3 →  43) . The photometer indicates the chlorine content.

Requirements

The sensor reading is stable (no drifts or unsteady values for at least 5 minutes). This is normally guaranteed once the following preconditions have been met:

- The polarization period has elapsed.
- The flow is constant and within the correct range.
- The sensor and the medium are at the same temperature.
- The pH value is within the permitted range.

Zero point adjustment

A zero point adjustment is not required due to the zero point stability of the membrane-covered sensor.

However, a zero point adjustment can be performed if desired.

1. To perform a zero point adjustment, operate the sensor for at least 15 min. in chlorine-free water, using the assembly or protection cap as a vessel.
2. Alternatively, perform the zero point adjustment using the zero point gel COY8 →  43.

Slope calibration



Always perform a slope calibration in the following cases:

- After replacing the membrane cap
- After replacing electrolyte

1. Ensure that the pH value and temperature of the medium are constant.
2. Take a representative sample for the DPD measurement. This must be done in close proximity to the sensor. Use the sampling tap if available.
3. Determine the chlorine content using the DPD method.
4. Enter the measured value into the transmitter (see Operating Instructions for transmitter).
5. To ensure greater accuracy, check the calibration several hours or 24 hours later using the DPD method.

8 Diagnostics and troubleshooting

When troubleshooting, the entire measuring point must be taken into account. This comprises:

- Transmitter
- Electrical connections and lines
- Assembly
- Sensor



The possible causes of error in the following table refer primarily to the sensor. Before commencing troubleshooting, ensure that the following operating conditions have been met:

- Measurement in "temperature-compensated" mode (can be configured on transmitter CM44x) or constant temperature following calibration
- Flow rate of at least 15 cm/s (0.5 ft/s) (when using the Flowfit CCA151 flow assembly)
- No organic chlorination agents are used



If the value measured by the sensor differs significantly from that of the DPD method, first consider all possible malfunctions of the photometric DPD method (see Operating Instructions for photometer). If necessary, repeat the DPD measurement several times.

Error	Possible cause	Remedy
No display, no sensor current	No supply voltage at the transmitter	▶ Establish mains connection
	Connection cable between sensor and transmitter interrupted	▶ Establish cable connection
	There is no electrolyte in the membrane cap	▶ Fill membrane cap
	No input flow of medium	▶ Establish flow, clean filter
Display value too high	Polarization of the sensor not yet completed	▶ Wait for polarization to be completed
	Membrane defective	▶ Replace membrane cap
	Shunt resistance (e.g. moisture contact) in the sensor shaft	▶ Remove membrane cap, rub working electrode dry. ▶ If the transmitter display does not return to zero, there is a shunt present: replace sensor.
	Foreign oxidants interfering with sensor	▶ Examine medium, check chemicals

Error	Possible cause	Remedy
Display value too low	Membrane cap not screwed on fully	<ul style="list-style-type: none"> ▶ Fill membrane cap with fresh electrolyte →  36 ▶ Screw membrane cap on fully
	Membrane soiled	▶ Clean membrane →  35
	Air bubble in front of membrane	▶ Release air bubble
	Air bubble between working electrode and membrane	<ul style="list-style-type: none"> ▶ Remove membrane cap, top up electrolyte ▶ Remove air bubble by tapping on the outside of the membrane cap ▶ Screw on membrane cap
	Input flow of medium too low	▶ Establish correct flow
	Foreign oxidants interfering with DPD reference measurement	▶ Examine medium, check chemicals
	Use of organic disinfectants	<ul style="list-style-type: none"> ▶ Use suitable agent (e.g. as per DIN 19643) (water may need to be replaced first) ▶ Use suitable reference system.
Display fluctuates considerably	Hole in membrane	▶ Replace membrane cap

9 Maintenance



Please note the information on the safety data sheet to ensure safe use of the electrolyte.

Take all the necessary precautions in time to ensure the operational safety and reliability of the entire measuring system.

NOTICE

Effects on process and process control!

- ▶ When carrying out any work on the system, bear in mind any potential impact this could have on the process control system and the process itself.
- ▶ For your own safety, only use genuine accessories. With genuine parts, the function, accuracy and reliability are also ensured after maintenance work.

9.1 Maintenance schedule

Interval	Maintenance work
If deposits are visible on the membrane (biofilm, limescale)	Clean sensor membrane → 36
If dirt is visible on the surface of the electrode body	Clean electrode body of sensor → 36
<ul style="list-style-type: none"> ▪ Slope depending on application: <ul style="list-style-type: none"> ▪ Every 12 months (at maximum) under constant conditions in the permitted range of 0 to 55 °C (32 to 131 °F) ▪ In the case of severe temperature fluctuations, e.g. from 10 °C (50 °F) to 25°C (77 °F) and back 100 times ▪ Zero point calibration: <ul style="list-style-type: none"> ▪ If operated in concentration range below 0.5 mg/l (ppm) ▪ If negative measured value is displayed with factory calibration 	Sensor calibration
<ul style="list-style-type: none"> ▪ If electrolyte counter warning is active ▪ If cap is replaced ▪ For determining the zero point ▪ If the slope is too low or too high relative to the nominal slope and the membrane cap is not visibly damaged or dirty 	Fill membrane cap with fresh electrolyte → 36
<ul style="list-style-type: none"> ▪ If there are grease/oil deposits (dark or transparent spots on the membrane) ▪ If slope is too high or too low or sensor current is very noisy ▪ If it is obvious that the sensor current is significantly dependent on the temperature (temperature compensation not working). 	Replace membrane cap → 37
If changes are visible on the working electrode or counter electrode (brown coating no longer present)	Regenerate sensor → 40

9.2 Maintenance tasks

9.2.1 Cleaning the sensor

CAUTION

Diluted hydrochloric acid

Hydrochloric acid causes irritation if it comes into contact with the skin or eyes.

- ▶ When using diluted hydrochloric acid, wear protective clothing such as gloves and goggles.
- ▶ Avoid splashes.

NOTICE

Chemicals that reduce surface tension (e.g. surfactants in cleaning agents or organic solvents such as alcohol that can be mixed with water)

Chemicals that reduce the surface tension cause the sensor membrane to lose its special property and protective function, which results in measured errors.

- ▶ Do not use any chemicals that reduce surface tension.

Removing the sensor from assembly CCA151

1. Remove the cable.
2. Unscrew the union nut from the assembly.

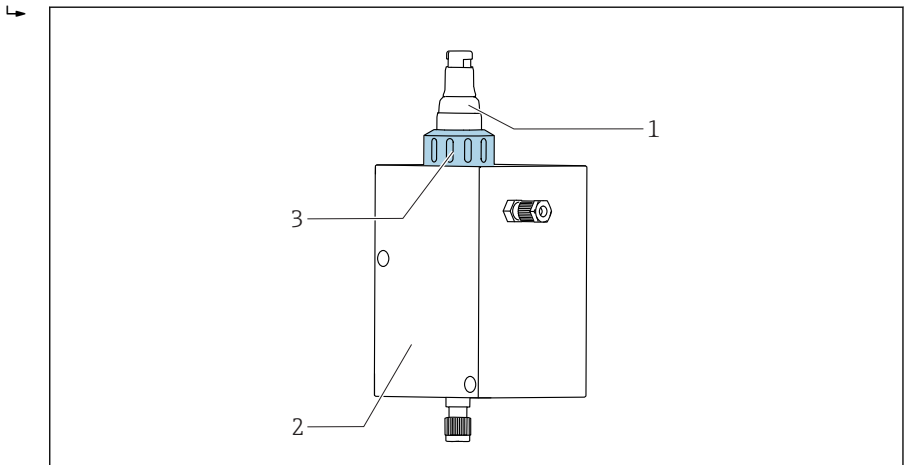

A0034261

- 1 Disinfection sensor CCS51D
- 2 Flowfit CCA151 flow assembly
- 3 Union nut for securing a disinfection sensor CCS51D

3. Pull sensor out through opening in assembly.

Removing the sensor from assembly CCA250

1. Remove the cable.

2. Unscrew the sensor, along with the adapter, from the assembly.

 The adapter does not need to be disassembled.

 For detailed information on "Removing sensor from assembly CCA250", see Operating Instructions for assembly.

Removing the sensor from assembly CYA112



1. Remove the cable.
2. Unscrew the sensor, along with the adapter, from the assembly.

 The adapter does not need to be disassembled.



 For detailed information on "Removing sensor from assembly CYA112", see Operating Instructions for assembly.

Cleaning the sensor membrane

If the membrane is visibly dirty, e.g. biofilm, proceed as follows:

1. Remove sensor from flow assembly →  35.
2. Remove membrane cap →  37.
3. Clean the membrane cap mechanically only using a gentle water jet. Alternatively, clean for several minutes in diluted acids or in specified cleaning agents without any further chemical additives.
4. Then rinse thoroughly with water.
5. Screw membrane cap back onto sensor →  37.

Cleaning the electrode body

1. Remove sensor from flow assembly →  35.
2. Remove membrane cap →  37.
3. Wipe gold electrode carefully using a soft sponge.
4. Rinse electrode body with demineralized water, alcohol or acid.
5. Screw membrane cap back onto sensor →  37.

9.2.2 Filling the membrane cap with fresh electrolyte



 Please note the information on the safety data sheet to ensure safe use of the electrolyte.

NOTICE**Damage to membrane and electrodes, air bubbles**



Possibility of measured errors to complete failure of the measuring point

- ▶ Avoid damage to membrane and electrodes.
- ▶ The electrolyte is chemically neutral and is not hazardous to health. Nonetheless, do not swallow it and avoid contact with eyes.
- ▶ Keep the electrolyte bottle closed after use. Do not transfer electrolyte to other vessels.
- ▶ Do not store electrolyte for longer than 2 years. The electrolyte must not be yellow in color. Observe the use-by date on the label.
- ▶ Avoid air bubbles when pouring electrolyte into membrane cap.

Filling the membrane cap with electrolyte

1. Remove membrane cap →  38.
2. Approx. 7 ml (0.24 fl.oz) Fill the membrane cap with electrolyte until it is level with the start of the internal thread.
3. Slowly screw on membrane cap up to the stop →  36. This will cause excess electrolyte to be displaced at the valve and thread.
4. If necessary, pat the sensor and membrane cap dry using a cloth.
5. Reset operating hours counter for electrolyte on transmitter. For detailed information, see Operating Instructions for transmitter.

9.2.3 Replacing the membrane cap

1. Remove sensor from flow assembly →  35.
2. Remove membrane cap →  38.
3. Pour fresh electrolyte into the new membrane cap until it is level with the start of the internal thread.
4. Check if the sealing ring is mounted in the membrane cap.
5. Screw new membrane cap onto sensor shaft →  39.
6. Screw on membrane cap until the membrane at the working electrode is slightly overstretched (1 mm (0.04 in)).
7. Reset operating hours counter for membrane cap on transmitter. For detailed information, see Operating Instructions for transmitter.

Removing the membrane cap

- ▶ Carefully rotate membrane cap and remove.

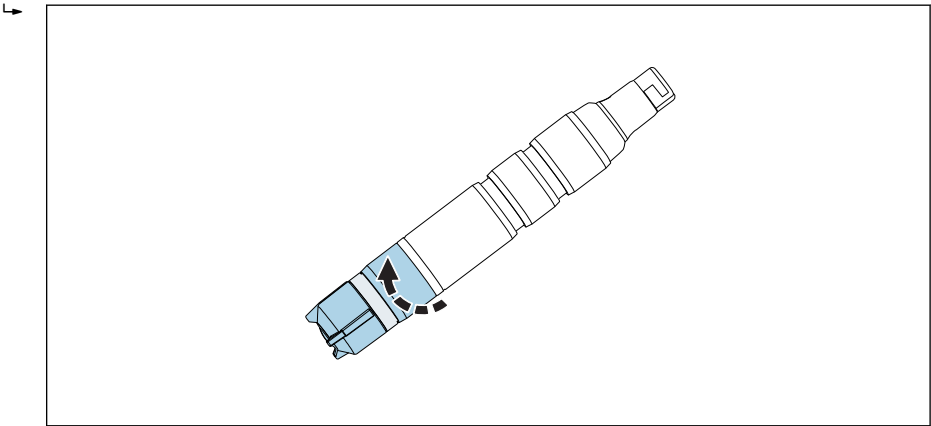

A0034406

15 Carefully rotate membrane cap.

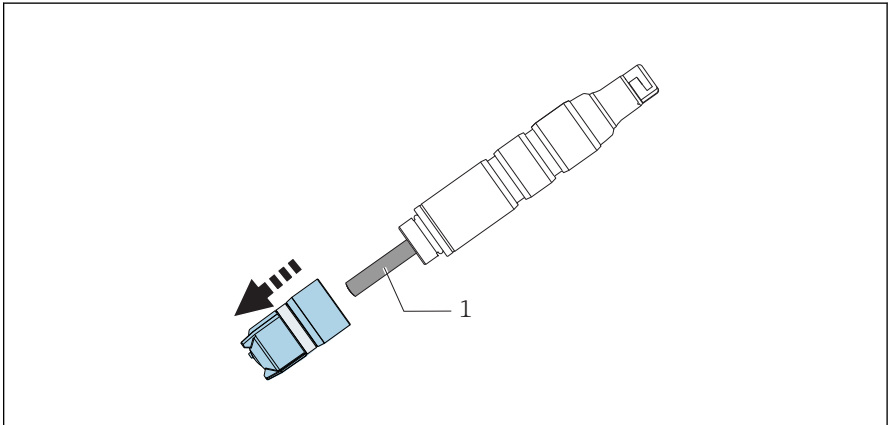

A0034406

16 Carefully remove membrane cap.

1 Electrode body

Screwing the membrane cap onto the sensor

- ▶ Screw membrane cap onto sensor shaft: hold sensor by the shaft. Keep valve clear.

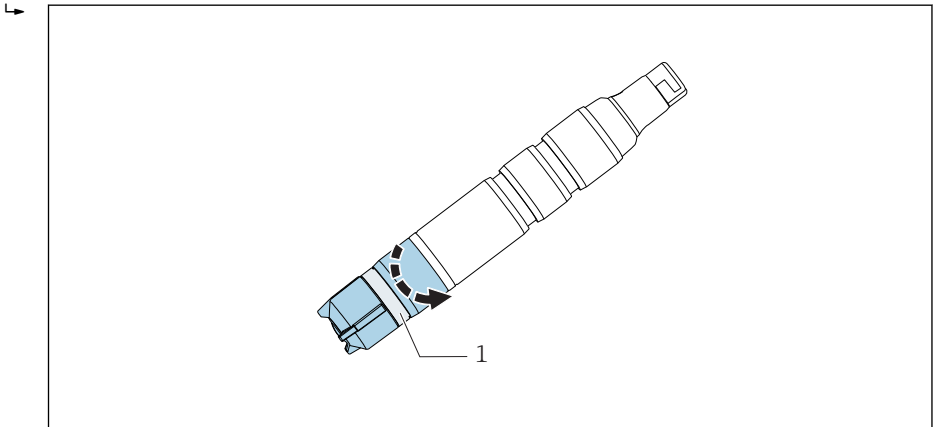

A0034480

☑ 17 Screw on membrane cap: keep pressure relief valve clear.

1 Pressure relief valve

9.2.4 Storing the sensor

If measurement is suspended for a short period of time and it can be guaranteed that the sensor will be kept moist while in storage:

1. If the assembly is guaranteed not to empty out, you may leave the sensor in the flow assembly.
2. If there is a possibility that the assembly may empty out, remove the sensor from assembly.
3. To keep the membrane moist after the sensor has been removed, refill the protection cap with electrolyte or clean water.
4. Fit protection cap on sensor → ☰ 40.

During longterm interruptions to measurement, particularly if dehydration is possible:

1. Remove sensor from assembly.
2. Clean sensor shaft and membrane cap with cold water and leave to dry.
3. Loosely screw on membrane cap up to the stop. This ensures that the membrane remains slack.
4. Pour electrolyte or clean water into protection cap and attach → ☰ 39.
5. For recommissioning, follow the same procedure as for commissioning → ☰ 30.



Ensure that no biofouling occurs during longer interruptions to measurement. Remove continuous organic deposits, such as films of bacteria.

Fitting the protection cap on the sensor

1. To keep the membrane moist after the sensor has been removed, fill the protection cap with some electrolyte or clean water.

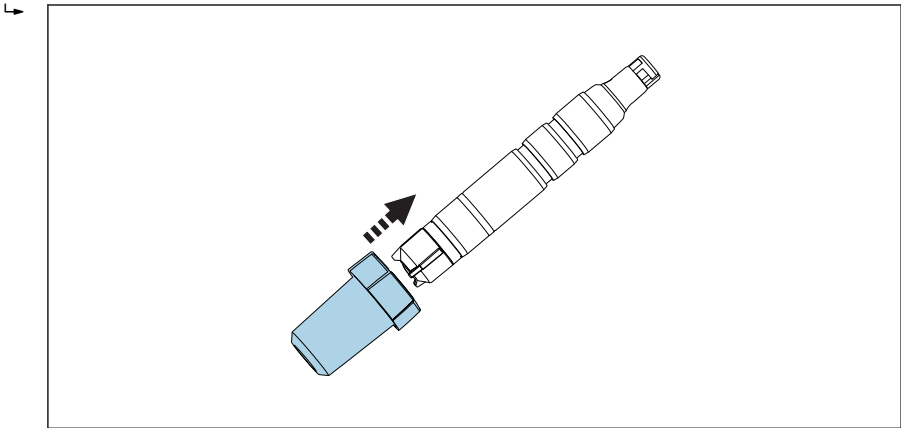

A0034264

- 18 Carefully slide protection cap onto the membrane cap.

2. Top part of protection cap is in the open position. Carefully slide protection cap onto the membrane cap.
3. Secure protection cap by rotating the top part of the protection cap.

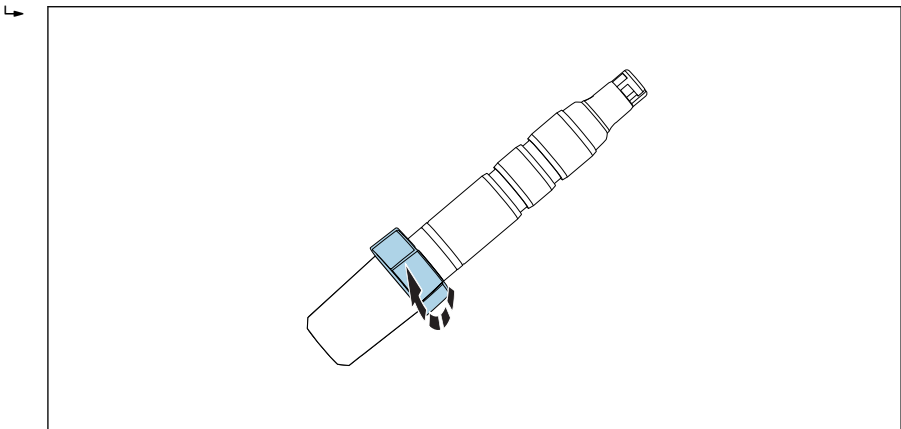

A0034494

- 19 Securing protection cap by rotating the top part

9.2.5 Regenerating the sensor

During measurement, the electrolyte in the sensor is gradually exhausted due to chemical reactions. The gray-brown silver chloride layer that is applied to the counter electrode at the factory continues to grow during sensor operation. However, this has no effect on the reaction taking place at the working electrode.

A change in the color of the silver chloride layer indicates an effect of the reaction that is taking place. Carry out a visual inspection to ensure that the gray-brown color of the counter electrode has not changed. If the color of the counter electrode has changed, e.g. if it is spotted, white or silvery, the sensor must be regenerated.

- ▶ Send the sensor to the manufacturer for regeneration.

10 Repair

10.1 Spare parts

For more detailed information on spare parts kits, please refer to the "Spare Part Finding Tool" on the Internet:

www.endress.com/spareparts_consumables

10.2 Return

The product must be returned if repairs or a factory calibration are required, or if the wrong product was ordered or delivered. As an ISO-certified company and also due to legal regulations, Endress+Hauser is obliged to follow certain procedures when handling any returned products that have been in contact with medium.

To ensure the swift, safe and professional return of the device:

- ▶ Refer to the website www.endress.com/support/return-material for information on the procedure and conditions for returning devices.

10.3 Disposal

The device contains electronic components. The product must be disposed of as electronic waste.

- ▶ Observe the local regulations.

11 Accessories

The following are the most important accessories available at the time this documentation was issued.

- ▶ For accessories not listed here, please contact your Service or Sales Center.

11.1 Maintenance kit CCV05

Order according to product structure

- 2 x membrane caps and 1 x electrolyte 50 ml (1.69 fl.oz)
- 1 x electrolyte 50 ml (1.69 fl.oz)
- 2 x sealing set

11.2 Device-specific accessories

Memosens data cable CYK10

- For digital sensors with Memosens technology
- Product Configurator on the product page: www.endress.com/cyk10



Technical Information TI00118C

Memosens data cable CYK11

- Extension cable for digital sensors with Memosens protocol
- Product Configurator on the product page: www.endress.com/cyk11



Technical Information TI00118C

Memosens laboratory cable CYK20

- For digital sensors with Memosens technology
- Product Configurator on the product page: www.endress.com/cyk20

Flowfit CCA250

- Flow assembly for disinfection and pH/ORP sensors
- Product Configurator on the product page: www.endress.com/cca250



Technical Information TI00062C

Flexdip CYA112

- Immersion assembly for water and wastewater
- Modular assembly system for sensors in open basins, channels and tanks
- Material: PVC or stainless steel
- Product Configurator on the product page: www.endress.com/cya112



Technical Information TI00432C

Photometer PF-3

- Compact hand-held photometer for determining the reference measured value
- Color-coded reagent bottles with clear dosing instructions
- Order No.: 71257946

Kit adapter CCS5xD for CCA151

- Clamping ring
- Thrust collar
- O-ring
- Order No. 71372027

Adapter kit CCS5x(D) for CCA250

- Adapter incl. O-rings
- 2 studs for locking in place
- Order No. 71372025

Adapter kit CCS5x(D) for CYA112

- Adapter incl. O-rings
- 2 studs for locking in place
- Order No. 71372026

COY8

Zero-point gel for oxygen and disinfection sensors

- Oxygen-free and chlorine-free gel for the verification, zero point calibration and adjustment of oxygen and disinfection measuring points
- Product Configurator on the product page: www.endress.com/coy8



Technical Information TI01244C

12 Technical data

12.1 Input

12.1.1 Measured values

Free chlorine (HOCl)	Hypochlorous acid (HOCl) [mg/l, µg/l, ppm, ppb]
Temperature	[°C, °F]

12.1.2 Measuring ranges

CCS51D-**11AD	0 to 5 mg/l (ppm) HOCl
CCS51D-**11BF	0 to 20 mg/l (ppm) HOCl
CCS51D-**11CJ	0 to 200 mg/l (ppm) HOCl

12.1.3 Signal current

CCS51D-**11AD	33 to 63 nA per 1 mg/l (ppm) HOCl
CCS51D-**11BF	9 to 18 nA per 1 mg/l (ppm) HOCl
CCS51D-**11CJ	9 to 18 nA per 1 mg/l (ppm) HOCl

12.2 Performance characteristics

12.2.1 Reference operating conditions

Temperature	20 °C (68 °F)
pH value	pH 5.5 ±0.2
Flow	40 to 60 cm/s
HOCl-free base medium	Mains water

12.2.2 Response time

$T_{90} < 25$ s (after completing polarization)

The T_{90} time can be longer under certain conditions. If the sensor is operated or stored in a chlorine-free medium for a longer period, the sensor response starts immediately if chlorine is present but only reaches the exact concentration value after a delay.

12.2.3 Measured value resolution of sensor

CCS51D-**11AD	0.03 µg/l (ppb) HOCl
CCS51D-**11BF	0.13 µg/l (ppb) HOCl
CCS51D-**11CJ	1.1 µg/l (ppb) HOCl

12.2.4 Maximum measured error

±2 % and ±5 µg/l (ppb) of value measured (depending on which value is higher)

	LOD (limit of detection) ¹⁾	LOQ (limit of quantification) ¹⁾
CCS51D-**11AD	0.002 mg/l (ppm)	0.005 mg/l (ppm)
CCS51D-**11BF	0.002 mg/l (ppm)	0.007 mg/l (ppm)
CCS51D-**11CJ	0.008 mg/l (ppm)	0.027 mg/l (ppm)

1) Based on ISO 15839. The measured error includes all the uncertainties of the sensor and transmitter (electrode system). It does not contain all the uncertainties caused by the reference material and adjustments that may have been performed.

12.2.5 Repeatability

CCS51D-**11AD	0.0031 mg/l (ppm)
CCS51D-**11BF	0.0035 mg/l (ppm)
CCS51D-**11CJ	0.062 mg/l (ppm)

12.2.6 Nominal slope

CCS51D-**11AD	48 nA per 1 mg/l (ppm) HOCl
CCS51D-**11BF	14 nA per 1 mg/l (ppm) HOCl
CCS51D-**11CJ	14 nA per 1 mg/l (ppm) HOCl

12.2.7 Long-term drift

< 1 % per month (mean value, determined while operating at varying concentrations and under reference conditions)

12.2.8 Polarization time

Initial commissioning	60 min
Recommissioning	30 min

12.2.9 Operating time of the electrolyte

at 10 % of measuring range and 20 °C	2 years
at 50 % of measuring range and 20 °C	1 year
at maximum concentration and 55 °C	60 days

12.3 Environment

12.3.1 Ambient temperature

-20 to 60 °C (-4 to 140 °F)

12.3.2 Storage temperature

	Long-term storage up to 2 years (maximum)	Storage up to 48 h (maximum)
With electrolyte	0 to 35 °C (32 to 95 °F) (non-freezing)	35 to 50 °C (95 to 122 °F)
Without electrolyte	-20 to 60 °C (-4 to 140 °F)	

12.3.3 Degree of protection

IP68 (1.8 m (5.91 ft)) water column over 7 days at 20 °C (68 °F)

12.4 Process

12.4.1 Process temperature

0 to 55 °C (32 to 130 °F), non-freezing

12.4.2 Process pressure

The inlet pressure depends on the specific fitting and installation.

The measurement can take place with a free outlet.

The sensor can be operated at process pressures up to 1 bar (14.5 psi) (2 bar abs. (29 psi abs.)).

- In terms of sensor condition and performance, it is essential that the flow velocity limits specified in the following table be observed.

	Flow velocity [cm/s]	Volume flow [l/h]		
		Flowfit CCA250	Flowfit CCA151	Flexdip CYA112
Minimum	15	30	5	The sensor is suspended freely in the medium; pay attention to the minimum flow velocity of 15 cm/s during installation.
Maximum	80	120	20	

12.4.3 pH range

Range of effectiveness of free chlorine pH 4 to 9¹⁾

Calibration pH 4 to 8

Measurement pH 4 to 9

1) Up to pH 4 and in the presence of chloride ions (Cl⁻), free chlorine is produced and included in the measurement

12.4.4 Flow

At least 5 l/h (1.3 gal/h), in the Flowfit CCA151 flow assembly

At least 30 l/h (7.9 gal/h), in the Flowfit CCA250 flow assembly

12.4.5 Flow

At least 15 cm/s (0.5 ft/s) , e.g. with Flexdip CYA112 immersion assembly

12.5 Mechanical construction

12.5.1 Dimensions

→  18

12.5.2 Weight

Sensor with membrane cap and electrolyte (without protection cap and without adapter)

Approx. 95 g (3.35 oz)

12.5.3 Materials

Sensor shaft	POM or PVC
Membrane	PVDF
Membrane cap	PVDF
Protection cap	<ul style="list-style-type: none"> ■ Vessel: PC Makrolon (polycarbonate) ■ Seal: Kraiburg TPE TM5MED ■ Cover: PC Makrolon (polycarbonate)
Sealing ring	FKM
Sensor shaft coupling	PPS

12.5.4 Cable specification

max. 100 m (330 ft), incl. Cable extension

13 Installation and operation in hazardous environment Class I Div. 2

Non-sparking device for use in specified hazardous environment in accordance with:

- cCSAus Class I Div. 2
- Gas group A, B, C, D
- Temperature class T6, $-5\text{ °C (23 °F)} < T_a < 55\text{ °C (131 °F)}$
- Control drawing: 401204

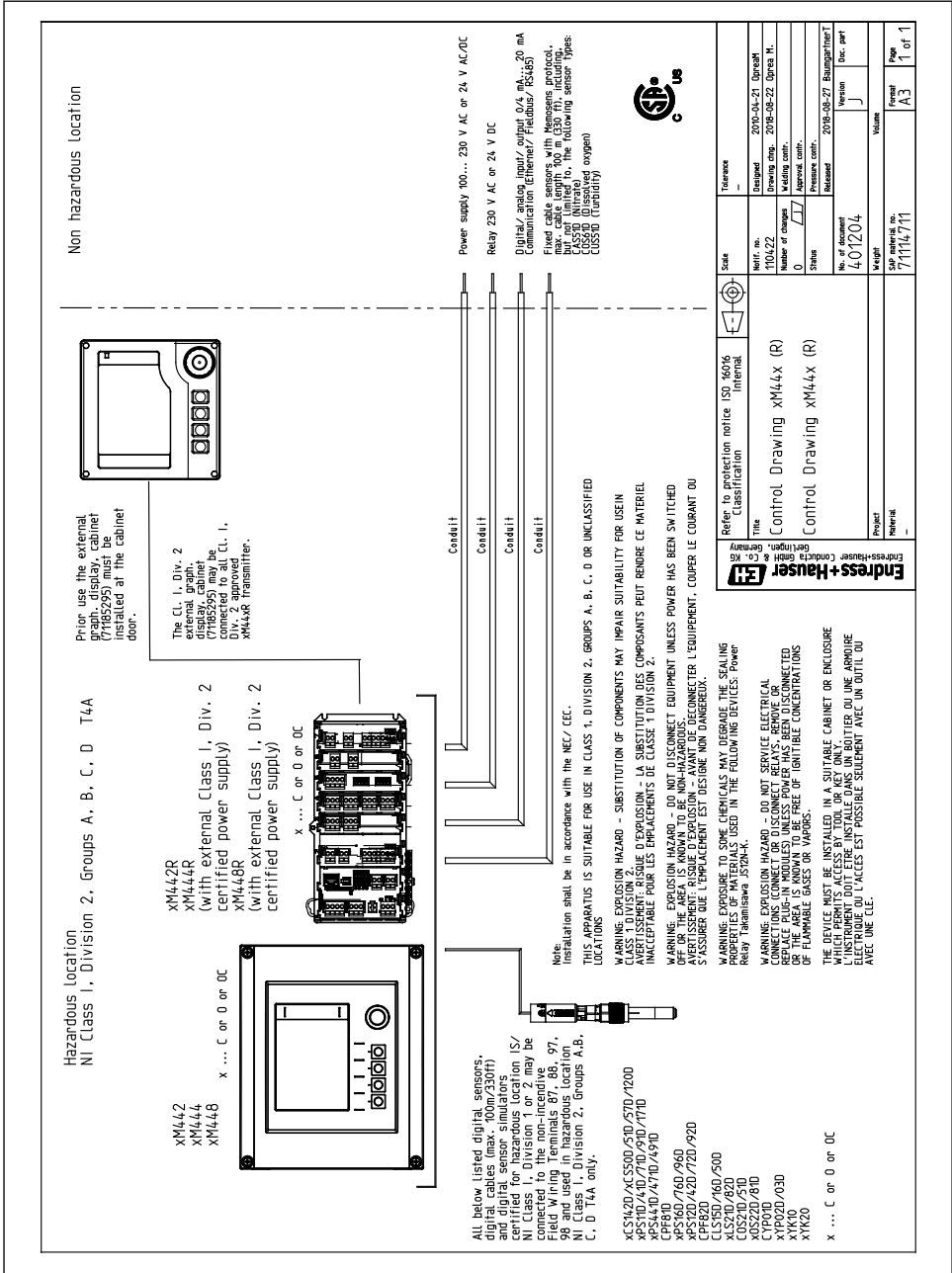

Index

A

Accessories	43
Ambient temperature	46
Approvals	
Marine	15

C

Cable specification	48
Check	
Connection	29
Function	30
Installation	27
Cleaning	35
Connection	
Check	29
Ensuring the degree of protection	28

D

Degree of protection	
Ensuring	28
Technical data	47
Designated use	6
Device description	8
Diagnostics	32
Disposal	42

E

Effect on the measured signal	
Flow	11
pH value	9
Temperature	12
Electrical connection	28
Environment	46
Ex approvals	15

F

Flow	11, 47, 48
Flow assembly	24, 25
Function check	30

I

Immersion assembly	26
Incoming acceptance	14
Installation	
Check	27

Flow assembly	24
Immersion assembly	26
Orientation	17
Sensor	19
Installation check	30

L

Long-term drift	46
---------------------------	----

M

Maintenance schedule	34
Maintenance tasks	35
Marine	15
Materials	48
Maximum measured error	46
Measured signal	9
Measured value resolution	45
Measured values	45
Measuring principle	8
Measuring ranges	45
Measuring system	19
Mounting instructions	17

N

Nameplate	14
Nominal slope	46

O

Operating principle	8
Operating time of the electrolyte	46
Orientation	17

P

Performance characteristics	45
pH range	47
pH value	9
Polarization time	46
Process	47
Process pressure	47
Process temperature	47

R

Reference operating conditions	45
Regeneration	40
Repair	42
Repeatability	46

Response time	45
Return	42

S

Safety instructions	6
Scope of delivery	15
Sensor	
Calibration	30
Cleaning	35
Connecting	28
Mounting	19
Polarization	30
Regenerating	40
Storage	39
Spare parts	42
Storage	39
Storage temperature	47
Symbols	4

T

Technical data	
Environment	46
Input	45
Mechanical construction	48
Performance characteristics	45
Process	47
Temperature	12
Troubleshooting	32

U

Use	6
---------------	---

W

Warnings	4
Weight	48



71484143

www.addresses.endress.com
