

# Brief Operating Instructions

## Flowmeter

### Proline 300

PROFIBUS DP transmitter  
with electromagnetic sensor

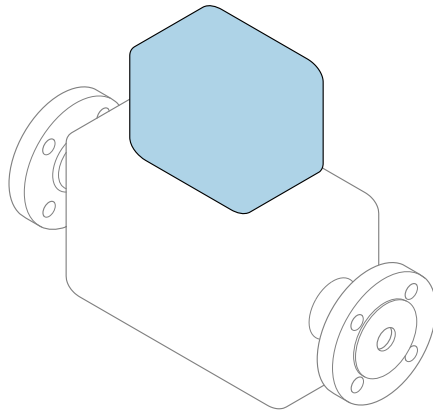

These instructions are Brief Operating Instructions; they are **not** a substitute for the Operating Instructions pertaining to the device.

**Brief Operating Instructions part 2 of 2: Transmitter**  
Contain information about the transmitter.

Brief Operating Instructions part 1 of 2: Sensor →  3



A0023555

## Brief Operating Instructions for the flowmeter

The device consists of a transmitter and a sensor.

The process of commissioning these two components is described in two separate manuals, that form the Brief Operating Instructions of the flowmeter:

- Brief Operating Instructions part 1: Sensor
- Brief Operating Instructions part 2: Transmitter

Please refer to both Brief Operating Instructions when commissioning the flowmeter as the contents complement one another:

### Brief Operating Instructions part 1: Sensor

The Sensor Brief Operating Instructions are aimed at specialists with responsibility for installing the measuring device.

- Incoming acceptance and product identification
- Storage and transport
- Installation

### Brief Operating Instructions part 2: Transmitter

The Transmitter Brief Operating Instructions are aimed at specialists with responsibility for commissioning, configuring and parameterizing the measuring device (until the first measured value).

- Product description
- Installation
- Electrical connection
- Operation options
- System integration
- Commissioning
- Diagnostic information

## Additional device documentation



These Brief Operating Instructions are the **Brief Operating Instructions part 2: Transmitter**.

The "Brief Operating Instructions part 1: Sensor" are available via:

- Internet: [www.endress.com/deviceviewer](http://www.endress.com/deviceviewer)
- Smart phone/tablet: *Endress+Hauser Operations App*

Detailed information about the device can be found in the Operating Instructions and the other documentation:

- Internet: [www.endress.com/deviceviewer](http://www.endress.com/deviceviewer)
- Smart phone/tablet: *Endress+Hauser Operations App*





# Table of contents

<b>1</b>	<b>About this document</b> .....	<b>5</b>
1.1	Symbols used .....	5
<b>2</b>	<b>Basic safety instructions</b> .....	<b>7</b>
2.1	Requirements for the personnel .....	7
2.2	Designated use .....	7
2.3	Workplace safety .....	8
2.4	Operational safety .....	8
2.5	Product safety .....	8
2.6	IT security .....	8
2.7	Device-specific IT security .....	9
<b>3</b>	<b>Product description</b> .....	<b>10</b>
<b>4</b>	<b>Installation</b> .....	<b>11</b>
4.1	Turning the transmitter housing .....	11
4.2	Turning the display module .....	12
4.3	Transmitter post-installation check .....	12
<b>5</b>	<b>Electrical connection</b> .....	<b>13</b>
5.1	Connection conditions .....	13
5.2	Connecting the measuring device .....	16
5.3	Ensuring potential equalization .....	20
5.4	Hardware settings .....	25
5.5	Ensuring the degree of protection .....	27
5.6	Post-connection check .....	27
<b>6</b>	<b>Operation options</b> .....	<b>28</b>
6.1	Overview of operation options .....	28
6.2	Structure and function of the operating menu .....	29
6.3	Access to the operating menu via the local display .....	30
6.4	Access to the operating menu via the operating tool .....	33
6.5	Access to the operating menu via the Web server .....	33
<b>7</b>	<b>System integration</b> .....	<b>33</b>
<b>8</b>	<b>Commissioning</b> .....	<b>34</b>
8.1	Function check .....	34
8.2	Setting the operating language .....	34
8.3	Configuring the measuring device .....	35
8.4	Protecting settings from unauthorized access .....	35
<b>9</b>	<b>Diagnostic information</b> .....	<b>36</b>











# 1 About this document

## 1.1 Symbols used





### 1.1.1 Safety symbols

Symbol	Meaning
	<b>DANGER!</b> This symbol alerts you to a dangerous situation. Failure to avoid this situation will result in serious or fatal injury.
	<b>WARNING!</b> This symbol alerts you to a dangerous situation. Failure to avoid this situation can result in serious or fatal injury.
	<b>CAUTION!</b> This symbol alerts you to a dangerous situation. Failure to avoid this situation can result in minor or medium injury.
	<b>NOTE!</b> This symbol contains information on procedures and other facts which do not result in personal injury.

### 1.1.2 Symbols for certain types of information





Symbol	Meaning	Symbol	Meaning
	<b>Permitted</b> Procedures, processes or actions that are permitted.		<b>Preferred</b> Procedures, processes or actions that are preferred.
	<b>Forbidden</b> Procedures, processes or actions that are forbidden.		<b>Tip</b> Indicates additional information.
	Reference to documentation		Reference to page
	Reference to graphic		Series of steps
	Result of a step		Visual inspection

### 1.1.3 Electrical symbols





Symbol	Meaning	Symbol	Meaning
	Direct current		Alternating current
	Direct current and alternating current		<b>Ground connection</b> A grounded terminal which, as far as the operator is concerned, is grounded via a grounding system.

Symbol	Meaning
	<p><b>Protective Earth (PE)</b>                      A terminal which must be connected to ground prior to establishing any other connections.</p> <p>The ground terminals are situated inside and outside the device:</p> <ul style="list-style-type: none"> <li>▪ Inner ground terminal: Connects the protective earth to the mains supply.</li> <li>▪ Outer ground terminal: Connects the device to the plant grounding system.</li> </ul>





### 1.1.4 Communication symbols

Symbol	Meaning	Symbol	Meaning
	<p><b>Wireless Local Area Network (WLAN)</b>                      Communication via a wireless, local network.</p>		<p><b>LED</b>                      Light emitting diode is off.</p>
	<p><b>LED</b>                      Light emitting diode is on.</p>		<p><b>LED</b>                      Light emitting diode is flashing.</p>

### 1.1.5 Tool symbols

Symbol	Meaning	Symbol	Meaning
	Torx screwdriver		Flat blade screwdriver
	Cross-head screwdriver		Allen key
	Open-ended wrench		

### 1.1.6 Symbols in graphics

Symbol	Meaning	Symbol	Meaning
1, 2, 3,...	Item numbers		Series of steps
A, B, C, ...	Views	A-A, B-B, C-C, ...	Sections
	Hazardous area		Safe area (non-hazardous area)
	Flow direction		

## 2 Basic safety instructions

### 2.1 Requirements for the personnel

The personnel must fulfill the following requirements for its tasks:

- ▶ Trained, qualified specialists must have a relevant qualification for this specific function and task.
- ▶ Are authorized by the plant owner/operator.
- ▶ Are familiar with federal/national regulations.
- ▶ Before starting work, read and understand the instructions in the manual and supplementary documentation as well as the certificates (depending on the application).
- ▶ Follow instructions and comply with basic conditions.

### 2.2 Designated use

#### Application and media

The measuring device described in these Brief Operating Instructions is intended only for flow measurement of liquids with a minimum conductivity of 5  $\mu\text{S}/\text{cm}$ .

Depending on the version ordered, the measuring device can also measure potentially explosive, flammable, poisonous and oxidizing media.

Measuring devices for use in hazardous areas, in hygienic applications or where there is an increased risk due to process pressure, are labeled accordingly on the nameplate.

To ensure that the measuring device remains in proper condition for the operation time:

- ▶ Keep within the specified pressure and temperature range.
- ▶ Only use the measuring device in full compliance with the data on the nameplate and the general conditions listed in the Operating Instructions and supplementary documentation.
- ▶ Based on the nameplate, check whether the ordered device is permitted for the intended use in the hazardous area (e.g. explosion protection, pressure vessel safety).
- ▶ Use the measuring device only for media to which the process-wetted materials are sufficiently resistant.
- ▶ If the ambient temperature of the measuring device is outside the atmospheric temperature, it is absolutely essential to comply with the relevant basic conditions as specified in the device documentation.
- ▶ Protect the measuring device permanently against corrosion from environmental influences.

#### Incorrect use

Non-designated use can compromise safety. The manufacturer is not liable for damage caused by improper or non-designated use.

#### WARNING

#### **Danger of breakage due to corrosive or abrasive fluids and ambient conditions!**

- ▶ Verify the compatibility of the process fluid with the sensor material.
- ▶ Ensure the resistance of all fluid-wetted materials in the process.
- ▶ Keep within the specified pressure and temperature range.

**NOTICE****Verification for borderline cases:**

- ▶ For special fluids and fluids for cleaning, Endress+Hauser is glad to provide assistance in verifying the corrosion resistance of fluid-wetted materials, but does not accept any warranty or liability as minute changes in the temperature, concentration or level of contamination in the process can alter the corrosion resistance properties.

**Residual risks****⚠ WARNING**

**The electronics and the medium may cause the surfaces to heat up. This presents a burn hazard!**

- ▶ For elevated fluid temperatures, ensure protection against contact to prevent burns.

## 2.3 Workplace safety

For work on and with the device:

- ▶ Wear the required personal protective equipment according to federal/national regulations.

For welding work on the piping:

- ▶ Do not ground the welding unit via the measuring device.

If working on and with the device with wet hands:

- ▶ Due to the increased risk of electric shock, gloves must be worn.

## 2.4 Operational safety

Risk of injury.

- ▶ Operate the device in proper technical condition and fail-safe condition only.
- ▶ The operator is responsible for interference-free operation of the device.

## 2.5 Product safety

This measuring device is designed in accordance with good engineering practice to meet state-of-the-art safety requirements, has been tested, and left the factory in a condition in which it is safe to operate.

It meets general safety standards and legal requirements. It also complies with the EU directives listed in the device-specific EU Declaration of Conformity. Endress+Hauser confirms this by affixing the CE mark to the device.

## 2.6 IT security

Our warranty is valid only if the device is installed and used as described in the Operating Instructions. The device is equipped with security mechanisms to protect it against any inadvertent changes to the settings.

IT security measures, which provide additional protection for the device and associated data transfer, must be implemented by the operators themselves in line with their security standards.



## 2.7 Device-specific IT security

The device offers a range of specific functions to support protective measures on the operator's side. These functions can be configured by the user and guarantee greater in-operation safety if used correctly.



For detailed information on device-specific IT security, see the Operating Instructions for the device.

### 2.7.1 Access via service interface (CDI-RJ45)

The device can be connected to a network via the service interface (CDI-RJ45). Device-specific functions guarantee the secure operation of the device in a network.

The use of relevant industrial standards and guidelines that have been defined by national and international safety committees, such as IEC/ISA62443 or the IEEE, is recommended. This includes organizational security measures such as the assignment of access authorization as well as technical measures such as network segmentation.

### 3 Product description

The device consists of a Proline 300 transmitter and an electromagnetic Proline Promag sensor.

The device is available as a compact version:

The transmitter and sensor form a mechanical unit.

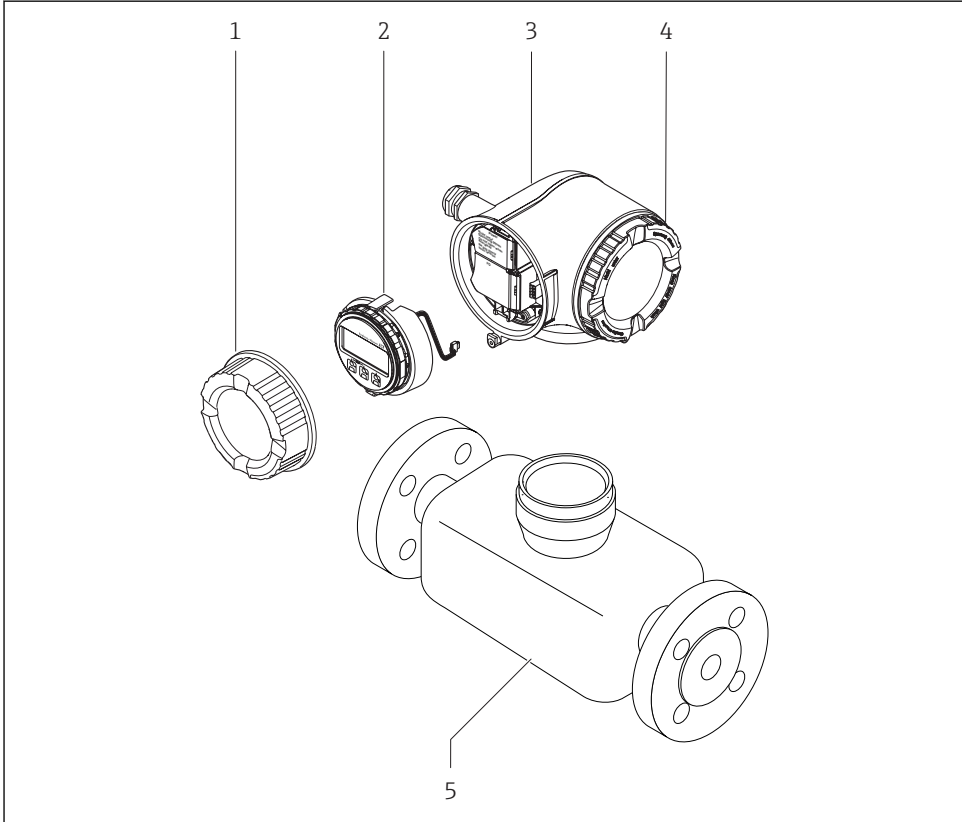

A0029586

- 1 Connection compartment cover
- 2 Display module
- 3 Transmitter housing
- 4 Electronics compartment cover
- 5 Sensor

 Use of the device with the remote display and operating module DKX001 →  20.

 For detailed information on the product description, see the Operating Instructions for the device

## 4 Installation



For detailed information about mounting the sensor, see the Sensor Brief Operating Instructions → 3

### 4.1 Turning the transmitter housing

To provide easier access to the connection compartment or display module, the transmitter housing can be turned.

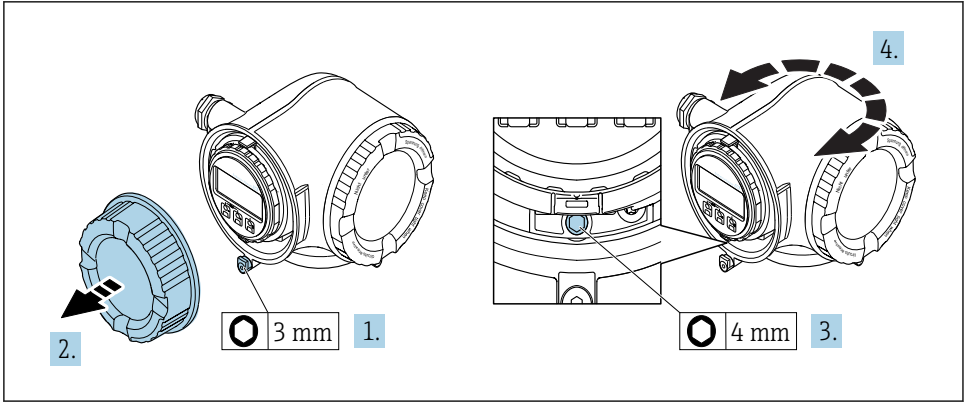

A0029993

1. Depending on the device version: Loosen the securing clamp of the connection compartment cover.
2. Unscrew the connection compartment cover.
3. Release the fixing screw.
4. Turn the housing to the desired position.
5. Firmly tighten the securing screw.
6. Screw on the connection compartment cover
7. Depending on the device version: Attach the securing clamp of the connection compartment cover.

## 4.2 Turning the display module

The display module can be turned to optimize display readability and operability.

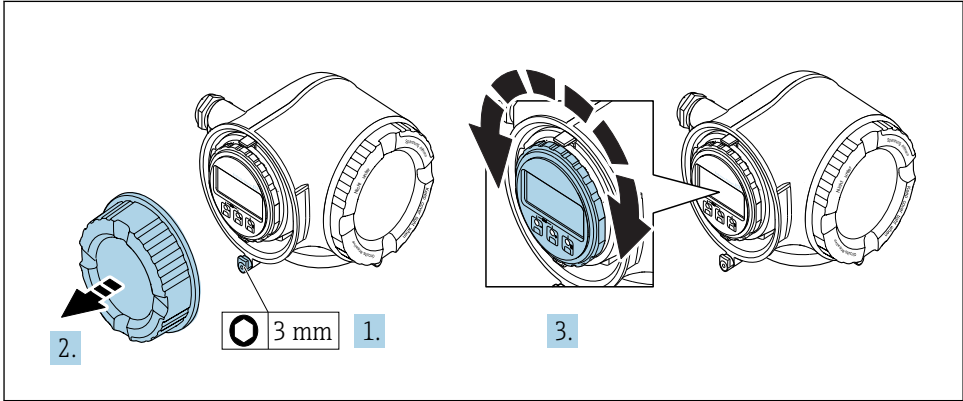

A0030035

1. Depending on the device version: Loosen the securing clamp of the connection compartment cover.
2. Unscrew the connection compartment cover.
3. Turn the display module to the desired position: max.  $8 \times 45^\circ$  in each direction.
4. Screw on the connection compartment cover.
5. Depending on the device version: Attach the securing clamp of the connection compartment cover.

## 4.3 Transmitter post-installation check

The post-installation check must always be performed after the following tasks:

- Turning the transmitter housing
- Turning the display module

Is the device undamaged (visual inspection)?	<input type="checkbox"/>
Turning the transmitter housing: <ul style="list-style-type: none"> <li>▪ Is the securing screw firmly tightened?</li> <li>▪ Is the connection compartment cover screwed on tightly?</li> <li>▪ Is the securing clamp firmly tightened?</li> </ul>	<input type="checkbox"/>
Turning the display module: <ul style="list-style-type: none"> <li>▪ Is the connection compartment cover screwed on tightly?</li> <li>▪ Is the securing clamp firmly tightened?</li> </ul>	<input type="checkbox"/>

## 5 Electrical connection

### NOTICE

**The measuring device does not have an internal circuit breaker.**

- ▶ For this reason, assign the measuring device a switch or power-circuit breaker so that the power supply line can be easily disconnected from the mains.
- ▶ Although the measuring device is equipped with a fuse, additional overcurrent protection (maximum 10 A) should be integrated into the system installation.

### 5.1 Connection conditions

#### 5.1.1 Required tools

- For cable entries: Use corresponding tools
- For securing clamp: Allen key 3 mm
- Wire stripper
- When using stranded cables: Crimper for wire end ferrule
- For removing cables from terminal: Flat blade screwdriver  $\leq 3$  mm (0.12 in)

#### 5.1.2 Connecting cable requirements

The connecting cables provided by the customer must fulfill the following requirements.

#### Electrical safety

In accordance with applicable federal/national regulations.

#### Protective ground cable

Cable  $\geq 2.08$  mm<sup>2</sup> (14 AWG)

The grounding impedance must be less than 1  $\Omega$ .

#### Permitted temperature range

- The installation guidelines that apply in the country of installation must be observed.
- The cables must be suitable for the minimum and maximum temperatures to be expected.

#### Power supply cable

Standard installation cable is sufficient.

#### Cable diameter

- Cable glands supplied:  
M20  $\times$  1.5 with cable  $\varnothing$  6 to 12 mm (0.24 to 0.47 in)
- Spring-loaded terminals: Suitable for strands and strands with ferrules.  
Conductor cross-section 0.2 to 2.5 mm<sup>2</sup> (24 to 12 AWG).

## Signal cable

### *PROFIBUS DP*

The IEC 61158 standard specifies two types of cable (A and B) for the bus line which can be used for every transmission rate. Cable type A is recommended.

 For detailed information about the specification of the connecting cable, see the Operating Instructions for the device.

 For further information on planning and installing PROFIBUS networks see: Operating Instructions "PROFIBUS DP/PA: Guidelines for planning and commissioning" (BA00034S)

### *Current output 0/4 to 20 mA*

Standard installation cable is sufficient.

### *Pulse/frequency/switch output*

Standard installation cable is sufficient.

### *Relay output*

Standard installation cable is sufficient.

### *Current input 0/4 to 20 mA*

Standard installation cable is sufficient.

### *Status input*

Standard installation cable is sufficient.

## Requirements for the connecting cable

### *Optionally available connecting cable*

A cable is supplied depending on the order option

- Order code for measuring device: order code **030** for "Display; operation", option **O** or
- Order code for measuring device: order code **030** for "Display; operation", option **M** and
- Order code for DKX001: order code **040** for "Cable", option **A, B, D, E**

<b>Standard cable</b>	2 × 2 × 0.34 mm <sup>2</sup> (22 AWG) PVC cable with common shield (2 pairs, pair-stranded)
<b>Flame resistance</b>	According to DIN EN 60332-1-2
<b>Oil-resistance</b>	According to DIN EN 60811-2-1
<b>Shielding</b>	Tin-plated copper-braid, optical cover ≥ 85 %
<b>Capacitance: core/shield</b>	≤200 pF/m
<b>L/R</b>	≤24 μH/Ω

<b>Available cable length</b>	5 m (15 ft)/10 m (35 ft)/20 m (65 ft)/30 m (100 ft)
<b>Operating temperature</b>	When mounted in a fixed position: -50 to +105 °C (-58 to +221 °F); when cable can move freely: -25 to +105 °C (-13 to +221 °F)

### Standard cable - customer-specific cable

No cable is supplied, and it must be provided by the customer (up to max. 300 m (1 000 ft)) for the following order option:

Order code for DKX001: Order code **040** for "Cable", option **1** "None, provided by customer, max 300 m"

A standard cable can be used as the connecting cable.

<b>Standard cable</b>	4 cores (2 pairs); pair-stranded with common shield
<b>Shielding</b>	Tin-plated copper-braid, optical cover ≥ 85 %
<b>Capacitance: core/shield</b>	Maximum 1 000 nF for Zone 1, Class I, Division 1
<b>L/R</b>	Maximum 24 μH/Ω for Zone 1, Class I, Division 1
<b>Cable length</b>	Maximum 300 m (1 000 ft), see the following table



<b>Cross-section</b>	<b>Max. cable length for use in Non-hazardous area, Ex Zone 2, Class I, Division 2 Ex Zone 1, Class I, Division 1</b>
0.34 mm <sup>2</sup> (22 AWG)	80 m (270 ft)
0.50 mm <sup>2</sup> (20 AWG)	120 m (400 ft)
0.75 mm <sup>2</sup> (18 AWG)	180 m (600 ft)
1.00 mm <sup>2</sup> (17 AWG)	240 m (800 ft)
1.50 mm <sup>2</sup> (15 AWG)	300 m (1 000 ft)

### 5.1.3 Terminal assignment

#### Transmitter: supply voltage, input/outputs

The terminal assignment of the inputs and outputs depends on the individual order version of the device. The device-specific terminal assignment is documented on an adhesive label in the terminal cover.

Supply voltage		Input/output 1		Input/output 2		Input/output 3	
1 (+)	2 (-)	26 (B)	27 (A)	24 (+)	25 (-)	22 (+)	23 (-)
Device-specific terminal assignment: adhesive label in terminal cover.							

 Terminal assignment of the remote display and operating module →  20.

### 5.1.4 Preparing the measuring device

#### NOTICE

#### Insufficient sealing of the housing!

Operational reliability of the measuring device could be compromised.

► Use suitable cable glands corresponding to the degree of protection.

1. Remove dummy plug if present.
2. If the measuring device is supplied without cable glands:  
Provide suitable cable gland for corresponding connecting cable.
3. If the measuring device is supplied with cable glands:  
Observe requirements for connecting cables →  13.

## 5.2 Connecting the measuring device

#### NOTICE

#### Limitation of electrical safety due to incorrect connection!

- Have electrical connection work carried out by appropriately trained specialists only.
- Observe applicable federal/national installation codes and regulations.
- Comply with local workplace safety regulations.
- Always connect the protective ground cable ⊕ before connecting additional cables.
- For use in potentially explosive atmospheres, observe the information in the device-specific Ex documentation.



### 5.2.1 Connecting the transmitter

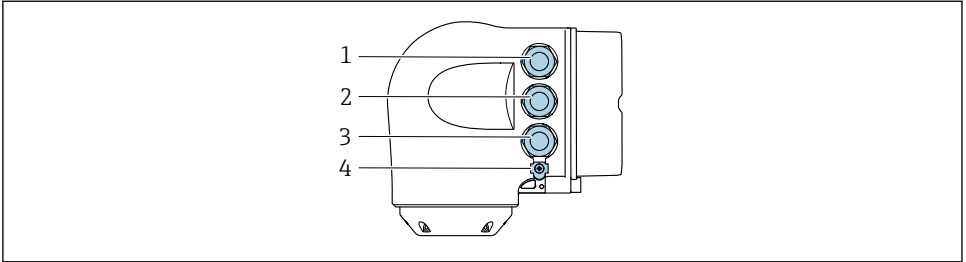

A0026781

- 1 Terminal connection for supply voltage
- 2 Terminal connection for signal transmission, input/output
- 3 Terminal connection for signal transmission, input/output or terminal connection for network connection via service interface (CDI-RJ45); optional: connection for external WLAN antenna or remote display and operating module DKX001
- 4 Protective earth (PE)

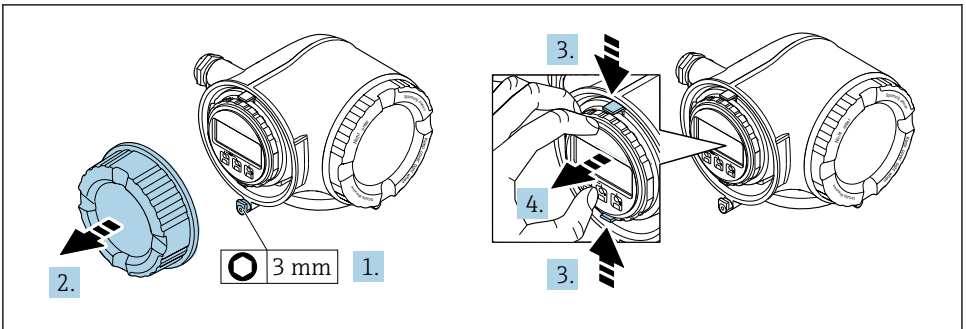

A0029813

1. Loosen the securing clamp of the connection compartment cover.
2. Unscrew the connection compartment cover.
3. Squeeze the tabs of the display module holder together.
4. Remove the display module holder.

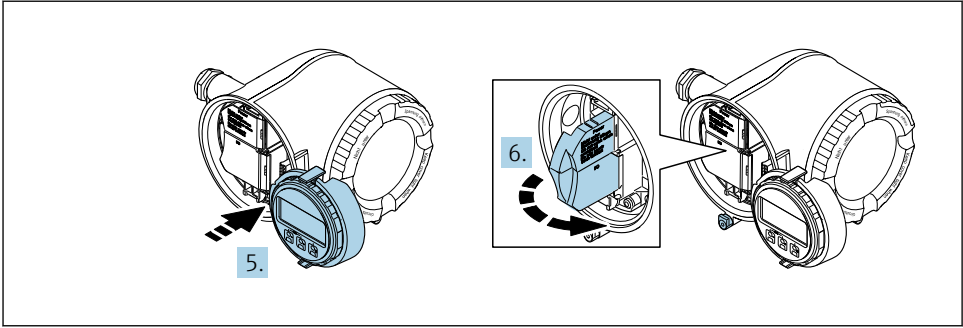

A0029814

5. Attach the holder to the edge of the electronics compartment.
6. Open the terminal cover.

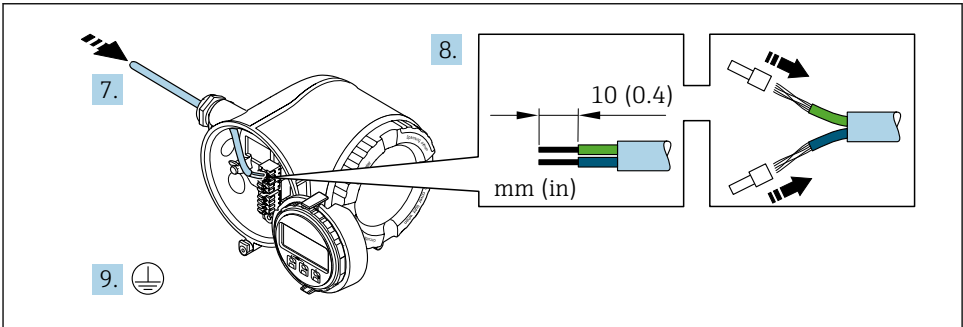

A0029815

7. Push the cable through the cable entry . To ensure tight sealing, do not remove the sealing ring from the cable entry.
8. Strip the cable and cable ends. In the case of stranded cables, also fit ferrules.
9. Connect the protective ground.

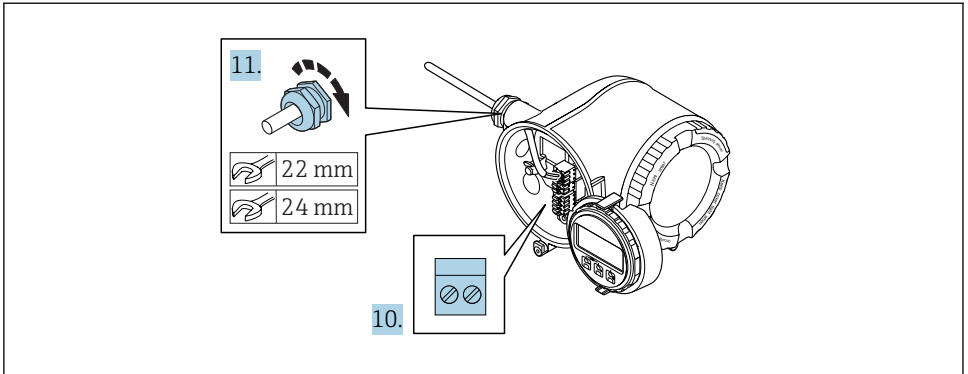

A0029816

10. Connect the cable in accordance with the terminal assignment .
  - ↳ **Signal cable terminal assignment:** The device-specific terminal assignment is documented on an adhesive label in the terminal cover.
  - Supply voltage terminal assignment:** Adhesive label in the terminal cover or → 16.
11. Firmly tighten the cable glands.
  - ↳ This concludes the cable connection process.
12. Close the terminal cover.
13. Fit the display module holder in the electronics compartment.
14. Screw on the connection compartment cover.
15. Secure the securing clamp of the connection compartment cover.

## 5.2.2 Connecting the remote display and operating module DKX001

**i** The remote display and operating module DKX001 is available as an optional extra.

- The remote display and operating module DKX001 is only available for the following housing version: order code for "Housing": option A "Aluminum, coated"
- The measuring device is always supplied with a dummy cover when the remote display and operating module DKX001 is ordered directly with the measuring device. Display or operation at the transmitter is not possible in this case.
- If ordered subsequently, the remote display and operating module DKX001 may not be connected at the same time as the existing measuring device display module. Only one display or operation unit may be connected to the transmitter at any one time.

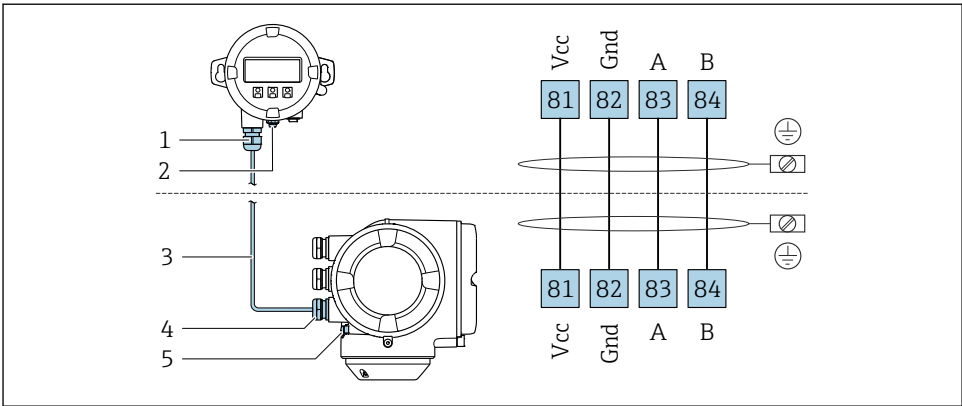

A0027518

- 1 Remote display and operating module DKX001
- 2 Protective earth (PE)
- 3 Connecting cable
- 4 Measuring device
- 5 Protective earth (PE)

## 5.3 Ensuring potential equalization

### 5.3.1 Proline Promag H

**i** For devices intended for use in hazardous locations, please observe the guidelines in the Ex documentation (XA).

#### Metal process connections

Potential equalization is generally via the metal process connections that are in contact with the medium and mounted directly on the sensor. Therefore there is generally no need for additional potential equalization measures.

## Plastic process connections

In the case of plastic process connections, additional grounding rings or process connections with an integrated grounding electrode must be used to ensure potential matching between the sensor and the fluid. If there is no potential matching, this can affect the measuring accuracy or cause the destruction of the sensor as a result of the electrochemical decomposition of the electrodes.

Note the following when using grounding rings:

- Depending on the option ordered, plastic disks are used instead of grounding rings on some process connections. These plastic disks only act as "spacers" and do not have any potential matching function. Furthermore, they also perform a significant sealing function at the sensor/connection interface. Therefore, in the case of process connections without metal grounding rings, these plastic disks/seals should never be removed and should always be installed!
- Grounding rings can be ordered separately as an accessory from Endress+Hauser . When ordering make sure that the grounding rings are compatible with the material used for the electrodes, as otherwise there is the danger that the electrodes could be destroyed by electrochemical corrosion!
- Grounding rings, including seals, are mounted inside the process connections. Therefore the installation length is not affected.

### Potential equalization via additional grounding ring

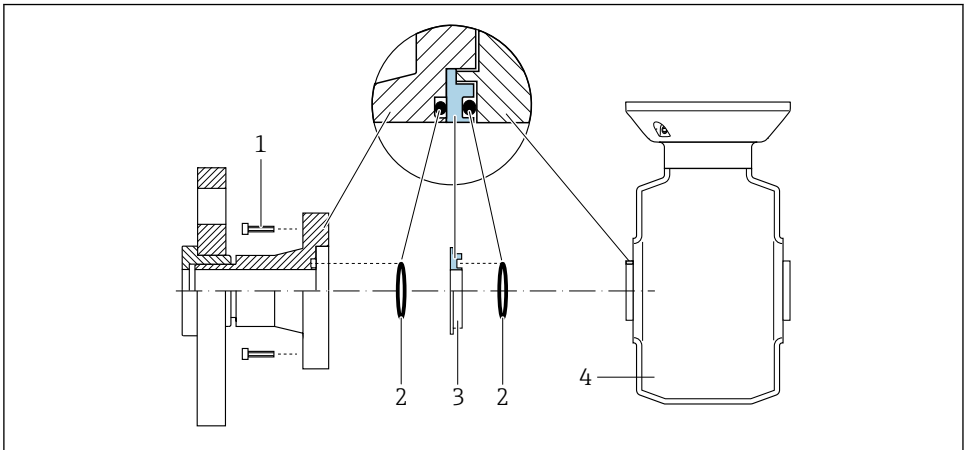

A0028971

- 1 Hexagonal-headed bolts of process connection
- 2 O-ring seals
- 3 Plastic disk (spacer) or grounding ring
- 4 Sensor

### Potential equalization via grounding electrodes on process connection

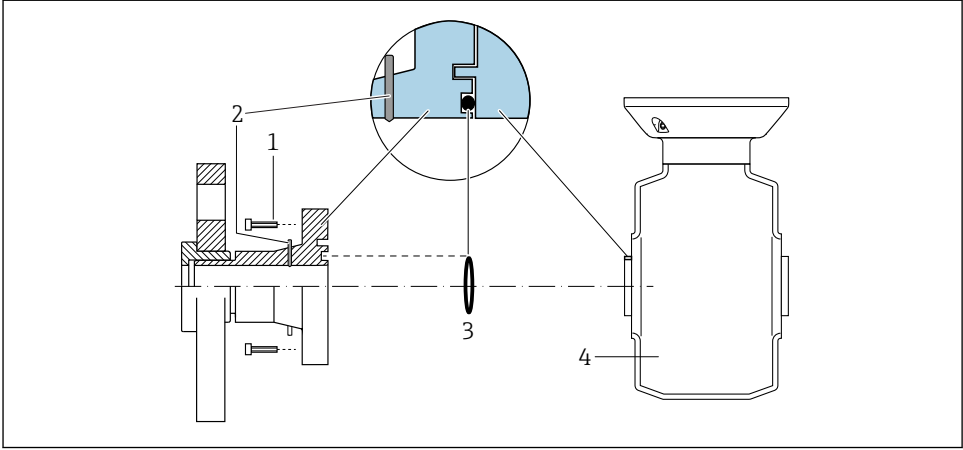

A0028972

- 1 Hexagonal-headed bolts of process connection
- 2 Integrated grounding electrodes
- 3 O-ring seal
- 4 Sensor

### 5.3.2 Promag P

 For devices intended for use in hazardous locations, please observe the guidelines in the Ex documentation (XA).

### Metal, grounded pipe

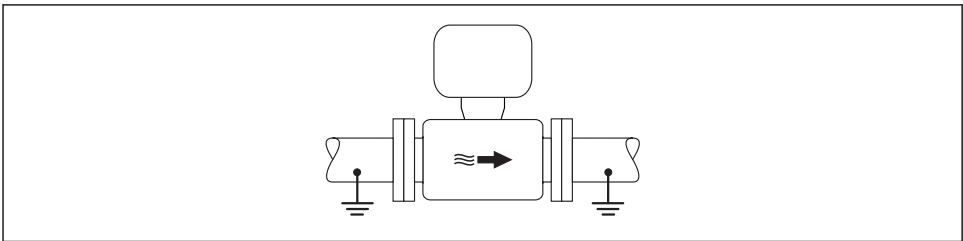

A0016315

-  1 Potential equalization via measuring tube

### Unlined and ungrounded metal pipe

This connection method also applies in situations where:

- The customary potential equalization is not used
- Equalizing currents are present

<b>Ground cable</b>	Copper wire, at least 6 mm <sup>2</sup> (0.0093 in <sup>2</sup> )
---------------------	---

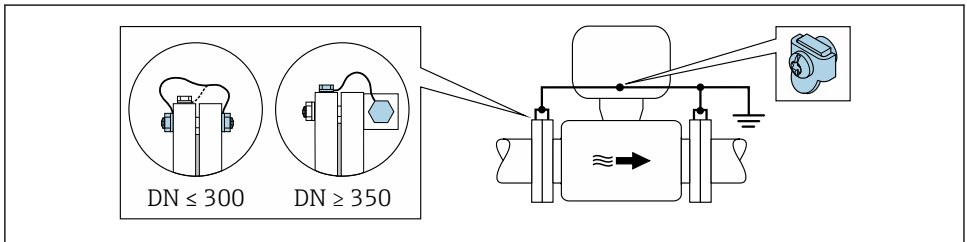

A0029338

### 2 Potential equalization via ground terminal and pipe flanges

1. Connect both sensor flanges to the pipe flange via a ground cable and ground them.
2. If  $DN \leq 300$  (12"): Mount the ground cable directly on the conductive flange coating of the sensor with the flange screws.
3. If  $DN \geq 350$  (14"): Mount the ground cable directly on the metal transport bracket. Observe screw tightening torques: see the Sensor Brief Operating Instructions.
4. Connect the connection housing of the transmitter or sensor to ground potential by means of the ground terminal provided for the purpose.

### Plastic pipe or pipe with insulating liner

This connection method also applies in situations where:

- The customary potential equalization is not used
- Equalizing currents are present

<b>Ground cable</b>	Copper wire, at least 6 mm <sup>2</sup> (0.0093 in <sup>2</sup> )
---------------------	---

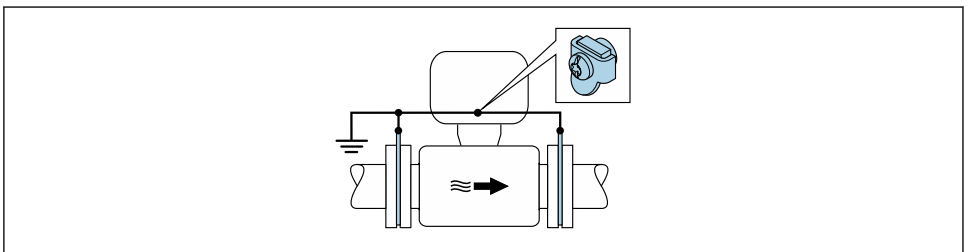

A0029339

### 3 Potential equalization via ground terminal and ground disks

1. Connect the ground disks to the ground terminal via the ground cable.
2. Connect the ground disks to ground potential.

### Pipe with a cathodic protection unit

This connection method is only used if the following two conditions are met:

- Metal pipe without liner or pipe with electrically conductive liner
- Cathodic protection is integrated in the personal protection equipment

<b>Ground cable</b>	Copper wire, at least 6 mm <sup>2</sup> (0.0093 in <sup>2</sup> )
---------------------	---

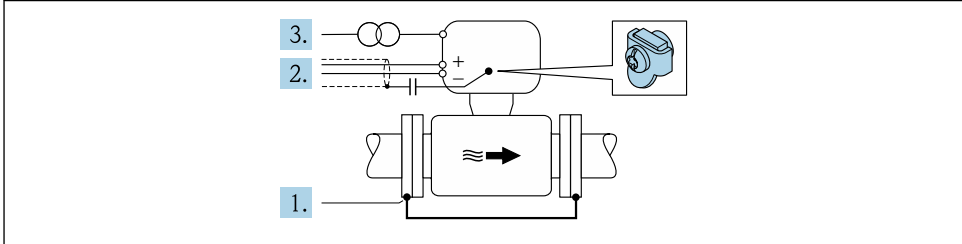

A0029340

Prerequisite: The sensor is installed in the pipe in a way that provides electrical insulation.

1. Connect the two flanges of the pipe to one another via a ground cable.
2. Guide the shield of the signal lines through a capacitor.
3. Connect the measuring device to the power supply such that it is floating in relation to the protective ground (isolation transformer).



## 5.4 Hardware settings

### 5.4.1 Setting the device address

The address must always be configured for a PROFIBUS DP/PA device. The valid address range is between 1 and 126. In a PROFIBUS DP/PA network, each address can only be assigned once. If an address is not configured correctly, the device is not recognized by the master. All measuring devices are delivered from the factory with the device address 126 and with the software addressing method.

#### Hardware addressing

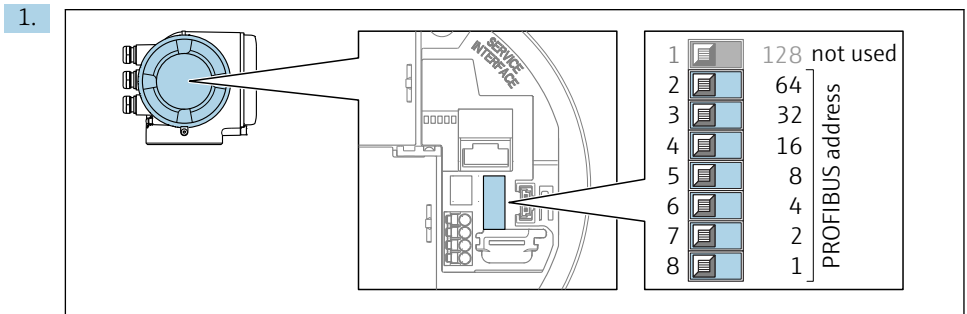

Set the desired device address using the DIP switches in the connection compartment.

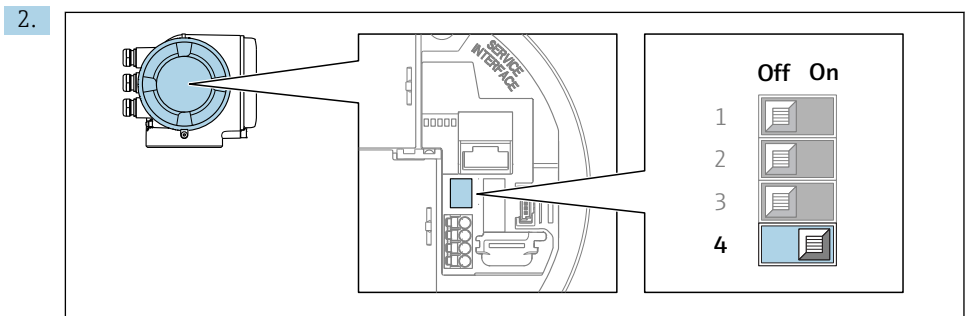

To switch addressing from software addressing to hardware addressing: set the DIP switch to **On**.

↳ The change of device address takes effect after 10 seconds. The device is restarted.

#### Software addressing

▶ To switch addressing from hardware addressing to software addressing: set DIP switch No. 4 to **Off**.

↳ The device address configured in the **Device address** parameter takes effect after 10 seconds. The device is restarted.

### 5.4.2 Enabling the terminating resistor

To avoid incorrect communication transmission caused by impedance mismatch, terminate the PROFIBUS DP cable correctly at the start and end of the bus segment.

- If the device is operated with a baud rate of 1.5 MBaud and under:  
For the last transmitter on the bus, terminate by setting DIP switch 3 (bus termination) to ON.
- For baud rates > 1.5 MBaud:  
Due to the capacitance load of the user and the line reflections generated as a result, ensure that an external bus terminator is used.

 It is generally advisable to use an external bus terminator as the entire segment can fail if a device that is terminated internally is defective.

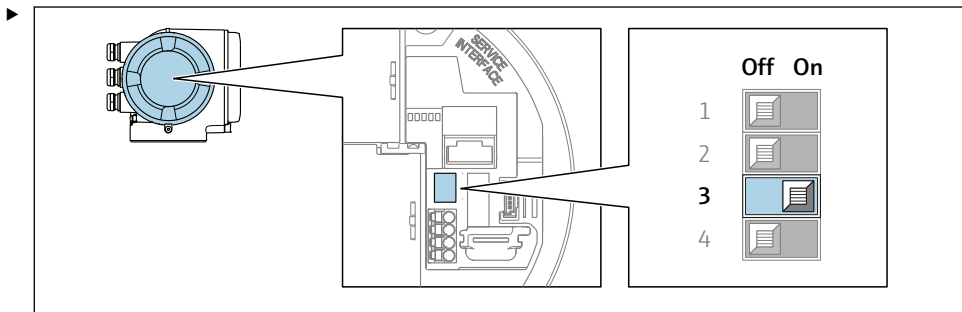

A0029632

Set DIP switch No. 3 to **ON**.

### 5.4.3 Activating the default IP address

The default IP address 192.168.1.212 can be activated by DIP switch.

Risk of electric shock when opening the transmitter housing.

- ▶ Before opening the transmitter housing:
- ▶ Disconnect the device from the power supply.

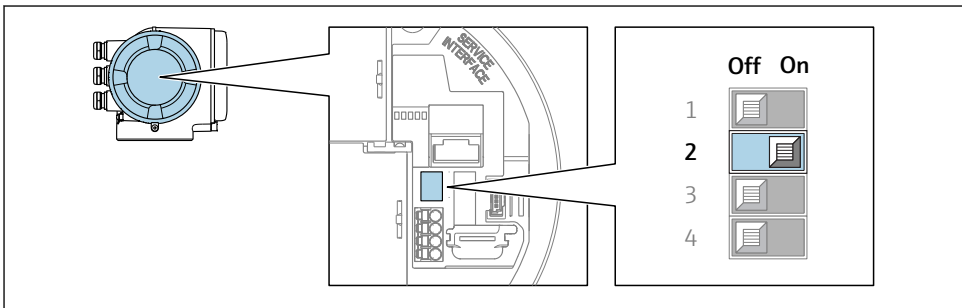

A0034499

- ▶ Set DIP switch No. 2 on the I/O electronics module from **OFF** → **ON**.

### 5.5 Ensuring the degree of protection

The measuring device fulfills all the requirements for the IP66/67 degree of protection, Type 4X enclosure.

To guarantee IP66/67 degree of protection, Type 4X enclosure, carry out the following steps after the electrical connection:

1. Check that the housing seals are clean and fitted correctly.
2. Dry, clean or replace the seals if necessary.
3. Tighten all housing screws and screw covers.
4. Firmly tighten the cable glands.
5. To ensure that moisture does not enter the cable entry:  
Route the cable so that it loops down before the cable entry ("water trap").

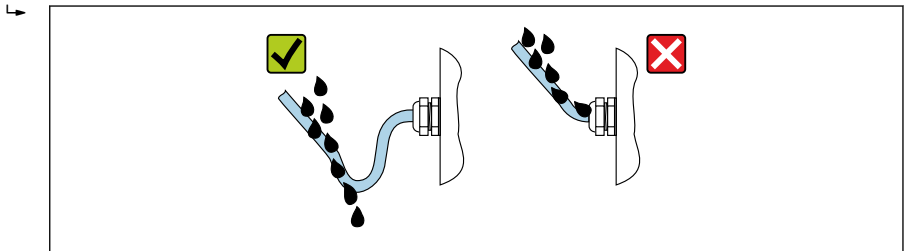

A0029278

6. Insert dummy plugs into unused cable entries.

### 5.6 Post-connection check

Are cables or the device undamaged (visual inspection)?	<input type="checkbox"/>
Do the cables used meet the requirements?	<input type="checkbox"/>
Do the cables have adequate strain relief?	<input type="checkbox"/>
Are all the cable glands installed, firmly tightened and leak-tight? Cable run with "water trap" → 27?	<input type="checkbox"/>
If supply voltage is present, do values appear on the display module?	<input type="checkbox"/>
Is the potential equalization established correctly ?	<input type="checkbox"/>

## 6 Operation options

### 6.1 Overview of operation options

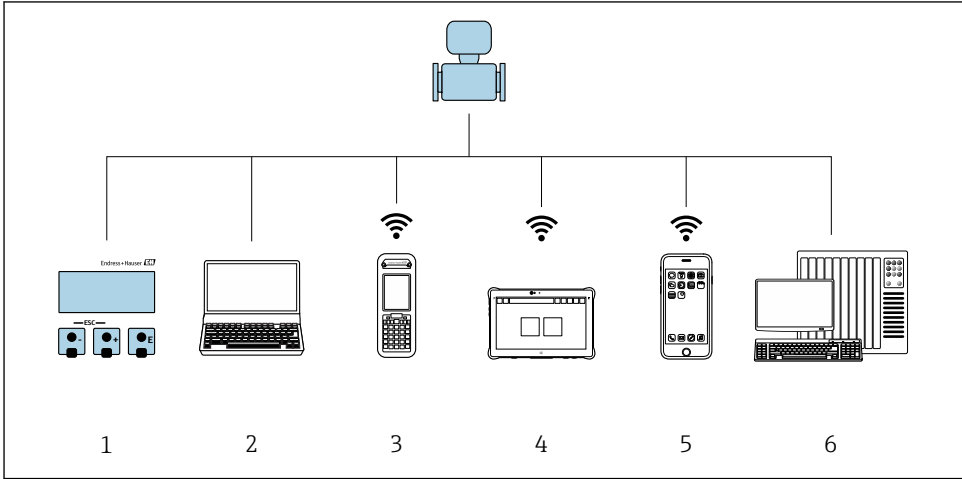

A0034513

- 1 Local operation via display module
- 2 Computer with Web browser (e.g. Internet Explorer) or with operating tool (e.g. FieldCare, DeviceCare, AMS Device Manager, SIMATIC PDM)
- 3 Field Xpert SFX350 or SFX370
- 4 Field Xpert SMT70
- 5 Mobile handheld terminal
- 6 Control system (e.g. PLC)

## 6.2 Structure and function of the operating menu

### 6.2.1 Structure of the operating menu

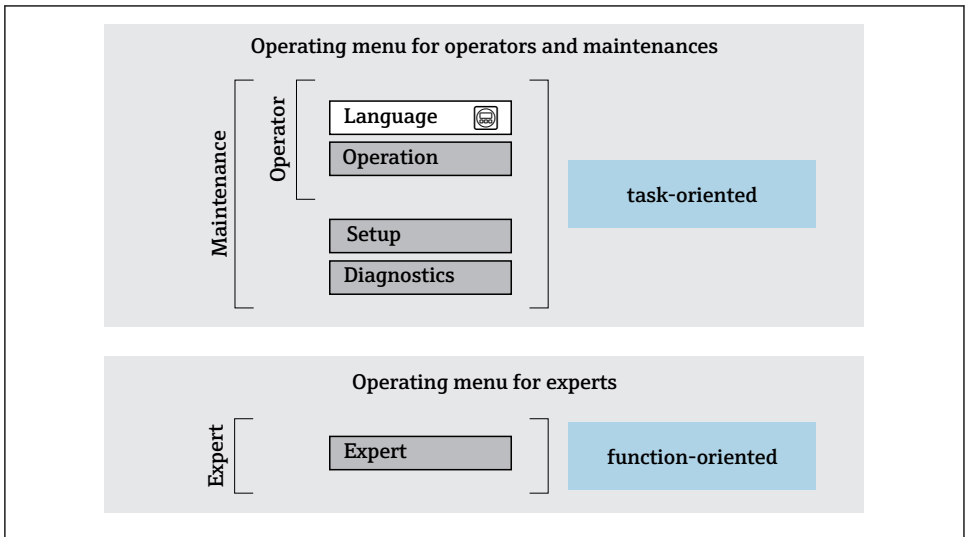

A0014058-EN

4 Schematic structure of the operating menu

### 6.2.2 Operating philosophy

The individual parts of the operating menu are assigned to certain user roles (operator, maintenance etc.). Each user role contains typical tasks within the device lifecycle.



For detailed information on the operating philosophy, see the Operating Instructions for the device.

### 6.3 Access to the operating menu via the local display

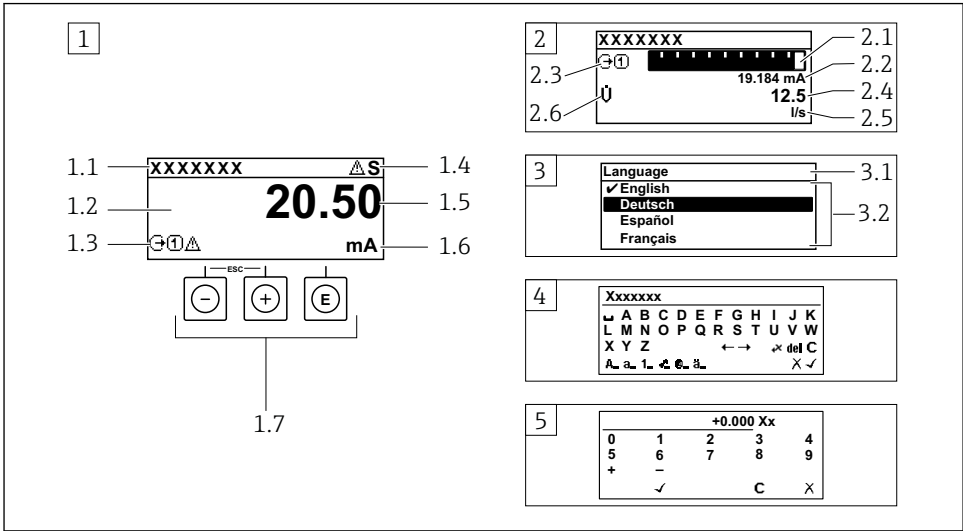

A0014013

- 1 Operational display with measured value shown as "1 value, max." (example)
  - 1.1 Device tag
  - 1.2 Display area for measured values (4-line)
  - 1.3 Explanatory symbols for measured value: Measured value type, measuring channel number, symbol for diagnostic behavior
  - 1.4 Status area
  - 1.5 Measured value
  - 1.6 Unit for the measured value
  - 1.7 Operating elements
- 2 Operational display with measured value shown as "1 bar graph + 1 value" (example)
  - 2.1 Bar graph display for measured value 1
  - 2.2 Measured value 1 with unit
  - 2.3 Explanatory symbols for measured value 1: measured value type, measuring channel number
  - 2.4 Measured value 2
  - 2.5 Unit for measured value 2
  - 2.6 Explanatory symbols for measured value 2: measured value type, measuring channel number
- 3 Navigation view: picklist of a parameter
  - 3.1 Navigation path and status area
  - 3.2 Display area for navigation: ✓ designates the current parameter value
- 4 Editing view: text editor with input mask
- 5 Editing view: numeric editor with input mask

### 6.3.1 Operational display

Explanatory symbols for the measured value	Status area
<ul style="list-style-type: none"> <li>▪ Depends on the device version, e.g.:                             <ul style="list-style-type: none"> <li>- : Volume flow</li> <li>- : Mass flow</li> <li>- : Density</li> <li>- : Conductivity</li> <li>- : Temperature</li> </ul> </li> <li>▪ : Totalizer</li> <li>▪ : Output</li> <li>▪ : Input</li> <li>▪  ... : Measurement channel number <sup>1)</sup></li> <li>▪ Diagnostic behavior <sup>2)</sup> <ul style="list-style-type: none"> <li>- : Alarm</li> <li>- : Warning</li> </ul> </li> </ul>	<p>The following symbols appear in the status area of the operational display at the top right:</p> <ul style="list-style-type: none"> <li>▪ Status signals                             <ul style="list-style-type: none"> <li>- <b>F</b>: Failure</li> <li>- <b>C</b>: Function check</li> <li>- <b>S</b>: Out of specification</li> <li>- <b>M</b>: Maintenance required</li> </ul> </li> <li>▪ Diagnostic behavior                             <ul style="list-style-type: none"> <li>- : Alarm</li> <li>- : Warning</li> </ul> </li> <li>▪ : Locking (locked via hardware))</li> <li>▪ : Communication via remote operation is active.</li> </ul>







- 1) If there is more than one channel for the same measured variable type (totalizer, output etc.).
- 2) For a diagnostic event that concerns the displayed measured variable.

### 6.3.2 Navigation view





Status area	Display area
<p>The following appears in the status area of the navigation view in the top right corner:</p> <ul style="list-style-type: none"> <li>▪ In the submenu                             <ul style="list-style-type: none"> <li>- The direct access code for the parameter you are navigating to (e.g. 0022-1)</li> <li>- If a diagnostic event is present, the diagnostic behavior and status signal</li> </ul> </li> <li>▪ In the wizard                             <ul style="list-style-type: none"> <li>- If a diagnostic event is present, the diagnostic behavior and status signal</li> </ul> </li> </ul>	<ul style="list-style-type: none"> <li>▪ Icons for menus                             <ul style="list-style-type: none"> <li>- : Operation</li> <li>- : Setup</li> <li>- : Diagnostics</li> <li>- : Expert</li> </ul> </li> <li>▪ : Submenus</li> <li>▪ : Wizards</li> <li>▪ : Parameters within a wizard</li> <li>▪ : Parameter locked</li> </ul>

### 6.3.3 Editing view

Text editor	Correction symbols under
Confirms selection.	Clears all entered characters.
Exits the input without applying the changes.	Moves the input position one position to the right.
Clears all entered characters.	Moves the input position one position to the left.
Switches to the selection of the correction tools.	Deletes one character immediately to the left of the input position.
Toggle <ul style="list-style-type: none"> <li>▪ Between upper-case and lower-case letters</li> <li>▪ For entering numbers</li> <li>▪ For entering special characters</li> </ul>	

Numeric editor	
 Confirms selection.	 Moves the input position one position to the left.
 Exits the input without applying the changes.	 Inserts decimal separator at the input position.
 Inserts minus sign at the input position.	 Clears all entered characters.

### 6.3.4 Operating elements

Keys and meaning
<p> <b>Enter key</b></p> <p><i>With an operational display</i> Pressing the key briefly opens the operating menu.</p> <p><i>In a menu, submenu</i></p> <ul style="list-style-type: none"> <li>■ Pressing the key briefly:                     <ul style="list-style-type: none"> <li>- Opens the selected menu, submenu or parameter.</li> <li>- Starts the wizard.</li> <li>- If help text is open:                             <ul style="list-style-type: none"> <li>Closes the help text of the parameter.</li> </ul> </li> </ul> </li> <li>■ Pressing the key for 2 s in the case of a parameter: If present, opens the help text for the function of the parameter.</li> </ul> <p><i>With a wizard:</i> Opens the editing view of the parameter.</p> <p><i>With a text and numeric editor</i></p> <ul style="list-style-type: none"> <li>■ Press the key briefly: confirm your selection.</li> <li>■ Press the key for 2 s: confirm the entry.</li> </ul>
<p> <b>Minus key</b></p> <ul style="list-style-type: none"> <li>■ <i>In a menu, submenu:</i> Moves the selection bar upwards in a picklist.</li> <li>■ <i>With a wizard:</i> Confirms the parameter value and goes to the previous parameter.</li> <li>■ <i>With a text and numeric editor:</i> Moves the cursor position to the left.</li> </ul>
<p> <b>Plus key</b></p> <ul style="list-style-type: none"> <li>■ <i>In a menu, submenu:</i> Moves the selection bar downwards in a picklist.</li> <li>■ <i>With a wizard:</i> Confirms the parameter value and goes to the next parameter.</li> <li>■ <i>With a text and numeric editor:</i> Moves the cursor position to the right.</li> </ul>
<p>+ <b>Escape key combination (press keys simultaneously)</b></p> <p><i>In a menu, submenu</i></p> <ul style="list-style-type: none"> <li>■ Pressing the key briefly:                     <ul style="list-style-type: none"> <li>- Exits the current menu level and takes you to the next higher level.</li> <li>- If help text is open, closes the help text of the parameter.</li> </ul> </li> <li>■ Pressing the key for 2 s in the case of a parameter: Returns you to the operational display ("home position").</li> </ul> <p><i>With a wizard:</i> Exits the wizard and takes you to the next higher level.</p> <p><i>With a text and numeric editor:</i> Closes the editor view without applying any changes.</p>



**Keys and meaning** **Minus/Enter key combination (press the keys simultaneously)**

*With an operational display:*

- If keypad lock is active:  
Press the key for 3 s: Deactivates the keypad lock.
- If keypad lock is not active:  
Press the key for 3 s: Opens the context menu including the option for activating the keypad lock.

**6.3.5 Further information**

For further information on the following topics, see the Operating Instructions for the device

- Calling up help text
- User roles and related access authorization
- Disabling write protection via access code
- Enabling and disabling the keypad lock

**6.4 Access to the operating menu via the operating tool**

The operating menu can also be accessed via the FieldCare and DeviceCare operating tools. See the Operating Instructions for the device.

**6.5 Access to the operating menu via the Web server**

The operating menu can also be accessed via the Web server. See the Operating Instructions for the device.

**7 System integration**

For detailed information on system integration, see the Operating Instructions for the device.

- Overview of device description files:
  - Current version data for the device
  - Operating tools
- Device master file (GSD)
  - Manufacturer-specific GSD
  - Profile GSD
- Compatibility with previous model
- Using the GSD modules of the previous model
- Cyclic data transmission
  - Block model
  - Description of the modules

## 8 Commissioning

### 8.1 Function check

Before commissioning the measuring device:

- ▶ Make sure that the post-installation and post-connection checks have been performed.
- "Post-installation check" checklist →  12
- "Post-connection check" checklist →  27

### 8.2 Setting the operating language

Factory setting: English or ordered local language

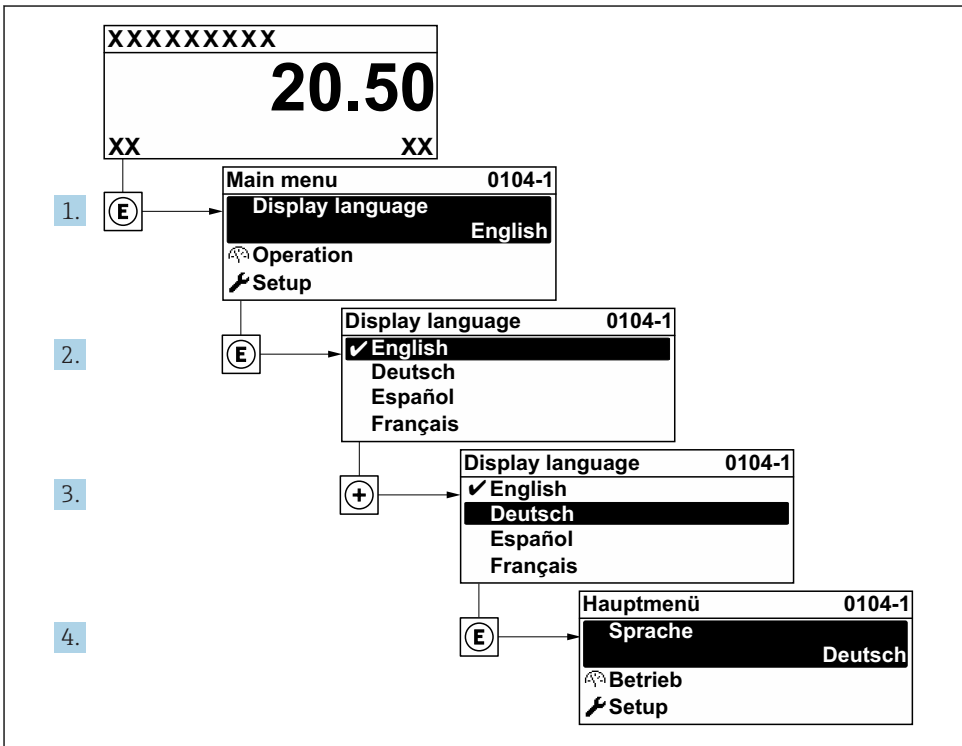

A0029420

 5 *Taking the example of the local display*

### 8.3 Configuring the measuring device

The **Setup** menu with its submenus and guided wizards is used for fast commissioning of the device. They contain all the parameters required for configuration, such as for measurement or communication.



Depending on the device version, not all submenus and parameters are available in every device. The selection can vary depending on the order code.

Example: Available submenus, wizards	Meaning
System units	Configure the units for all measured values
User interface	Configure the display format on the local display
Low flow cut off	Set the low flow cut off
Empty pipe detection	Configure empty pipe detection
Advanced setup	Additional parameters for configuration: <ul style="list-style-type: none"> <li>▪ Sensor adjustment</li> <li>▪ Totalizer</li> <li>▪ User interface</li> <li>▪ Electrode cleaning circuit</li> <li>▪ WLAN settings</li> <li>▪ Data backup</li> <li>▪ Administration</li> </ul>

### 8.4 Protecting settings from unauthorized access

The following write protection options exist in order to protect the configuration of the measuring device from unintentional modification:

- Protect access to parameters via access code
- Protect access to local operation via key locking
- Protect access to measuring device via write protection switch



For detailed information on protecting the settings against unauthorized access, see the Operating Instructions for the device.

## 9 Diagnostic information

Faults detected by the self-monitoring system of the measuring device are displayed as a diagnostic message in alternation with the operational display. The message about remedial measures can be called up from the diagnostic message, and contains important information on the fault.

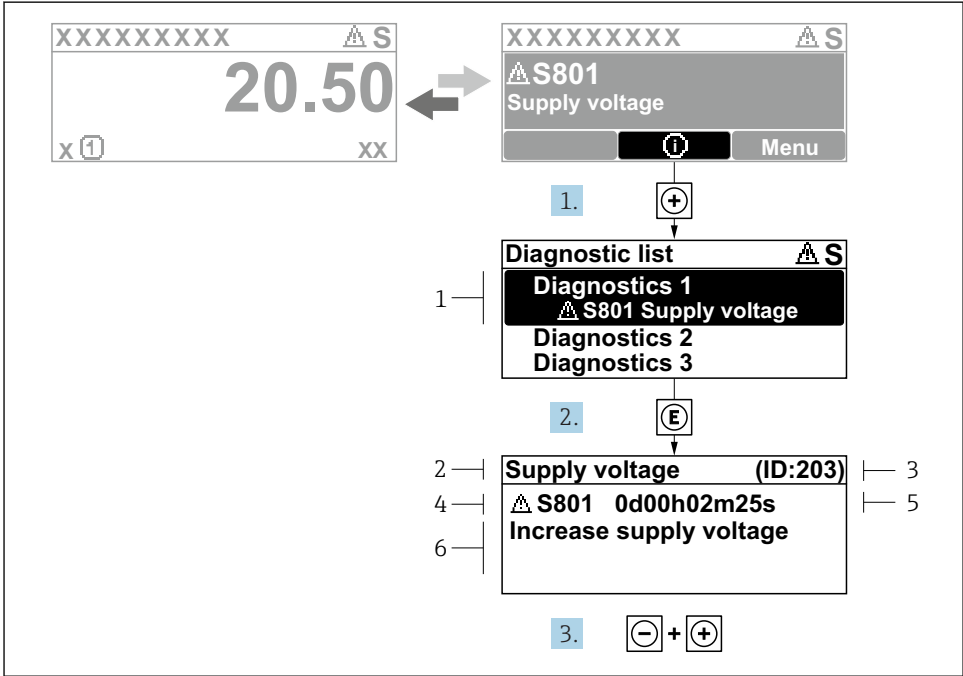

A0029431-EN

### 6 Message about remedial measures

- 1 Diagnostic information
- 2 Short text
- 3 Service ID
- 4 Diagnostic behavior with diagnostic code
- 5 Operation time of occurrence
- 6 Remedial measures

1. The user is in the diagnostic message.  
Press **+** (Ⓢ symbol).  
↳ The **Diagnostic list** submenu opens.
2. Select the desired diagnostic event with **+** or **-** and press **E** .  
↳ The message about the remedial measures opens.
3. Press **-** + **+** simultaneously.  
↳ The message about the remedial measures closes.







[www.addresses.endress.com](http://www.addresses.endress.com)

---