

Operating Instructions

Proline Promass F 500

EtherNet/IP

Coriolis flowmeter

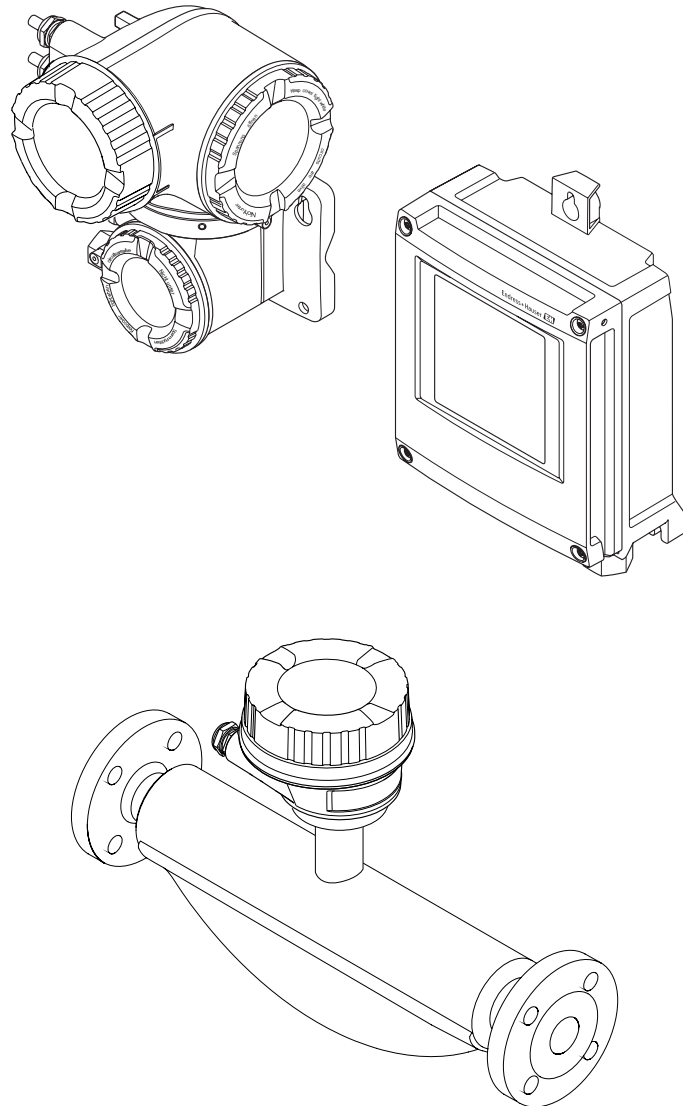

- Make sure the document is stored in a safe place such that it is always available when working on or with the device.
- To avoid danger to individuals or the facility, read the "Basic safety instructions" section carefully, as well as all other safety instructions in the document that are specific to working procedures.
- The manufacturer reserves the right to modify technical data without prior notice. Your Endress+Hauser Sales Center will supply you with current information and updates to these instructions.

Table of contents

1	About this document	6	5.3	Packaging disposal	23
1.1	Document function	6	6	Installation	23
1.2	Symbols used	6	6.1	Installation conditions	23
1.2.1	Safety symbols	6	6.1.1	Mounting position	23
1.2.2	Electrical symbols	6	6.1.2	Requirements from environment and process	26
1.2.3	Communication symbols	6	6.1.3	Special mounting instructions	28
1.2.4	Tool symbols	7	6.2	Mounting the measuring device	30
1.2.5	Symbols for certain types of information	7	6.2.1	Required tools	30
1.2.6	Symbols in graphics	7	6.2.2	Preparing the measuring device	30
1.3	Documentation	8	6.2.3	Mounting the measuring device	30
1.3.1	Standard documentation	8	6.2.4	Mounting the transmitter housing: Proline 500 – digital	31
1.3.2	Supplementary device-dependent documentation	8	6.2.5	Mounting the transmitter housing: Proline 500	32
1.4	Registered trademarks	8	6.2.6	Turning the transmitter housing: Proline 500	34
2	Basic safety instructions	10	6.2.7	Turning the display module: Proline 500	35
2.1	Requirements for the personnel	10	6.3	Post-installation check	35
2.2	Designated use	10	7	Electrical connection	36
2.3	Workplace safety	11	7.1	Connection conditions	36
2.4	Operational safety	11	7.1.1	Required tools	36
2.5	Product safety	11	7.1.2	Requirements for connecting cable	36
2.6	IT security	12	7.1.3	Terminal assignment	40
2.7	Device-specific IT security	12	7.1.4	Device plugs available	40
2.7.1	Protecting access via hardware write protection	12	7.1.5	Pin assignment of device plug	41
2.7.2	Protecting access via a password	12	7.1.6	Preparing the measuring device	41
2.7.3	Access via fieldbus	13	7.2	Connecting the measuring device: Proline 500 - digital	42
2.7.4	Access via Web server	13	7.2.1	Connecting the connecting cable	42
2.7.5	Access via CDI-RJ45 service interface	14	7.2.2	Connecting the transmitter	47
3	Product description	15	7.2.3	Integrating the transmitter into a network	50
3.1	Product design	15	7.3	Connecting the measuring device: Proline 500	52
3.1.1	Proline 500 – digital	15	7.3.1	Connecting the connecting cable	52
3.1.2	Proline 500	16	7.3.2	Connecting the transmitter	56
4	Incoming acceptance and product identification	17	7.3.3	Integrating the transmitter into a network	59
4.1	Incoming acceptance	17	7.4	Ensure potential equalization	60
4.2	Product identification	17	7.4.1	Requirements	60
4.2.1	Transmitter nameplate	18	7.5	Special connection instructions	61
4.2.2	Sensor nameplate	20	7.5.1	Connection examples	61
4.2.3	Symbols on measuring device	21	7.6	Hardware settings	64
5	Storage and transport	22	7.6.1	Setting the device address	64
5.1	Storage conditions	22	7.6.2	Activating the default IP address	65
5.2	Transporting the product	22	7.7	Ensuring the degree of protection	67
5.2.1	Measuring devices without lifting lugs	22	7.8	Post-connection check	67
5.2.2	Measuring devices with lifting lugs	23	8	Operation options	68
5.2.3	Transporting with a fork lift	23	8.1	Overview of operation options	68

8.2	Structure and function of the operating menu	69	10.5.4	Selecting and setting the medium ..	119
8.2.1	Structure of the operating menu	69	10.5.5	Displaying the I/O configuration ...	120
8.2.2	Operating philosophy	70	10.5.6	Configuring the current input	121
8.3	Access to the operating menu via the local display	71	10.5.7	Configuring the status input	122
8.3.1	Operational display	71	10.5.8	Configuring the current output	123
8.3.2	Navigation view	73	10.5.9	Configuring the pulse/frequency/switch output	128
8.3.3	Editing view	75	10.5.10	Configuring the relay output	138
8.3.4	Operating elements	77	10.5.11	Configuring the local display	141
8.3.5	Opening the context menu	77	10.5.12	Configuring the low flow cut off	152
8.3.6	Navigating and selecting from list ...	79	10.5.13	Configuring the partial filled pipe detection	153
8.3.7	Calling the parameter directly	79	10.6	Advanced settings	154
8.3.8	Calling up help text	80	10.6.1	Using the parameter to enter the access code	155
8.3.9	Changing the parameters	80	10.6.2	Calculated values	155
8.3.10	User roles and related access authorization	81	10.6.3	Carrying out a sensor adjustment ...	156
8.3.11	Disabling write protection via access code	81	10.6.4	Configuring the totalizer	157
8.3.12	Enabling and disabling the keypad lock	82	10.6.5	Carrying out additional display configurations	159
8.4	Access to the operating menu via the Web browser	82	10.6.6	WLAN configuration	169
8.4.1	Function range	82	10.6.7	Configuration management	170
8.4.2	Prerequisites	83	10.6.8	Using parameters for device administration	172
8.4.3	Establishing a connection	84	10.7	Simulation	173
8.4.4	Logging on	87	10.8	Protecting settings from unauthorized access	177
8.4.5	User interface	88	10.8.1	Write protection via access code ...	177
8.4.6	Disabling the Web server	89	10.8.2	Write protection via write protection switch	178
8.4.7	Logging out	89	11	Operation	181
8.5	Access to the operating menu via the operating tool	90	11.1	Reading the device locking status	181
8.5.1	Connecting the operating tool	90	11.2	Adjusting the operating language	181
8.5.2	FieldCare	94	11.3	Configuring the display	181
8.5.3	DeviceCare	95	11.4	Reading measured values	181
9	System integration	96	11.4.1	"Measured variables" submenu	182
9.1	Overview of device description files	96	11.4.2	"Totalizer" submenu	183
9.1.1	Current version data for the device ...	96	11.4.3	"Input values" submenu	184
9.1.2	Operating tools	96	11.4.4	Output values	185
9.2	Overview of system files	96	11.5	Adapting the measuring device to the process conditions	187
9.3	Integrating the measuring device in the system	97	11.6	Performing a totalizer reset	187
9.4	Cyclic data transmission	97	11.6.1	Function scope of the "Control Totalizer" parameter	188
9.4.1	Block model	97	11.6.2	Function scope of the "Reset all totalizers" parameter	188
9.4.2	Input and output groups	98	11.7	Showing data logging	188
9.5	Diagnostic information via EtherNet/IP	108	12	Diagnostics and troubleshooting ..	194
10	Commissioning	113	12.1	General troubleshooting	194
10.1	Function check	113	12.2	Diagnostic information via light emitting diodes	197
10.2	Switching on the measuring device	113	12.2.1	Transmitter	197
10.3	Connecting via FieldCare	113	12.2.2	Sensor connection housing	199
10.4	Setting the operating language	113	12.3	Diagnostic information on local display	200
10.5	Configuring the measuring device	114	12.3.1	Diagnostic message	200
10.5.1	Defining the tag name	115	12.3.2	Calling up remedial measures	202
10.5.2	Setting the system units	115			
10.5.3	Configuring the communication interface	117			

12.4	Diagnostic information in the Web browser .	202	16	Technical data	232
12.4.1	Diagnostic options	202	16.1	Application	232
12.4.2	Calling up remedy information	203	16.2	Function and system design	232
12.5	Diagnostic information in DeviceCare or FieldCare	203	16.3	Input	233
12.5.1	Diagnostic options	203	16.4	Output	236
12.5.2	Calling up remedy information	204	16.5	Power supply	240
12.6	Diagnostic information via communication interface	205	16.6	Performance characteristics	241
12.6.1	Reading out diagnostic information	205	16.7	Installation	246
12.7	Adapting the diagnostic information	205	16.8	Environment	247
12.7.1	Adapting the diagnostic behavior ...	205	16.9	Process	248
12.8	Overview of diagnostic information	206	16.10	Mechanical construction	251
12.8.1	Diagnostic of sensor	206	16.11	Operability	255
12.8.2	Diagnostic of electronic	207	16.12	Certificates and approvals	259
12.8.3	Diagnostic of configuration	211	16.13	Application packages	261
12.8.4	Diagnostic of process	216	16.14	Accessories	263
12.9	Pending diagnostic events	219	16.15	Supplementary documentation	263
12.10	Diagnostic list	220	Index	265	
12.11	Event logbook	220			
12.11.1	Reading out the event logbook	220			
12.11.2	Filtering the event logbook	221			
12.11.3	Overview of information events	221			
12.12	Resetting the measuring device	223			
12.12.1	Function scope of the "Device reset" parameter	223			
12.13	Device information	223			
12.14	Firmware history	225			
13	Maintenance	226			
13.1	Maintenance tasks	226			
13.1.1	Exterior cleaning	226			
13.1.2	Interior cleaning	226			
13.2	Measuring and test equipment	226			
13.3	Endress+Hauser services	226			
14	Repairs	227			
14.1	General notes	227			
14.1.1	Repair and conversion concept	227			
14.1.2	Notes for repair and conversion	227			
14.2	Spare parts	227			
14.3	Endress+Hauser services	227			
14.4	Return	227			
14.5	Disposal	228			
14.5.1	Removing the measuring device	228			
14.5.2	Disposing of the measuring device ..	228			
15	Accessories	229			
15.1	Device-specific accessories	229			
15.1.1	For the transmitter	229			
15.1.2	For the sensor	230			
15.2	Communication-specific accessories	230			
15.3	Service-specific accessories	230			
15.4	System components	231			





1 About this document

1.1 Document function





These Operating Instructions contain all the information that is required in various phases of the life cycle of the device: from product identification, incoming acceptance and storage, to mounting, connection, operation and commissioning through to troubleshooting, maintenance and disposal.

1.2 Symbols used



1.2.1 Safety symbols



Symbol	Meaning
	DANGER! This symbol alerts you to a dangerous situation. Failure to avoid this situation will result in serious or fatal injury.
	WARNING! This symbol alerts you to a dangerous situation. Failure to avoid this situation can result in serious or fatal injury.
	CAUTION! This symbol alerts you to a dangerous situation. Failure to avoid this situation can result in minor or medium injury.
	NOTE! This symbol contains information on procedures and other facts which do not result in personal injury.

1.2.2 Electrical symbols



Symbol	Meaning
	Direct current
	Alternating current
	Direct current and alternating current
	Ground connection A grounded terminal which, as far as the operator is concerned, is grounded via a grounding system.
	Protective Earth (PE) A terminal which must be connected to ground prior to establishing any other connections. The ground terminals are situated inside and outside the device: <ul style="list-style-type: none"> ▪ Inner ground terminal: Connects the protective earth to the mains supply. ▪ Outer ground terminal: Connects the device to the plant grounding system.

1.2.3 Communication symbols













Symbol	Meaning
	Wireless Local Area Network (WLAN) Communication via a wireless, local network.
	LED Light emitting diode is off.

Symbol	Meaning
	LED Light emitting diode is on.
	LED Light emitting diode is flashing.





1.2.4 Tool symbols



Symbol	Meaning
	Torx screwdriver
	Phillips head screwdriver
	Open-ended wrench

1.2.5 Symbols for certain types of information

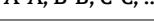
Symbol	Meaning
	Permitted Procedures, processes or actions that are permitted.
	Preferred Procedures, processes or actions that are preferred.
	Forbidden Procedures, processes or actions that are forbidden.
	Tip Indicates additional information.
	Reference to documentation.
	Reference to page.
	Reference to graphic.
	Notice or individual step to be observed.
	Series of steps.
	Result of a step.
	Help in the event of a problem.
	Visual inspection.

1.2.6 Symbols in graphics



Symbol	Meaning
	Item numbers
	Series of steps
	Views
	Sections
	Hazardous area

Symbol	Meaning
	Safe area (non-hazardous area)
	Flow direction

1.3 Documentation

 For an overview of the scope of the associated Technical Documentation, refer to the following:

- The *W@M Device Viewer* : Enter the serial number from the nameplate (www.endress.com/deviceviewer)
- The *Endress+Hauser Operations App*: Enter the serial number from the nameplate or scan the 2-D matrix code (QR code) on the nameplate.

 For a detailed list of the individual documents along with the documentation code
→  263

1.3.1 Standard documentation

Document type	Purpose and content of the document
Technical Information	Planning aid for your device The document contains all the technical data on the device and provides an overview of the accessories and other products that can be ordered for the device.
Sensor Brief Operating Instructions	Guides you quickly to the 1st measured value - Part 1 The Sensor Brief Operating Instructions are aimed at specialists with responsibility for installing the measuring device. <ul style="list-style-type: none"> ▪ Incoming acceptance and product identification ▪ Storage and transport ▪ Installation
Transmitter Brief Operating Instructions	Guides you quickly to the 1st measured value - Part 2 The Transmitter Brief Operating Instructions are aimed at specialists with responsibility for commissioning, configuring and parameterizing the measuring device (until the first measured value). <ul style="list-style-type: none"> ▪ Product description ▪ Installation ▪ Electrical connection ▪ Operation options ▪ System integration ▪ Commissioning ▪ Diagnostic information
Description of Device Parameters	Reference for your parameters The document provides a detailed explanation of each individual parameter in the Expert operating menu. The description is aimed at those who work with the device over the entire life cycle and perform specific configurations.

1.3.2 Supplementary device-dependent documentation

Additional documents are supplied depending on the device version ordered: Always comply strictly with the instructions in the supplementary documentation. The supplementary documentation is an integral part of the device documentation.

1.4 Registered trademarks

EtherNet/IP™
Trademark of ODVA, Inc.

TRI-CLAMP®

Registered trademark of Ladish & Co., Inc., Kenosha, USA

2 Basic safety instructions

2.1 Requirements for the personnel

The personnel for installation, commissioning, diagnostics and maintenance must fulfill the following requirements:

- ▶ Trained, qualified specialists must have a relevant qualification for this specific function and task.
- ▶ Are authorized by the plant owner/operator.
- ▶ Are familiar with federal/national regulations.
- ▶ Before starting work, read and understand the instructions in the manual and supplementary documentation as well as the certificates (depending on the application).
- ▶ Follow instructions and comply with basic conditions.

The operating personnel must fulfill the following requirements:

- ▶ Are instructed and authorized according to the requirements of the task by the facility's owner-operator.
- ▶ Follow the instructions in this manual.

2.2 Designated use

Application and media

The measuring device described in these Brief Operating Instructions is intended only for flow measurement of liquids and gases.

Depending on the version ordered, the measuring device can also measure potentially explosive, flammable, poisonous and oxidizing media.

Measuring devices for use in hazardous areas, in hygienic applications or where there is an increased risk due to process pressure, are labeled accordingly on the nameplate.

To ensure that the measuring device remains in proper condition for the operation time:

- ▶ Keep within the specified pressure and temperature range.
- ▶ Only use the measuring device in full compliance with the data on the nameplate and the general conditions listed in the Operating Instructions and supplementary documentation.
- ▶ Based on the nameplate, check whether the ordered device is permitted for the intended use in the hazardous area (e.g. explosion protection, pressure vessel safety).
- ▶ Use the measuring device only for media to which the process-wetted materials are sufficiently resistant.
- ▶ If the measuring device is not operated at atmospheric temperature, compliance with the relevant basic conditions specified in the associated device documentation is absolutely essential: "Documentation" section →  8.
- ▶ Protect the measuring device permanently against corrosion from environmental influences.

Incorrect use

Non-designated use can compromise safety. The manufacturer is not liable for damage caused by improper or non-designated use.

WARNING

Danger of breakage due to corrosive or abrasive fluids!

- ▶ Verify the compatibility of the process fluid with the sensor material.
- ▶ Ensure the resistance of all fluid-wetted materials in the process.
- ▶ Keep within the specified pressure and temperature range.

NOTICE**Verification for borderline cases:**

- ▶ For special fluids and fluids for cleaning, Endress+Hauser is glad to provide assistance in verifying the corrosion resistance of fluid-wetted materials, but does not accept any warranty or liability as minute changes in the temperature, concentration or level of contamination in the process can alter the corrosion resistance properties.

Residual risks**⚠ WARNING**

The electronics and the medium may cause the surfaces to heat up. This presents a burn hazard!

- ▶ For elevated fluid temperatures, ensure protection against contact to prevent burns.

⚠ WARNING

Danger of housing breaking due to measuring tube breakage!

- ▶ In the event of a measuring tube breakage for a device version without rupture disk it is possible for the pressure loading capacity of the sensor housing to be exceeded. This can lead to rupture or failure of the sensor housing.

2.3 Workplace safety

For work on and with the device:

- ▶ Wear the required personal protective equipment according to federal/national regulations.

For welding work on the piping:

- ▶ Do not ground the welding unit via the measuring device.

If working on and with the device with wet hands:

- ▶ Due to the increased risk of electric shock, gloves must be worn.

2.4 Operational safety

Risk of injury.

- ▶ Operate the device in proper technical condition and fail-safe condition only.
- ▶ The operator is responsible for interference-free operation of the device.

Conversions to the device

Unauthorized modifications to the device are not permitted and can lead to unforeseeable dangers.

- ▶ If, despite this, modifications are required, consult with Endress+Hauser.

Repair

To ensure continued operational safety and reliability,

- ▶ Carry out repairs on the device only if they are expressly permitted.
- ▶ Observe federal/national regulations pertaining to repair of an electrical device.
- ▶ Use original spare parts and accessories from Endress+Hauser only.

2.5 Product safety

This measuring device is designed in accordance with good engineering practice to meet state-of-the-art safety requirements, has been tested, and left the factory in a condition in which it is safe to operate.

It meets general safety standards and legal requirements. It also complies with the EU directives listed in the device-specific EU Declaration of Conformity. Endress+Hauser confirms this by affixing the CE mark to the device.





2.6 IT security

We only provide a warranty if the device is installed and used as described in the Operating Instructions. The device is equipped with security mechanisms to protect it against any inadvertent changes to the device settings.

IT security measures in line with operators' security standards and designed to provide additional protection for the device and device data transfer must be implemented by the operators themselves.

2.7 Device-specific IT security

The device offers a range of specific functions to support protective measures on the operator's side. These functions can be configured by the user and guarantee greater in-operation safety if used correctly. An overview of the most important functions is provided in the following section.

Function/interface	Factory setting	Recommendation
Write protection via hardware write protection switch →  12	Not enabled.	Individually following risk assessment.
Access code (also applies for Web server login or FieldCare connection) →  13	Not enabled (0000).	Assign an individual access code during commissioning.
WLAN (order option in display module)	Enabled.	Individually following risk assessment.
WLAN security mode	Enabled (WPA2-PSK)	Do not change.
WLAN passphrase (password) →  13	Serial number	Assign an individual access code during commissioning.
WLAN mode	Access Point	Individually following risk assessment.
Web server →  13	Enabled.	Individually following risk assessment.
CDI-RJ45 service interface →  14	–	Individually following risk assessment.

2.7.1 Protecting access via hardware write protection

Write access to the device parameters via the local display, Web browser or operating tool (e.g. FieldCare, DeviceCare) can be disabled via a write protection switch (DIP switch on the motherboard). When hardware write protection is enabled, only read access to the parameters is possible.

Hardware write protection is disabled when the device is delivered →  178.

2.7.2 Protecting access via a password

Different passwords are available to protect write access to the device parameters or access to the device via the WLAN interface.

- **User-specific access code**
Protect write access to the device parameters via the local display, Web browser or operating tool (e.g. FieldCare, DeviceCare). Access authorization is clearly regulated through the use of a user-specific access code.
- **WLAN passphrase**
The network key protects a connection between an operating unit (e.g. notebook or tablet) and the device via the WLAN interface which can be ordered as an option.

User-specific access code

Write access to the device parameters via the local display, Web browser or operating tool (e.g. FieldCare, DeviceCare) can be protected by the modifiable, user-specific access code (→  177).

When the device is delivered, the device does not have an access code and is equivalent to 0000 (open).

WLAN passphrase

A connection between an operating unit (e.g. notebook or tablet) and the device via the WLAN interface (→  92) which can be ordered as an option is protected by the network key. The WLAN authentication of the network key complies with the IEEE 802.11 standard.

When the device is delivered, the network key is pre-defined depending on the device. It can be changed via the **WLAN settings** submenu in the **WLAN passphrase** parameter (→  170).

General notes on the use of passwords

- The access code and network key supplied with the device should be changed during commissioning.
- Follow the general rules for generating a secure password when defining and managing the access code or network key.
- The user is responsible for the management and careful handling of the access code and network key.
- For information on configuring the access code or on what to do if you lose the password, see the "Write protection via access code" section →  177

2.7.3 Access via fieldbus

When communicating via fieldbus, access to the device parameters can be restricted to "Read only" access. The option can be changed in the **Fieldbus writing access** parameter.

This does not affect cyclic measured value transmission to the higher-order system, which is always guaranteed.

 For detailed information, see the "Description of Device Parameters" document pertaining to the device →  263

2.7.4 Access via Web server

The device can be operated and configured via a Web browser with the integrated Web server (→  82). The connection is via the service interface (CDI-RJ45), the connection for EtherNet/IP signal transmission (RJ45 connector) or the WLAN interface.

The Web server is enabled when the device is delivered. The Web server can be disabled if necessary (e.g. after commissioning) via the **Web server functionality** parameter.



The device and status information can be hidden on the login page. This prevents unauthorized access to the information.

 For detailed information, see the "Description of Device Parameters" document pertaining to the device →  263

2.7.5 Access via CDI-RJ45 service interface

The device can be connected to a network via the CDI-RJ45 service interface. Device-specific functions guarantee the secure operation of the device in a network.

It is advisable to take relevant security concepts into consideration, such as those issued by the Federal Office for Information Security. This includes organizational security measures such as the assignment of access authorization as well as technical measures such as network segmentation.

 The device can be integrated in a ring topology. The device is integrated via the terminal connection for signal transmission (output 1) and the connection to the service interface (CDI-RJ45) →  60 or →  51.

3 Product description

The measuring system consists of a transmitter and a sensor. The transmitter and sensor are mounted in physically separate locations. They are interconnected by one connecting cable(s).

3.1 Product design

Two versions of the transmitter are available.

3.1.1 Proline 500 – digital

Signal transmission: digital

Order code for "Integrated ISEM electronics", option **A** "Sensor"

For use in applications not required to meet special requirements due to ambient or operating conditions.

As the electronics are located in the sensor, the device is ideal:
For simple transmitter replacement.

- A standard cable can be used as the connecting cable.
- Not sensitive to external EMC interference.

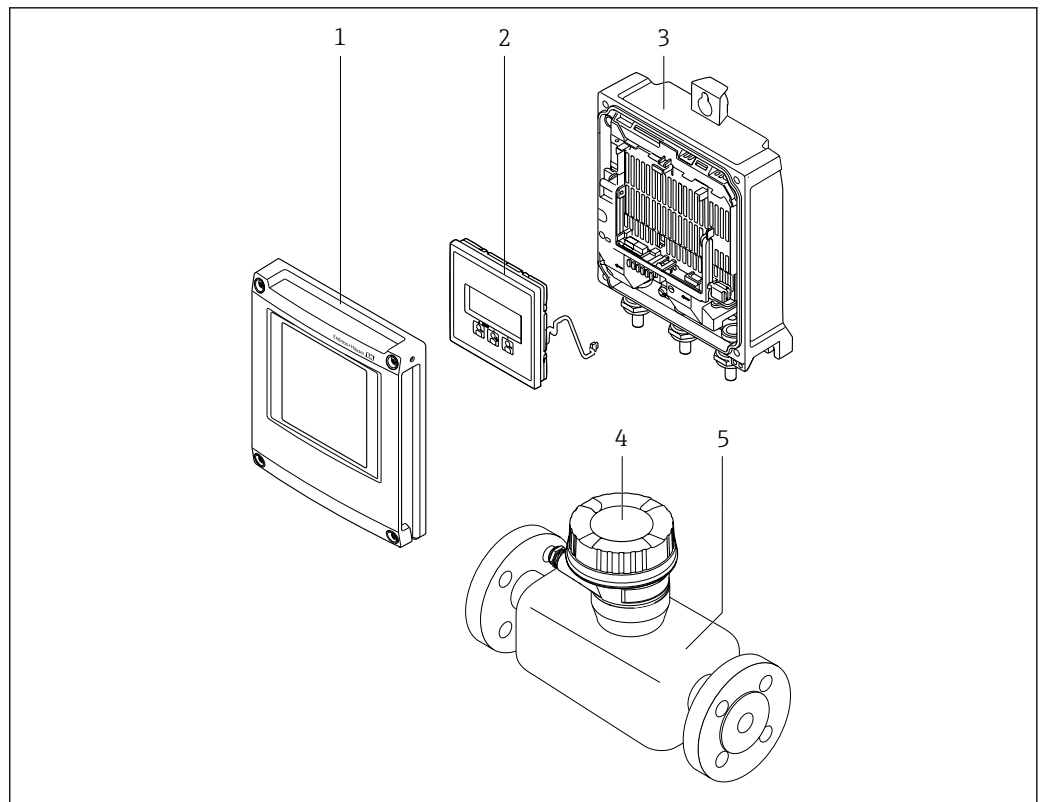

A0029593

1 Important components of a measuring device

- 1 Electronics compartment cover
- 2 Display module
- 3 Transmitter housing
- 4 Sensor connection housing with integrated ISEM electronics: connecting cable connection
- 5 Sensor

3.1.2 Proline 500

Signal transmission: analog

Order code for "Integrated ISEM electronics", option **B** "Transmitter"

For use in applications required to meet special requirements due to ambient or operating conditions.

As the electronics are located in the transmitter, the device is ideal in the event of:

- Strong vibrations at the sensor.
- Sensor operation in underground installations.
- Permanent sensor immersion in water.

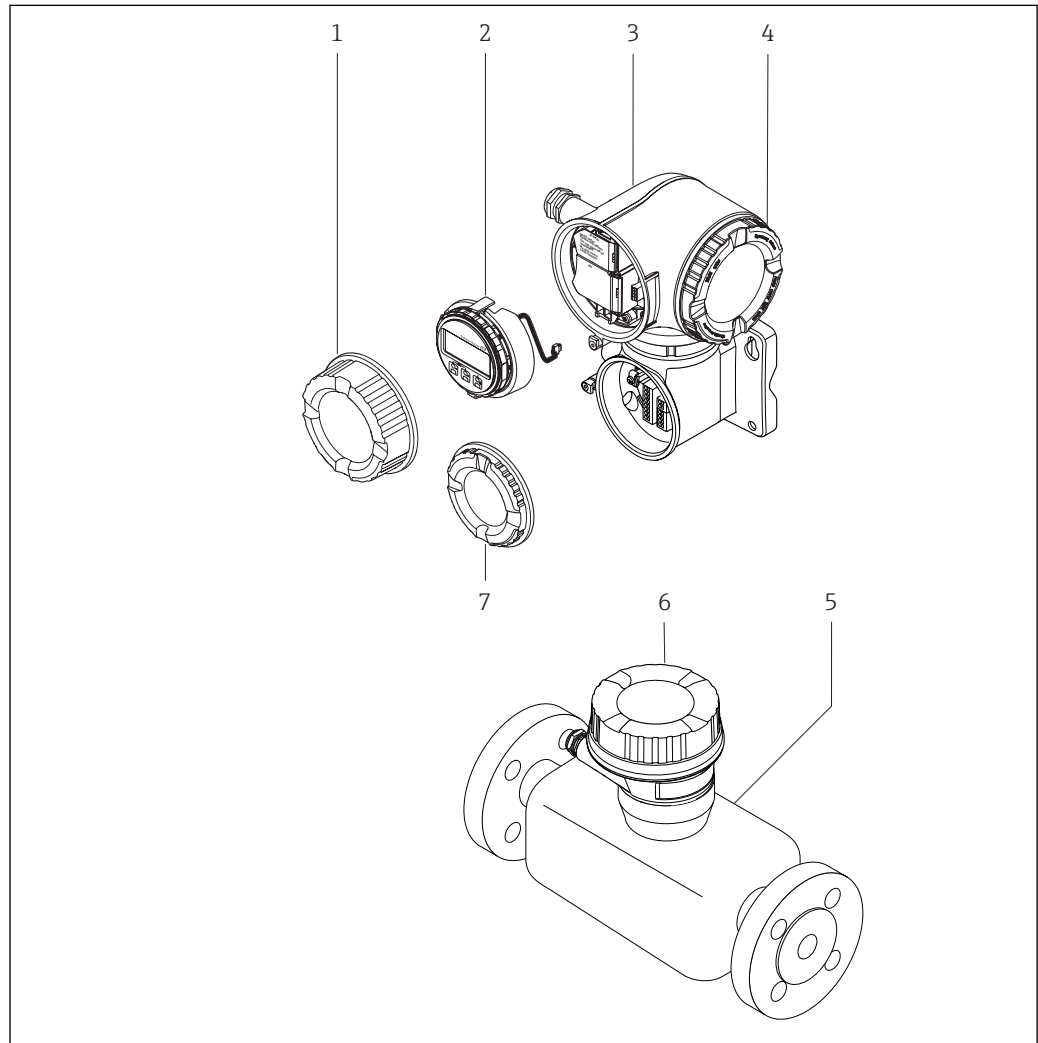

A0029589

2 Important components of a measuring device

- 1 Connection compartment cover
- 2 Display module
- 3 Transmitter housing with integrated ISEM electronics
- 4 Electronics compartment cover
- 5 Sensor
- 6 Sensor connection housing: connecting cable connection
- 7 Connection compartment cover: connecting cable connection

4 Incoming acceptance and product identification

4.1 Incoming acceptance

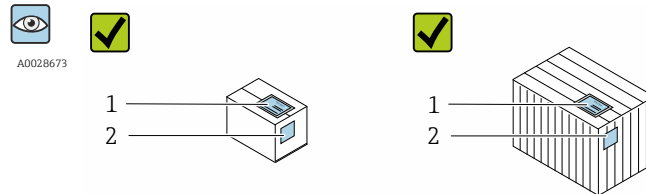

Are the order codes on the delivery note (1) and the product sticker (2) identical?

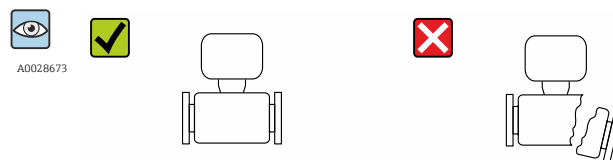
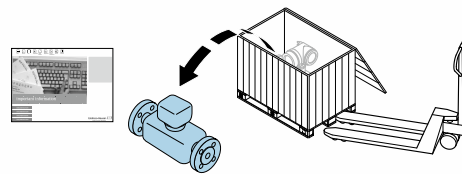

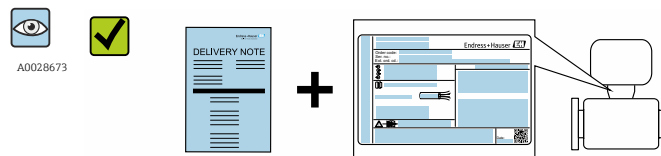

Are the goods undamaged?

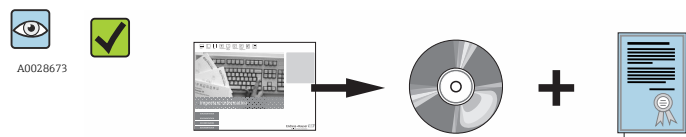

Do the nameplate data match the ordering information on the delivery note?



Is the CD-ROM with the Technical Documentation (depends on device version) and documents present?

-  If one of the conditions is not satisfied, contact your Endress+Hauser Sales Center.
- Depending on the device version, the CD-ROM might not be part of the delivery! The Technical Documentation is available via the Internet or via the *Endress+Hauser Operations App*, see the "Product identification" section →  18.

4.2 Product identification

The following options are available for identification of the measuring device:

- Nameplate specifications
- Order code with breakdown of the device features on the delivery note
- Enter serial numbers from nameplates in *W@M Device Viewer* (www.endress.com/deviceviewer): All information about the measuring device is displayed.
- Enter the serial number from the nameplates into the *Endress+Hauser Operations App* or scan the 2-D matrix code (QR code) on the nameplate with the *Endress+Hauser Operations App*: all the information for the measuring device is displayed.

For an overview of the scope of the associated Technical Documentation, refer to the following:

- The chapters "Additional standard documentation on the device" → 8 and "Supplementary device-dependent documentation" → 8
- The *W@M Device Viewer*: Enter the serial number from the nameplate (www.endress.com/deviceviewer)
- The *Endress+Hauser Operations App*: Enter the serial number from the nameplate or scan the 2-D matrix code (QR code) on the nameplate.

4.2.1 Transmitter nameplate

Proline 500 – digital

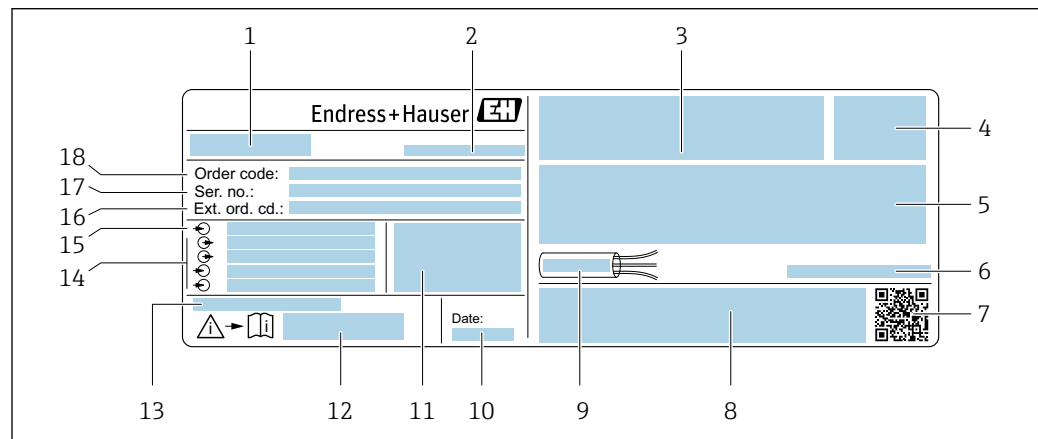

A0029194

3 Example of a transmitter nameplate

- 1 Name of the transmitter
- 2 Manufacturing location
- 3 Space for approvals: use in hazardous areas
- 4 Degree of protection
- 5 Electrical connection data: available inputs and outputs
- 6 Permitted ambient temperature (T_a)
- 7 2-D matrix code
- 8 Space for approvals and certificates: e.g. CE mark, C-Tick
- 9 Permitted temperature range for cable
- 10 Manufacturing date: year-month
- 11 Firmware version (FW) and device revision (Dev.Rev.) from the factory
- 12 Document number of safety-related supplementary documentation
- 13 Space for additional information in the case of special products
- 14 Available inputs and outputs, supply voltage
- 15 Electrical connection data: supply voltage
- 16 Extended order code (Ext. ord. cd.)
- 17 Serial number (ser. no.)
- 18 Order code

Proline 500

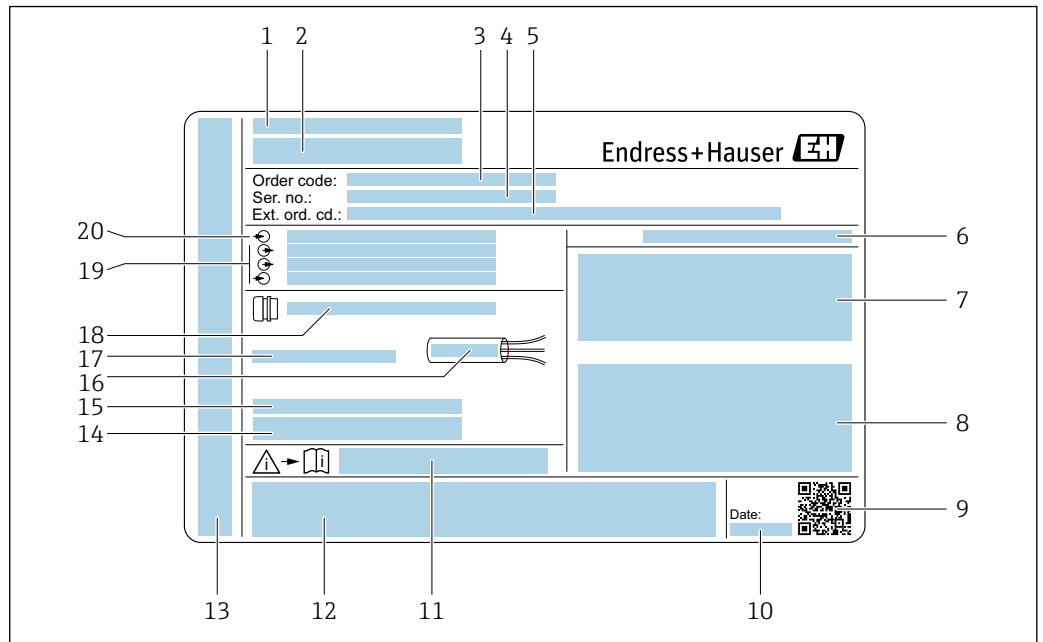

A0029192

4 Example of a transmitter nameplate

- 1 Manufacturing location
- 2 Name of the transmitter
- 3 Order code
- 4 Serial number (ser. no.)
- 5 Extended order code (Ext. ord. cd.)
- 6 Degree of protection
- 7 Space for approvals: use in hazardous areas
- 8 Electrical connection data: available inputs and outputs
- 9 2-D matrix code
- 10 Manufacturing date: year-month
- 11 Document number of safety-related supplementary documentation
- 12 Space for approvals and certificates: e.g. CE mark, C-Tick
- 13 Space for degree of protection of connection and electronics compartment when used in hazardous areas
- 14 Firmware version (FW) and device revision (Dev.Rev.) from the factory
- 15 Space for additional information in the case of special products
- 16 Permitted temperature range for cable
- 17 Permitted ambient temperature (T_a)
- 18 Information on cable gland
- 19 Available inputs and outputs, supply voltage
- 20 Electrical connection data: supply voltage

4.2.2 Sensor nameplate

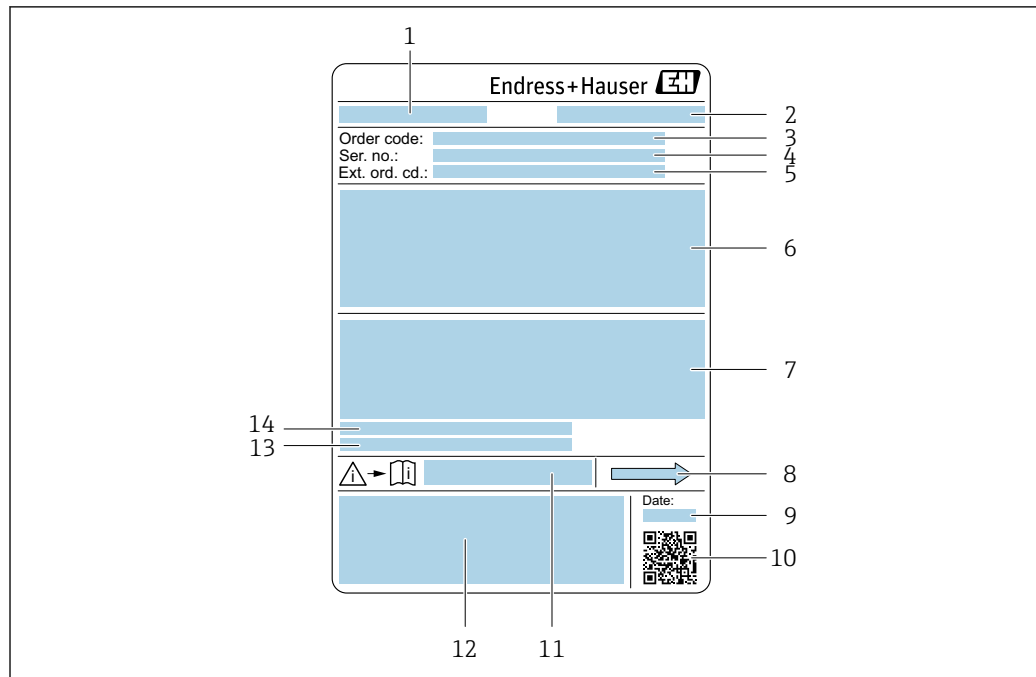

A0029199

5 Example of a sensor nameplate

- 1 Name of the sensor
- 2 Manufacturing location
- 3 Order code
- 4 Serial number (ser. no.)
- 5 Extended order code (Ext. ord. cd.)
- 6 Nominal diameter of the sensor; flange nominal diameter/nominal pressure; sensor test pressure; medium temperature range; material of measuring tube and manifold; sensor-specific information: e.g. pressure range of secondary containment, wide-range density specification (special density calibration)
- 7 Approval information for explosion protection, Pressure Equipment Directive and degree of protection
- 8 Flow direction
- 9 Manufacturing date: year-month
- 10 2-D matrix code
- 11 Document number of safety-related supplementary documentation
- 12 CE mark, C-Tick
- 13 Surface roughness
- 14 Permitted ambient temperature (T_a)





Order code

The measuring device is reordered using the order code.

Extended order code

- The device type (product root) and basic specifications (mandatory features) are always listed.
- Of the optional specifications (optional features), only the safety and approval-related specifications are listed (e.g. LA). If other optional specifications are also ordered, these are indicated collectively using the # placeholder symbol (e.g. #LA#).
- If the ordered optional specifications do not include any safety and approval-related specifications, they are indicated by the + placeholder symbol (e.g. XXXXXX-ABCDE +).

4.2.3 Symbols on measuring device

Symbol	Meaning
	WARNING! This symbol alerts you to a dangerous situation. Failure to avoid this situation can result in serious or fatal injury.
	Reference to documentation Refers to the corresponding device documentation.
	Protective ground connection A terminal which must be connected to ground prior to establishing any other connections.

5 Storage and transport

5.1 Storage conditions

Observe the following notes for storage:

- ▶ Store in the original packaging to ensure protection from shock.
- ▶ Do not remove protective covers or protective caps installed on process connections. They prevent mechanical damage to the sealing surfaces and contamination in the measuring tube.
- ▶ Protect from direct sunlight to avoid unacceptably high surface temperatures.
- ▶ Store in a dry and dust-free place.
- ▶ Do not store outdoors.

Storage temperature →  247

5.2 Transporting the product

Transport the measuring device to the measuring point in the original packaging.

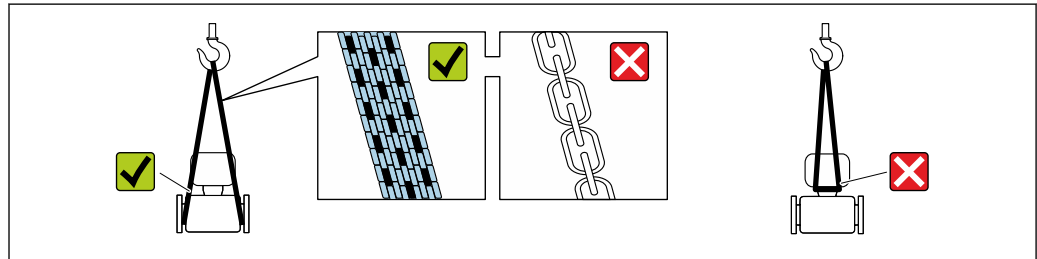

A0029252

-  Do not remove protective covers or caps installed on process connections. They prevent mechanical damage to the sealing surfaces and contamination in the measuring tube.

5.2.1 Measuring devices without lifting lugs

WARNING

Center of gravity of the measuring device is higher than the suspension points of the webbing slings.

Risk of injury if the measuring device slips.

- ▶ Secure the measuring device against slipping or turning.
- ▶ Observe the weight specified on the packaging (stick-on label).

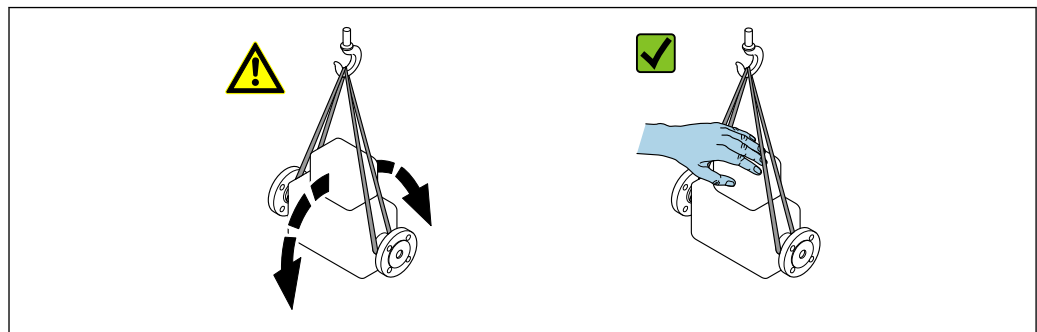

A0029214

5.2.2 Measuring devices with lifting lugs

⚠ CAUTION

Special transportation instructions for devices with lifting lugs

- ▶ Only use the lifting lugs fitted on the device or flanges to transport the device.
- ▶ The device must always be secured at two lifting lugs at least.

5.2.3 Transporting with a fork lift

If transporting in wood crates, the floor structure enables the crates to be lifted lengthwise or at both sides using a forklift.

5.3 Packaging disposal

All packaging materials are environmentally friendly and 100% recyclable:

- Measuring device secondary packaging: polymer stretch film that conforms to EC Directive 2002/95/EC (RoHS).
- Packaging:
 - Wood crate, treated in accordance with ISPM 15 standard, which is confirmed by the affixed IPPC logo.
 - or
 - Carton in accordance with European Packaging Directive 94/62/EC; recyclability is confirmed by the affixed RESY symbol.
- Seaworthy packaging (optional): Wood crate, treated in accordance with ISPM 15 standard, which is confirmed by the affixed IPPC logo.
- Carrying and mounting hardware:
 - Disposable plastic pallet
 - Plastic straps
 - Plastic adhesive strips
- Dunnage: Paper cushion

6 Installation

6.1 Installation conditions

No special measures such as supports are necessary. External forces are absorbed by the construction of the device.

6.1.1 Mounting position

Mounting location

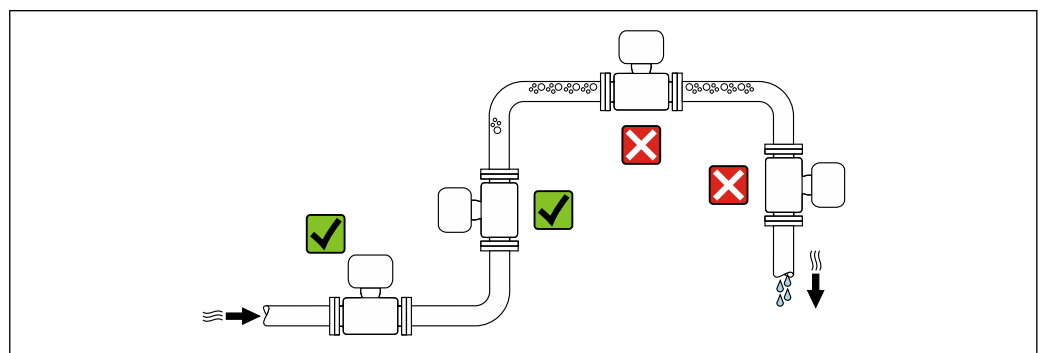

A0028772

To prevent measuring errors arising from accumulation of gas bubbles in the measuring tube, avoid the following mounting locations in the pipe:

- Highest point of a pipeline.
- Directly upstream of a free pipe outlet in a down pipe.

Installation in down pipes

However, the following installation suggestion allows for installation in an open vertical pipeline. Pipe restrictions or the use of an orifice with a smaller cross-section than the nominal diameter prevent the sensor running empty while measurement is in progress.

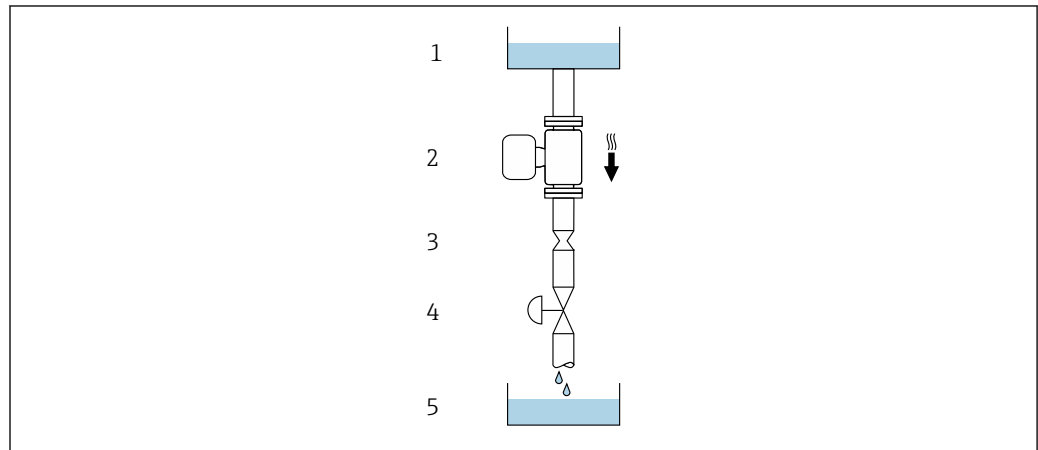

A0028773







■ 6 Installation in a down pipe (e.g. for batching applications)

- 1 Supply tank
- 2 Sensor
- 3 Orifice plate, pipe restriction
- 4 Valve
- 5 Batching tank

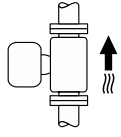
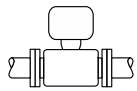
DN		Ø orifice plate, pipe restriction	
[mm]	[in]	[mm]	[in]
8	3/8	6	0.24
15	1/2	10	0.40
25	1	14	0.55
40	1 1/2	22	0.87
50	2	28	1.10
80	3	50	1.97
100	4	65	2.60
150	6	90	3.54
250	10	150	5.91

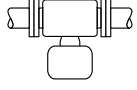
Orientation

The direction of the arrow on the sensor nameplate helps you to install the sensor according to the flow direction (direction of medium flow through the piping).

Orientation		Recommendation
A	Vertical orientation	 A0015591 ✓✓
B	Horizontal orientation, transmitter at top	 A0015589 ✓✓ ¹⁾ Exceptions: →  , 
C	Horizontal orientation, transmitter at bottom	 A0015590 ✓✓ ²⁾ Exceptions: →  , 
D	Horizontal orientation, transmitter at side	 A0015592 ✗

- 1) Applications with low process temperatures may decrease the ambient temperature. To maintain the minimum ambient temperature for the transmitter, this orientation is recommended.
- 2) Applications with high process temperatures may increase the ambient temperature. To maintain the maximum ambient temperature for the transmitter, this orientation is recommended.

If a sensor is installed horizontally with a curved measuring tube, match the position of the sensor to the fluid properties.

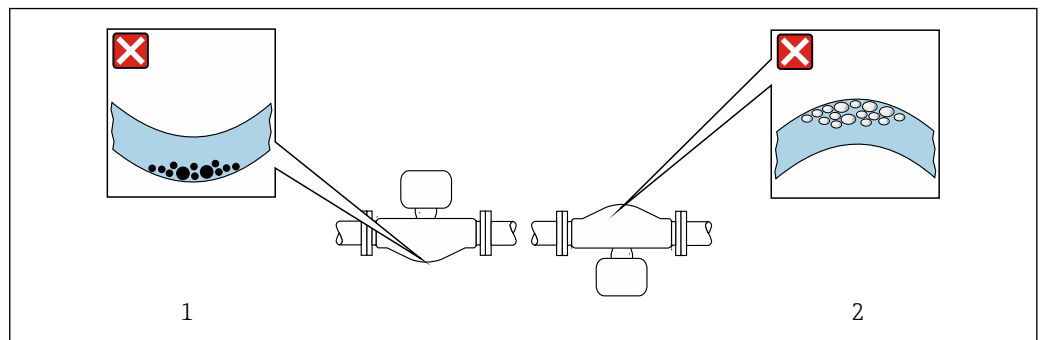

 7 Orientation of sensor with curved measuring tube

- 1 Avoid this orientation for fluids with entrained solids: Risk of solids accumulating.
- 2 Avoid this orientation for outgassing fluids: Risk of gas accumulating.

Inlet and outlet runs

No special precautions need to be taken for fittings which create turbulence, such as valves, elbows or T-pieces, as long as no cavitation occurs →  26.

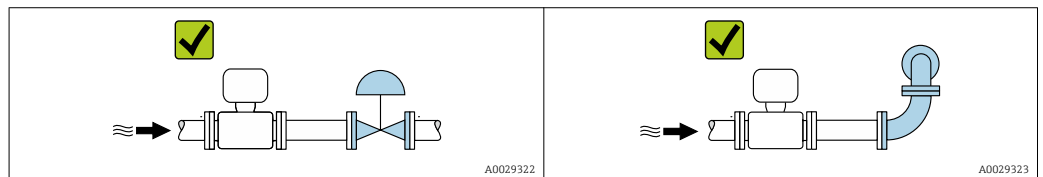



Installation dimensions

 For the dimensions and installation lengths of the device, see the "Technical Information" document, "Mechanical construction" section.

6.1.2 Requirements from environment and process

Ambient temperature range

Measuring device	<ul style="list-style-type: none"> ▪ -40 to +60 °C (-40 to +140 °F) ▪ Order code for "Test, certificate", option JP: -50 to +60 °C (-58 to +140 °F) ▪ Order code for "Test, certificate", option JQ: <ul style="list-style-type: none"> - Sensor: -60 to +60 °C (-76 to +140 °F) - Transmitter: -50 to +60 °C (-58 to +140 °F)
Readability of the local display	-20 to +60 °C (-4 to +140 °F) The readability of the display may be impaired at temperatures outside the temperature range.

 Dependency of ambient temperature on medium temperature →  248

- ▶ If operating outdoors:
Avoid direct sunlight, particularly in warm climatic regions.

 You can order a weather protection cover from Endress+Hauser : →  229

System pressure

It is important that cavitation does not occur, or that gases entrained in the liquids do not outgas.

Cavitation is caused if the pressure drops below the vapor pressure:

- In liquids that have a low boiling point (e.g. hydrocarbons, solvents, liquefied gases)
 - In suction lines
- ▶ Ensure the system pressure is sufficiently high to prevent cavitation and outgassing.

For this reason, the following mounting locations are recommended:

- At the lowest point in a vertical pipe
- Downstream from pumps (no danger of vacuum)

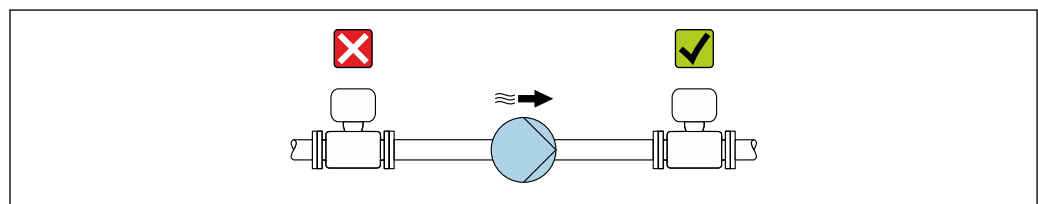

A0028771

Thermal insulation

In the case of some fluids, it is important to keep the heat radiated from the sensor to the transmitter to a low level. A wide range of materials can be used for the required insulation.

The following device versions are recommended for versions with thermal insulation:

- Version with extended neck for insulation:
Order code for "Sensor option", option **CG** with an extended neck length of 105 mm (4.13 in).
- Extended temperature version:
Order code for "Measuring tube material", option **SD, SE, SF** or **TH** with an extended neck length of 105 mm (4.13 in).
- High-temperature version:
Order code for "Measuring tube material", option **TT** or **TU** with an extended neck length of 142 mm (5.59 in).

NOTICE**Electronics overheating on account of thermal insulation!**

- ▶ Recommended orientation: horizontal orientation, sensor connection housing pointing downwards.
- ▶ Do not insulate the sensor connection housing.
- ▶ Maximum permissible temperature at the lower end of the sensor connection housing: 80 °C (176 °F)
- ▶ Thermal insulation with extended neck free: the insulation is omitted around the extended neck. We recommend that you do not insulate the extended neck in order to ensure optimum dissipation of heat.

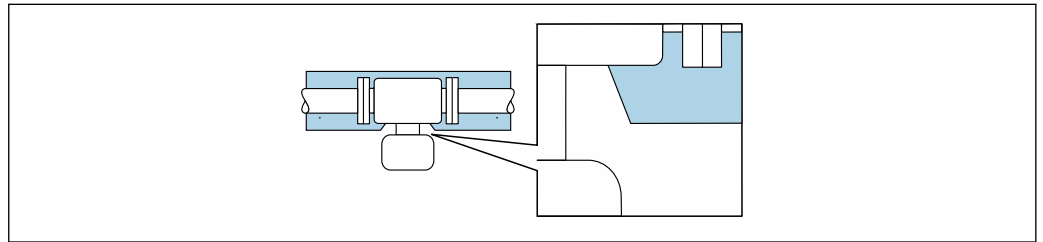

 8 Thermal insulation with extended neck free

-  Low-temperature version: It is generally not necessary to insulate the sensor connection housing. If insulation is provided, the rules that apply are the same as those for thermal insulation.

Heating**NOTICE****Electronics can overheat due to elevated ambient temperature!**

- ▶ Observe maximum permitted ambient temperature for the transmitter .
- ▶ Depending on the fluid temperature, take the device orientation requirements into account .

NOTICE**Danger of overheating when heating**

- ▶ Ensure that the temperature at the lower end of the transmitter housing does not exceed 80 °C (176 °F).
- ▶ Ensure that convection takes place on a sufficiently large scale at the transmitter neck.
- ▶ Ensure that a sufficiently large area of the housing support remains exposed. The uncovered part serves as a radiator and protects the electronics from overheating and excessive cooling.

Heating options

If a fluid requires that no heat loss should occur at the sensor, users can avail of the following heating options:

- Electrical heating, e.g. with electric band heaters
- Via pipes carrying hot water or steam
- Via heating jackets

Using an electrical trace heating system

If heating is regulated via phase angle control or pulse packages, magnetic fields can affect the measured values (= for values that are greater than the values permitted by the EN standard (sine 30 A/m)).

For this reason, the sensor must be magnetically shielded: the housing can be shielded with tin plates or electric sheets without a privileged direction (e.g. V330-35A).

The sheet must have the following properties:

- Relative magnetic permeability $\mu_r \geq 300$
- Plate thickness $d \geq 0.35 \text{ mm}$ ($d \geq 0.014 \text{ in}$)

Vibrations

The high oscillation frequency of the measuring tubes ensures that the correct operation of the measuring system is not influenced by plant vibrations.

6.1.3 Special mounting instructions

Rupture disk

Information that is relevant to the process: → 250.

⚠ WARNING

Limited functional reliability of the rupture disk.

Danger to persons from escaping fluids!

- ▶ Do not remove the rupture disk.
- ▶ When using a rupture disk, do not use a heating jacket.
- ▶ Make sure that the function and operation of the rupture disk is not impeded through the installation of the device.
- ▶ Take precautions to prevent damage and danger to persons if the rupture disk is actuated.
- ▶ Observe information on the rupture disk sticker.

The position of the rupture disk is indicated on a sticker beside it.

The transportation guard must be removed.

For information on the dimensions: see the "Mechanical construction" section

The existing connecting nozzles are not intended for the purpose of rinsing or pressure monitoring, but instead serve as the mounting location for the rupture disk.

In the event of a failure of the rupture disk, a discharge device can be screwed onto the internal thread of the rupture disk in order to drain off any escaping medium.

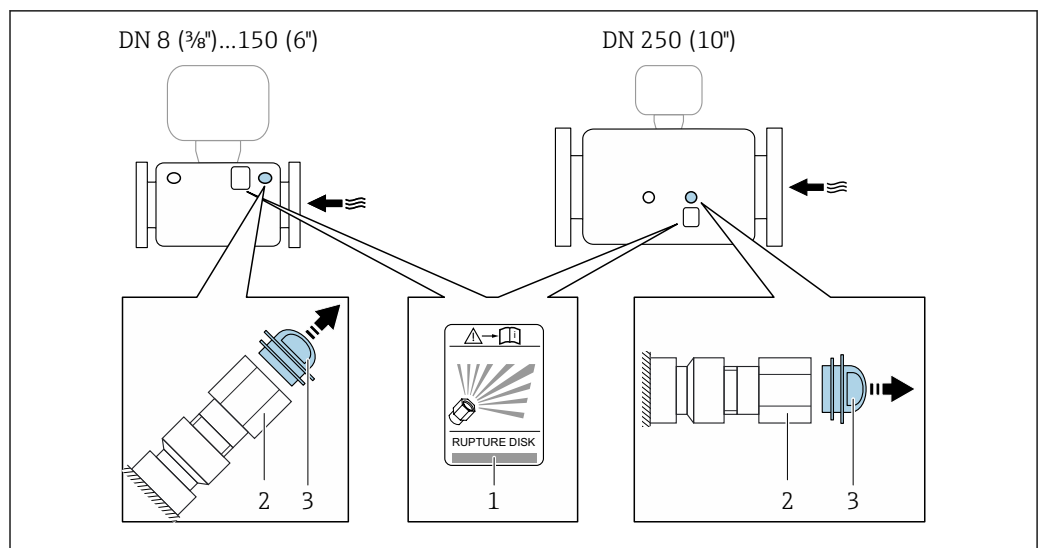

- 1 Rupture disk label
- 2 Rupture disk with 1/2" NPT internal thread with 1" width across flat
- 3 Transport protection

A0028903

Zero point adjustment

All measuring devices are calibrated in accordance with state-of-the-art technology. Calibration takes place under reference conditions → 241. Therefore, a zero point adjustment in the field is generally not required.

Experience shows that zero point adjustment is advisable only in special cases:

- To achieve maximum measuring accuracy even with low flow rates.
- Under extreme process or operating conditions (e.g. very high process temperatures or very high-viscosity fluids).

Protective cover

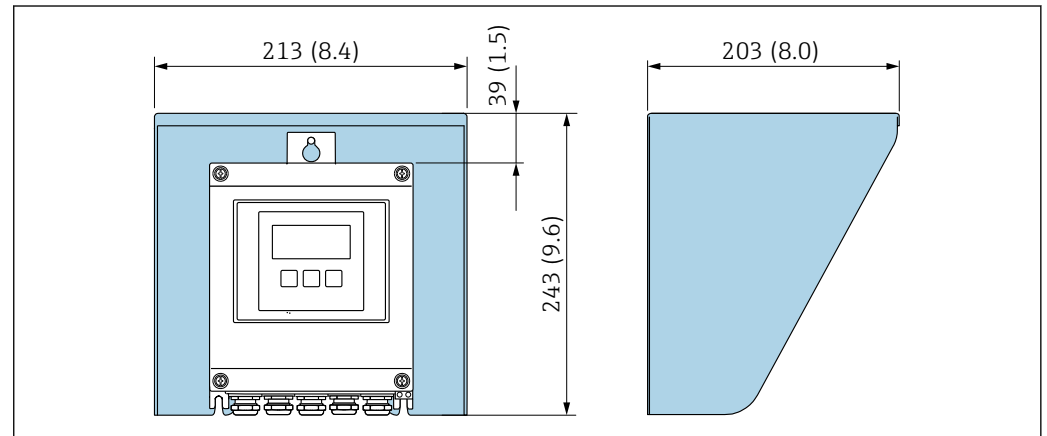

9 Weather protection cover for Proline 500 – digital

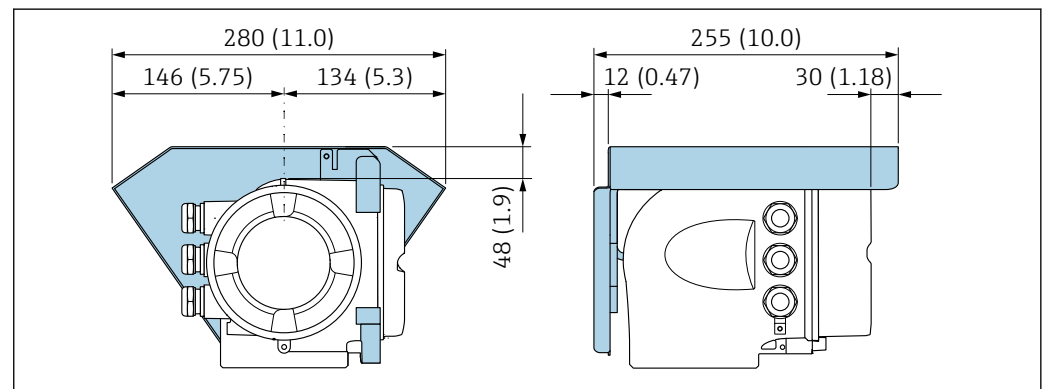

10 Weather protection cover for Proline 500

Cover locking: Proline 500

NOTICE

Order code "Transmitter housing", option L "Cast, stainless": The covers of the transmitter housing are provided with a borehole to lock the cover.

The cover can be locked using screws and a chain or cable provided by the customer.

- ▶ It is recommended to use stainless steel cables or chains.
- ▶ If a protective coating is applied, it is recommended to use a heat shrink tube to protect the housing paint.

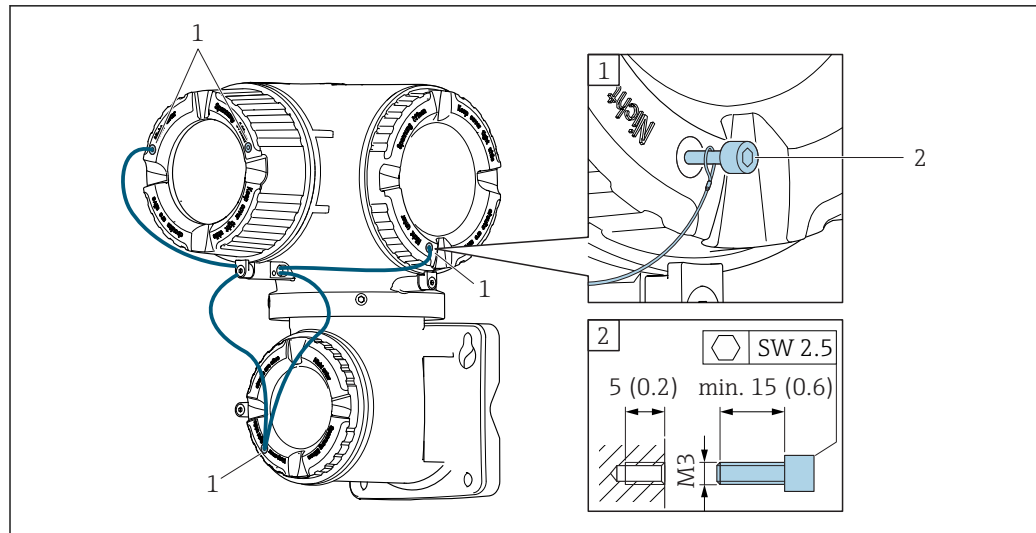

A0029799

- 1 Cover borehole for the securing screw
2 Securing screw to lock the cover

6.2 Mounting the measuring device

6.2.1 Required tools

For transmitter

For mounting on a post:

- Proline 500 – digital transmitter
 - Open-ended wrench AF 10
 - Torx screwdriver TX 25
- Proline 500 transmitter
 - Open-ended wrench AF 13

For wall mounting:

Drill with drill bit \varnothing 6.0 mm

For sensor

For flanges and other process connections: Corresponding mounting tools

6.2.2 Preparing the measuring device

1. Remove all remaining transport packaging.
2. Remove any protective covers or protective caps present from the sensor.
3. Remove stick-on label on the electronics compartment cover.

6.2.3 Mounting the measuring device

⚠ WARNING

Danger due to improper process sealing!

- ▶ Ensure that the inside diameters of the gaskets are greater than or equal to that of the process connections and piping.
- ▶ Ensure that the gaskets are clean and undamaged.
- ▶ Install the gaskets correctly.

1. Ensure that the direction of the arrow on the nameplate of the sensor matches the flow direction of the fluid.

2. Install the measuring device or turn the transmitter housing so that the cable entries do not point upwards.

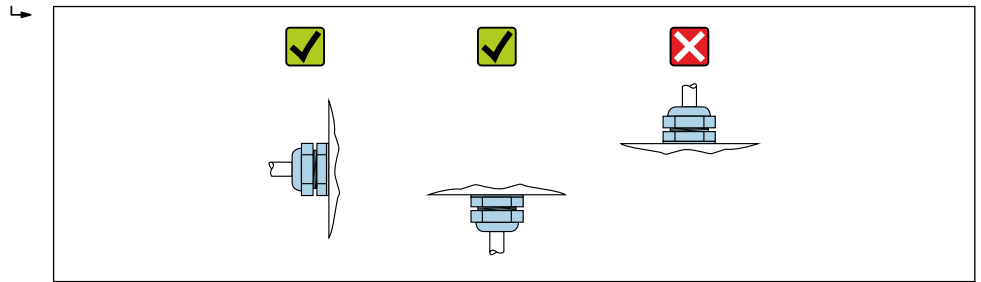

A0029263

6.2.4 Mounting the transmitter housing: Proline 500 – digital

CAUTION

Ambient temperature too high!

Danger of electronics overheating and housing deformation.

- ▶ Do not exceed the permitted maximum ambient temperature .
- ▶ If operating outdoors: Avoid direct sunlight and exposure to weathering, particularly in warm climatic regions.

CAUTION

Excessive force can damage the housing!

- ▶ Avoid excessive mechanical stress.

The transmitter can be mounted in the following ways:

- Post mounting
- Wall mounting

Post mounting

WARNING

Excessive tightening torque applied to the fixing screws!

Risk of damaging the plastic transmitter.

- ▶ Tighten the fixing screws as per the tightening torque: 2 Nm (1.5 lbf ft)

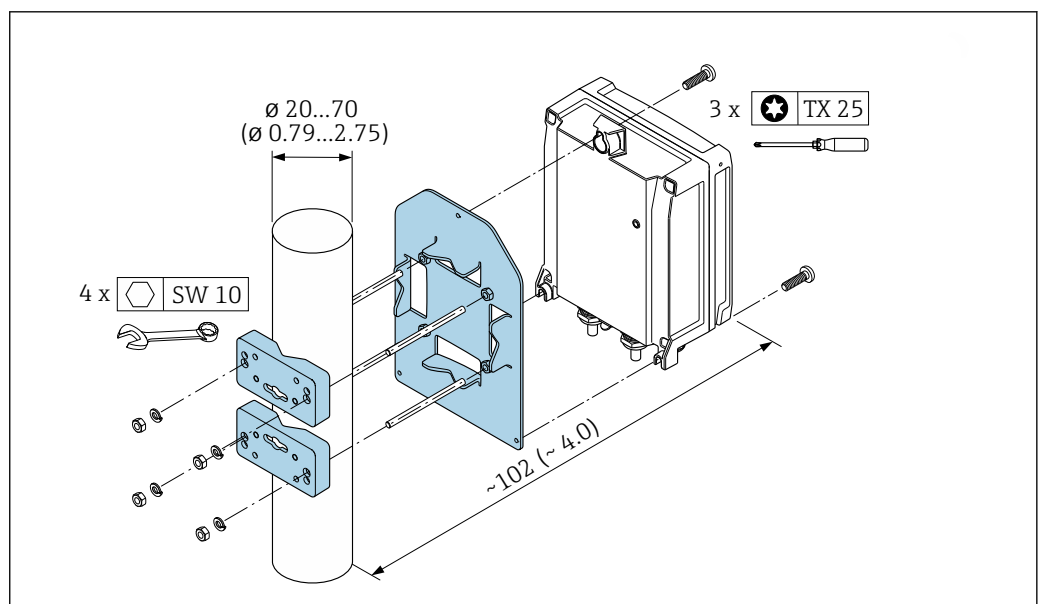

A0029051

11 Engineering unit mm (in)

Wall mounting

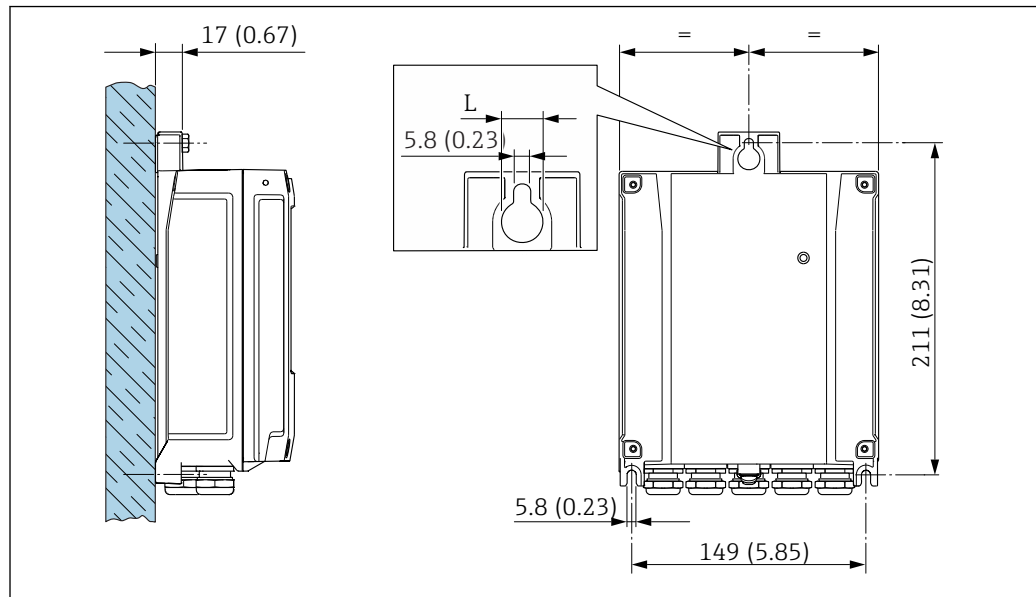

12 Engineering unit mm (in)

L Depends on order code for "Transmitter housing"

Order code for "Transmitter housing"

- Option A, aluminum coated: L = 14 mm (0.55 in)
- Option D, polycarbonate: L = 13 mm (0.51 in)

1. Drill the holes.
2. Insert wall plugs into the drilled holes.
3. Screw in the securing screws slightly at first.
4. Fit the transmitter housing over the securing screws and mount in place.
5. Tighten the securing screws.

6.2.5 Mounting the transmitter housing: Proline 500

⚠ CAUTION

Ambient temperature too high!

Danger of electronics overheating and housing deformation.

- ▶ Do not exceed the permitted maximum ambient temperature .
- ▶ If operating outdoors: Avoid direct sunlight and exposure to weathering, particularly in warm climatic regions.

⚠ CAUTION

Excessive force can damage the housing!

- ▶ Avoid excessive mechanical stress.

The transmitter can be mounted in the following ways:

- Post mounting
- Wall mounting

Wall mounting

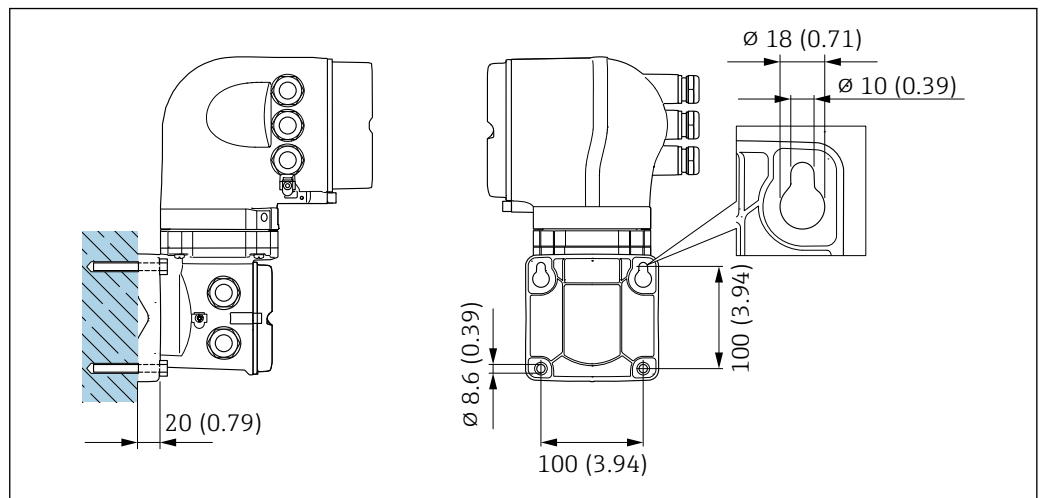

13 Engineering unit mm (in)

1. Drill the holes.
2. Insert wall plugs into the drilled holes.
3. Screw in the securing screws slightly at first.
4. Fit the transmitter housing over the securing screws and mount in place.
5. Tighten the securing screws.

Post mounting

⚠ WARNING

Order code for "Transmitter housing", option L "Cast, stainless": cast transmitters are very heavy.

They are unstable if they are not mounted on a secure, fixed post.

- Only mount the transmitter on a secure, fixed post on a stable surface.

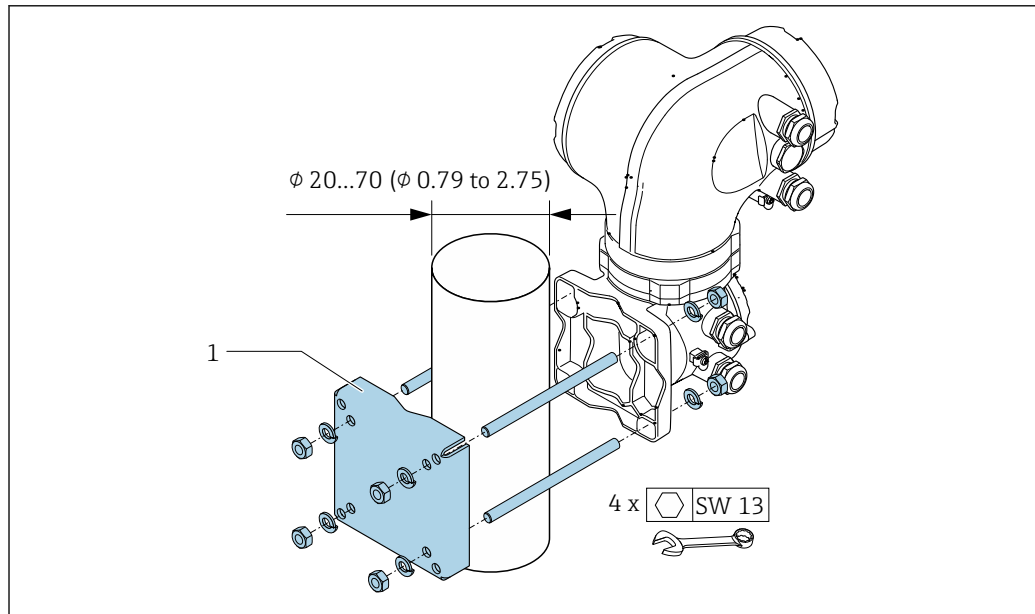

14 Engineering unit mm (in)

6.2.6 Turning the transmitter housing: Proline 500

To provide easier access to the connection compartment or display module, the transmitter housing can be turned.

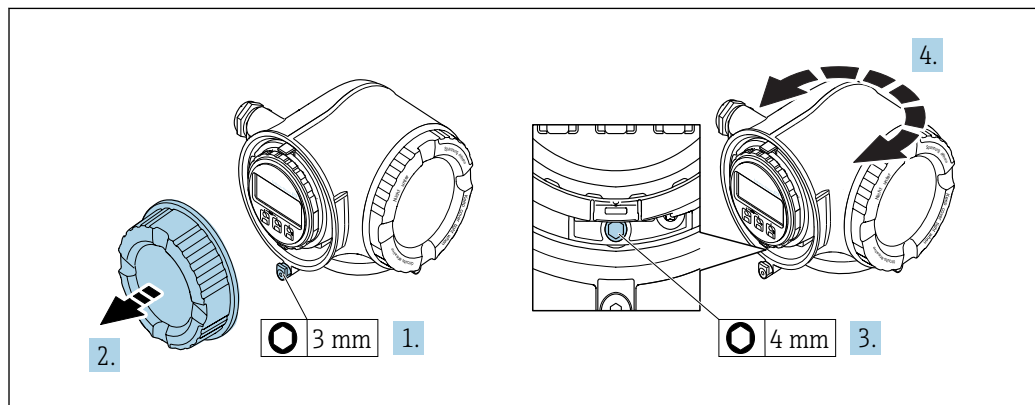

1. Depending on the device version: Loosen the securing clamp of the connection compartment cover.
2. Unscrew the connection compartment cover.
3. Release the fixing screw.
4. Turn the housing to the desired position.
5. Firmly tighten the securing screw.
6. Screw on the connection compartment cover

- 7. Depending on the device version: Attach the securing clamp of the connection compartment cover.

6.2.7 Turning the display module: Proline 500

The display module can be turned to optimize display readability and operability.

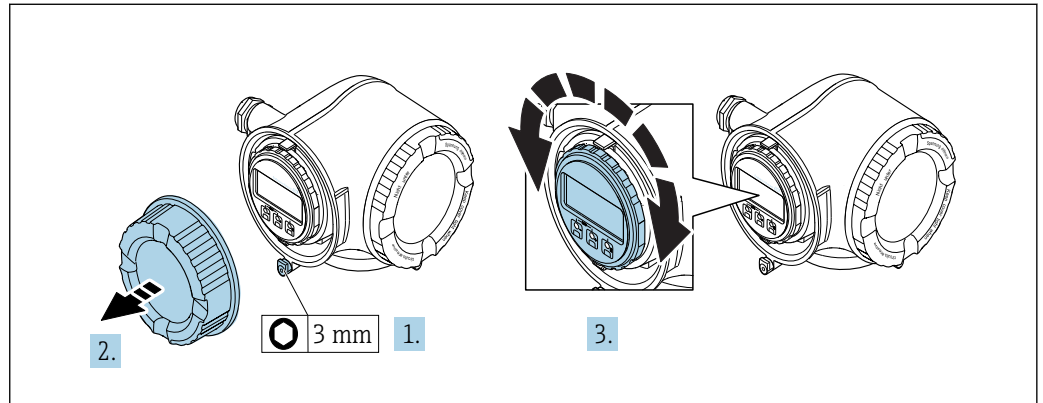

A0030035

- 1. Depending on the device version: Loosen the securing clamp of the connection compartment cover.
- 2. Unscrew the connection compartment cover.
- 3. Turn the display module to the desired position: max. 8 × 45° in each direction.
- 4. Screw on the connection compartment cover.
- 5. Depending on the device version: Attach the securing clamp of the connection compartment cover.

6.3 Post-installation check

Is the device undamaged (visual inspection)?	<input type="checkbox"/>
Does the measuring device conform to the measuring point specifications? For example: <ul style="list-style-type: none"> ▪ Process temperature → 248 ▪ Process pressure (refer to the section on "Pressure-temperature ratings" in the "Technical Information" document) ▪ Ambient temperature ▪ Measuring range 	<input type="checkbox"/>
Has the correct orientation for the sensor been selected ? <ul style="list-style-type: none"> ▪ According to sensor type ▪ According to medium temperature ▪ According to medium properties (outgassing, with entrained solids) 	<input type="checkbox"/>
Does the arrow on the sensor nameplate match the direction of flow of the fluid through the piping → 24?	<input type="checkbox"/>
Are the measuring point identification and labeling correct (visual inspection)?	<input type="checkbox"/>
Is the device adequately protected from precipitation and direct sunlight?	<input type="checkbox"/>
Are the securing screw and securing clamp tightened securely?	<input type="checkbox"/>

7 Electrical connection

NOTICE

The measuring device does not have an internal circuit breaker.

- ▶ For this reason, assign the measuring device a switch or power-circuit breaker so that the power supply line can be easily disconnected from the mains.
- ▶ Although the measuring device is equipped with a fuse, additional overcurrent protection (maximum 10 A) should be integrated into the system installation.

7.1 Connection conditions

7.1.1 Required tools

- For cable entries: Use corresponding tools
- For securing clamp: Allen key 3 mm
- Wire stripper
- When using stranded cables: crimper for wire end ferrule
- For removing cables from terminal: Flat blade screwdriver ≤ 3 mm (0.12 in)

7.1.2 Requirements for connecting cable

The connecting cables provided by the customer must fulfill the following requirements.

Electrical safety

In accordance with applicable federal/national regulations.

Protective ground cable

Cable: 2.1 mm² (14 AWG)

The grounding impedance must be less than 1 Ω .

Permitted temperature range

- The installation guidelines that apply in the country of installation must be observed.
- The cables must be suitable for the minimum and maximum temperatures to be expected.

Power supply cable

Standard installation cable is sufficient.

Signal cable

EtherNet/IP

The standard ANSI/TIA/EIA-568-B.2 Annex specifies CAT 5 as the minimum category for a cable used for EtherNet/IP. CAT 5e and CAT 6 are recommended.



For more information on planning and installing EtherNet/IP networks, please refer to the "Media Planning and Installation Manual. EtherNet/IP" of ODVA Organization

Current output 0/4 to 20 mA

Standard installation cable is sufficient.

Pulse/frequency/switch output

Standard installation cable is sufficient.

Relay output

Standard installation cable is sufficient.

Current input 0/4 to 20 mA

Standard installation cable is sufficient.

Status input

Standard installation cable is sufficient.

Cable diameter

- Cable glands supplied:
M20 × 1.5 with cable Ø 6 to 12 mm (0.24 to 0.47 in)
- Spring-loaded terminals: Suitable for strands and strands with ferrules.
Conductor cross-section 0.2 to 2.5 mm² (24 to 12 AWG).

Choice of connecting cable between the transmitter and sensor

Depends on the type of transmitter and the installation zones

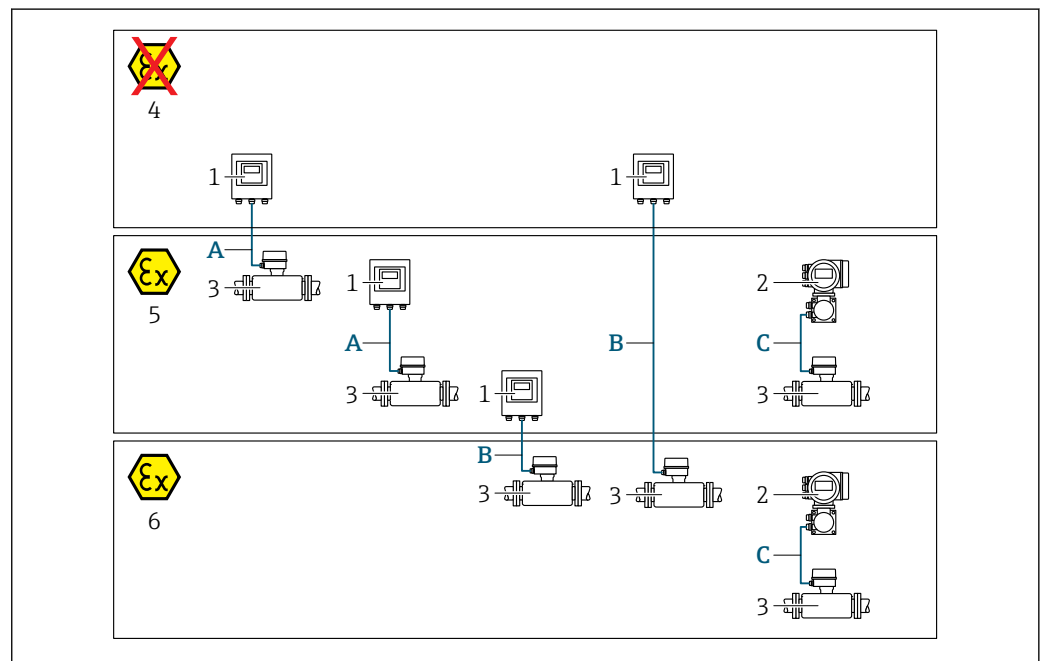

A0032476

- 1 Proline 500 digital transmitter
- 2 Proline 500 transmitter
- 3 Promass sensor
- 4 Non-hazardous area
- 5 Hazardous area: Zone 2; Class I, Division 2
- 6 Hazardous area: Zone 1; Class I, Division 1
- A Standard cable to 500 digital transmitter → 38
Transmitter installed in the non-hazardous area or hazardous area: Zone 2; Class I, Division 2 / sensor installed in the hazardous area: Zone 2; Class I, Division 2
- B Standard cable to 500 digital transmitter → 38
Transmitter installed in the hazardous area: Zone 2; Class I, Division 2 / sensor installed in the hazardous area: Zone 1; Class I, Division 1
- C Signal cable to 500 transmitter → 39
Transmitter and sensor installed in the hazardous area: Zone 2; Class I, Division 2 oder Zone 1; Class I, Division 1

*A: Connecting cable between sensor and transmitter: Proline 500 – digital**Standard cable*

A standard cable with the following specifications can be used as the connecting cable.

Design	4 cores (2 pairs); uninsulated stranded CU wires; pair-stranded with common shield
Shielding	Tin-plated copper-braid, optical cover $\geq 85\%$
Loop resistance	Power supply line (+, -): maximum $10\ \Omega$
Cable length	Maximum 300 m (1000 ft), see the following table.

Cross-section	Cable length [max.]
0.34 mm ² (AWG 22)	80 m (270 ft)
0.50 mm ² (AWG 20)	120 m (400 ft)
0.75 mm ² (AWG 18)	180 m (600 ft)
1.00 mm ² (AWG 17)	240 m (800 ft)
1.50 mm ² (AWG 15)	300 m (1000 ft)

Optionally available connecting cable

Design	2 × 2 × 0.34 mm ² (AWG 22) PVC cable ¹⁾ with common shield (2 pairs, uninsulated stranded CU wires; pair-stranded)
Flame resistance	According to DIN EN 60332-1-2
Oil-resistance	According to DIN EN 60811-2-1
Shielding	Tin-plated copper-braid, optical cover $\geq 85\%$
Operating temperature	When mounted in a fixed position: -50 to $+105\ ^\circ\text{C}$ (-58 to $+221\ ^\circ\text{F}$); when cable can move freely: -25 to $+105\ ^\circ\text{C}$ (-13 to $+221\ ^\circ\text{F}$)
Available cable length	Fixed: 20 m (65 ft); variable: up to maximum 50 m (165 ft)

1) UV radiation can impair the cable outer sheath. Protect the cable from direct sunshine where possible.

*B: Connecting cable between sensor and transmitter: Proline 500 - digital**Standard cable*

A standard cable with the following specifications can be used as the connecting cable.

Design	4, 6, 8 cores (2, 3, 4 pairs); uninsulated stranded CU wires; pair-stranded with common shield
Shielding	Tin-plated copper-braid, optical cover $\geq 85\%$
Capacitance C	Maximum 760 nF IIC, maximum 4.2 μF IIB
Inductance L	Maximum 26 μH IIC, maximum 104 μH IIB
Inductance/resistance ratio (L/R)	Maximum 8.9 $\mu\text{H}/\Omega$ IIC, maximum 35.6 $\mu\text{H}/\Omega$ IIB (e.g. in accordance with IEC 60079-25)
Loop resistance	Power supply line (+, -): maximum $5\ \Omega$
Cable length	Maximum 150 m (500 ft), see the following table.

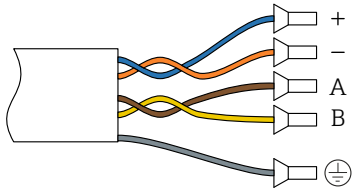
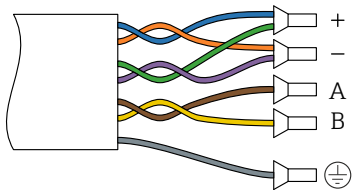
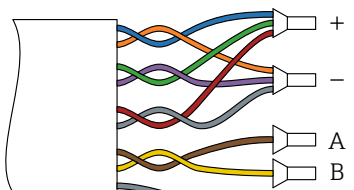
Cross-section	Cable length [max.]	Termination
2 x 2 x 0.50 mm ² (AWG 22)	50 m (165 ft)	2 x 2 x 0.50 mm ² (AWG 22)  <ul style="list-style-type: none">▪ +, - = 0.5 mm²▪ A, B = 0.5 mm²
3 x 2 x 0.50 mm ² (AWG 22)	100 m (330 ft)	3 x 2 x 0.50 mm ² (AWG 22)  <ul style="list-style-type: none">▪ +, - = 1.0 mm²▪ A, B = 0.5 mm²
4 x 2 x 0.50 mm ² (AWG 22)	150 m (500 ft)	4 x 2 x 0.50 mm ² (AWG 22)  <ul style="list-style-type: none">▪ +, - = 1.5 mm²▪ A, B = 0.5 mm²

Optionally available connecting cable

Connecting cable for	Zone 1; Class I, Division 1
Standard cable	2 × 2 × 0.5 mm ² (AWG 20) PVC cable ¹⁾ with common shield (2 pairs, pair-stranded)
Flame resistance	According to DIN EN 60332-1-2
Oil-resistance	According to DIN EN 60811-2-1
Shielding	Tin-plated copper-braid, optical cover ≥ 85 %
Operating temperature	When mounted in a fixed position: -50 to +105 °C (-58 to +221 °F); when cable can move freely: -25 to +105 °C (-13 to +221 °F)
Available cable length	Fixed: 20 m (65 ft); variable: up to maximum 50 m (165 ft)

1) UV radiation can impair the cable outer sheath. Protect the cable from direct sunshine where possible.

C: Connecting cable between sensor and transmitter: Proline 500

Standard cable	6 × 0.38 mm ² PVC cable ¹⁾ with common shield and individually shielded cores
Conductor resistance	≤ 50 Ω/km (0.015 Ω/ft)

Capacitance: core/shield	≤420 pF/m (128 pF/ft)
Cable length (max.)	20 m (65 ft)
Cable lengths (available for order)	5 m (15 ft), 10 m (32 ft), 20 m (65 ft)
Operating temperature	Depends on the device version and how the cable is installed: <ul style="list-style-type: none"> ■ Standard version: <ul style="list-style-type: none"> - Cable - fixed installation: -40 to +105 °C (-40 to +221 °F) - Cable - movable: -25 to +105 °C (-13 to +221 °F) ■ Order code for "Test, certificate", option JP: <ul style="list-style-type: none"> - Cable - fixed installation: -50 to +105 °C (-58 to +221 °F) - Cable - movable: -25 to +105 °C (-13 to +221 °F) ■ Order code for "Test, certificate", option JQ: <ul style="list-style-type: none"> - Cable - fixed installation: -60 to +105 °C (-76 to +221 °F) - Cable - movable: -25 to +105 °C (-13 to +221 °F)

1) UV radiation can impair the cable outer sheath. Protect the cable from direct sunshine where possible.

7.1.3 Terminal assignment

Transmitter: supply voltage, input/outputs



The terminal assignment of the inputs and outputs depends on the individual order version of the device. The device-specific terminal assignment is documented on an adhesive label in the terminal cover.

Supply voltage		Input/output 1	Input/output 2	Input/output 3	Input/output 4
1 (+)	2 (-)	EtherNet/IP (RJ45 Stecker)	24 (+) 25 (-)	22 (+) 23 (-)	20 (+) 21 (-)
Device-specific terminal assignment: adhesive label in terminal cover.					

Transmitter and sensor connection housing: connecting cable

The sensor and transmitter, which are mounted in separate locations, are interconnected by a connecting cable. The cable is connected via the sensor connection housing and the transmitter housing.

Terminal assignment and connection of the connecting cable:

- Proline 500 – digital →  42
- Proline 500 →  52

7.1.4 Device plugs available

 Device plugs may not be used in hazardous areas!

Order code for "Input; output 1", option NA "EtherNet/IP"

Order code for "Electrical connection"	Cable entry/connection	
	2	3
L, N, P, U	Connector M12 × 1	-
R ^{1) 2)} , S ^{1) 2)} , T ^{1) 2)} , V ^{1) 2)}	Connector M12 × 1	Connector M12 × 1

- 1) Cannot be combined with an external WLAN antenna (order code for "Enclosed accessories", option P8) of an RJ45 M12 adapter for the service interface (order code for "Accessories mounted", option NB) or of the remote display and operating module DKX001
- 2) Suitable for integrating the device in a ring topology.

7.1.5 Pin assignment of device plug

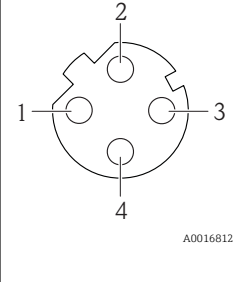
	Pin		Assignment	
	1	+	Tx	
	2	+	Rx	
	3	-	Tx	
	4	-	Rx	
Coding		Plug/socket		
D		Socket		

7.1.6 Preparing the measuring device

Carry out the steps in the following order:

1. Mount the sensor and transmitter.
2. Connection housing, sensor: Connect connecting cable.
3. Transmitter: Connect connecting cable.
4. Transmitter: Connect signal cable and cable for supply voltage.

NOTICE

Insufficient sealing of the housing!

Operational reliability of the measuring device could be compromised.

- Use suitable cable glands corresponding to the degree of protection.

1. Remove dummy plug if present.
2. If the measuring device is supplied without cable glands:
Provide suitable cable gland for corresponding connecting cable.
3. If the measuring device is supplied with cable glands:
Observe requirements for connecting cables →  36.

7.2 Connecting the measuring device: Proline 500 - digital

NOTICE

Limitation of electrical safety due to incorrect connection!

- ▶ Have electrical connection work carried out by appropriately trained specialists only.
- ▶ Observe applicable federal/national installation codes and regulations.
- ▶ Comply with local workplace safety regulations.
- ▶ Always connect the protective ground cable ⊕ before connecting additional cables.
- ▶ For use in potentially explosive atmospheres, observe the information in the device-specific Ex documentation.

7.2.1 Connecting the connecting cable

⚠ WARNING

Risk of damaging the electronic components!

- ▶ Connect the sensor and transmitter to the same potential equalization.
- ▶ Only connect the sensor to a transmitter with the same serial number.
- ▶ Ground the connection housing of the sensor via the external screw terminal.

Connecting cable terminal assignment

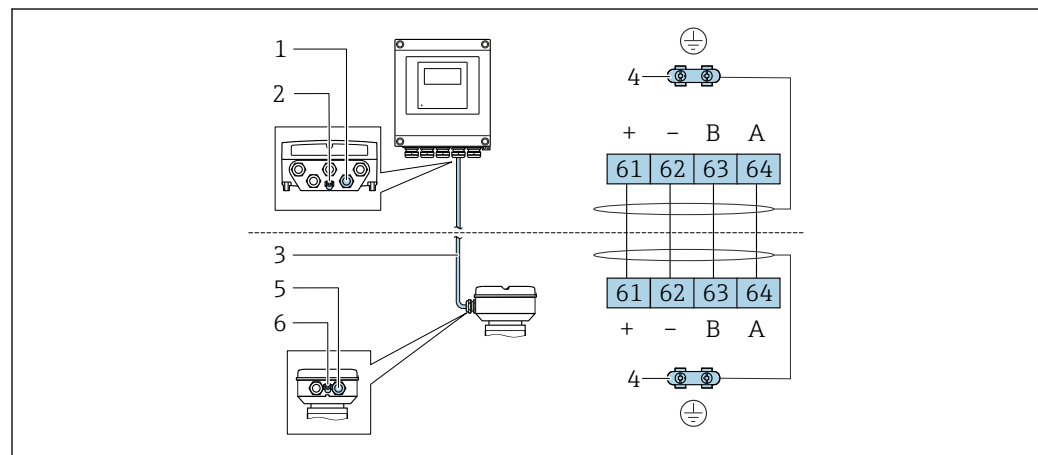

A0028198

- 1 Cable entry for cable on transmitter housing
- 2 Protective earth (PE)
- 3 Connecting cable ISEM communication
- 4 Grounding via ground connection; on device plug versions grounding is through the plug itself
- 5 Cable entry for cable or connection of device plug on sensor connection housing
- 6 Protective earth (PE)

Connecting the connecting cable to the sensor connection housing

- Connection via terminals with order code for "Sensor connection housing":
 - Option **A** "Aluminum, coated" → 43
 - Option **B** "Stainless" → 44
 - Option **L** "Cast, stainless" → 43
- Connection via connectors with order code for "Sensor connection housing":
 - Option **C** "Ultra-compact hygienic, stainless" → 45

Connecting the connecting cable to the transmitter

The cable is connected to the transmitter via terminals → 46.

Connecting the sensor connection housing via terminals

For the device version with the order code for "Sensor connection housing":

- Option **A** "Aluminum coated"
- Option **L** "Cast, stainless"

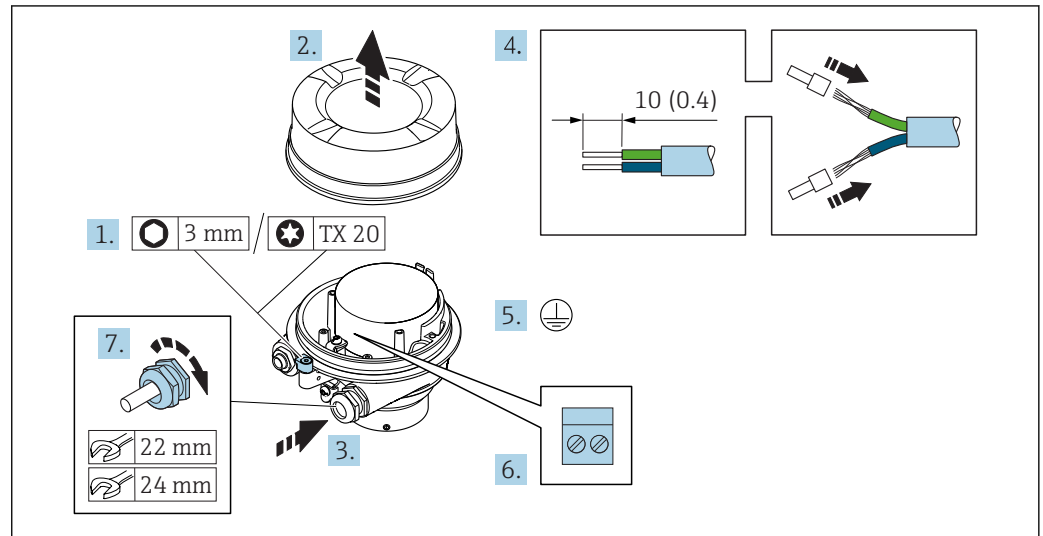

A0029616

1. Loosen the securing clamp of the housing cover.
2. Unscrew the housing cover.
3. Push the cable through the cable entry . To ensure tight sealing, do not remove the sealing ring from the cable entry.
4. Strip the cable and cable ends. In the case of stranded cables, fit ferrules.
5. Connect the protective ground.
6. Connect the cable in accordance with the connecting cable terminal assignment.
7. Firmly tighten the cable glands.
 - ↳ This concludes the process for connecting the connecting cable.

⚠ WARNING

Housing degree of protection voided due to insufficient sealing of the housing.

- ▶ Screw in the thread on the cover without using any lubricant. The thread on the cover is coated with a dry lubricant.

8. Screw on the housing cover.
9. Tighten the securing clamp of the housing cover.

Connecting the sensor connection housing via terminals

For the device version with the order code for "Sensor connection housing":
Option B "Stainless"

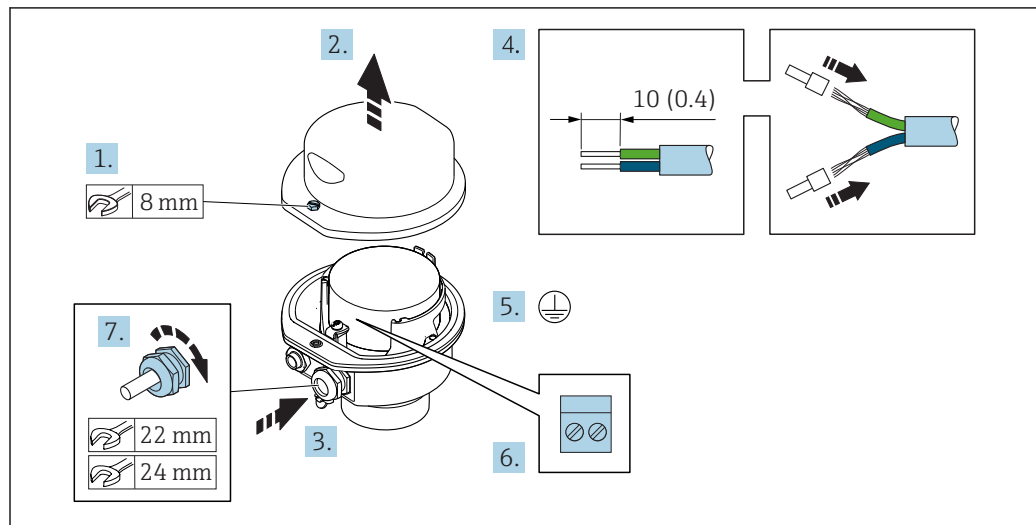

A0029613

1. Release the securing screw of the housing cover.
2. Open the housing cover.
3. Push the cable through the cable entry . To ensure tight sealing, do not remove the sealing ring from the cable entry.
4. Strip the cable and cable ends. In the case of stranded cables, fit ferrules.
5. Connect the protective ground.
6. Connect the cable in accordance with the connecting cable terminal assignment.
7. Firmly tighten the cable glands.
 - ↳ This concludes the process for connecting the connecting cable.
8. Close the housing cover.
9. Tighten the securing screw of the housing cover.

Connecting the sensor connection housing via the connector

For the device version with the order code for "Sensor connection housing":
Option C "Ultra-compact hygienic, stainless"

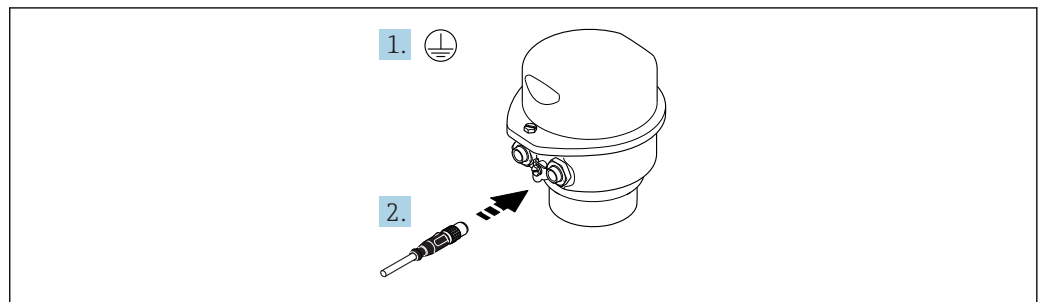

A0029615

1. Connect the protective ground.
2. Connect the connector.

Connecting the connecting cable to the transmitter

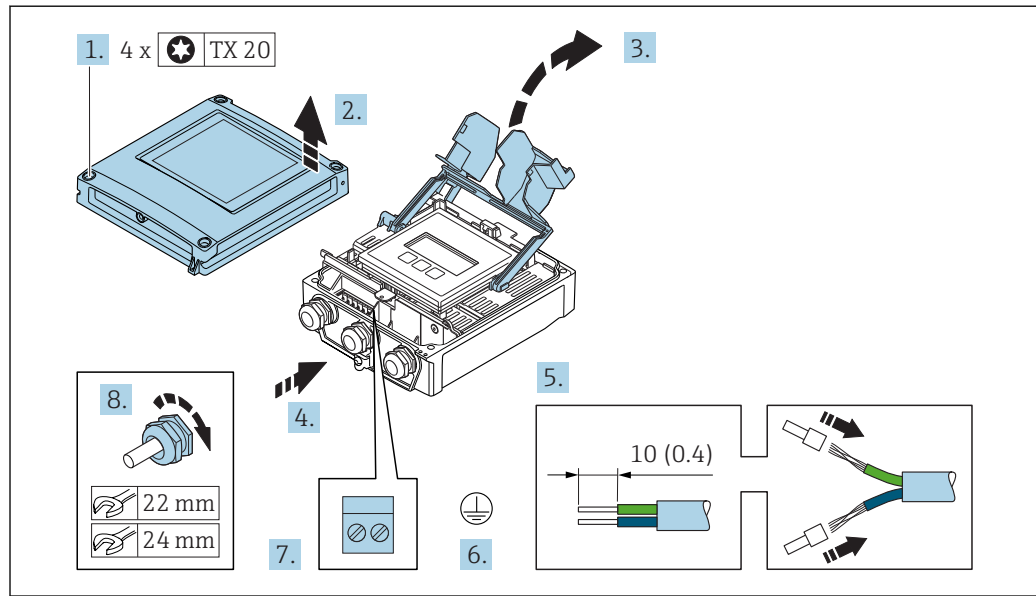

A0029597

- Loosen the 4 fixing screws on the housing cover.
- Open the housing cover.
- Fold open the terminal cover.
- Push the cable through the cable entry . To ensure tight sealing, do not remove the sealing ring from the cable entry.
- Strip the cable and cable ends. In the case of stranded cables, fit ferrules.
- Connect the protective ground.
- Connect the cable in accordance with the connecting cable terminal assignment → 42.
- Firmly tighten the cable glands.
 - ↳ This concludes the process for connecting the connecting cable.
- Close the housing cover.
- Tighten the securing screw of the housing cover.
- After connecting the connecting cable:
 - Connect the signal cable and the supply voltage cable → 47.

7.2.2 Connecting the transmitter

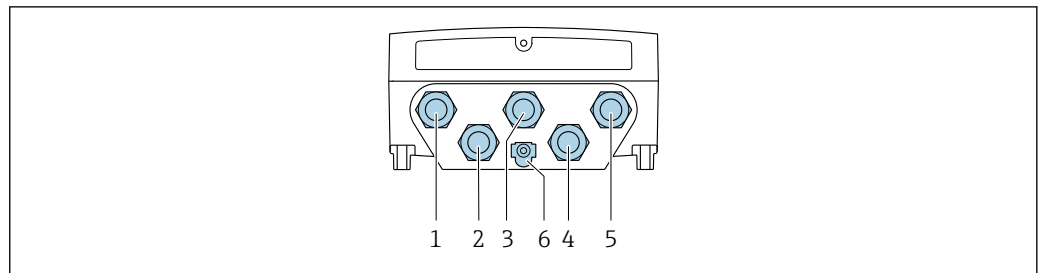

A0028200

- 1 Terminal connection for supply voltage
- 2 Terminal connection for signal transmission, input/output
- 3 Terminal connection for signal transmission, input/output
- 4 Terminal connection for connecting cable between sensor and transmitter
- 5 Terminal connection for signal transmission, input/output or terminal connection for network connection (DHCP client) via service interface (CDI-RJ45); optional: connection for external WLAN antenna
- 6 Protective earth (PE)

i In addition to connecting the device via EtherNet/IP and the available inputs/outputs, additional connection options are also available:

- Integrate into a network via the service interface (CDI-RJ45) → 50.
- Integrate the device into a ring topology → 51.

Connecting the EtherNet/IP connector

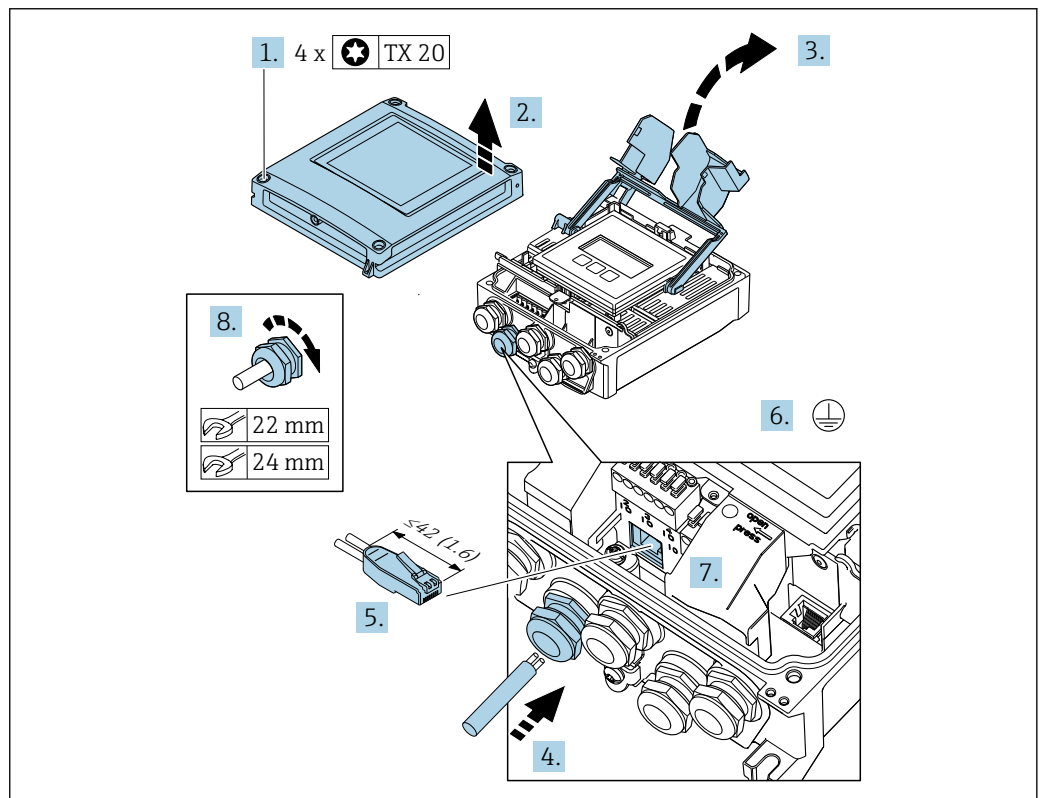

A0033987

1. Loosen the 4 fixing screws on the housing cover.
2. Open the housing cover.
3. Fold open the terminal cover.
4. Push the cable through the cable entry. To ensure tight sealing, do not remove the sealing ring from the cable entry.
5. Strip the cable and cable ends and connect to the RJ45 connector.

6. Connect the protective ground.
7. Plug in the RJ45 connector.
8. Firmly tighten the cable glands.
 - ↳ This concludes the EtherNet/IP connection process.

Connecting the supply voltage and additional inputs/outputs

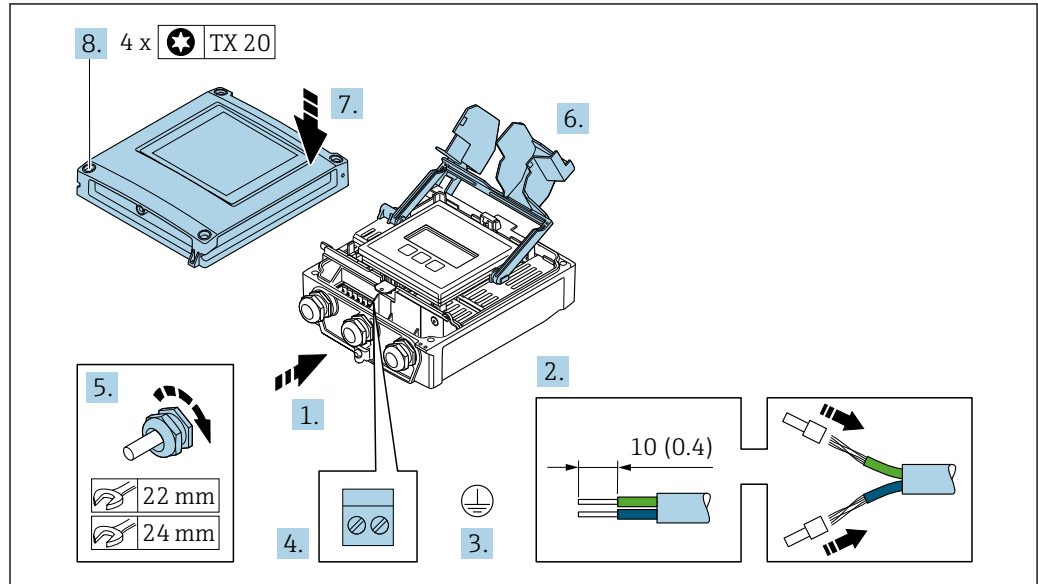

1. Push the cable through the cable entry . To ensure tight sealing, do not remove the sealing ring from the cable entry.
2. Strip the cable and cable ends. In the case of stranded cables, fit ferrules.
3. Connect the protective ground.
4. Connect the cable in accordance with the terminal assignment .
 - ↳ **Signal cable terminal assignment:** The device-specific terminal assignment is documented on an adhesive label in the terminal cover.
 - Supply voltage terminal assignment:** Adhesive label in the terminal cover or → 40.
5. Firmly tighten the cable glands.
 - ↳ This concludes the cable connection process.
6. Close the terminal cover.
7. Close the housing cover.

⚠ WARNING

Housing degree of protection may be voided due to insufficient sealing of the housing.

- ▶ Screw in the screw without using any lubricant.

⚠ WARNING

Excessive tightening torque applied to the fixing screws!

Risk of damaging the plastic transmitter.

- ▶ Tighten the fixing screws as per the tightening torque: 2 Nm (1.5 lbf ft)

8. Tighten the 4 fixing screws on the housing cover.

Removing a cable

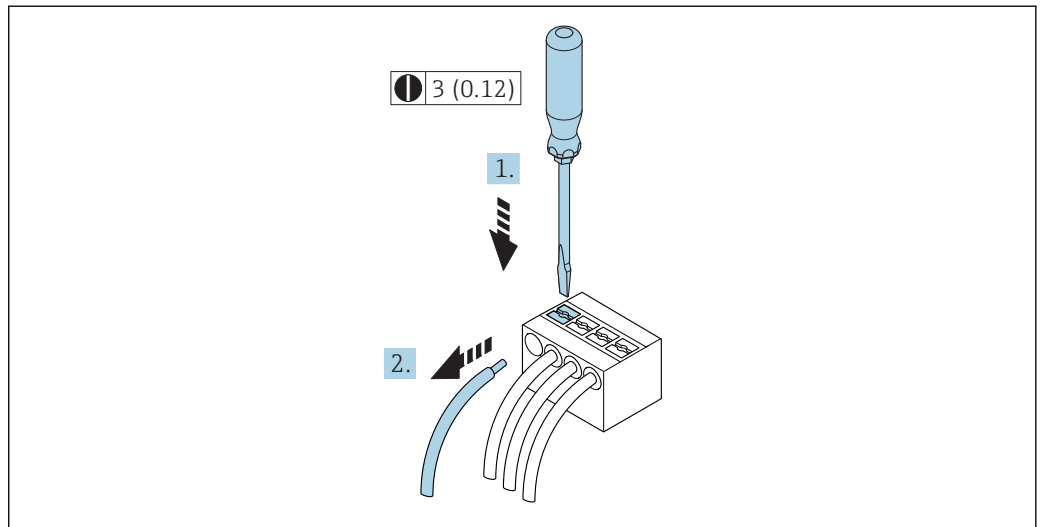

15 Engineering unit mm (in)

A0029598

1. To remove a cable from the terminal, use a flat-blade screwdriver to push the slot between the two terminal holes
2. while simultaneously pulling the cable end out of the terminal.

7.2.3 Integrating the transmitter into a network

This section only presents the basic options for integrating the device into a network.

For information on the procedure to follow to connect the transmitter correctly →  42.

Integrating via the service interface

The device is integrated via the connection to the service interface (CDI-RJ45).

Note the following when connecting:

- Recommended cable: CAT5e, CAT6 or CAT7, with shielded connector
- Maximum cable thickness: 6 mm
- Length of connector including bend protection: 42 mm
- Bending radius: 5 x cable thickness

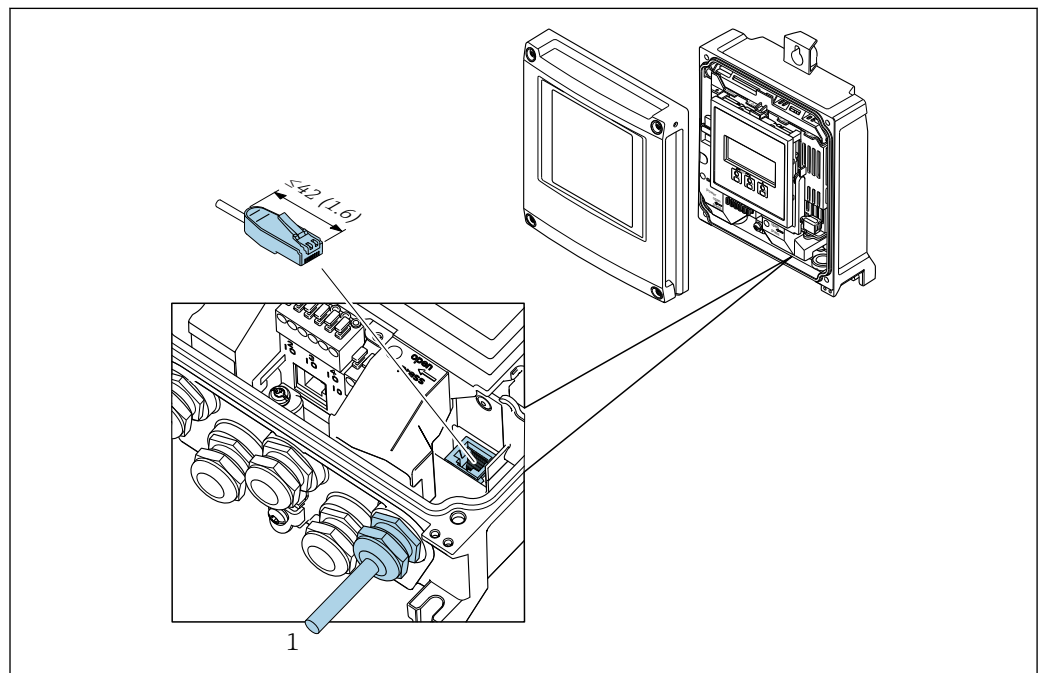

1 Service interface (CDI-RJ45)

 An adapter for RJ45 and the M12 connector is optionally available:
Order code for "Accessories", option **NB**: "Adapter RJ45 M12 (service interface)"

The adapter connects the service interface (CDI-RJ45) to an M12 connector mounted in the cable entry. Therefore the connection to the service interface can be established via an M12 connector without opening the device.

Integrating into a ring topology

The device is integrated via the terminal connection for signal transmission (output 1) and the connection to the service interface (CDI-RJ45).

Note the following when connecting:

- Recommended cable: CAT5e, CAT6 or CAT7, with shielded connector
- Maximum cable thickness: 6 mm
- Length of connector including bend protection: 42 mm
- Bending radius: 2.5 x cable thickness

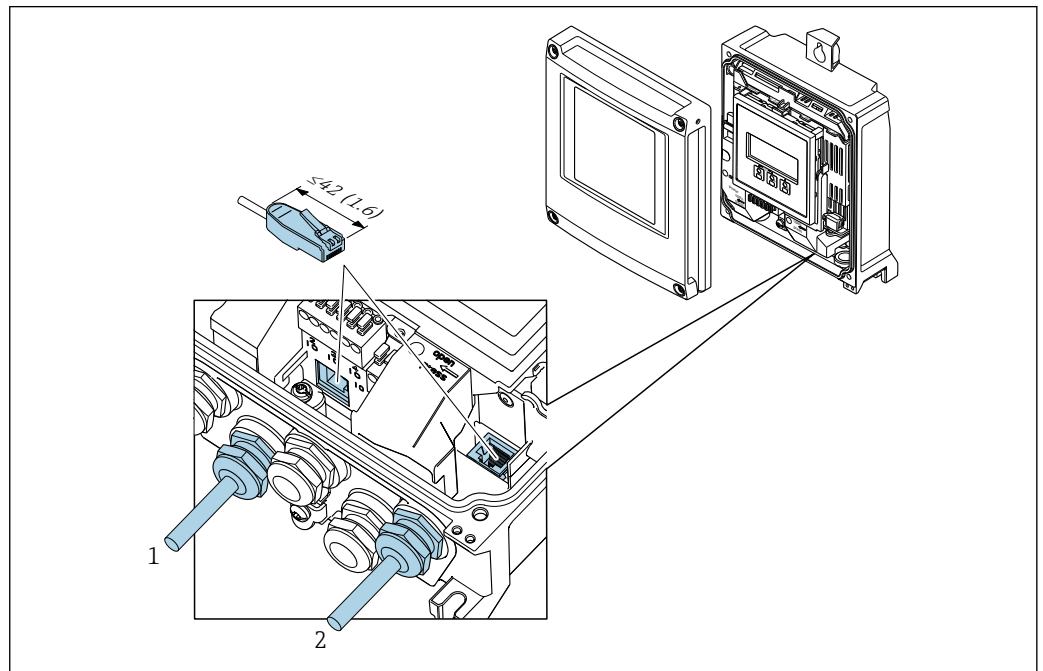

A0033830

- 1 EtherNet/IP connection
2 Service interface (CDI-RJ45)

i An adapter for RJ45 and the M12 connector is optionally available:
Order code for "Accessories", option **NB**: "Adapter RJ45 M12 (service interface)"

The adapter connects the service interface (CDI-RJ45) to an M12 connector mounted in the cable entry. Therefore the connection to the service interface can be established via an M12 connector without opening the device.

7.3 Connecting the measuring device: Proline 500

NOTICE

Limitation of electrical safety due to incorrect connection!

- ▶ Have electrical connection work carried out by appropriately trained specialists only.
- ▶ Observe applicable federal/national installation codes and regulations.
- ▶ Comply with local workplace safety regulations.
- ▶ Always connect the protective ground cable ⊕ before connecting additional cables.
- ▶ For use in potentially explosive atmospheres, observe the information in the device-specific Ex documentation.

7.3.1 Connecting the connecting cable

⚠ WARNING

Risk of damaging the electronic components!

- ▶ Connect the sensor and transmitter to the same potential equalization.
- ▶ Only connect the sensor to a transmitter with the same serial number.
- ▶ Ground the connection housing of the sensor via the external screw terminal.

Connecting cable terminal assignment

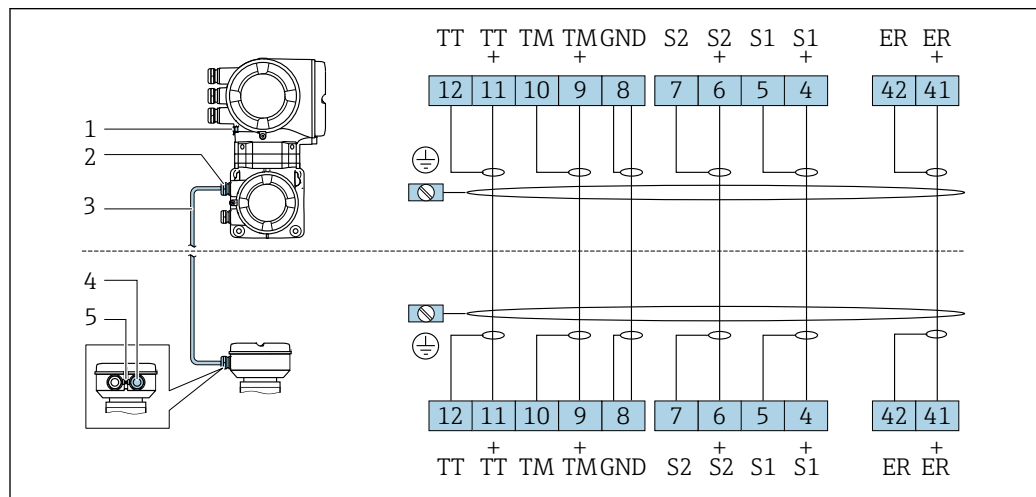

A0028197

- 1 Protective earth (PE)
- 2 Cable entry for connecting cable on transmitter connection housing
- 3 Connecting cable
- 4 Cable entry for connecting cable on sensor connection housing
- 5 Protective earth (PE)

Connecting the connecting cable to the sensor connection housing

Connection via terminals with order code for "Housing":

- Option **B** "Stainless" → 54
- Option **L** "Cast, stainless" → 53

Connecting the connecting cable to the transmitter

The cable is connected to the transmitter via terminals → 55.

Connecting the sensor connection housing via terminals

For the device version with the order code for "Housing":
Option L "Cast, stainless"

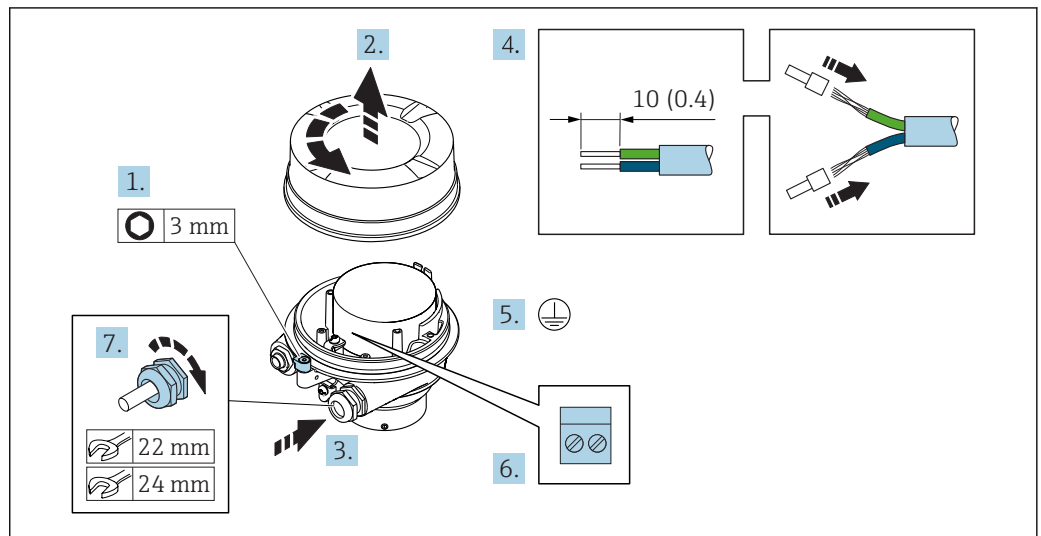

A0029612

1. Loosen the securing clamp of the housing cover.
2. Unscrew the housing cover.
3. Push the cable through the cable entry . To ensure tight sealing, do not remove the sealing ring from the cable entry.
4. Strip the cable and cable ends. In the case of stranded cables, fit ferrules.
5. Connect the protective ground.
6. Connect the cable in accordance with the connecting cable terminal assignment.
7. Firmly tighten the cable glands.
 - ↳ This concludes the process for connecting the connecting cable.

⚠ WARNING

Housing degree of protection voided due to insufficient sealing of the housing.

- ▶ Screw in the thread on the cover without using any lubricant. The thread on the cover is coated with a dry lubricant.
8. Screw on the housing cover.
 9. Tighten the securing clamp of the housing cover.

Connecting the sensor connection housing via terminals

For the device version with the order code for "Housing":
Option B "Stainless"

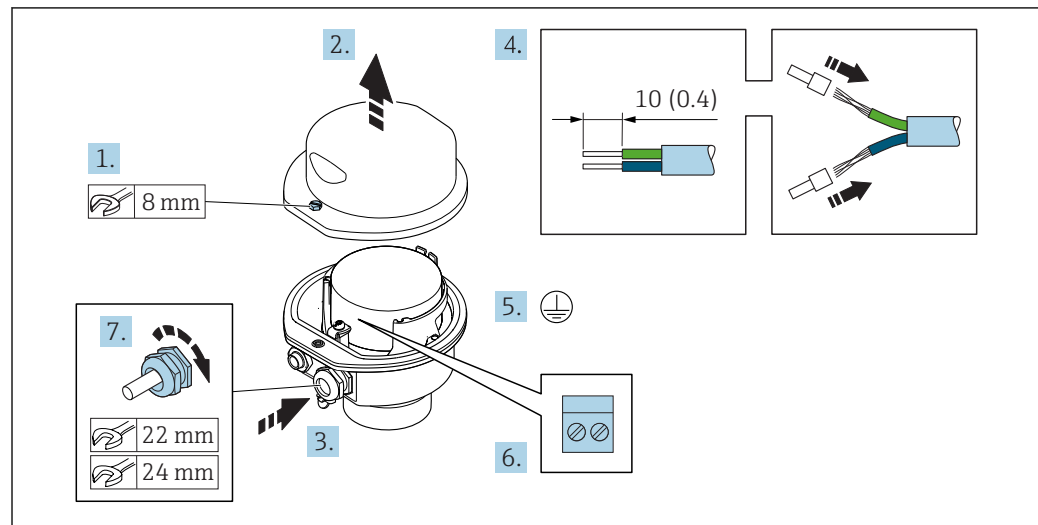

A0029613

1. Release the securing screw of the housing cover.
2. Open the housing cover.
3. Push the cable through the cable entry . To ensure tight sealing, do not remove the sealing ring from the cable entry.
4. Strip the cable and cable ends. In the case of stranded cables, fit ferrules.
5. Connect the protective ground.
6. Connect the cable in accordance with the connecting cable terminal assignment.
7. Firmly tighten the cable glands.
 - ↳ This concludes the process for connecting the connecting cable.
8. Close the housing cover.
9. Tighten the securing screw of the housing cover.

Connecting the connecting cable to the transmitter

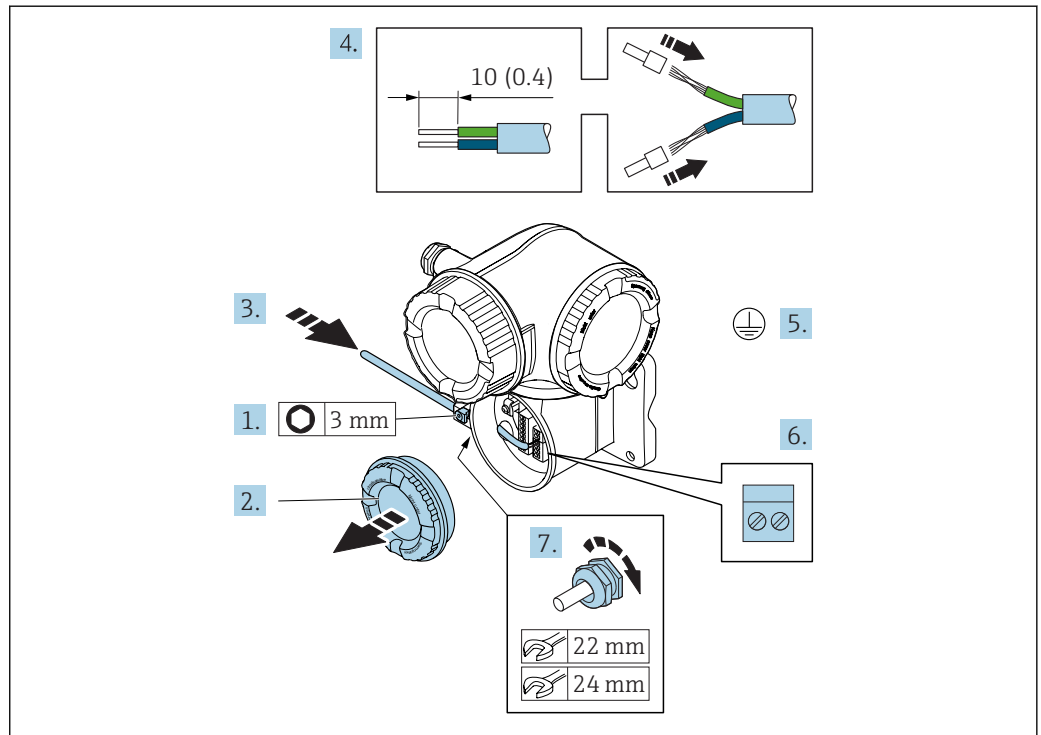

A0029592

1. Loosen the securing clamp of the connection compartment cover.
2. Unscrew the connection compartment cover.
3. Push the cable through the cable entry . To ensure tight sealing, do not remove the sealing ring from the cable entry.
4. Strip the cable and cable ends. In the case of stranded cables, also fit ferrules.
5. Connect the protective ground.
6. Connect the cable in accordance with the connecting cable terminal assignment
→ 52.
7. Firmly tighten the cable glands.
↳ This concludes the process for connecting the connecting cable.
8. Screw on the connection compartment cover.
9. Tighten the securing clamp of the connection compartment cover.
10. After connecting the connecting cable: After connecting the connecting cables:
Connect the signal cable and the supply voltage cable .

7.3.2 Connecting the transmitter

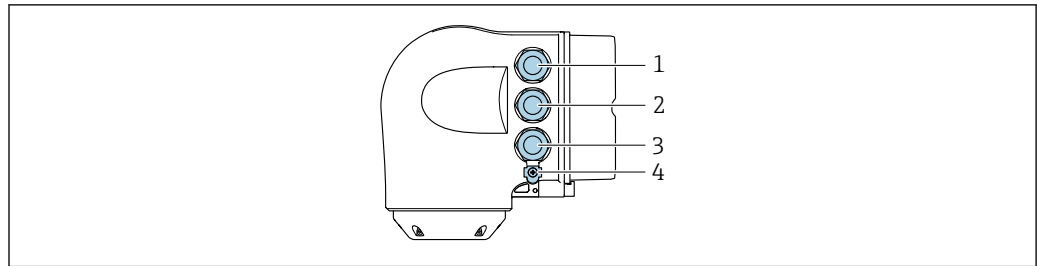

A0026781

- 1 Terminal connection for supply voltage
- 2 Terminal connection for signal transmission, input/output
- 3 Terminal connection for signal transmission, input/output or terminal connection for network connection via service interface (CDI-RJ45)
- 4 Protective earth (PE)

i In addition to connecting the device via EtherNet/IP and the available inputs/outputs, additional connection options are also available:

- Integrate into a network via the service interface (CDI-RJ45) → 59.
- Integrate the device into a ring topology → 60.

Connecting the EtherNet/IP connector

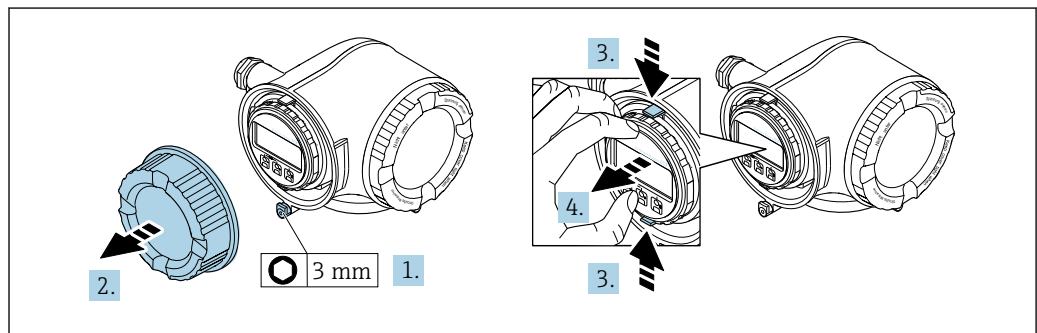

A0029813

1. Loosen the securing clamp of the connection compartment cover.
2. Unscrew the connection compartment cover.
3. Squeeze the tabs of the display module holder together.
4. Remove the display module holder.

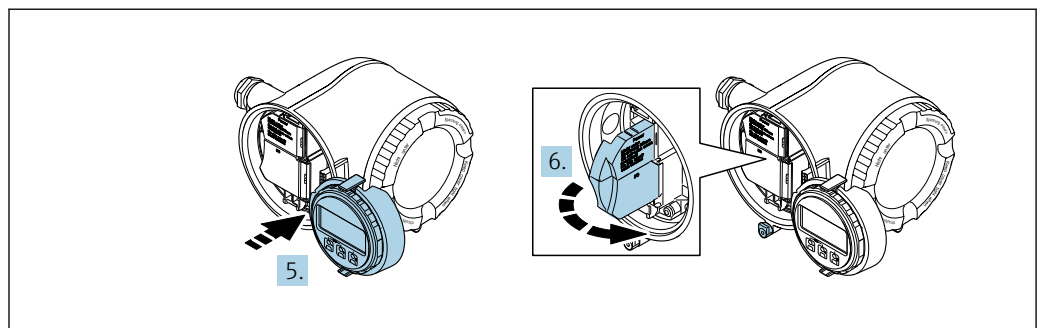

A0029814

5. Attach the holder to the edge of the electronics compartment.
6. Open the terminal cover.

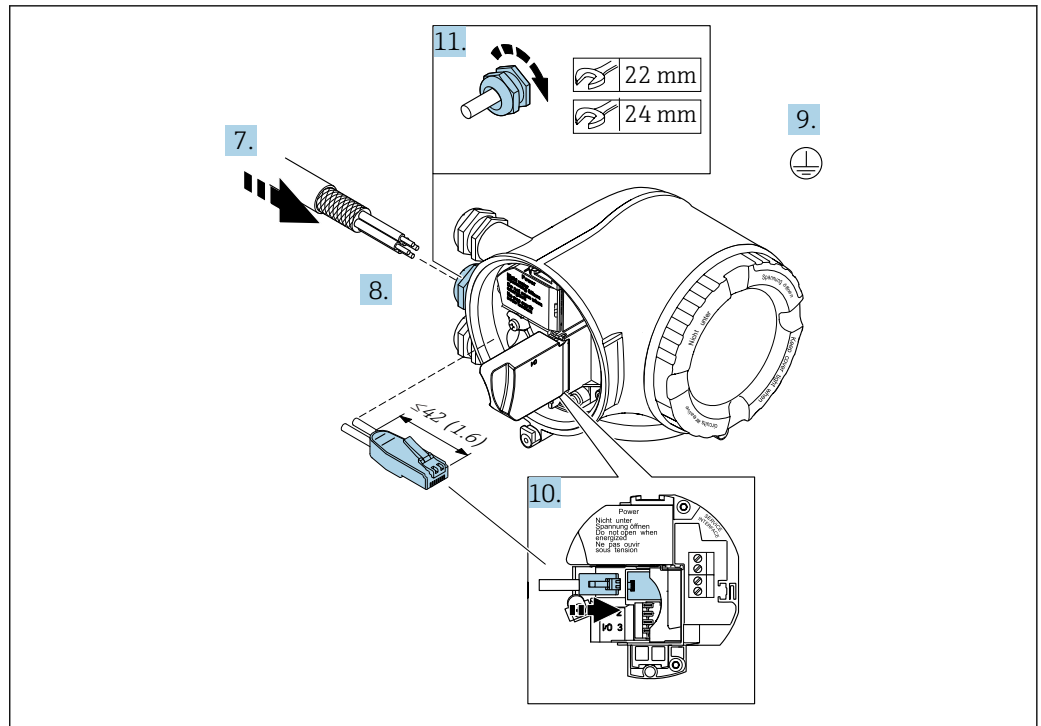

A0033722

7. Push the cable through the cable entry . To ensure tight sealing, do not remove the sealing ring from the cable entry.
8. Strip the cable and cable ends and connect to the RJ45 connector.
9. Connect the protective ground.
10. Plug in the RJ45 connector.
11. Firmly tighten the cable glands.
 - ↳ This concludes the EtherNet/IP connection process.

Connecting the supply voltage and additional inputs/outputs

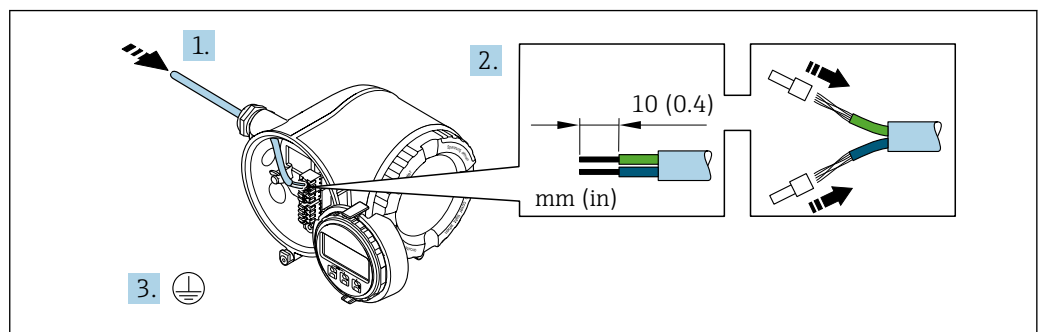

A0033983

1. Push the cable through the cable entry . To ensure tight sealing, do not remove the sealing ring from the cable entry.
2. Strip the cable and cable ends. In the case of stranded cables, also fit ferrules.
3. Connect the protective ground.

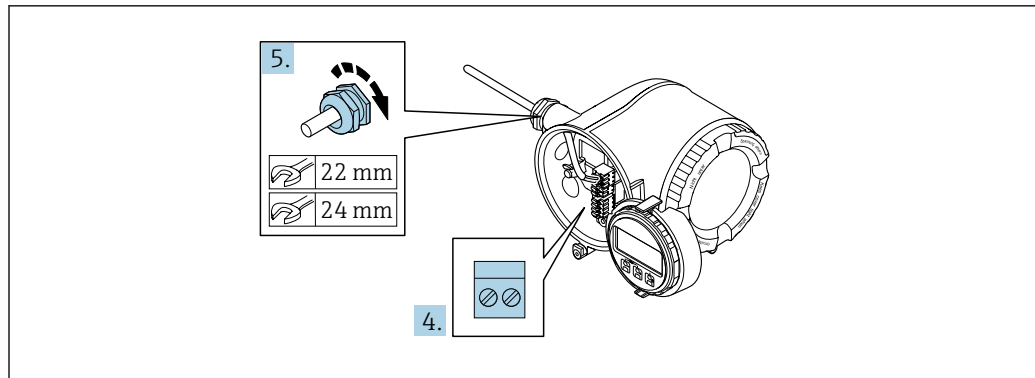

A0033984

4. Connect the cable in accordance with the terminal assignment .
 - ↳ **Signal cable terminal assignment:** The device-specific terminal assignment is documented on an adhesive label in the terminal cover.
 - Supply voltage terminal assignment:** Adhesive label in the terminal cover or → 40.
5. Firmly tighten the cable glands.
 - ↳ This concludes the cable connection process.
6. Close the terminal cover.
7. Fit the display module holder in the electronics compartment.
8. Screw on the connection compartment cover.
9. Secure the securing clamp of the connection compartment cover.

Removing a cable

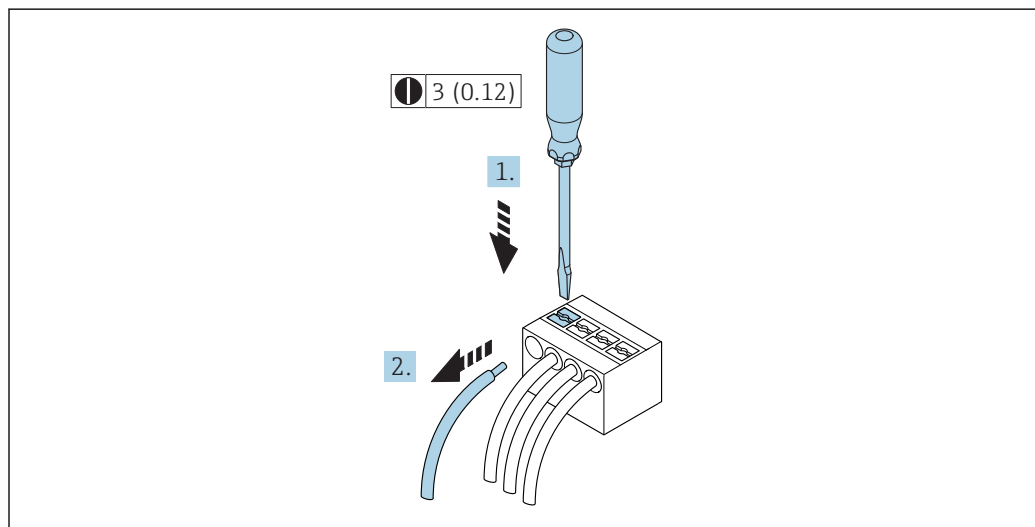

A0029598

16 Engineering unit mm (in)

1. To remove a cable from the terminal, use a flat-blade screwdriver to push the slot between the two terminal holes
2. while simultaneously pulling the cable end out of the terminal.

7.3.3 Integrating the transmitter into a network

This section only presents the basic options for integrating the device into a network.

For information on the procedure to follow to connect the transmitter correctly →  52.

Integrating via the service interface

The device is integrated via the connection to the service interface (CDI-RJ45).

Note the following when connecting:

- Recommended cable: CAT 5e, CAT 6 or CAT 7, with shielded connector
- Maximum cable thickness: 6 mm
- Length of connector including bend protection: 42 mm
- Bending radius: 5 x cable thickness

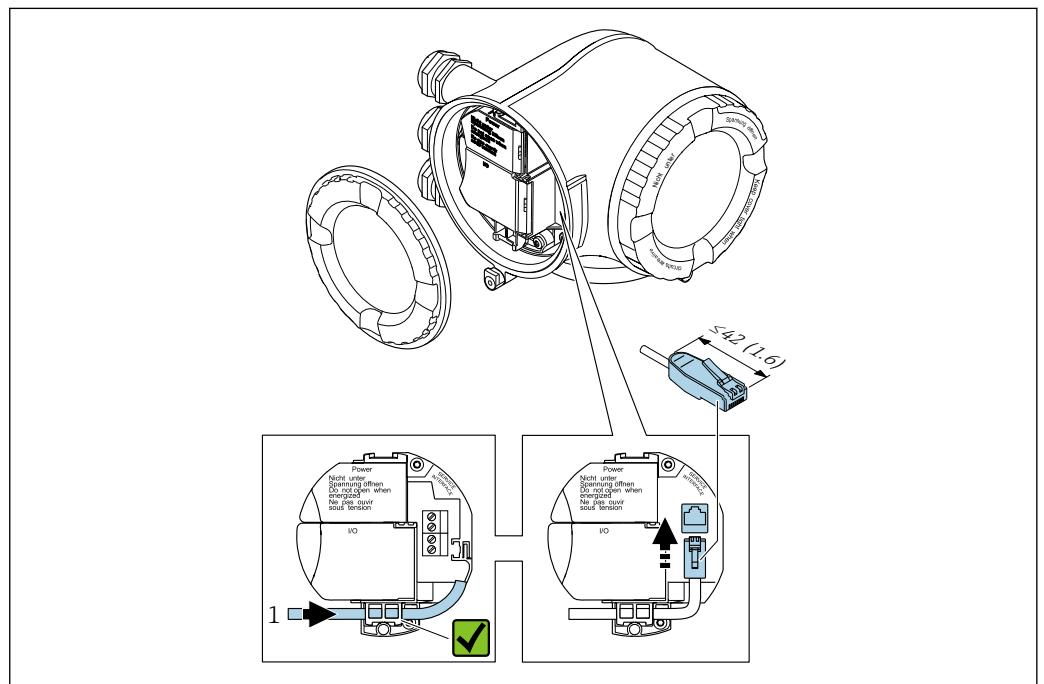

1 Service interface (CDI-RJ45)

-  An adapter for RJ45 and the M12 connector is optionally available:
Order code for "Accessories", option **NB**: "Adapter RJ45 M12 (service interface)"

The adapter connects the service interface (CDI-RJ45) to an M12 connector mounted in the cable entry. Therefore the connection to the service interface can be established via an M12 connector without opening the device.

Integrating into a ring topology

The device is integrated via the terminal connection for signal transmission (output 1) and the connection to the service interface (CDI-RJ45).

Note the following when connecting:

- Recommended cable: CAT5e, CAT6 or CAT7, with shielded connector
- Maximum cable thickness: 6 mm
- Length of connector including bend protection: 42 mm
- Bending radius: 2.5 x cable thickness

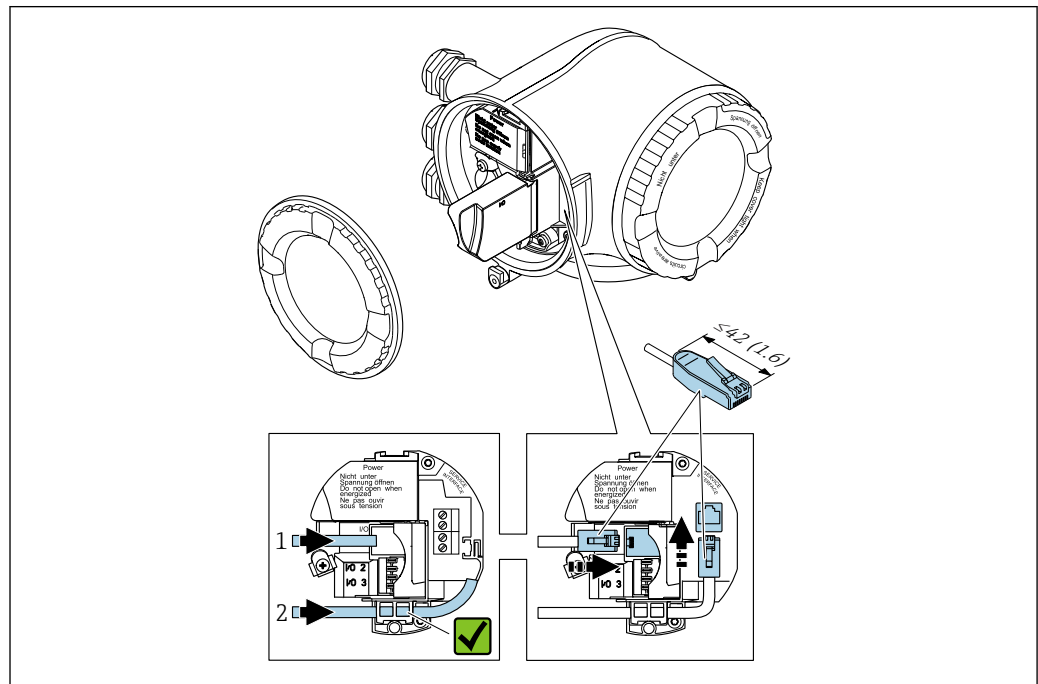

A0033717

- 1 EtherNet/IP connection
- 2 Service interface (CDI-RJ45)

i An adapter for RJ45 and the M12 connector is optionally available:
Order code for "Accessories", option **NB**: "Adapter RJ45 M12 (service interface)"

The adapter connects the service interface (CDI-RJ45) to an M12 connector mounted in the cable entry. Therefore the connection to the service interface can be established via an M12 connector without opening the device.

7.4 Ensure potential equalization

7.4.1 Requirements

No special measures for potential equalization are required.

7.5 Special connection instructions

7.5.1 Connection examples

EtherNet/IP

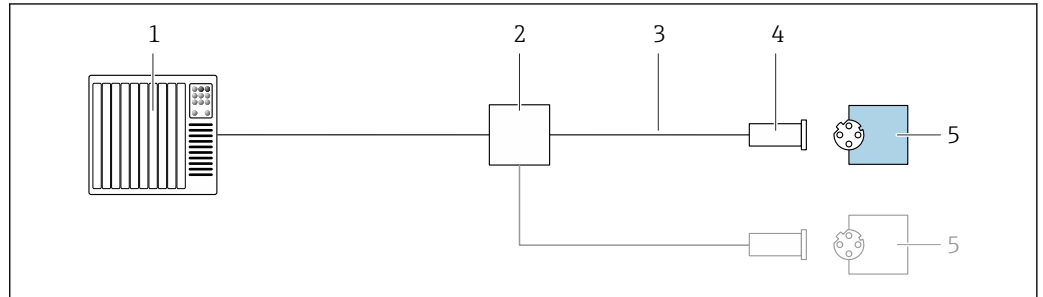

A0028767

17 Connection example for EtherNet/IP

- 1 Control system (e.g. PLC)
- 2 Ethernet switch
- 3 Observe cable specifications
- 4 Device plug
- 5 Transmitter

EtherNet/IP: DLR (Device Level Ring)

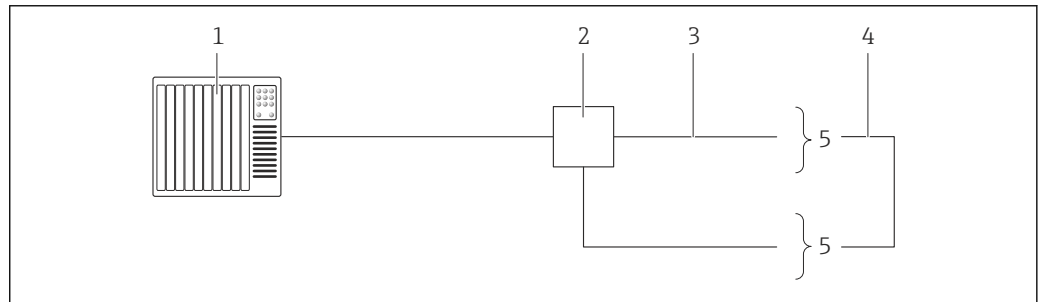

A0027544

- 1 Control system (e.g. PLC)
- 2 Ethernet switch
- 3 Observe cable specifications → 36
- 4 Connecting cable between the two transmitters
- 5 Transmitter

Current output 4-20 mA

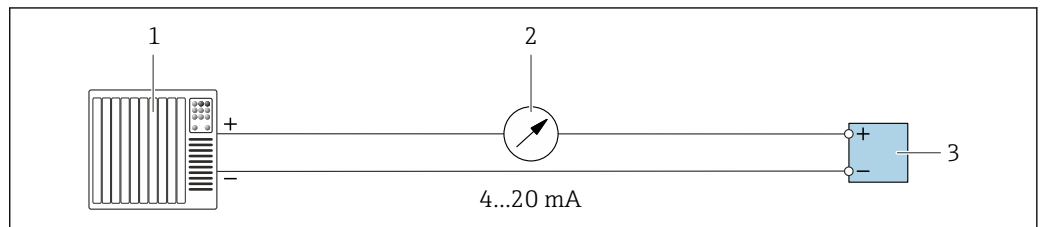

A0028758

18 Connection example for 4-20 mA current output (active)

- 1 Automation system with current input (e.g. PLC)
- 2 Analog display unit: observe maximum load
- 3 Transmitter

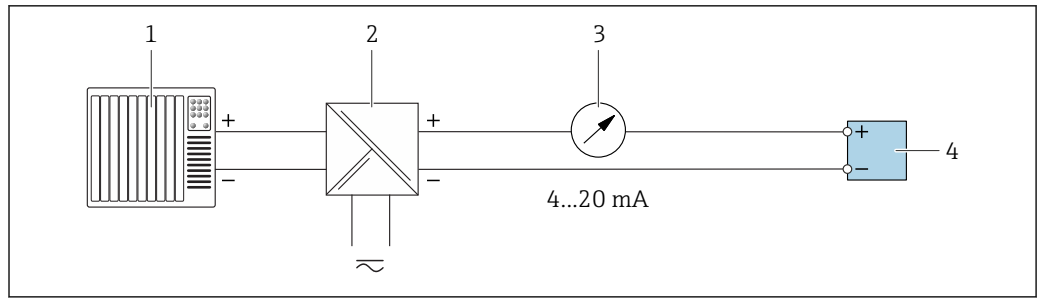

A0028759

19 Connection example for 4-20 mA current output (passive)

- 1 Automation system with current input (e.g. PLC)
- 2 Active barrier for power supply (e.g. RN221N)
- 3 Analog display unit: observe maximum load
- 4 Transmitter

Pulse/frequency output

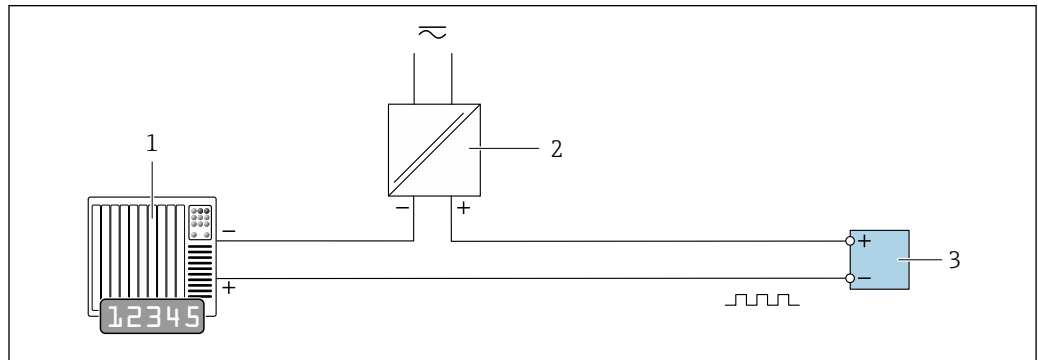

A0028761

20 Connection example for pulse/frequency output (passive)

- 1 Automation system with pulse/frequency input (e.g. PLC)
- 2 Power supply
- 3 Transmitter: Observe input values → 236

Switch output

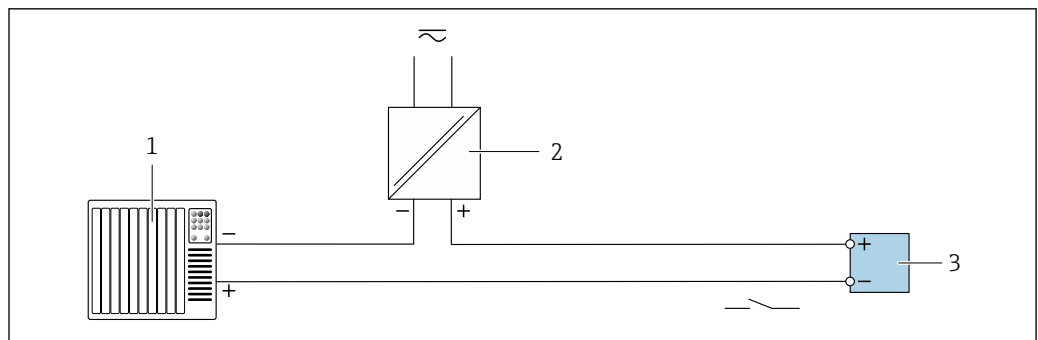

A0028760

21 Connection example for switch output (passive)

- 1 Automation system with switch input (e.g. PLC)
- 2 Power supply
- 3 Transmitter: Observe input values → 236

Relay output

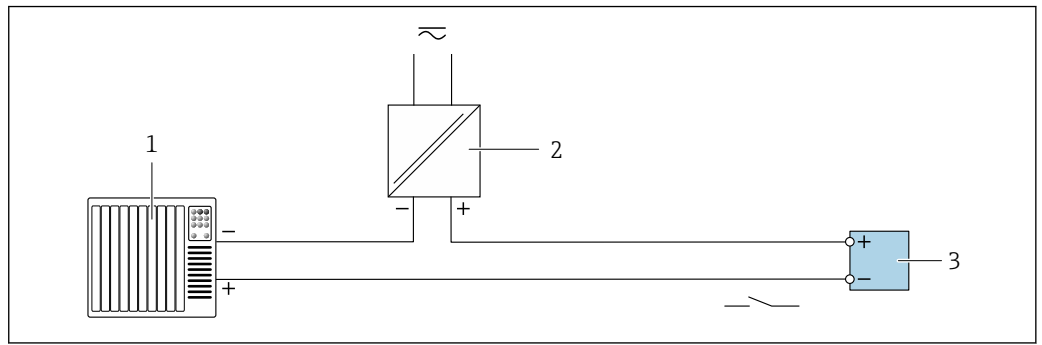

A0028760

22 Connection example for relay output (passive)

- 1 Automation system with relay input (e.g. PLC)
- 2 Power supply
- 3 Transmitter: Observe input values → 237

Current input

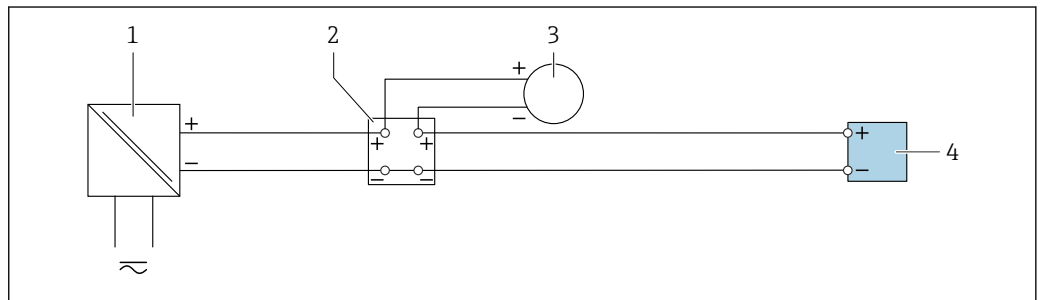

A0028915

23 Connection example for 4 to 20 mA current input

- 1 Power supply
- 2 External measuring device (for reading in pressure or temperature, for instance)
- 3 Transmitter: Observe input values

Status input

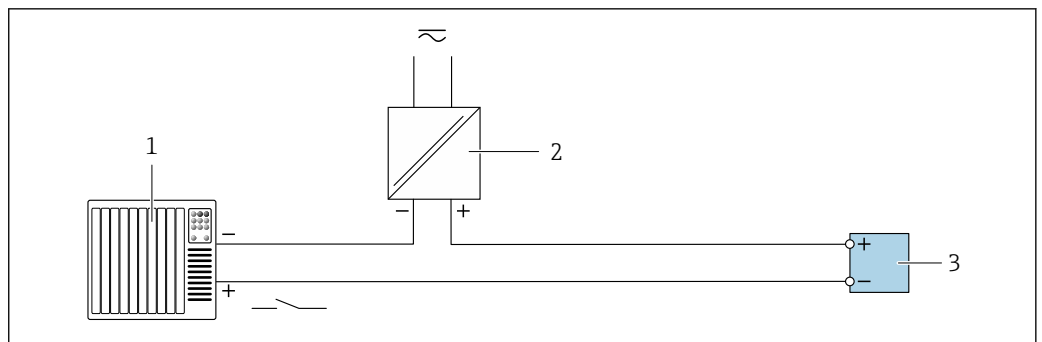

A0028764

24 Connection example for status input

- 1 Automation system with status output (e.g. PLC)
- 2 Power supply
- 3 Transmitter: Observe input values

7.6 Hardware settings

7.6.1 Setting the device address

The IP address of the measuring device can be configured for the network via DIP switches.

Addressing data

IP address and configuration options			
1st octet	2nd octet	3rd octet	4th octet
192.	168.	1.	XXX

↓
Can only be configured via software addressing

↓
Can be configured via software addressing and hardware addressing

IP address range	1 to 254 (4th octet)
IP address broadcast	255
Addressing mode ex works	Software addressing; all DIP switches for hardware addressing are set to OFF.
IP address ex works	DHCP server active

i Software addressing: The IP address is entered via the **IP address** parameter (→  118) .

Setting the IP address: Proline 500 - digital

Risk of electric shock when opening the transmitter housing.

- ▶ Before opening the transmitter housing:
- ▶ Disconnect the device from the power supply.

i The default IP address may **not** be activated →  65.

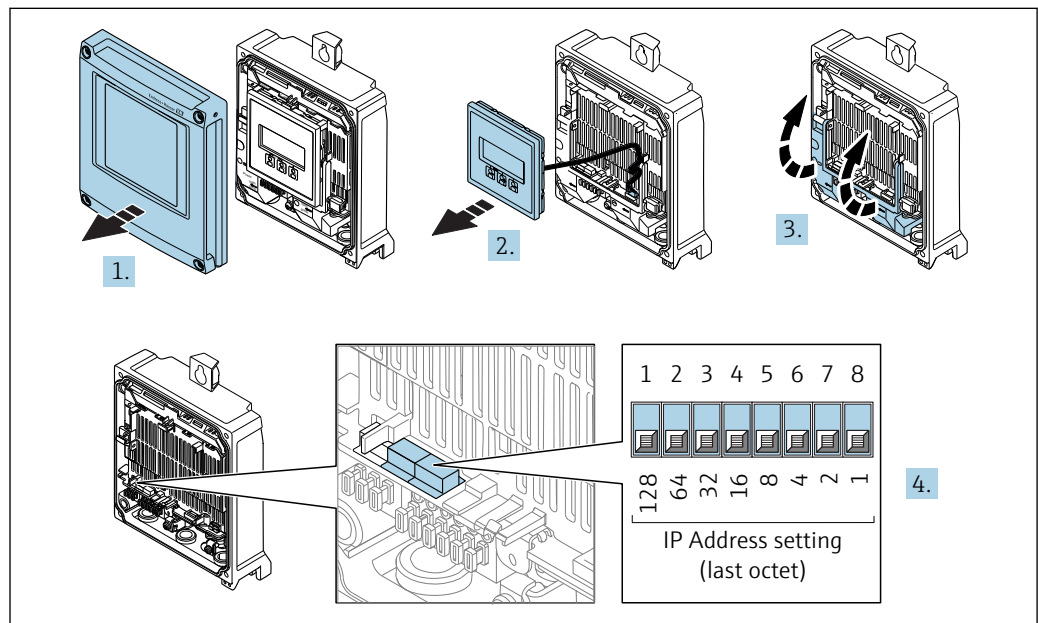

1. Loosen the 4 fixing screws on the housing cover.
2. Open the housing cover.
3. Fold open the terminal cover.

4. Set the desired IP address using the corresponding DIP switches on the I/O electronics module.
5. Reverse the removal procedure to reassemble the transmitter.
6. Reconnect the device to the power supply.
 - ↳ The configured device address is used once the device is restarted.

Setting the IP address: Proline 500

Risk of electric shock when opening the transmitter housing.

- ▶ Before opening the transmitter housing:
- ▶ Disconnect the device from the power supply.

 The default IP address may **not** be activated →  66.

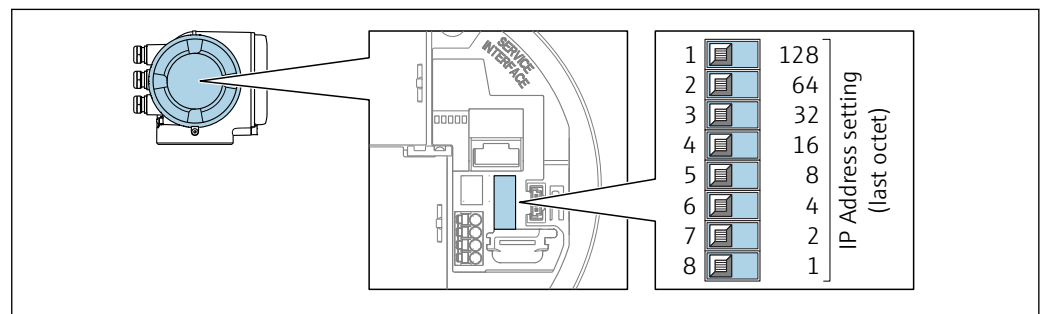

A0029635

1. Depending on the housing version, loosen the securing clamp or fixing screw of the housing cover.
2. Depending on the housing version, unscrew or open the housing cover and disconnect the local display from the main electronics module where necessary.
3. Set the desired IP address using the corresponding DIP switches on the I/O electronics module.
4. Reverse the removal procedure to reassemble the transmitter.
5. Reconnect the device to the power supply.
 - ↳ The configured device address is used once the device is restarted.

7.6.2 Activating the default IP address

The DHCP function is enabled in the device at the factory, i.e. the device expects an IP address to be assigned by the network. This function can be disabled and the device can be set to the default IP address 192.168.1.212 by DIP switch.

Activating the default IP address by DIP switch: Proline 500 - digital

Risk of electric shock when opening the transmitter housing.

- ▶ Before opening the transmitter housing:
- ▶ Disconnect the device from the power supply.

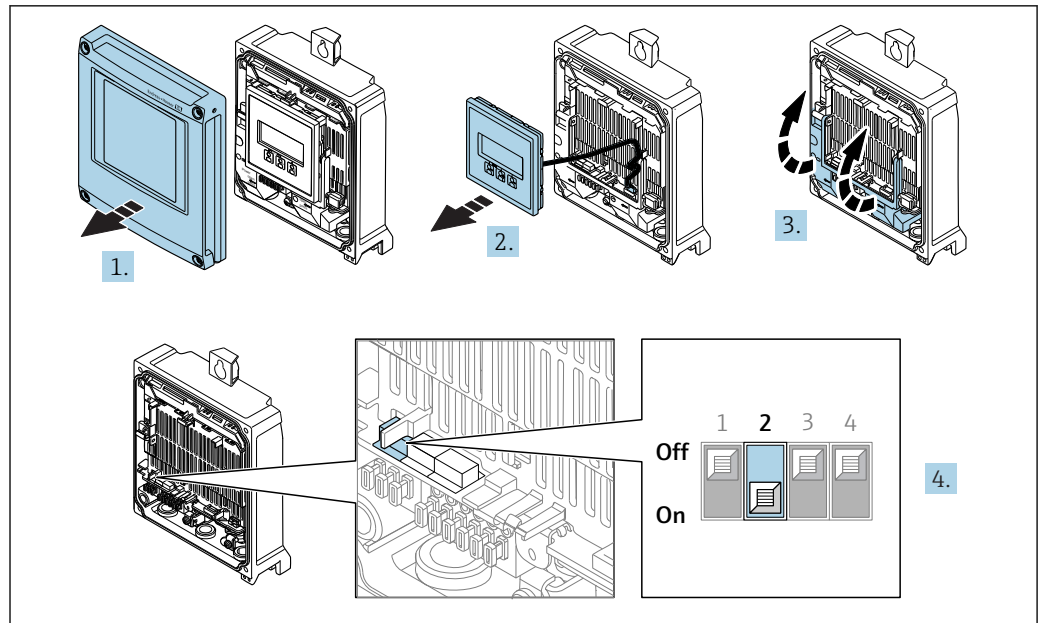

A0034500

1. Loosen the 4 fixing screws on the housing cover.
2. Open the housing cover.
3. Fold open the terminal cover.
4. Set DIP switch No. 2 on the I/O electronics module from **OFF** → **ON**.
5. Reverse the removal procedure to reassemble the transmitter.
6. Reconnect the device to the power supply.
 - ↳ The default IP address is used once the device is restarted.

Activating the default IP address via the DIP switch: Proline 500

Risk of electric shock when opening the transmitter housing.

- ▶ Before opening the transmitter housing:
- ▶ Disconnect the device from the power supply.

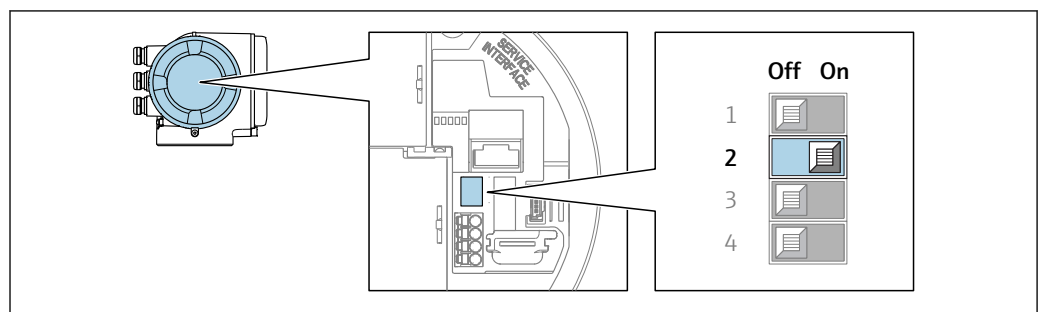

A0034499

1. Depending on the housing version, loosen the securing clamp or fixing screw of the housing cover.
2. Depending on the housing version, unscrew or open the housing cover and disconnect the local display from the main electronics module where necessary .
3. Set DIP switch No. 2 on the I/O electronics module from **OFF** → **ON**.
4. Reverse the removal procedure to reassemble the transmitter.
5. Reconnect the device to the power supply.
 - ↳ The default IP address is used once the device is restarted.

7.7 Ensuring the degree of protection

The measuring device fulfills all the requirements for the IP66/67 degree of protection, Type 4X enclosure.

To guarantee IP66/67 degree of protection, Type 4X enclosure, carry out the following steps after the electrical connection:

1. Check that the housing seals are clean and fitted correctly.
2. Dry, clean or replace the seals if necessary.
3. Tighten all housing screws and screw covers.
4. Firmly tighten the cable glands.
5. To ensure that moisture does not enter the cable entry:
Route the cable so that it loops down before the cable entry ("water trap").

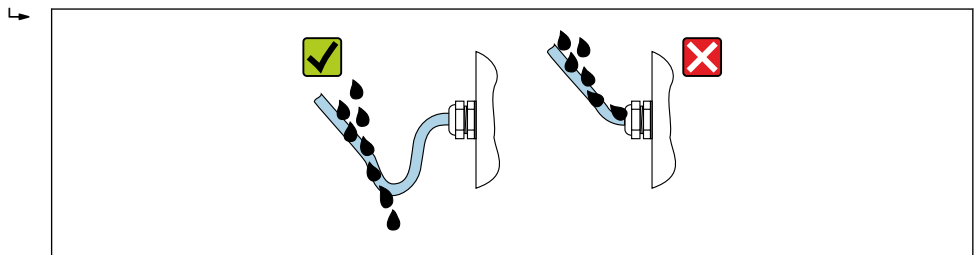

A0029278

6. Insert dummy plugs into unused cable entries.

7.8 Post-connection check

Are cables or the device undamaged (visual inspection)?	<input type="checkbox"/>
Do the cables used meet the requirements?	<input type="checkbox"/>
Do the cables have adequate strain relief?	<input type="checkbox"/>
Are all the cable glands installed, firmly tightened and leak-tight? Cable run with "water trap" → 67 ?	<input type="checkbox"/>

8 Operation options

8.1 Overview of operation options

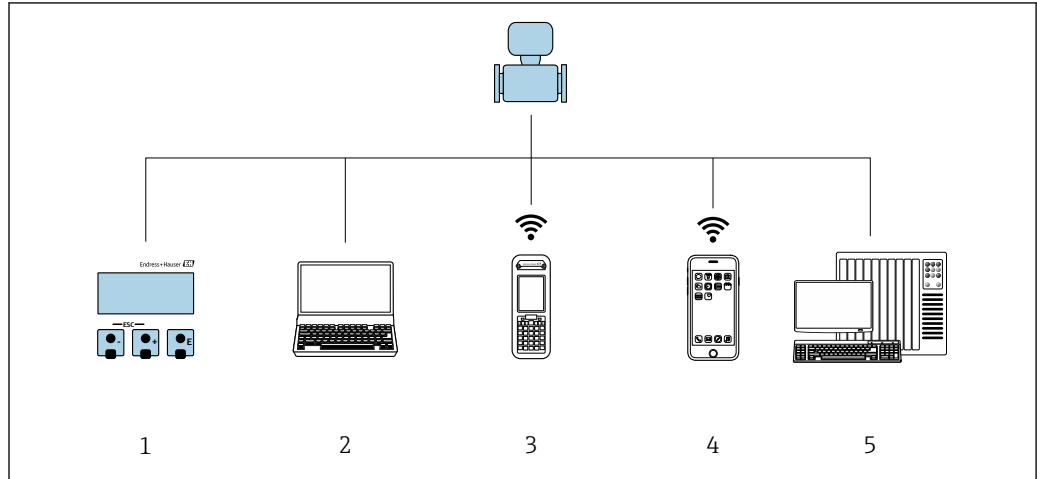



A0034513

- 1 Local operation via display module
- 2 Computer with Web browser (e.g. Internet Explorer) or with operating tool (e.g. FieldCare, DeviceCare, AMS Device Manager, SIMATIC PDM)
- 3 Field Xpert SFX350 or SFX370
- 5 Mobile handheld terminal
- 6 Control system (e.g. PLC)

8.2 Structure and function of the operating menu

8.2.1 Structure of the operating menu

 For an overview of the operating menu for experts: "Description of Device Parameters" document supplied with the device →  263

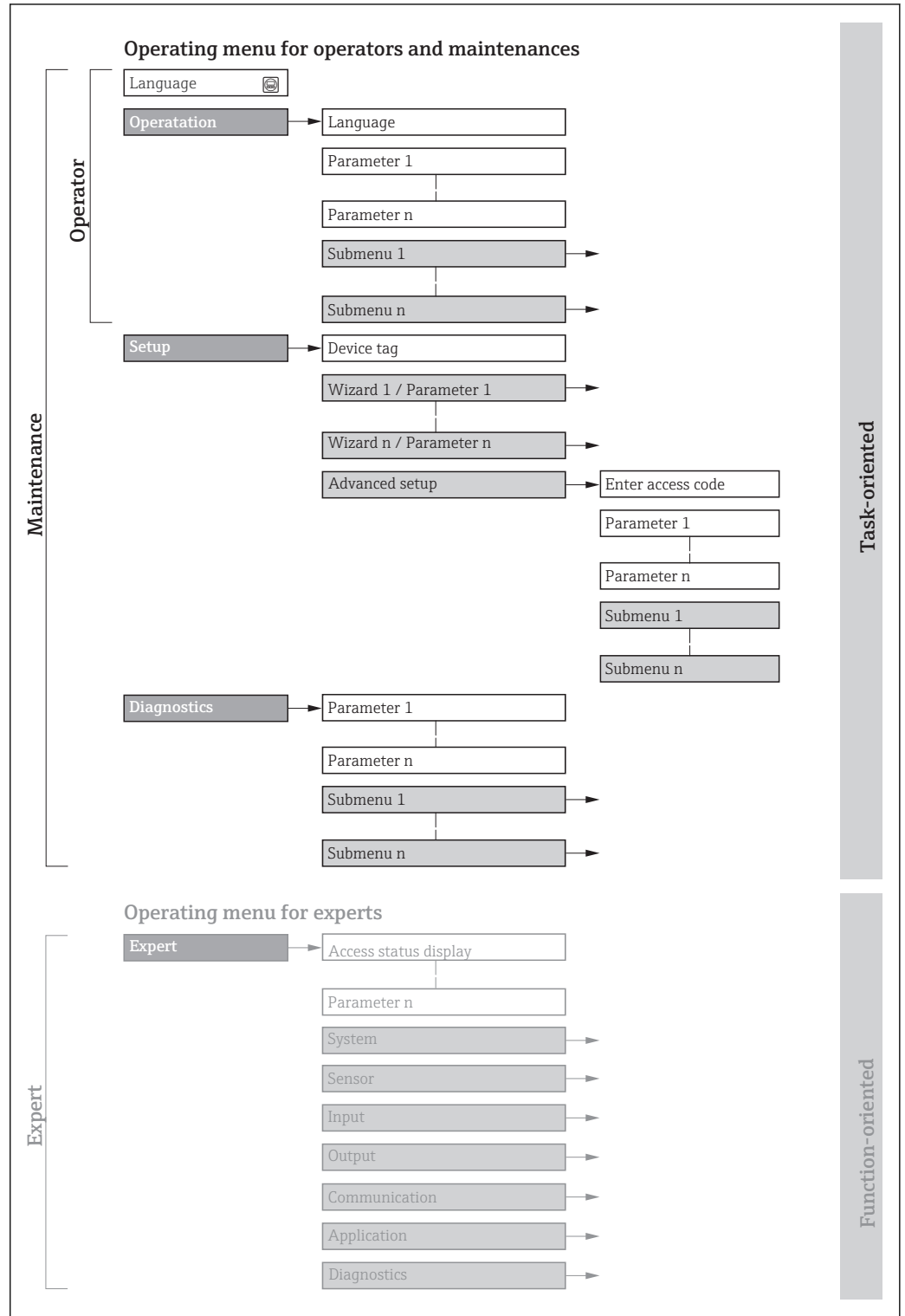

 25 Schematic structure of the operating menu

A0018237-EN

8.2.2 Operating philosophy

The individual parts of the operating menu are assigned to certain user roles (operator, maintenance etc.). Each user role contains typical tasks within the device lifecycle.

 For custody transfer, once the device has been put into circulation or sealed, its operation is restricted.

Menu/parameter		User role and tasks	Content/meaning
Language	task-oriented	Role "Operator", "Maintenance" Tasks during operation: <ul style="list-style-type: none"> ▪ Configuring the operational display ▪ Reading measured values 	<ul style="list-style-type: none"> ▪ Defining the operating language ▪ Defining the Web server operating language ▪ Resetting and controlling totalizers
Operation			<ul style="list-style-type: none"> ▪ Configuring the operational display (e.g. display format, display contrast) ▪ Resetting and controlling totalizers
Setup		"Maintenance" role Commissioning: <ul style="list-style-type: none"> ▪ Configuration of the measurement ▪ Configuration of the inputs and outputs ▪ Configuration of the communication interface 	Wizards for fast commissioning: <ul style="list-style-type: none"> ▪ Set the system units ▪ Configuration of the communication interface ▪ Define the medium ▪ Display I/O/configuration ▪ Configure the inputs ▪ Configure the outputs ▪ Configuring the operational display ▪ Define the output conditioning ▪ Set the low flow cut off ▪ Configure partial and empty pipe detection Advanced setup <ul style="list-style-type: none"> ▪ For more customized configuration of the measurement (adaptation to special measuring conditions) ▪ Configuration of totalizers ▪ Configure the WLAN settings ▪ Administration (define access code, reset measuring device)
Diagnostics	"Maintenance" role Fault elimination: <ul style="list-style-type: none"> ▪ Diagnostics and elimination of process and device errors ▪ Measured value simulation 	Contains all parameters for error detection and analyzing process and device errors: <ul style="list-style-type: none"> ▪ Diagnostic list Contains up to 5 currently pending diagnostic messages. ▪ Event logbook Contains event messages that have occurred. ▪ Device information Contains information for identifying the device. ▪ Measured values Contains all current measured values. ▪ Data logging submenu with "Extended HistoROM" order option Storage and visualization of measured values ▪ Heartbeat The functionality of the device is checked on demand and the verification results are documented. ▪ Simulation Is used to simulate measured values or output values. 	

Menu/parameter		User role and tasks	Content/meaning
Expert	function-oriented	<p>Tasks that require detailed knowledge of the function of the device:</p> <ul style="list-style-type: none"> ▪ Commissioning measurements under difficult conditions ▪ Optimal adaptation of the measurement to difficult conditions ▪ Detailed configuration of the communication interface ▪ Error diagnostics in difficult cases 	<p>Contains all the parameters of the device and makes it possible to access these parameters directly using an access code. The structure of this menu is based on the function blocks of the device:</p> <ul style="list-style-type: none"> ▪ System Contains all higher-order device parameters which do not concern the measurement or the communication interface. ▪ Sensor Configuration of the measurement. ▪ Input Configuring the status input. ▪ Output Configuring of the analog current outputs as well as the pulse/frequency and switch output. ▪ Communication Configuration of the digital communication interface and the Web server. ▪ Application Configure the functions that go beyond the actual measurement (e.g. totalizer). ▪ Diagnostics Error detection and analysis of process and device errors and for device simulation and Heartbeat Technology.

8.3 Access to the operating menu via the local display

8.3.1 Operational display

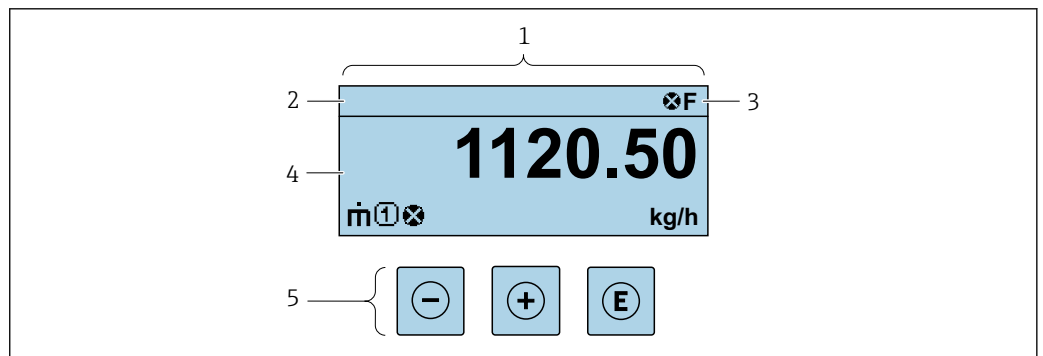

- 1 Operational display
- 2 Device tag
- 3 Status area
- 4 Display area for measured values (4-line)
- 5 Operating elements → 77

Status area

The following symbols appear in the status area of the operational display at the top right:







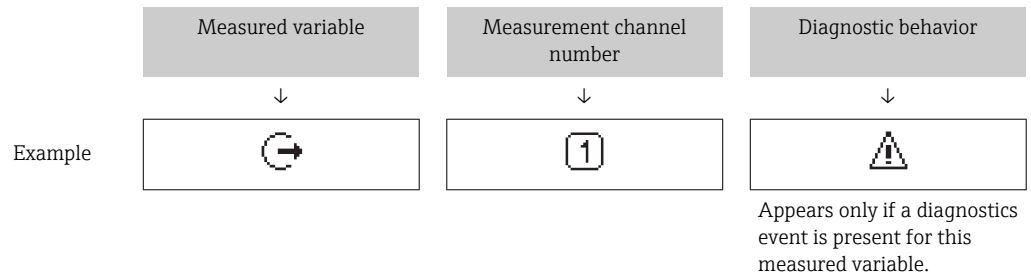

- Status signals → 200
 - F: Failure
 - C: Function check
 - S: Out of specification
 - M: Maintenance required
- Diagnostic behavior → 201
 - ☒: Alarm
 - ⚠: Warning
- 🔒: Locking (the device is locked via the hardware)
- ↔: Communication (communication via remote operation is active)

Display area

In the display area, each measured value is prefaced by certain symbol types for further description:



Measured values



Symbol	Meaning
	Mass flow
	<ul style="list-style-type: none"> ▪ Volume flow ▪ Corrected volume flow
	<ul style="list-style-type: none"> ▪ Density ▪ Reference density
	Temperature
	Totalizer  The measurement channel number indicates which of the three totalizers is displayed.
	Output  The measurement channel number indicates which of the outputs is displayed.
	Status input

Measurement channel numbers

Symbol	Meaning
	Measurement channel 1 to 4
The measurement channel number is displayed only if more than one channel is present for the same measured variable type (e.g. Totalizer 1 to 3).	

Diagnostic behavior

The diagnostic behavior pertains to a diagnostic event that is relevant to the displayed measured variable. For information on the symbols →  201

 The number and display format of the measured values can be configured via the **Format display** parameter (→  142).

8.3.2 Navigation view

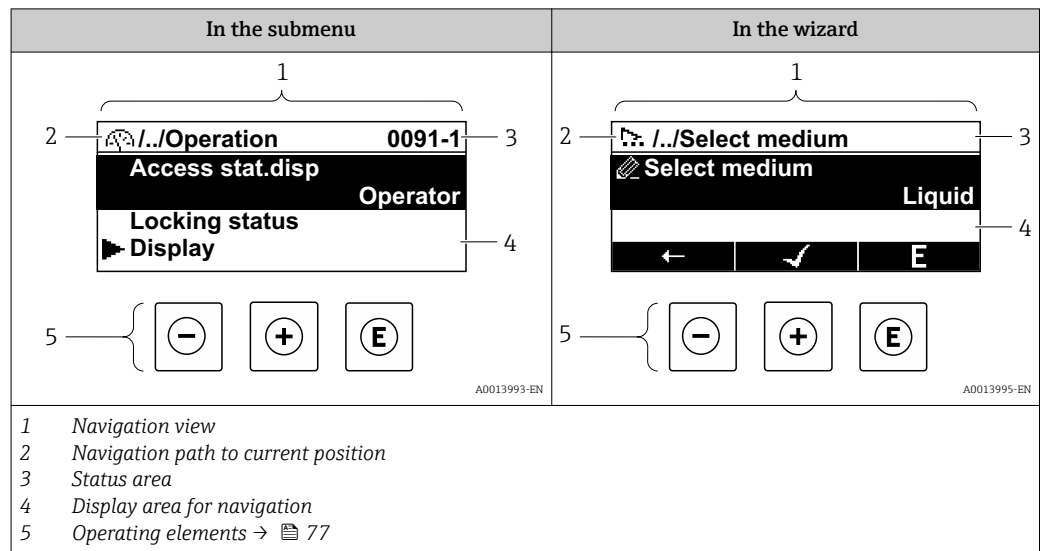

Navigation path

The navigation path - displayed at the top left in the navigation view - consists of the following elements:

	<ul style="list-style-type: none"> In the submenu: Display symbol for menu In the wizard: Display symbol for wizard 	Omission symbol for operating menu levels in between	Name of current <ul style="list-style-type: none"> Submenu Wizard Parameters
	↓	↓	↓
Examples		/ .. /	Display
		/ .. /	Display

For more information about the icons in the menu, refer to the "Display area" section → 74

Status area





The following appears in the status area of the navigation view in the top right corner:

- In the submenu
 - The direct access code for the parameter you are navigating to (e.g. 0022-1)
 - If a diagnostic event is present, the diagnostic behavior and status signal
- In the wizard
 - If a diagnostic event is present, the diagnostic behavior and status signal





- For information on the diagnostic behavior and status signal → 200
- For information on the function and entry of the direct access code → 79

Display area

Menus

Symbol	Meaning
	Operation Appears: <ul style="list-style-type: none"> In the menu next to the "Operation" selection At the left in the navigation path in the Operation menu
	Setup Appears: <ul style="list-style-type: none"> In the menu next to the "Setup" selection At the left in the navigation path in the Setup menu
	Diagnostics Appears: <ul style="list-style-type: none"> In the menu next to the "Diagnostics" selection At the left in the navigation path in the Diagnostics menu
	Expert Appears: <ul style="list-style-type: none"> In the menu next to the "Expert" selection At the left in the navigation path in the Expert menu



Submenus, wizards, parameters

Symbol	Meaning
	Submenu
	Wizard
	Parameters within a wizard  No display symbol exists for parameters in submenus.

Locking

Symbol	Meaning
	Parameter locked When displayed in front of a parameter name, indicates that the parameter is locked. <ul style="list-style-type: none"> By a user-specific access code By the hardware write protection switch

Wizard operation

Symbol	Meaning
	Switches to the previous parameter.
	Confirms the parameter value and switches to the next parameter.
	Opens the editing view of the parameter.

8.3.3 Editing view

Numeric editor

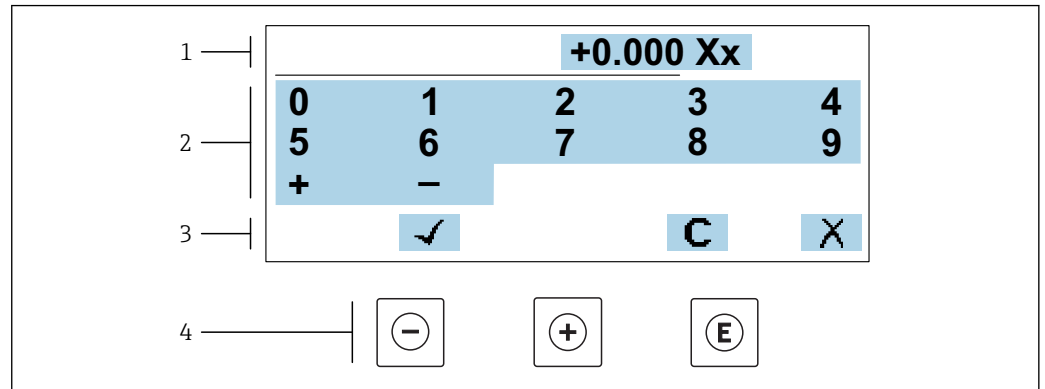

A0034250

26 For entering values in parameters (e.g. limit values)

- 1 Entry display area
- 2 Input screen
- 3 Confirm, delete or reject entry
- 4 Operating elements

Text editor

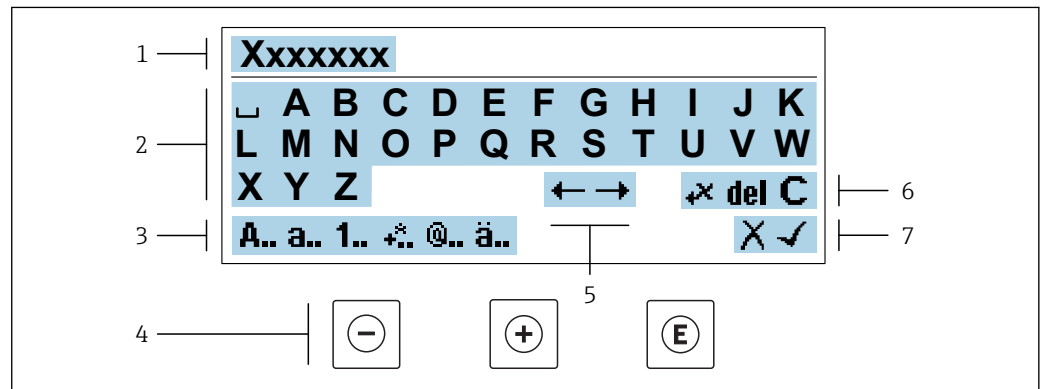



A0034114

27 For entering text in parameters (e.g. tag name)



- 1 Entry display area
- 2 Current input screen
- 3 Change input screen
- 4 Operating elements
- 5 Move entry position
- 6 Delete entry
- 7 Reject or confirm entry

Using the operating elements in the editing view





Operating key(s)	Meaning
⊖	Minus key Move the entry position to the left.
⊕	Plus key Move the entry position to the right.

Operating key(s)	Meaning
	Enter key <ul style="list-style-type: none"> ▪ Press the key briefly: confirm your selection. ▪ Press the key for 2 s: confirm the entry.
	Escape key combination (press keys simultaneously) Close the editing view without accepting the changes.





Input screens

Symbol	Meaning
A..	Upper case
a..	Lower case
1..	Numbers
	Punctuation marks and special characters: = + - * / ² ³ ¼ ½ ¾ () [] < > { }
	Punctuation marks and special characters: " ` ^ . , ; : ? ! % μ ° € \$ £ ¥ \$ @ # / \ ~ & _
ä..	Umlauts and accents

Controlling data entries

Symbol	Meaning
	Move entry position
	Reject entry
	Confirm entry
	Delete character immediately to the left of the entry position
del	Delete character immediately to the right of the entry position
C	Clear all the characters entered

8.3.4 Operating elements

Operating key(s)	Meaning
	<p>Minus key</p> <p><i>In a menu, submenu</i> Moves the selection bar upwards in a choose list.</p> <p><i>With a Wizard</i> Confirms the parameter value and goes to the previous parameter.</p> <p><i>With a text and numeric editor</i> Move the entry position to the left.</p>
	<p>Plus key</p> <p><i>In a menu, submenu</i> Moves the selection bar downwards in a choose list.</p> <p><i>With a Wizard</i> Confirms the parameter value and goes to the next parameter.</p> <p><i>With a text and numeric editor</i> Move the entry position to the right.</p>
	<p>Enter key</p> <p><i>For operational display</i></p> <ul style="list-style-type: none"> ▪ Pressing the key briefly opens the operating menu. ▪ Pressing the key for 2 s opens the context menu including the option for activating the keypad lock. <p><i>In a menu, submenu</i></p> <ul style="list-style-type: none"> ▪ Pressing the key briefly: <ul style="list-style-type: none"> - Opens the selected menu, submenu or parameter. - Starts the wizard. - If help text is open, closes the help text of the parameter. ▪ Pressing the key for 2 s for parameter: <ul style="list-style-type: none"> - If present, opens the help text for the function of the parameter. <p><i>With a Wizard</i> Opens the editing view of the parameter.</p> <p><i>With a text and numeric editor</i></p> <ul style="list-style-type: none"> ▪ Press the key briefly: confirm your selection. ▪ Press the key for 2 s: confirm the entry.
	<p>Escape key combination (press keys simultaneously)</p> <p><i>In a menu, submenu</i></p> <ul style="list-style-type: none"> ▪ Pressing the key briefly: <ul style="list-style-type: none"> - Exits the current menu level and takes you to the next higher level. - If help text is open, closes the help text of the parameter. ▪ Pressing the key for 2 s returns you to the operational display ("home position"). <p><i>With a Wizard</i> Exits the wizard and takes you to the next higher level.</p> <p><i>With a text and numeric editor</i> Close the editing view without accepting the changes.</p>
	<p>Minus/Enter key combination (press the keys simultaneously)</p> <p>Press the key for 3 s: deactivate the keypad lock.</p>

8.3.5 Opening the context menu

Using the context menu, the user can call up the following menus quickly and directly from the operational display:

- Setup
- Data backup
- Simulation

Calling up and closing the context menu

The user is in the operational display.

1. Press **⏏** for 2 s.
↳ The context menu opens.

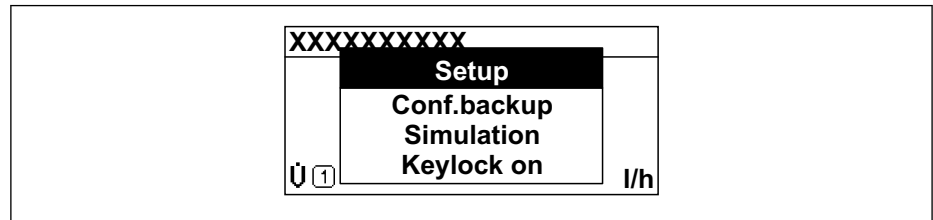

A0034608-EN



2. Press **⏏** + **⏏** simultaneously.
↳ The context menu is closed and the operational display appears.

Calling up the menu via the context menu

1. Open the context menu.
2. Press **⏏** to navigate to the desired menu.
3. Press **⏏** to confirm the selection.
↳ The selected menu opens.

8.3.6 Navigating and selecting from list

Different operating elements are used to navigate through the operating menu. The navigation path is displayed on the left in the header. Icons are displayed in front of the individual menus. These icons are also shown in the header during navigation.

 For an explanation of the navigation view with symbols and operating elements →  73

Example: Setting the number of displayed measured values to "2 values"

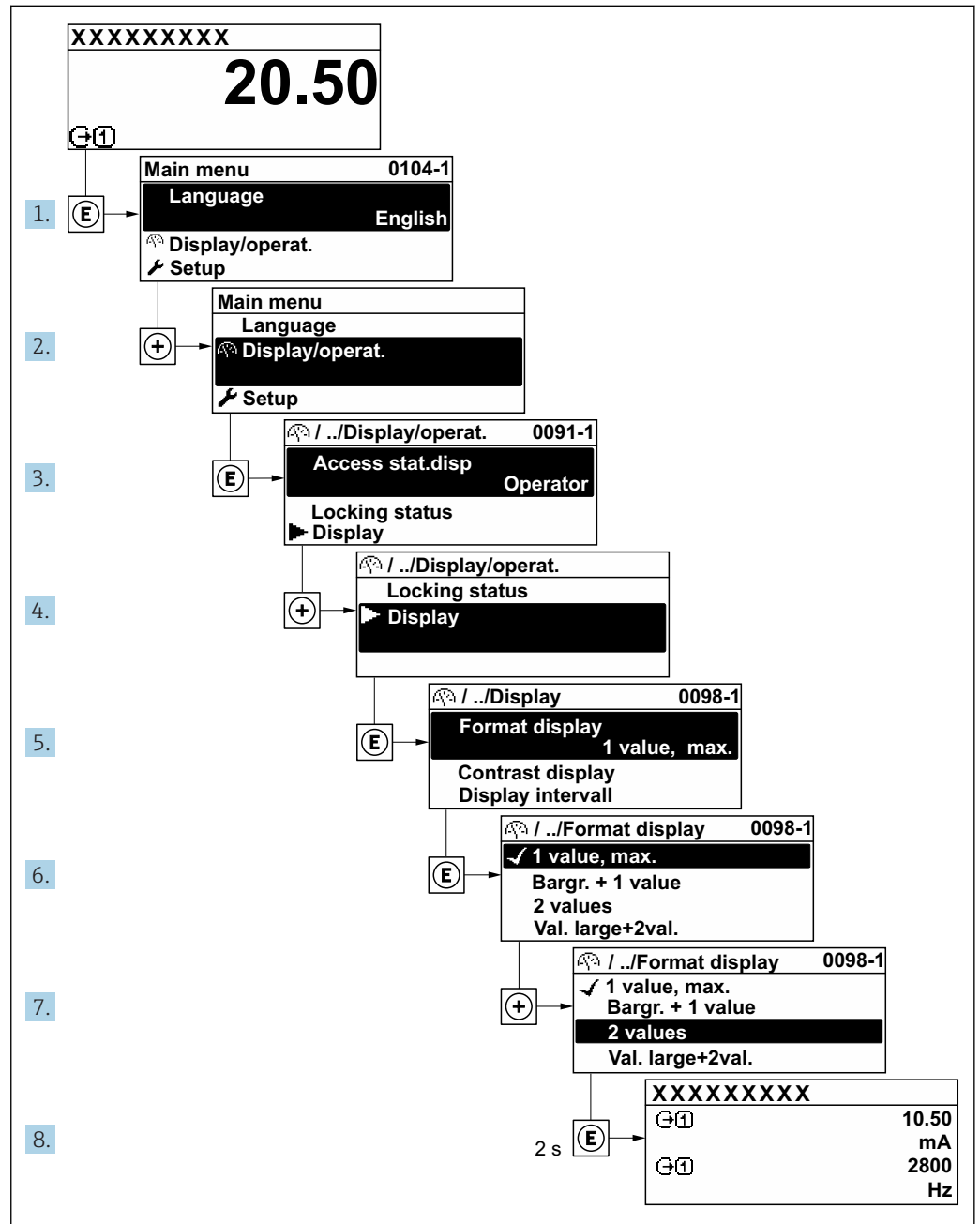

A0029562-EN

8.3.7 Calling the parameter directly

A parameter number is assigned to every parameter to be able to access a parameter directly via the onsite display. Entering this access code in the **Direct access** parameter calls up the desired parameter directly.

Navigation path

Expert → Direct access

The direct access code consists of a 5-digit number (at maximum) and the channel number, which identifies the channel of a process variable: e.g. 00914-2. In the navigation view, this appears on the right-hand side in the header of the selected parameter.

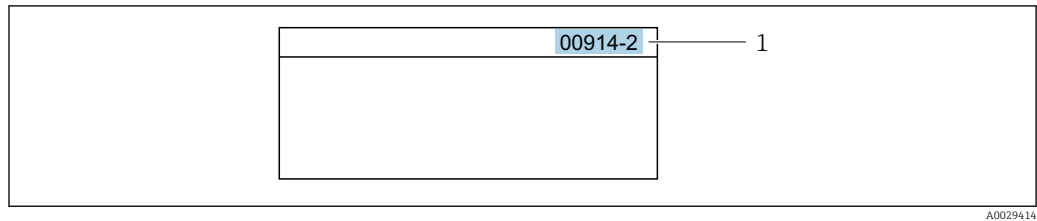

1 Direct access code

Note the following when entering the direct access code:

- The leading zeros in the direct access code do not have to be entered.
Example: Enter "914" instead of "00914"
- If no channel number is entered, channel 1 is accessed automatically.
Example: Enter 00914 → **Assign process variable** parameter
- If a different channel is accessed: Enter the direct access code with the corresponding channel number.
Example: Enter 00914-2 → **Assign process variable** parameter



For the direct access codes of the individual parameters, see the "Description of Device Parameters" document for the device

8.3.8 Calling up help text

Help text is available for some parameters and can be called up from the navigation view. The help text provides a brief explanation of the parameter function and thereby supports swift and safe commissioning.

Calling up and closing the help text

The user is in the navigation view and the selection bar is on a parameter.

1. Press \square for 2 s.
↳ The help text for the selected parameter opens.

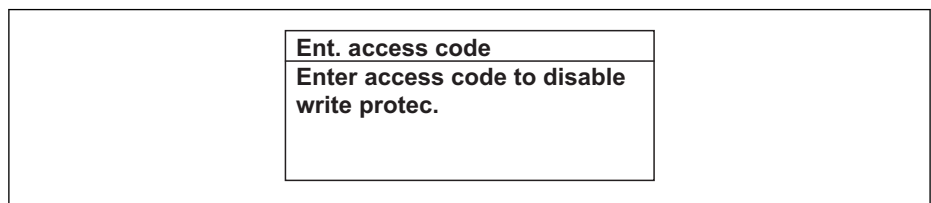

28 Example: Help text for parameter "Enter access code"

2. Press \square + \oplus simultaneously.
↳ The help text is closed.

8.3.9 Changing the parameters

Parameters can be changed via the numeric editor or text editor.

- Numeric editor: Change values in a parameter, e.g. specifications for limit values.
- Text editor: Enter text in a parameter, e.g. tag name.

A message is displayed if the value entered is outside the permitted value range.

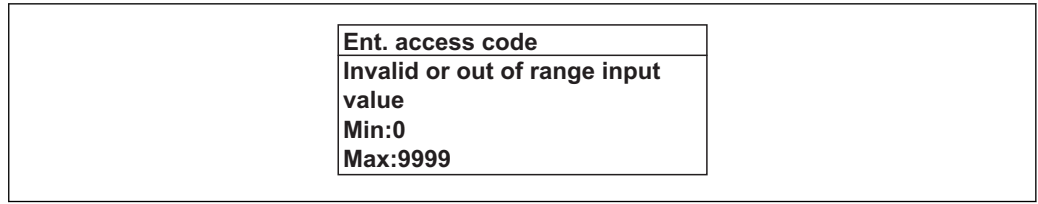

A0014049-EN

For a description of the editing view - consisting of the text editor and numeric editor - with symbols → 75, for a description of the operating elements → 77

8.3.10 User roles and related access authorization

The two user roles "Operator" and "Maintenance" have different write access to the parameters if the customer defines a user-specific access code. This protects the device configuration via the local display from unauthorized access → 177.

Defining access authorization for user roles

An access code is not yet defined when the device is delivered from the factory. Access authorization (read and write access) to the device is not restricted and corresponds to the "Maintenance" user role.

- ▶ Define the access code.
 - ↳ The "Operator" user role is redefined in addition to the "Maintenance" user role. Access authorization differs for the two user roles.

Access authorization to parameters: "Maintenance" user role

Access code status	Read access	Write access
An access code has not yet been defined (factory setting).	✓	✓
After an access code has been defined.	✓	✓ ¹⁾

1) The user only has write access after entering the access code.

Access authorization to parameters: "Operator" user role

Access code status	Read access	Write access
After an access code has been defined.	✓	-- ¹⁾

1) Despite the defined access code, certain parameters can always be modified and thus are exempted from the write protection, as they do not affect the measurement. Refer to the "Write protection via access code" section

The user role with which the user is currently logged on is indicated by the **Access status** parameter. Navigation path: Operation → Access status

8.3.11 Disabling write protection via access code

If the -symbol appears on the local display in front of a parameter, the parameter is write-protected by a user-specific access code and its value cannot be changed at the moment using local operation → 177.

Parameter write protection via local operation can be disabled by entering the user-specific access code in the **Enter access code** parameter (→ 155) via the respective access option.

1. After you press , the input prompt for the access code appears.

2. Enter the access code.
 - ↳ The -symbol in front of the parameters disappears; all previously write-protected parameters are now re-enabled.

8.3.12 Enabling and disabling the keypad lock

The keypad lock makes it possible to block access to the entire operating menu via local operation. As a result, it is no longer possible to navigate through the operating menu or change the values of individual parameters. Users can only read the measured values on the operational display.

The keypad lock is switched on and off via the context menu.

Switching on the keypad lock

-  The keypad lock is switched on automatically:
- If the device has not been operated via the display for > 1 minute.
 - Each time the device is restarted.

To activate the keylock manually:

1. The device is in the measured value display.
Press  for at least 2 seconds.
 - ↳ A context menu appears.
2. In the context menu select the **Keylock on** option.
 - ↳ The keypad lock is switched on.

-  If the user attempts to access the operating menu while the keypad lock is active, the **Keylock on** message appears.

Switching off the keypad lock



1. The keypad lock is switched on.
Press  for at least 2 seconds.
 - ↳ A context menu appears.
2. In the context menu select the **Keylock off** option.
 - ↳ The keypad lock is switched off.

8.4 Access to the operating menu via the Web browser

8.4.1 Function range

Thanks to the integrated Web server, the device can be operated and configured via a Web browser and via a service interface (CDI-RJ45) or via a WLAN interface. The structure of the operating menu is the same as for the local display. In addition to the measured values, status information on the device is also displayed and allows the user to monitor the status of the device. Furthermore the device data can be managed and the network parameters can be configured.

A device that has a WLAN interface (can be ordered as an option) is required for the WLAN connection: order code for "Display; operation", option **G** "4-line, illuminated; touch control + WLAN". The device acts as an Access Point and enables communication by computer or a mobile handheld terminal.

-  For additional information on the Web server, refer to the Special Documentation for the device →  264

8.4.2 Prerequisites



Computer hardware

Hardware	Interface	
	CDI-RJ45	WLAN
Interface	The computer must have an RJ45 interface.	The operating unit must have a WLAN interface.
Connection	Standard Ethernet cable with RJ45 connector.	Connection via Wireless LAN.
Screen	Recommended size: ≥ 12" (depends on the screen resolution)	

Computer software



Software	Interface	
	CDI-RJ45	WLAN
Recommended operating systems	<ul style="list-style-type: none"> ▪ Microsoft Windows 7 or higher. ▪ Mobile operating systems: <ul style="list-style-type: none"> - iOS - Android <p> Microsoft Windows XP is supported.</p>	
Web browsers supported	<ul style="list-style-type: none"> ▪ Microsoft Internet Explorer 8 or higher ▪ Microsoft Edge ▪ Mozilla Firefox ▪ Google Chrome ▪ Safari 	

Computer settings



Settings	Interface	
	CDI-RJ45	WLAN
User rights	Appropriate user rights (e.g. administrator rights) for TCP/IP and proxy server settings are necessary (for adjusting the IP address, subnet mask etc.).	
Proxy server settings of the Web browser	The Web browser setting <i>Use a Proxy Server for Your LAN</i> must be deselected .	
JavaScript	JavaScript must be enabled. <p> If JavaScript cannot be enabled: enter <code>http://192.168.1.212/basic.html</code> in the address line of the Web browser. A fully functional but simplified version of the operating menu structure starts in the Web browser.</p> <p> When installing a new firmware version: To enable correct data display, clear the temporary memory (cache) of the Web browser under Internet options.</p>	
Network connections	Only the active network connections to the measuring device should be used.	
	Switch off all other network connections such as WLAN.	Switch off all other network connections.

 In the event of connection problems: →  195

Measuring device: Via CDI-RJ45 service interface

Device	CDI-RJ45 service interface
Measuring device	The measuring device has an RJ45 interface.
Web server	Web server must be enabled; factory setting: ON  For information on enabling the Web server → 89
IP address	If the IP address of the device is not known: <ul style="list-style-type: none"> ▪ The IP address can be read out via local operation: Diagnostics → Device information → IP address ▪ Communication with the Web server can be established via the default IP address 192.168.1.212. The DHCP function is enabled in the device at the factory, i.e. the device expects an IP address to be assigned by the network. This function can be disabled and the device can be set to the default IP address 192.168.1.212: set DIP switch No. 4 from OFF → ON .  Set the default IP address → 65.

Measuring device: via WLAN interface

Device	WLAN interface
Measuring device	The measuring device has a WLAN antenna: <ul style="list-style-type: none"> ▪ Transmitter with integrated WLAN antenna ▪ Transmitter with external WLAN antenna
Web server	Web server and WLAN must be enabled; factory setting: ON  For information on enabling the Web server → 89
IP address	If the IP address of the device is not known: <ul style="list-style-type: none"> ▪ The IP address can be read out via local operation: Diagnostics → Device information → IP address ▪ Communication with the Web server can be established via the default IP address 192.168.1.212. The DHCP function is enabled in the device at the factory, i.e. the device expects an IP address to be assigned by the network. This function can be disabled and the device can be set to the default IP address 192.168.1.212: set DIP switch No. 4 from OFF → ON .  Set the default IP address → 65.

8.4.3 Establishing a connection

Via service interface (CDI-RJ45)

Preparing the measuring device

Proline 500 – digital

1. Loosen the 4 fixing screws on the housing cover.
2. Open the housing cover.
3. The location of the connection socket depends on the measuring device and the communication protocol:
 Connect the computer to the RJ45 connector via the standard Ethernet connecting cable .

Proline 500

1. Depending on the housing version:
 Release the securing clamp or securing screw of the housing cover.

2. Depending on the housing version:
Unscrew or open the housing cover.
3. The location of the connection socket depends on the measuring device and the communication protocol:
Connect the computer to the RJ45 connector via the standard Ethernet connecting cable .

Configuring the Internet protocol of the computer

The IP address can be assigned to the measuring device in a variety of ways:

- Dynamic Host Configuration Protocol (DHCP), factory setting:
The IP address is automatically assigned to the measuring device by the automation system (DHCP server).
- Hardware addressing:
The IP address is set via DIP switches → 64.
- Software addressing:
The IP address is entered via the **IP address** parameter (→ 118) .
- DIP switch for "Default IP address":
To establish the network connection via the service interface (CDI-RJ45): the fixed IP address 192.168.1.212 is used → 65.

The measuring device works with the Dynamic Host Configuration Protocol (DHCP), on leaving the factory, i.e. the IP address of the measuring device is automatically assigned by the automation system (DHCP server).

To establish a network connection via the service interface (CDI-RJ45): the "Default IP address" DIP switch must be set to **ON**. The measuring device then has the fixed IP address: 192.168.1.212. This address can now be used to establish the network connection.

1. Via DIP switch 2, activate the default IP address 192.168.1.212: → 65.
2. Switch on the measuring device.
3. Connect to the computer using a cable → 91.
4. If a 2nd network card is not used, close all the applications on the notebook.
 - ↳ Applications requiring Internet or a network, such as e-mail, SAP applications, Internet or Windows Explorer.
5. Close any open Internet browsers.
6. Configure the properties of the Internet protocol (TCP/IP) as defined in the table:

IP address	192.168.1.XXX; for XXX all numerical sequences except: 0, 212 and 255 → e.g. 192.168.1.213
Subnet mask	255.255.255.0
Default gateway	192.168.1.212 or leave cells empty

Via WLAN interface

Configuring the Internet protocol of the mobile terminal

NOTICE

If the WLAN connection is lost during the configuration, settings made may be lost.

- ▶ Make sure that the WLAN connection is not disconnected while configuring the device.

NOTICE

In principle, avoid simultaneous access to the measuring device via the service interface (CDI-RJ45) and the WLAN interface from the same mobile terminal. This could cause a network conflict.

- ▶ Only activate one service interface (CDI-RJ45 service interface or WLAN interface).
- ▶ If simultaneous communication is necessary: configure different IP address ranges, e.g. 192.168.0.1 (WLAN interface) and 192.168.1.212 (CDI-RJ45 service interface).

Preparing the mobile terminal

- ▶ Enable WLAN reception on the mobile terminal.

Establishing a connection from the mobile terminal to the measuring device

1. In the WLAN settings of the mobile terminal:
Select the measuring device using the SSID (e.g. EH_Promass_500_A802000).
2. If necessary, select the WPA2 encryption method.
3. Enter the password: serial number of the measuring device ex-works (e.g. L100A802000).
 - ↳ LED on display module flashes: it is now possible to operate the measuring device with the Web browser, FieldCare or DeviceCare.

 The serial number can be found on the nameplate.

 To ensure the safe and swift assignment of the WLAN network to the measuring point, it is advisable to change the SSID name. It should be possible to clearly assign the new SSID name to the measuring point (e.g. tag name) because it is displayed as the WLAN network.

Disconnecting

- ▶ After configuring the device:
Terminate the WLAN connection between the operating unit and measuring device.

Starting the Web browser

1. Start the Web browser on the computer.

2. Enter the IP address of the Web server in the address line of the Web browser:
192.168.1.212
↳ The login page appears.

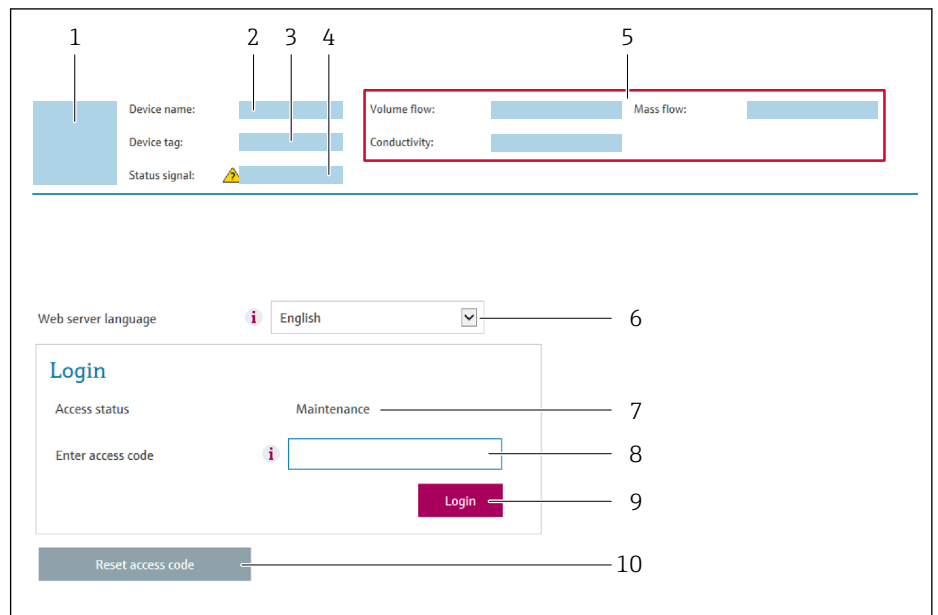

A0029417

- 1 Picture of device
- 2 Device name
- 3 Device tag
- 4 Status signal
- 5 Current measured values
- 6 Operating language
- 7 User role
- 8 Access code
- 9 Login
- 10 Reset access code (→ 173)

i If a login page does not appear, or if the page is incomplete → 195

8.4.4 Logging on

1. Select the preferred operating language for the Web browser.
2. Enter the user-specific access code.
3. Press **OK** to confirm your entry.

Access code	0000 (factory setting); can be changed by customer
--------------------	--

i If no action is performed for 10 minutes, the Web browser automatically returns to the login page.

8.4.5 User interface

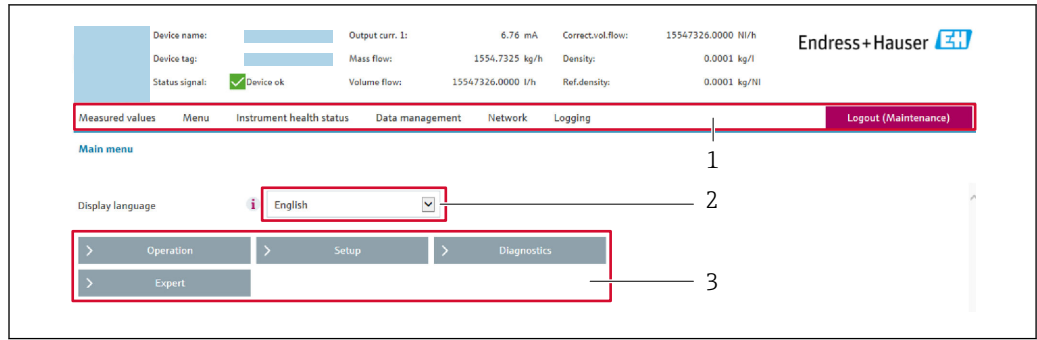

A0029418

- 1 Function row
- 2 Local display language
- 3 Navigation area

Header

The following information appears in the header:

- Device name
- Device tag
- Device status with status signal → 📄 203
- Current measured values

Function row

Functions	Meaning
Measured values	Displays the measured values of the measuring device
Menu	<ul style="list-style-type: none"> ■ Access to the operating menu from the measuring device ■ The structure of the operating menu is the same as for the local display <p>📖 For detailed information on the structure of the operating menu, see the Operating Instructions for the measuring device</p>
Device status	Displays the diagnostic messages currently pending, listed in order of priority
Data management	<p>Data exchange between PC and measuring device:</p> <ul style="list-style-type: none"> ■ Device configuration: <ul style="list-style-type: none"> - Load settings from the device (XML format, save configuration) - Save settings to the device (XML format, restore configuration) ■ Logbook - Export Event logbook (.csv file) ■ Documents - Export documents: <ul style="list-style-type: none"> - Export backup data record (.csv file, create documentation of the measuring point configuration) - Verification report (PDF file, only available with the "Heartbeat Verification" application package) ■ File for system integration - If using fieldbuses, upload device drivers for system integration from the measuring device: <ul style="list-style-type: none"> EtherNet/IP: EDS file ■ Firmware update - Flashing a firmware version
Network configuration	<p>Configuration and checking of all the parameters required for establishing the connection to the measuring device:</p> <ul style="list-style-type: none"> ■ Network settings (e.g. IP address, MAC address) ■ Device information (e.g. serial number, firmware version)
Logout	End the operation and call up the login page

Navigation area

If a function is selected in the function bar, the submenus of the function open in the navigation area. The user can now navigate through the menu structure.

Working area

Depending on the selected function and the related submenus, various actions can be performed in this area:

- Configuring parameters
- Reading measured values
- Calling up help text
- Starting an upload/download

8.4.6 Disabling the Web server

The Web server of the measuring device can be switched on and off as required using the **Web server functionality** parameter.

Navigation

"Expert" menu → Communication → Web server

Parameter overview with brief description

Parameter	Description	Selection	Factory setting
Web server functionality	Switch the Web server on and off.	<ul style="list-style-type: none"> ▪ Off ▪ HTML Off ▪ On 	On

Function scope of the "Web server functionality" parameter

Option	Description
Off	<ul style="list-style-type: none"> ▪ The web server is completely disabled. ▪ Port 80 is locked.
On	<ul style="list-style-type: none"> ▪ The complete functionality of the web server is available. ▪ JavaScript is used. ▪ The password is transferred in an encrypted state. ▪ Any change to the password is also transferred in an encrypted state.

Enabling the Web server

If the Web server is disabled it can only be re-enabled with the **Web server functionality** parameter via the following operating options:

- Via local display
- Via Bedientool "FieldCare"
- Via "DeviceCare" operating tool

8.4.7 Logging out

 Before logging out, perform a data backup via the **Data management** function (upload configuration from device) if necessary.

1. Select the **Logout** entry in the function row.
 - ↳ The home page with the Login box appears.
2. Close the Web browser.

- 3. If no longer needed:

Reset modified properties of the Internet protocol (TCP/IP) → 85.



If communication with the Web server was established via the default IP address 192.168.1.212, DIP switch No. 10 must be reset (from **ON** → **OFF**). Afterwards, the IP address of the device is active again for network communication.

8.5 Access to the operating menu via the operating tool

The structure of the operating menu in the operating tools is the same as for operation via the local display.

8.5.1 Connecting the operating tool

Via EtherNet/IP network

This communication interface is available in device versions with EtherNet/IP.

Star topology

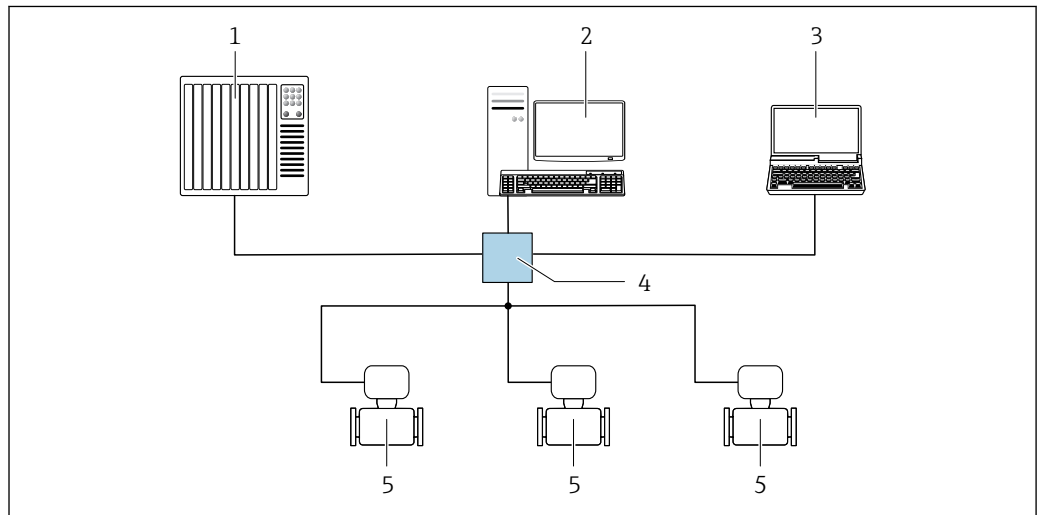

A0032078

29 Options for remote operation via EtherNet/IP network: star topology

- 1 Automation system, e.g. "RSLogix" (Rockwell Automation)
- 2 Workstation for measuring device operation: with Custom Add-On Profile for "RSLogix 5000" (Rockwell Automation) or with Electronic Data Sheet (EDS)
- 3 Computer with Web browser (e.g. Internet Explorer) for accessing the integrated device Web server or computer with operating tool (e.g. FieldCare, DeviceCare) with COM DTM "CDI Communication TCP/IP"
- 4 Ethernet switch
- 5 Measuring device

Ring topology

The device is integrated via the terminal connection for signal transmission (output 1) and the service interface (CDI-RJ45).

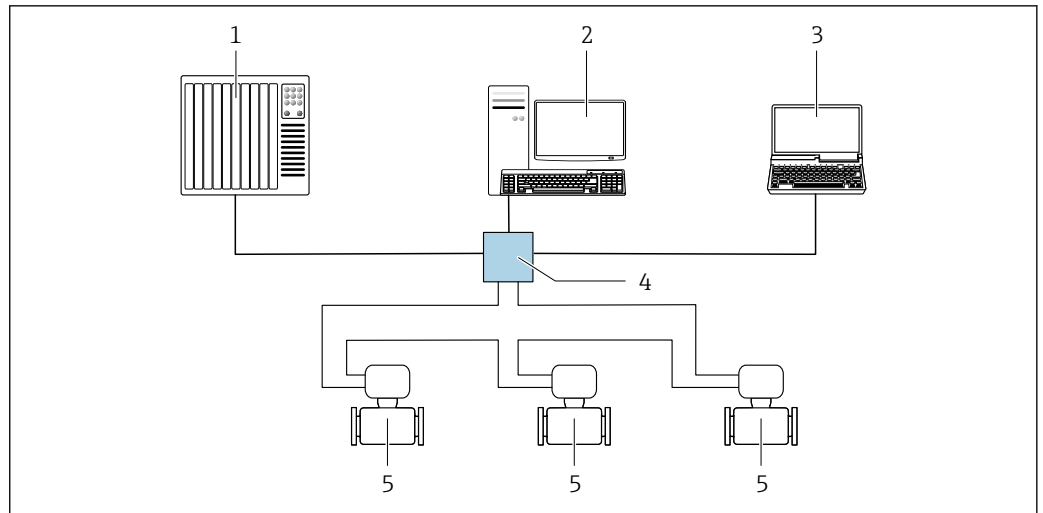

A0033725

30 Options for remote operation via EtherNet/IP network: ring topology

- 1 Automation system, e.g. "RSLogix" (Rockwell Automation)
- 2 Workstation for measuring device operation: with Custom Add-On Profile for "RSLogix 5000" (Rockwell Automation) or with Electronic Data Sheet (EDS)
- 3 Computer with Web browser (e.g. Internet Explorer) for accessing the integrated device Web server or computer with operating tool (e.g. FieldCare, DeviceCare) with COM DTM "CDI Communication TCP/IP"
- 4 Ethernet switch
- 5 Measuring device

Service interface

Via service interface (CDI-RJ45)

A point-to-point connection can be established to configure the device onsite. With the housing open, the connection is established directly via the service interface (CDI-RJ45) of the device.

i An adapter for RJ45 and the M12 connector is optionally available:
Order code for "Accessories", option **NB**: "Adapter RJ45 M12 (service interface)"

The adapter connects the service interface (CDI-RJ45) to an M12 connector mounted in the cable entry. Therefore the connection to the service interface can be established via an M12 connector without opening the device.

Proline 500 – digital transmitter

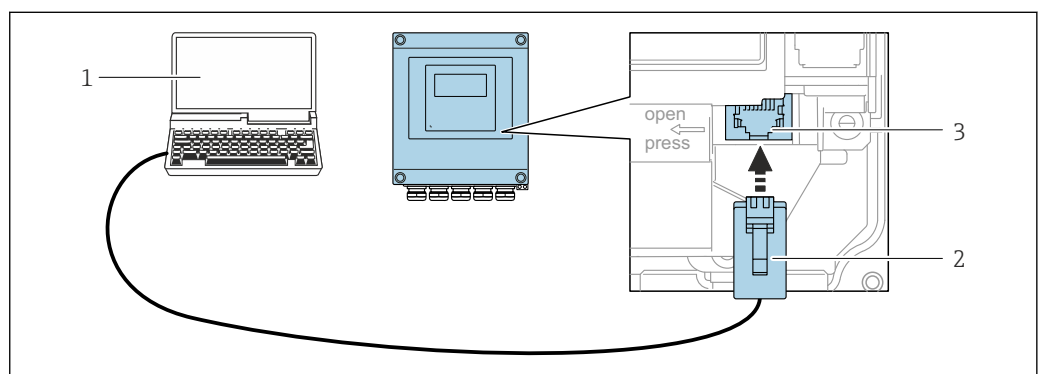

A0029163

31 Connection via service interface (CDI-RJ45)

- 1 Computer with Web browser (e.g. Microsoft Internet Explorer, Microsoft Edge) for accessing the integrated device Web server or with "FieldCare", "DeviceCare" operating tool with COM DTM "CDI Communication TCP/IP"
- 2 Standard Ethernet connecting cable with RJ45 connector
- 3 Service interface (CDI-RJ45) of the measuring device with access to the integrated Web server

Proline 500 transmitter

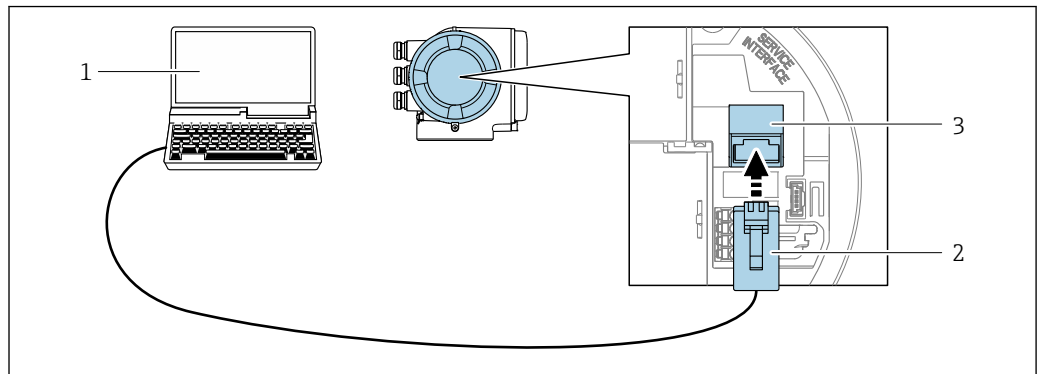

A0027563

32 Connection via service interface (CDI-RJ45)

- 1 Computer with Web browser (e.g. Microsoft Internet Explorer, Microsoft Edge) for accessing the integrated device Web server or with "FieldCare", "DeviceCare" operating tool with COM DTM "CDI Communication TCP/IP"
- 2 Standard Ethernet connecting cable with RJ45 connector
- 3 Service interface (CDI-RJ45) of the measuring device with access to the integrated Web server

Via WLAN interface

The optional WLAN interface is available on the following device version:
 Order code for "Display; operation", option **G** "4-line, illuminated, graphic display; touch control + WLAN"

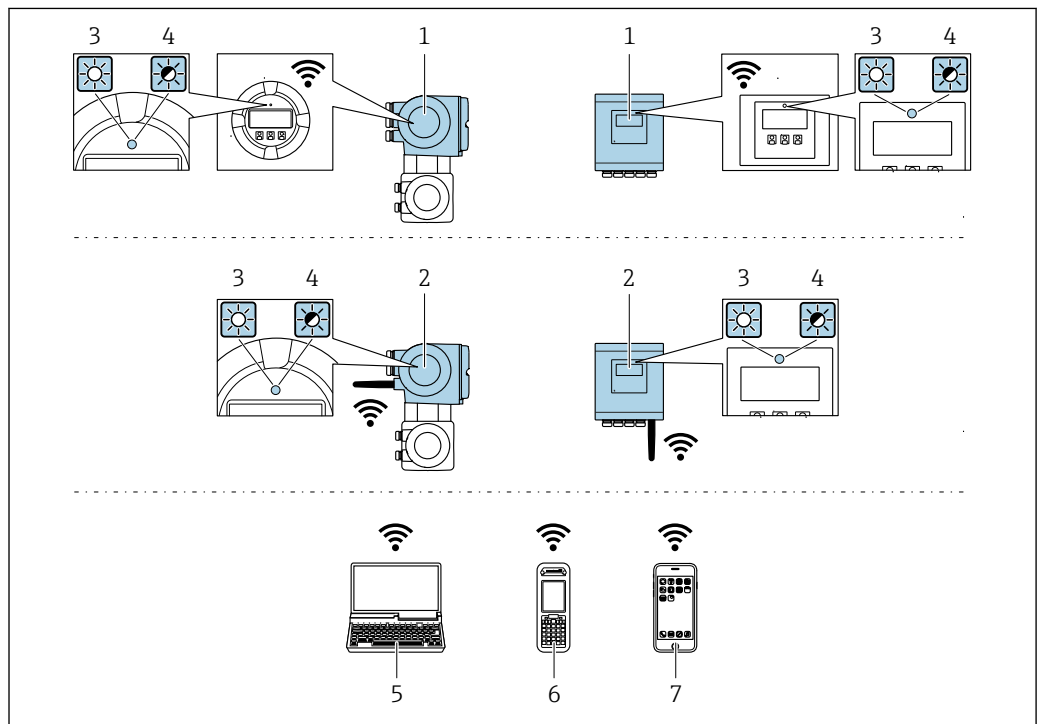

A0034569

- 1 Transmitter with integrated WLAN antenna
- 2 Transmitter with external WLAN antenna
- 3 LED lit constantly: WLAN reception is enabled on measuring device
- 4 LED flashing: WLAN connection established between operating unit and measuring device
- 5 Computer with WLAN interface and Web browser (e.g. Microsoft Internet Explorer, Microsoft Edge) for accessing the integrated device Web server or with operating tool (e.g. FieldCare, DeviceCare)
- 6 Mobile handheld terminal with WLAN interface and Web browser (e.g. Microsoft Internet Explorer, Microsoft Edge) for accessing the integrated device Web server or operating tool (e.g. FieldCare, DeviceCare)
- 7 Smartphone or tablet

Function	WLAN: IEEE 802.11 b/g (2.4 GHz) <ul style="list-style-type: none"> ▪ Access point with DHCP server (default setting) ▪ Network
Encryption	WPA2-PSK/AES 128 bit
Configurable WLAN channels	1 to 11
Degree of protection	IP67
Available antennas	<ul style="list-style-type: none"> ▪ Internal antenna ▪ External antenna (optional) In the event of poor transmission/reception conditions at the place of installation.  Only one antenna active in each case!
Max. range	50 m (164 ft)
Materials: External WLAN antenna	<ul style="list-style-type: none"> ▪ Antenna: ASA plastic (acrylic ester-styrene-acrylonitrile) and nickel-plated brass ▪ Adapter: Stainless steel and nickel-plated brass ▪ Cable: Polyethylene ▪ Connector: Nickel-plated brass ▪ Angle bracket: Stainless steel

Configuring the Internet protocol of the mobile terminal

NOTICE

If the WLAN connection is lost during the configuration, settings made may be lost.

- ▶ Make sure that the WLAN connection is not disconnected while configuring the device.

NOTICE

In principle, avoid simultaneous access to the measuring device via the service interface (CDI-RJ45) and the WLAN interface from the same mobile terminal. This could cause a network conflict.

- ▶ Only activate one service interface (CDI-RJ45 service interface or WLAN interface).
- ▶ If simultaneous communication is necessary: configure different IP address ranges, e.g. 192.168.0.1 (WLAN interface) and 192.168.1.212 (CDI-RJ45 service interface).

Preparing the mobile terminal

- ▶ Enable WLAN reception on the mobile terminal.

Establishing a connection from the mobile terminal to the measuring device

1. In the WLAN settings of the mobile terminal:
Select the measuring device using the SSID (e.g. EH_Promass_500_A802000).
2. If necessary, select the WPA2 encryption method.
3. Enter the password: serial number of the measuring device ex-works (e.g. L100A802000).
 - ↳ LED on display module flashes: it is now possible to operate the measuring device with the Web browser, FieldCare or DeviceCare.

 The serial number can be found on the nameplate.

 To ensure the safe and swift assignment of the WLAN network to the measuring point, it is advisable to change the SSID name. It should be possible to clearly assign the new SSID name to the measuring point (e.g. tag name) because it is displayed as the WLAN network.

Disconnecting



- ▶ After configuring the device:
Terminate the WLAN connection between the operating unit and measuring device.

8.5.2 FieldCare

Function scope

FDT-based plant asset management tool from Endress+Hauser. It can configure all smart field devices in a system and helps you manage them. By using the status information, it is also a simple but effective way of checking their status and condition.

Access is via:

- CDI-RJ45 service interface →  91
- WLAN interface →  92

Typical functions:

- Configuring parameters of transmitters
- Loading and saving device data (upload/download)
- Documentation of the measuring point
- Visualization of the measured value memory (line recorder) and event logbook



For additional information about FieldCare, see Operating Instructions BA00027S and BA00059S

Source for device description files

See information →  96

Establishing a connection

1. Start FieldCare and launch the project.
2. In the network: Add a device.
 - ↳ The **Add device** window opens.
3. Select the **CDI Communication TCP/IP** option from the list and press **OK** to confirm.
4. Right-click **CDI Communication TCP/IP** and select the **Add device** option in the context menu that opens.
5. Select the desired device from the list and press **OK** to confirm.
 - ↳ The **CDI Communication TCP/IP (Configuration)** window opens.
6. Enter the device address in the **IP address** field: 192.168.1.212 and press **Enter** to confirm.
7. Establish the online connection to the device.



For additional information, see Operating Instructions BA00027S and BA00059S

User interface

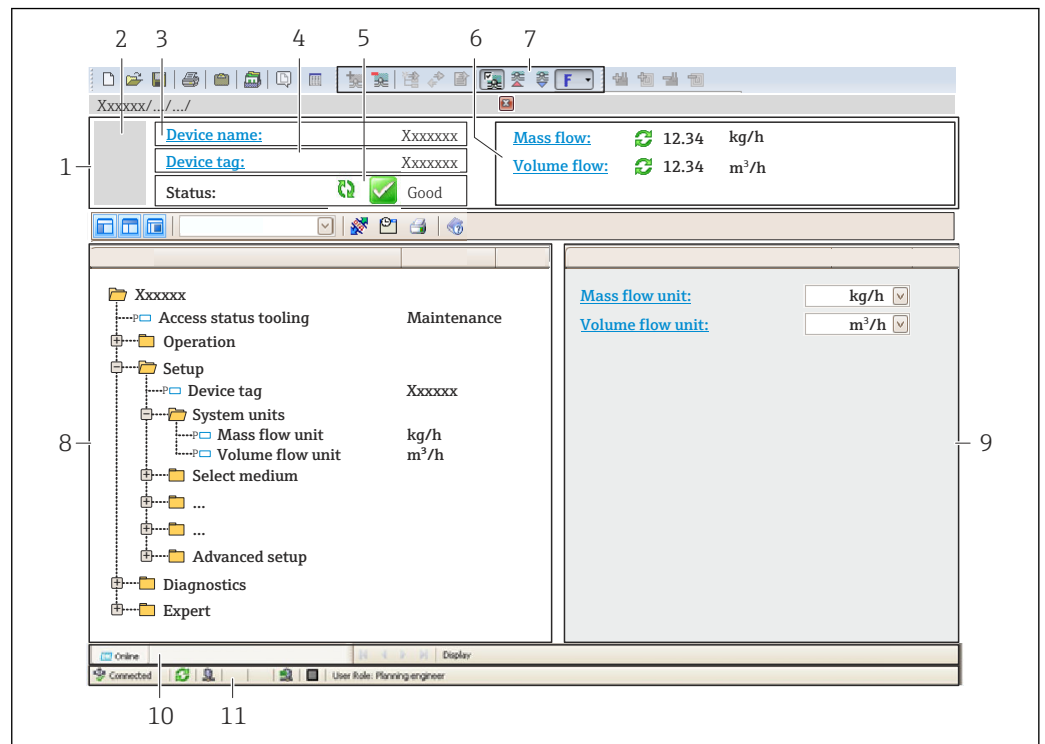

A0021051-EN

- 1 Header
- 2 Picture of device
- 3 Device name
- 4 Tag name
- 5 Status area with status signal → 203
- 6 Display area for current measured values
- 7 Edit toolbar with additional functions such as save/restore, event list and create documentation
- 8 Navigation area with operating menu structure
- 9 Working area
- 10 Range of action
- 11 Status area

8.5.3 DeviceCare

Function scope

Tool to connect and configure Endress+Hauser field devices.

The fastest way to configure Endress+Hauser field devices is with the dedicated "DeviceCare" tool. Together with the device type managers (DTMs) it presents a convenient, comprehensive solution.

 For details, see Innovation Brochure IN01047S

Source for device description files

See information →  96

9 System integration

9.1 Overview of device description files

9.1.1 Current version data for the device

Firmware version	01.00.zz	<ul style="list-style-type: none"> ▪ On the title page of the Operating Instructions ▪ On the transmitter nameplate ▪ Firmware version Diagnostics → Device information → Firmware version
Release date of firmware version	10.2017	---
Manufacturer ID	0x11	Manufacturer ID Diagnostics → Device information → Manufacturer ID
Device type ID	0x103B	Device type Diagnostics → Device information → Device type
Device revision	<ul style="list-style-type: none"> ▪ Major revision 1 ▪ Minor revision 1 	<ul style="list-style-type: none"> ▪ On the transmitter nameplate ▪ Device revision Diagnostics → Device information → Device revision
Device profile	Generic device (product type: 0x2B)	



For an overview of the different firmware versions for the device → 225

9.1.2 Operating tools

The suitable device description file for the individual operating tools is listed in the table below, along with information on where the file can be acquired.

Operating tool via Service interface (CDI)	Sources for obtaining device descriptions
FieldCare	<ul style="list-style-type: none"> ▪ www.endress.com → Download Area ▪ CD-ROM (contact Endress+Hauser) ▪ DVD (contact Endress+Hauser)
DeviceCare	<ul style="list-style-type: none"> ▪ www.endress.com → Download Area ▪ CD-ROM (contact Endress+Hauser) ▪ DVD (contact Endress+Hauser)

9.2 Overview of system files

System files	Version	Description	How to acquire
Electronic Data Sheet (EDS system file)	2.1	Certified in accordance with the following ODVA guidelines: <ul style="list-style-type: none"> ▪ Conformance test ▪ Performance test ▪ PlugFest Embedded EDS Support (File Object 0x37)	<ul style="list-style-type: none"> ▪ www.endress.com → Download-Area ▪ EDS system file integrated in the device: can be downloaded via the Web browser
Add-on Profile Level 3	<ul style="list-style-type: none"> ▪ Major revision 1 ▪ Minor revision 1 	System file for "Studio 5000" software (Rockwell Automation)	www.endress.com → Download-Area

9.3 Integrating the measuring device in the system

 A detailed description of how to integrate the device into an automation system (e.g. from Rockwell Automation) is available as a separate document: www.endress.com → Select country → Automation → Digital communication → Fieldbus device integration → EtherNet/IP











 Protocol-specific data →  240.

9.4 Cyclic data transmission

Cyclic data transmission when using the device master file (GSD).

9.4.1 Block model

The block model shows which input and output data the measuring device makes available for implicit messaging. Cyclical data exchange is performed using an EtherNet/IP scanner, e.g. a distributed control system etc.

Measuring device			Control system
Transducer Block	Input Assembly Fix (Assem100) 44 byte	→  99	Permanently assigned input group →
	Mass flow fixed input assembly (Assem106) 32 byte	→  100	Permanently assigned input group →
	Volume flow fixed input assembly (Assem107) 62 byte	→  100	Permanently assigned input group →
	Concentration fixed input assembly ¹⁾ (Assem109) 66 byte	→  100	Permanently assigned input group →
	API Referenced corrections fixed input assembly ²⁾ (Assem110) 64 byte	→  101	Permanently assigned input group →
	Water cut % fixed input assembly ²⁾ (Assem111) 80 byte	→  101	Permanently assigned input group →
	Heartbeat monitoring fixed input assembly ³⁾ (Assem112) 96 byte	→  101	Permanently assigned input group →
	Input assembly custom (Assem101) 88 byte	→  102	Configurable input group →
	Output assembly fix (Assem102) 54 byte	→  103	Permanently assigned output group ←
	Config assembly (Assem104) 2709 byte	→  105	Permanently assigned configuration →
			EtherNet/IP

- 1) Only available with the Concentration application package.
- 2) Only available with the Petroleum application package.
- 3) Only available with the Heartbeat Verification application package.

9.4.2 Input and output groups

Possible configurations

Configuration 1: Exclusive Owner Multicast

Input Assembly Fix		Instance	Size (byte)	Min. RPI (ms)
Input Assembly Configurable	Configuration	0 x 64	398	-
Output Assembly Fix	O → T Configuration	0 x 66	64	5
Input Assembly Fix	T → O Configuration	0 x 64	44	5

Configuration 2: Input Only Multicast

Input Assembly Fix		Instance	Size (byte)	Min. RPI (ms)
Input Assembly Configurable	Configuration	0 x 68	398	-
Output Assembly Fix	O → T Configuration	0 x C7	-	-
Input Assembly Fix	T → O Configuration	0 x 64	44	5

Configuration 3: Exclusive Owner Multicast

Input Assembly Configurable		Instance	Size (byte)	Min. RPI (ms)
Input Assembly Configurable	Configuration	0 x 68	398	-
Output Assembly Fix	O → T Configuration	0 x 66	64	5
Input Assembly Fix	T → O Configuration	0 x 65	88	5

Configuration 4: Input Only Multicast

Input Assembly Configurable		Instance	Size (byte)	Min. RPI (ms)
Input Assembly Configurable	Configuration	0 x 68	398	-
Output Assembly Fix	O → T Configuration	0 x C7	-	-
Input Assembly Fix	T → O Configuration	0 x 64	88	5

Configuration 5: Exclusive Owner Multicast

Input Assembly Fix		Instance	Size (byte)	Min. RPI (ms)
Input Assembly Configurable	Configuration	0 x 69	-	-
Output Assembly Fix	O → T Configuration	0 x 66	64	5
Input Assembly Fix	T → O Configuration	0 x 64	44	5

Configuration 6: Input Only Multicast

Input Assembly Fix		Instance	Size (byte)	Min. RPI (ms)
Input Assembly Configurable	Configuration	0 x 69	-	-
Output Assembly Fix	O → T Configuration	0 x C7	-	-
Input Assembly Fix	T → O Configuration	0 x 65	44	5

Configuration 7: Exclusive Owner Multicast

Input Assembly Configurable		Instance	Size (byte)	Min. RPI (ms)
Input Assembly Configurable	Configuration	0 x 69	–	–
Output Assembly Fix	O → T Configuration	0 x 66	64	5
Input Assembly Fix	T → O Configuration	0 x 64	88	5

Configuration 8: Input Only Multicast

Input Assembly Configurable		Instance	Size (byte)	Min. RPI (ms)
Input Assembly Configurable	Configuration	0 x 69	–	–
Output Assembly Fix	O → T Configuration	0 x C7	–	–
Input Assembly Fix	T → O Configuration	0 x 65	88	5

Possible connections

No.	#1	#2	#3	#4	#5	#6	#7	#8	#9
Number of connections	1	1	1	1	1	1	1	1	1
Input assembly fixed (Assem100)	X								
Mass flow fixed input assembly (Assem106)		X							
Volume flow fixed input assembly (Assem107)			X						
Input assembly custom (Assem101)				X					
Viscosity fixed input assembly (Assem108)					X				
Concentration fixed input assembly (Assem109)						X			
API Referenced corrections fixed input assembly (Assem110)							X		
Water cut % fixed input assembly (Assem111)								X	
Heartbeat monitoring fixed input assembly (Assem112)									X

Permanently assigned input group*Input assembly fixed (Assem100), 44 byte*

Description	Byte
1. File header (not visible)	1-4
2. Current diagnosis ¹⁾	5-8
3. Mass flow	9-12
4. Volume flow	13-16
5. Corrected volume flow	17-20
6. Temperature	21-24
7. Density	25-28
8. Reference density	29-32
9. Totalizer 1	33-36

Description	Byte
10. Totalizer 2	37-40
11. Totalizer 3	41-44

1) Diagnostic information via EtherNet/IP → ⓘ 108

Mass flow fixed input assembly (Assem106), 32 byte

Description	Byte
1. File header (not visible)	1-4
2. Current diagnosis ¹⁾	5-8
3. Mass flow	9-12
4. Density	13-16
5. Temperature	17-20
6. Totalizer 1	21-24
7. Mass flow unit	25-26
8. Density unit	27-28
9. Temperature unit	29-30
10. Totalizer 1 unit	31-32

1) Diagnostic information via EtherNet/IP → ⓘ 108

Volume flow fixed input assembly (Assem107), 62 byte

Description	Byte
1. Mass flow fixed input assembly	1-32
2. Volume flow	33-36
3. Corrected volume flow	37-40
4. Reference density	41-44
5. Totalizer 2	45-48
6. Totalizer 3	49-52
7. Volume flow unit	53-54
8. Corrected volume flow unit	55-56
9. Reference density unit	57-58
10. Totalizer 2 unit	59-60
11. Totalizer 3 unit	61-62

Concentration fixed input assembly (Assem109), 66 byte ¹⁾

Description	Byte
1. Mass flow fixed input assembly	1-32
2. Target mass flow	33-36
3. Carrier mass flow	37-40
4. Target volume flow	41-44
5. Carrier volume flow	45-48
6. Target corrected volume flow	49-52
7. Carrier corrected volume flow	53-56

Description	Byte
8. Concentration	57-60
9. Volume flow unit	61-62
10. Corrected volume flow unit	63-64
11. Concentration unit	65-66

1) Only available with the Concentration application package.

API Referenced corrections fixed input assembly (Assem110), 60 byte ¹⁾

Description	Byte
1. Mass flow fixed input assembly	1-32
2. Alternative reference density	33-36
3. GSV flow	37-40
4. Alternative GSV flow	41-44
5. NSV flow	45-48
6. Alternative NSV flow	49-52
7. S&W volume flow	53-56
8. Volume flow unit	57-58
9. Reference density unit	59-60

1) Only available with the Petroleum application package.

Water cut % fixed input assembly (Assem111), 76 byte ¹⁾

Description	Byte
1. Mass flow fixed input assembly	1-32
2. Oil density	33-36
3. Water density	37-40
4. Water cut %	41-44
5. Oil mass flow	45-48
6. Water mass flow	49-52
7. Oil volume flow	53-56
8. Water volume flow	57-60
9. Oil corrected volume flow	61-64
10. Water corrected volume flow	65-68
11. Volume flow unit	69-70
12. Corrected volume flow unit	71-72
13. Oil density unit	73-74
14. Water density unit	75-76

1) Only available with the Petroleum application package

Heartbeat monitoring fixed input assembly (Assem112), 100 byte ¹⁾

Description	Byte
1. Mass flow fixed input assembly	1-32
2. Signal asymmetry	33-36

Description	Byte
3. Oscillation frequency 0	37-40
4. Oscillation frequency 1	41-44
5. Oscillation amplitude 0	45-48
6. Oscillation amplitude 1	49-52
7. Oscillation damping 0	53-56
8. Oscillation damping 1	57-60
9. Tube damping fluctuation 0	61-64
10. Tube damping fluctuation 1	65-68
11. Exciter current 0	69-72
12. Exciter current 1	73-76
13. HBSI	77-80
14. Frequency fluctuation 0	81-84
15. Frequency fluctuation 1	85-88
16. Electronic temperature	89-92
17. Carrier pipe temperature	93-96
18. Verification status	97-98
19. Verification results	99-100

1) Only available with the Heartbeat Verification application package.

Configurable input group

Input assembly custom (Assem101), 88 byte

Description	Format
1. - 10. Input values 1 to 10	Real
11. - 20. Input values 11 to 20	Double integer

Possible input values

Possible input values 1 to 10:		
<ul style="list-style-type: none"> ▪ Off ▪ Mass flow ▪ Volume flow ▪ Corrected volume flow ▪ Target mass flow ¹⁾ ▪ Carrier mass flow ¹⁾ ▪ Target volume flow ¹⁾ ▪ Carrier volume flow ¹⁾ ▪ Target corrected volume flow ¹⁾ ▪ Carrier corrected volume flow ¹⁾ ▪ Density ▪ Reference density ▪ Concentration ¹⁾ 	<ul style="list-style-type: none"> ▪ Temperature ▪ Carrier tube temperature ²⁾ ▪ Electronic temperature ▪ Oscillation frequency 0 ▪ Oscillation frequency 1 ²⁾ ▪ Oscillation amplitude 0 ▪ Oscillation amplitude 1 ²⁾ ▪ Frequency fluctuation 0 ▪ Frequency fluctuation 1 ²⁾ ▪ Oscillation damping 0 ▪ Oscillation damping 1 ▪ Tube damping fluctuation 0 ▪ Tube damping fluctuation 1 ▪ Signal asymmetry 	<ul style="list-style-type: none"> ▪ Exciter current 0 ▪ Exciter current 1 ²⁾ ▪ Monitoring of exciter current 0 ▪ Monitoring of exciter current 1 ²⁾ ▪ HBSI ²⁾ ▪ Totalizer 1 ▪ Totalizer 2 ▪ Totalizer 3 ▪ Alternative reference density ³⁾ ▪ GSV flow ³⁾ ▪ Alternative GSV flow ³⁾ ▪ NSV flow ³⁾ ▪ Alternative NSV flow ³⁾ ▪ S&W volume flow ³⁾

1) Only available with the Concentration application package.

2) Only available with the Heartbeat Verification application package.

3) Only available with the Petroleum application package.

Possible input values 11 to 20:		
<ul style="list-style-type: none"> ▪ Off ▪ Actual diagnostics ▪ Previous diagnosis ▪ Mass flow unit ▪ Volume flow unit ▪ Corrected volume flow unit 	<ul style="list-style-type: none"> ▪ Temperature unit ▪ Density unit ▪ Reference density unit ▪ Concentration unit ▪ Current unit 	<ul style="list-style-type: none"> ▪ Totalizer 1 unit ▪ Totalizer 2 unit ▪ Totalizer 3 unit ▪ Verification results ▪ Verification status ▪ Status zero point adjustment

Permanently assigned output group

Output assembly fix (Assem102), 54 byte

Description (format)	Byte	Bit	Value
1. Totalizer 1	1	0	<ul style="list-style-type: none"> ▪ 0: Enable ▪ 1: Disable
2. Totalizer 2		1	
3. Totalizer 3		2	
4. Verification		3	
5. Concentration of medium type		4	
6. Compensation, pressure		5	
7. Reference density compensation		6	
8. Compensation, temperature		7	
9. S&W correction value %	2	0	<ul style="list-style-type: none"> ▪ 0: Enable ▪ 1: Disable
10. Water cut %		1	
11. Flow override		2	
12. Zero point adjustment		3	
13. Not used		4	
14. Not used		5	
15. Not used		6	
16. Not used		7	
17. Not used	3-4	16	-
18. Control totalizer 1 (integer)	5-6	16	<ul style="list-style-type: none"> ▪ 32226 (0): Add ▪ 32490 (1): Reset and stop ▪ 32228 (2): Default value and stop ▪ 198 (3): Reset and add ▪ 199 (4): Default value and add ▪ 32928 (3): Stop
19. Control totalizer 2 (integer)	7-8	16	
20. Control totalizer 3 (integer)	9-10	16	
21. Start verification (integer)	11-12	16	
			<ul style="list-style-type: none"> ▪ 32823 (0): Cancel ▪ 33158 (1): Start

Description (format)	Byte	Bit	Value
22. Select concentration of medium type	13-14	16	<ul style="list-style-type: none"> ■ 3062 (0) : Aqueous Fructose ■ 3063 (0) : Aqueous Glucose ■ 3068 (0) : Aqueous Hydrochloric Acid ■ 3077 (0) : Aqueous Hydrogen Peroxide ■ 3065 (0) : Aqueous Sucrose ■ 3064 (0) : Aqueous Invert Sugar ■ 3069 (0) : Aqueous Nitric Acid ■ 3070 (0) : Aqueous Phosphoric Acid ■ 3075 (0) : Aqueous Potassium Hydroxide ■ 3071 (0) : Aqueous Sodium Hydroxide ■ 3060 (0) : Ethanol Water ■ 3061 (0) : Methanol Water ■ 3066 (0) : Ammonium Nitrate In Water ■ 3067 (0) : Ferric Chloride In Water ■ 3073 (0) : High Fructose Corn Syrup 42 ■ 3074 (0) : High Fructose Corn Syrup 55 ■ 3072 (0) : High Fructose Corn Syrup 90 ■ 3092 (0) : Percent Volume / Percent Mass ■ 3081 (0) : Wort ■ 3082 (0) : Coef Set 1 ■ 3083 (0) : Coef Set 2 ■ 3084 (0) : Coef Set 3
23. Not used	15-16	16	–
24. External pressure (real)	17-20	32	Data format: Byte 1-4: External pressure Floating-point number (IEEE754)
25. External pressure unit (integer)	21-22	16	<ul style="list-style-type: none"> ■ 1610 (11): Pa a ■ 1616 (12): kPa a ■ 1614 (237): MPa a ■ 1137 (7): bar ■ 1611 (240): Pa g ■ 1617 (240): kPa a ■ 1615 (240): MPa a ■ 32797 (7): bar g ■ 1142 (6): psi a ■ 1143 (240): psi g
26. Not used	23-24	16	–
27. External reference density (real)	25-28	32	Data format: Byte 1-4: External ref. density Floating-point number (IEEE754)
28. External reference density unit (integer)	29-30	16	<ul style="list-style-type: none"> ■ 32840 (240): kg/Nm³ ■ 32841 (240): kg/Nl ■ 32842 (240): g/Scm³ ■ 32843 (240): kg/Scm³ ■ 32844 (240): lb/Sft³
29. Not used	31-32	16	–
30. External temperature (real)	33-36	32	Data format: Byte 1-4: External temperature Floating-point number (IEEE754)
31. External temperature unit (integer)	37-38	16	<ul style="list-style-type: none"> ■ 1001 (32): °C ■ 1002 (33): °F ■ 1000 (35): K ■ 1003 (34): °R
32. Not used	39-40	16	–

Description (format)	Byte	Bit	Value
33. External value % S&W (real)	41-44	32	Data format: Byte 1-4: External value, % S&W Floating-point number (IEEE754)
34. External value, water cut % (real)	45-48	32	Data format: Byte 1-4: External value, water cut % Floating-point number (IEEE754)
35 Flow override monitoring	49-50	16	<ul style="list-style-type: none"> ■ 33004 (0): Off ■ 33006 (1): On
36 Zero point adjustment monitoring	51-52	16	<ul style="list-style-type: none"> ■ 32823 (0): Cancel ■ 33242 (0): Active ■ 248 (0): Error zero point adjustment ■ 33158 (1): Start

Permanently assigned configuration group

Config assembly (Assem104), 2704 byte

Description (format)	Bits	Byte	Offset
1. None	32	4	0
2. Parameter 36 – Write protection	8	1	4
3. None	8	1	5
4. Parameter 87 System units Mass flow unit	16	2	6
5. Parameter 86 System units Mass unit	16	2	8
6. Parameter 93 System units Volume flow unit	16	2	10
7. Parameter 92 System units Volume unit	16	2	12
8. Parameter 80 System units Corrected volume flow unit	16	2	14
9. Parameter 79 System units Corrected volume unit	16	2	16
10. Parameter 81 System units Density unit	16	2	18
11. Parameter 89 System units Reference density unit	16	2	20
12. Parameter 91 System units Temperature unit	16	2	22
13. None	16	2	24
14. Parameter 88 System units Press. eng. unit	16	2	26
15. Parameter 85 System units Kinematic viscosity unit	16	2	28
16. Parameter 84 System units Dynamic viscosity unit	16	2	30
17. Parameter 78 System units Concentration unit	16	2	32
18. Parameter 82 System units Oil density unit	16	2	34
19. Parameter 83 System units Water density unit	16	2	36
20. Parameter 90 System units Water reference density unit	16	2	38
21. None	32	4	40
22. None	16	2	44
23. Parameter 224 – Enter access code	16	2	46
24. Parameter 94 Totalizer 1 Assign process variable	16	2	48
25. Parameter 106 Totalizer 1 Unit totalizer	16	2	50
26. Parameter 103 Totalizer 1 Totalizer operation mode	16	2	52
27. Parameter 100 Totalizer 1 Failure mode	16	2	54
28. Parameter 244 Totalizer operation Preset value tot. 1	32	4	56
29. Parameter 97 Totalizer operation Control totalizer 1	16	2	60

Description (format)				Bits	Byte	Offset
30.	Parameter 95	Totalizer 2	Assign process variable	16	2	62
31.	Parameter 107	Totalizer 2	Unit totalizer	16	2	64
32.	Parameter 104	Totalizer 2	Totalizer operation mode	16	2	66
33.	Parameter 101	Totalizer 2	Failure mode	16	2	68
34.	Parameter 98	Totalizer operation	Control totalizer 2	16	2	70
35.	Parameter 245	Totalizer operation	Preset value tot. 2	32	4	72
36.	Parameter 96	Totalizer 3	Assign process variable	16	2	76
37.	Parameter 108	Totalizer 3	Unit totalizer	16	2	78
38.	Parameter 105	Totalizer 3	Totalizer operation mode	16	2	80
39.	Parameter 102	Totalizer 3	Failure mode	16	2	82
40.	Parameter 246	Totalizer operation	Preset value tot. 3	32	4	84
41.	Parameter 99	Totalizer operation	Control totalizer 3	16	2	88
42.	Parameter 16	Configurable input assembly	Input assembly position 1	16	2	90
43.	Parameter 27	Configurable input assembly	Input assembly position 2	16	2	92
44.	Parameter 29	Configurable input assembly	Input assembly position 3	16	2	94
45.	Parameter 30	Configurable input assembly	Input assembly position 4	16	2	96
46.	Parameter 31	Configurable input assembly	Input assembly position 5	16	2	98
47.	Parameter 32	Configurable input assembly	Input assembly position 6	16	2	100
48.	Parameter 33	Configurable input assembly	Input assembly position 7	16	2	102
49.	Parameter 34	Configurable input assembly	Input assembly position 8	16	2	104
50.	Parameter 35	Configurable input assembly	Input assembly position 9	16	2	106
51.	Parameter 17	Configurable input assembly	Input assembly position 10	16	2	108
52.	Parameter 18	Configurable input assembly	Input assembly position 11	16	2	110
53.	Parameter 19	Configurable input assembly	Input assembly position 12	16	2	112
54.	Parameter 20	Configurable input assembly	Input assembly position 13	16	2	114
55.	Parameter 21	Configurable input assembly	Input assembly position 14	16	2	116
56.	Parameter 22	Configurable input assembly	Input assembly position 15	16	2	118
57.	Parameter 23	Configurable input assembly	Input assembly position 16	16	2	120
58.	Parameter 24	Configurable input assembly	Input assembly position 17	16	2	122
59.	Parameter 25	Configurable input assembly	Input assembly position 18	16	2	124
60.	Parameter 26	Configurable input assembly	Input assembly position 19	16	2	126
61.	Parameter 28	Configurable input assembly	Input assembly position 20	16	2	128
62.	Parameter 38	Sensor adjustment	Flow direction	16	2	130
63.	Parameter 40	Process parameter	Flow override	16	2	132
64.	Parameter 37	Low flow cut off	Assign process variable	16	2	134
65.	Parameter 39	Empty pipe detection	Assign process variable	16	2	136
66.	Parameter 41	Corrected volume flow calculation	Corrected volume flow calculation	16	2	138
67.	Parameter 188	Low flow cut off	On value low flow cut off	32	4	140
68.	Parameter 187	Low flow cut off	Off value low flow cutoff	32	4	144
69.	Parameter 209	Low flow cut off	Pressure shock suppression	32	4	148
70.	Parameter 191	Empty pipe detection	Low value partial filled pipe detection	32	4	152
71.	Parameter 189	Partially filled pipe detection	High value partial filled pipe detection	32	4	156
72.	Parameter 190	Empty pipe detection	Response time part. filled pipe detect.	32	4	160

Description (format)				Bits	Byte	Offset
73.	Parameter 182	Corrected volume flow calculation	Fixed reference density	32	4	164
74.	Parameter 186	Corrected volume flow calculation	Linear expansion coefficient	32	4	168
75.	Parameter 211	Corrected volume flow calculation	Square expansion coefficient	32	4	172
76.	Parameter 210	Corrected volume flow calculation	Reference temperature	32	4	176
77.	Parameter 183	Process parameter	Flow damping	32	4	180
78.	Parameter 184	Process parameter	Density damping	32	4	184
79.	Parameter 185	Process parameter	Temperature damping	32	4	188
80.	Parameter 5	External compensation	Pressure compensation	16	2	192
81.	Parameter 6	External compensation	Temperature mode	16	2	194
82.	Parameter 2	Medium selection	Select medium	16	2	196
83.	Parameter 3	Medium selection	Select gas type	16	2	198
84.	Parameter 119	External compensation	Pressure value	32	4	200
85.	Parameter 133	Medium selection	Temperature coefficient sound velocity	32	4	204
86.	Parameter 128	Medium selection	Reference sound velocity	32	4	208
87.	Parameter 115	Empty pipe detection	Max. damping empty pipe detection	32	4	212
88.	Parameter 241	Diagnostic settings	Alarm delay	32	4	216
89.	Parameter 58	Diagnostic behavior	Assign behavior for diagnostic information 046	8	1	220
90.	Parameter 57	Diagnostic behavior	Assign behavior for diagnostic information 140	8	1	221
91.	Parameter 59	Diagnostic behavior	Assign behavior for diagnostic information 144	8	1	222
92.	Parameter 60	Diagnostic behavior	Assign behavior for diagnostic information 374	8	1	223
93.	Parameter 61	Diagnostic behavior	Assign behavior for diagnostic information 302	8	1	224
94.	None			8	1	225
95.	Parameter 74	Diagnostic behavior	Assign behavior for diagnostic information 441	16	2	226
96.	Parameter 75	Diagnostic behavior	Assign behavior for diagnostic information 442	16	2	228
97.	Parameter 76	Diagnostic behavior	Assign behavior for diagnostic information 443	16	2	230
98.	Parameter 73	Diagnostic behavior	Assign behavior for diagnostic information 444	16	2	232
99.	Parameter 62	Diagnostic behavior	Assign behavior for diagnostic information 830	8	1	234
100.	Parameter 63	Diagnostic behavior	Assign behavior for diagnostic information 831	8	1	235
101.	Parameter 64	Diagnostic behavior	Assign behavior for diagnostic information 832	8	1	236
102.	Parameter 65	Diagnostic behavior	Assign behavior for diagnostic information 833	8	1	237
103.	Parameter 66	Diagnostic behavior	Assign behavior for diagnostic information 834	8	1	238
104.	Parameter 67	Diagnostic behavior	Assign behavior for diagnostic information 835	8	1	239
105.	Parameter 72	Diagnostic behavior	Assign behavior for diagnostic information 862	16	2	240

Description (format)				Bits	Byte	Offset
106.	Parameter 68	Diagnostic behavior	Assign behavior for diagnostic information 912	8	1	242
107.	Parameter 69	Diagnostic behavior	Assign behavior for diagnostic information 913	8	1	243
108.	Parameter 70	Diagnostic behavior	Assign behavior for diagnostic information 944	8	1	244
109.	Parameter 71	Diagnostic behavior	Assign behavior for diagnostic information 948	8	1	245
110.	None			32	4	246
111.	None			16	2	250
112.	Parameter 12	Concentration	Liquid type	16	2	252
113.	None			32	4	254
114.	None			16	2	258
115.	Parameter 138	Concentration	Coefficient A0	32	4	260
116.	Parameter 141	Concentration	Coefficient A1	32	4	264
117.	Parameter 144	Concentration	Coefficient A2	32	4	268
118.	Parameter 147	Concentration	Coefficient A3	32	4	272
119.	Parameter 150	Concentration	Coefficient A4	32	4	276
120.	Parameter 153	Concentration	Coefficient B1	32	4	280
121.	Parameter 156	Concentration	Coefficient B2	32	4	284
122.	Parameter 159	Concentration	Coefficient B3	32	4	288
123.	Parameter 162	Concentration	Coefficient D1	32	4	292
124.	Parameter 165	Concentration	Coefficient D2	32	4	296
125.	Parameter 168	Concentration	Coefficient D3	32	4	300
126.	Parameter 171	Concentration	Coefficient D4	32	4	304
127.	Parameter 55		Petroleum mode	16	2	308
128.	Parameter 53		API product group	16	2	310
129.	Parameter 54		API table selection	16	2	312
130.	None			16	2	314
131.	Parameter 237		Thermal expansion coefficient	32	4	316
132.	Parameter 220		Oil density sample	32	4	320
133.	Parameter 235		Oil temperature sample	32	4	324
134.	Parameter 230		Oil pressure sample	32	4	328
135.	Parameter 222		Water density sample	32	4	332
136.	Parameter 236		Water temperature sample	32	4	336

9.5 Diagnostic information via EtherNet/IP

Status signal	No.	Short text	Value
	000	–	0
F	882	Input signal	16777265
F	910	Tubes not oscillating	16777296
F	437	Configuration incompatible	16777312
F	242	Software incompatible	16777319

Status signal	No.	Short text	Value
F	252	Modules incompatible	16777323
F	272	Main electronic failure	16777337
F	270	Main electronic failure	16777340
F	271	Main electronic failure	16777341
F	270	Main electronic failure	16777343
F	270	Main electronic failure	16777344
F	825	Operating temperature	16777352
F	410	Data transfer	16777355
F	273	Main electronic failure	16777368
F	270	Main electronic failure	16777375
F	083	Memory content	16777376
F	270	Main electronic failure	16777377
F	022	Sensor temperature	16777406
F	022	Sensor temperature	16777407
F	833	Electronic temperature too low	16777409
F	832	Electronic temperature too high	16777411
F	834	Process temperature too high	16777413
F	835	Process temperature too low	16777414
F	270	Main electronic failure	16777428
F	022	Sensor temperature	16777429
F	022	Sensor temperature	16777430
F	062	Sensor connection	16777435
F	062	Sensor connection	16777436
F	311	Electronic failure	16777441
F	273	Main electronic failure	16777445
F	082	Data storage	16777447
F	190	Special event 2	16777450
F	273	Main electronic failure	16777483
F	390	Special event 3	16777490
F	062	Sensor connection	16777491
F	062	Sensor connection	16777492
F	992	Special event 13	16777503
F	590	Special event 4	16777508
F	990	Special event 5	16777509
F	991	Special event 9	16777510
F	591	Special event 8	16777511
F	391	Special event 7	16777512
F	191	Special event 6	16777513
F	262	Module connection	16777545
F	537	Configuration	16777546
F	201	Device failure	16777547
F	192	Special event 10	16777552
F	392	Special event 11	16777553

Status signal	No.	Short text	Value
F	592	Special event 12	16777554
F	382	Data storage	16777581
F	383	Memory content	16777582
F	283	Memory content	16777583
F	144	Measuring error too high	16777671
C	411	Up-/download active	33554536
C	411	Up-/download active	33554537
C	411	Up-/download active	33554540
C	484	Simulation failure mode	33554576
C	485	Simulation measured variable	33554579
C	453	Flow override	33554580
C	833	Electronic temperature too low	33554625
C	832	Electronic temperature too high	33554627
C	834	Process temperature too high	33554629
C	835	Process temperature too low	33554630
C	992	Special event 13	33554719
C	192	Special event 10	33554768
C	392	Special event 11	33554769
C	592	Special event 12	33554770
C	495	Simulation diagnostic event	33554782
C	302	Device verification active	33554926
M	438	Dataset	67108970
M	833	Electronic temperature too low	67109057
M	832	Electronic temperature too high	67109059
M	834	Process temperature too high	67109061
M	835	Process temperature too low	67109062
M	311	Electronic failure	67109090
M	992	Special event 13	67109151
M	192	Special event 10	67109200
M	392	Special event 11	67109201
M	592	Special event 12	67109202
S	825	Operating temperature	134217861
S	825	Operating temperature	134217863
S	842	Process limit	134217873
S	862	Partly filled pipe	134217874
S	830	Sensor temperature too high	134217920
S	833	Electronic temperature too low	134217921
S	831	Sensor temperature too low	134217922
S	832	Electronic temperature too high	134217923
S	912	Medium inhomogeneous	134217924
S	834	Process temperature too high	134217925
S	835	Process temperature too low	134217926
S	046	Sensor limit exceeded	134217928

Status signal	No.	Short text	Value
S	046	Sensor limit exceeded	134217930
S	140	Sensor signal	134217932
S	913	Medium unsuitable	134217933
S	274	Main electronic failure	134217934
S	274	Main electronic failure	134217935
S	912	Medium inhomogeneous	134217951
S	912	Inhomogeneous	134218005
S	992	Special event 13	134218015
S	843	Process limit	134218019
S	192	Special event 10	134218064
S	392	Special event 11	134218065
S	592	Special event 12	134218066
S	912	Inhomogeneous	134218082
S	948	Tube damping too high	134218088
S	944	Monitoring failed	134218182
I	1089	Power on	268435545
I	1090	Configuration reset	268435546
I	1091	Configuration changed	268435547
I	1110	Write protection switch changed	268435566
I	1111	Density adjust failure	268435567
I	1137	Electronic changed	268435593
I	1151	History reset	268435607
I	1155	Reset electronic temperature	268435611
I	1157	Memory error event list	268435613
I	1185	Display backup done	268435641
I	1186	Restore via display done	268435642
I	1187	Settings downloaded with display	268435643
I	1188	Display data cleared	268435644
I	1189	Backup compared	268435645
I	1209	Density adjustment ok	268435665
I	1221	Zero point adjust failure	268435677
I	1222	Zero point adjustment ok	268435678
I	1256	Display: access status changed	268435712
I	1264	Safety sequence aborted	268435720
I	1335	Firmware changed	268435791
I	1361	Wrong web server login	268435817
I	1397	Fieldbus: access status changed	268435853
I	1398	CDI: access status changed	268435854
I	1444	Device verification passed	268435900
I	1445	Device verification failed	268435901
I	1446	Device verification active	268435902
I	1447	Record application reference data	268435903
I	1448	Application reference data recorded	268435904

Status signal	No.	Short text	Value
I	1449	Recording application ref. data failed	268435905
I	1450	Monitoring off	268435906
I	1451	Monitoring on	268435907
I	1457	Failed: Measured error verification	268435913
I	1459	Failed: I/O module verification	268435915
I	1460	Failed: Sensor integrity verification	268435916
I	1461	Failed: Sensor verification	268435917
I	1462	Failed: Sensor electronic module verific.	268435918

10 Commissioning

10.1 Function check

Before commissioning the measuring device:

- ▶ Make sure that the post-installation and post-connection checks have been performed.
- "Post-installation check" checklist → 35
- "Post-connection check" checklist → 67

10.2 Switching on the measuring device

- ▶ After a successful function check, switch on the measuring device.
 - ↳ After a successful startup, the local display switches automatically from the startup display to the operational display.

i If nothing appears on the local display or a diagnostic message is displayed, refer to the section on "Diagnostics and troubleshooting" → 194.

10.3 Connecting via FieldCare

- For FieldCare → 91 connection
- For connecting via FieldCare → 94
- For the FieldCare → 95 user interface

10.4 Setting the operating language

Factory setting: English or ordered local language

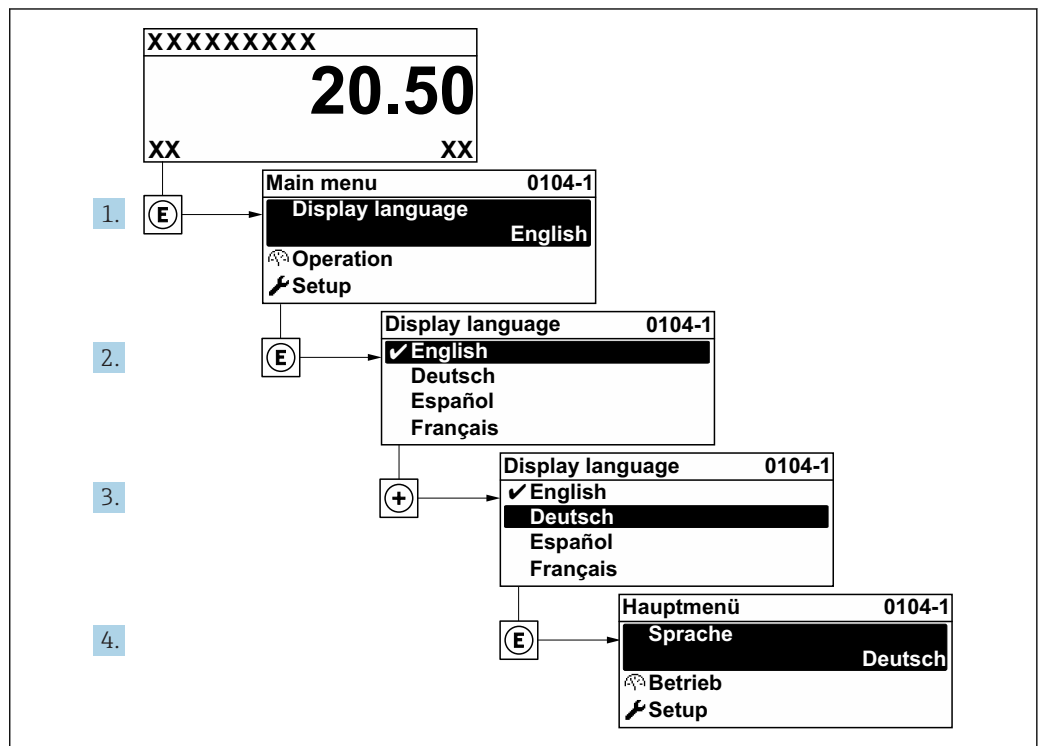

33 Taking the example of the local display

A0029420

10.5 Configuring the measuring device

- The **Setup** menu with its guided wizards contains all the parameters needed for standard operation.
- Navigation to the **Setup** menu

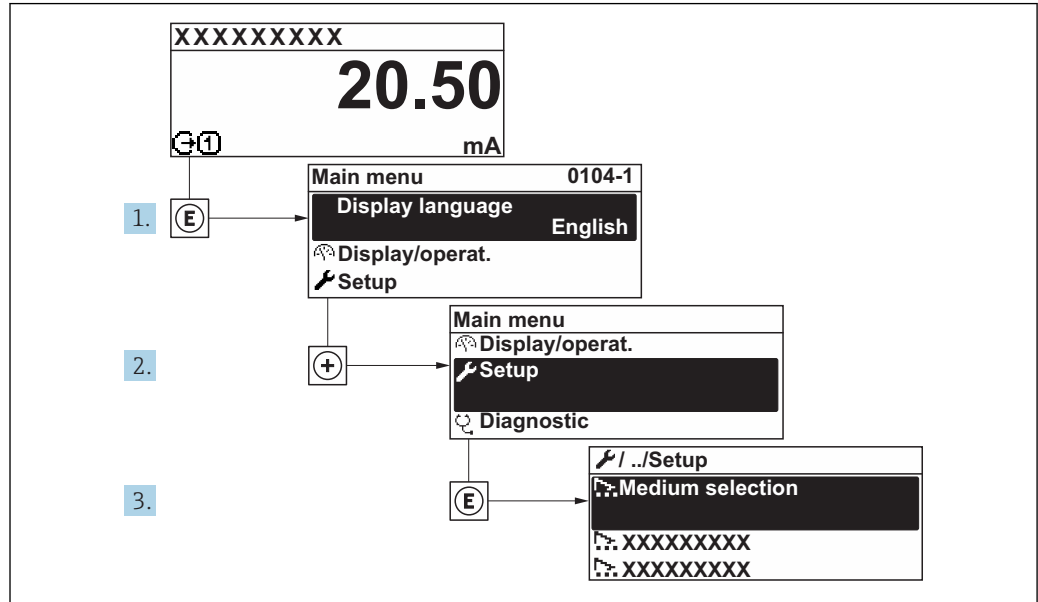

34 Taking the example of the local display

A003222-EN

i Depending on the device version, not all submenus and parameters are available in every device. The selection can vary depending on the order code.

Setup	
Device tag	→ 115
▶ System units	→ 115
▶ Communication	→ 117
▶ Medium selection	→ 119
▶ I/O configuration	→ 120
▶ Current input 1 to n	→ 121
▶ Status input 1 to n	→ 122
▶ Current output 1 to n	→ 123
▶ Pulse/frequency/switch output 1 to n	→ 128
▶ Relay output 1 to n	→ 138

▶ Display	→ 141
▶ Low flow cut off	→ 152
▶ Partially filled pipe detection	→ 153
▶ Advanced setup	→ 154

10.5.1 Defining the tag name

To enable fast identification of the measuring point within the system, you can enter a unique designation using the **Device tag** parameter and thus change the factory setting.

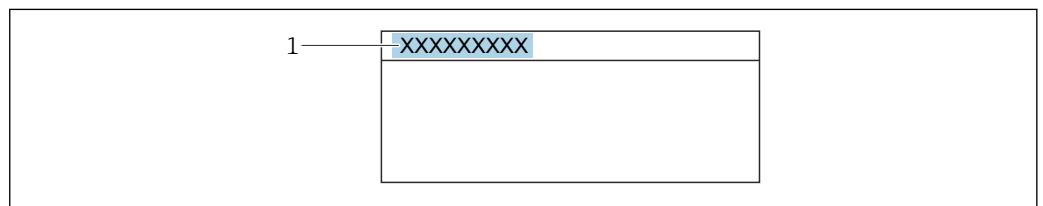

A0029422

35 Header of the operational display with tag name

1 Tag name

i Enter the tag name in the "FieldCare" operating tool → 95

Navigation

"Setup" menu → Device tag

Parameter overview with brief description

Parameter	Description	User entry	Factory setting
Device tag	Enter the name for the measuring point.	Max. 32 characters, such as letters, numbers or special characters (e.g. @, %, /).	Promass

10.5.2 Setting the system units









In the **System units** submenu the units of all the measured values can be set.

i Depending on the device version, not all submenus and parameters are available in every device. The selection can vary depending on the order code.

Navigation

"Setup" menu → System units

▶ System units	
Mass flow unit	→ 116
Mass unit	→ 116

Volume flow unit	→  116
Volume unit	→  116
Corrected volume flow unit	→  116
Corrected volume unit	→  116
Density unit	→  116
Reference density unit	→  117
Temperature unit	→  117
Pressure unit	→  117

Parameter overview with brief description

Parameter	Description	Selection	Factory setting
Mass flow unit	Select mass flow unit. <i>Result</i> The selected unit applies for: <ul style="list-style-type: none"> ▪ Output ▪ Low flow cut off ▪ Simulation process variable 	Unit choose list	Country-specific: <ul style="list-style-type: none"> ▪ kg/h ▪ lb/min
Mass unit	Select mass unit.	Unit choose list	Country-specific: <ul style="list-style-type: none"> ▪ kg ▪ lb
Volume flow unit	Select volume flow unit. <i>Result</i> The selected unit applies for: <ul style="list-style-type: none"> ▪ Output ▪ Low flow cut off ▪ Simulation process variable 	Unit choose list	Country-specific: <ul style="list-style-type: none"> ▪ l/h ▪ gal/min (us)
Volume unit	Select volume unit.	Unit choose list	Country-specific: <ul style="list-style-type: none"> ▪ l (DN > 150 (6"): m³) ▪ gal (us)
Corrected volume flow unit	Select corrected volume flow unit. <i>Result</i> The selected unit applies for: Corrected volume flow parameter (→  182)	Unit choose list	Country-specific: <ul style="list-style-type: none"> ▪ NI/h ▪ Sft³/min
Corrected volume unit	Select corrected volume unit.	Unit choose list	Country-specific: <ul style="list-style-type: none"> ▪ NI ▪ Sft³
Density unit	Select density unit. <i>Result</i> The selected unit applies for: <ul style="list-style-type: none"> ▪ Output ▪ Simulation process variable ▪ Density adjustment (Expert menu) 	Unit choose list	Country-specific: <ul style="list-style-type: none"> ▪ kg/l ▪ lb/ft³

Parameter	Description	Selection	Factory setting
Reference density unit	Select reference density unit.	Unit choose list	Country-dependent <ul style="list-style-type: none"> ■ kg/Nl ■ lb/Sft³
Temperature unit	Select temperature unit. <i>Result</i> The selected unit applies for: <ul style="list-style-type: none"> ■ Electronic temperature parameter (6053) ■ Maximum value parameter (6051) ■ Minimum value parameter (6052) ■ External temperature parameter (6080) ■ Maximum value parameter (6108) ■ Minimum value parameter (6109) ■ Carrier pipe temperature parameter (6027) ■ Maximum value parameter (6029) ■ Minimum value parameter (6030) ■ Reference temperature parameter (1816) ■ Temperature parameter 	Unit choose list	Country-specific: <ul style="list-style-type: none"> ■ °C ■ °F
Pressure unit	Select process pressure unit. <i>Result</i> The unit is taken from: <ul style="list-style-type: none"> ■ Pressure value parameter (→ ⓘ 120) ■ External pressure parameter (→ ⓘ 120) ■ Pressure value 	Unit choose list	Country-specific: <ul style="list-style-type: none"> ■ bar a ■ psi a

10.5.3 Configuring the communication interface

The **Communication** submenu guides you systematically through all the parameters that have to be configured for selecting and setting the communication interface.



Navigation

"Setup" menu → Communication

▶ Communication

MAC address	→ ⓘ 118
Default network settings	→ ⓘ 118
DHCP client	→ ⓘ 118
IP address	→ ⓘ 118
Subnet mask	→ ⓘ 118
Default gateway	→ ⓘ 118

Parameter overview with brief description

Parameter	Description	User interface / Selection / User entry	Factory setting
MAC address	Displays the MAC address of the measuring device.  MAC = Media Access Control	Unique 12-digit character string comprising letters and numbers, e.g.: 00:07:05:10:01:5F	Each measuring device is given an individual address.
Default network settings	Select whether to restore network settings.	<ul style="list-style-type: none"> ■ Off ■ On 	Off
DHCP client	Select to activate/deactivate DHCP client functionality. Result If the DHCP client functionality of the Web server is activated, the IP address, Subnet mask and Default gateway are set automatically.  Identification is via the MAC address of the measuring device.	<ul style="list-style-type: none"> ■ Off ■ On 	Off
IP address	Displays the IP address of the Web server of the measuring device.	4 octet: 0 to 255 (in the particular octet)	192.168.1.212
Subnet mask	Displays the subnet mask.	4 octet: 0 to 255 (in the particular octet)	255.255.255.0
Default gateway	Displays the default gateway.	4 octet: 0 to 255 (in the particular octet)	0.0.0.0

10.5.4 Selecting and setting the medium

The **Select medium** wizard submenu contains parameters that must be configured in order to select and set the medium.

Navigation

"Setup" menu → Select medium

► Medium selection	
Select medium	→ ⓘ 120
Select gas type	→ ⓘ 120
Reference sound velocity	→ ⓘ 120
Temperature coefficient sound velocity	→ ⓘ 120
Pressure compensation	→ ⓘ 120
Pressure value	→ ⓘ 120
External pressure	→ ⓘ 120

Parameter overview with brief description

Parameter	Prerequisite	Description	Selection / User entry / User interface	Factory setting
Select medium	–	Select medium type.	<ul style="list-style-type: none"> ▪ Liquid ▪ Gas 	Liquid
Select gas type	The Gas option is selected in the Select medium parameter.	Select measured gas type.	<ul style="list-style-type: none"> ▪ Air ▪ Ammonia NH₃ ▪ Argon Ar ▪ Sulfur hexafluoride SF₆ ▪ Oxygen O₂ ▪ Ozone O₃ ▪ Nitrogen oxide NO_x ▪ Nitrogen N₂ ▪ Nitrous oxide N₂O ▪ Methane CH₄ ▪ Hydrogen H₂ ▪ Helium He ▪ Hydrogen chloride HCl ▪ Hydrogen sulfide H₂S ▪ Ethylene C₂H₄ ▪ Carbon dioxide CO₂ ▪ Carbon monoxide CO ▪ Chlorine Cl₂ ▪ Butane C₄H₁₀ ▪ Propane C₃H₈ ▪ Propylene C₃H₆ ▪ Ethane C₂H₆ ▪ Others 	Methane CH ₄
Reference sound velocity	In the Select gas type parameter, the Others option is selected.	Enter sound velocity of gas at 0 °C (32 °F).	1 to 99 999.9999 m/s	415.0 m/s
Temperature coefficient sound velocity	The Others option is selected in the Select gas type parameter.	Enter temperature coefficient for the gas sound velocity.	Positive floating-point number	0 (m/s)/K
Pressure compensation	–	Select pressure compensation type.	<ul style="list-style-type: none"> ▪ Off ▪ Fixed value ▪ External value ▪ Current input 1 * ▪ Current input 2 * ▪ Current input 3 * 	Off
Pressure value	The Fixed value option is selected in the Pressure compensation parameter.	Enter process pressure to be used for pressure correction.	Positive floating-point number	0 bar
External pressure	The External value option is selected in the Pressure compensation parameter.	Shows the external process pressure value.	Positive floating-point number	0 bar

* Visibility depends on order options or device settings

10.5.5 Displaying the I/O configuration

The **I/O configuration** submenu guides the user systematically through all the parameters in which the configuration of the I/O modules is displayed.

Navigation

"Setup" menu → I/O configuration

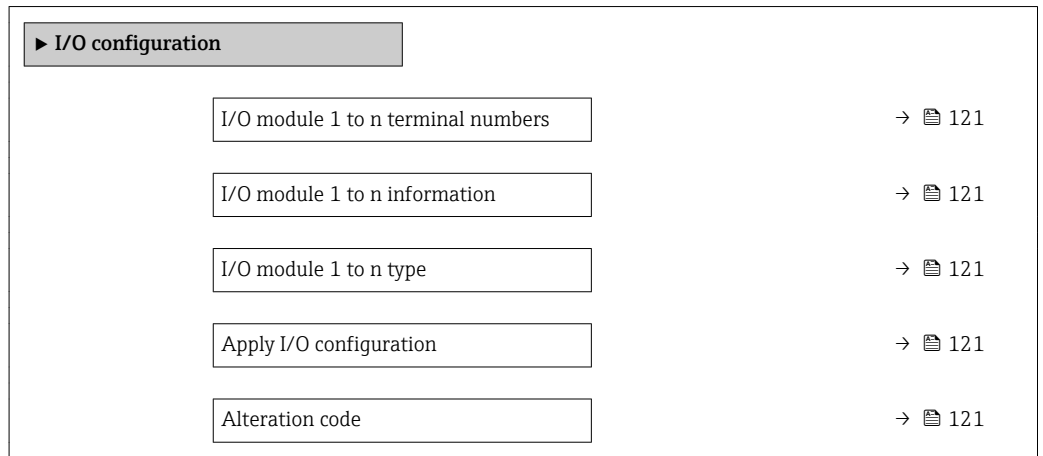

Parameter overview with brief description

Parameter	Description	User interface / Selection / User entry	Factory setting
I/O module 1 to n terminal numbers	Shows the terminal numbers used by the I/O module.	<ul style="list-style-type: none"> Not used 26-27 (I/O 1) 24-25 (I/O 2) 22-23 (I/O 3) 20-21 (I/O 4) 	-
I/O module 1 to n information	Shows information of the plugged I/O module.	<ul style="list-style-type: none"> Not plugged Invalid Not configurable Configurable EtherNet/IP 	-
I/O module 1 to n type	Shows the I/O module type.	<ul style="list-style-type: none"> Off Current output * Current input * Status input * Pulse/frequency/switch output * 	Off
Apply I/O configuration	Apply parameterization of the freely configurable I/O module.	<ul style="list-style-type: none"> No Yes 	No
Alteration code	Enter the code in order to change the I/O configuration.	Positive integer	0

* Visibility depends on order options or device settings





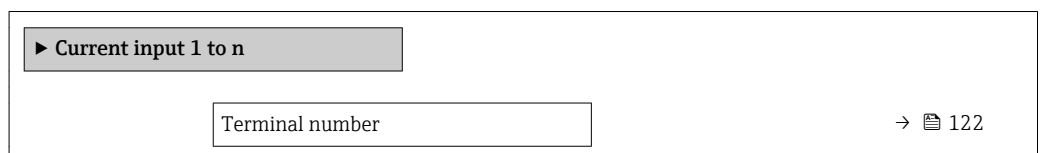

10.5.6 Configuring the current input

The "Current input" wizard guides the user systematically through all the parameters that have to be set for configuring the current input.

Navigation

"Setup" menu → Current input



Signal mode	→  122
0/4 mA value	→  122
20 mA value	→  122
Current span	→  122
Failure mode	→  122
Failure value	→  122

Parameter overview with brief description

Parameter	Prerequisite	Description	User interface / Selection / User entry	Factory setting
Terminal number	–	Shows the terminal numbers used by the current input module.	<ul style="list-style-type: none"> ▪ Not used ▪ 24-25 (I/O 2) ▪ 22-23 (I/O 3) ▪ 20-21 (I/O 4) 	–
Signal mode	The measuring device is not approved for use in the hazardous area with type of protection Ex-i.	Select the signal mode for the current input.	<ul style="list-style-type: none"> ▪ Passive ▪ Active 	Active
0/4 mA value	–	Enter 4 mA value.	Signed floating-point number	0
20 mA value	–	Enter 20 mA value.	Signed floating-point number	Depends on country and nominal diameter
Current span	–	Select current range for process value output and upper/lower level for alarm signal.	<ul style="list-style-type: none"> ▪ 4...20 mA ▪ 4...20 mA NAMUR ▪ 4...20 mA US ▪ 0...20 mA 	Country-specific: <ul style="list-style-type: none"> ▪ 4...20 mA NAMUR ▪ 4...20 mA US
Failure mode	–	Define input behavior in alarm condition.	<ul style="list-style-type: none"> ▪ Alarm ▪ Last valid value ▪ Defined value 	Alarm
Failure value	In the Failure mode parameter, the Defined value option is selected.	Enter value to be used by the device if input value from external device is missing.	Signed floating-point number	0

10.5.7 Configuring the status input

The **Status input** submenu guides the user systematically through all the parameters that have to be set for configuring the status input.

Navigation

"Setup" menu → Status input

▶ Status input 1 to n	
Assign status input	→  123

Terminal number	→ 123
Active level	→ 123
Terminal number	→ 123
Response time status input	→ 123
Terminal number	→ 123

Parameter overview with brief description

Parameter	Description	User interface / Selection / User entry	Factory setting
Terminal number	Shows the terminal numbers used by the status input module.	<ul style="list-style-type: none"> ▪ Not used ▪ 24-25 (I/O 2) ▪ 22-23 (I/O 3) ▪ 20-21 (I/O 4) 	-
Assign status input	Select function for the status input.	<ul style="list-style-type: none"> ▪ Off ▪ Reset totalizer 1 ▪ Reset totalizer 2 ▪ Reset totalizer 3 ▪ Reset all totalizers ▪ Flow override 	Off
Active level	Define input signal level at which the assigned function is triggered.	<ul style="list-style-type: none"> ▪ High ▪ Low 	High
Response time status input	Define the minimum amount of time the input signal level must be present before the selected function is triggered.	5 to 200 ms	50 ms





10.5.8 Configuring the current output

The **Current output** wizard guides you systematically through all the parameters that have to be set for configuring the current output.

Navigation

"Setup" menu → Current output

► Current output 1 to n	
Terminal number	→ 124
Signal mode	→ 124
Assign current output 1 to n	→ 125
Current span	→ 125
0/4 mA value	→ 126
20 mA value	→ 126



Fixed current	→  126
Damping output 1 to n	→  126
Failure mode	→  127
Failure current	→  127

Parameter overview with brief description

Parameter	Prerequisite	Description	User interface / Selection / User entry	Factory setting
Terminal number	-	Shows the terminal numbers used by the current output module.	<ul style="list-style-type: none"> ▪ Not used ▪ 24-25 (I/O 2) ▪ 22-23 (I/O 3) ▪ 20-21 (I/O 4) 	-
Signal mode	-	Select the signal mode for the current output.	<ul style="list-style-type: none"> ▪ Passive ▪ Active 	Active

Parameter	Prerequisite	Description	User interface / Selection / User entry	Factory setting
Assign current output 1 to n	-	Select process variable for current output.	<ul style="list-style-type: none"> ■ Off ■ Mass flow ■ Volume flow ■ Corrected volume flow ■ Target mass flow * ■ Carrier mass flow * ■ Target volume flow ■ Carrier volume flow ■ Target corrected volume flow ■ Carrier corrected volume flow ■ Density ■ Reference density ■ Reference density alternative ■ GSV flow ■ GSV flow alternative ■ NSV flow ■ NSV flow alternative ■ S&W volume flow ■ Water cut ■ Oil density ■ Water density ■ Oil mass flow ■ Water mass flow ■ Oil volume flow ■ Water volume flow ■ Oil corrected volume flow ■ Water corrected volume flow ■ Concentration * ■ Temperature ■ Carrier pipe temperature * ■ Electronic temperature ■ Oscillation frequency 0 ■ Oscillation amplitude 0 * ■ Frequency fluctuation 0 ■ Oscillation damping 0 ■ Oscillation damping fluctuation 0 ■ Signal asymmetry ■ Exciter current 0 ■ Pressure 	Mass flow
Current span	-	Select current range for process value output and upper/lower level for alarm signal.	<ul style="list-style-type: none"> ■ 4...20 mA NAMUR ■ 4...20 mA US ■ 4...20 mA ■ 0...20 mA ■ Fixed current 	Country-specific: <ul style="list-style-type: none"> ■ 4...20 mA NAMUR ■ 4...20 mA US

Parameter	Prerequisite	Description	User interface / Selection / User entry	Factory setting
0/4 mA value	One of the following options is selected in the Current span parameter (→ ⓘ 125): <ul style="list-style-type: none"> ▪ 4...20 mA NAMUR ▪ 4...20 mA US ▪ 4...20 mA ▪ 0...20 mA 	Enter 4 mA value.	Signed floating-point number	Country-specific: <ul style="list-style-type: none"> ▪ 0 kg/h ▪ 0 lb/min
20 mA value	One of the following options is selected in the Current span parameter (→ ⓘ 125): <ul style="list-style-type: none"> ▪ 4...20 mA NAMUR ▪ 4...20 mA US ▪ 4...20 mA ▪ 0...20 mA 	Enter 20 mA value.	Signed floating-point number	Depends on country and nominal diameter
Fixed current	The Fixed current option is selected in the Current span parameter (→ ⓘ 125).	Defines the fixed output current.	0 to 22.5 mA	22.5 mA
Damping output 1 to n	One of the following options is selected in the Assign current output parameter (→ ⓘ 125): <ul style="list-style-type: none"> ▪ Mass flow ▪ Volume flow ▪ Corrected volume flow ▪ Target mass flow * ▪ Carrier mass flow * ▪ Density ▪ Reference density ▪ Concentration * ▪ Temperature ▪ Carrier pipe temperature * ▪ Electronic temperature ▪ Oscillation frequency 0 ▪ Oscillation amplitude 0 * ▪ Frequency fluctuation 0 ▪ Oscillation damping fluctuation 0 ▪ Tube damping fluctuation 0 ▪ Signal asymmetry ▪ Exciter current 0 <p> Detailed description of the options Oscillation frequency, Oscillation amplitude, Oscillation damping and Signal asymmetry: Value 1 display parameter</p> One of the following options is selected in the Current span parameter (→ ⓘ 125): <ul style="list-style-type: none"> ▪ 4...20 mA NAMUR ▪ 4...20 mA US ▪ 4...20 mA ▪ 0...20 mA 	Set reaction time for output signal to fluctuations in the measured value.	0.0 to 999.9 s	1.0 s

Parameter	Prerequisite	Description	User interface / Selection / User entry	Factory setting
Failure mode	<p>One of the following options is selected in the Assign current output parameter (→  125):</p> <ul style="list-style-type: none"> ▪ Mass flow ▪ Volume flow ▪ Corrected volume flow ▪ Target mass flow * ▪ Carrier mass flow * ▪ Density ▪ Reference density ▪ Concentration * ▪ Temperature ▪ Carrier pipe temperature * ▪ Electronic temperature ▪ Oscillation frequency 0 ▪ Oscillation amplitude 0 * ▪ Frequency fluctuation 0 ▪ Oscillation damping 0 ▪ Oscillation damping fluctuation 0 ▪ Signal asymmetry ▪ Exciter current 0 <p>One of the following options is selected in the Current span parameter (→  125):</p> <ul style="list-style-type: none"> ▪ 4...20 mA NAMUR ▪ 4...20 mA US ▪ 4...20 mA ▪ 0...20 mA 	Define output behavior in alarm condition.	<ul style="list-style-type: none"> ▪ Min. ▪ Max. ▪ Last valid value ▪ Actual value ▪ Defined value 	Max.
Failure current	The Defined value option is selected in the Failure mode parameter.	Enter current output value in alarm condition.	0 to 22.5 mA	22.5 mA

* Visibility depends on order options or device settings

10.5.9 Configuring the pulse/frequency/switch output

The **Pulse/frequency/switch output** wizard guides you systematically through all the parameters that can be set for configuring the selected output type.

Navigation

"Setup" menu → Advanced setup → Pulse/frequency/switch output

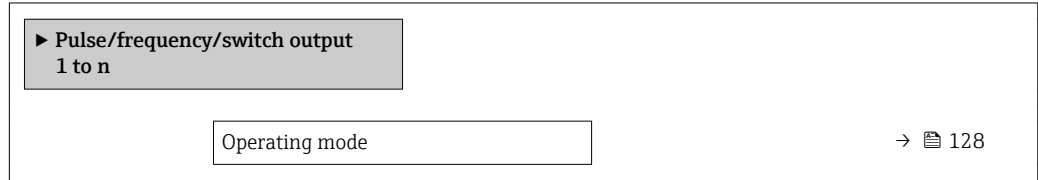

Parameter overview with brief description

Parameter	Description	Selection	Factory setting
Operating mode	Define the output as a pulse, frequency or switch output.	<ul style="list-style-type: none"> ■ Pulse ■ Frequency ■ Switch 	Pulse

Configuring the pulse output

Navigation

"Setup" menu → Pulse/frequency/switch output

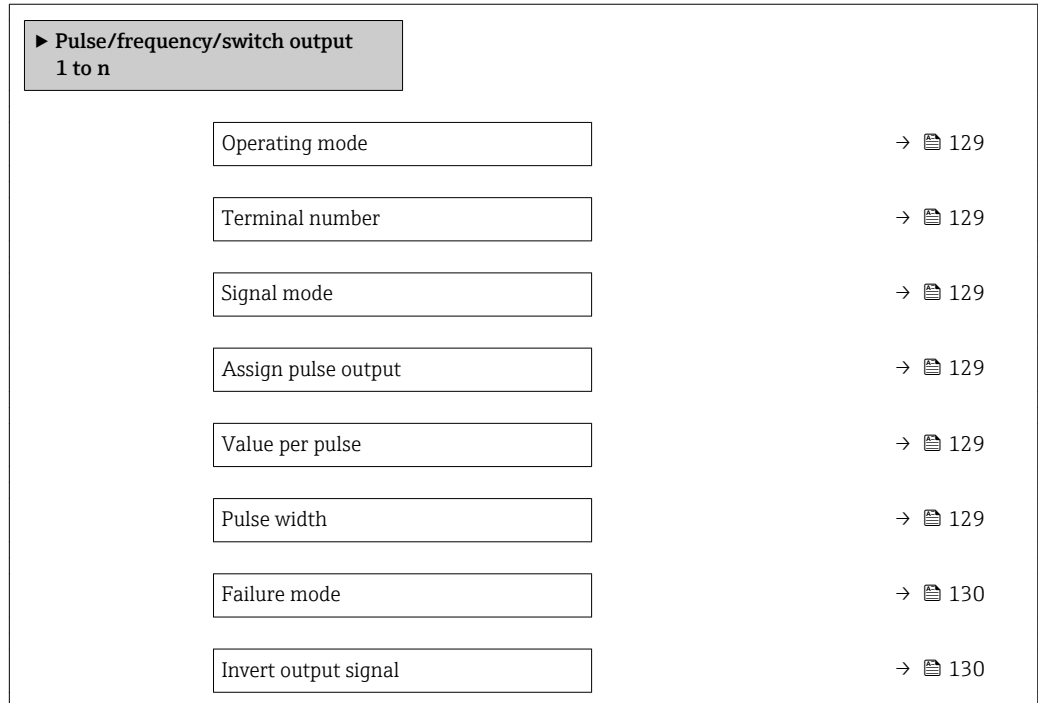

Parameter overview with brief description

Parameter	Prerequisite	Description	Selection / User interface / User entry	Factory setting
Operating mode	–	Define the output as a pulse, frequency or switch output.	<ul style="list-style-type: none"> ■ Pulse ■ Frequency ■ Switch 	Pulse
Terminal number	–	Shows the terminal numbers used by the PFS output module.	<ul style="list-style-type: none"> ■ Not used ■ 24-25 (I/O 2) ■ 22-23 (I/O 3) ■ 20-21 (I/O 4) 	–
Signal mode	–	Select the signal mode for the PFS output.	<ul style="list-style-type: none"> ■ Passive ■ Active 	Passive
Assign pulse output 1 to n	The Pulse option is selected in the Operating mode parameter.	Select process variable for pulse output.	<ul style="list-style-type: none"> ■ Off ■ Mass flow ■ Volume flow ■ Corrected volume flow ■ Target mass flow * ■ Carrier mass flow * ■ Target volume flow ■ Carrier volume flow ■ Target corrected volume flow ■ Carrier corrected volume flow ■ GSV flow ■ GSV flow alternative ■ NSV flow ■ NSV flow alternative ■ S&W volume flow ■ Oil mass flow ■ Water mass flow ■ Oil volume flow ■ Water volume flow ■ Oil corrected volume flow ■ Water corrected volume flow 	Off
Value per pulse	In the Operating mode parameter, the Pulse option is selected, and one of the following options is selected in the Assign pulse output parameter (→ 129): <ul style="list-style-type: none"> ■ Mass flow ■ Volume flow ■ Corrected volume flow ■ Target mass flow * ■ Carrier mass flow * 	Enter measured value at which a pulse is output.	Signed floating-point number	Depends on country and nominal diameter
Pulse width	In the Operating mode parameter, the Pulse option is selected, and one of the following options is selected in the Assign pulse output parameter (→ 129): <ul style="list-style-type: none"> ■ Mass flow ■ Volume flow ■ Corrected volume flow ■ Target mass flow * ■ Carrier mass flow * 	Define time width of the output pulse.	0.05 to 2000 ms	100 ms











Parameter	Prerequisite	Description	Selection / User interface / User entry	Factory setting
Failure mode	In the Operating mode parameter, the Pulse option is selected, and one of the following options is selected in the Assign pulse output parameter (→  129): <ul style="list-style-type: none"> ▪ Mass flow ▪ Volume flow ▪ Corrected volume flow ▪ Target mass flow * ▪ Carrier mass flow * 	Define output behavior in alarm condition.	<ul style="list-style-type: none"> ▪ Actual value ▪ No pulses 	No pulses
Invert output signal	–	Invert the output signal.	<ul style="list-style-type: none"> ▪ No ▪ Yes 	No

* Visibility depends on order options or device settings

Configuring the frequency output

Navigation



"Setup" menu → Pulse/frequency/switch output



► Pulse/frequency/switch output 1 to n	
Operating mode	→  131
Terminal number	→  131
Signal mode	→  131
Assign frequency output	→  132
Minimum frequency value	→  133
Maximum frequency value	→  133
Measuring value at minimum frequency	→  134
Measuring value at maximum frequency	→  134
Failure mode	→  135
Failure frequency	→  135
Invert output signal	→  135



Parameter overview with brief description

Parameter	Prerequisite	Description	Selection / User interface / User entry	Factory setting
Operating mode	–	Define the output as a pulse, frequency or switch output.	<ul style="list-style-type: none"> ■ Pulse ■ Frequency ■ Switch 	Pulse
Terminal number	–	Shows the terminal numbers used by the PFS output module.	<ul style="list-style-type: none"> ■ Not used ■ 24-25 (I/O 2) ■ 22-23 (I/O 3) ■ 20-21 (I/O 4) 	–
Signal mode	–	Select the signal mode for the PFS output.	<ul style="list-style-type: none"> ■ Passive ■ Active 	Passive

Parameter	Prerequisite	Description	Selection / User interface / User entry	Factory setting
Assign frequency output	The Frequency option is selected in the Operating mode parameter (→  128).	Select process variable for frequency output.	<ul style="list-style-type: none"> ▪ Off ▪ Mass flow ▪ Volume flow ▪ Corrected volume flow ▪ Target mass flow * ▪ Carrier mass flow * ▪ Target volume flow ▪ Carrier volume flow ▪ Target corrected volume flow ▪ Carrier corrected volume flow ▪ Density ▪ Reference density ▪ Reference density alternative ▪ GSV flow ▪ GSV flow alternative ▪ NSV flow ▪ NSV flow alternative ▪ S&W volume flow ▪ Water cut ▪ Oil density ▪ Water density ▪ Oil mass flow ▪ Water mass flow ▪ Oil volume flow ▪ Water volume flow ▪ Oil corrected volume flow ▪ Water corrected volume flow ▪ Concentration * ▪ Temperature ▪ Carrier pipe temperature * ▪ Electronic temperature ▪ Oscillation frequency 0 ▪ Oscillation amplitude 0 * ▪ Frequency fluctuation 0 ▪ Oscillation damping 0 ▪ Oscillation damping fluctuation 0 ▪ Signal asymmetry ▪ Exciter current 0 ▪ HBSI ▪ Pressure 	Off

Parameter	Prerequisite	Description	Selection / User interface / User entry	Factory setting
Minimum frequency value	<p>In the Operating mode parameter, the Frequency option is selected, and one of the following options is selected in the Assign frequency output parameter (→  132):</p> <ul style="list-style-type: none"> ▪ Mass flow ▪ Volume flow ▪ Corrected volume flow ▪ Target mass flow[*] ▪ Carrier mass flow[*] ▪ Density ▪ Reference density ▪ Concentration[*] ▪ Temperature ▪ Carrier pipe temperature[*] ▪ Electronic temperature ▪ Oscillation frequency 0 ▪ Frequency fluctuation 0 ▪ Oscillation amplitude 0[*] ▪ Oscillation damping 0 ▪ Oscillation damping fluctuation 0 ▪ Signal asymmetry ▪ Exciter current 0 	Enter minimum frequency.	0.0 to 10000.0 Hz	0.0 Hz
Maximum frequency value	<p>In the Operating mode parameter, the Frequency option is selected, and one of the following options is selected in the Assign frequency output parameter (→  132):</p> <ul style="list-style-type: none"> ▪ Mass flow ▪ Volume flow ▪ Corrected volume flow ▪ Target mass flow[*] ▪ Carrier mass flow[*] ▪ Density ▪ Reference density ▪ Concentration[*] ▪ Temperature ▪ Carrier pipe temperature[*] ▪ Electronic temperature ▪ Oscillation frequency 0 ▪ Frequency fluctuation 0 ▪ Oscillation amplitude 0[*] ▪ Oscillation damping 0 ▪ Oscillation damping fluctuation 0 ▪ Signal asymmetry ▪ Exciter current 0 	Enter maximum frequency.	0.0 to 10000.0 Hz	10000.0 Hz

Parameter	Prerequisite	Description	Selection / User interface / User entry	Factory setting
Measuring value at minimum frequency	In the Operating mode parameter, the Frequency option is selected, and one of the following options is selected in the Assign frequency output parameter (→  132): <ul style="list-style-type: none"> ▪ Mass flow ▪ Volume flow ▪ Corrected volume flow ▪ Target mass flow * ▪ Carrier mass flow * ▪ Density ▪ Reference density ▪ Concentration * ▪ Temperature ▪ Carrier pipe temperature * ▪ Electronic temperature ▪ Oscillation frequency 0 ▪ Frequency fluctuation 0 ▪ Oscillation amplitude 0 * ▪ Oscillation damping 0 ▪ Oscillation damping fluctuation 0 ▪ Signal asymmetry ▪ Exciter current 0 	Enter measured value for minimum frequency.	Signed floating-point number	Depends on country and nominal diameter
Measuring value at maximum frequency	In the Operating mode parameter, the Frequency option is selected, and one of the following options is selected in the Assign frequency output parameter (→  132): <ul style="list-style-type: none"> ▪ Mass flow ▪ Volume flow ▪ Corrected volume flow ▪ Target mass flow * ▪ Carrier mass flow * ▪ Density ▪ Reference density ▪ Concentration * ▪ Temperature ▪ Carrier pipe temperature * ▪ Electronic temperature ▪ Oscillation frequency 0 ▪ Frequency fluctuation 0 ▪ Oscillation amplitude 0 * ▪ Oscillation damping 0 ▪ Oscillation damping fluctuation 0 ▪ Signal asymmetry ▪ Exciter current 0 	Enter measured value for maximum frequency.	Signed floating-point number	Depends on country and nominal diameter

Parameter	Prerequisite	Description	Selection / User interface / User entry	Factory setting
Failure mode	In the Operating mode parameter, the Frequency option is selected, and one of the following options is selected in the Assign frequency output parameter (→  132): <ul style="list-style-type: none"> ▪ Mass flow ▪ Volume flow ▪ Corrected volume flow ▪ Target mass flow[*] ▪ Carrier mass flow[*] ▪ Density ▪ Reference density ▪ Concentration[*] ▪ Temperature ▪ Carrier pipe temperature[*] ▪ Electronic temperature ▪ Oscillation frequency 0 ▪ Frequency fluctuation 0 ▪ Oscillation amplitude 0[*] ▪ Oscillation damping 0 ▪ Oscillation damping fluctuation 0 ▪ Signal asymmetry ▪ Exciter current 0 	Define output behavior in alarm condition.	<ul style="list-style-type: none"> ▪ Actual value ▪ Defined value ▪ 0 Hz 	0 Hz
Failure frequency	In the Operating mode parameter, the Frequency option is selected, and one of the following options is selected in the Assign frequency output parameter (→  132): <ul style="list-style-type: none"> ▪ Mass flow ▪ Volume flow ▪ Corrected volume flow ▪ Target mass flow[*] ▪ Carrier mass flow[*] ▪ Density ▪ Reference density ▪ Concentration[*] ▪ Temperature ▪ Carrier pipe temperature[*] ▪ Electronic temperature ▪ Oscillation frequency 0 ▪ Frequency fluctuation 0 ▪ Oscillation amplitude 0[*] ▪ Oscillation damping 0 ▪ Oscillation damping fluctuation 0 ▪ Signal asymmetry ▪ Exciter current 0 	Enter frequency output value in alarm condition.	0.0 to 12 500.0 Hz	0.0 Hz
Invert output signal	–	Invert the output signal.	<ul style="list-style-type: none"> ▪ No ▪ Yes 	No

* Visibility depends on order options or device settings

Configuring the switch output

Navigation

"Setup" menu → Pulse/frequency/switch output

► Pulse/frequency/switch output 1 to n	
Operating mode	→ 136
Terminal number	→ 136
Signal mode	→ 136
Switch output function	→ 137
Assign diagnostic behavior	→ 137
Assign limit	→ 137
Assign flow direction check	→ 138
Assign status	→ 138
Switch-on value	→ 138
Switch-off value	→ 138
Switch-on delay	→ 138
Switch-off delay	→ 138
Failure mode	→ 138
Invert output signal	→ 138

Parameter overview with brief description

Parameter	Prerequisite	Description	Selection / User interface / User entry	Factory setting
Operating mode	–	Define the output as a pulse, frequency or switch output.	<ul style="list-style-type: none"> ▪ Pulse ▪ Frequency ▪ Switch 	Pulse
Terminal number	–	Shows the terminal numbers used by the PFS output module.	<ul style="list-style-type: none"> ▪ Not used ▪ 24-25 (I/O 2) ▪ 22-23 (I/O 3) ▪ 20-21 (I/O 4) 	–
Signal mode	–	Select the signal mode for the PFS output.	<ul style="list-style-type: none"> ▪ Passive ▪ Active 	Passive

Parameter	Prerequisite	Description	Selection / User interface / User entry	Factory setting
Switch output function	The Switch option is selected in the Operating mode parameter.	Select function for switch output.	<ul style="list-style-type: none"> ▪ Off ▪ On ▪ Diagnostic behavior ▪ Limit ▪ Flow direction check ▪ Status 	Off
Assign diagnostic behavior	<ul style="list-style-type: none"> ▪ In the Operating mode parameter, the Switch option is selected. ▪ In the Switch output function parameter, the Diagnostic behavior option is selected. 	Select diagnostic behavior for switch output.	<ul style="list-style-type: none"> ▪ Alarm ▪ Alarm or warning ▪ Warning 	Alarm
Assign limit	<ul style="list-style-type: none"> ▪ The Switch option is selected in the Operating mode parameter. ▪ The Limit option is selected in the Switch output function parameter. 	Select process variable for limit function.	<ul style="list-style-type: none"> ▪ Mass flow ▪ Volume flow ▪ Corrected volume flow ▪ Target mass flow * ▪ Carrier mass flow * ▪ Target volume flow ▪ Carrier volume flow ▪ Target corrected volume flow ▪ Carrier corrected volume flow ▪ Density ▪ Reference density ▪ Reference density alternative ▪ GSV flow ▪ GSV flow alternative ▪ NSV flow ▪ NSV flow alternative ▪ S&W volume flow ▪ Water cut ▪ Oil density ▪ Water density ▪ Oil mass flow ▪ Water mass flow ▪ Oil volume flow ▪ Water volume flow ▪ Oil corrected volume flow ▪ Water corrected volume flow ▪ Concentration * ▪ Temperature ▪ Totalizer 1 ▪ Totalizer 2 ▪ Totalizer 3 ▪ Oscillation damping ▪ Pressure 	Mass flow

Parameter	Prerequisite	Description	Selection / User interface / User entry	Factory setting
Assign flow direction check	<ul style="list-style-type: none"> The Switch option is selected in the Operating mode parameter. The Flow direction check option is selected in the Switch output function parameter. 	Select process variable for flow direction monitoring.	<ul style="list-style-type: none"> Off Volume flow Mass flow Corrected volume flow 	Mass flow
Assign status	<ul style="list-style-type: none"> The Switch option is selected in the Operating mode parameter. The Status option is selected in the Switch output function parameter. 	Select device status for switch output.	<ul style="list-style-type: none"> Partially filled pipe detection Low flow cut off 	Partially filled pipe detection
Switch-on value	<ul style="list-style-type: none"> In the Operating mode parameter, the Switch option is selected. In the Switch output function parameter, the Limit option is selected. 	Enter measured value for the switch-on point.	Signed floating-point number	Country-specific: <ul style="list-style-type: none"> 0 kg/h 0 lb/min
Switch-off value	<ul style="list-style-type: none"> In the Operating mode parameter, the Switch option is selected. In the Switch output function parameter, the Limit option is selected. 	Enter measured value for the switch-off point.	Signed floating-point number	Country-specific: <ul style="list-style-type: none"> 0 kg/h 0 lb/min
Switch-on delay	<ul style="list-style-type: none"> The Switch option is selected in the Operating mode parameter. The Limit option is selected in the Switch output function parameter. 	Define delay for the switch-on of status output.	0.0 to 100.0 s	0.0 s
Switch-off delay	<ul style="list-style-type: none"> The Switch option is selected in the Operating mode parameter. The Limit option is selected in the Switch output function parameter. 	Define delay for the switch-off of status output.	0.0 to 100.0 s	0.0 s
Failure mode	-	Define output behavior in alarm condition.	<ul style="list-style-type: none"> Actual status Open Closed 	Open
Invert output signal	-	Invert the output signal.	<ul style="list-style-type: none"> No Yes 	No

* Visibility depends on order options or device settings





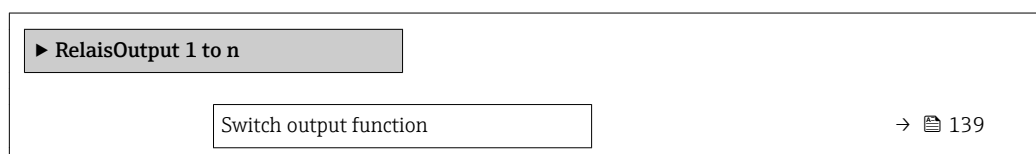

10.5.10 Configuring the relay output

The **Relay output** wizard guides the user systematically through all the parameters that have to be set for configuring the relay output.

Navigation

"Setup" menu → Relay output 1 to n



Assign flow direction check	→  139
Assign limit	→  140
Assign diagnostic behavior	→  140
Assign status	→  140
Switch-off value	→  140
Switch-on value	→  140
Failure mode	→  141

Parameter overview with brief description

Parameter	Prerequisite	Description	Selection / User interface / User entry	Factory setting
Relay output function	–	Select the function for the relay output.	<ul style="list-style-type: none"> ▪ Closed ▪ Open ▪ Diagnostic behavior ▪ Limit ▪ Flow direction check ▪ Digital Output 	Closed
Terminal number	–	Shows the terminal numbers used by the relay output module.	<ul style="list-style-type: none"> ▪ Not used ▪ 24-25 (I/O 2) ▪ 22-23 (I/O 3) ▪ 20-21 (I/O 4) 	–
Assign flow direction check	In the Relay output function parameter, the Flow direction check option is selected.	Select process variable for flow direction monitoring.	<ul style="list-style-type: none"> ▪ Off ▪ Volume flow ▪ Mass flow ▪ Corrected volume flow 	Mass flow

Parameter	Prerequisite	Description	Selection / User interface / User entry	Factory setting
Assign limit	In the Relay output function parameter, the Limit option is selected.	Select process variable for limit function.	<ul style="list-style-type: none"> ▪ Mass flow ▪ Volume flow ▪ Corrected volume flow ▪ Target mass flow * ▪ Carrier mass flow * ▪ Target volume flow ▪ Carrier volume flow ▪ Target corrected volume flow ▪ Carrier corrected volume flow ▪ Density ▪ Reference density ▪ Reference density alternative ▪ GSV flow ▪ GSV flow alternative ▪ NSV flow ▪ NSV flow alternative ▪ S&W volume flow ▪ Water cut ▪ Oil density ▪ Water density ▪ Oil mass flow ▪ Water mass flow ▪ Oil volume flow ▪ Water volume flow ▪ Oil corrected volume flow ▪ Water corrected volume flow ▪ Concentration * ▪ Temperature ▪ Totalizer 1 ▪ Totalizer 2 ▪ Totalizer 3 ▪ Oscillation damping ▪ Pressure 	Mass flow
Assign diagnostic behavior	In the Relay output function parameter, the Diagnostic behavior option is selected.	Select diagnostic behavior for switch output.	<ul style="list-style-type: none"> ▪ Alarm ▪ Alarm or warning ▪ Warning 	Alarm
Assign status	In the Relay output function parameter, the Digital Output option is selected.	Select device status for switch output.	<ul style="list-style-type: none"> ▪ Partially filled pipe detection ▪ Low flow cut off 	Partially filled pipe detection
Switch-off value	In the Relay output function parameter, the Limit option is selected.	Enter measured value for the switch-off point.	Signed floating-point number	Country-specific: <ul style="list-style-type: none"> ▪ 0 kg/h ▪ 0 lb/min
Switch-off delay	In the Relay output function parameter, the Limit option is selected.	Define delay for the switch-off of status output.	0.0 to 100.0 s	0.0 s
Switch-on value	In the Relay output function parameter, the Limit option is selected.	Enter measured value for the switch-on point.	Signed floating-point number	Country-specific: <ul style="list-style-type: none"> ▪ 0 kg/h ▪ 0 lb/min

Parameter	Prerequisite	Description	Selection / User interface / User entry	Factory setting
Switch-on delay	In the Relay output function parameter, the Limit option is selected.	Define delay for the switch-on of status output.	0.0 to 100.0 s	0.0 s
Failure mode	–	Define output behavior in alarm condition.	<ul style="list-style-type: none"> ■ Actual status ■ Open ■ Closed 	Open

* Visibility depends on order options or device settings

10.5.11 Configuring the local display

The **Display** wizard guides you systematically through all the parameters that can be configured for configuring the local display.

Navigation

"Setup" menu → Display

► Display	
Format display	→ 142
Value 1 display	→ 143
0% bargraph value 1	→ 144
100% bargraph value 1	→ 144
Value 2 display	→ 145
Value 3 display	→ 147
0% bargraph value 3	→ 148
100% bargraph value 3	→ 149
Value 4 display	→ 150

Parameter overview with brief description

Parameter	Prerequisite	Description	Selection / User entry	Factory setting
Format display	A local display is provided.	Select how measured values are shown on the display.	<ul style="list-style-type: none">▪ 1 value, max. size▪ 1 bargraph + 1 value▪ 2 values▪ 1 value large + 2 values▪ 4 values	1 value, max. size

Parameter	Prerequisite	Description	Selection / User entry	Factory setting
Value 1 display	A local display is provided.	Select the measured value that is shown on the local display.	<ul style="list-style-type: none"> ■ Mass flow ■ Volume flow ■ Corrected volume flow ■ Target mass flow * ■ Carrier mass flow * ■ Target volume flow ■ Carrier volume flow ■ Target corrected volume flow ■ Carrier corrected volume flow ■ Density ■ Reference density ■ Reference density alternative ■ GSV flow ■ GSV flow alternative ■ NSV flow ■ NSV flow alternative ■ S&W volume flow ■ Water cut ■ Oil density ■ Water density ■ Oil mass flow ■ Water mass flow ■ Oil volume flow ■ Water volume flow ■ Oil corrected volume flow ■ Water corrected volume flow ■ Weighted density average ■ Weighted temperature average ■ Concentration * ■ Temperature ■ Carrier pipe temperature * ■ Electronic temperature ■ Oscillation frequency 0 ■ Oscillation amplitude 0 * ■ Frequency fluctuation 0 ■ Oscillation damping 0 ■ Oscillation damping fluctuation 0 ■ Signal asymmetry ■ Exciter current 0 ■ Totalizer 1 ■ Totalizer 2 ■ Totalizer 3 ■ Current output 1 ■ Current output 2 * ■ Current output 3 * ■ Current output 4 * ■ Pressure 	Mass flow

Parameter	Prerequisite	Description	Selection / User entry	Factory setting
0% bargraph value 1	A local display is provided.	Enter 0% value for bar graph display.	Signed floating-point number	Country-specific: <ul style="list-style-type: none">■ 0 kg/h■ 0 lb/min
100% bargraph value 1	A local display is provided.	Enter 100% value for bar graph display.	Signed floating-point number	Depends on country and nominal diameter

Parameter	Prerequisite	Description	Selection / User entry	Factory setting
Value 2 display	A local display is provided.	Select the measured value that is shown on the local display.	<ul style="list-style-type: none"> ■ None ■ Mass flow ■ Volume flow ■ Corrected volume flow ■ Target mass flow ■ Carrier mass flow ■ Target volume flow ■ Carrier volume flow ■ Target corrected volume flow ■ Carrier corrected volume flow ■ Density ■ Reference density ■ Reference density alternative ■ GSV flow ■ GSV flow alternative ■ NSV flow ■ NSV flow alternative ■ S&W volume flow ■ Water cut ■ Oil density ■ Water density ■ Oil mass flow ■ Water mass flow ■ Oil volume flow ■ Water corrected volume flow ■ Oil corrected volume flow ■ Water volume flow ■ Weighted density average ■ Weighted temperature average ■ Concentration ■ Dynamic viscosity ■ Kinematic viscosity ■ Temp. compensated dynamic viscosity ■ Temp. compensated kinematic viscosity ■ Temperature ■ Carrier pipe temperature ■ Electronic temperature ■ Oscillation frequency 0 ■ Oscillation frequency 1 ■ Oscillation amplitude 0 ■ Oscillation amplitude 1 ■ Frequency fluctuation 0 ■ Frequency fluctuation 1 	None

Parameter	Prerequisite	Description	Selection / User entry	Factory setting
			<ul style="list-style-type: none"> ▪ Oscillation damping 0 ▪ Oscillation damping 1 ▪ Oscillation damping fluctuation 0 ▪ Oscillation damping fluctuation 1 ▪ Signal asymmetry ▪ Exciter current 0 ▪ Exciter current 1 ▪ HBSI ▪ Totalizer 1 ▪ Totalizer 2 ▪ Totalizer 3 ▪ Current output 1 ▪ Current output 2 * ▪ Current output 3 * ▪ Current output 4 * ▪ Pressure 	

Parameter	Prerequisite	Description	Selection / User entry	Factory setting
Value 3 display	A local display is provided.	Select the measured value that is shown on the local display.	<ul style="list-style-type: none"> ■ None ■ Mass flow ■ Volume flow ■ Corrected volume flow ■ Target mass flow ■ Carrier mass flow ■ Target volume flow ■ Carrier volume flow ■ Target corrected volume flow ■ Carrier corrected volume flow ■ Density ■ Reference density ■ Reference density alternative ■ GSV flow ■ GSV flow alternative ■ NSV flow ■ NSV flow alternative ■ S&W volume flow ■ Water cut ■ Oil density ■ Water density ■ Oil mass flow ■ Water mass flow ■ Oil volume flow ■ Water corrected volume flow ■ Oil corrected volume flow ■ Water volume flow ■ Weighted density average ■ Weighted temperature average ■ Concentration ■ Dynamic viscosity ■ Kinematic viscosity ■ Temp. compensated dynamic viscosity ■ Temp. compensated kinematic viscosity ■ Temperature ■ Carrier pipe temperature ■ Electronic temperature ■ Oscillation frequency 0 ■ Oscillation frequency 1 ■ Oscillation amplitude 0 ■ Oscillation amplitude 1 ■ Frequency fluctuation 0 ■ Frequency fluctuation 1 	None

Parameter	Prerequisite	Description	Selection / User entry	Factory setting
			<ul style="list-style-type: none"> ▪ Oscillation damping 0 ▪ Oscillation damping 1 ▪ Oscillation damping fluctuation 0 ▪ Oscillation damping fluctuation 1 ▪ Signal asymmetry ▪ Exciter current 0 ▪ Exciter current 1 ▪ HBSI ▪ Totalizer 1 ▪ Totalizer 2 ▪ Totalizer 3 ▪ Current output 1 ▪ Current output 2 * ▪ Current output 3 * ▪ Current output 4 * ▪ Pressure 	
0% bargraph value 3	A selection was made in the Value 3 display parameter.	Enter 0% value for bar graph display.	Signed floating-point number	Country-specific: <ul style="list-style-type: none"> ▪ 0 kg/h ▪ 0 lb/min

Parameter	Prerequisite	Description	Selection / User entry	Factory setting
100% bargraph value 3	A selection was made in the Value 3 display parameter.	Enter 100% value for bargraph display.	Signed floating-point number	0

Parameter	Prerequisite	Description	Selection / User entry	Factory setting
Value 4 display	A local display is provided.	Select the measured value that is shown on the local display.	<ul style="list-style-type: none"> ▪ None ▪ Mass flow ▪ Volume flow ▪ Corrected volume flow ▪ Target mass flow ▪ Carrier mass flow ▪ Target volume flow ▪ Carrier volume flow ▪ Target corrected volume flow ▪ Carrier corrected volume flow ▪ Density ▪ Reference density ▪ Reference density alternative ▪ GSV flow ▪ GSV flow alternative ▪ NSV flow ▪ NSV flow alternative ▪ S&W volume flow ▪ Water cut ▪ Oil density ▪ Water density ▪ Oil mass flow ▪ Water mass flow ▪ Oil volume flow ▪ Water corrected volume flow ▪ Oil corrected volume flow ▪ Water volume flow ▪ Weighted density average ▪ Weighted temperature average ▪ Concentration ▪ Dynamic viscosity ▪ Kinematic viscosity ▪ Temp. compensated dynamic viscosity ▪ Temp. compensated kinematic viscosity ▪ Temperature ▪ Carrier pipe temperature ▪ Electronic temperature ▪ Oscillation frequency 0 ▪ Oscillation frequency 1 ▪ Oscillation amplitude 0 ▪ Oscillation amplitude 1 ▪ Frequency fluctuation 0 ▪ Frequency fluctuation 1 	None

Parameter	Prerequisite	Description	Selection / User entry	Factory setting
			<ul style="list-style-type: none"> ■ Oscillation damping 0 ■ Oscillation damping 1 ■ Oscillation damping fluctuation 0 ■ Oscillation damping fluctuation 1 ■ Signal asymmetry ■ Exciter current 0 ■ Exciter current 1 ■ HBSI ■ Totalizer 1 ■ Totalizer 2 ■ Totalizer 3 ■ Current output 1 ■ Current output 2 * ■ Current output 3 * ■ Current output 4 * ■ Pressure 	

* Visibility depends on order options or device settings

10.5.12 Configuring the low flow cut off

The **Low flow cut off** wizard systematically guides the user through all the parameters that must be set to configure low flow cut off.

Navigation

"Setup" menu → Low flow cut off

► Low flow cut off	
Assign process variable	→ ⓘ 152
On value low flow cutoff	→ ⓘ 152
Off value low flow cutoff	→ ⓘ 152
Pressure shock suppression	→ ⓘ 152

Parameter overview with brief description

Parameter	Prerequisite	Description	Selection / User entry	Factory setting
Assign process variable	–	Select process variable for low flow cut off.	<ul style="list-style-type: none"> ▪ Off ▪ Mass flow ▪ Volume flow ▪ Corrected volume flow 	Mass flow
On value low flow cutoff	One of the following options is selected in the Assign process variable parameter (→ ⓘ 152): <ul style="list-style-type: none"> ▪ Mass flow ▪ Volume flow ▪ Corrected volume flow 	Enter on value for low flow cut off.	Positive floating-point number	Depends on country and nominal diameter
Off value low flow cutoff	One of the following options is selected in the Assign process variable parameter (→ ⓘ 152): <ul style="list-style-type: none"> ▪ Mass flow ▪ Volume flow ▪ Corrected volume flow 	Enter off value for low flow cut off.	0 to 100.0 %	50 %
Pressure shock suppression	One of the following options is selected in the Assign process variable parameter (→ ⓘ 152): <ul style="list-style-type: none"> ▪ Mass flow ▪ Volume flow ▪ Corrected volume flow 	Enter time frame for signal suppression (= active pressure shock suppression).	0 to 100 s	0 s

10.5.13 Configuring the partial filled pipe detection

The **Partial filled pipe detection** wizard guides you systematically through all parameters that have to be set for configuring the monitoring of the pipe filling.

Navigation

"Setup" menu → Partially filled pipe detection

▶ **Partially filled pipe detection**

Assign process variable	→ ⓘ 153
Low value partial filled pipe detection	→ ⓘ 153
High value partial filled pipe detection	→ ⓘ 153
Response time part. filled pipe detect.	→ ⓘ 153

Parameter overview with brief description

Parameter	Prerequisite	Description	Selection / User entry	Factory setting
Assign process variable	–	Select process variable for partially filled pipe detection.	<ul style="list-style-type: none"> ▪ Off ▪ Density ▪ Reference density 	Off
Low value partial filled pipe detection	One of the following options is selected in the Assign process variable parameter (→ ⓘ 153): <ul style="list-style-type: none"> ▪ Density ▪ Reference density 	Enter lower limit value for deactivating partialy filled pipe detection.	Signed floating-point number	200
High value partial filled pipe detection	One of the following options is selected in the Assign process variable parameter (→ ⓘ 153): <ul style="list-style-type: none"> ▪ Density ▪ Reference density 	Enter upper limit value for deactivating partialy filled pipe detection.	Signed floating-point number	6 000
Response time part. filled pipe detect.	One of the following options is selected in the Assign process variable parameter (→ ⓘ 153): <ul style="list-style-type: none"> ▪ Density ▪ Reference density 	Enter time before diagnostic message is displayed for partially filled pipe detection.	0 to 100 s	1 s

10.6 Advanced settings

The **Advanced setup** submenu together with its submenus contains parameters for specific settings.

Navigation to the "Advanced setup" submenu

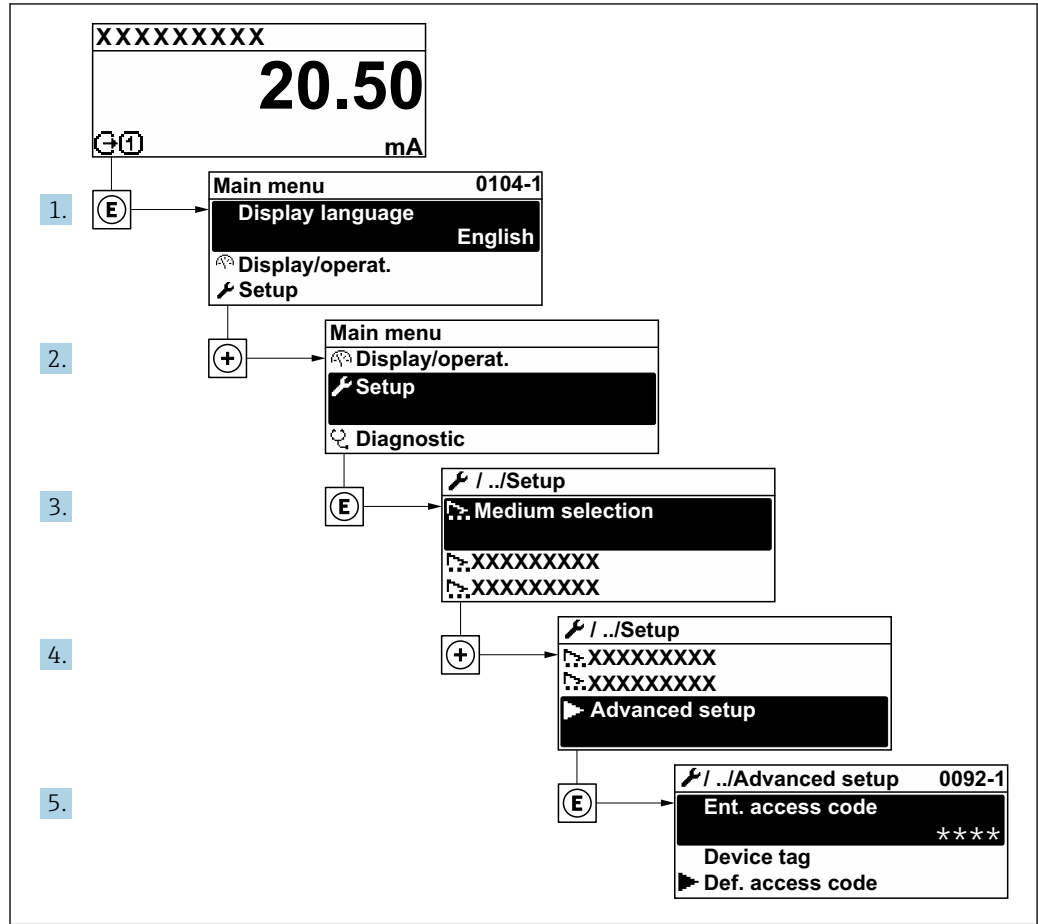

A0032223-EN

i The number of submenus can vary depending on the device version. Some submenus are not dealt with in the Operating Instructions. These submenus and the parameters they contain are explained in the Special Documentation for the device.

Navigation

"Setup" menu → Advanced setup

▶ Advanced setup	
Enter access code	→ 155
▶ Calculated values	→ 155
▶ Sensor adjustment	→ 156
▶ Totalizer 1 to n	→ 157
▶ Display	→ 159

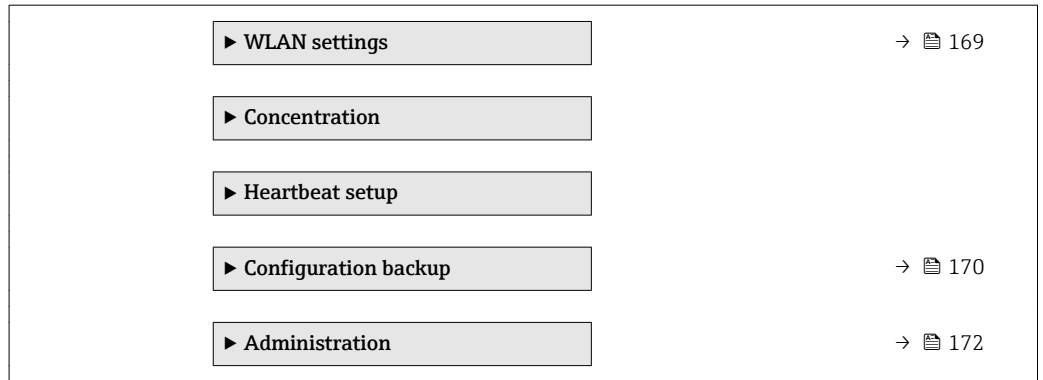

10.6.1 Using the parameter to enter the access code

Navigation

"Setup" menu → Advanced setup

Parameter overview with brief description

Parameter	Description	User entry
Enter access code	Enter access code to disable write protection of parameters.	0 to 9999

10.6.2 Calculated values

The **Calculated values** submenu contains parameters for calculating the corrected volume flow.

Navigation

"Setup" menu → Advanced setup → Calculated values

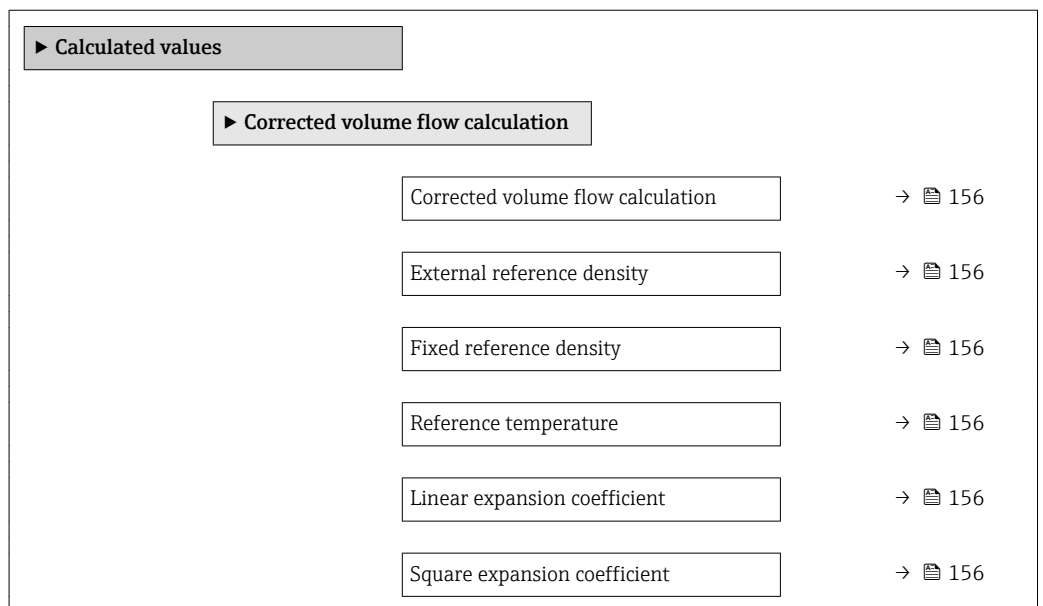

Parameter overview with brief description

Parameter	Prerequisite	Description	Selection / User interface / User entry	Factory setting
Corrected volume flow calculation	–	Select reference density for calculating the corrected volume flow.	<ul style="list-style-type: none"> ■ Fixed reference density ■ Calculated reference density ■ External reference density ■ Current input 1 * ■ Current input 2 * ■ Current input 3 * 	Calculated reference density
External reference density	In the Corrected volume flow calculation parameter, the External reference density option is selected.	Shows external reference density.	Floating point number with sign	–
Fixed reference density	The Fixed reference density option is selected in the Corrected volume flow calculation parameter parameter.	Enter fixed value for reference density.	Positive floating-point number	1 kg/Nl
Reference temperature	The Calculated reference density option is selected in the Corrected volume flow calculation parameter.	Enter reference temperature for calculating the reference density.	–273.15 to 99 999 °C	Country-specific: <ul style="list-style-type: none"> ■ +20 °C ■ +68 °F
Linear expansion coefficient	The Calculated reference density option is selected in the Corrected volume flow calculation parameter parameter.	Enter linear, medium-specific expansion coefficient for calculating the reference density.	Signed floating-point number	0.0 1/K
Square expansion coefficient	The Calculated reference density option is selected in the Corrected volume flow calculation parameter parameter.	For media with a non-linear expansion pattern: enter the quadratic, medium-specific expansion coefficient for calculating the reference density.	Signed floating-point number	0.0 1/K ²

* Visibility depends on order options or device settings

10.6.3 Carrying out a sensor adjustment

The **Sensor adjustment** submenu contains parameters that pertain to the functionality of the sensor.

Navigation

"Setup" menu → Advanced setup → Sensor adjustment

▶ Sensor adjustment	
Installation direction	→ ⓘ 157
▶ Zero point adjustment	→ ⓘ 157

Parameter overview with brief description

Parameter	Description	Selection	Factory setting
Installation direction	Set sign of flow direction to match the direction of the arrow on the sensor.	<ul style="list-style-type: none"> ▪ Flow in arrow direction ▪ Flow against arrow direction 	Flow in arrow direction

Zero point adjustment

All measuring devices are calibrated in accordance with state-of-the-art technology. Calibration takes place under reference conditions →  241. Therefore, a zero point adjustment in the field is generally not required.

Experience shows that zero point adjustment is advisable only in special cases:

- To achieve maximum measuring accuracy even with low flow rates.
- Under extreme process or operating conditions (e.g. very high process temperatures or very high-viscosity fluids).

Navigation

"Setup" menu → Advanced setup → Sensor adjustment → Zero point adjustment

▶ Zero point adjustment

Zero point adjustment control

→  157

Progress

→  157

Parameter overview with brief description

Parameter	Description	Selection / User interface	Factory setting
Zero point adjustment control	Start zero point adjustment.	<ul style="list-style-type: none"> ▪ Cancel ▪ Busy ▪ Zero point adjust failure ▪ Start 	Cancel
Progress	Shows the progress of the process.	0 to 100 %	-

10.6.4 Configuring the totalizer

In the "Totalizer 1 to n" submenu the individual totalizer can be configured.

Navigation

"Setup" menu → Advanced setup → Totalizer 1 to n

▶ Totalizer 1 to n

Assign process variable

→  158

Unit totalizer 1 to n

→  158



Totalizer operation mode

→  158

Failure mode

→  158

Parameter overview with brief description

Parameter	Prerequisite	Description	Selection	Factory setting
Assign process variable	–	Select process variable for totalizer.	<ul style="list-style-type: none"> ▪ Off ▪ Mass flow ▪ Volume flow ▪ Corrected volume flow ▪ Target mass flow[*] ▪ Carrier mass flow[*] ▪ Target volume flow ▪ Carrier volume flow ▪ Target corrected volume flow ▪ Carrier corrected volume flow ▪ GSV flow ▪ GSV flow alternative ▪ NSV flow ▪ NSV flow alternative ▪ S&W volume flow ▪ Oil mass flow ▪ Water mass flow ▪ Oil volume flow ▪ Water volume flow ▪ Oil corrected volume flow ▪ Water corrected volume flow 	Mass flow
Unit totalizer 1 to n	One of the following options is selected in the Assign process variable parameter (→  158) of the Totalizer 1 to n submenu: <ul style="list-style-type: none"> ▪ Volume flow ▪ Mass flow ▪ Corrected volume flow ▪ Target mass flow[*] ▪ Carrier mass flow[*] 	Select process variable totalizer unit.	Unit choose list	Country-specific: <ul style="list-style-type: none"> ▪ kg ▪ lb
Totalizer operation mode	One of the following options is selected in the Assign process variable parameter (→  158) of the Totalizer 1 to n submenu: <ul style="list-style-type: none"> ▪ Volume flow ▪ Mass flow ▪ Corrected volume flow ▪ Target mass flow[*] ▪ Carrier mass flow[*] 	Select totalizer calculation mode.	<ul style="list-style-type: none"> ▪ Net flow total ▪ Forward flow total ▪ Reverse flow total 	Net flow total
Failure mode	One of the following options is selected in the Assign process variable parameter (→  158) of the Totalizer 1 to n submenu: <ul style="list-style-type: none"> ▪ Volume flow ▪ Mass flow ▪ Corrected volume flow ▪ Target mass flow[*] ▪ Carrier mass flow[*] 	Define totalizer behavior in alarm condition.	<ul style="list-style-type: none"> ▪ Stop ▪ Actual value ▪ Last valid value 	Stop

* Visibility depends on order options or device settings

10.6.5 Carrying out additional display configurations

In the **Display** submenu you can set all the parameters associated with the configuration of the local display.

Navigation

"Setup" menu → Advanced setup → Display

► Display	
Format display	→ 160
Value 1 display	→ 161
0% bargraph value 1	→ 162
100% bargraph value 1	→ 162
Decimal places 1	→ 162
Value 2 display	→ 163
Decimal places 2	→ 164
Value 3 display	→ 165
0% bargraph value 3	→ 166
100% bargraph value 3	→ 166
Decimal places 3	→ 166
Value 4 display	→ 167
Decimal places 4	→ 168
Display language	→ 168
Display interval	→ 168
Display damping	→ 168
Header	→ 168
Header text	→ 168
Separator	→ 169
Backlight	→ 169

Parameter overview with brief description

Parameter	Prerequisite	Description	Selection / User entry	Factory setting
Format display	A local display is provided.	Select how measured values are shown on the display.	<ul style="list-style-type: none">▪ 1 value, max. size▪ 1 bargraph + 1 value▪ 2 values▪ 1 value large + 2 values▪ 4 values	1 value, max. size

Parameter	Prerequisite	Description	Selection / User entry	Factory setting
Value 1 display	A local display is provided.	Select the measured value that is shown on the local display.	<ul style="list-style-type: none"> ■ Mass flow ■ Volume flow ■ Corrected volume flow ■ Target mass flow * ■ Carrier mass flow * ■ Target volume flow ■ Carrier volume flow ■ Target corrected volume flow ■ Carrier corrected volume flow ■ Density ■ Reference density ■ Reference density alternative ■ GSV flow ■ GSV flow alternative ■ NSV flow ■ NSV flow alternative ■ S&W volume flow ■ Water cut ■ Oil density ■ Water density ■ Oil mass flow ■ Water mass flow ■ Oil volume flow ■ Water volume flow ■ Oil corrected volume flow ■ Water corrected volume flow ■ Weighted density average ■ Weighted temperature average ■ Concentration * ■ Temperature ■ Carrier pipe temperature * ■ Electronic temperature ■ Oscillation frequency 0 ■ Oscillation amplitude 0 * ■ Frequency fluctuation 0 ■ Oscillation damping 0 ■ Oscillation damping fluctuation 0 ■ Signal asymmetry ■ Exciter current 0 ■ Totalizer 1 ■ Totalizer 2 ■ Totalizer 3 ■ Current output 1 ■ Current output 2 * ■ Current output 3 * ■ Current output 4 * ■ Pressure 	Mass flow

Parameter	Prerequisite	Description	Selection / User entry	Factory setting
0% bargraph value 1	A local display is provided.	Enter 0% value for bar graph display.	Signed floating-point number	Country-specific: <ul style="list-style-type: none"> ■ 0 kg/h ■ 0 lb/min
100% bargraph value 1	A local display is provided.	Enter 100% value for bar graph display.	Signed floating-point number	Depends on country and nominal diameter
Decimal places 1	A measured value is specified in the Value 1 display parameter.	Select the number of decimal places for the display value.	<ul style="list-style-type: none"> ■ x ■ x.x ■ x.xx ■ x.xxx ■ x.xxxx 	x.xx

Parameter	Prerequisite	Description	Selection / User entry	Factory setting
Value 2 display	A local display is provided.	Select the measured value that is shown on the local display.	<ul style="list-style-type: none"> ■ None ■ Mass flow ■ Volume flow ■ Corrected volume flow ■ Target mass flow ■ Carrier mass flow ■ Target volume flow ■ Carrier volume flow ■ Target corrected volume flow ■ Carrier corrected volume flow ■ Density ■ Reference density ■ Reference density alternative ■ GSV flow ■ GSV flow alternative ■ NSV flow ■ NSV flow alternative ■ S&W volume flow ■ Water cut ■ Oil density ■ Water density ■ Oil mass flow ■ Water mass flow ■ Oil volume flow ■ Water corrected volume flow ■ Oil corrected volume flow ■ Water volume flow ■ Weighted density average ■ Weighted temperature average ■ Concentration ■ Dynamic viscosity ■ Kinematic viscosity ■ Temp. compensated dynamic viscosity ■ Temp. compensated kinematic viscosity ■ Temperature ■ Carrier pipe temperature ■ Electronic temperature ■ Oscillation frequency 0 ■ Oscillation frequency 1 ■ Oscillation amplitude 0 ■ Oscillation amplitude 1 ■ Frequency fluctuation 0 ■ Frequency fluctuation 1 	None

Parameter	Prerequisite	Description	Selection / User entry	Factory setting
			<ul style="list-style-type: none"> ▪ Oscillation damping 0 ▪ Oscillation damping 1 ▪ Oscillation damping fluctuation 0 ▪ Oscillation damping fluctuation 1 ▪ Signal asymmetry ▪ Exciter current 0 ▪ Exciter current 1 ▪ HBSI ▪ Totalizer 1 ▪ Totalizer 2 ▪ Totalizer 3 ▪ Current output 1 ▪ Current output 2 * ▪ Current output 3 * ▪ Current output 4 * ▪ Pressure 	
Decimal places 2	A measured value is specified in the Value 2 display parameter.	Select the number of decimal places for the display value.	<ul style="list-style-type: none"> ▪ x ▪ x.x ▪ x.xx ▪ x.xxx ▪ x.xxxx 	x.xx

Parameter	Prerequisite	Description	Selection / User entry	Factory setting
Value 3 display	A local display is provided.	Select the measured value that is shown on the local display.	<ul style="list-style-type: none"> ■ None ■ Mass flow ■ Volume flow ■ Corrected volume flow ■ Target mass flow ■ Carrier mass flow ■ Target volume flow ■ Carrier volume flow ■ Target corrected volume flow ■ Carrier corrected volume flow ■ Density ■ Reference density ■ Reference density alternative ■ GSV flow ■ GSV flow alternative ■ NSV flow ■ NSV flow alternative ■ S&W volume flow ■ Water cut ■ Oil density ■ Water density ■ Oil mass flow ■ Water mass flow ■ Oil volume flow ■ Water corrected volume flow ■ Oil corrected volume flow ■ Water volume flow ■ Weighted density average ■ Weighted temperature average ■ Concentration ■ Dynamic viscosity ■ Kinematic viscosity ■ Temp. compensated dynamic viscosity ■ Temp. compensated kinematic viscosity ■ Temperature ■ Carrier pipe temperature ■ Electronic temperature ■ Oscillation frequency 0 ■ Oscillation frequency 1 ■ Oscillation amplitude 0 ■ Oscillation amplitude 1 ■ Frequency fluctuation 0 ■ Frequency fluctuation 1 	None

Parameter	Prerequisite	Description	Selection / User entry	Factory setting
			<ul style="list-style-type: none"> ▪ Oscillation damping 0 ▪ Oscillation damping 1 ▪ Oscillation damping fluctuation 0 ▪ Oscillation damping fluctuation 1 ▪ Signal asymmetry ▪ Exciter current 0 ▪ Exciter current 1 ▪ HBSI ▪ Totalizer 1 ▪ Totalizer 2 ▪ Totalizer 3 ▪ Current output 1 ▪ Current output 2 * ▪ Current output 3 * ▪ Current output 4 * ▪ Pressure 	
0% bargraph value 3	A selection was made in the Value 3 display parameter.	Enter 0% value for bar graph display.	Signed floating-point number	Country-specific: <ul style="list-style-type: none"> ▪ 0 kg/h ▪ 0 lb/min
100% bargraph value 3	A selection was made in the Value 3 display parameter.	Enter 100% value for bar graph display.	Signed floating-point number	0
Decimal places 3	A measured value is specified in the Value 3 display parameter.	Select the number of decimal places for the display value.	<ul style="list-style-type: none"> ▪ x ▪ x.x ▪ x.xx ▪ x.xxx ▪ x.xxxx 	x.xx

Parameter	Prerequisite	Description	Selection / User entry	Factory setting
Value 4 display	A local display is provided.	Select the measured value that is shown on the local display.	<ul style="list-style-type: none"> ■ None ■ Mass flow ■ Volume flow ■ Corrected volume flow ■ Target mass flow ■ Carrier mass flow ■ Target volume flow ■ Carrier volume flow ■ Target corrected volume flow ■ Carrier corrected volume flow ■ Density ■ Reference density ■ Reference density alternative ■ GSV flow ■ GSV flow alternative ■ NSV flow ■ NSV flow alternative ■ S&W volume flow ■ Water cut ■ Oil density ■ Water density ■ Oil mass flow ■ Water mass flow ■ Oil volume flow ■ Water corrected volume flow ■ Oil corrected volume flow ■ Water volume flow ■ Weighted density average ■ Weighted temperature average ■ Concentration ■ Dynamic viscosity ■ Kinematic viscosity ■ Temp. compensated dynamic viscosity ■ Temp. compensated kinematic viscosity ■ Temperature ■ Carrier pipe temperature ■ Electronic temperature ■ Oscillation frequency 0 ■ Oscillation frequency 1 ■ Oscillation amplitude 0 ■ Oscillation amplitude 1 ■ Frequency fluctuation 0 ■ Frequency fluctuation 1 	None

Parameter	Prerequisite	Description	Selection / User entry	Factory setting
			<ul style="list-style-type: none"> ▪ Oscillation damping 0 ▪ Oscillation damping 1 ▪ Oscillation damping fluctuation 0 ▪ Oscillation damping fluctuation 1 ▪ Signal asymmetry ▪ Exciter current 0 ▪ Exciter current 1 ▪ HBSI ▪ Totalizer 1 ▪ Totalizer 2 ▪ Totalizer 3 ▪ Current output 1 ▪ Current output 2 * ▪ Current output 3 * ▪ Current output 4 * ▪ Pressure 	
Decimal places 4	A measured value is specified in the Value 4 display parameter.	Select the number of decimal places for the display value.	<ul style="list-style-type: none"> ▪ x ▪ x.x ▪ x.xx ▪ x.xxx ▪ x.xxxx 	x.xx
Display language	A local display is provided.	Set display language.	<ul style="list-style-type: none"> ▪ English ▪ Deutsch * ▪ Français * ▪ Español * ▪ Italiano * ▪ Nederlands * ▪ Portuguesa * ▪ Polski * ▪ русский язык (Russian) * ▪ Svenska * ▪ Türkçe * ▪ 中文 (Chinese) * ▪ 日本語 (Japanese) * ▪ 한국어 (Korean) * ▪ Bahasa Indonesia * ▪ tiếng Việt (Vietnamese) * ▪ čeština (Czech) * 	English (alternatively, the ordered language is preset in the device)
Display interval	A local display is provided.	Set time measured values are shown on display if display alternates between values.	1 to 10 s	5 s
Display damping	A local display is provided.	Set display reaction time to fluctuations in the measured value.	0.0 to 999.9 s	0.0 s
Header	A local display is provided.	Select header contents on local display.	<ul style="list-style-type: none"> ▪ Device tag ▪ Free text 	Device tag
Header text	In the Header parameter, the Free text option is selected.	Enter display header text.	Max. 12 characters such as letters, numbers or special characters (e.g. @, %, /)	-----

Parameter	Prerequisite	Description	Selection / User entry	Factory setting
Separator	A local display is provided.	Select decimal separator for displaying numerical values.	<ul style="list-style-type: none"> ▪ . (point) ▪ , (comma) 	. (point)
Backlight	One of the following conditions is met: <ul style="list-style-type: none"> ▪ Order code for "Display; operation", option F "4-line, illum.; touch control" ▪ Order code for "Display; operation", option G "4-line, illum.; touch control +WLAN" 	Switch the local display backlight on and off.	<ul style="list-style-type: none"> ▪ Disable ▪ Enable 	Enable

* Visibility depends on order options or device settings

10.6.6 WLAN configuration

The **WLAN Settings** submenu guides the user systematically through all the parameters that have to be set for the WLAN configuration.



Navigation

"Setup" menu → Advanced setup → WLAN settings

▶ WLAN settings

WLAN	→ ⓘ 170
WLAN mode	→ ⓘ 170
SSID name	→ ⓘ 170
Network security	→ ⓘ 170
Security identification	→ ⓘ 170
User name	→ ⓘ 170
WLAN password	→ ⓘ 170
WLAN IP address	→ ⓘ 170
WLAN passphrase	→ ⓘ 170
Assign SSID name	→ ⓘ 170
SSID name	→ ⓘ 170
Connection state	→ ⓘ 170
Received signal strength	→ ⓘ 170

Parameter overview with brief description

Parameter	Prerequisite	Description	Selection / User entry / User interface	Factory setting
WLAN	–	Switch WLAN on and off.	<ul style="list-style-type: none"> ▪ Disable ▪ Enable 	Enable
WLAN mode	–	Select WLAN mode.	<ul style="list-style-type: none"> ▪ WLAN access point ▪ WLAN Client 	WLAN access point
SSID name	The client is activated.	Enter the user-defined SSID name (max. 32 characters).	–	–
Network security	–	Select the security type of the WLAN network.	<ul style="list-style-type: none"> ▪ Unsecured ▪ WPA2-PSK ▪ EAP-PEAP with MSCHAPv2 ▪ EAP-PEAP MSCHAPv2 no server authentic. ▪ EAP-TLS 	WPA2-PSK
Security identification	–	Select security settings and download these settings via menu Data management > Security > WLAN.	<ul style="list-style-type: none"> ▪ Root certificate ▪ Device certificate ▪ Device private key 	–
User name	–	Enter user name.	–	–
WLAN password	–	Enter WLAN password.	–	–
WLAN IP address	–	Enter IP address of the device WLAN interface.	4 octet: 0 to 255 (in the particular octet)	192.168.1.212
WLAN passphrase	The WPA2-PSK option is selected in the Security type parameter.	Enter the network key (8 to 32 characters).  The network key supplied with the device should be changed during commissioning for security reasons.	8 to 32-digit character string comprising numbers, letters and special characters	Serial number of the measuring device (e.g. L100A802000)
Assign SSID name	–	Select which name will be used for SSID: device tag or user-defined name.	<ul style="list-style-type: none"> ▪ Device tag ▪ User-defined 	User-defined
SSID name	<ul style="list-style-type: none"> ▪ The User-defined option is selected in the Assign SSID name parameter. ▪ The WLAN access point option is selected in the WLAN mode parameter. 	Enter the user-defined SSID name (max. 32 characters).  The user-defined SSID name may only be assigned once. If the SSID name is assigned more than once, the devices can interfere with one another.	Max. 32-digit character string comprising numbers, letters and special characters	EH_device designation_last 7 digits of the serial number (e.g. EH_Promass_500_A 802000)
Connection state	–	Displays the connection status.	<ul style="list-style-type: none"> ▪ Connected ▪ Not connected 	Not connected
Received signal strength	–	Shows the received signal strength.	<ul style="list-style-type: none"> ▪ Low ▪ Medium ▪ High 	High

10.6.7 Configuration management

After commissioning, you can save the current device configuration or restore the previous device configuration.

You can do so using the **Configuration management** parameter and the related options found in the **Configuration backup** submenu.

Navigation

"Setup" menu → Advanced setup → Configuration backup

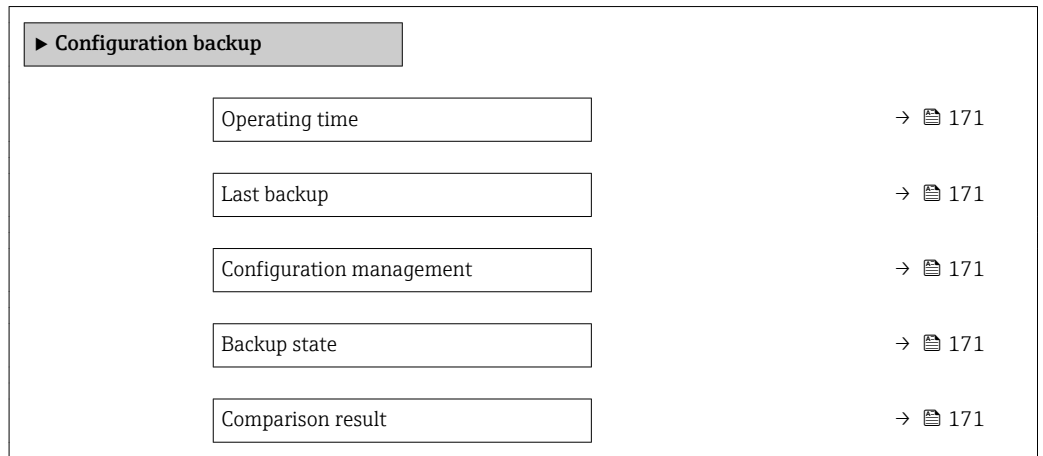

Parameter overview with brief description

Parameter	Description	User interface / Selection	Factory setting
Operating time	Indicates how long the device has been in operation.	Days (d), hours (h), minutes (m) and seconds (s)	–
Last backup	Shows when the last data backup was saved to HistoROM backup.	Days (d), hours (h), minutes (m) and seconds (s)	–
Configuration management	Select action for managing the device data in the HistoROM backup.	<ul style="list-style-type: none"> ■ Cancel ■ Execute backup ■ Restore ■ Compare ■ Clear backup data 	Cancel
Backup state	Shows the current status of data saving or restoring.	<ul style="list-style-type: none"> ■ None ■ Backup in progress ■ Restoring in progress ■ Delete in progress ■ Compare in progress ■ Restoring failed ■ Backup failed 	None
Comparison result	Comparison of current device data with HistoROM backup.	<ul style="list-style-type: none"> ■ Settings identical ■ Settings not identical ■ No backup available ■ Backup settings corrupt ■ Check not done ■ Dataset incompatible 	Check not done

Function scope of the "Configuration management" parameter

Options	Description
Cancel	No action is executed and the user exits the parameter.
Execute backup	A backup copy of the current device configuration is saved from the HistoROM backup to the memory of the device. The backup copy includes the transmitter data of the device.
Restore	The last backup copy of the device configuration is restored from the device memory to the device's HistoROM backup. The backup copy includes the transmitter data of the device.

Options	Description
Compare	The device configuration saved in the device memory is compared with the current device configuration of the HistoROM backup.
Clear backup data	The backup copy of the device configuration is deleted from the memory of the device.

 **HistoROM backup**
 A HistoROM is a "non-volatile" device memory in the form of an EEPROM.



 While this action is in progress, the configuration cannot be edited via the local display and a message on the processing status appears on the display.

10.6.8 Using parameters for device administration

The **Administration** submenu systematically guides the user through all the parameters that can be used for device administration purposes.

Navigation



"Setup" menu → Advanced setup → Administration

▶ Administration		
▶ Define access code		→  172
▶ Reset access code		→  173
Device reset		→  173

Using the parameter to define the access code

Navigation

"Setup" menu → Advanced setup → Administration → Define access code

▶ Define access code		
Define access code		→  172
Confirm access code		→  172

Parameter overview with brief description

Parameter	Description	User entry
Define access code	Restrict write-access to parameters to protect the configuration of the device against unintentional changes.	Max. 16-digit character string comprising numbers, letters and special characters
Confirm access code	Confirm the entered access code.	Max. 16-digit character string comprising numbers, letters and special characters

Using the parameter to reset the access code

Navigation

"Setup" menu → Advanced setup → Administration → Reset access code

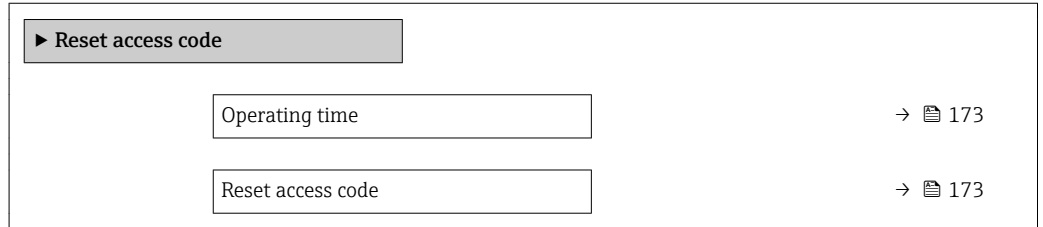

Parameter overview with brief description

Parameter	Description	User interface / User entry	Factory setting
Operating time	Indicates how long the device has been in operation.	Days (d), hours (h), minutes (m) and seconds (s)	-
Reset access code	Reset access code to factory settings.  For a reset code, contact your Endress+Hauser service organization. The reset code can only be entered via: <ul style="list-style-type: none"> ▪ Web browser ▪ DeviceCare, FieldCare (via service interface CDI-RJ45) ▪ Fieldbus 	Character string comprising numbers, letters and special characters	0x00

Using the parameter to reset the device

Navigation

"Setup" menu → Advanced setup → Administration

Parameter overview with brief description

Parameter	Description	Selection	Factory setting
Device reset	Reset the device configuration - either entirely or in part - to a defined state.	<ul style="list-style-type: none"> ▪ Cancel ▪ To delivery settings ▪ Restart device ▪ Restore S-DAT backup 	Cancel









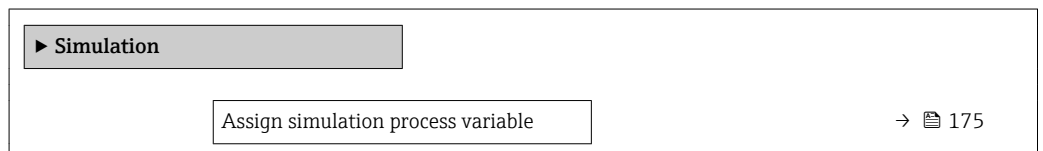









10.7 Simulation

The **Simulation** submenu enables you to simulate, without a real flow situation, various process variables in the process and the device alarm mode and to verify downstream signal chains (switching valves or closed-control loops).

Navigation



"Diagnostics" menu → Simulation



Process variable value	→  175
Status input simulation	→  175
Input signal level	→  175
Current input 1 to n simulation	→  176
Value current input 1 to n	→  176
Current output 1 to n simulation	→  176
Value current output 1 to n	→  176
Frequency output simulation 1 to n	→  176
Frequency value 1 to n	→  176
Pulse output simulation 1 to n	→  176
Pulse value 1 to n	→  176
Switch output simulation 1 to n	→  176
Switch status 1 to n	→  176
Relay output 1 to n simulation	→  176
Switch status 1 to n	→  176
Device alarm simulation	→  176
Diagnostic event category	→  176
Diagnostic event simulation	→  177

Parameter overview with brief description

Parameter	Prerequisite	Description	Selection / User entry / User interface	Factory setting
Assign simulation process variable	–	Select a process variable for the simulation process that is activated.	<ul style="list-style-type: none"> ▪ Off ▪ Mass flow ▪ Volume flow ▪ Corrected volume flow ▪ Target volume flow ▪ Carrier volume flow ▪ Target corrected volume flow ▪ Carrier corrected volume flow ▪ Density ▪ Reference density ▪ Reference density alternative ▪ GSV flow ▪ GSV flow alternative ▪ NSV flow ▪ NSV flow alternative ▪ S&W volume flow ▪ Water cut ▪ Oil density ▪ Water density ▪ Oil mass flow ▪ Water mass flow ▪ Oil volume flow ▪ Water volume flow ▪ Oil corrected volume flow ▪ Water corrected volume flow ▪ Weighted density average ▪ Weighted temperature average ▪ Temperature ▪ Concentration * ▪ Target mass flow * ▪ Carrier mass flow * 	Off
Process variable value	One of the following options is selected in the Assign simulation process variable parameter (→ 175): <ul style="list-style-type: none"> ▪ Mass flow ▪ Volume flow ▪ Corrected volume flow ▪ Density ▪ Reference density ▪ Temperature ▪ Concentration * ▪ Target mass flow * ▪ Carrier mass flow * 	Enter the simulation value for the selected process variable.	Depends on the process variable selected	0
Status input simulation	–	Switch simulation of the status input on and off.	<ul style="list-style-type: none"> ▪ Off ▪ On 	Off
Input signal level	In the Status input simulation parameter, the On option is selected.	Select the signal level for the simulation of the status input.	<ul style="list-style-type: none"> ▪ High ▪ Low 	High



Parameter	Prerequisite	Description	Selection / User entry / User interface	Factory setting
Current input 1 to n simulation	–	Switch simulation of the current input on and off.	<ul style="list-style-type: none"> ▪ Off ▪ On 	Off
Value current input 1 to n	In the Current input 1 to n simulation parameter, the On option is selected.	Enter the current value for simulation.	0 to 22.5 mA	0 mA
Current output 1 to n simulation	–	Switch the simulation of the current output on and off.	<ul style="list-style-type: none"> ▪ Off ▪ On 	Off
Value current output 1 to n	In the Current output 1 to n simulation parameter, the On option is selected.	Enter the current value for simulation.	3.59 to 22.5 mA	3.59 mA
Frequency output simulation 1 to n	In the Operating mode parameter, the Frequency option is selected.	Switch the simulation of the frequency output on and off.	<ul style="list-style-type: none"> ▪ Off ▪ On 	Off
Frequency value 1 to n	In the Frequency output simulation 1 to n parameter, the On option is selected.	Enter the frequency value for the simulation.	0.0 to 12 500.0 Hz	0.0 Hz
Pulse output simulation 1 to n	In the Operating mode parameter, the Pulse option is selected.	Set and switch off the pulse output simulation.  For Fixed value option: Pulse width parameter (→  129) defines the pulse width of the pulses output.	<ul style="list-style-type: none"> ▪ Off ▪ Fixed value ▪ Down-counting value 	Off
Pulse value 1 to n	In the Pulse output simulation 1 to n parameter, the Down-counting value option is selected.	Enter the number of pulses for simulation.	0 to 65 535	0
Switch output simulation 1 to n	In the Operating mode parameter, the Switch option is selected.	Switch the simulation of the switch output on and off.	<ul style="list-style-type: none"> ▪ Off ▪ On 	Off
Switch status 1 to n	–	Select the status of the status output for the simulation.	<ul style="list-style-type: none"> ▪ Open ▪ Closed 	Open
Relay output 1 to n simulation	–	Switch simulation of the relay output on and off.	<ul style="list-style-type: none"> ▪ Off ▪ On 	Off
Switch status 1 to n	The On option is selected in the Switch output simulation 1 to n parameter parameter.	Select status of the relay output for the simulation.	<ul style="list-style-type: none"> ▪ Open ▪ Closed 	Open
Pulse output simulation	–	Set and switch off the pulse output simulation.  For Fixed value option: Pulse width parameter defines the pulse width of the pulses output.	<ul style="list-style-type: none"> ▪ Off ▪ Fixed value ▪ Down-counting value 	Off
Pulse value	In the Pulse output simulation parameter, the Down-counting value option is selected.	Set and switch off the pulse output simulation.	0 to 65 535	0
Device alarm simulation	–	Switch the device alarm on and off.	<ul style="list-style-type: none"> ▪ Off ▪ On 	Off
Diagnostic event category	–	Select a diagnostic event category.	<ul style="list-style-type: none"> ▪ Sensor ▪ Electronics ▪ Configuration ▪ Process 	Process

Parameter	Prerequisite	Description	Selection / User entry / User interface	Factory setting
Diagnostic event simulation	–	Select a diagnostic event to simulate this event.	<ul style="list-style-type: none"> ▪ Off ▪ Diagnostic event picklist (depends on the category selected) 	Off
Logging interval	–	Define the logging interval tlog for data logging. This value defines the time interval between the individual data points in the memory.	1.0 to 3 600.0 s	–

* Visibility depends on order options or device settings

10.8 Protecting settings from unauthorized access

The following write protection options exist in order to protect the configuration of the measuring device from unintentional modification:



- Protect access to parameters via access code →  177
- Protect access to local operation via key locking →  82
- Protect access to measuring device via write protection switch →  178

10.8.1 Write protection via access code



The effects of the user-specific access code are as follows:

- Via local operation, the parameters for the measuring device configuration are write-protected and their values can no longer be changed.
- Device access is protected via the Web browser, as are the parameters for the measuring device configuration.
- Device access is protected via FieldCare or DeviceCare (via CDI-RJ45 service interface), as are the parameters for the measuring device configuration.

Defining the access code via local display

1. Navigate to the **Define access code** parameter (→  172).
2. Define a max. 16-digit character string comprising numbers, letters and special characters as the access code.
3. Enter the access code again in the **Confirm access code** parameter (→  172) to confirm the code.
 - ↳ The -symbol appears in front of all write-protected parameters.

The device automatically locks the write-protected parameters again if a key is not pressed for 10 minutes in the navigation and editing view. The device locks the write-protected parameters automatically after 60 s if the user skips back to the operational display mode from the navigation and editing view.



-  ▪ If parameter write protection is activated via an access code, it can also only be deactivated via this access code →  81.
- The user role with which the user is currently logged on via the local display is indicated by the →  81 **Access status** parameter. Navigation path: Operation → Access status

Parameters which can always be modified via the local display

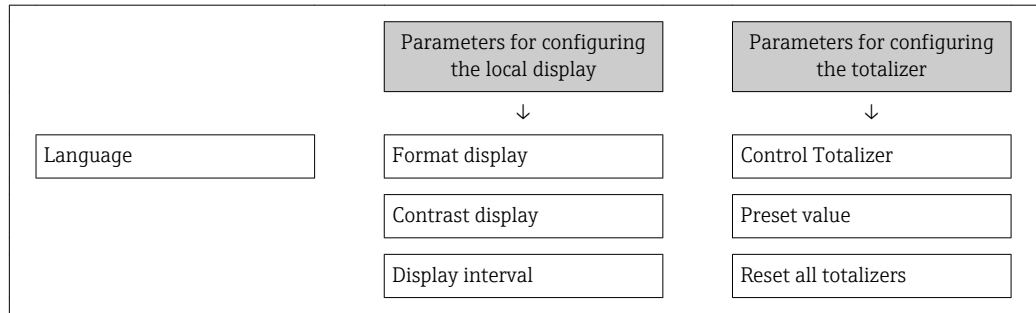

Certain parameters that do not affect the measurement are excepted from parameter write protection via the local display. Despite the user-specific access code, they can always be modified, even if the other parameters are locked.



Defining the access code via the Web browser

1. Navigate to the **Define access code** parameter (→  172).
2. Define a max. 16-digit numeric code as an access code.
3. Enter the access code again in the **Confirm access code** parameter (→  172) to confirm the code.
 - ↳ The Web browser switches to the login page.

 If no action is performed for 10 minutes, the Web browser automatically returns to the login page.



-  If parameter write protection is activated via an access code, it can also only be deactivated via this access code →  81.
- The user role with which the user is currently logged on via Web browser is indicated by the **Access status** parameter. Navigation path: Operation → Access status

Resetting the access code

If you misplace the user-specific access code, it is possible to reset the code to the factory setting. A reset code must be entered for this purpose. The user-specific access code can then be defined again afterwards.

Via Web browser, FieldCare, DeviceCare (via CDI-RJ45 service interface), fieldbus

 For a reset code, contact your Endress+Hauser service organization.

1. Navigate to the **Reset access code** parameter (→  173).
2. Enter the reset code.
 - ↳ The access code has been reset to the factory setting **0000**. It can be redefined →  177.

10.8.2 Write protection via write protection switch

Unlike parameter write protection via a user-specific access code, this allows write access to the entire operating menu - except for the **"Contrast display" parameter** - to be locked.

The parameter values are now read only and cannot be edited any more (exception **"Contrast display" parameter**):

- Via local display
- Via EtherNet/IP protocol

Proline 500 – digital

WARNING

Excessive tightening torque applied to the fixing screws!

Risk of damaging the plastic transmitter.

- ▶ Tighten the fixing screws as per the tightening torque: 2 Nm (1.5 lbf ft)

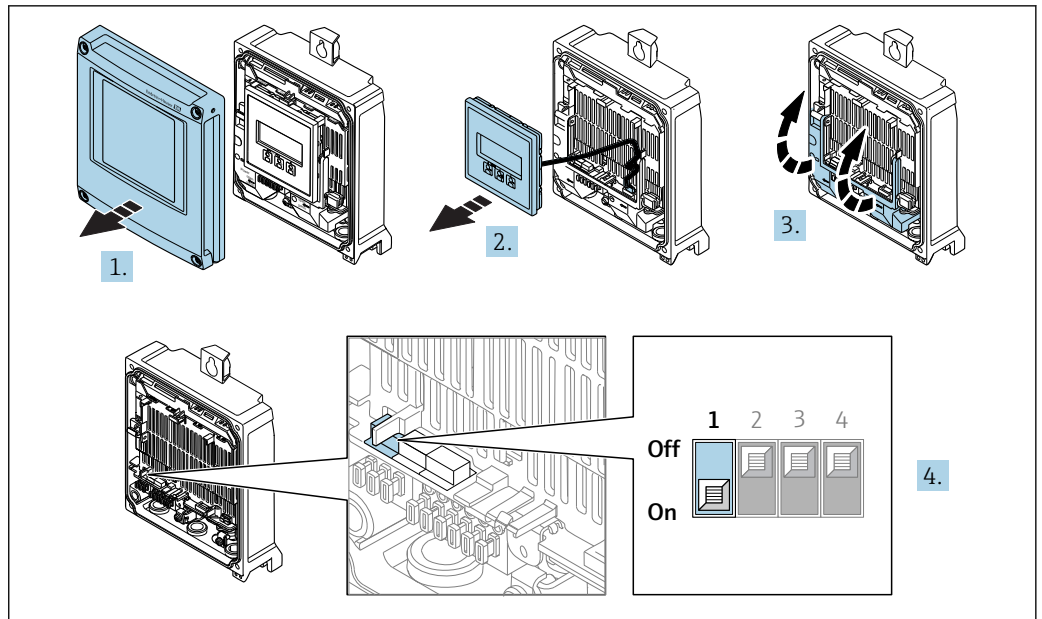

A0029673

1. Open the housing cover.
2. Remove the display module.
3. Fold open the terminal cover.
4. Setting the write protection (WP) switch on the main electronics module to the **ON** position enables hardware write protection.
 - ↳ In the **Locking status** parameter the **Hardware locked** option is displayed → 181. In addition, on the local display the -symbol appears in front of the parameters in the header of the operational display and in the navigation view.

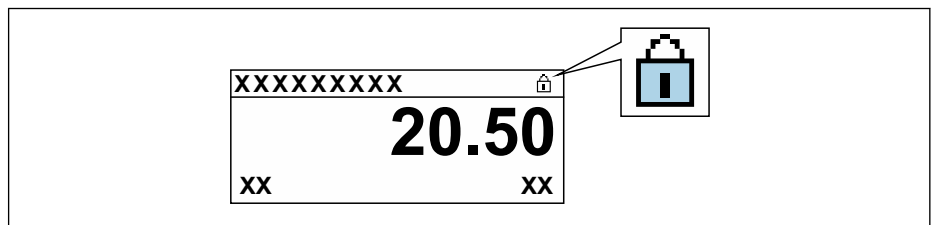

A0029425

5. Setting the write protection (WP) switch on the main electronics module to the **OFF** position (factory setting) disables hardware write protection.
 - ↳ No option is displayed in the **Locking status** parameter → 181. On the local display, the -symbol disappears from in front of the parameters in the header of the operational display and in the navigation view.

Proline 500

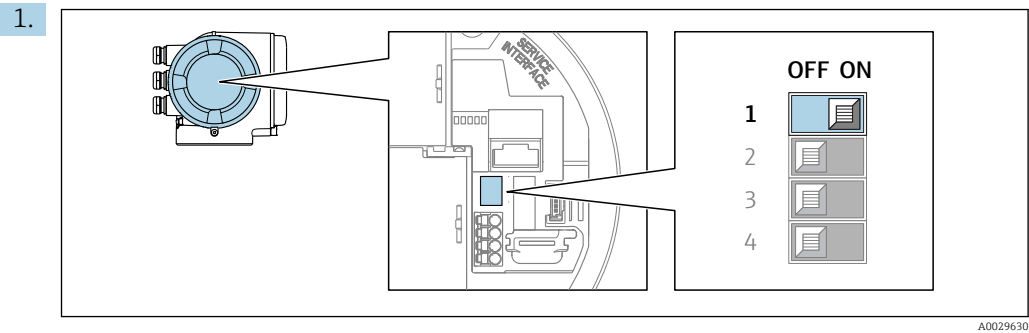

Setting the write protection (WP) switch on the main electronics module to the **ON** position enables hardware write protection.

- ↳ In the **Locking status** parameter the **Hardware locked** option is displayed → 181. In addition, on the local display the -symbol appears in front of the parameters in the header of the operational display and in the navigation view.

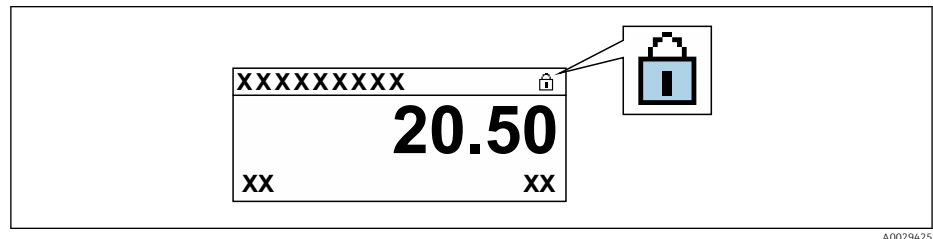

2. Setting the write protection (WP) switch on the main electronics module to the **OFF** position (factory setting) disables hardware write protection.

- ↳ No option is displayed in the **Locking status** parameter → 181. On the local display, the -symbol disappears from in front of the parameters in the header of the operational display and in the navigation view.

11 Operation

11.1 Reading the device locking status

Device active write protection: **Locking status** parameter

Operation → Locking status

Function scope of the "Locking status" parameter

Options	Description
None	The access status displayed in the Access status parameter applies → 81. Only appears on local display.
Hardware locked	The DIP switch for hardware locking is activated on the PCB board. This locks write access to the parameters (e.g. via local display or operating tool) .
Temporarily locked	Write access to the parameters is temporarily locked on account of internal processes running in the device (e.g. data upload/download, reset etc.). Once the internal processing has been completed, the parameters can be changed once again.

11.2 Adjusting the operating language

 Detailed information:

- To configure the operating language → 113
- For information on the operating languages supported by the measuring device → 255

11.3 Configuring the display

Detailed information:

- On the basic settings for the local display → 141
- On the advanced settings for the local display → 159

11.4 Reading measured values

With the **Measured values** submenu, it is possible to read all the measured values.

Navigation

"Diagnostics" menu → Measured values

▶ Measured values	
▶ Measured variables	→ 182
▶ Input values	→ 184
▶ Output values	→ 185
▶ Totalizer	→ 183

11.4.1 "Measured variables" submenu

The **Measured variables** submenu contains all the parameters needed to display the current measured values for each process variable.



Navigation

"Diagnostics" menu → Measured values → Measured variables

► Measured variables	
Mass flow	→ ⓘ 182
Volume flow	→ ⓘ 182
Corrected volume flow	→ ⓘ 182
Density	→ ⓘ 182
Reference density	→ ⓘ 183
Temperature	→ ⓘ 183
Pressure value	→ ⓘ 183
Concentration	→ ⓘ 183
Target mass flow	→ ⓘ 183
Carrier mass flow	→ ⓘ 183

Parameter overview with brief description

Parameter	Prerequisite	Description	User interface
Mass flow	-	Displays the mass flow currently measured. <i>Dependency</i> The unit is taken from the Mass flow unit parameter (→ ⓘ 116).	Signed floating-point number
Volume flow	-	Displays the volume flow currently calculated. <i>Dependency</i> The unit is taken from the Volume flow unit parameter (→ ⓘ 116).	Signed floating-point number
Corrected volume flow	-	Displays the corrected volume flow currently calculated. <i>Dependency</i> The unit is taken from the Corrected volume flow unit parameter (→ ⓘ 116).	Signed floating-point number
Density	-	Shows the density currently measured. <i>Dependency</i> The unit is taken from the Density unit parameter (→ ⓘ 116).	Signed floating-point number

Parameter	Prerequisite	Description	User interface
Reference density	–	Displays the reference density currently calculated. <i>Dependency</i> The unit is taken from the Reference density unit parameter (→ 117).	Signed floating-point number
Temperature	–	Shows the medium temperature currently measured. <i>Dependency</i> The unit is taken from the Temperature unit parameter (→ 117).	Signed floating-point number
Pressure value	–	Displays either a fixed or external pressure value. <i>Dependency</i> The unit is taken from the Pressure unit parameter (→ 117).	Signed floating-point number
Concentration	For the following order code: "Application package", option ED "Concentration"  The software options currently enabled are displayed in the Software option overview parameter.	Displays the concentration currently calculated. <i>Dependency</i> The unit is taken from the Concentration unit parameter.	Signed floating-point number
Target mass flow	With the following conditions: <ul style="list-style-type: none"> Order code for "Application package", option ED "Concentration" The WT-% option or the User conc. option is selected in the Concentration unit parameter.  The software options currently enabled are displayed in the Software option overview parameter.	Displays the target fluid mass flow currently measured. <i>Dependency</i> The unit is taken from the Mass flow unit parameter (→ 116).	Signed floating-point number
Carrier mass flow	With the following conditions: <ul style="list-style-type: none"> Order code for "Application package", option ED "Concentration" The WT-% option or the User conc. option is selected in the Concentration unit parameter.  The software options currently enabled are displayed in the Software option overview parameter.	Displays the carrier fluid mass flow currently measured. <i>Dependency</i> The unit is taken from the Mass flow unit parameter (→ 116).	Signed floating-point number

11.4.2 "Totalizer" submenu

The **Totalizer** submenu contains all the parameters needed to display the current measured values for every totalizer.

Navigation

"Diagnostics" menu → Measured values → Totalizer

► **Totalizer**



Totalizer value 1 to n

→ 184

Totalizer overflow 1 to n

→ 184

Parameter overview with brief description



Parameter	Prerequisite	Description	User interface
Totalizer value 1 to n	A process variable is selected in the Assign process variable parameter (→  158) of the Totalizer 1 to n submenu.	Displays the current totalizer counter value.	Signed floating-point number
Totalizer overflow 1 to n	A process variable is selected in the Assign process variable parameter (→  158) of the Totalizer 1 to n submenu.	Displays the current totalizer overflow.	Integer with sign

11.4.3 "Input values" submenu

The **Input values** submenu guides you systematically to the individual input values.

Navigation

"Diagnostics" menu → Measured values → Input values



▶ Input values	
▶ Current input 1 to n	→  184
▶ Status input 1 to n	→  184

Input values of current input

The **Current input 1 to n** submenu contains all the parameters needed to display the current measured values for every current input.

Navigation

"Diagnostics" menu → Measured values → Input values → Current input 1 to n

▶ Current input 1 to n	
Measured values 1 to n	→  184
Measured current 1 to n	→  184

Parameter overview with brief description

Parameter	Description	User interface
Measured values 1 to n	Displays the current input value.	Signed floating-point number
Measured current 1 to n	Displays the current value of the current input.	0 to 22.5 mA

Input values of status input

The **Status input 1 to n** submenu contains all the parameters needed to display the current measured values for every status input.

Navigation

"Diagnostics" menu → Measured values → Input values → Status input 1 to n

▶ Status input 1 to n

Value status input

→ ⓘ 185

Parameter overview with brief description

Parameter	Description	User interface
Value status input	Shows the current input signal level.	<ul style="list-style-type: none"> ■ High ■ Low

11.4.4 Output values

The **Output values** submenu contains all the parameters needed to display the current measured values for every output.

Navigation

"Diagnostics" menu → Measured values → Output values

▶ Output values

▶ Current output 1 to n

→ ⓘ 185

▶ Pulse/frequency/switch output 1 to n

→ ⓘ 186

▶ Relay output 1 to n

→ ⓘ 186

Output values of current output

The **Value current output** submenu contains all the parameters needed to display the current measured values for every current output.

Navigation

"Diagnostics" menu → Measured values → Output values → Value current output 1 to n

▶ Current output 1 to n

Output current 1 to n

→ ⓘ 186

Measured current 1 to n

→ ⓘ 186

Parameter overview with brief description

Parameter	Description	User interface
Output current 1	Displays the current value currently calculated for the current output.	3.59 to 22.5 mA
Measured current	Displays the current value currently measured for the current output.	0 to 30 mA

Output values for pulse/frequency/switch output

The **Pulse/frequency/switch output 1 to n** submenu contains all the parameters needed to display the current measured values for every pulse/frequency/switch output.

Navigation

"Diagnostics" menu → Measured values → Output values → Pulse/frequency/switch output 1 to n

▶ **Pulse/frequency/switch output 1 to n**

Output frequency 1 to n

 → 186

Pulse output 1 to n

 → 186

Switch status 1 to n

 → 186

Parameter overview with brief description

Parameter	Prerequisite	Description	User interface
Output frequency 1 to n	In the Operating mode parameter, the Frequency option is selected.	Displays the value currently measured for the frequency output.	0.0 to 12 500.0 Hz
Pulse output 1 to n	In the Operating mode parameter, the Pulse option is selected.	Displays the pulse frequency currently output.	Positive floating-point number
Switch status 1 to n	The Switch option is selected in the Operating mode parameter.	Displays the current switch output status.	<ul style="list-style-type: none"> ■ Open ■ Closed

Output values for relay output

The **Relay output 1 to n** submenu contains all the parameters needed to display the current measured values for every relay output.

Navigation

"Diagnostics" menu → Measured values → Output values → Relay output 1 to n

▶ **Relay output 1 to n**

Switch status

 → 187

Switch cycles

 → 187

Max. switch cycles number



 → 187

Parameter overview with brief description

Parameter	Description	User interface
Switch status	Shows the current relay switch status.	<ul style="list-style-type: none"> ▪ Open ▪ Closed
Switch cycles	Shows number of all performed switch cycles.	Positive integer
Max. switch cycles number	Shows the maximal number of guaranteed switch cycles.	Positive integer

11.5 Adapting the measuring device to the process conditions



The following are available for this purpose:

- Basic settings using the **Setup** menu (→  114)
- Advanced settings using the **Advanced setup** submenu (→  154)

11.6 Performing a totalizer reset

Navigation

"Operation" menu → Totalizer handling

▶ Totalizer handling	
Control Totalizer 1 to n	→  188
Preset value 1 to n	→  188
Reset all totalizers	→  188

Parameter overview with brief description

Parameter	Prerequisite	Description	Selection / User entry	Factory setting
Control Totalizer 1 to n	One of the following options is selected in the Assign process variable parameter (→ 158) of the Totalizer 1 to n submenu: <ul style="list-style-type: none"> ▪ Volume flow ▪ Mass flow ▪ Corrected volume flow ▪ Target mass flow * ▪ Carrier mass flow * 	Control totalizer value.	<ul style="list-style-type: none"> ▪ Totalize ▪ Reset + hold ▪ Preset + hold ▪ Reset + totalize ▪ Preset + totalize ▪ Hold 	Totalize
Preset value 1 to n	One of the following options is selected in the Assign process variable parameter (→ 158) of the Totalizer 1 to n submenu: <ul style="list-style-type: none"> ▪ Volume flow ▪ Mass flow ▪ Corrected volume flow ▪ Target mass flow * ▪ Carrier mass flow * 	Specify start value for totalizer. <i>Dependency</i>  The unit of the selected process variable is specified for the totalizer in the Unit totalizer parameter (→ 158).	Signed floating-point number	Country-specific: <ul style="list-style-type: none"> ▪ 0 kg ▪ 0 lb
Reset all totalizers	–	Reset all totalizers to 0 and start.	<ul style="list-style-type: none"> ▪ Cancel ▪ Reset + totalize 	Cancel

* Visibility depends on order options or device settings

11.6.1 Function scope of the "Control Totalizer" parameter

Options	Description
Totalize	The totalizer is started or continues running.
Reset + hold	The totaling process is stopped and the totalizer is reset to 0.
Preset + hold	The totaling process is stopped and the totalizer is set to its defined start value from the Preset value parameter.
Reset + totalize	The totalizer is reset to 0 and the totaling process is restarted.
Preset + totalize	The totalizer is set to the defined start value from the Preset value parameter and the totaling process is restarted.
Hold	Totalizing is stopped.

11.6.2 Function scope of the "Reset all totalizers" parameter

Options	Description
Cancel	No action is executed and the user exits the parameter.
Reset + totalize	Resets all totalizers to 0 and restarts the totaling process. This deletes all the flow values previously totaled.

11.7 Showing data logging

The **Extended HistoROM** application package must be enabled in the device (order option) for the **Data logging** submenu to appear. This contains all the parameters for the measured value history.

-  Data logging is also available via:
- Plant Asset Management Tool FieldCare → 94.
 - Web browser

Function range

- A total of 1000 measured values can be stored
- 4 logging channels
- Adjustable logging interval for data logging
- Display of the measured value trend for each logging channel in the form of a chart

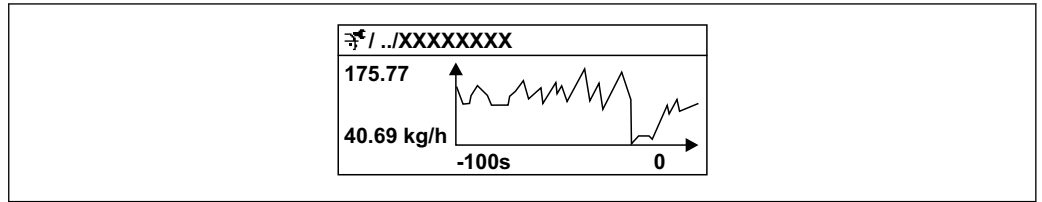

A0016357

36 Chart of a measured value trend

- x-axis: depending on the number of channels selected displays 250 to 1000 measured values of a process variable.
- y-axis: displays the approximate measured value span and constantly adapts this to the ongoing measurement.

i If the length of the logging interval or the assignment of the process variables to the channels is changed, the content of the data logging is deleted.

Navigation

"Diagnostics" menu → Data logging





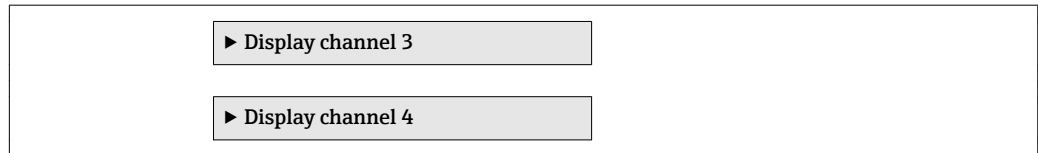

▶ **Data logging**

Assign channel 1	→ 191
Assign channel 2	→ 192
Assign channel 3	→ 192
Assign channel 4	→ 192
Logging interval	→ 192
Clear logging data	→ 192
Data logging	→ 192
Logging delay	→ 192
Data logging control	→ 192
Data logging status	→ 193
Entire logging duration	→ 193
▶ Display channel 1	
▶ Display channel 2	



Parameter overview with brief description

Parameter	Prerequisite	Description	Selection / User entry / User interface	Factory setting
Assign channel 1	<p>The Extended HistoROM application package is available.</p> <p> The software options currently enabled are displayed in the Software option overview parameter.</p>	Assign a process variable to logging channel.	<ul style="list-style-type: none"> ▪ Off ▪ Mass flow ▪ Volume flow ▪ Corrected volume flow ▪ Target mass flow * ▪ Carrier mass flow * ▪ Target volume flow ▪ Carrier volume flow ▪ Target corrected volume flow ▪ Carrier corrected volume flow ▪ Density ▪ Reference density ▪ Reference density alternative ▪ GSV flow ▪ GSV flow alternative ▪ NSV flow ▪ NSV flow alternative ▪ S&W volume flow ▪ Water cut ▪ Oil density ▪ Water density ▪ Oil mass flow ▪ Water mass flow ▪ Oil volume flow ▪ Water volume flow ▪ Oil corrected volume flow ▪ Water corrected volume flow ▪ Concentration * ▪ Dynamic viscosity ▪ Kinematic viscosity ▪ Temp. compensated dynamic viscosity ▪ Temp. compensated kinematic viscosity ▪ Temperature ▪ Carrier pipe temperature * ▪ Electronic temperature ▪ Oscillation frequency 0 ▪ Oscillation frequency 1 ▪ Oscillation amplitude * ▪ Oscillation amplitude 1 ▪ Frequency fluctuation 0 ▪ Frequency fluctuation 1 ▪ Oscillation damping 0 	Off

Parameter	Prerequisite	Description	Selection / User entry / User interface	Factory setting
			<ul style="list-style-type: none"> ▪ Oscillation damping 1 ▪ Oscillation damping fluctuation 0 ▪ Oscillation damping fluctuation 1 ▪ Signal asymmetry ▪ Exciter current 0 ▪ Exciter current 1 ▪ HBSI ▪ Current output 1 ▪ Current output 2 * ▪ Current output 3 * ▪ Current output 4 * ▪ Pressure 	
Assign channel 2	<p>The Extended HistorOM application package is available.</p> <p> The software options currently enabled are displayed in the Software option overview parameter.</p>	Assign process variable to logging channel.	Picklist, see Assign channel 1 parameter (→  191)	Off
Assign channel 3	<p>The Extended HistorOM application package is available.</p> <p> The software options currently enabled are displayed in the Software option overview parameter.</p>	Assign process variable to logging channel.	Picklist, see Assign channel 1 parameter (→  191)	Off
Assign channel 4	<p>The Extended HistorOM application package is available.</p> <p> The software options currently enabled are displayed in the Software option overview parameter.</p>	Assign process variable to logging channel.	Picklist, see Assign channel 1 parameter (→  191)	Off
Logging interval	<p>The Extended HistorOM application package is available.</p>	Define the logging interval for data logging. This value defines the time interval between the individual data points in the memory.	0.1 to 3 600.0 s	1.0 s
Clear logging data	<p>The Extended HistorOM application package is available.</p>	Clear the entire logging data.	<ul style="list-style-type: none"> ▪ Cancel ▪ Clear data 	Cancel
Data logging	–	Select the data logging method.	<ul style="list-style-type: none"> ▪ Overwriting ▪ Not overwriting 	Overwriting
Logging delay	In the Data logging parameter, the Not overwriting option is selected.	Enter the time delay for measured value logging.	0 to 999 h	0 h
Data logging control	In the Data logging parameter, the Not overwriting option is selected.	Start and stop measured value logging.	<ul style="list-style-type: none"> ▪ None ▪ Delete + start ▪ Stop 	None

Parameter	Prerequisite	Description	Selection / User entry / User interface	Factory setting
Data logging status	In the Data logging parameter, the Not overwriting option is selected.	Displays the measured value logging status.	<ul style="list-style-type: none"> ■ Done ■ Delay active ■ Active ■ Stopped 	Done
Entire logging duration	In the Data logging parameter, the Not overwriting option is selected.	Displays the total logging duration.	Positive floating-point number	0 s

* Visibility depends on order options or device settings

12 Diagnostics and troubleshooting

12.1 General troubleshooting

For local display

Error	Possible causes	Solution
Local display dark and no output signals	Supply voltage does not match the value indicated on the nameplate.	Apply the correct supply voltage .
Local display dark and no output signals	The polarity of the supply voltage is wrong.	Correct the polarity.
Local display dark and no output signals	No contact between connecting cables and terminals.	Check the connection of the cables and correct if necessary.
Local display dark and no output signals	Terminals are not plugged into the I/O electronics module correctly. Terminals are not plugged into the main electronics module correctly.	Check terminals.
Local display dark and no output signals	I/O electronics module is defective. Main electronics module is defective.	Order spare part → ☰ 227.
Local display dark and no output signals	The connector between the main electronics module and display module is not plugged in correctly.	Check the connection and correct if necessary.
Local display dark and no output signals	The connecting cable is not plugged in correctly.	1. Check the connection of the electrode cable and correct if necessary. 2. Check the connection of the coil current cable and correct if necessary.
Local display is dark, but signal output is within the valid range	Display is set too bright or too dark.	<ul style="list-style-type: none"> ▪ Set the display brighter by simultaneously pressing ☐ + ☐. ▪ Set the display darker by simultaneously pressing ☐ + ☐.
Local display is dark, but signal output is within the valid range	The cable of the display module is not plugged in correctly.	Insert the plug correctly into the main electronics module and display module.
Local display is dark, but signal output is within the valid range	Display module is defective.	Order spare part → ☰ 227.
Backlighting of local display is red	Diagnostic event with "Alarm" diagnostic behavior has occurred.	Take remedial measures
Text on local display appears in a foreign language and cannot be understood.	Incorrect operating language is configured.	1. Press ☐ + ☐ for 2 s ("home position"). 2. Press ☐. 3. Set the desired language in the Display language parameter (→ ☰ 168).
Message on local display: "Communication Error" "Check Electronics"	Communication between the display module and the electronics is interrupted.	<ul style="list-style-type: none"> ▪ Check the cable and the connector between the main electronics module and display module. ▪ Order spare part → ☰ 227.

For output signals

Error	Possible causes	Solution
Signal output outside the valid range	Main electronics module is defective.	Order spare part → 227.
Device shows correct value on local display, but signal output is incorrect, though in the valid range.	Configuration error	Check and correct the parameter configuration.
Device measures incorrectly.	Configuration error or device is operated outside the application.	1. Check and correct parameter configuration. 2. Observe limit values specified in the "Technical Data".

For access

Error	Possible causes	Solution
No write access to parameters	Hardware write protection enabled	Set the write protection switch on main electronics module to the OFF position → 178.
No write access to parameters	Current user role has limited access authorization	1. Check user role → 81. 2. Enter correct customer-specific access code → 81.
No connection via EtherNet/IP	Device plug connected incorrectly	Check the pin assignment of the connector .
Not connecting to Web server	Web server disabled	Using the "FieldCare" or "DeviceCare" operating tool, check whether the Web server of the measuring device is enabled, and enable it if necessary → 89.
	Incorrect setting for the Ethernet interface of the computer	1. Check the properties of the Internet protocol (TCP/IP) → 85. 2. Check the network settings with the IT manager.
Not connecting to Web server	<ul style="list-style-type: none"> ▪ Incorrect IP address ▪ IP address is not known 	1. If addressing via hardware: open the transmitter and check the IP address configured (last octet). 2. Check the IP address of the measuring device with the network manager. 3. If the IP address is not known, set DIP switch no. 10 to ON, restart the device and enter the factory IP address 192.168.1.212.  EtherNet/IP communication is interrupted by enabling the DIP switch.
	Web browser setting "Use a Proxy Server for Your LAN" is enabled	Disable the use of the proxy server in the Web browser settings of the computer. Using the example of MS Internet Explorer: 1. Under <i>Control Panel</i> open <i>Internet options</i> . 2. Select the <i>Connections</i> tab and then double-click <i>LAN settings</i> . 3. In the <i>LAN settings</i> disable the use of the proxy server and select <i>OK</i> to confirm.

Error	Possible causes	Solution
	Apart from the active network connection to the measuring device, other network connections are also being used.	<ul style="list-style-type: none"> ▪ Make sure that no other network connections are established by the computer (also no WLAN) and close other programs with network access to the computer. ▪ If using a docking station for notebooks, make sure that a network connection to another network is not active.
Not connecting to Web server	Incorrect WLAN access data	<ul style="list-style-type: none"> ▪ Check WLAN network status. ▪ Log on to the device again using WLAN access data. ▪ Verify that WLAN is enabled on the measuring device and operating device .
	WLAN communication disabled	–
Not connecting to Web server, FieldCare or DeviceCare	No WLAN network available	<ul style="list-style-type: none"> ▪ Check if WLAN reception is present: LED on display module is lit blue ▪ Check if WLAN connection is enabled: LED on display module flashes blue ▪ Switch on instrument function.
Network connection not present or unstable	WLAN network is weak.	<ul style="list-style-type: none"> ▪ Operating device is outside of reception range: Check network status on operating device. ▪ To improve network performance, use an external WLAN antenna.
	Parallel WLAN and Ethernet communication	<ul style="list-style-type: none"> ▪ Check network settings. ▪ Temporarily enable only the WLAN as an interface.
Web browser frozen and operation no longer possible	Data transfer active	Wait until data transfer or current action is finished.
	Connection lost	<ol style="list-style-type: none"> 1. Check cable connection and power supply. 2. Refresh the Web browser and restart if necessary.
Content of Web browser incomplete or difficult to read	Not using optimum version of Web server.	<ol style="list-style-type: none"> 1. Use the correct Web browser version . 2. Clear the Web browser cache and restart the Web browser.
	Unsuitable view settings.	Change the font size/display ratio of the Web browser.
No or incomplete display of contents in the Web browser	<ul style="list-style-type: none"> ▪ JavaScript not enabled ▪ JavaScript cannot be enabled 	<ol style="list-style-type: none"> 1. Enable JavaScript. 2. Enter http://XXX.XXX.X.XXX/basic.html as the IP address.
Operation with FieldCare or DeviceCare via CDI-RJ45 service interface (port 8000)	Firewall of computer or network is preventing communication	Depending on the settings of the firewall used on the computer or in the network, the firewall must be adapted or disabled to allow FieldCare/DeviceCare access.
Flashing of firmware with FieldCare or DeviceCare via CDI-RJ45 service interface (via port 8000 or TFTP ports)	Firewall of computer or network is preventing communication	Depending on the settings of the firewall used on the computer or in the network, the firewall must be adapted or disabled to allow FieldCare/DeviceCare access.

12.2 Diagnostic information via light emitting diodes

12.2.1 Transmitter

Proline 500 – digital

Different LEDs in the transmitter provide information on the device status.

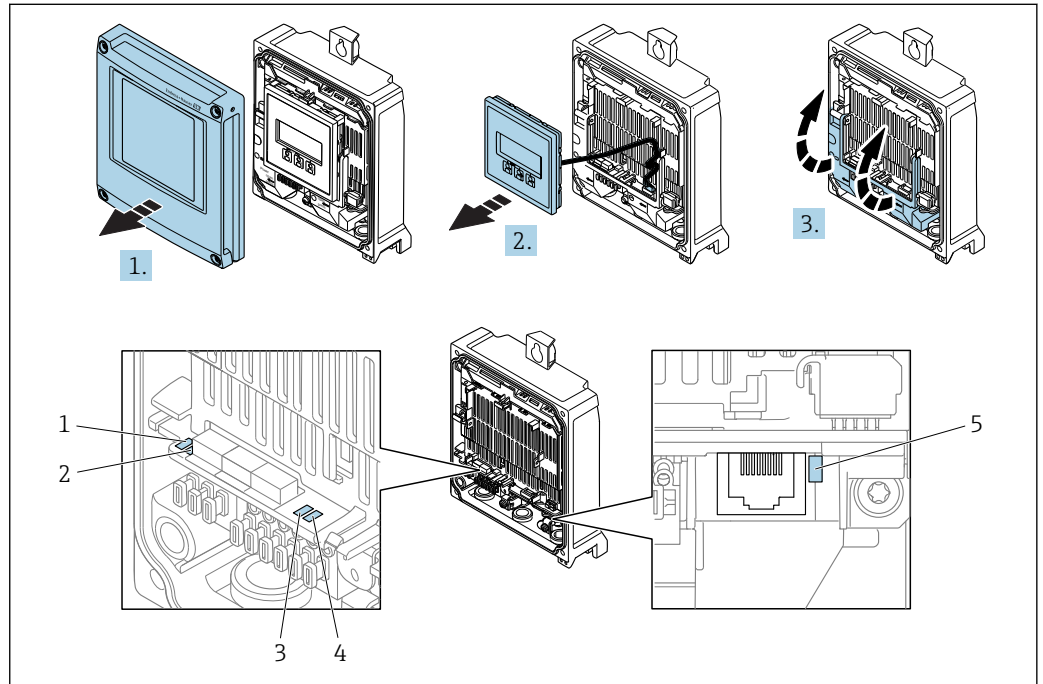

A0029689

- 1 Supply voltage
- 2 Device status
- 3 network status
- 4 Port 1 active: EtherNet/IP
- 5 Port 2 active: EtherNet/IP and service interface (CDI)

1. Open the housing cover.
2. Remove the display module.
3. Fold open the terminal cover.

LED	Color	Meaning
1 Supply voltage	Off	Supply voltage is off or too low.
	Green	Supply voltage is ok.
2 Device status/module status	Off	Firmware error
	Green	Device status is ok.
	Flashing green	Device is not configured.
	Flashing red	A diagnostic event with "Warning" diagnostic behavior has occurred.
	Red	A diagnostic event with "Alarm" diagnostic behavior has occurred.
3 Network status	Flashing red/green	The device restarts/self-test.
	Off	The device does not have an EtherNet/IP address.
	Green	EtherNet/IP connection is active.
	Flashing green	The device has an Ethernet/IP address but no EtherNet/IP connection is active.

LED	Color	Meaning
	Red	The EtherNet/IP address of the device has been assigned twice.
	Flashing red	EtherNet/IP connection is in the "time out" mode.
	Flashing red/green	The device restarts/self-test.
4 Port 1 active: Ethernet/IP	Off	Not connected or no connection established.
	White	Connected and connection established.
	Flashing white	Communication not active.
5 Port 2 active: Ethernet/IP and service interface (CDI)	Off	Not connected or no connection established.
	Yellow	Connected and connection established.
	Flashing yellow	Communication not active.

Proline 500

Different LEDs in the transmitter provide information on the device status.

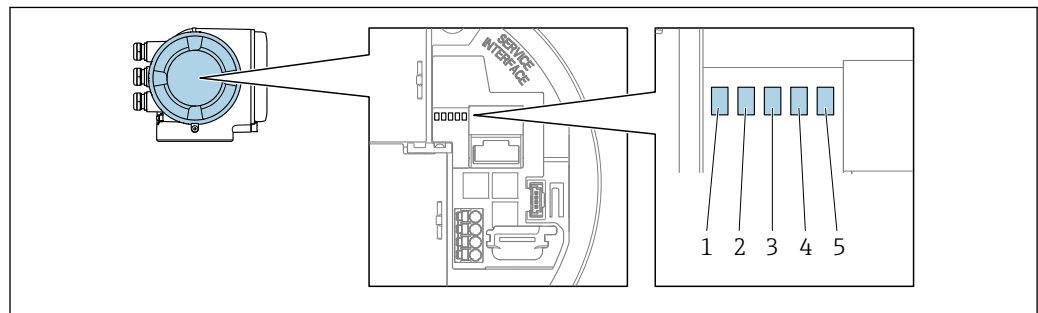

A0029629

- 1 Supply voltage
- 2 Device status
- 3 network status
- 4 Port 1 active: EtherNet/IP
- 5 Port 2 active: EtherNet/IP and service interface (CDI)

LED	Color	Meaning
1 Supply voltage	Off	Supply voltage is off or too low.
	Green	Supply voltage is ok.
2 Device status/module status	Off	Firmware error.
	Green	Device status is ok.
	Flashing green	Device is not configured.
	Flashing red	A diagnostic event with "Warning" diagnostic behavior has occurred.
	Red	A diagnostic event with "Alarm" diagnostic behavior has occurred.
	Flashing red/green	The device restarts/self-test.
3 Network status	Off	The device does not have an EtherNet/IP address.
	Green	EtherNet/IP connection is active.
	Flashing green	The device has an Ethernet/IP address but no EtherNet/IP connection is active.
	Red	The EtherNet/IP address of the device has been assigned twice.
	Flashing red	EtherNet/IP connection is in the "time out" mode.
	Flashing red/green	The device restarts/self-test.

LED	Color	Meaning
4 Port 1 active: Ethernet/IP	Off	Not connected or no connection established.
	White	Connected and connection established.
	Flashing white	Communication not active.
5 Port 2 active: Ethernet/IP and service interface (CDI)	Off	Not connected or no connection established.
	Yellow	Connected and connection established.
	Flashing yellow	Communication not active.

12.2.2 Sensor connection housing

Proline 500 – digital

Various light emitting diodes (LED) on the ISEM electronics (Intelligent Sensor Electronic Module) in the sensor connection housing provide information on the device status.

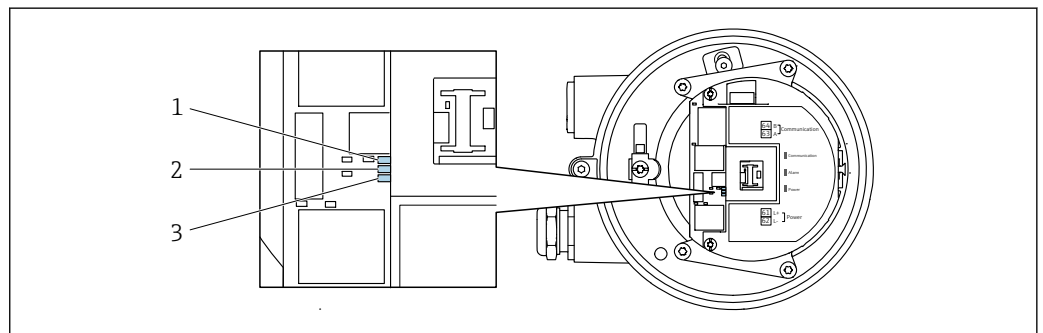

A0029699

- 1 Communication
- 2 Device status
- 3 Supply voltage

LED	Color	Meaning
1 Communication	White	Communication active
2 Device status	Red	Error
	Flashing red	Warning
3 Supply voltage	Green	Supply voltage is ok
	Off	Supply voltage is off or too low

12.3 Diagnostic information on local display

12.3.1 Diagnostic message

Faults detected by the self-monitoring system of the measuring device are displayed as a diagnostic message in alternation with the operational display.

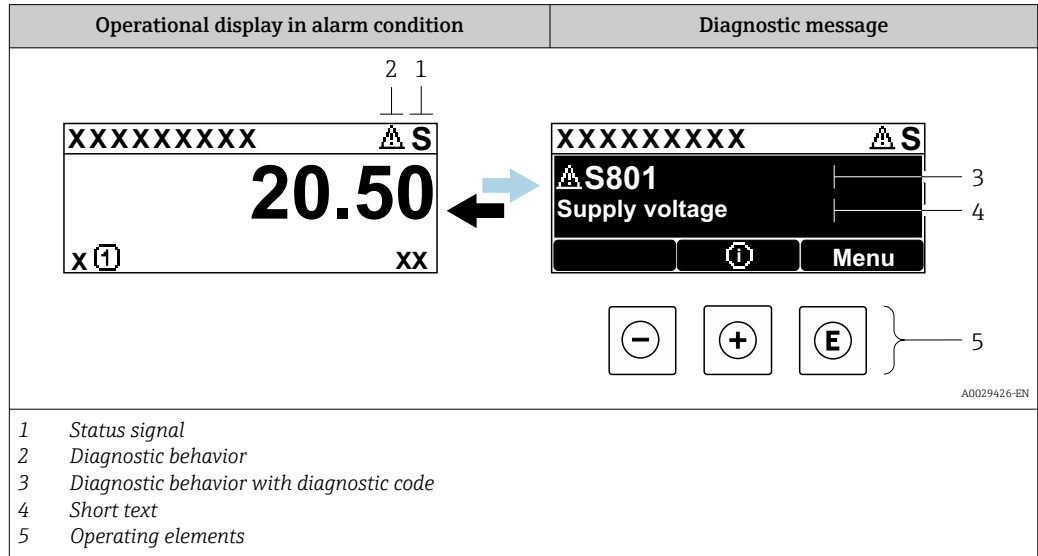

If two or more diagnostic events are pending simultaneously, only the message of the diagnostic event with the highest priority is shown.

- i** Other diagnostic events that have occurred can be displayed in the **Diagnostics** menu:
 - Via parameter
 - Via submenus → 220



Status signals

The status signals provide information on the state and reliability of the device by categorizing the cause of the diagnostic information (diagnostic event).

- i** The status signals are categorized according to VDI/VDE 2650 and NAMUR Recommendation NE 107: F = Failure, C = Function Check, S = Out of Specification, M = Maintenance Required

Symbol	Meaning
F	Failure A device error has occurred. The measured value is no longer valid.
C	Function check The device is in service mode (e.g. during a simulation).
S	Out of specification The device is operated: Outside its technical specification limits (e.g. outside the process temperature range)
M	Maintenance required Maintenance is required. The measured value remains valid.

Diagnostic behavior



Symbol	Meaning
	Alarm <ul style="list-style-type: none"> Measurement is interrupted. Signal outputs and totalizers assume the defined alarm condition. A diagnostic message is generated.
	Warning Measurement is resumed. The signal outputs and totalizers are not affected. A diagnostic message is generated.

Diagnostic information

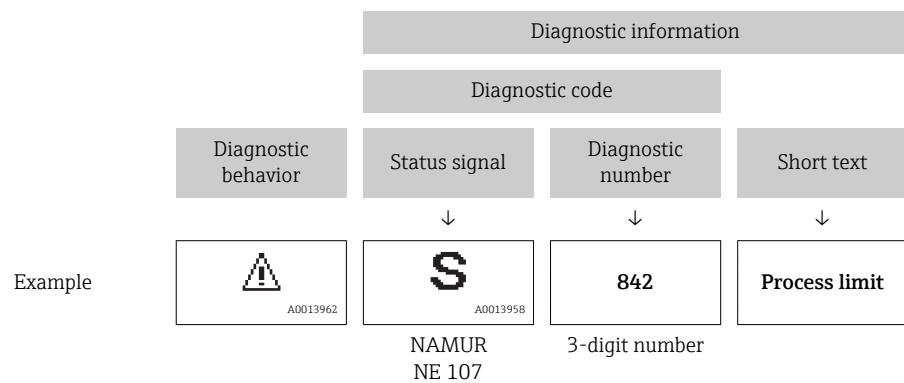
The fault can be identified using the diagnostic information. The short text helps you by providing information about the fault. In addition, the corresponding symbol for the diagnostic behavior is displayed in front of the diagnostic information on the local display.



Operating elements

Key	Meaning
	Plus key <i>In a menu, submenu</i> Opens the message about remedy information.
	Enter key <i>In a menu, submenu</i> Opens the operating menu.

12.3.2 Calling up remedial measures

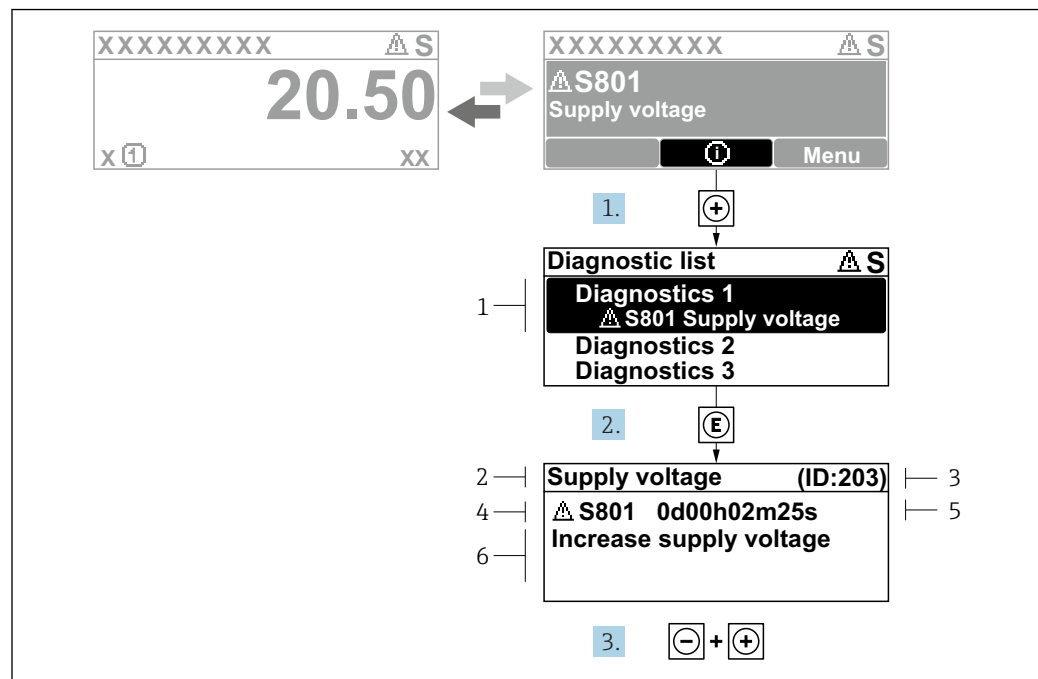

37 Message about remedial measures

- 1 Diagnostic information
- 2 Short text
- 3 Service ID
- 4 Diagnostic behavior with diagnostic code
- 5 Operation time of occurrence
- 6 Remedial measures

1. The user is in the diagnostic message.
Press \oplus (ⓘ symbol).
↳ The **Diagnostic list** submenu opens.
2. Select the desired diagnostic event with \oplus or \ominus and press \oplus .
↳ The message about the remedial measures opens.
3. Press $\ominus + \oplus$ simultaneously.
↳ The message about the remedial measures closes.

The user is in the **Diagnostics** menu at an entry for a diagnostics event, e.g. in the **Diagnostic list** submenu or **Previous diagnostics** parameter.

1. Press \oplus .
↳ The message for the remedial measures for the selected diagnostic event opens.
2. Press $\ominus + \oplus$ simultaneously.
↳ The message for the remedial measures closes.

12.4 Diagnostic information in the Web browser

12.4.1 Diagnostic options

Any faults detected by the measuring device are displayed in the Web browser on the home page once the user has logged on.

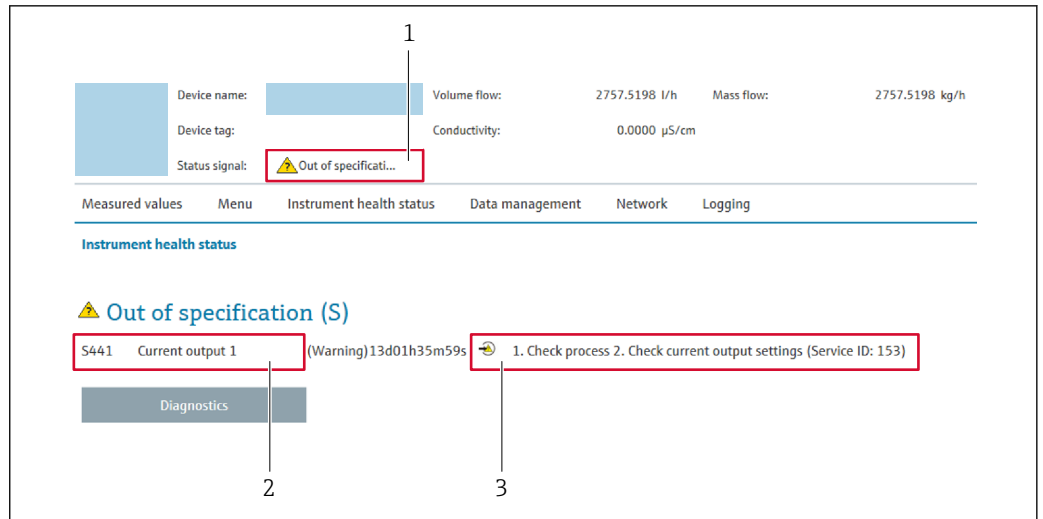

- 1 Status area with status signal
- 2 Diagnostic information → 201
- 3 Remedy information with Service ID

i In addition, diagnostic events which have occurred can be shown in the **Diagnostics** menu:

- Via parameter
- Via submenu → 220

Status signals

The status signals provide information on the state and reliability of the device by categorizing the cause of the diagnostic information (diagnostic event).

Symbol	Meaning
	Failure A device error has occurred. The measured value is no longer valid.
	Function check The device is in service mode (e.g. during a simulation).
	Out of specification The device is operated: Outside its technical specification limits (e.g. outside the process temperature range)
	Maintenance required Maintenance is required. The measured value is still valid.

i The status signals are categorized in accordance with VDI/VDE 2650 and NAMUR Recommendation NE 107.

12.4.2 Calling up remedy information

Remedy information is provided for every diagnostic event to ensure that problems can be rectified quickly. These measures are displayed in red along with the diagnostic event and the related diagnostic information.

12.5 Diagnostic information in DeviceCare or FieldCare

12.5.1 Diagnostic options

Any faults detected by the measuring device are displayed on the home page of the operating tool once the connection has been established.

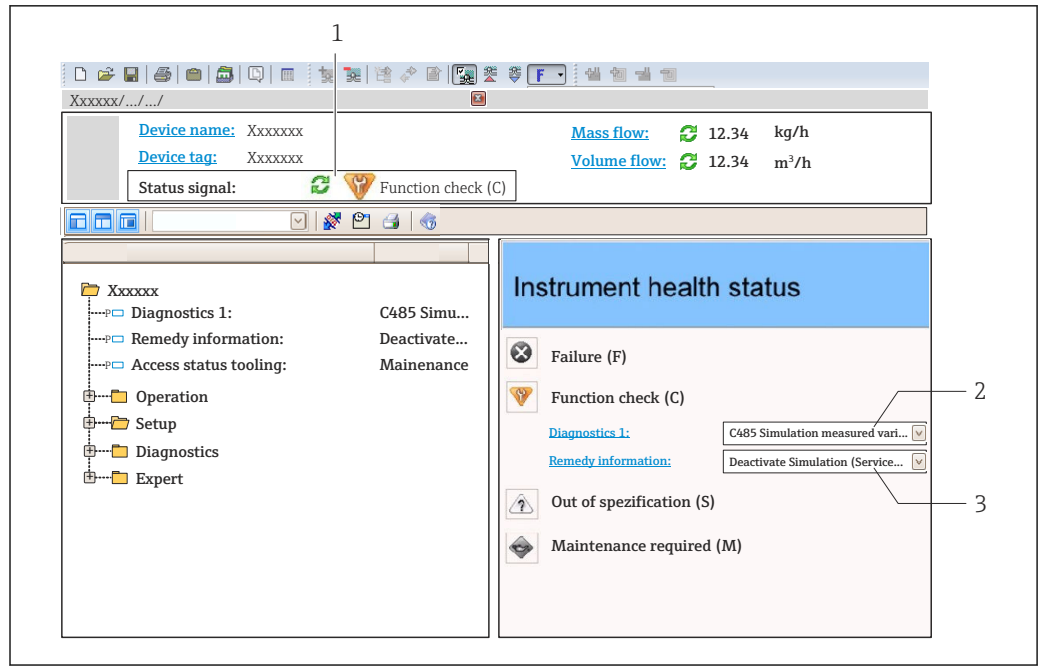

- 1 Status area with status signal → 200
- 2 Diagnostic information → 201
- 3 Remedy information with Service ID

i In addition, diagnostic events which have occurred can be shown in the **Diagnostics** menu:

- Via parameter
- Via submenu → 220

Diagnostic information

The fault can be identified using the diagnostic information. The short text helps you by providing information about the fault. In addition, the corresponding symbol for the diagnostic behavior is displayed in front of the diagnostic information on the local display.

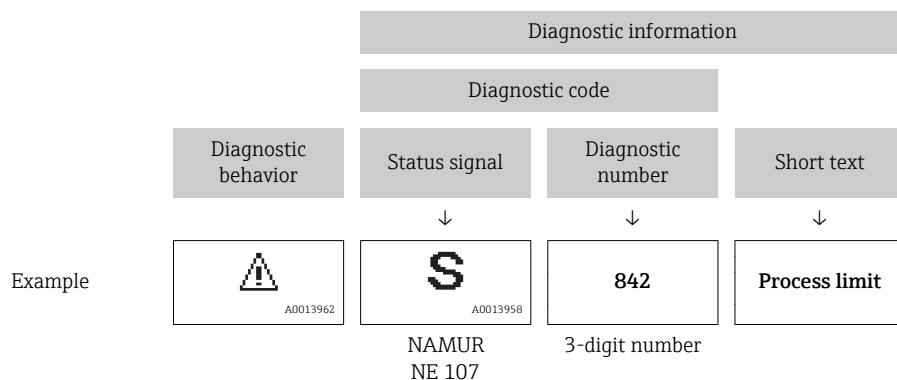

12.5.2 Calling up remedy information

Remedy information is provided for every diagnostic event to ensure that problems can be rectified quickly:

- On the home page
Remedy information is displayed in a separate field below the diagnostics information.
- In the **Diagnostics** menu
Remedy information can be called up in the working area of the user interface.

The user is in the **Diagnostics** menu.

1. Call up the desired parameter.
2. On the right in the working area, mouse over the parameter.
 - ↳ A tool tip with remedy information for the diagnostic event appears.

12.6 Diagnostic information via communication interface

12.6.1 Reading out diagnostic information

The current diagnostic event and associated diagnostic information can be read out via the input assembly (fix assembly):

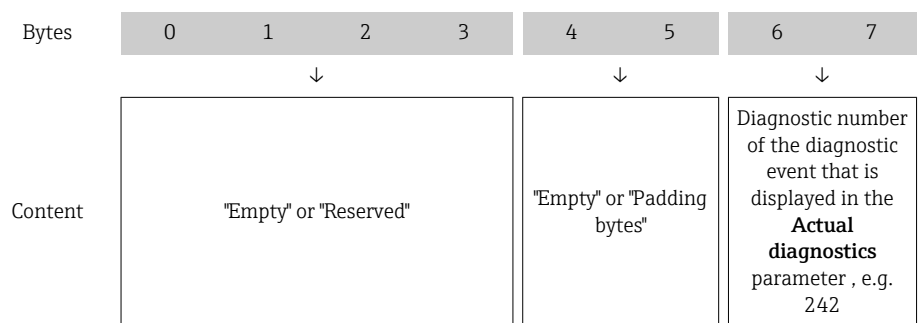

 For the content of bytes 8 to 16

12.7 Adapting the diagnostic information

12.7.1 Adapting the diagnostic behavior

Each item of diagnostic information is assigned a specific diagnostic behavior at the factory. The user can change this assignment for specific diagnostic information in the **Diagnostic behavior** submenu.



Expert → System → Diagnostic handling → Diagnostic behavior

You can assign the following options to the diagnostic number as the diagnostic behavior:

Options	Description
Alarm	The device stops measurement. The totalizers assume the defined alarm condition. A diagnostic message is generated. The background lighting changes to red.
Warning	The device continues to measure. The totalizers are not affected. A diagnostic message is generated.
Logbook entry only	The device continues to measure. The diagnostic message is displayed only in the Event logbook submenu (Event list submenu) and is not displayed in alternation with the operational display.
Off	The diagnostic event is ignored, and no diagnostic message is generated or entered.

12.8 Overview of diagnostic information

 The amount of diagnostic information and the number of measured variables affected increase if the measuring device has one or more application packages.

 In the case of some items of diagnostic information, the diagnostic behavior can be changed. Change the diagnostic information →  205

12.8.1 Diagnostic of sensor

Diagnostic information		Remedy instructions	Coding of diagnostic information (hex)	
No.	Short text			
022	Temperature sensor defective	1. Check or replace sensor electronic module (ISEM) 2. If available: Check connection cable between sensor and transmitter 3. Replace sensor	<ul style="list-style-type: none"> ■ 0x10000BE ■ 0x10000BF ■ 0x10000D5 ■ 0x10000D6 	
	Status signal			F
	Diagnostic behavior			Alarm

Diagnostic information		Remedy instructions	Coding of diagnostic information (hex)	
No.	Short text			
046	Sensor limit exceeded	1. Inspect sensor 2. Check process condition	<ul style="list-style-type: none"> ■ 0x80000C8 ■ 0x80000CA 	
	Status signal			S
	Diagnostic behavior [from the factory] ¹⁾			Alarm

1) Diagnostic behavior can be changed.

Diagnostic information		Remedy instructions	Coding of diagnostic information (hex)	
No.	Short text			
062	Sensor connection faulty	1. Check or replace sensor electronic module (ISEM) 2. If available: Check connection cable between sensor and transmitter 3. Replace sensor	<ul style="list-style-type: none"> ■ 0x10000DB ■ 0x10000DC ■ 0x1000113 ■ 0x1000114 	
	Status signal			F
	Diagnostic behavior			Alarm

Diagnostic information		Remedy instructions	Coding of diagnostic information (hex)	
No.	Short text			
063	Exciter current faulty	1. Check or replace sensor electronic module (ISEM) 2. If available: Check connection cable between sensor and transmitter 3. Replace sensor	0x80002B3	
	Status signal			S
	Diagnostic behavior			Alarm

Diagnostic information		Remedy instructions	Coding of diagnostic information (hex)	
No.	Short text			
082	Data storage	1. Check module connections 2. Contact service	0x10000E7	
	Status signal			F
	Diagnostic behavior			Alarm

Diagnostic information		Remedy instructions	Coding of diagnostic information (hex)	
No.	Short text			
083	Memory content	1. Restart device 2. Restore HistoROM S-DAT backup ('Device reset' parameter) 3. Replace HistoROM S-DAT	0x1000A0	
	Status signal			F
	Diagnostic behavior			Alarm

Diagnostic information		Remedy instructions	Coding of diagnostic information (hex)	
No.	Short text			
140	Sensor signal asymmetrical	1. Check or replace sensor electronic module (ISEM) 2. If available: Check connection cable between sensor and transmitter 3. Replace sensor	0x8000CC	
	Status signal			S
	Diagnostic behavior [from the factory] ¹⁾			Alarm

1) Diagnostic behavior can be changed.

Diagnostic information		Remedy instructions	Coding of diagnostic information (hex)	
No.	Short text			
144	Measuring error too high	1. Check or change sensor 2. Check process conditions	0x10001C7	
	Status signal			F
	Diagnostic behavior [from the factory] ¹⁾			Alarm

1) Diagnostic behavior can be changed.

12.8.2 Diagnostic of electronic

Diagnostic information		Remedy instructions	Coding of diagnostic information (hex)	
No.	Short text			
201	Device failure	1. Restart device 2. Contact service	0x100014B	
	Status signal			F
	Diagnostic behavior			Alarm

Diagnostic information		Remedy instructions	Coding of diagnostic information (hex)	
No.	Short text			
242	Software incompatible	1. Check software 2. Flash or change main electronics module	0x1000067	
	Status signal			F
	Diagnostic behavior			Alarm

Diagnostic information		Remedy instructions	Coding of diagnostic information (hex)	
No.	Short text			
252	Modules incompatible	1. Check electronic modules 2. Change electronic modules	0x100006B	
	Status signal			F
	Diagnostic behavior			Alarm

Diagnostic information		Remedy instructions	Coding of diagnostic information (hex)	
No.	Short text			
252	Modules incompatible	1. Check if correct electronic modul is plugged 2. Replace electronic module	0x10002C0	
	Status signal			F
	Diagnostic behavior			Alarm

Diagnostic information		Remedy instructions	Coding of diagnostic information (hex)	
No.	Short text			
262	Sensor electronic connection faulty	1. Check or replace connection cable between sensor electronic module (ISEM) and main electronics 2. Check or replace ISEM or main electronics	0x1000149	
	Status signal			F
	Diagnostic behavior			Alarm

Diagnostic information		Remedy instructions	Coding of diagnostic information (hex)	
No.	Short text			
270	Main electronic failure	Change main electronic module	<ul style="list-style-type: none"> ■ 0x1000078 ■ 0x100007C ■ 0x1000080 ■ 0x100009F ■ 0x10002D7 	
	Status signal			F
	Diagnostic behavior			Alarm

Diagnostic information		Remedy instructions	Coding of diagnostic information (hex)	
No.	Short text			
271	Main electronic failure	1. Restart device 2. Change main electronic module	0x100007D	
	Status signal			F
	Diagnostic behavior			Alarm

Diagnostic information		Remedy instructions	Coding of diagnostic information (hex)	
No.	Short text			
272	Main electronic failure	1. Restart device 2. Contact service	0x1000079	
	Status signal			F
	Diagnostic behavior			Alarm

Diagnostic information		Remedy instructions	Coding of diagnostic information (hex)	
No.	Short text			
273	Main electronic failure	Change electronic	<ul style="list-style-type: none"> ■ 0x1000098 ■ 0x10000E5 	
	Status signal			F
	Diagnostic behavior			Alarm

Diagnostic information		Remedy instructions	Coding of diagnostic information (hex)	
No.	Short text			
275	I/O module 1 to n defective	Change I/O module	0x100007A	
	Status signal			F
	Diagnostic behavior			Alarm

Diagnostic information		Remedy instructions	Coding of diagnostic information (hex)	
No.	Short text			
276	I/O module 1 to n faulty	1. Restart device 2. Change I/O module	<ul style="list-style-type: none"> ■ 0x100007B ■ 0x1000081 	
	Status signal			F
	Diagnostic behavior			Alarm

Diagnostic information		Remedy instructions	Coding of diagnostic information (hex)	
No.	Short text			
283	Memory content	1. Reset device 2. Contact service	<ul style="list-style-type: none"> ■ 0x10000E1 ■ 0x100016F 	
	Status signal			F
	Diagnostic behavior			Alarm

Diagnostic information		Remedy instructions	Coding of diagnostic information (hex)	
No.	Short text			
302	Device verification active	Device verification active, please wait.	0x20001EE	
	Status signal			C
	Diagnostic behavior			Warning

Diagnostic information		Remedy instructions	Coding of diagnostic information (hex)	
No.	Short text			
311	Electronic failure	1. Do not reset device 2. Contact service	0x40000E2	
	Status signal			M
	Diagnostic behavior			Warning

Diagnostic information		Remedy instructions	Coding of diagnostic information (hex)	
No.	Short text			
332	Writing in HistoROM backup failed	Replace user interface board Ex d/XP: replace transmitter	0x10002C7	
	Status signal			F
	Diagnostic behavior			Alarm

Diagnostic information		Remedy instructions	Coding of diagnostic information (hex)	
No.	Short text			
361	I/O module 1 to n faulty	<ol style="list-style-type: none"> Restart device Check electronic modules Change I/O Modul or main electronics 	0x1000095	
	Status signal			F
	Diagnostic behavior			Alarm

Diagnostic information		Remedy instructions	Coding of diagnostic information (hex)	
No.	Short text			
372	Sensor electronic (ISEM) faulty	<ol style="list-style-type: none"> Restart device Check if failure recurs Replace sensor electronic module (ISEM) 	<ul style="list-style-type: none"> ▪ 0x10000A1 ▪ 0x10000C7 ▪ 0x10000C9 ▪ 0x10000D4 ▪ 0x10000DA ▪ 0x1000120 ▪ 0x10002CB ▪ 0x10002CC ▪ 0x10002CD ▪ 0x10002CE ▪ 0x10002CF ▪ 0x10002D0 	
	Status signal			F
	Diagnostic behavior			Alarm

Diagnostic information		Remedy instructions	Coding of diagnostic information (hex)	
No.	Short text			
373	Sensor electronic (ISEM) faulty	<ol style="list-style-type: none"> Transfer data or reset device Contact service 	0x10002D1	
	Status signal			F
	Diagnostic behavior			Alarm

Diagnostic information		Remedy instructions	Coding of diagnostic information (hex)	
No.	Short text			
374	Sensor electronic (ISEM) faulty	<ol style="list-style-type: none"> Restart device Check if failure recurs Replace sensor electronic module (ISEM) 	0x80000CE	
	Status signal			S
	Diagnostic behavior [from the factory] ¹⁾			Warning

1) Diagnostic behavior can be changed.

Diagnostic information		Remedy instructions	Coding of diagnostic information (hex)	
No.	Short text			
375	I/O- 1 to n communication failed	<ol style="list-style-type: none"> Restart device Check if failure recurs Replace module rack inclusive electronic modules 	0x1000107	
	Status signal			F
	Diagnostic behavior			Alarm

Diagnostic information		Remedy instructions	Coding of diagnostic information (hex)	
No.	Short text			
382	Data storage	1. Insert T-DAT 2. Replace T-DAT	0x100016D	
	Status signal			F
	Diagnostic behavior			Alarm

Diagnostic information		Remedy instructions	Coding of diagnostic information (hex)	
No.	Short text			
383	Memory content	1. Restart device 2. Delete T-DAT via 'Reset device' parameter 3. Replace T-DAT	0x100016E	
	Status signal			F
	Diagnostic behavior			Alarm

Diagnostic information		Remedy instructions	Coding of diagnostic information (hex)	
No.	Short text			
387	HistoROM backup failed	Contact service organization	0x1000288	
	Status signal			F
	Diagnostic behavior			Alarm

12.8.3 Diagnostic of configuration

Diagnostic information		Remedy instructions	Coding of diagnostic information (hex)	
No.	Short text			
303	I/O 1 to n configuration changed	1. Apply I/O module configuration (parameter 'Apply I/O configuration') 2. Afterwards reload device description and check wiring	0x400026C	
	Status signal			M
	Diagnostic behavior			Warning

Diagnostic information		Remedy instructions	Coding of diagnostic information (hex)	
No.	Short text			
330	Flash file invalid	1. Update firmware of device 2. Restart device	0x40002C9	
	Status signal			M
	Diagnostic behavior			Warning

Diagnostic information		Remedy instructions	Coding of diagnostic information (hex)	
No.	Short text			
331	Firmware update failed	1. Update firmware of device 2. Restart device	0x10002CA	
	Status signal			F
	Diagnostic behavior			Warning

Diagnostic information		Remedy instructions	Coding of diagnostic information (hex)	
No.	Short text			
410	Data transfer	1. Check connection 2. Retry data transfer	0x100008B	
	Status signal			F
	Diagnostic behavior			Alarm

Diagnostic information		Remedy instructions	Coding of diagnostic information (hex)	
No.	Short text			
412	Processing download	Download active, please wait	0x2000204	
	Status signal			C
	Diagnostic behavior			Warning

Diagnostic information		Remedy instructions	Coding of diagnostic information (hex)	
No.	Short text			
431	Trim 1 to n	Carry out trim	0x2000004	
	Status signal			C
	Diagnostic behavior			Warning

Diagnostic information		Remedy instructions	Coding of diagnostic information (hex)	
No.	Short text			
437	Configuration incompatible	1. Restart device 2. Contact service	0x1000060	
	Status signal			F
	Diagnostic behavior			Alarm

Diagnostic information		Remedy instructions	Coding of diagnostic information (hex)	
No.	Short text			
438	Dataset	1. Check data set file 2. Check device configuration 3. Up- and download new configuration	0x400006A	
	Status signal			M
	Diagnostic behavior			Warning

Diagnostic information		Remedy instructions	Coding of diagnostic information (hex)	
No.	Short text			
441	Current output 1 to n	1. Check process 2. Check current output settings	<ul style="list-style-type: none"> ▪ 0x8000099 ▪ 0x80000B6 	
	Status signal			S
	Diagnostic behavior			Warning

Diagnostic information		Remedy instructions	Coding of diagnostic information (hex)	
No.	Short text			
442	Frequency output 1 to n	1. Check process 2. Check frequency output settings	<ul style="list-style-type: none"> ■ 0x800008A ■ 0x8000122 	
	Status signal			S
	Diagnostic behavior			Warning

Diagnostic information		Remedy instructions	Coding of diagnostic information (hex)	
No.	Short text			
443	Pulse output 1 to n	1. Check process 2. Check pulse output settings	<ul style="list-style-type: none"> ■ 0x800008C ■ 0x8000121 	
	Status signal			S
	Diagnostic behavior			Warning

Diagnostic information		Remedy instructions	Coding of diagnostic information (hex)	
No.	Short text			
444	Current input 1 to n	1. Check process 2. Check current input settings	0x80001EB	
	Status signal			S
	Diagnostic behavior			Warning

Diagnostic information		Remedy instructions	Coding of diagnostic information (hex)	
No.	Short text			
453	Flow override	Deactivate flow override	0x2000094	
	Status signal			C
	Diagnostic behavior			Warning

Diagnostic information		Remedy instructions	Coding of diagnostic information (hex)	
No.	Short text			
484	Failure mode simulation	Deactivate simulation	0x2000090	
	Status signal			C
	Diagnostic behavior			Alarm

Diagnostic information		Remedy instructions	Coding of diagnostic information (hex)	
No.	Short text			
485	Measured variable simulation	Deactivate simulation	0x2000093	
	Status signal			C
	Diagnostic behavior			Warning

Diagnostic information		Remedy instructions	Coding of diagnostic information (hex)	
No.	Short text			
486	Current input 1 to n simulation	Deactivate simulation	0x20001EC	
	Status signal			C
	Diagnostic behavior			Warning

Diagnostic information		Remedy instructions	Coding of diagnostic information (hex)	
No.	Short text			
491	Current output 1 to n simulation	Deactivate simulation	0x200000E	
	Status signal			C
	Diagnostic behavior			Warning

Diagnostic information		Remedy instructions	Coding of diagnostic information (hex)	
No.	Short text			
492	Simulation frequency output 1 to n	Deactivate simulation frequency output	0x200008D	
	Status signal			C
	Diagnostic behavior			Warning

Diagnostic information		Remedy instructions	Coding of diagnostic information (hex)	
No.	Short text			
493	Simulation pulse output 1 to n	Deactivate simulation pulse output	0x200008E	
	Status signal			C
	Diagnostic behavior			Warning

Diagnostic information		Remedy instructions	Coding of diagnostic information (hex)	
No.	Short text			
494	Switch output simulation 1 to n	Deactivate simulation switch output	0x200008F	
	Status signal			C
	Diagnostic behavior			Warning

Diagnostic information		Remedy instructions	Coding of diagnostic information (hex)	
No.	Short text			
495	Diagnostic event simulation	Deactivate simulation	0x200015E	
	Status signal			C
	Diagnostic behavior			Warning

Diagnostic information		Remedy instructions	Coding of diagnostic information (hex)
No.	Short text		
496	Status input simulation		Deactivate simulation status input 0x2000170
	Status signal	C	
	Diagnostic behavior	Warning	

Diagnostic information		Remedy instructions	Coding of diagnostic information (hex)
No.	Short text		
520	I/O 1 to n hardware configuration invalid		1. Check I/O hardware configuration 2. Replace wrong I/O module 3. Plug the module of double pulse output on correct slot 0x1000276
	Status signal	F	
	Diagnostic behavior	Alarm	

Diagnostic information		Remedy instructions	Coding of diagnostic information (hex)
No.	Short text		
528	Concentration settings faulty		1. Check concentration settings 2. Check input values e.g. pressure, temperature 0x8000387
	Status signal	S	
	Diagnostic behavior	Alarm	

Diagnostic information		Remedy instructions	Coding of diagnostic information (hex)
No.	Short text		
529	Concentration settings faulty		1. Check concentration settings 2. Check input values e.g. pressure, temperature 0x8000389
	Status signal	S	
	Diagnostic behavior	Warning	

Diagnostic information		Remedy instructions	Coding of diagnostic information (hex)
No.	Short text		
537	Configuration		1. Check IP addresses in network 2. Change IP address 0x100014A
	Status signal	F	
	Diagnostic behavior	Warning	

Diagnostic information		Remedy instructions	Coding of diagnostic information (hex)
No.	Short text		
594	Relay output simulation		Deactivate simulation switch output 0x20002BA
	Status signal	C	
	Diagnostic behavior	Warning	

12.8.4 Diagnostic of process

Diagnostic information		Remedy instructions	Coding of diagnostic information (hex)	
No.	Short text			
803	Current loop	1. Check wiring 2. Change I/O module	0x1000AD	
	Status signal			F
	Diagnostic behavior			Alarm

Diagnostic information		Remedy instructions	Coding of diagnostic information (hex)	
No.	Short text			
830	Sensor temperature too high	Reduce ambient temp. around the sensor housing	0x8000C0	
	Status signal			S
	Diagnostic behavior [from the factory] ¹⁾			Warning

1) Diagnostic behavior can be changed.

Diagnostic information		Remedy instructions	Coding of diagnostic information (hex)	
No.	Short text			
831	Sensor temperature too low	Increase ambient temp. around the sensor housing	0x8000C2	
	Status signal			S
	Diagnostic behavior [from the factory] ¹⁾			Warning

1) Diagnostic behavior can be changed.

Diagnostic information		Remedy instructions	Coding of diagnostic information (hex)	
No.	Short text			
832	Electronic temperature too high	Reduce ambient temperature	<ul style="list-style-type: none"> ■ 0x8000C3 ■ 0x80002D4 	
	Status signal			S
	Diagnostic behavior [from the factory] ¹⁾			Warning

1) Diagnostic behavior can be changed.

Diagnostic information		Remedy instructions	Coding of diagnostic information (hex)	
No.	Short text			
833	Electronic temperature too low	Increase ambient temperature	<ul style="list-style-type: none"> ■ 0x8000C1 ■ 0x80002D3 	
	Status signal			S
	Diagnostic behavior [from the factory] ¹⁾			Warning

1) Diagnostic behavior can be changed.

Diagnostic information		Remedy instructions	Coding of diagnostic information (hex)	
No.	Short text			
834	Process temperature too high	Reduce process temperature	0x80000C5	
	Status signal			S
	Diagnostic behavior [from the factory] ¹⁾			Warning

1) Diagnostic behavior can be changed.

Diagnostic information		Remedy instructions	Coding of diagnostic information (hex)	
No.	Short text			
835	Process temperature too low	Increase process temperature	0x80000C6	
	Status signal			S
	Diagnostic behavior [from the factory] ¹⁾			Warning

1) Diagnostic behavior can be changed.

Diagnostic information		Remedy instructions	Coding of diagnostic information (hex)	
No.	Short text			
842	Process limit	Low flow cut off active! 1. Check low flow cut off configuration	0x8000091	
	Status signal			S
	Diagnostic behavior			Warning

Diagnostic information		Remedy instructions	Coding of diagnostic information (hex)	
No.	Short text			
862	Partly filled pipe	1. Check for gas in process 2. Adjust detection limits	0x8000092	
	Status signal			S
	Diagnostic behavior			Warning

Diagnostic information		Remedy instructions	Coding of diagnostic information (hex)	
No.	Short text			
882	Input signal	1. Check input configuration 2. Check external device or process conditions	<ul style="list-style-type: none"> ■ 0x1000031 ■ 0x1000257 	
	Status signal			F
	Diagnostic behavior			Alarm

Diagnostic information		Remedy instructions	Coding of diagnostic information (hex)	
No.	Short text			
910	Tubes not oscillating	1. Check electronic 2. Inspect sensor	0x1000050	
	Status signal			F
	Diagnostic behavior			Alarm

Diagnostic information		Remedy instructions	Coding of diagnostic information (hex)	
No.	Short text			
912	Medium inhomogeneous	1. Check process cond. 2. Increase system pressure	<ul style="list-style-type: none"> ■ 0x80000C4 ■ 0x80000DF ■ 0x8000115 ■ 0x8000162 	
	Status signal			S
	Diagnostic behavior [from the factory] ¹⁾			Warning

1) Diagnostic behavior can be changed.

Diagnostic information		Remedy instructions	Coding of diagnostic information (hex)	
No.	Short text			
913	Medium unsuitable	1. Check process conditions 2. Check electronic modules or sensor	0x80000CD	
	Status signal			S
	Diagnostic behavior [from the factory] ¹⁾			Alarm

1) Diagnostic behavior can be changed.

Diagnostic information		Remedy instructions	Coding of diagnostic information (hex)	
No.	Short text			
941	API temperature out of specification	1. Check process temperature with selected API commodity group 2. Check API related parameters	0x8000380	
	Status signal			S
	Diagnostic behavior			Alarm

Diagnostic information		Remedy instructions	Coding of diagnostic information (hex)	
No.	Short text			
942	API density out of specification	1. Check process density with selected API commodity group 2. Check API related parameters	0x800033B	
	Status signal			S
	Diagnostic behavior			Alarm

Diagnostic information		Remedy instructions	Coding of diagnostic information (hex)	
No.	Short text			
943	API pressure out of specification	1. Check process pressure with selected API commodity group 2. Check API related parameters	0x800037F	
	Status signal			S
	Diagnostic behavior			Alarm





Diagnostic information		Remedy instructions	Coding of diagnostic information (hex)	
No.	Short text			
944	Monitoring failed	Check process conditions for Heartbeat Monitoring	0x80001C6	
	Status signal			S
	Diagnostic behavior [from the factory] ¹⁾			Warning



1) Diagnostic behavior can be changed.

Diagnostic information		Remedy instructions	Coding of diagnostic information (hex)	
No.	Short text			
948	Oscillation damping too high	Check process conditions	0x8000168	
	Status signal			S
	Diagnostic behavior			Warning

12.9 Pending diagnostic events





The **Diagnostics** menu allows the user to view the current diagnostic event and the previous diagnostic event separately.

-  To call up the measures to rectify a diagnostic event:
 - Via local display →  202
 - Via Web browser →  203
 - Via "FieldCare" operating tool →  204
 - Via "DeviceCare" operating tool →  204

-  Other pending diagnostic events can be displayed in the **Diagnostic list** submenu →  220

Navigation

"Diagnostics" menu

 Diagnostics	
Actual diagnostics	→  219
Previous diagnostics	→  219
Operating time from restart	→  219
Operating time	→  219

Parameter overview with brief description

Parameter	Prerequisite	Description	User interface
Actual diagnostics	A diagnostic event has occurred.	Shows the current occurred diagnostic event along with its diagnostic information.  If two or more messages occur simultaneously, the message with the highest priority is shown on the display.	Symbol for diagnostic behavior, diagnostic code and short message.
Previous diagnostics	Two diagnostic events have already occurred.	Shows the diagnostic event that occurred prior to the current diagnostic event along with its diagnostic information.	Symbol for diagnostic behavior, diagnostic code and short message.
Operating time from restart	–	Shows the time the device has been in operation since the last device restart.	Days (d), hours (h), minutes (m) and seconds (s)
Operating time	–	Indicates how long the device has been in operation.	Days (d), hours (h), minutes (m) and seconds (s)

12.10 Diagnostic list

Up to 5 currently pending diagnostic events can be displayed in the **Diagnostic list** submenu along with the associated diagnostic information. If more than 5 diagnostic events are pending, the events with the highest priority are shown on the display.

Navigation path

Diagnostics → Diagnostic list

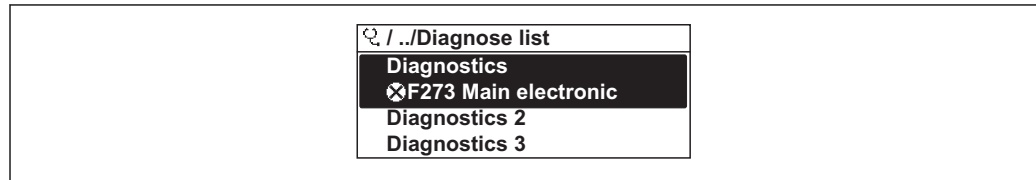

A0014006-EN

38 Taking the example of the local display

To call up the measures to rectify a diagnostic event:

- Via local display → 202
- Via Web browser → 203
- Via "FieldCare" operating tool → 204
- Via "DeviceCare" operating tool → 204

12.11 Event logbook

12.11.1 Reading out the event logbook

A chronological overview of the event messages that have occurred is provided in the **Events list** submenu.

Navigation path

Diagnostics menu → **Event logbook** submenu → Event list

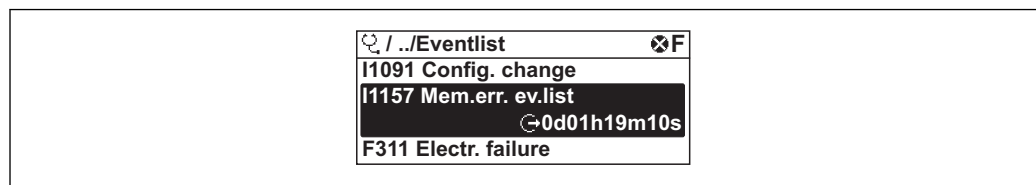

A0014008-EN

39 Taking the example of the local display





- A maximum of 20 event messages can be displayed in chronological order.
- If the **Extended HistoROM** application package (order option) is enabled in the device, the event list can contain up to 100 entries.

The event history includes entries for:

- Diagnostic events → 206
- Information events → 221

In addition to the operation time of its occurrence, each event is also assigned a symbol that indicates whether the event has occurred or is ended:

- Diagnostic event
 - ☺: Occurrence of the event
 - ☹: End of the event
- Information event
 - ☺: Occurrence of the event

-  To call up the measures to rectify a diagnostic event:
- Via local display →  202
 - Via Web browser →  203
 - Via "FieldCare" operating tool →  204
 - Via "DeviceCare" operating tool →  204

-  For filtering the displayed event messages →  221

12.11.2 Filtering the event logbook

Using the **Filter options** parameter you can define which category of event message is displayed in the **Events list** submenu.

Navigation path

Diagnostics → Event logbook → Filter options

Filter categories

- All
- Failure (F)
- Function check (C)
- Out of specification (S)
- Maintenance required (M)
- Information (I)

12.11.3 Overview of information events

Unlike a diagnostic event, an information event is displayed in the event logbook only and not in the diagnostic list.

Info number	Info name
I1000	----- (Device ok)
I1079	Sensor changed
I1089	Power on
I1090	Configuration reset
I1091	Configuration changed
I1092	HistoROM backup deleted
I1111	Density adjust failure
I1137	Electronic changed
I1151	History reset
I1155	Reset electronic temperature
I1156	Memory error trend
I1157	Memory error event list
I1184	Display connected
I1209	Density adjustment ok
I1221	Zero point adjust failure
I1222	Zero point adjustment ok

Info number	Info name
I1256	Display: access status changed
I1278	I/O module reset detected
I1335	Firmware changed
I1361	Web server: login failed
I1397	Fieldbus: access status changed
I1398	CDI: access status changed
I1444	Device verification passed
I1445	Device verification failed
I1447	Record application reference data
I1448	Application reference data recorded
I1449	Recording application ref. data failed
I1450	Monitoring off
I1451	Monitoring on
I1457	Measured error verification failed
I1459	I/O module verification failed
I1460	HBSI verification failed
I1461	Sensor verification failed
I1462	Sensor electronic module verific. failed
I1512	Download started
I1513	Download finished
I1514	Upload started
I1515	Upload finished
I1618	I/O module 2 replaced
I1619	I/O module 3 replaced
I1621	I/O module 4 replaced
I1622	Calibration changed
I1624	Reset all totalizers
I1625	Write protection activated
I1626	Write protection deactivated
I1627	Web server: login successful
I1628	Display: login successful
I1629	CDI: login successful
I1631	Web server access changed
I1632	Display: login failed
I1633	CDI: login failed
I1634	Reset to factory settings
I1635	Reset to delivery settings
I1639	Max. switch cycles number reached
I1649	Hardware write protection activated
I1650	Hardware write protection deactivated
I1712	New flash file received
I1725	Sensor electronic module (ISEM) changed
I1726	Configuration backup failed

12.12 Resetting the measuring device

Using the **Device reset** parameter (→  173) it is possible to reset the entire device configuration or some of the configuration to a defined state.

12.12.1 Function scope of the "Device reset" parameter









Options	Description
Cancel	No action is executed and the user exits the parameter.
To delivery settings	Every parameter for which a customer-specific default setting was ordered is reset to this customer-specific value. All other parameters are reset to the factory setting.
Restart device	The restart resets every parameter whose data are in the volatile memory (RAM) to the factory setting (e.g. measured value data). The device configuration remains unchanged.
Restore S-DAT backup	Restore the data that are saved on the S-DAT. The data record is restored from the electronics memory to the S-DAT.

12.13 Device information





The **Device information** submenu contains all parameters that display different information for device identification.

Navigation

"Diagnostics" menu → Device information



► Device information	
Device tag	→  224
Serial number	→  224
Firmware version	→  224
Device name	→  224
Order code	→  224
Extended order code 1	→  224
Extended order code 2	→  224
Extended order code 3	→  224
ENP version	→  224

Parameter overview with brief description

Parameter	Description	User interface	Factory setting
Device tag	Shows name of measuring point.	Max. 32 characters, such as letters, numbers or special characters (e.g. @, %, /).	Promass
Serial number	Shows the serial number of the measuring device.	A maximum of 11-digit character string comprising letters and numbers.	–
Firmware version	Shows the device firmware version installed.	Character string in the format xx.yy.zz	–
Device name	Shows the name of the transmitter.  The name can be found on the nameplate of the transmitter.	Promass300/500	–
Order code	Shows the device order code.  The order code can be found on the nameplate of the sensor and transmitter in the "Order code" field.	Character string composed of letters, numbers and certain punctuation marks (e.g. /).	–
Extended order code 1	Shows the 1st part of the extended order code.  The extended order code can also be found on the nameplate of the sensor and transmitter in the "Ext. ord. cd." field.	Character string	–
Extended order code 2	Shows the 2nd part of the extended order code.  The extended order code can also be found on the nameplate of the sensor and transmitter in the "Ext. ord. cd." field.	Character string	–
Extended order code 3	Shows the 3rd part of the extended order code.  The extended order code can also be found on the nameplate of the sensor and transmitter in the "Ext. ord. cd." field.	Character string	–
ENP version	Shows the version of the electronic nameplate (ENP).	Character string	2.02.00

12.14 Firmware history

Release date	Firmware version	Order code for "Firmware version"	Firmware changes	Documentation type	Documentation
10.2017	01.00.zz	Option 77	Original firmware	Operating Instructions	BA01750D

-  It is possible to flash the firmware to the current version or the previous version using the service interface.
-  For the compatibility of the firmware version with the previous version, the installed device description files and operating tools, observe the information about the device in the "Manufacturer's information" document.
-  The manufacturer's information is available:
 - In the Download Area of the Endress+Hauser web site: www.endress.com → Downloads
 - Specify the following details:
 - Product root: e.g. 8F 5B
The product root is the first part of the order code: see the nameplate on the device.
 - Text search: Manufacturer's information
 - Media type: Documentation – Technical Documentation

13 Maintenance

13.1 Maintenance tasks

No special maintenance work is required.

13.1.1 Exterior cleaning

When cleaning the exterior of measuring devices, always use cleaning agents that do not attack the surface of the housing or the seals.

13.1.2 Interior cleaning

Observe the following points for CIP and SIP cleaning:

- Use only cleaning agents to which the process-wetted materials are adequately resistant.
- Observe the maximum permitted medium temperature for the measuring device
→  248.

13.2 Measuring and test equipment

Endress+Hauser offers a wide variety of measuring and test equipment, such as W@M or device tests.

 Your Endress+Hauser Sales Center can provide detailed information on the services.

List of some of the measuring and testing equipment: →  229

13.3 Endress+Hauser services

Endress+Hauser offers a wide variety of services for maintenance such as recalibration, maintenance service or device tests.

 Your Endress+Hauser Sales Center can provide detailed information on the services.

14 Repairs

14.1 General notes

14.1.1 Repair and conversion concept

The Endress+Hauser repair and conversion concept provides for the following:

- The measuring devices have a modular design.
- Spare parts are grouped into logical kits with the associated Installation Instructions.
- Repairs are carried out by Endress+Hauser Service or by appropriately trained customers.
- Certified devices can only be converted to other certified devices by Endress+Hauser Service or at the factory.

14.1.2 Notes for repair and conversion

For repair and modification of a measuring device, observe the following notes:

- ▶ Use only original Endress+Hauser spare parts.
- ▶ Carry out the repair according to the Installation Instructions.
- ▶ Observe the applicable standards, federal/national regulations, Ex documentation (XA) and certificates.
- ▶ Document every repair and each conversion and enter them into the *W@M* life cycle management database.

14.2 Spare parts

W@M Device Viewer (www.endress.com/deviceviewer):

All the spare parts for the measuring device, along with the order code, are listed here and can be ordered. If available, users can also download the associated Installation Instructions.



Measuring device serial number:

- Is located on the nameplate of the device.
- Can be read out via the **Serial number** parameter (→ 224) in the **Device information** submenu.

14.3 Endress+Hauser services

Endress+Hauser offers a wide range of services.



Your Endress+Hauser Sales Center can provide detailed information on the services.

14.4 Return

The measuring device must be returned if it is need of repair or a factory calibration, or if the wrong measuring device has been delivered or ordered. Legal specifications require Endress+Hauser, as an ISO-certified company, to follow certain procedures when handling products that are in contact with the medium.

To ensure safe, swift and professional device returns, please refer to the procedure and conditions for returning devices provided on the Endress+Hauser website at

<http://www.endress.com/support/return-material>

14.5 Disposal

14.5.1 Removing the measuring device

1. Switch off the device.

⚠ WARNING

Danger to persons from process conditions.

- ▶ Beware of hazardous process conditions such as pressure in the measuring device, high temperatures or aggressive fluids.

2. Carry out the mounting and connection steps from the "Mounting the measuring device" and "Connecting the measuring device" sections in reverse order. Observe the safety instructions.

14.5.2 Disposing of the measuring device

⚠ WARNING

Danger to personnel and environment from fluids that are hazardous to health.

- ▶ Ensure that the measuring device and all cavities are free of fluid residues that are hazardous to health or the environment, e.g. substances that have permeated into crevices or diffused through plastic.

Observe the following notes during disposal:











- ▶ Observe valid federal/national regulations.
- ▶ Ensure proper separation and reuse of the device components.



15 Accessories

Various accessories, which can be ordered with the device or subsequently from Endress+Hauser, are available for the device. Detailed information on the order code in question is available from your local Endress+Hauser sales center or on the product page of the Endress+Hauser website: www.endress.com.

15.1 Device-specific accessories

15.1.1 For the transmitter



Accessories	Description
Transmitter <ul style="list-style-type: none"> ▪ Proline 500 – digital ▪ Proline 500 	Transmitter for replacement or storage. Use the order code to define the following specifications: <ul style="list-style-type: none"> ▪ Approvals ▪ Output ▪ Input ▪ Display / operation ▪ Housing ▪ Software <p> ▪ Proline 500 – digital transmitter: Order code: 8X5BXX-XXXXXXXXXA</p> <p>▪ Proline 500 transmitter: Order code: 8X5BXX-XXXXXXXXXB</p> <p> Proline 500 transmitter for replacement: It is essential to specify the serial number of the current transmitter when ordering. Based on the serial number, the device-specific data (e.g., calibration factors) of the replacement device can be used for the new transmitter.</p> <p> For details</p> <ul style="list-style-type: none"> ▪ Proline 500 – digital transmitter: Installation Instructions EA01151 ▪ Proline 500 transmitter: Installation Instructions EA01152
External WLAN antenna	External WLAN antenna with 2 m (6.6 ft) connecting cable and two angle brackets. Order code for "Enclosed accessories", option P8 "Wireless antenna wide area". <p> Further information on the WLAN interface →  92.</p>
Pipe mounting set	Pipe mounting set for transmitter. <p> ▪ Proline 500 – digital transmitter Order number: 71346427</p> <p>▪ Proline 500 transmitter Order number: 71346428</p>
Protective cover Transmitter <ul style="list-style-type: none"> ▪ Proline 500 – digital ▪ Proline 500 	Is used to protect the measuring device from the effects of the weather: e.g. rainwater, excess heating from direct sunlight. <p> ▪ Proline 500 – digital transmitter Order number: 71343504</p> <p>▪ Proline 500 transmitter Order number: 71343505</p> <p> For details, see Installation Instructions EA01160</p>
Display guard Proline 500 – digital	Is used to protect the measuring device from the effects of the weather: e.g. rainwater, excess heating from direct sunlight. <p> Order number: 71228792</p> <p> For details, see Installation Instructions EA01161</p>

Connecting cable Proline 500 – digital Sensor – Transmitter	The connecting cable can be ordered directly with the measuring device (order code for "Cable, sensor connection") or as an accessory (order number DK8012). The following cable lengths are available: order code for "Cable, sensor connection" <ul style="list-style-type: none"> ▪ Option B: 20 m (65 ft) ▪ Option E: User configurable up to max. 50 m ▪ Option F: User configurable up to max. 165 ft  Maximum possible cable length for a Proline 500 – digital connecting cable: 300 m (1 000 ft)
Connecting cable Proline 500 Sensor – Transmitter	The connecting cable can be ordered directly with the measuring device (order code for "Cable, sensor connection") or as an accessory (order number DK8012). The following cable lengths are available: order code for "Cable, sensor connection" <ul style="list-style-type: none"> ▪ Option 1: 5 m (16 ft) ▪ Option 2: 10 m (32 ft) ▪ Option 3: 20 m (65 ft)  Possible cable length for a Proline 500 connecting cable: max. 20 m (65 ft)

15.1.2 For the sensor



Accessories	Description
Heating jacket	Is used to stabilize the temperature of the fluids in the sensor. Water, water vapor and other non-corrosive liquids are permitted for use as fluids. If using oil as a heating medium, please consult with Endress+Hauser. Heating jackets cannot be used with sensors fitted with a rupture disk.  For details, see Operating Instructions BA00132D

15.2 Communication-specific accessories





Accessories	Description
Field Xpert SFX350	Field Xpert SFX350 is a mobile computer for commissioning and maintenance. It enables efficient device configuration and diagnostics for and can be used in non-hazardous areas.  For details, see Operating Instructions BA01202S
Field Xpert SFX370	Field Xpert SFX370 is a mobile computer for commissioning and maintenance. It enables efficient device configuration and diagnostics for and can be used in the non-hazardous area and in the hazardous area.  For details, see Operating Instructions BA01202S

15.3 Service-specific accessories

Accessories	Description
Applicator	Software for selecting and sizing Endress+Hauser measuring devices: <ul style="list-style-type: none"> ▪ Choice of measuring devices for industrial requirements ▪ Calculation of all the necessary data for identifying the optimum flowmeter: e.g. nominal diameter, pressure loss, flow velocity and accuracy. ▪ Graphic illustration of the calculation results ▪ Determination of the partial order code, administration, documentation and access to all project-related data and parameters over the entire life cycle of a project. Applicator is available: <ul style="list-style-type: none"> ▪ Via the Internet: https://wapps.endress.com/applicator ▪ As a downloadable DVD for local PC installation.

W@M	<p>W@M Life Cycle Management Improved productivity with information at your fingertips. Data relevant to a plant and its components is generated from the first stages of planning and during the asset's complete life cycle. W@M Life Cycle Management is an open and flexible information platform with online and on-site tools. Instant access for your staff to current, in-depth data shortens your plant's engineering time, speeds up procurement processes and increases plant uptime. Combined with the right services, W@M Life Cycle Management boosts productivity in every phase. For more information, visit www.endress.com/lifecyclemanagement</p>
FieldCare	<p>FDT-based plant asset management tool from Endress+Hauser. It can configure all smart field units in your system and helps you manage them. By using the status information, it is also a simple but effective way of checking their status and condition.  For details, see Operating Instructions BA00027S and BA00059S</p>
DeviceCare	<p>Tool for connecting and configuring Endress+Hauser field devices.  For details, see Innovation brochure IN01047S</p>

15.4 System components

Accessories	Description
Memograph M graphic data manager	<p>The Memograph M graphic data manager provides information on all the relevant measured variables. Measured values are recorded correctly, limit values are monitored and measuring points analyzed. The data are stored in the 256 MB internal memory and also on a SD card or USB stick.  For details, see "Technical Information" TI00133R and Operating Instructions BA00247R</p>
Cerabar M	<p>The pressure transmitter for measuring the absolute and gauge pressure of gases, steam and liquids. It can be used to read in the operating pressure value.  For details, see "Technical Information" TI00426P, TI00436P and Operating Instructions BA00200P, BA00382P</p>
Cerabar S	<p>The pressure transmitter for measuring the absolute and gauge pressure of gases, steam and liquids. It can be used to read in the operating pressure value.  For details, see "Technical Information" TI00383P and Operating Instructions BA00271P</p>
iTEMP	<p>The temperature transmitters can be used in all applications and are suitable for the measurement of gases, steam and liquids. They can be used to read in the medium temperature.  For details, see "Fields of Activity", FA00006T</p>

16 Technical data

16.1 Application

The measuring device is suitable for flow measurement of liquids and gases only.

Depending on the version ordered, the measuring device can also measure potentially explosive, flammable, poisonous and oxidizing media.

To ensure that the device remains in proper operating condition for its service life, use the measuring device only for media against which the process-wetted materials are sufficiently resistant.

16.2 Function and system design

Measuring principle

Mass flow measurement based on the Coriolis measuring principle

Measuring system

The measuring system consists of a transmitter and a sensor. The transmitter and sensor are mounted in physically separate locations. They are interconnected by one connecting cable(s).

For information on the structure of the device →  15

16.3 Input

Measured variable

Direct measured variables

- Mass flow
- Density
- Temperature

Calculated measured variables

- Volume flow
- Corrected volume flow
- Reference density

Measuring range

Measuring ranges for liquids

DN		Measuring range full scale values $\dot{m}_{\min(F)}$ to $\dot{m}_{\max(F)}$	
[mm]	[in]	[kg/h]	[lb/min]
8	$\frac{3}{8}$	0 to 2 000	0 to 73.50
15	$\frac{1}{2}$	0 to 6 500	0 to 238.9
25	1	0 to 18 000	0 to 661.5
40	$1\frac{1}{2}$	0 to 45 000	0 to 1 654
50	2	0 to 70 000	0 to 2 573
80	3	0 to 180 000	0 to 6 615
100	4	0 to 350 000	0 to 12 860
150	6	0 to 800 000	0 to 29 400
250	10	0 to 2 200 000	0 to 80 850

Measuring ranges for gases

The full scale values depend on the density of the gas and can be calculated with the formula below:

$$\dot{m}_{\max(G)} = \dot{m}_{\max(F)} \cdot \rho_G : x$$

$\dot{m}_{\max(G)}$	Maximum full scale value for gas [kg/h]
$\dot{m}_{\max(F)}$	Maximum full scale value for liquid [kg/h]
$\dot{m}_{\max(G)} < \dot{m}_{\max(F)}$	$\dot{m}_{\max(G)}$ can never be greater than $\dot{m}_{\max(F)}$
ρ_G	Gas density in [kg/m ³] at operating conditions
x	Constant dependent on nominal diameter

DN		x
[mm]	[in]	[kg/m ³]
8	$\frac{3}{8}$	60
15	$\frac{1}{2}$	80
25	1	90
40	$1\frac{1}{2}$	90
50	2	90
80	3	110

DN		x
[mm]	[in]	[kg/m ³]
100	4	130
150	6	200
250	10	200

Calculation example for gas

- Sensor: Promass F, DN 50
- Gas: Air with a density of 60.3 kg/m³ (at 20 °C and 50 bar)
- Measuring range (liquid): 70 000 kg/h
- x = 90 kg/m³ (for Promass F, DN 50)

Maximum possible full scale value:

$$\dot{m}_{\max(G)} = \dot{m}_{\max(F)} \cdot \rho_G : x = 70\,000 \text{ kg/h} \cdot 60.3 \text{ kg/m}^3 : 90 \text{ kg/m}^3 = 46\,900 \text{ kg/h}$$

Recommended measuring range

"Flow limit" section →  251

Operable flow range

Over 1000 : 1.



Flow rates above the preset full scale value do not override the electronics unit, with the result that the totalizer values are registered correctly.

Input signal

External measured values

To increase the accuracy of certain measured variables or to calculate the corrected volume flow for gases, the automation system can continuously write different measured values to the measuring device:

- Operating pressure to increase accuracy (Endress+Hauser recommends the use of a pressure measuring device for absolute pressure, e.g. Cerabar M or Cerabar S)
- Medium temperature to increase accuracy (e.g. iTEMP)
- Reference density for calculating the corrected volume flow for gases

 Various pressure transmitters and temperature measuring devices can be ordered from Endress+Hauser: see "Accessories" section →  231

It is recommended to read in external measured values to calculate the following measured variables for gases:

Corrected volume flow

Current input

The measured values are written from the automation system to the measuring device via the current input →  234.

Digital communication

The measured values are written from the automation system to the measuring device via EtherNet/IP.

Current input 0/4 to 20 mA

Current input	0/4 to 20 mA (active/passive)
Current span	<ul style="list-style-type: none"> ■ 4 to 20 mA (active) ■ 0/4 to 20 mA (passive)
Resolution	1 µA
Voltage drop	Typically: 0.6 to 2 V for 3.6 to 22 mA (passive)

Maximum input voltage	≤ 30 V (passive)
Open-circuit voltage	≤ 28.8 V (active)
Possible input variables	<ul style="list-style-type: none"> ▪ Pressure ▪ Temperature ▪ Density

Status input

Maximum input values	<ul style="list-style-type: none"> ▪ DC -3 to 30 V ▪ If status input is active (ON): $R_i > 3 \text{ k}\Omega$
Response time	Adjustable: 5 to 200 ms
Input signal level	<ul style="list-style-type: none"> ▪ Low signal: DC -3 to +5 V ▪ High signal: DC 12 to 30 V
Assignable functions	<ul style="list-style-type: none"> ▪ Off ▪ Reset the individual totalizers separately ▪ Reset all totalizers ▪ Flow override



16.4 Output

Output signal

EtherNet/IP



Standards	In accordance with IEEE 802.3
-----------	-------------------------------

Current output 0/4 to 20 mA

Current output	0/4 to 20 mA
Maximum output values	22.5 mA
Current span	Can be set to: <ul style="list-style-type: none"> ▪ 4 to 20 mA (active) ▪ 0/4 to 20 mA (passive)  Ex-i, passive
Open-circuit voltage	DC 28.8 V (active)
Maximum input voltage	DC 30 V (passive)
Load	0 to 700 Ω
Resolution	0.38 μA
Damping	Adjustable: 0.07 to 999 s
Assignable measured variables	<ul style="list-style-type: none"> ▪ Mass flow ▪ Volume flow ▪ Corrected volume flow ▪ Density ▪ Reference density ▪ Temperature ▪ Electronic temperature ▪ Oscillation frequency 0 ▪ Oscillation damping 0 ▪ Signal asymmetry ▪ Exciter current 0  The range of options increases if the measuring device has one or more application packages.

Pulse/frequency/switch output

Function	Can be set to pulse, frequency or switch output
Version	Open collector Can be set to: <ul style="list-style-type: none"> ▪ Active ▪ Passive  Ex-i, passive
Maximum input values	DC 30 V, 250 mA (passive)
Open-circuit voltage	DC 28.8 V (active)
Voltage drop	For 22.5 mA: ≤ DC 2 V
Pulse output	
Maximum input values	DC 30 V, 250 mA (passive)
Maximum output current	22.5 mA (active)
Open-circuit voltage	DC 28.8 V (active)
Pulse width	Adjustable: 0.05 to 2 000 ms
Maximum pulse rate	10 000 Impulse/s

Pulse value	Adjustable
Assignable measured variables	<ul style="list-style-type: none"> ▪ Mass flow ▪ Volume flow ▪ Corrected volume flow
Frequency output	
Maximum input values	DC 30 V, 250 mA (passive)
Maximum output current	22.5 mA (active)
Open-circuit voltage	DC 28.8 V (active)
Output frequency	Adjustable: end value frequency 2 to 10 000 Hz ($f_{\max} = 12\,500$ Hz)
Damping	Adjustable: 0 to 999 s
Pulse/pause ratio	1:1
Assignable measured variables	<ul style="list-style-type: none"> ▪ Mass flow ▪ Volume flow ▪ Corrected volume flow ▪ Density ▪ Reference density ▪ Temperature ▪ Electronic temperature ▪ Oscillation frequency 0 ▪ Oscillation damping 0 ▪ Signal asymmetry ▪ Exciter current 0 <p> The range of options increases if the measuring device has one or more application packages.</p>
Switch output	
Maximum input values	DC 30 V, 250 mA (passive)
Open-circuit voltage	DC 28.8 V (active)
Switching behavior	Binary, conductive or non-conductive
Switching delay	Adjustable: 0 to 100 s
Number of switching cycles	Unlimited
Assignable functions	<ul style="list-style-type: none"> ▪ Off ▪ On ▪ Diagnostic behavior ▪ Limit value <ul style="list-style-type: none"> – Mass flow – Volume flow – Corrected volume flow – Density – Reference density – Temperature – Totalizer 1-3 ▪ Flow direction monitoring ▪ Status <ul style="list-style-type: none"> – Partially filled pipe detection – Low flow cut off <p> The range of options increases if the measuring device has one or more application packages.</p>

Relay output

Function	Switch output
Version	Relay output, galvanically isolated
Switching behavior	Can be set to: <ul style="list-style-type: none"> ▪ NO (normally open), factory setting ▪ NC (normally closed)

Maximum switching capacity (passive)	<ul style="list-style-type: none"> ■ DC 30 V, 0.1 A ■ AC 30 V, 0.5 A
Assignable functions	<ul style="list-style-type: none"> ■ Off ■ On ■ Diagnostic behavior ■ Limit value <ul style="list-style-type: none"> - Mass flow - Volume flow - Corrected volume flow - Density - Reference density - Temperature - Totalizer 1-3 ■ Flow direction monitoring ■ Status <ul style="list-style-type: none"> - Partially filled pipe detection - Low flow cut off <p> The range of options increases if the measuring device has one or more application packages.</p>

User configurable input/output

One specific input or output is assigned to a user-configurable input/output (configurable I/O) during device commissioning.

The following inputs and outputs are available for assignment:

- Choice of current output: 4 to 20 mA (active), 0/4 to 20 mA (passive)
- Pulse/frequency/switch output
- Choice of current input: 4 to 20 mA (active), 0/4 to 20 mA (passive)
- Status input

The technical values correspond to those of the inputs and outputs described in this section.

Signal on alarm

Depending on the interface, failure information is displayed as follows:

EtherNet/IP

Device diagnostics	Device condition can be read out in Input Assembly
---------------------------	--

Current output 0/4 to 20 mA

4 to 20 mA

Failure mode	<p>Choose from:</p> <ul style="list-style-type: none"> ■ 4 to 20 mA in accordance with NAMUR recommendation NE 43 ■ 4 to 20 mA in accordance with US ■ Min. value: 3.59 mA ■ Max. value: 22.5 mA ■ Freely definable value between: 3.59 to 22.5 mA ■ Actual value ■ Last valid value
---------------------	---

0 to 20 mA

Failure mode	<p>Choose from:</p> <ul style="list-style-type: none"> ■ Maximum alarm: 22 mA ■ Freely definable value between: 0 to 20.5 mA
---------------------	--

Pulse/frequency/switch output

Pulse output	
Failure mode	Choose from: <ul style="list-style-type: none"> ▪ Actual value ▪ No pulses
Frequency output	
Failure mode	Choose from: <ul style="list-style-type: none"> ▪ Actual value ▪ 0 Hz ▪ Defined value (f_{\max} 2 to 12 500 Hz)
Switch output	
Failure mode	Choose from: <ul style="list-style-type: none"> ▪ Current status ▪ Open ▪ Closed

Relay output

Failure mode	Choose from: <ul style="list-style-type: none"> ▪ Current status ▪ Open ▪ Closed
--------------	---

Local display

Plain text display	With information on cause and remedial measures
Backlight	Red backlighting indicates a device error.

 Status signal as per NAMUR recommendation NE 107

Interface/protocol

- Via digital communication:
 - EtherNet/IP
- Via service interface
 - CDI-RJ45 service interface
 - WLAN interface

Plain text display	With information on cause and remedial measures
--------------------	---

Web server

Plain text display	With information on cause and remedial measures
--------------------	---

Light emitting diodes (LED)

Status information	<p>Status indicated by various light emitting diodes</p> <p>The following information is displayed depending on the device version:</p> <ul style="list-style-type: none"> ▪ Supply voltage active ▪ Data transmission active ▪ Device alarm/error has occurred ▪ EtherNet/IP network available ▪ EtherNet/IP connection established <p> Diagnostic information via light emitting diodes</p>
---------------------------	---

Low flow cut off The switch points for low flow cut off are user-selectable.

Galvanic isolation The outputs are galvanically isolated from one another and from earth (PE).

Protocol-specific data	Protocol	<ul style="list-style-type: none"> ▪ The CIP Networks Library Volume 1: Common Industrial Protocol ▪ The CIP Networks Library Volume 2: EtherNet/IP Adaptation of CIP
	Communication type	<ul style="list-style-type: none"> ▪ 10Base-T ▪ 100Base-TX
	Device profile	Generic device (product type: 0x2B)
	Manufacturer ID	0x11
	Device type ID	0x103B
	Baud rates	Automatic ¹⁰ / ₁₀₀ Mbit with half-duplex and full-duplex detection
	Polarity	Auto-polarity for automatic correction of crossed TxD and RxD pairs
	Supported CIP connections	Max. 3 connections
	Explicit connections	Max. 6 connections
	I/O connections	Max. 6 connections (scanner)
	Configuration options for measuring device	<ul style="list-style-type: none"> ▪ DIP switches on the electronics module for IP addressing ▪ Manufacturer-specific software (FieldCare) ▪ Add-on Profile Level 3 for Rockwell Automation control systems ▪ Web browser ▪ Electronic Data Sheet (EDS) integrated in the measuring device
	Configuration of the EtherNet interface	<ul style="list-style-type: none"> ▪ Speed: 10 MBit, 100 MBit, auto (factory setting) ▪ Duplex: half-duplex, full-duplex, auto (factory setting)
	Configuration of the device address	<ul style="list-style-type: none"> ▪ DIP switches on the electronics module for IP addressing (last octet) ▪ DHCP ▪ Manufacturer-specific software (FieldCare) ▪ Add-on Profile Level 3 for Rockwell Automation control systems ▪ Web browser ▪ EtherNet/IP tools, e.g. RSLinx (Rockwell Automation)
Device Level Ring (DLR)	Yes	
System integration	<p>Information regarding system integration →  97.</p> <ul style="list-style-type: none"> ▪ Cyclic data transmission ▪ Block model ▪ Input and output groups 	

16.5 Power supply

Terminal assignment →  40

Device plugs available →  40

Supply voltage	Order code for "Power supply"	terminal voltage		Frequency range
	Option D	DC24 V	±20%	–
Option E	AC100 to 240 V	–15...+10%	50/60 Hz	
Option I	DC24 V	±20%	–	
	AC100 to 240 V	–15...+10%	50/60 Hz	

Power consumption **Transmitter**
Max. 10 W (active power)

Current consumption **Transmitter**

- Max. 400 mA (24 V)
- Max. 200 mA (110 V, 50/60 Hz; 230 V, 50/60 Hz)

Power supply failure

- Totalizers stop at the last value measured.
- Configuration is retained in the plug-in memory (HistoROM DAT).
- Error messages (incl. total operated hours) are stored.

Electrical connection →  52

Potential equalization →  60

terminals Spring-loaded terminals: Suitable for strands and strands with ferrules.
Conductor cross-section 0.2 to 2.5 mm² (24 to 12 AWG).

Cable entries

- Cable gland: M20 × 1.5 with cable Ø 6 to 12 mm (0.24 to 0.47 in)
- Thread for cable entry:
 - NPT ½"
 - G ½"
 - M20
- Device plug for digital communication: M12
- Device plug for connecting cable: M12



A device plug is always used for the device version with the order code for "Sensor connection housing", option C "Ultra-compact, hygienic, stainless".

Cable specification →  36

16.6 Performance characteristics



reference operating conditions

- Error limits based on ISO 11631
- Water with +15 to +45 °C (+59 to +113 °F) at 2 to 6 bar (29 to 87 psi)
- Specifications as per calibration protocol
- Accuracy based on accredited calibration rigs that are traced to ISO 17025.

 To obtain measured errors, use the *Applicator* sizing tool →  230

Maximum measured error o.r. = of reading; 1 g/cm³ = 1 kg/l; T = medium temperature

Base accuracy

 Design fundamentals →  246

Mass flow and volume flow (liquids)

±0.05 % o.r. (PremiumCal; order code for "Calibration flow", option **D**, for mass flow)
±0.10 % o.r.

Mass flow (cryogenic liquids)

Order code for "Measuring tube material", option **LA**
±0.35 % o.r.

Mass flow (gases)

±0.35 % o.r.

Density (liquids)

Under reference operating conditions [g/cm ³]	Standard density calibration ¹⁾ [g/cm ³]	Wide-range Density specification ^{2) 3)} [g/cm ³]
±0.0005	±0.01	±0.001

- 1) Valid over the entire temperature and density range
- 2) Valid range for special density calibration: 0 to 2 g/cm³, +5 to +80 °C (+41 to +176 °F)
- 3) Order code for "Application package", option EF "Special density"

Density (cryogenic liquids)

Order code for "Measuring tube material", option **LA**
±0.05 g/cm³

Temperature

±0.5 °C ± 0.005 · T °C (±0.9 °F ± 0.003 · (T - 32) °F)

Zero point stability

DN		Zero point stability	
[mm]	[in]	[kg/h]	[lb/min]
8	3/8	0.030	0.001
15	1/2	0.200	0.007
25	1	0.540	0.019
40	1½	2.25	0.083
50	2	3.50	0.129
80	3	9.0	0.330
100	4	14.0	0.514
150	6	32.0	1.17
250	10	88.0	3.23

High-temperature version: order code for "Measuring tube material", option TT, TU

DN		Zero point stability	
[mm]	[in]	[kg/h]	[lb/min]
25	1	1.80	0.0661
50	2	7.00	0.2572
80	3	18.0	0.6610

For devices with low-temperature version, order code for "Measuring tube mat., wetted surface", option LA, please note the following:

NOTICE

Zero point confirmation and zero point adjustment are difficult to carry out in the field due to the vaporization of the cryogenic liquid.

- As a general rule, the factory-set zero point should not be changed. Please ensure that the medium is in the liquid phase if a zero point adjustment is to be carried out.

Flow values

Flow values as turndown parameter depending on nominal diameter.

SI units

DN	1:1	1:10	1:20	1:50	1:100	1:500
[mm]	[kg/h]	[kg/h]	[kg/h]	[kg/h]	[kg/h]	[kg/h]
8	2000	200	100	40	20	4
15	6500	650	325	130	65	13
25	18000	1800	900	360	180	36
40	45000	4500	2250	900	450	90
50	70000	7000	3500	1400	700	140
80	180000	18000	9000	3600	1800	360
100	350000	35000	17500	7000	3500	700
150	800000	80000	40000	16000	8000	1600
250	2200000	220000	110000	44000	22000	4400

US units

DN	1:1	1:10	1:20	1:50	1:100	1:500
[inch]	[lb/min]	[lb/min]	[lb/min]	[lb/min]	[lb/min]	[lb/min]
$\frac{3}{8}$	73.50	7.350	3.675	1.470	0.735	0.147
$\frac{1}{2}$	238.9	23.89	11.95	4.778	2.389	0.478
1	661.5	66.15	33.08	13.23	6.615	1.323
1½	1654	165.4	82.70	33.08	16.54	3.308
2	2573	257.3	128.7	51.46	25.73	5.146
3	6615	661.5	330.8	132.3	66.15	13.23
4	12860	1286	643.0	257.2	128.6	25.72
6	29400	2940	1470	588	294	58.80
10	80850	8085	4043	1617	808.5	161.7

Accuracy of outputs

The outputs have the following base accuracy specifications.

Current output

Accuracy	±5 µA
-----------------	-------



Pulse/frequency output

o.r. = of reading

Accuracy	Max. ±50 ppm o.r. (over the entire ambient temperature range)
-----------------	---

Repeatability o.r. = of reading; 1 g/cm³ = 1 kg/l; T = medium temperature

Base repeatability

 Design fundamentals →  246

Mass flow and volume flow (liquids)

±0.025 % o.r. (PremiumCal, for mass flow)
±0.05 % o.r.

Mass flow (cryogenic liquids)

Order code for "Measuring tube material", option **LA**
±0.175 % o.r.

Mass flow (gases)

±0.25 % o.r.

Density (liquids)

±0.00025 g/cm³

Density (cryogenic liquids)

Order code for "Measuring tube material", option **LA**
±0.025 g/cm³

Temperature

±0.25 °C ± 0.0025 · T °C (±0.45 °F ± 0.0015 · (T-32) °F)

Response time The response time depends on the configuration (damping).

Influence of ambient temperature

Current output

Temperature coefficient	Max. 1 µA/°C
--------------------------------	--------------

Pulse/frequency output

Temperature coefficient	No additional effect. Included in accuracy.
--------------------------------	---

Influence of medium temperature

Mass flow and volume flow

o.f.s. = of full scale value

When there is a difference between the temperature for zero point adjustment and the process temperature, the additional measured error of the sensor is typically $\pm 0.0002\%$ o.f.s./ $^{\circ}\text{C}$ ($\pm 0.0001\%$ o.f.s./ $^{\circ}\text{F}$).

The effect is reduced if zero point adjustment is performed at process temperature.

Density

When there is a difference between the density calibration temperature and the process temperature, the typical measured error of the sensor is $\pm 0.00005\text{ g/cm}^3\text{ /}^{\circ}\text{C}$ ($\pm 0.000025\text{ g/cm}^3\text{ /}^{\circ}\text{F}$). Field density calibration is possible.

Wide-range density specification (special density calibration)

If the process temperature is outside the valid range (\rightarrow  242) the measured error is $\pm 0.00005\text{ g/cm}^3\text{ /}^{\circ}\text{C}$ ($\pm 0.000025\text{ g/cm}^3\text{ /}^{\circ}\text{F}$)

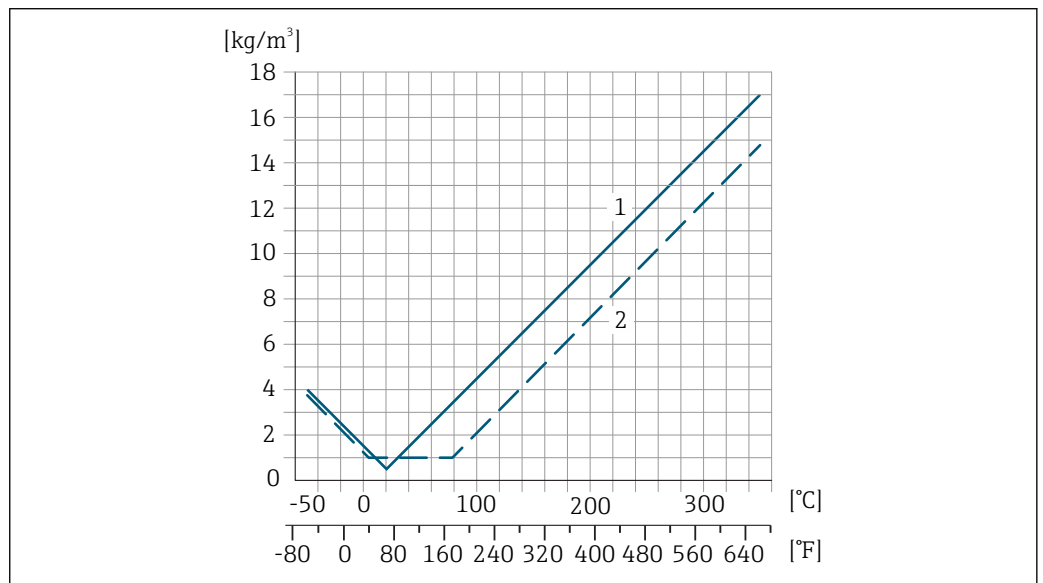

- 1 Field density calibration, for example at +20 °C (+68 °F)
- 2 Special density calibration

Temperature

$\pm 0.005 \cdot T\text{ }^{\circ}\text{C}$ ($\pm 0.005 \cdot (T - 32)\text{ }^{\circ}\text{F}$)

Influence of medium pressure

The table below shows the effect on accuracy of mass flow due to a difference between calibration pressure and process pressure.

o.r. = of reading

-  It is possible to compensate for the effect by:
 - Reading in the current pressure measured value via the current input.
 - Specifying a fixed value for the pressure in the device parameters.

 Operating Instructions .

DN		[% o.r./bar]	[% o.r./psi]
[mm]	[in]		
8	3/8	no influence	
15	1/2	no influence	
25	1	no influence	
40	1 1/2	-0.003	-0.0002

DN		[% o.r./bar]	[% o.r./psi]
[mm]	[in]		
50	2	-0.008	-0.0006
80	3	-0.009	-0.0006
100	4	-0.007	-0.0005
150	6	-0.009	-0.0006
250	10	-0.009	-0.0006

Design fundamentals

o.r. = of reading, o.f.s. = of full scale value

BaseAccu = base accuracy in % o.r., BaseRepeat = base repeatability in % o.r.

MeasValue = measured value; ZeroPoint = zero point stability

Calculation of the maximum measured error as a function of the flow rate

Flow rate	Maximum measured error in % o.r.
$\geq \frac{\text{ZeroPoint}}{\text{BaseAccu}} \cdot 100$ <small>A0021332</small>	$\pm \text{BaseAccu}$ <small>A0021339</small>
$< \frac{\text{ZeroPoint}}{\text{BaseAccu}} \cdot 100$ <small>A0021333</small>	$\pm \frac{\text{ZeroPoint}}{\text{MeasValue}} \cdot 100$ <small>A0021334</small>

Calculation of the maximum repeatability as a function of the flow rate

Flow rate	Maximum repeatability in % o.r.
$\geq \frac{1/2 \cdot \text{ZeroPoint}}{\text{BaseRepeat}} \cdot 100$ <small>A0021335</small>	$\pm \text{BaseRepeat}$ <small>A0021340</small>
$< \frac{1/2 \cdot \text{ZeroPoint}}{\text{BaseRepeat}} \cdot 100$ <small>A0021336</small>	$\pm 1/2 \cdot \frac{\text{ZeroPoint}}{\text{MeasValue}} \cdot 100$ <small>A0021337</small>

Example for maximum measured error

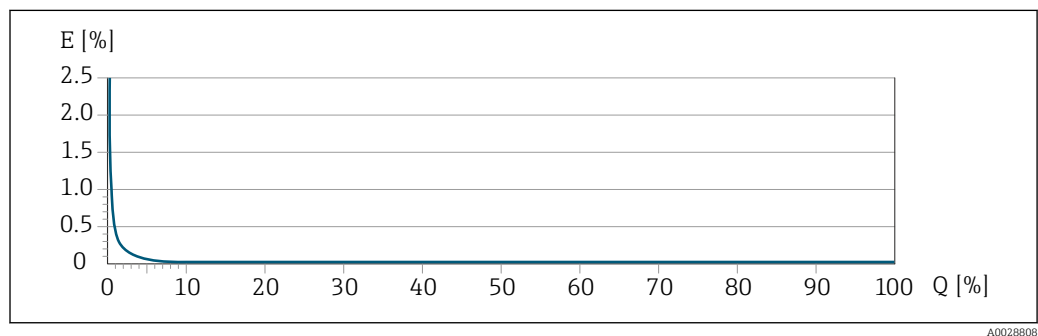

E Maximum measured error in % o.r. (example with PremiumCal)
 Q Flow rate in % of maximum full scale value



16.7 Installation

"Mounting requirements"

16.8 Environment

Ambient temperature range →  26

Temperature tables

-  Observe the interdependencies between the permitted ambient and fluid temperatures when operating the device in hazardous areas.
-  For detailed information on the temperature tables, see the separate document entitled "Safety Instructions" (XA) for the device.

Storage temperature -50 to +80 °C (-58 to +176 °F)

Climate class DIN EN 60068-2-38 (test Z/AD)

Degree of protection

Transmitter

- As standard: IP66/67, type 4X enclosure
- When housing is open: IP20, type 1 enclosure
- Display module: IP20, type 1 enclosure

Sensor

- As standard: IP66/67, type 4X enclosure
- With the order code for "Sensor options", option **CM**: IP69 can also be ordered

External WLAN antenna

IP67

Vibration resistance

Device version: Order code for "Sensor connection housing", option: A "Aluminum, coated", B "Stainless" or C "Ultra-compact hygienic, stainless"

- Vibration, sinusoidal according to IEC 60068-2-6
 - 2 to 8.4 Hz, 7.5 mm peak
 - 8.4 to 2 000 Hz, 2 g peak
- Vibration broad-band random, according to IEC 60068-2-64
 - 10 to 200 Hz, 0.01 g²/Hz
 - 200 to 2 000 Hz, 0.003 g²/Hz
 - Total: 2.70 g rms

Device version: Order code for "Sensor connection housing", option: L "Cast, stainless"

For medium temperature range: standard version

- Vibration, sinusoidal according to IEC 60068-2-6
 - 2 to 8.4 Hz, 7.5 mm peak
 - 8.4 to 2 000 Hz, 2 g peak
- Vibration broad-band random, according to IEC 60068-2-64
 - 10 to 200 Hz, 0.01 g²/Hz
 - 200 to 2 000 Hz, 0.003 g²/Hz
 - Total: 2.70 g rms

Device version: Order code for "Sensor connection housing", option: L "Cast, stainless"
 For medium temperature range: extended temperature version, high-temperature version and low-temperature version

- Vibration, sinusoidal according to IEC 60068-2-6
 - 2 to 8.4 Hz, 3.5 mm peak
 - 8.4 to 2 000 Hz, 1 g peak
- Vibration broad-band random, according to IEC 60068-2-64
 - 10 to 200 Hz, 0.003 g²/Hz
 - 200 to 2 000 Hz, 0.001 g²/Hz
 - Total: 1.54 g rms

Shock resistance	Shock, half-sine according to IEC 60068-2-27 6 ms 50 g
Impact resistance	Rough handling shocks according to IEC 60068-2-31
Mechanical load	Never use the transmitter housing as a ladder or climbing aid.
Electromagnetic compatibility (EMC)	As per IEC/EN 61326 and NAMUR Recommendation 21 (NE 21)  Details are provided in the Declaration of Conformity.

16.9 Process

Medium temperature range

Standard version	-50 to +150 °C (-58 to +302 °F)	Order code for "Measuring tube mat., wetted surface", option HA, SA, SB, SC
Extended temperature version	-50 to +240 °C (-58 to +464 °F)	Order code for "Measuring tube mat., wetted surface", option SD, SE, SF, TH
High-temperature version	-50 to +350 °C (-58 to +662 °F)	For nominal diameters DN 25 (1"), DN 50 (2") and DN 80 (3") Order code for "Measuring tube mat., wetted surface", option TT, TU
Low-temperature version	-196 to +150 °C (-320 to +302 °F) <div style="background-color: #0070C0; color: white; padding: 2px; display: inline-block; font-weight: bold;">NOTICE</div> Material fatigue due to excessive temperature differential. ► The maximum temperature differential of the fluid used must not exceed 300 K.	Order code for "Measuring tube mat., wetted surface", option LA

Dependency of ambient temperature on medium temperature

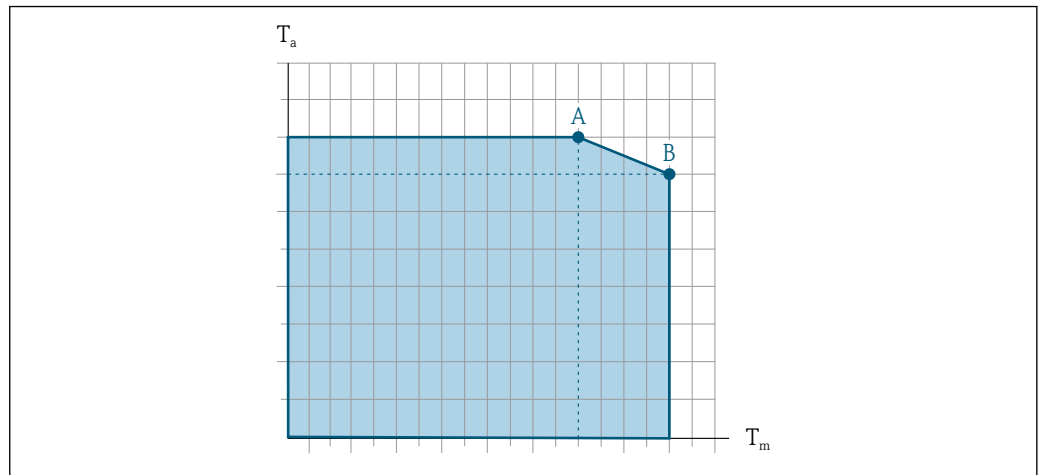

A0031121

40 Exemplary representation, values in the table below.

T_a Ambient temperature

T_m Medium temperature

A Maximum permitted medium temperature T_m at $T_{a\max} = 60\text{ °C}$ (140 °F); higher medium temperatures T_m require a reduced ambient temperature T_a

B Maximum permitted ambient temperature T_a for the maximum specified medium temperature T_m of the sensor



Values for devices used in the hazardous area:

Separate Ex documentation (XA) for the device → 264.

Version ¹⁾	Not insulated				Insulated			
	A		B		A		B	
	T_a	T_m	T_a	T_m	T_a	T_m	T_a	T_m
Standard version	60 °C (140 °F)	130 °C (266 °F)	55 °C (131 °F)	150 °C (302 °F)	60 °C (140 °F)	90 °C (194 °F)	45 °C (113 °F)	150 °C (302 °F)
Extended temperature version	60 °C (140 °F)	240 °C (464 °F)	–	–	60 °C (140 °F)	150 °C (302 °F)	50 °C (122 °F)	240 °C (464 °F)
High-temperature version	60 °C (140 °F)	240 °C (464 °F)	50 °C (122 °F)	350 °C (662 °F)	60 °C (140 °F)	210 °C (410 °F)	50 °C (122 °F)	350 °C (662 °F)

1) The values apply for Promass F 500 - digital and Promass F 500.

Density 0 to 5 000 kg/m³ (0 to 312 lb/cf)

Pressure-temperature ratings



An overview of the pressure-temperature ratings for the process connections is provided in the "Technical Information" document

Secondary containment

For the Standard version with the temperature range -50 to $+150\text{ °C}$ (-58 to $+302\text{ °F}$), the sensor housing is filled with dry nitrogen gas and protects the electronics and mechanics inside.

For all other temperature versions the sensor housing is filled with dry inert gas.

The following secondary containment pressure ratings/burst pressures are only valid for standard devices and/or devices equipped with closed purge connections (never opened/as delivered).

If a device fitted with purge connections (order code for "Sensor option", option **CH** "Purge connection") is connected to the purge system, the maximum nominal pressure is determined by the purge system itself or by the device, depending on which component has the lower nominal pressure classification.

If the device is fitted with a rupture disk (order code for "Sensor option", option **CA** "Rupture disk"), the rupture disk trigger pressure is decisive for the maximum nominal pressure →  250.

The secondary containment burst pressure refers to a typical internal pressure achieved prior to mechanical failure of the secondary containment as determined during type testing. The corresponding type test declaration can be ordered with the device (order code for "Additional approval", option **LN** "Type test containment").

DN		Secondary containment pressure rating (designed with a safety factor ≥ 4)		Secondary containment burst pressure	
[mm]	[in]	[bar]	[psi]	[bar]	[psi]
8	3/8	40	580	255	3 698
15	1/2	40	580	200	2 900
25	1	40	580	280	4 060
40	1 1/2	40	580	180	2 610
50	2	40	580	195	2 828
80	3	25	362	105	1 522
100	4	16	232	85	1 232
150	6	16	232	80	1 160
250	10	10	145	57	826

 If a measuring tube fails (e.g. due to process characteristics like corrosive or abrasive fluids), the fluid will be contained by the secondary containment.

If there is a need to drain the leaking medium into a discharge device, the sensor should be fitted with a rupture disk. Connect the discharge to the additional threaded connection .

If the sensor is to be purged with gas (gas detection), it should be equipped with purge connections.

 Do not open the purge connections unless the containment can be filled immediately with a dry, inert gas. Use only low pressure to purge. Maximum pressure: 5 bar (72.5 psi).

In case of a tube failure, the pressure level inside the secondary containment will rise according to the operating process pressure. If the user judges that the secondary containment pressure rating/burst pressure does not provide an adequate safety margin, the device can be fitted with a rupture disk. This prevents excessively high pressure from forming inside the secondary containment. Therefore, the use of a rupture disk is strongly recommended in applications involving high gas pressures, and particularly in applications in which the process pressure is greater than 2/3 of the secondary containment burst pressure.

 For information on the dimensions: see the "Mechanical construction" section of the "Technical Information" document

Rupture disk

To increase the level of safety, a device version with a rupture disk with a trigger pressure of 10 to 15 bar (145 to 217.5 psi) can be used (order code for "Sensor option", option **CA** "rupture disk").

Rupture disks cannot be combined with the separately available heating jacket .

Special mounting instructions: →  28





For information on the dimensions: see the "Mechanical construction" section

Flow limit

Select the nominal diameter by optimizing between the required flow range and permissible pressure loss.



For an overview of the full scale values for the measuring range, see the "Measuring range" section →  233

- The minimum recommended full scale value is approx. 1/20 of the maximum full scale value
- In most applications, 20 to 50 % of the maximum full scale value can be considered ideal
- A low full scale value must be selected for abrasive media (such as liquids with entrained solids): flow velocity < 1 m/s (< 3 ft/s).
- For gas measurement the following rules apply:
 - The flow velocity in the measuring tubes should not exceed half the sound velocity (0.5 Mach).
 - The maximum mass flow depends on the density of the gas: formula →  233



To calculate the flow limit, use the *Applicator* sizing tool →  230

Pressure loss



To calculate the pressure loss, use the *Applicator* sizing tool →  230

Promass F with reduced pressure loss: order code for "Sensor option", option **CE** "reduced pressure loss"

System pressure

→  26

16.10 Mechanical construction

Design, dimensions



For the dimensions and installation lengths of the device, see the "Technical Information" document, "Mechanical construction" section.

Weight

All values (weight exclusive of packaging material) refer to devices with EN/DIN PN 40 flanges.

Different values due to different transmitter versions:

Transmitter

- Proline 500 – digital polycarbonate: 1.4 kg (3.1 lbs)
- Proline 500 – digital aluminum: 2.4 kg (5.3 lbs)
- Proline 500 aluminum: 6.5 kg (14.3 lbs)
- Proline 500 cast, stainless: 15.6 kg (34.4 lbs)

Sensor

- Sensor with aluminum connection housing version: see the information in the following table
- Cast connection housing version, stainless: +3.7 kg (+8.2 lbs)

Weight in SI units

DN [mm]	Weight [kg]
8	9
15	10

DN [mm]	Weight [kg]
25	12
40	17
50	28
80	53
100	94
150	152
250	398

Weight in US units

DN [in]	Weight [lbs]
3/8	20
1/2	22
1	26
1 1/2	37
2	62
3	117
4	207
6	335
10	878

Materials

Transmitter housing

Proline 500 – digital transmitter housing

Order code for "Transmitter housing":

- Option **A** "Aluminum coated": aluminum, AlSi10Mg, coated
- Option **D** "Polycarbonate": polycarbonate

Proline 500 transmitter housing

Order code for "Transmitter housing":

- Option **A** "Aluminum coated": aluminum, AlSi10Mg, coated
- Option **L** "Cast, stainless": cast, stainless steel, 1.4409 (CF3M) similar to 316L

Window material

Order code for "Transmitter housing":



- Option **A** "Aluminum, coated": glass
- Option **D** "Polycarbonate": plastic
- Option **L** "Cast, stainless": glass

Sensor connection housing

Order code for "Sensor connection housing":

- Option **A** "Aluminum coated": aluminum, AlSi10Mg, coated
- Option **B** "Stainless":
 - Stainless steel 1.4301 (304)
 - Optional: Order code for "Sensor feature", option **CC** "Hygienic version, for maximum corrosion resistance": stainless steel, 1.4404 (316L)
- Option **C** "Ultra-compact, stainless":
 - Stainless steel 1.4301 (304)
 - Optional: Order code for "Sensor feature", option **CC** "Hygienic version, for maximum corrosion resistance": stainless steel, 1.4404 (316L)
- Option **L** "Cast, stainless": 1.4409 (CF3M) similar to 316L

Cable entries/cable glands

Cable entries and adapters	Material
Cable gland M20 × 1.5	Plastic
<ul style="list-style-type: none"> ■ Adapter for cable entry with internal thread G ½" ■ Adapter for cable entry with internal thread NPT ½" <p> Only available for certain device versions:</p> <ul style="list-style-type: none"> ■ Order code for "Transmitter housing": <ul style="list-style-type: none"> - Option A "Aluminum, coated" - Option D "Polycarbonate" ■ Order code for "Sensor connection housing": <ul style="list-style-type: none"> - Proline 500 – digital: <ul style="list-style-type: none"> Option A "Aluminum coated" Option B "Stainless" Option L "Cast, stainless" - Proline 500: <ul style="list-style-type: none"> Option B "Stainless" Option L "Cast, stainless" 	Nickel-plated brass
<ul style="list-style-type: none"> ■ Adapter for cable entry with internal thread G ½" ■ Adapter for cable entry with internal thread NPT ½" <p> Only available for certain device versions:</p> <ul style="list-style-type: none"> ■ Order code for "Transmitter housing": <ul style="list-style-type: none"> Option L "Cast, stainless" ■ Order code for "Sensor connection housing": <ul style="list-style-type: none"> Option L "Cast, stainless" 	Stainless steel, 1.4404 (316L)

Connecting cable

Connecting cable for sensor - Proline 500 – digital transmitter

PVC cable with copper shield

Connecting cable for sensor - Proline 500 transmitter

- Standard cable: PVC cable with copper shield
- Reinforced cable: PVC cable with copper shield and additional steel wire braided jacket

 UV rays can impair the cable outer sheath. Protect the cable from exposure to sun as much as possible.

Sensor housing

- Acid and alkali-resistant outer surface
- DN 08 to DN 150: stainless steel, 1.4301 (304)
Optional: order code for "Sensor option", option **CC**: stainless steel, 1.4404 (316L)
- DN 250:
 - Order code for "Measuring tube material", option **SA, SD** (stainless steel, 1.4404 (316L)):
Stainless steel 1.4301 (304)
Optional: order code for "Sensor option", option **CC**: stainless steel, 1.4404 (316L)
 - Order code for "Measuring tube material", option **LA** (stainless steel, 1.4404 (316L)):
Stainless steel 1.4301 (304)
Optional: order code for "Sensor option", option **CC**: stainless steel, 1.4404 (316L)
 - Order code for "Measuring tube material", option **HA, TH** (Alloy C22):
Stainless steel, 1.4404 (316L)

Measuring tubes

- DN 8 to 100 (3/8...4"): stainless steel, 1.4539 (904L);
Manifold: stainless steel, 1.4404 (316/316L)
- DN 150 (6"), DN 250 (10"): stainless steel, 1.4404 (316/316L);
Manifold: stainless steel, 1.4404 (316/316L)
- DN 8 to 250 (3/8 to 10"): Alloy C22, 2.4602 (UNS N06022);
Manifold: Alloy C22, 2.4602 (UNS N06022)

High-temperature version

DN 25, DN 50, DN 80 (DN 1", DN 2", DN 3"): Alloy C22, 2.4602 (UNS N06022)

Process connections

- Flanges according to EN 1092-1 (DIN2501) / according to ASME B 16.5 / as per JIS B2220:
 - Stainless steel, 1.4404 (F316/F316L)
 - Alloy C22, 2.4602 (UNS N06022)
 - Lap joint flanges: stainless steel, 1.4301 (F304); wetted parts Alloy C22
- All other process connections:
Stainless steel, 1.4404 (316/316L)

High-temperature version

Flanges according to EN 1092-1 (DIN2501) / according to ASME B 16.5 / as per JIS B2220:

- Stainless steel, 1.4404 (F316/F316L)
- Alloy C22, 2.4602 (UNS N06022)



List of all available process connections → 255

Seals

Welded process connections without internal seals

Accessories

Protective cover



Stainless steel, 1.4404 (316L)

External WLAN antenna

- Antenna: ASA plastic (acrylic ester-styrene-acrylonitrile) and nickel-plated brass
- Adapter: Stainless steel and nickel-plated brass
- Cable: Polyethylene
- Plug: Nickel-plated brass
- Angle bracket: Stainless steel

Process connections

- Fixed flange connections:
 - EN 1092-1 (DIN 2501) flange
 - EN 1092-1 (DIN 2512N) flange
 - Namur lengths in accordance with NE 132
 - ASME B16.5 flange
 - JIS B2220 flange
 - DIN 11864-2 Form A flange, DIN 11866 series A, flange with notch
- Clamp connections
 - Tri-Clamp (OD tubes), DIN 11866 series C
- Thread:
 - DIN 11851 thread, DIN 11866 series A
 - SMS 1145 thread
 - ISO 2853 thread, ISO 2037
 - DIN 11864-1 Form A thread, DIN 11866 series A
- VCO connections
 - 8-VCO-4
 - 12-VCO-4

 For information on the different materials used in the process connections →  254

Surface roughness

All data relate to parts in contact with fluid. The following surface roughness quality can be ordered.

- Not polished
- $Ra_{max} = 0.8 \mu\text{m}$ (32 μin)
- $Ra_{max} = 0.4 \mu\text{m}$ (16 μin)

16.11 Operability

Languages

Can be operated in the following languages:

- Via local operation
 - English, German, French, Spanish, Italian, Dutch, Portuguese, Polish, Russian, Turkish, Chinese, Japanese, Korean, Bahasa (Indonesian), Vietnamese, Czech, Swedish
- Via Web browser
 - English, German, French, Spanish, Italian, Dutch, Portuguese, Polish, Russian, Turkish, Chinese, Japanese, Korean, Bahasa (Indonesian), Vietnamese, Czech, Swedish
- Via "FieldCare", "DeviceCare" operating tool: English, German, French, Spanish, Italian, Chinese, Japanese

Local operation

Via display module

Two display modules are available:

- Order code for "Display; operation", option **F** "4-line, illuminated, graphic display; touch control"
- Order code for "Display; operation", option **G** "4-line, illuminated, graphic display; touch control + WLAN"

 Information about WLAN interface →  92

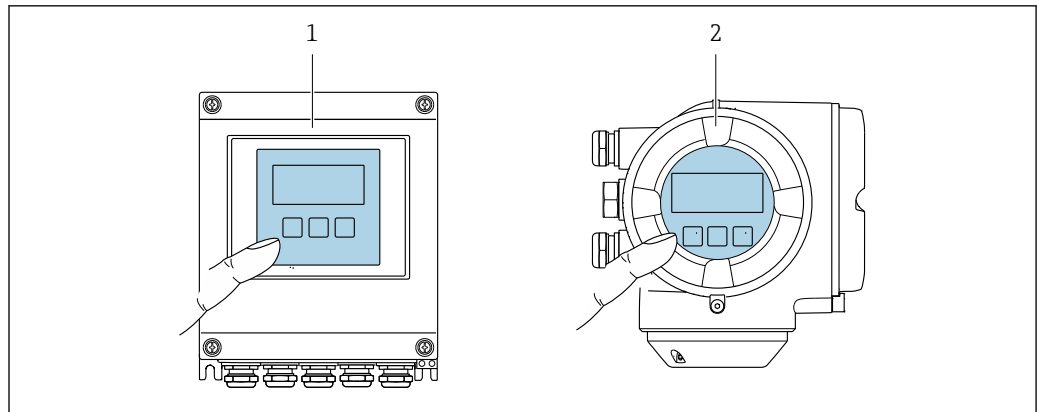

A0028232

41 Operation with touch control

- 1 Proline 500 – digital
- 2 Proline 500

Display elements

- 4-line, illuminated, graphic display
- White background lighting; switches to red in event of device errors
- Format for displaying measured variables and status variables can be individually configured
- Permitted ambient temperature for the display: -20 to +60 °C (-4 to +140 °F)
The readability of the display may be impaired at temperatures outside the temperature range.



Operating elements

- External operation via touch control (3 optical keys) without opening the housing: ⊕, ⊖, ⊞
- Operating elements also accessible in the various zones of the hazardous area

Remote operation → 90

Service interface → 91

Supported operating tools Different operating tools can be used for local or remote access to the measuring device. Depending on the operating tool used, access is possible with different operating units and via a variety of interfaces.

Supported operating tools	Operating unit	Interface	Additional information
Web browser	Notebook, PC or tablet with Web browser	<ul style="list-style-type: none"> ▪ CDI-RJ45 service interface ▪ WLAN interface ▪ Ethernet-based fieldbus (EtherNet/IP, PROFINET) 	Special Documentation for device →  264
DeviceCare SFE100	Notebook, PC or tablet with Microsoft Windows system	<ul style="list-style-type: none"> ▪ CDI-RJ45 service interface ▪ WLAN interface ▪ Fieldbus protocol 	→  230
FieldCare SFE500	Notebook, PC or tablet with Microsoft Windows system	<ul style="list-style-type: none"> ▪ CDI-RJ45 service interface ▪ WLAN interface ▪ Fieldbus protocol 	→  230



Other operating tools based on FDT technology with a device driver such as DTM/iDTM or DD/EDD can be used for device operation. These operating tools are available from the individual manufacturers. Integration into the following operating tools, among others, is supported:

- Field Device Manager (FDM) by Honeywell → www.honeywellprocess.com
- FieldMate by Yokogawa → www.yokogawa.com
- PACTWare → www.pactware.com

The associated device description files are available at: www.endress.com → Downloads

Web server

Thanks to the integrated Web server, the device can be operated and configured via a Web browser and via a service interface (CDI-RJ45) or via a WLAN interface. The structure of the operating menu is the same as for the local display. In addition to the measured values, status information on the device is also displayed and allows the user to monitor the status of the device. Furthermore the device data can be managed and the network parameters can be configured.

A device that has a WLAN interface (can be ordered as an option) is required for the WLAN connection: order code for "Display; operation", option **G** "4-line, illuminated; touch control + WLAN". The device acts as an Access Point and enables communication by computer or a mobile handheld terminal.

Supported functions

Data exchange between the operating unit (such as a notebook for example) and the measuring device:

- Upload the configuration from the measuring device (XML format, configuration backup)
- Save the configuration to the measuring device (XML format, restore configuration)
- Export event list (.csv file)
- Export parameter settings (.csv file or PDF file, document the measuring point configuration)
- Export the Heartbeat verification log (PDF file, only available with the "Heartbeat Verification" application package)
- Flash firmware version for device firmware upgrade, for instance
- Download driver for system integration
- Visualize up to 1000 saved measured values (only available with the **Extended HistoROM** application package →  262)



Webserver special documentation →  264

HistoROM data management

The measuring device features HistoROM data management. HistoROM data management comprises both the storage and import/export of key device and process data, making operation and servicing far more reliable, secure and efficient.

 When the device is delivered, the factory settings of the configuration data are stored as a backup in the device memory. This memory can be overwritten with an updated data record, for example after commissioning.

Additional information on the data storage concept

There are different types of data storage units in which device data are stored and used by the device:

	Device memory	T-DAT	S-DAT
Available data	<ul style="list-style-type: none"> ▪ Event logbook such as diagnostic events for example ▪ Parameter data record backup ▪ Device firmware package ▪ Driver for system integration for exporting via Web server, e.g.: EDS for EtherNet/IP 	<ul style="list-style-type: none"> ▪ Measured value logging ("Extended HistoROM" order option) ▪ Current parameter data record (used by firmware at run time) ▪ Maximum indicators (min/max values) ▪ Totalizer values 	<ul style="list-style-type: none"> ▪ Sensor data: nominal diameter etc. ▪ Serial number ▪ Calibration data ▪ Device configuration (e.g. SW options, fixed I/O or multi I/O)
Storage location	Fixed on the user interface board in the connection compartment	Attachable to the user interface board in the connection compartment	In the sensor plug in the transmitter neck part

Data backup

Automatic

- The most important device data (sensor and transmitter) are automatically saved in the DAT modules
- If the transmitter or measuring device is replaced: once the T-DAT containing the previous device data has been exchanged, the new measuring device is ready for operation again immediately without any errors
- If the sensor is replaced: once the sensor has been replaced, new sensor data are transferred from the S-DAT in the measuring device and the measuring device is ready for operation again immediately without any errors
- If exchanging the electronics module (e.g. I/O electronics module): Once the electronics module has been replaced, the software of the module is compared against the current device firmware. The module software is upgraded or downgraded where necessary. The electronics module is available for use immediately afterwards and no compatibility problems occur.

Manual

Additional parameter data record (complete parameter settings) in the integrated device memory HistoROM backup for:

- Data backup function
Backup and subsequent restoration of a device configuration in the device memory HistoROM backup
- Data comparison function
Comparison of the current device configuration with the device configuration saved in the device memory HistoROM backup

Data transfer

Manual

- Transfer of a device configuration to another device using the export function of the specific operating tool, e.g. with FieldCare, DeviceCare or Web server: to duplicate the configuration or to store in an archive (e.g. for backup purposes)
- Transmission of the drivers for system integration via Web server, e.g.: EDS for EtherNet/IP

Event list**Automatic**

- Chronological display of up to 20 event messages in the events list
- If the **Extended HistoROM** application package (order option) is enabled: up to 100 event messages are displayed in the events list along with a time stamp, plain text description and remedial measures
- The events list can be exported and displayed via a variety of interfaces and operating tools e.g. DeviceCare, FieldCare or Web server

Data logging**Manual**

If the **Extended HistoROM** application package (order option) is enabled:

- Record up to 1 000 measured values via 1 to 4 channels
- User configurable recording interval
- Record up to 250 measured values via each of the 4 memory channels
- Export the measured value log via a variety of interfaces and operating tools e.g. FieldCare, DeviceCare or web server

16.12 Certificates and approvals

CE mark	<p>The measuring system is in conformity with the statutory requirements of the applicable EU Directives. These are listed in the corresponding EU Declaration of Conformity along with the standards applied.</p> <p>Endress+Hauser confirms successful testing of the device by affixing to it the CE mark.</p>
C-Tick symbol	<p>The measuring system meets the EMC requirements of the "Australian Communications and Media Authority (ACMA)".</p>
Ex approval	<p>The devices are certified for use in hazardous areas and the relevant safety instructions are provided in the separate "Safety Instructions" (XA) document. Reference is made to this document on the nameplate.</p>
Sanitary compatibility	<ul style="list-style-type: none"> ■ 3-A approval Only devices with the order code for "Additional approval", option LP "3A" have 3-A approval. ■ EHEDG-tested Only devices with the order code for "Additional approval", option LT "EHEDG" have been tested and meet the requirements of the EHEDG. To meet the requirements for EHEDG certification, the device must be used with process connections in accordance with the EHEDG position paper entitled "Easy Cleanable Pipe Couplings and Process Connections" (www.ehedg.org). ■ FDA ■ Food Contact Materials Regulation (EC) 1935/2004
Pharmaceutical compatibility	<ul style="list-style-type: none"> ■ FDA ■ USP Class VI ■ TSE/BSE certificate of suitability



EtherNet/IP certification The measuring device is certified and registered by the ODVA (Open Device Vendor Association). The measuring system meets all the requirements of the following specifications:

- Certified in accordance with the ODVA Conformance Test
- EtherNet/IP Performance Test
- EtherNet/IP PlugFest compliance
- The device can also be operated with certified devices of other manufacturers (interoperability)

Pressure Equipment Directive

- With the identification PED/G1/x (x = category) on the sensor nameplate, Endress+Hauser confirms conformity with the "Essential Safety Requirements" specified in Appendix I of the Pressure Equipment Directive 2014/68/EC.
- Devices not bearing this marking (PED) are designed and manufactured according to good engineering practice. They meet the requirements of Art. 4, Par. 3 of the Pressure Equipment Directive 2014/68/EU. The range of application is indicated in tables 6 to 9 in Annex II of the Pressure Equipment Directive 2014/68/EC.

Radio approval The measuring device has radio approval.

 For detailed information on the radio approval, see the Special Documentation →  264

Additional certification **Marine approval**

Currently valid certificates are available:

- In the Download Area of the Endress+Hauser Internet site: www.endress.com → Downloads
- Specify the following details:
Search area: Approval & Certificates → Marine

CRN approval

Some device versions have CRN approval. A CRN-approved process connection with a CSA approval must be ordered for a CRN-approved device.

Tests and certificates

- Pressure test, internal procedure, inspection certificate
- EN10204-3.1 Material certificate, wetted parts and secondary containment
- PMI test (XRF), internal procedure, wetted parts, test report
- EN10204-2.1 confirmation of compliance with the order and EN10204-2.2 test report

Testing of welded connections

Option	Test standard				Component	
	ISO 23277 AL2x (PT) ISO 10675-1 AL1 (RT, DR)	ASME B31.3 NFS	ASME VIII Div.1 Appx. 4+8	NORSOK M-601	Measuring tube	Process connection
CF	x				PT	RT
KK		x			PT	RT
KP			x		PT	RT
KR				x	VT, PT	VT, RT
K1	x				PT	DR
K2		x			PT	DR
K3			x		PT	DR

Option	Test standard				Component	
	ISO 23277 AL2x (PT) ISO 10675-1 AL1 (RT, DR)	ASME B31.3 NFS	ASME VIII Div.1 Appx. 4+8	NORSOK M-601	Measuring tube	Process connection
K4				x	VT, PT	VT, DR
PT = penetrant testing, RT = radiographic testing, VT = visual testing, DR = digital radiography All options with test report						

Other standards and guidelines

- EN 60529
Degrees of protection provided by enclosures (IP code)
- IEC/EN 60068-2-6
Environmental influences: Test procedure - Test Fc: vibrate (sinusoidal).
- IEC/EN 60068-2-31
Environmental influences: Test procedure - Test Ec: shocks due to rough handling, primarily for devices.
- EN 61010-1
Safety requirements for electrical equipment for measurement, control and laboratory use - general requirements
- IEC/EN 61326
Emission in accordance with Class A requirements. Electromagnetic compatibility (EMC requirements).
- NAMUR NE 21
Electromagnetic compatibility (EMC) of industrial process and laboratory control equipment
- NAMUR NE 32
Data retention in the event of a power failure in field and control instruments with microprocessors
- NAMUR NE 43
Standardization of the signal level for the breakdown information of digital transmitters with analog output signal.
- NAMUR NE 53
Software of field devices and signal-processing devices with digital electronics
- NAMUR NE 80
The application of the pressure equipment directive to process control devices
- NAMUR NE 105
Specifications for integrating fieldbus devices in engineering tools for field devices
- NAMUR NE 107
Self-monitoring and diagnosis of field devices
- NAMUR NE 131
Requirements for field devices for standard applications
- NAMUR NE 132
Coriolis mass meter
- NACE MR0103
Materials resistant to sulfide stress cracking in corrosive petroleum refining environments.
- NACE MR0175/ISO 15156-1
Materials for use in H₂S-containing Environments in Oil and Gas Production.

16.13 Application packages

Many different application packages are available to enhance the functionality of the device. Such packages might be needed to address safety aspects or specific application requirements.

The application packages can be ordered with the device or subsequently from Endress+Hauser. Detailed information on the order code in question is available from your

local Endress+Hauser sales center or on the product page of the Endress+Hauser website: www.endress.com.



Detailed information on the application packages:
Special Documentation for the device → 264

Diagnostics functions

Package	Description
Extended HistoROM	<p>Comprises extended functions concerning the event log and the activation of the measured value memory.</p> <p>Event log: Memory volume is extended from 20 message entries (standard version) to up to 100 entries.</p> <p>Data logging (line recorder):</p> <ul style="list-style-type: none"> ▪ Memory capacity for up to 1000 measured values is activated. ▪ 250 measured values can be output via each of the 4 memory channels. The recording interval can be defined and configured by the user. ▪ Measured value logs can be accessed via the local display or operating tool e.g. FieldCare, DeviceCare or Web server.

Heartbeat Technology

Package	Description
Heartbeat Verification +Monitoring	<p>Heartbeat Verification Meets the requirement for traceable verification to DIN ISO 9001:2008 Chapter 7.6 a) "Control of monitoring and measuring equipment".</p> <ul style="list-style-type: none"> ▪ Functional testing in the installed state without interrupting the process. ▪ Traceable verification results on request, including a report. ▪ Simple testing process via local operation or other operating interfaces. ▪ Clear measuring point assessment (pass/fail) with high test coverage within the framework of manufacturer specifications. ▪ Extension of calibration intervals according to operator's risk assessment. <p>Heartbeat Monitoring Continuously supplies data, which are characteristic of the measuring principle, to an external condition monitoring system for the purpose of preventive maintenance or process analysis. These data enable the operator to:</p> <ul style="list-style-type: none"> ▪ Draw conclusions - using these data and other information - about the impact process influences (such as corrosion, abrasion, buildup etc.) have on the measuring performance over time. ▪ Schedule servicing in time. ▪ Monitor the process or product quality, e.g. gas pockets.



Concentration

Package	Description
Concentration measurement and special density	<p>Calculation and outputting of fluid concentrations Many applications use density as a key measured value for monitoring quality or controlling processes. The device measures the density of the fluid as standard and makes this value available to the control system. The "Special Density" application package offers high-precision density measurement over a wide density and temperature range particularly for applications subject to varying process conditions. The observed density is converted to the concentration of a substance of a binary mixture using the "Concentration Measurement" application package:</p> <ul style="list-style-type: none"> ▪ Choice of predefined fluids (e.g. various sugar solutions, acids, alkalis, salts, ethanol etc.) ▪ Common or user-defined units (°Brix, °Plato, % mass, % volume, mol/l etc.) for standard applications. ▪ Concentration calculation from user-defined tables.

Petroleum

Package	Description
Petroleum	<p>The most important parameters for the Oil & Gas Industry can be calculated and displayed with this application package.</p> <ul style="list-style-type: none"> ▪ Corrected volume flow and calculated reference density in accordance with the "API Manual of Petroleum Measurement Standards, Chapter 11.1" ▪ Water content, based on density measurement ▪ Weighted mean of the density and temperature

16.14 Accessories

 Overview of accessories available for order →  229

16.15 Supplementary documentation

 For an overview of the scope of the associated Technical Documentation, refer to the following:

- The *W@M Device Viewer* : Enter the serial number from the nameplate (www.endress.com/deviceviewer)
- The *Endress+Hauser Operations App*: Enter the serial number from the nameplate or scan the 2-D matrix code (QR code) on the nameplate.

Standard documentation

Brief Operating Instructions

Brief Operating Instructions for the sensor

Measuring device	Documentation code
Proline Promass F	KA01261D

Brief Operating Instructions for transmitter

Measuring device	Documentation code
Proline 500 – digital	KA01346D
Proline 500	KA01347D

Technical Information

Measuring device	Documentation code
Promass F 500	TI01222D

Description of Device Parameters

Measuring device	Documentation code
Promass 500	GP01120D

Device-dependent
additional documentation

Safety instructions



Safety instructions for electrical equipment for hazardous areas.

Contents	Documentation code Measuring device
ATEX/IECEX Ex i	XA01473D
ATEX/IECEX Ex ec	XA01474D
cCSAus IS	XA01475D
cCSAus Ex i	XA01509D
cCSAus Ex nA	XA01510D
INMETRO Ex i	XA01476D
INMETRO Ex ec	XA01477D
NEPSI Ex i	XA01478D
NEPSI Ex nA	XA01479D

Special Documentation

Contents	Documentation code
Information on the Pressure Equipment Directive	SD01614D
Radio approvals for WLAN interface for A309/A310 display module	SD01793D
Web server	SD01970D
Heartbeat Technology	SD01983D
Concentration measurement	SD02006D
Petroleum	SD02012D

Installation Instructions

Contents	Comment
Installation instructions for spare part sets and accessories	<ul style="list-style-type: none"> ▪ Access the overview of all the available spare part sets via <i>W@M Device Viewer</i> →  227 ▪ Accessories available for order with Installation Instructions →  229

Index

0 ... 9

3-A approval 259

A

Access authorization to parameters
 Read access 81
 Write access 81
 Access code 81
 Incorrect input 81
 Accuracy 241
 Adapting the diagnostic behavior 205
 Additional certification 260
 Ambient temperature
 Influence 244
 Application 232
 Application packages 261
 Applicator 233
 Approvals 259

C

C-Tick symbol 259
 Cable entries
 Technical data 241
 Cable entry
 Degree of protection 67
 CE mark 11, 259
 Certificates 259
 Check
 Installation 35
 Checklist
 Post-connection check 67
 Post-installation check 35
 Cleaning
 Cleaning in place (CIP) 226
 Exterior cleaning 226
 Interior cleaning 226
 Sterilization in place (SIP) 226
 Climate class 247
 Commissioning 113
 Advanced settings 154
 Configuring the measuring device 114
 Connecting cable 36
 Connecting the connecting cable
 Proline 500 – digital transmitter 46
 Proline 500 terminal assignment 52
 Proline 500 transmitter 55
 Sensor connection housing, Proline 500 52
 Sensor connection housing, Proline 500 - digital 42
 Terminal assignment of Proline 500 - digital 42
 Connecting the measuring device
 Proline 500 52
 Proline 500 – digital 42
 Connecting the signal cable/supply voltage cable
 Proline 500 – digital transmitter 47
 Connecting the signal cables 56
 Connecting the supply voltage cables 56

Connection

 see Electrical connection

Connection preparations 41
 Connection tools 36
 Context menu
 Calling up 77
 Closing 77
 Explanation 77
 Current consumption 241
 Cyclic data transmission 97

D

Declaration of Conformity 11
 Define access code 177, 178
 Degree of protection 67, 247
 Density 249
 Design fundamentals
 Maximum measured error 246
 Repeatability 246
 Designated use 10
 Device components 15
 Device description files 96
 Device documentation
 Supplementary documentation 8
 Device locking, status 181
 Device name
 Sensor 20
 Transmitter 18
 Device repair 227
 Device revision 96
 Device type ID 96
 DeviceCare 95
 Device description file 96
 Diagnostic behavior
 Explanation 201
 Symbols 201
 Diagnostic information
 Communication interface 205
 Design, description 201, 204
 DeviceCare 203
 FieldCare 203
 Light emitting diodes 197
 Onsite display 200
 Overview 206
 Remedial measures 206
 Web browser 202
 Diagnostic list 220
 Diagnostic message 200
 Diagnostics
 Symbols 200
 DIP switch
 see Write protection switch
 Direct access 79
 Direct access code 73
 Disabling write protection 177

- Display
 - see Onsite display
- Display area
 - For operational display 72
 - In the navigation view 74
- Display values
 - For locking status 181
- Disposal 228
- Document
 - Function 6
 - Symbols used 6
- Document function 6
- Down pipe 24
- E**
- Editing view 75
 - Input screen 76
 - Using operating elements 75, 76
- EHDEG-certified 259
- Electrical connection
 - Degree of protection 67
 - Measuring device 36
 - Operating tools
 - Via Ethernet network 90
 - Via service interface (CDI-RJ45) 91
 - Via WLAN interface 92
 - RSLogix 5000 90
 - Web server 91
 - WLAN interface 92
- Electromagnetic compatibility 248
- Electronics module 15
- Enabling write protection 177
- Enabling/disabling the keypad lock 82
- Endress+Hauser services
 - Maintenance 226
 - Repair 227
- Environment
 - Impact resistance 248
 - Mechanical load 248
 - Shock resistance 248
 - Storage temperature 247
 - Vibration resistance 247
- Error messages
 - see Diagnostic messages
- EtherNet/IP
 - Diagnostic information 205
- EtherNet/IP certification 260
- Event list 220
- Event logbook 220
- Ex approval 259
- Extended order code
 - Sensor 20
 - Transmitter 18
- Exterior cleaning 226
- F**
- FDA 259
- Field of application
 - Residual risks 11
- FieldCare 94
 - Device description file 96
 - Establishing a connection 94
 - Function 94
 - User interface 95
- Filtering the event logbook 221
- Firmware
 - Release date 96
 - Version 96
- Firmware history 225
- Fix assembly 205
- Flow direction 24, 30
- Flow limit 251
- Food Contact Materials Regulation 259
- Function check 113
- Functions
 - see Parameter
- G**
- Galvanic isolation 240
- H**
- Hardware write protection 178
- Help text
 - Calling up 80
 - Closing 80
 - Explanation 80
- HistoROM 170
- I**
- Identifying the measuring device 17
- Impact resistance 248
- Incoming acceptance 17
- Influence
 - Ambient temperature 244
 - Medium pressure 245
 - Medium temperature 244
- Information on the document 6
- Inlet runs 25
- Input 233
- Inspection
 - Received goods 17
- Inspection check
 - Connection 67
- Installation 23
- Installation conditions
 - Down pipe 24
 - Inlet and outlet runs 25
 - Installation dimensions 25
 - Mounting location 23
 - Orientation 24
 - Rupture disk 28
 - Sensor heating 27
 - System pressure 26
 - Thermal insulation 26
 - Vibrations 28
- Installation dimensions 25
- Interior cleaning 226

- L**
- Languages, operation options 255
 - Line recorder 188
 - Local display
 - Navigation view 73
 - see Operational display
 - Low flow cut off 240
- M**
- Main electronics module 15
 - Maintenance tasks 226
 - Managing the device configuration 170
 - Manufacturer ID 96
 - Manufacturing date 18, 20
 - Materials 252
 - Maximum measured error 242
 - Measured values
 - see Process variables
 - Measuring and test equipment 226
 - Measuring device
 - Configuration 114
 - Conversion 227
 - Disposal 228
 - Mounting the sensor 30
 - Preparing for electrical connection 41
 - Preparing for mounting 30
 - Removing 228
 - Repairs 227
 - Structure 15
 - Switch-on 113
 - Measuring principle 232
 - Measuring range
 - Calculation example for gas 234
 - For gases 233
 - For liquids 233
 - Measuring range, recommended 251
 - Measuring system 232
 - Mechanical load 248
 - Medium pressure
 - Influence 245
 - Medium temperature
 - Influence 244
 - Menu
 - Diagnostics 219
 - Setup 115
 - Menus
 - For measuring device configuration 114
 - For specific settings 154
 - Mounting dimensions
 - see Installation dimensions
 - Mounting location 23
 - Mounting preparations 30
 - Mounting tools 30
- N**
- Nameplate
 - Sensor 20
 - Transmitter 18
 - Navigation path (navigation view) 73
 - Navigation view
 - In the submenu 73
 - In the wizard 73
 - Numeric editor 75
- O**
- Onsite display 255
 - Numeric editor 75
 - see Diagnostic message
 - see In alarm condition
 - Text editor 75
 - Operable flow range 234
 - Operating elements 77, 201
 - Operating keys
 - see Operating elements
 - Operating menu
 - Menus, submenus 69
 - Structure 69
 - Submenus and user roles 70
 - Operating philosophy 70
 - Operation 181
 - Operation options 68
 - Operational display 71
 - Operational safety 11
 - Order code 18, 20
 - Orientation (vertical, horizontal) 24
 - Outlet runs 25
 - Output 236
 - Output signal 236
- P**
- Packaging disposal 23
 - Parameter
 - Changing 80
 - Entering values or text 80
 - Parameter settings
 - Administration (Submenu) 173
 - Advanced setup (Submenu) 155
 - Calculated values (Submenu) 155
 - Communication (Submenu) 117
 - Configuration backup (Submenu) 170
 - Current input 121
 - Current input (Wizard) 121
 - Current input 1 to n (Submenu) 184
 - Current output 123
 - Current output (Wizard) 123
 - Data logging (Submenu) 188
 - Define access code (Wizard) 172
 - Device information (Submenu) 223
 - Diagnostics (Menu) 219
 - Display (Submenu) 159
 - Display (Wizard) 141
 - I/O configuration 120
 - I/O configuration (Submenu) 120
 - Low flow cut off (Wizard) 152
 - Measured variables (Submenu) 182
 - Partially filled pipe detection (Wizard) 153
 - Pulse/frequency/switch output 128

- Pulse/frequency/switch output (Wizard) 128, 130, 136
- Pulse/frequency/switch output 1 to n (Submenu) 186
- Relay output 138
- Relay output 1 to n (Submenu) 186
- Relay output 1 to n (Wizard) 138
- Reset access code (Submenu) 173
- Select medium (Wizard) 119
- Sensor adjustment (Submenu) 156
- Setup (Menu) 115
- Simulation (Submenu) 173
- Status input 122
- Status input (Submenu) 122
- Status input 1 to n (Submenu) 184
- System units (Submenu) 115
- Totalizer (Submenu) 183
- Totalizer 1 to n (Submenu) 157
- Totalizer handling (Submenu) 187
- Value current output 1 to n (Submenu) 185
- Web server (Submenu) 89
- WLAN settings (Wizard) 169
- Zero point adjustment (Submenu) 157
- Performance characteristics 241
- Pharmaceutical compatibility 259
- Post-connection check (checklist) 67
- Post-installation check 113
- Post-installation check (checklist) 35
- Potential equalization 60
- Power consumption 241
- Power supply failure 241
- Pressure Equipment Directive 260
- Pressure loss 251
- Pressure-temperature ratings 249
- Process connections 255
- Process variables
 - Calculated 233
 - Measured 233
- Product safety 11
- Proline 500 – digital transmitter
 - Connecting the signal cable/supply voltage cable . . 47
- Proline 500 connecting cable terminal assignment
 - Sensor connection housing 52
- Protecting parameter settings 177
- R**
- Radio approval 260
- Read access 81
- Reading measured values 181
- Reading out diagnostic information, EtherNet/IP . . . 205
- Recalibration 226
- reference operating conditions 241
- Registered trademarks 8
- Remedial measures
 - Calling up 202
 - Closing 202
- Remote operation 256
- Repair of a device 227
- Repairs 227
 - Notes 227
- Repeatability 244
- Replacement
 - Device components 227
- Requirements for personnel 10
- Response time 244
- Return 227
- Rupture disk
 - Safety instructions 28
 - Triggering pressure 250
- S**
- Safety 10
- Sanitary compatibility 259
- Secondary containment 249
- Sensor
 - Mounting 30
- Sensor heating 27
- Serial number 18, 20
- Setting the operating language 113
- Settings
 - Adapting the measuring device to the process conditions 187
 - Administration 172
 - Advanced display configurations 159
 - Communication interface 117
 - Current input 121
 - Current output 123
 - Device reset 223
 - Device tag 115
 - I/O configuration 120
 - Low flow cut off 152
 - Managing the device configuration 170
 - Medium 119
 - Onsite display 141
 - Operating language 113
 - Partial filled pipe detection 153
 - Pulse output 128
 - Pulse/frequency/switch output 128, 130
 - Relay output 138
 - Resetting the totalizer 187
 - Sensor adjustment 156
 - Simulation 173
 - Status input 122
 - Switch output 136
 - System units 115
 - Totalizer 157
 - Totalizer reset 187
 - WLAN 169
- Shock resistance 248
- Showing data logging 188
- Signal on alarm 238
- Software release 96
- Spare part 227
- Spare parts 227
- Special connection instructions 61
- Standards and guidelines 261
- Status area
 - For operational display 71
 - In the navigation view 73

- Status signals 200, 203
 - Storage conditions 22
 - Storage temperature 22
 - Storage temperature range 247
 - Structure
 - Measuring device 15
 - Operating menu 69
 - Submenu
 - Administration 172, 173
 - Advanced setup 154, 155
 - Calculated values 155
 - Communication 117
 - Configuration backup 170
 - Current input 1 to n 184
 - Data logging 188
 - Device information 223
 - Display 159
 - Event list 220
 - I/O configuration 120
 - Input values 184
 - Measured values 181
 - Measured variables 182
 - Output values 185
 - Overview 70
 - Process variables 155
 - Pulse/frequency/switch output 1 to n 186
 - Relay output 1 to n 186
 - Reset access code 173
 - Sensor adjustment 156
 - Simulation 173
 - Status input 122
 - Status input 1 to n 184
 - System units 115
 - Totalizer 183
 - Totalizer 1 to n 157
 - Totalizer handling 187
 - Value current output 1 to n 185
 - Web server 89
 - Zero point adjustment 157
 - Supply voltage 241
 - Surface roughness 255
 - Switch output 237
 - Symbols
 - Controlling data entries 76
 - For communication 71
 - For diagnostic behavior 71
 - For locking 71
 - For measured variable 72
 - For measurement channel number 72
 - For menus 74
 - For parameters 74
 - For status signal 71
 - For submenu 74
 - For wizard 74
 - In the status area of the local display 71
 - Input screen 76
 - Operating elements 75
 - System design
 - Measuring system 232
 - see Measuring device design
 - System file
 - Release date 96
 - Source 96
 - Version 96
 - System integration 96
 - System pressure 26
- T**
- Technical data, overview 232
 - Temperature range
 - Ambient temperature range for display 255
 - Medium temperature 248
 - Storage temperature 22
 - Terminal assignment 40
 - Terminal assignment of connecting cable for Proline 500- digital
 - Sensor connection housing 42
 - terminals 241
 - Tests and certificates 260
 - Text editor 75
 - Thermal insulation 26
 - Tool tip
 - see Help text
 - Tools
 - Electrical connection 36
 - For mounting 30
 - Transport 22
 - Totalizer
 - Configuration 157
 - Transmitter
 - Turning the display module 35
 - Turning the housing 34
 - Transporting the measuring device 22
 - Troubleshooting
 - General 194
 - TSE/BSE certificate of suitability 259
 - Turning the display module 35
 - Turning the electronics housing
 - see Turning the transmitter housing
 - Turning the transmitter housing 34
- U**
- Use of the measuring device
 - Borderline cases 10
 - Incorrect use 10
 - see Designated use
 - User interface
 - Current diagnostic event 219
 - Previous diagnostic event 219
 - User roles 70
 - USP Class VI 259
- V**
- Version data for the device 96
 - Vibration resistance 247
 - Vibrations 28
- W**
- W@M 226, 227

- W@M Device Viewer 17, 227
- Weight
 - SI units 251
 - Transport (notes) 22
 - US units 252
- Wizard
 - Current input 121
 - Current output 123
 - Define access code 172
 - Display 141
 - Low flow cut off 152
 - Partially filled pipe detection 153
 - Pulse/frequency/switch output 128, 130, 136
 - Relay output 1 to n 138
 - Select medium 119
 - WLAN settings 169
- WLAN settings 169
- Workplace safety 11
- Write access 81
- Write protection
 - Via access code 177
 - Via write protection switch 178
- Write protection switch 178

www.addresses.endress.com
