

Operating Instructions Proline Promag P 500 EtherNet/IP

Electromagnetic flowmeter

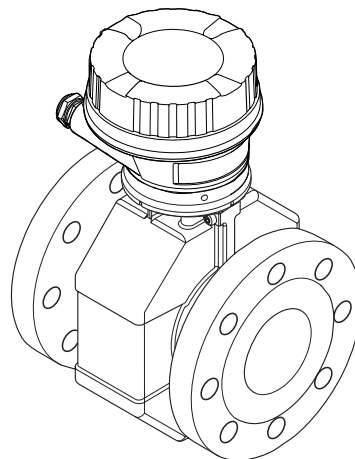
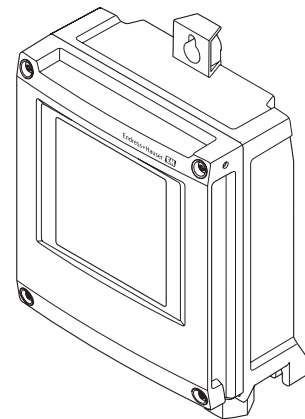
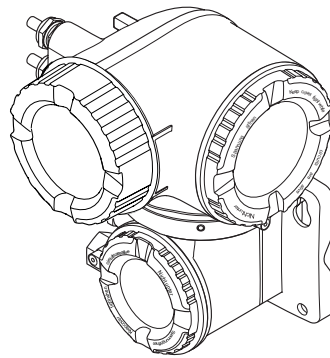

- Make sure the document is stored in a safe place such that it is always available when working on or with the device.
- To avoid danger to individuals or the facility, read the "Basic safety instructions" section carefully, as well as all other safety instructions in the document that are specific to working procedures.
- The manufacturer reserves the right to modify technical data without prior notice. Your Endress+Hauser Sales Center will supply you with current information and updates to these instructions.

Table of contents

1	About this document	6	5.3	Packaging disposal	22
1.1	Document function	6	6	Installation	23
1.2	Symbols used	6	6.1	Installation conditions	23
1.2.1	Safety symbols	6	6.1.1	Mounting position	23
1.2.2	Electrical symbols	6	6.1.2	Requirements from environment and process	26
1.2.3	Communication symbols	6	6.1.3	Special mounting instructions	28
1.2.4	Tool symbols	7	6.2	Mounting the measuring device	28
1.2.5	Symbols for certain types of information	7	6.2.1	Required tools	28
1.2.6	Symbols in graphics	7	6.2.2	Preparing the measuring device	29
1.3	Documentation	8	6.2.3	Mounting the sensor	29
1.3.1	Standard documentation	8	6.2.4	Mounting the transmitter housing: Proline 500 – digital	33
1.3.2	Supplementary device-dependent documentation	8	6.2.5	Mounting the transmitter housing: Proline 500	35
1.4	Registered trademarks	8	6.2.6	Turning the transmitter housing: Proline 500	36
2	Basic safety instructions	9	6.2.7	Turning the display module: Proline 500	37
2.1	Requirements for the personnel	9	6.3	Post-installation check	37
2.2	Designated use	9	7	Electrical connection	38
2.3	Workplace safety	10	7.1	Connection conditions	38
2.4	Operational safety	10	7.1.1	Required tools	38
2.5	Product safety	10	7.1.2	Requirements for connecting cable	38
2.6	IT security	11	7.1.3	Terminal assignment	41
2.7	Device-specific IT security	11	7.1.4	Device plugs available	42
2.7.1	Protecting access via hardware write protection	11	7.1.5	Pin assignment of device plug	42
2.7.2	Protecting access via a password	11	7.1.6	Preparing the measuring device	42
2.7.3	Access via fieldbus	12	7.1.7	Preparing the connecting cable: Proline 500 – digital	44
2.7.4	Access via Web server	12	7.1.8	Preparing the connecting cable: Proline 500	44
2.7.5	Access via CDI-RJ45 service interface	12	7.2	Connecting the measuring device: Proline 500 - digital	46
3	Product description	14	7.2.1	Connecting the connecting cable	46
3.1	Product design	14	7.2.2	Connecting the transmitter	49
3.1.1	Proline 500 – digital	14	7.2.3	Integrating the transmitter into a network	52
3.1.2	Proline 500	15	7.3	Connecting the measuring device: Proline 500	54
4	Incoming acceptance and product identification	16	7.3.1	Connecting the connecting cable	54
4.1	Incoming acceptance	16	7.3.2	Connecting the transmitter	57
4.2	Product identification	16	7.3.3	Integrating the transmitter into a network	60
4.2.1	Transmitter nameplate	17	7.4	Ensure potential equalization	61
4.2.2	Sensor nameplate	19	7.4.1	Requirements	61
4.2.3	Symbols on measuring device	20	7.4.2	Connection example, standard scenario	62
5	Storage and transport	21	7.4.3	Connection example in special situations	62
5.1	Storage conditions	21	7.5	Special connection instructions	64
5.2	Transporting the product	21	7.5.1	Connection examples	64
5.2.1	Measuring devices without lifting lugs	21			
5.2.2	Measuring devices with lifting lugs	22			
5.2.3	Transporting with a fork lift	22			

7.6	Hardware settings	67	10	Commissioning	109
7.6.1	Setting the device address	67	10.1	Function check	109
7.6.2	Activating the default IP address	68	10.2	Switching on the measuring device	109
7.7	Ensuring the degree of protection	70	10.3	Connecting via FieldCare	109
7.8	Post-connection check	70	10.4	Setting the operating language	109
8	Operation options	71	10.5	Configuring the measuring device	110
8.1	Overview of operation options	71	10.5.1	Defining the tag name	111
8.2	Structure and function of the operating menu	72	10.5.2	Setting the system units	111
8.2.1	Structure of the operating menu	72	10.5.3	Configuring the communication interface	113
8.2.2	Operating philosophy	73	10.5.4	Displaying the I/O configuration	114
8.3	Access to the operating menu via the local display	74	10.5.5	Configuring the current input	115
8.3.1	Operational display	74	10.5.6	Configuring the status input	116
8.3.2	Navigation view	75	10.5.7	Configuring the current output	116
8.3.3	Editing view	77	10.5.8	Configuring the pulse/frequency/switch output	119
8.3.4	Operating elements	79	10.5.9	Configuring the relay output	125
8.3.5	Opening the context menu	79	10.5.10	Configuring the local display	126
8.3.6	Navigating and selecting from list	81	10.5.11	Configuring the low flow cut off	129
8.3.7	Calling the parameter directly	81	10.5.12	Configuring empty pipe detection	130
8.3.8	Calling up help text	82	10.6	Advanced settings	131
8.3.9	Changing the parameters	82	10.6.1	Using the parameter to enter the access code	132
8.3.10	User roles and related access authorization	83	10.6.2	Carrying out a sensor adjustment	132
8.3.11	Disabling write protection via access code	83	10.6.3	Configuring the totalizer	132
8.3.12	Enabling and disabling the keypad lock	84	10.6.4	Carrying out additional display configurations	134
8.4	Access to the operating menu via the Web browser	84	10.6.5	Performing electrode cleaning	137
8.4.1	Function range	84	10.6.6	WLAN configuration	138
8.4.2	Prerequisites	85	10.6.7	Configuration management	140
8.4.3	Establishing a connection	86	10.6.8	Using parameters for device administration	141
8.4.4	Logging on	89	10.7	Simulation	143
8.4.5	User interface	90	10.8	Protecting settings from unauthorized access	146
8.4.6	Disabling the Web server	91	10.8.1	Write protection via access code	146
8.4.7	Logging out	91	10.8.2	Write protection via write protection switch	147
8.5	Access to the operating menu via the operating tool	92	11	Operation	150
8.5.1	Connecting the operating tool	92	11.1	Reading the device locking status	150
8.5.2	FieldCare	96	11.2	Adjusting the operating language	150
8.5.3	DeviceCare	97	11.3	Configuring the display	150
9	System integration	98	11.4	Reading measured values	150
9.1	Overview of device description files	98	11.4.1	"Process variables" submenu	151
9.1.1	Current version data for the device	98	11.4.2	"Totalizer" submenu	152
9.1.2	Operating tools	98	11.4.3	"Input values" submenu	152
9.2	Overview of system files	98	11.4.4	Output values	154
9.3	Integrating the measuring device in the system	99	11.5	Adapting the measuring device to the process conditions	156
9.4	Cyclic data transmission	99	11.6	Performing a totalizer reset	156
9.4.1	Block model	99	11.6.1	Function scope of the "Control Totalizer" parameter	156
9.4.2	Input and output groups	100	11.6.2	Function scope of the "Reset all totalizers" parameter	157
9.5	Diagnostic information via EtherNet/IP	106	11.7	Showing data logging	157

12	Diagnostics and troubleshooting ..	160	15	Accessories	193
12.1	General troubleshooting	160	15.1	Device-specific accessories	193
12.2	Diagnostic information via light emitting diodes	163	15.1.1	For the transmitter	193
12.2.1	Transmitter	163	15.1.2	For the sensor	194
12.2.2	Sensor connection housing	165	15.2	Communication-specific accessories	194
12.3	Diagnostic information on local display	166	15.3	Service-specific accessories	195
12.3.1	Diagnostic message	166	15.4	System components	195
12.3.2	Calling up remedial measures	168	16	Technical data	196
12.4	Diagnostic information in the Web browser	168	16.1	Application	196
12.4.1	Diagnostic options	168	16.2	Function and system design	196
12.4.2	Calling up remedy information	169	16.3	Input	196
12.5	Diagnostic information in DeviceCare or FieldCare	169	16.4	Output	199
12.5.1	Diagnostic options	169	16.5	Power supply	203
12.5.2	Calling up remedy information	170	16.6	Performance characteristics	204
12.6	Diagnostic information via communication interface	171	16.7	Installation	205
12.6.1	Reading out diagnostic information	171	16.8	Environment	205
12.7	Adapting the diagnostic information	171	16.9	Process	206
12.7.1	Adapting the diagnostic behavior	171	16.10	Mechanical construction	210
12.8	Overview of diagnostic information	172	16.11	Operability	215
12.8.1	Diagnostic of sensor	172	16.12	Certificates and approvals	218
12.8.2	Diagnostic of electronic	173	16.13	Application packages	220
12.8.3	Diagnostic of configuration	177	16.14	Accessories	221
12.8.4	Diagnostic of process	182	16.15	Supplementary documentation	221
12.9	Pending diagnostic events	184	Index	223	
12.10	Diagnostic list	185			
12.11	Event logbook	185			
12.11.1	Reading out the event logbook	185			
12.11.2	Filtering the event logbook	186			
12.11.3	Overview of information events	186			
12.12	Resetting the measuring device	187			
12.12.1	Function scope of the "Device reset" parameter	188			
12.13	Device information	188			
12.14	Firmware history	189			
13	Maintenance	190			
13.1	Maintenance tasks	190			
13.1.1	Exterior cleaning	190			
13.1.2	Interior cleaning	190			
13.1.3	Replacing seals	190			
13.2	Measuring and test equipment	190			
13.3	Endress+Hauser services	190			
14	Repairs	191			
14.1	General notes	191			
14.1.1	Repair and conversion concept	191			
14.1.2	Notes for repair and conversion	191			
14.2	Spare parts	191			
14.3	Endress+Hauser services	191			
14.4	Return	191			
14.5	Disposal	192			
14.5.1	Removing the measuring device	192			
14.5.2	Disposing of the measuring device	192			





1 About this document

1.1 Document function





These Operating Instructions contain all the information that is required in various phases of the life cycle of the device: from product identification, incoming acceptance and storage, to mounting, connection, operation and commissioning through to troubleshooting, maintenance and disposal.

1.2 Symbols used



1.2.1 Safety symbols



Symbol	Meaning
	DANGER! This symbol alerts you to a dangerous situation. Failure to avoid this situation will result in serious or fatal injury.
	WARNING! This symbol alerts you to a dangerous situation. Failure to avoid this situation can result in serious or fatal injury.
	CAUTION! This symbol alerts you to a dangerous situation. Failure to avoid this situation can result in minor or medium injury.
	NOTE! This symbol contains information on procedures and other facts which do not result in personal injury.

1.2.2 Electrical symbols



Symbol	Meaning
	Direct current
	Alternating current
	Direct current and alternating current
	Ground connection A grounded terminal which, as far as the operator is concerned, is grounded via a grounding system.
	Protective Earth (PE) A terminal which must be connected to ground prior to establishing any other connections. The ground terminals are situated inside and outside the device: <ul style="list-style-type: none"> ▪ Inner ground terminal: Connects the protective earth to the mains supply. ▪ Outer ground terminal: Connects the device to the plant grounding system.

1.2.3 Communication symbols













Symbol	Meaning
	Wireless Local Area Network (WLAN) Communication via a wireless, local network.
	LED Light emitting diode is off.

Symbol	Meaning
	LED Light emitting diode is on.
	LED Light emitting diode is flashing.

1.2.4 Tool symbols



Symbol	Meaning
	Torx screwdriver
	Phillips head screwdriver
	Open-ended wrench

1.2.5 Symbols for certain types of information

Symbol	Meaning
	Permitted Procedures, processes or actions that are permitted.
	Preferred Procedures, processes or actions that are preferred.
	Forbidden Procedures, processes or actions that are forbidden.
	Tip Indicates additional information.
	Reference to documentation.
	Reference to page.
	Reference to graphic.
	Notice or individual step to be observed.
	Series of steps.
	Result of a step.
	Help in the event of a problem.
	Visual inspection.

1.2.6 Symbols in graphics



Symbol	Meaning
1, 2, 3, ...	Item numbers
1, 2, 3, ...	Series of steps
A, B, C, ...	Views
A-A, B-B, C-C, ...	Sections
	Hazardous area

Symbol	Meaning
	Safe area (non-hazardous area)
	Flow direction

1.3 Documentation

 For an overview of the scope of the associated Technical Documentation, refer to the following:

- The *W@M Device Viewer* : Enter the serial number from the nameplate (www.endress.com/deviceviewer)
- The *Endress+Hauser Operations App*: Enter the serial number from the nameplate or scan the 2-D matrix code (QR code) on the nameplate.

 For a detailed list of the individual documents along with the documentation code →  221

1.3.1 Standard documentation

Document type	Purpose and content of the document
Technical Information	Planning aid for your device The document contains all the technical data on the device and provides an overview of the accessories and other products that can be ordered for the device.
Sensor Brief Operating Instructions	Guides you quickly to the 1st measured value - Part 1 The Sensor Brief Operating Instructions are aimed at specialists with responsibility for installing the measuring device. <ul style="list-style-type: none"> ▪ Incoming acceptance and product identification ▪ Storage and transport ▪ Installation
Transmitter Brief Operating Instructions	Guides you quickly to the 1st measured value - Part 2 The Transmitter Brief Operating Instructions are aimed at specialists with responsibility for commissioning, configuring and parameterizing the measuring device (until the first measured value). <ul style="list-style-type: none"> ▪ Product description ▪ Installation ▪ Electrical connection ▪ Operation options ▪ System integration ▪ Commissioning ▪ Diagnostic information
Description of Device Parameters	Reference for your parameters The document provides a detailed explanation of each individual parameter in the Expert operating menu. The description is aimed at those who work with the device over the entire life cycle and perform specific configurations.

1.3.2 Supplementary device-dependent documentation

Additional documents are supplied depending on the device version ordered: Always comply strictly with the instructions in the supplementary documentation. The supplementary documentation is an integral part of the device documentation.

1.4 Registered trademarks

EtherNet/IP™
Trademark of ODVA, Inc.

2 Basic safety instructions

2.1 Requirements for the personnel

The personnel for installation, commissioning, diagnostics and maintenance must fulfill the following requirements:

- ▶ Trained, qualified specialists must have a relevant qualification for this specific function and task.
- ▶ Are authorized by the plant owner/operator.
- ▶ Are familiar with federal/national regulations.
- ▶ Before starting work, read and understand the instructions in the manual and supplementary documentation as well as the certificates (depending on the application).
- ▶ Follow instructions and comply with basic conditions.

The operating personnel must fulfill the following requirements:

- ▶ Are instructed and authorized according to the requirements of the task by the facility's owner-operator.
- ▶ Follow the instructions in this manual.

2.2 Designated use

Application and media

The measuring device described in these Brief Operating Instructions is intended only for flow measurement of liquids with a minimum conductivity of 5 $\mu\text{S}/\text{cm}$.

Depending on the version ordered, the measuring device can also measure potentially explosive, flammable, poisonous and oxidizing media.

Measuring devices for use in hazardous areas, in hygienic applications or where there is an increased risk due to process pressure, are labeled accordingly on the nameplate.

To ensure that the measuring device remains in proper condition for the operation time:

- ▶ Keep within the specified pressure and temperature range.
- ▶ Only use the measuring device in full compliance with the data on the nameplate and the general conditions listed in the Operating Instructions and supplementary documentation.
- ▶ Based on the nameplate, check whether the ordered device is permitted for the intended use in the hazardous area (e.g. explosion protection, pressure vessel safety).
- ▶ Use the measuring device only for media to which the process-wetted materials are sufficiently resistant.
- ▶ If the measuring device is not operated at atmospheric temperature, compliance with the relevant basic conditions specified in the associated device documentation is absolutely essential: "Documentation" section →  8.
- ▶ Protect the measuring device permanently against corrosion from environmental influences.

Incorrect use

Non-designated use can compromise safety. The manufacturer is not liable for damage caused by improper or non-designated use.

WARNING

Danger of breakage due to corrosive or abrasive fluids!

- ▶ Verify the compatibility of the process fluid with the sensor material.
- ▶ Ensure the resistance of all fluid-wetted materials in the process.
- ▶ Keep within the specified pressure and temperature range.

NOTICE**Verification for borderline cases:**

- ▶ For special fluids and fluids for cleaning, Endress+Hauser is glad to provide assistance in verifying the corrosion resistance of fluid-wetted materials, but does not accept any warranty or liability as minute changes in the temperature, concentration or level of contamination in the process can alter the corrosion resistance properties.

Residual risks**⚠ WARNING**

The electronics and the medium may cause the surfaces to heat up. This presents a burn hazard!

- ▶ For elevated fluid temperatures, ensure protection against contact to prevent burns.

2.3 Workplace safety

For work on and with the device:

- ▶ Wear the required personal protective equipment according to federal/national regulations.

For welding work on the piping:

- ▶ Do not ground the welding unit via the measuring device.

If working on and with the device with wet hands:

- ▶ Due to the increased risk of electric shock, gloves must be worn.

2.4 Operational safety

Risk of injury.

- ▶ Operate the device in proper technical condition and fail-safe condition only.
- ▶ The operator is responsible for interference-free operation of the device.

Conversions to the device

Unauthorized modifications to the device are not permitted and can lead to unforeseeable dangers.

- ▶ If, despite this, modifications are required, consult with Endress+Hauser.

Repair

To ensure continued operational safety and reliability,

- ▶ Carry out repairs on the device only if they are expressly permitted.
- ▶ Observe federal/national regulations pertaining to repair of an electrical device.
- ▶ Use original spare parts and accessories from Endress+Hauser only.

2.5 Product safety

This measuring device is designed in accordance with good engineering practice to meet state-of-the-art safety requirements, has been tested, and left the factory in a condition in which it is safe to operate.

It meets general safety standards and legal requirements. It also complies with the EU directives listed in the device-specific EU Declaration of Conformity. Endress+Hauser confirms this by affixing the CE mark to the device.





2.6 IT security

We only provide a warranty if the device is installed and used as described in the Operating Instructions. The device is equipped with security mechanisms to protect it against any inadvertent changes to the device settings.

IT security measures in line with operators' security standards and designed to provide additional protection for the device and device data transfer must be implemented by the operators themselves.

2.7 Device-specific IT security

The device offers a range of specific functions to support protective measures on the operator's side. These functions can be configured by the user and guarantee greater in-operation safety if used correctly. An overview of the most important functions is provided in the following section.

Function/interface	Factory setting	Recommendation
Write protection via hardware write protection switch →  11	Not enabled.	Individually following risk assessment.
Access code (also applies for Web server login or FieldCare connection) →  12	Not enabled (0000).	Assign an individual access code during commissioning.
WLAN (order option in display module)	Enabled.	Individually following risk assessment.
WLAN security mode	Enabled (WPA2-PSK)	Do not change.
WLAN passphrase (password) →  12	Serial number	Assign an individual access code during commissioning.
WLAN mode	Access Point	Individually following risk assessment.
Web server →  12	Enabled.	Individually following risk assessment.
CDI-RJ45 service interface →  12	–	Individually following risk assessment.

2.7.1 Protecting access via hardware write protection

Write access to the device parameters via the local display, Web browser or operating tool (e.g. FieldCare, DeviceCare) can be disabled via a write protection switch (DIP switch on the motherboard). When hardware write protection is enabled, only read access to the parameters is possible.

Hardware write protection is disabled when the device is delivered →  147.

2.7.2 Protecting access via a password

Different passwords are available to protect write access to the device parameters or access to the device via the WLAN interface.

- User-specific access code
Protect write access to the device parameters via the local display, Web browser or operating tool (e.g. FieldCare, DeviceCare). Access authorization is clearly regulated through the use of a user-specific access code.
- WLAN passphrase
The network key protects a connection between an operating unit (e.g. notebook or tablet) and the device via the WLAN interface which can be ordered as an option.

User-specific access code

Write access to the device parameters via the local display, Web browser or operating tool (e.g. FieldCare, DeviceCare) can be protected by the modifiable, user-specific access code (→  146).

When the device is delivered, the device does not have an access code and is equivalent to 0000 (open).

WLAN passphrase

A connection between an operating unit (e.g. notebook or tablet) and the device via the WLAN interface (→  94) which can be ordered as an option is protected by the network key. The WLAN authentication of the network key complies with the IEEE 802.11 standard.

When the device is delivered, the network key is pre-defined depending on the device. It can be changed via the **WLAN settings** submenu in the **WLAN passphrase** parameter (→  140).

General notes on the use of passwords

- The access code and network key supplied with the device should be changed during commissioning.
- Follow the general rules for generating a secure password when defining and managing the access code or network key.
- The user is responsible for the management and careful handling of the access code and network key.
- For information on configuring the access code or on what to do if you lose the password, see the "Write protection via access code" section →  146

2.7.3 Access via fieldbus

When communicating via fieldbus, access to the device parameters can be restricted to "Read only" access. The option can be changed in the **Fieldbus writing access** parameter.

This does not affect cyclic measured value transmission to the higher-order system, which is always guaranteed.

 For detailed information, see the "Description of Device Parameters" document pertaining to the device →  221

2.7.4 Access via Web server

The device can be operated and configured via a Web browser with the integrated Web server (→  84). The connection is via the service interface (CDI-RJ45), the connection for EtherNet/IP signal transmission (RJ45 connector) or the WLAN interface.

The Web server is enabled when the device is delivered. The Web server can be disabled if necessary (e.g. after commissioning) via the **Web server functionality** parameter.

The device and status information can be hidden on the login page. This prevents unauthorized access to the information.



 For detailed information, see the "Description of Device Parameters" document pertaining to the device →  221

2.7.5 Access via CDI-RJ45 service interface

The device can be connected to a network via the CDI-RJ45 service interface. Device-specific functions guarantee the secure operation of the device in a network.

It is advisable to take relevant security concepts into consideration, such as those issued by the Federal Office for Information Security. This includes organizational security measures

such as the assignment of access authorization as well as technical measures such as network segmentation.

 The device can be integrated in a ring topology. The device is integrated via the terminal connection for signal transmission (output 1) and the connection to the service interface (CDI-RJ45) →  61 or →  53.

3 Product description

The measuring system consists of a transmitter and a sensor. The transmitter and sensor are mounted in physically separate locations. They are interconnected by one or two connecting cable(s).

3.1 Product design

Two versions of the transmitter are available.

3.1.1 Proline 500 – digital

Signal transmission: digital

Order code for "Integrated ISEM electronics", option **A** "Sensor"

For use in applications not required to meet special requirements due to ambient or operating conditions.

As the electronics are located in the sensor, the device is ideal:

For simple transmitter replacement.

- A standard cable can be used as the connecting cable.
- Not sensitive to external EMC interference.

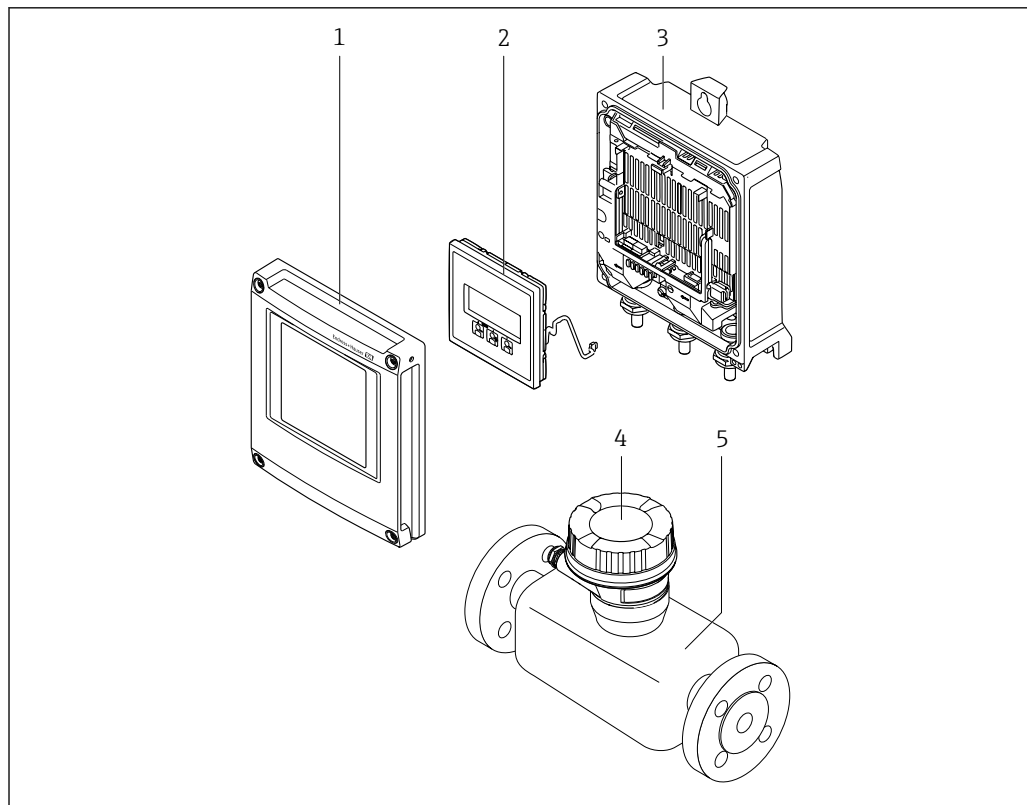

A0029593

1 Important components of a measuring device

- 1 Electronics compartment cover
- 2 Display module
- 3 Transmitter housing
- 4 Sensor connection housing with integrated ISEM electronics: connecting cable connection
- 5 Sensor

3.1.2 Proline 500

Signal transmission: analog

Order code for "Integrated ISEM electronics", option **B** "Transmitter"

For use in applications required to meet special requirements due to ambient or operating conditions.

As the electronics are located in the transmitter, the device is ideal in the event of:

- Sensor operation in underground installations.
- Permanent sensor immersion in water.

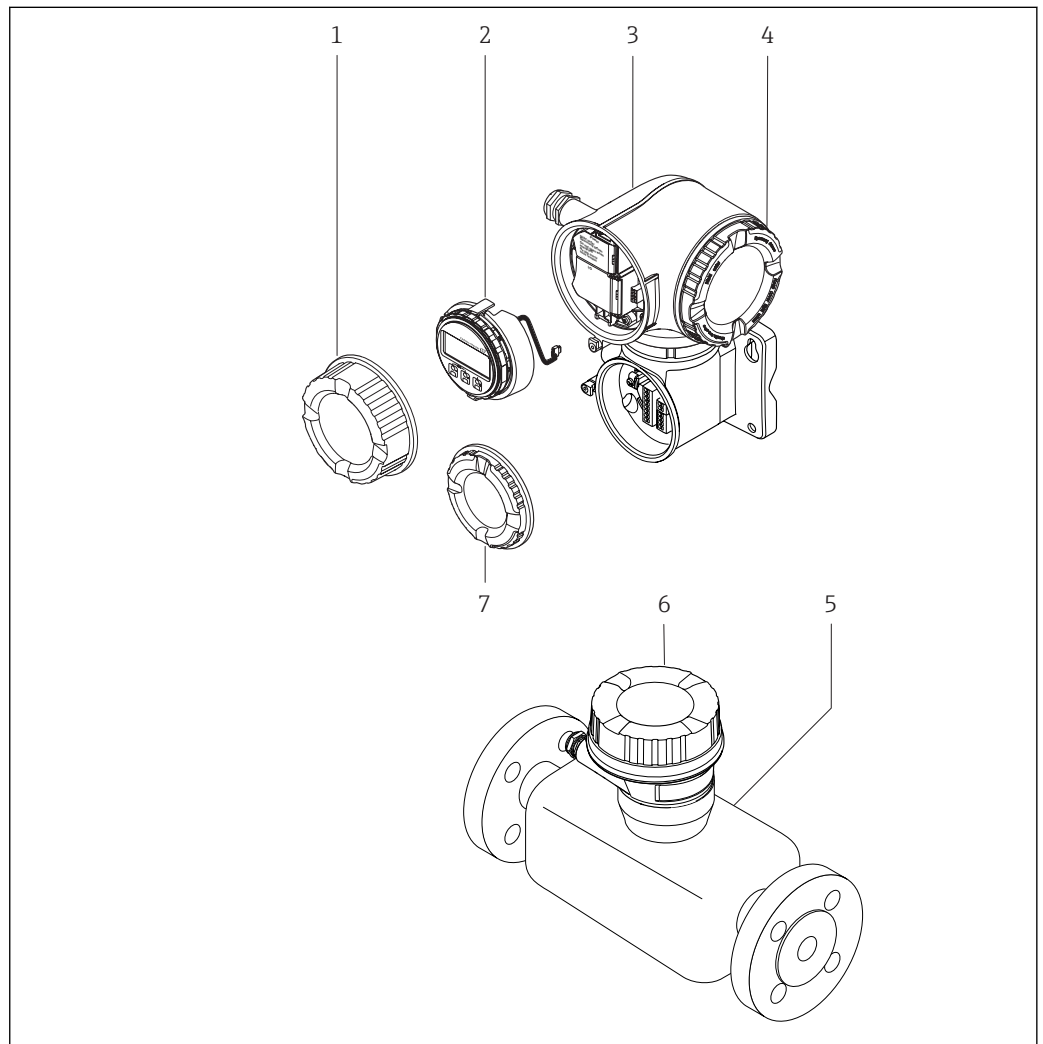

A0029589

2 Important components of a measuring device

- 1 Connection compartment cover
- 2 Display module
- 3 Transmitter housing with integrated ISEM electronics
- 4 Electronics compartment cover
- 5 Sensor
- 6 Sensor connection housing: connecting cable connection
- 7 Connection compartment cover: connecting cable connection

4 Incoming acceptance and product identification

4.1 Incoming acceptance



A0028673

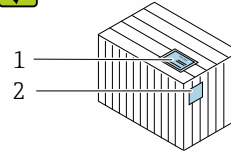
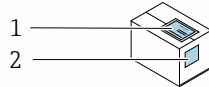

Are the order codes on the delivery note (1) and the product sticker (2) identical?

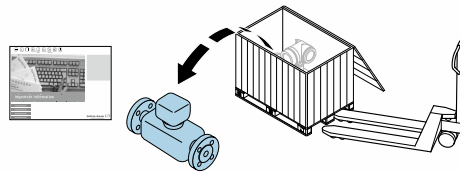

A0028673

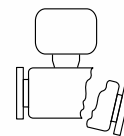
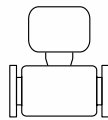

Are the goods undamaged?



A0028673

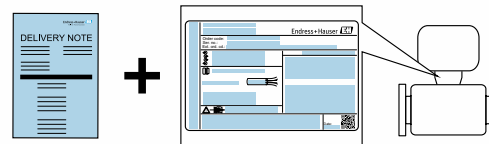

Do the nameplate data match the ordering information on the delivery note?



A0028673



Is the CD-ROM with the Technical Documentation (depends on device version) and documents present?





- If one of the conditions is not satisfied, contact your Endress+Hauser Sales Center.
- Depending on the device version, the CD-ROM might not be part of the delivery! The Technical Documentation is available via the Internet or via the *Endress+Hauser Operations App*, see the "Product identification" section → 17.

4.2 Product identification

The following options are available for identification of the measuring device:

- Nameplate specifications
- Order code with breakdown of the device features on the delivery note
- Enter serial numbers from nameplates in *W@M Device Viewer* (www.endress.com/deviceviewer): All information about the measuring device is displayed.
- Enter the serial number from the nameplates into the *Endress+Hauser Operations App* or scan the 2-D matrix code (QR code) on the nameplate with the *Endress+Hauser Operations App*: all the information for the measuring device is displayed.

For an overview of the scope of the associated Technical Documentation, refer to the following:

- The chapters "Additional standard documentation on the device" →  8 and "Supplementary device-dependent documentation" →  8
- The *W@M Device Viewer*: Enter the serial number from the nameplate (www.endress.com/deviceviewer)
- The *Endress+Hauser Operations App*: Enter the serial number from the nameplate or scan the 2-D matrix code (QR code) on the nameplate.

4.2.1 Transmitter nameplate

Proline 500 – digital

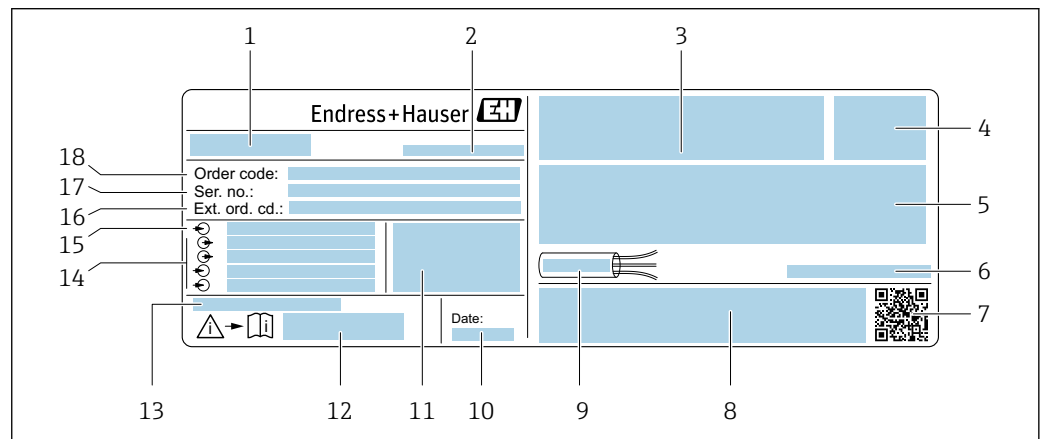

A0029194

 3 Example of a transmitter nameplate

- 1 Name of the transmitter
- 2 Manufacturing location
- 3 Space for approvals: use in hazardous areas
- 4 Degree of protection
- 5 Electrical connection data: available inputs and outputs
- 6 Permitted ambient temperature (T_a)
- 7 2-D matrix code
- 8 Space for approvals and certificates: e.g. CE mark, C-Tick
- 9 Permitted temperature range for cable
- 10 Manufacturing date: year-month
- 11 Firmware version (FW) and device revision (Dev.Rev.) from the factory
- 12 Document number of safety-related supplementary documentation
- 13 Space for additional information in the case of special products
- 14 Available inputs and outputs, supply voltage
- 15 Electrical connection data: supply voltage
- 16 Extended order code (Ext. ord. cd.)
- 17 Serial number (ser. no.)
- 18 Order code

Proline 500

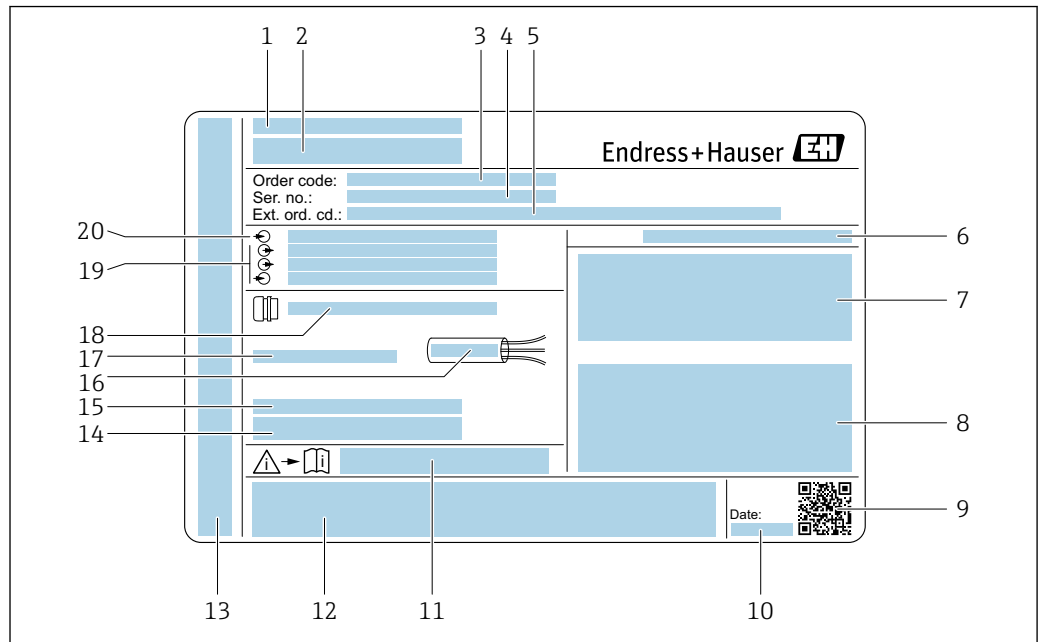

A0029192

4 Example of a transmitter nameplate

- 1 Manufacturing location
- 2 Name of the transmitter
- 3 Order code
- 4 Serial number (ser. no.)
- 5 Extended order code (Ext. ord. cd.)
- 6 Degree of protection
- 7 Space for approvals: use in hazardous areas
- 8 Electrical connection data: available inputs and outputs
- 9 2-D matrix code
- 10 Manufacturing date: year-month
- 11 Document number of safety-related supplementary documentation
- 12 Space for approvals and certificates: e.g. CE mark, C-Tick
- 13 Space for degree of protection of connection and electronics compartment when used in hazardous areas
- 14 Firmware version (FW) and device revision (Dev.Rev.) from the factory
- 15 Space for additional information in the case of special products
- 16 Permitted temperature range for cable
- 17 Permitted ambient temperature (T_a)
- 18 Information on cable gland
- 19 Available inputs and outputs, supply voltage
- 20 Electrical connection data: supply voltage

4.2.2 Sensor nameplate

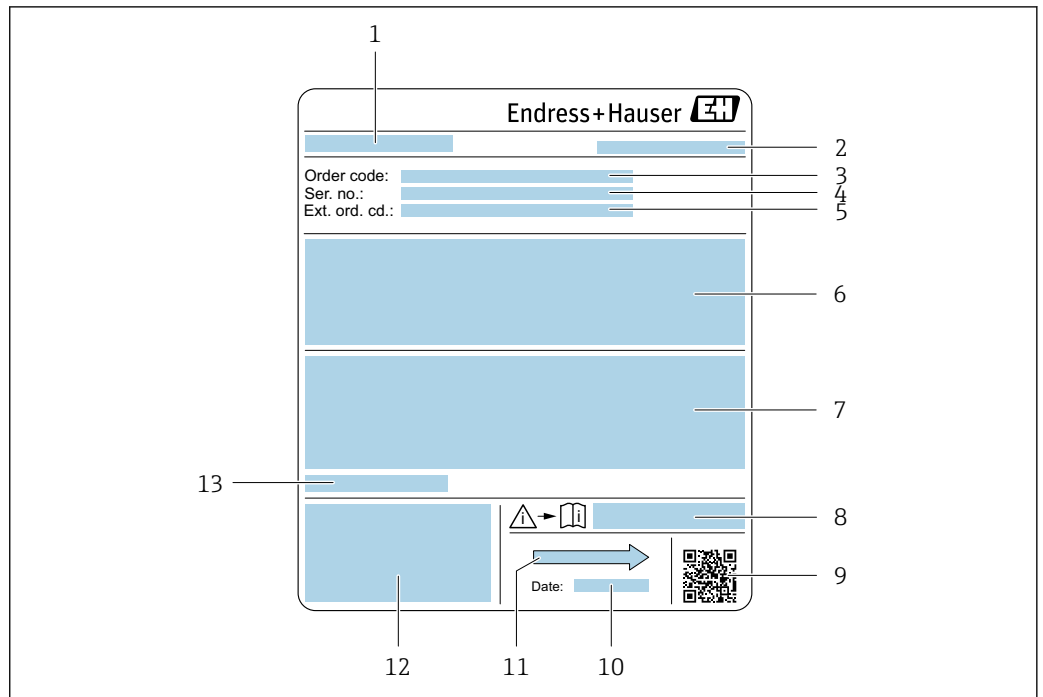

A0029205

5 Example of sensor nameplate

- 1 Name of the sensor
- 2 Manufacturing location
- 3 Order code
- 4 Serial number (ser. no.)
- 5 Extended order code (Ext. ord. cd.)
- 6 Flow; nominal diameter of the sensor; pressure rating; nominal pressure; system pressure; fluid temperature range; material of liner and electrodes
- 7 Approval information for explosion protection, Pressure Equipment Directive and degree of protection
- 8 Document number of safety-related supplementary documentation → 221
- 9 2-D matrix code
- 10 Manufacturing date: year-month
- 11 Flow direction
- 12 CE mark, C-Tick
- 13 Permitted ambient temperature (T_a)



Order code

The measuring device is reordered using the order code.

Extended order code

- The device type (product root) and basic specifications (mandatory features) are always listed.
- Of the optional specifications (optional features), only the safety and approval-related specifications are listed (e.g. LA). If other optional specifications are also ordered, these are indicated collectively using the # placeholder symbol (e.g. #LA#).
- If the ordered optional specifications do not include any safety and approval-related specifications, they are indicated by the + placeholder symbol (e.g. XXXXXX-ABCDE+).

4.2.3 Symbols on measuring device

Symbol	Meaning
	WARNING! This symbol alerts you to a dangerous situation. Failure to avoid this situation can result in serious or fatal injury.
	Reference to documentation Refers to the corresponding device documentation.
	Protective ground connection A terminal which must be connected to ground prior to establishing any other connections.

5 Storage and transport

5.1 Storage conditions

Observe the following notes for storage:

- ▶ Store in the original packaging to ensure protection from shock.
- ▶ Do not remove protective covers or protective caps installed on process connections. They prevent mechanical damage to the sealing surfaces and contamination in the measuring tube.
- ▶ Protect from direct sunlight to avoid unacceptably high surface temperatures.
- ▶ Select a storage location where moisture cannot collect in the measuring device as fungus and bacteria infestation can damage the lining.
- ▶ Store in a dry and dust-free place.
- ▶ Do not store outdoors.

Storage temperature → 📄 206

5.2 Transporting the product

Transport the measuring device to the measuring point in the original packaging.

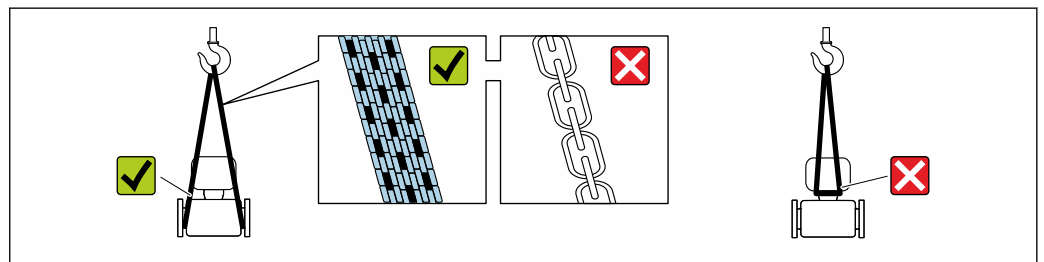

A0029252

- i** Do not remove protective covers or caps installed on process connections. They prevent mechanical damage to the sealing surfaces and contamination in the measuring tube.

5.2.1 Measuring devices without lifting lugs

⚠ WARNING

Center of gravity of the measuring device is higher than the suspension points of the webbing slings.

Risk of injury if the measuring device slips.

- ▶ Secure the measuring device against slipping or turning.
- ▶ Observe the weight specified on the packaging (stick-on label).

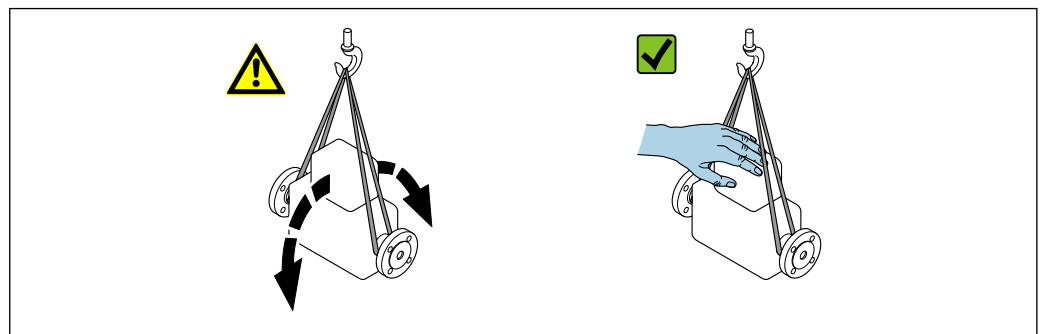

A0029214

5.2.2 Measuring devices with lifting lugs

⚠ CAUTION

Special transportation instructions for devices with lifting lugs

- ▶ Only use the lifting lugs fitted on the device or flanges to transport the device.
- ▶ The device must always be secured at two lifting lugs at least.

5.2.3 Transporting with a fork lift

If transporting in wood crates, the floor structure enables the crates to be lifted lengthwise or at both sides using a forklift.

⚠ CAUTION

Risk of damaging the magnetic coil

- ▶ If transporting by forklift, do not lift the sensor by the metal casing.
- ▶ This would buckle the casing and damage the internal magnetic coils.

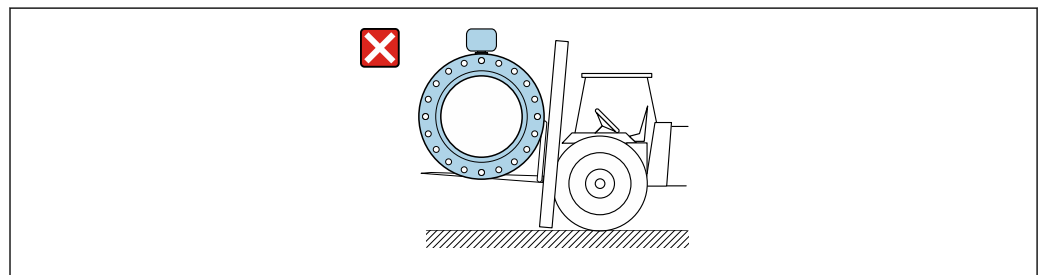

A0029319

5.3 Packaging disposal

All packaging materials are environmentally friendly and 100% recyclable:

- Measuring device secondary packaging: polymer stretch film that conforms to EC Directive 2002/95/EC (RoHS).
- Packaging:
 - Wood crate, treated in accordance with ISPM 15 standard, which is confirmed by the affixed IPPC logo.
 - or
 - Carton in accordance with European Packaging Directive 94/62EC; recyclability is confirmed by the affixed RESY symbol.
- Seaworthy packaging (optional): Wood crate, treated in accordance with ISPM 15 standard, which is confirmed by the affixed IPPC logo.
- Carrying and mounting hardware:
 - Disposable plastic pallet
 - Plastic straps
 - Plastic adhesive strips
- Dunnage: Paper cushion

6 Installation

6.1 Installation conditions

6.1.1 Mounting position

Mounting location

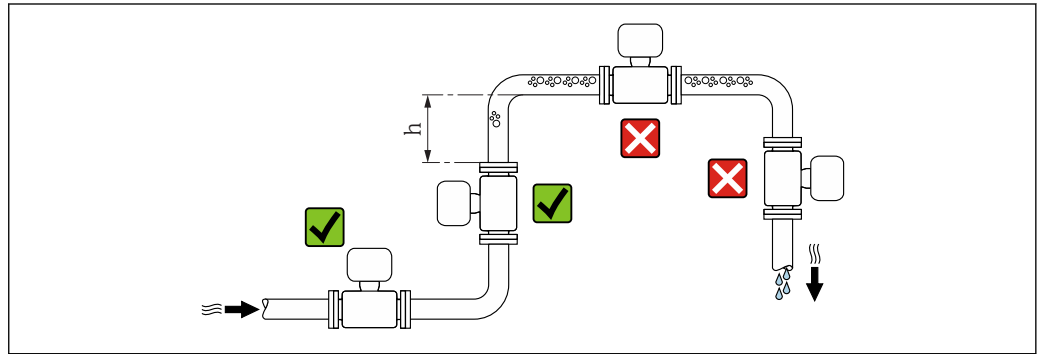

A0029343

Preferably install the sensor in an ascending pipe, and ensure a sufficient distance to the next pipe elbow: $h \geq 2 \times DN$

Installation in down pipes

Install a siphon with a vent valve downstream of the sensor in down pipes whose length $h \geq 5 \text{ m}$ (16.4 ft). This precaution is to avoid low pressure and the consequent risk of damage to the measuring tube. This measure also prevents the system losing prime.

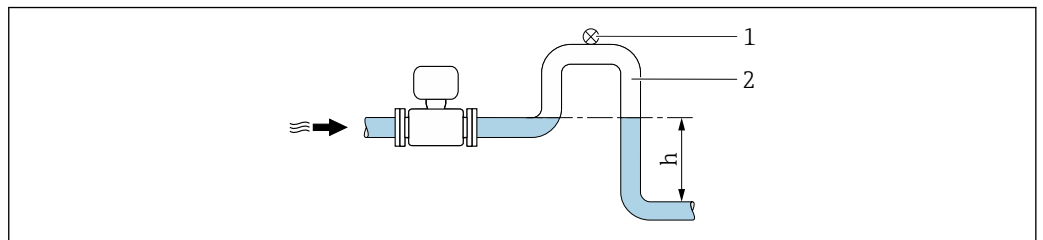

A0028981

6 Installation in a down pipe

- 1 Vent valve
- 2 Pipe siphon
- h Length of down pipe

Installation in partially filled pipes

A partially filled pipe with a gradient necessitates a drain-type configuration.

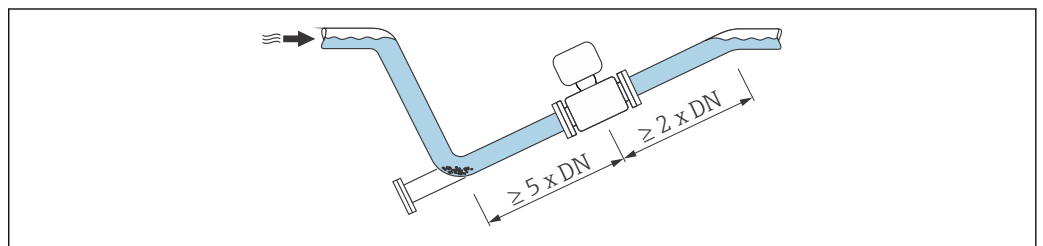

A0029257

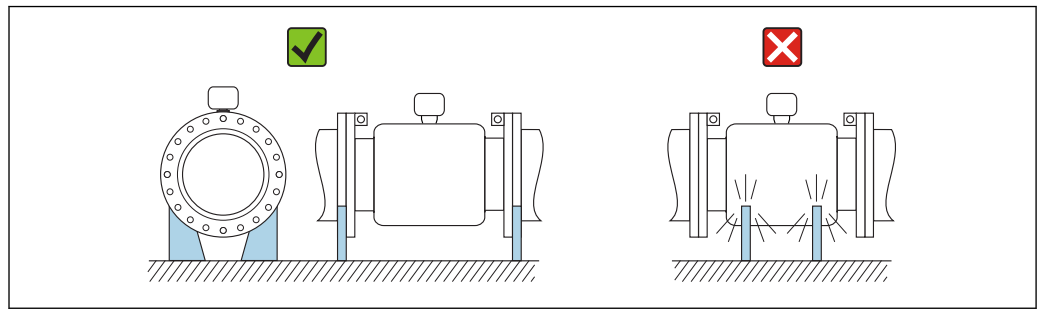

For heavy sensors $DN \geq 350$ (14")



A0016276

Orientation

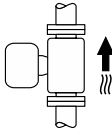
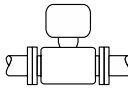
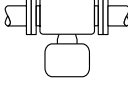
The direction of the arrow on the sensor nameplate helps you to install the sensor according to the flow direction (direction of medium flow through the piping).

Orientation		Recommendation	
A	Vertical orientation	 A0015591	✓✓
B	Horizontal orientation, transmitter at top	 A0015589	✓✓ ¹⁾
C	Horizontal orientation, transmitter at bottom	 A0015590	✓✓ ^{2) 3)}
D	Horizontal orientation, transmitter at side	 A0015592	✗

- 1) Applications with low process temperatures may decrease the ambient temperature. To maintain the minimum ambient temperature for the transmitter, this orientation is recommended.
- 2) Applications with high process temperatures may increase the ambient temperature. To maintain the maximum ambient temperature for the transmitter, this orientation is recommended.
- 3) To prevent the electronics module from overheating in the case of a sharp rise in temperature (e.g. CIP- or SIP processes), install the device with the transmitter component pointing downwards.

Horizontal

- Ideally, the measuring electrode plane should be horizontal. This prevents brief insulation of the two measuring electrodes by entrained air bubbles.
- Empty pipe detection only works if the transmitter housing is pointing upwards as otherwise there is no guarantee that the empty pipe detection function will actually respond to a partially filled or empty measuring tube.

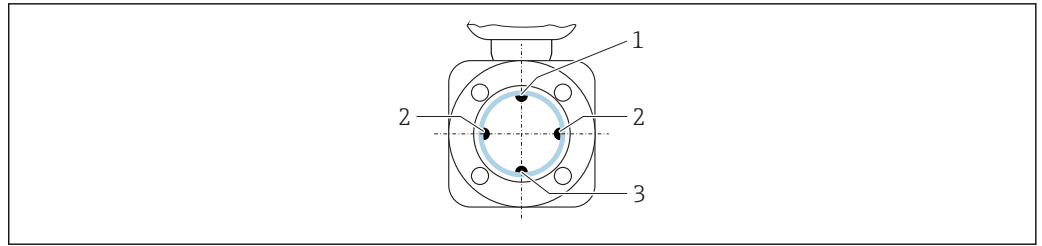

A0029344

- 1 EPD electrode for empty pipe detection
- 2 Measuring electrodes for signal detection
- 3 Reference electrode for potential equalization

i Measuring devices with tantalum or platinum electrodes can be ordered without an EPD electrode. In this case, empty pipe detection is performed via the measuring electrodes.

Inlet and outlet runs

If possible, install the sensor upstream from fittings such as valves, T-pieces or elbows. Observe the following inlet and outlet runs to comply with accuracy specifications:

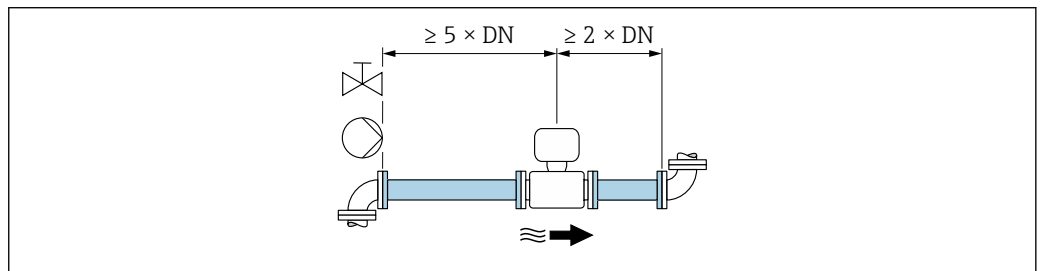

A0028997

- 7** Order code for "Design", option A "Insertion length short, ISO/DVGW until DN400, DN450-2000 1:1" and order code for "Design", option B "Insertion length long, ISO/DVGW until DN400, DN450-2000 1:1.3"

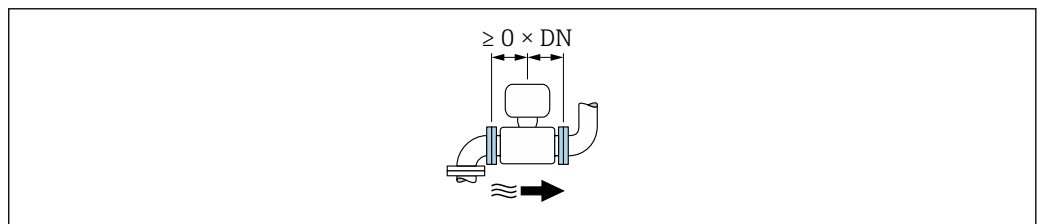

A0032859

- 8** Order code for "Design", option C "Insertion length short ISO/DVGW until DN300, w/o inlet and outlet runs, constricted meas.tube"

Installation dimensions

i For the dimensions and installation lengths of the device, see the "Technical Information" document, "Mechanical construction" section.

6.1.2 Requirements from environment and process

Ambient temperature range

Transmitter	<ul style="list-style-type: none"> Standard: -40 to +60 °C (-40 to +140 °F) Optional: -50 to +60 °C (-58 to +140 °F) (order code for "Test, certificate", option JN "Ambient temperature of transmitter -50 °C (-58 °F)")
Local display	-20 to +60 °C (-4 to +140 °F), the readability of the display may be impaired at temperatures outside the temperature range.
Sensor	<ul style="list-style-type: none"> Process connection material, carbon steel: -10 to +60 °C (+14 to +140 °F) Process connection material, stainless steel: -40 to +60 °C (-40 to +140 °F)
Liner	Do not exceed or fall below the permitted temperature range of the liner .

If operating outdoors:

- Install the measuring device in a shady location.
- Avoid direct sunlight, particularly in warm climatic regions.
- Avoid direct exposure to weather conditions.

System pressure

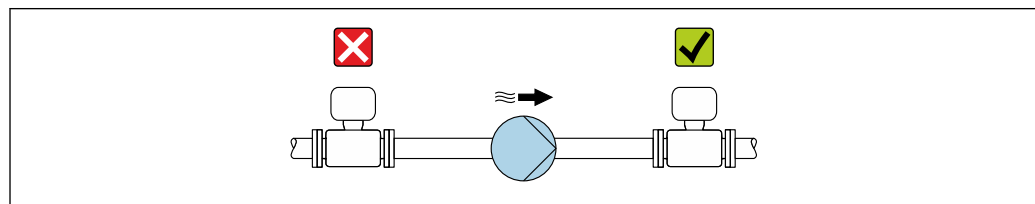

A0028777

Never install the sensor on the pump suction side in order to avoid the risk of low pressure, and thus damage to the liner.

i Furthermore, install pulse dampers if reciprocating, diaphragm or peristaltic pumps are used.

- i** Information on the liner's resistance to partial vacuum → 208
- i** Information on the shock resistance of the measuring system → 206
- i** Information on the vibration resistance of the measuring system → 206

Vibrations

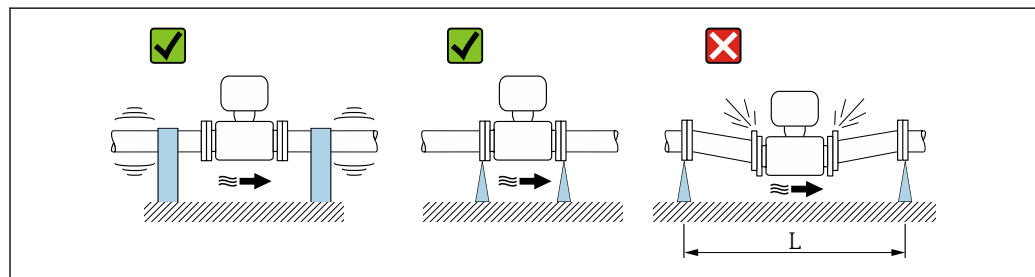

A0029004

9 Measures to avoid device vibrations ($L > 10\text{ m}$ (33 ft))

In the event of very strong vibrations, the pipe and sensor must be supported and fixed.

- i** Information on the shock resistance of the measuring system → 206
- i** Information on the vibration resistance of the measuring system → 206

Thermal insulation

Pipes generally have to be insulated if they carry very hot fluids to avoid energy losses and prevent accidental contact with pipes at temperatures that could cause injury. Guidelines regulating the insulation of pipes have to be taken into account.

⚠ WARNING

Electronics overheating on account of thermal insulation!

- ▶ The housing support dissipates heat and its entire surface area must remain uncovered. Make sure that the sensor insulation does not extend past the top of the two sensor half-shells.

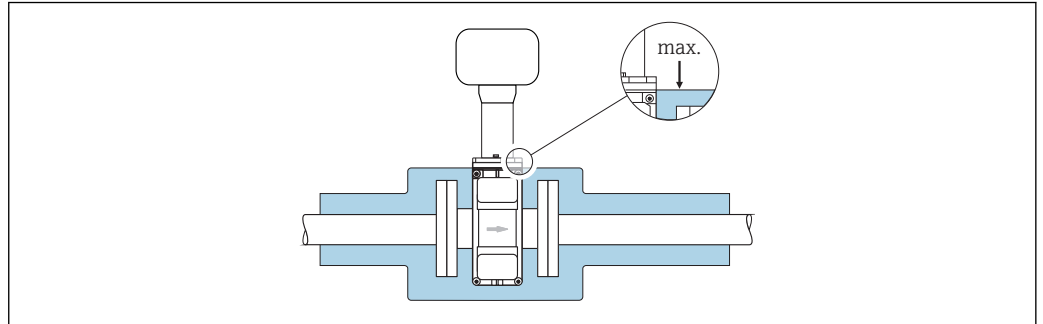

A0031216

Adapters

Suitable adapters to DIN EN 545 (double-flange reducers) can be used to install the sensor in larger-diameter pipes. The resultant increase in the rate of flow improves measuring accuracy with very slow-moving fluids. The nomogram shown here can be used to calculate the pressure loss caused by reducers and expanders.

i The nomogram only applies to liquids with a viscosity similar to that of water.

1. Calculate the ratio of the diameters d/D .
2. From the nomogram read off the pressure loss as a function of flow velocity (downstream from the reduction) and the d/D ratio.

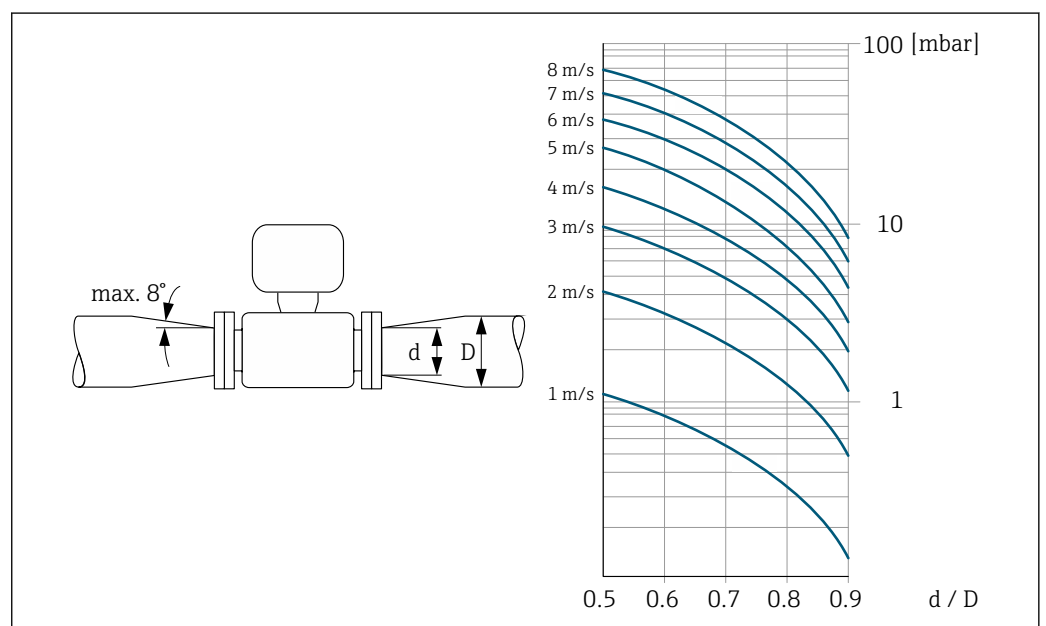

A0029002

6.1.3 Special mounting instructions

Protective cover

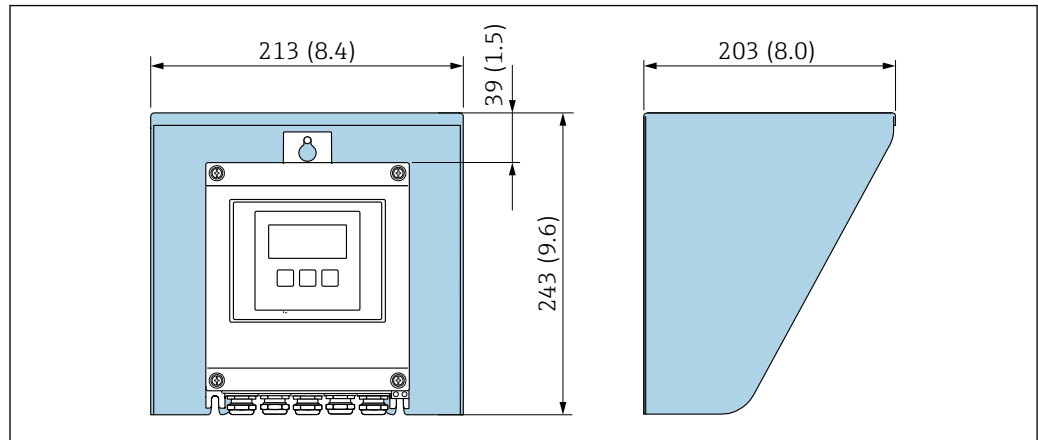

A0029552

10 Weather protection cover for Proline 500 – digital

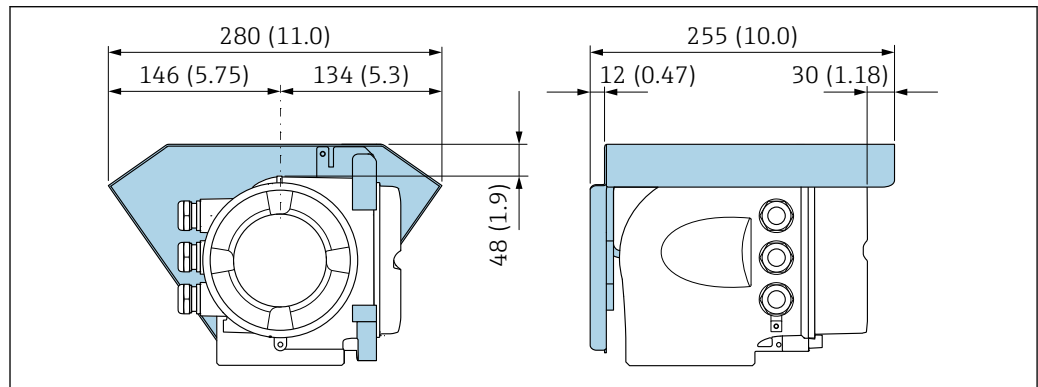

A0029553

11 Weather protection cover for Proline 500

6.2 Mounting the measuring device

6.2.1 Required tools

For transmitter

For mounting on a post:

- Proline 500 – digital transmitter
 - Open-ended wrench AF 10
 - Torx screwdriver TX 25
- Proline 500 transmitter
 - Open-ended wrench AF 13

For wall mounting:

Drill with drill bit \varnothing 6.0 mm

For sensor

For flanges and other process connections: Corresponding mounting tools

6.2.2 Preparing the measuring device

1. Remove all remaining transport packaging.
2. Remove any protective covers or protective caps present from the sensor.
3. Remove stick-on label on the electronics compartment cover.

6.2.3 Mounting the sensor

⚠ WARNING

Danger due to improper process sealing!

- ▶ Ensure that the inside diameters of the gaskets are greater than or equal to that of the process connections and piping.
 - ▶ Ensure that the gaskets are clean and undamaged.
 - ▶ Install the gaskets correctly.
1. Ensure that the direction of the arrow on the sensor matches the flow direction of the medium.
 2. To ensure compliance with device specifications, install the measuring device between the pipe flanges in a way that it is centered in the measurement section.
 3. If using ground disks, comply with the Installation Instructions provided.
 4. Observe required screw tightening torques → 📄 30.
 5. Install the measuring device or turn the transmitter housing so that the cable entries do not point upwards.

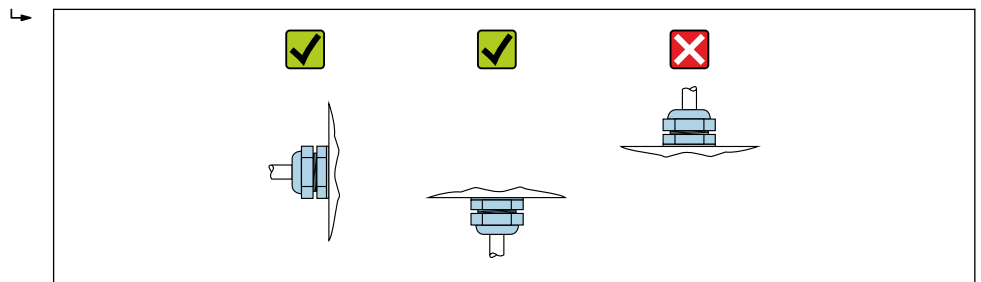

A0029263

Mounting the seals

⚠ CAUTION

An electrically conductive layer could form on the inside of the measuring tube!

Risk of measuring signal short circuit.

- ▶ Do not use electrically conductive sealing compounds such as graphite.

Comply with the following instructions when installing seals:

1. For DIN flanges: only use seals according to DIN EN 1514-1.
2. For "PFA" lining: generally additional seals are **not** required.
3. For "PTFE" lining: generally additional seals are **not** required.

Mounting the ground cable/ground disks

Comply with the information on potential equalization and detailed mounting instructions for the use of ground cables/ground disks .

Screw tightening torques

Please note the following:

- The screw tightening torques listed below apply only to lubricated threads and to pipes not subjected to tensile stress.
- Tighten the screws uniformly and in diagonally opposite sequence.
- Overtightening the screws will deform the sealing faces or damage the seals.

Screw tightening torques for EN 1092-1 (DIN 2501), PN 10/16/25/40

Nominal diameter [mm]	Pressure rating [bar]	Screws [mm]	Flange thickness [mm]	Max. screw tightening torque [Nm]	
				PTFE	PFA
15	PN 40	4 × M12	16	11	–
25	PN 40	4 × M12	18	26	20
32	PN 40	4 × M16	18	41	35
40	PN 40	4 × M16	18	52	47
50	PN 40	4 × M16	20	65	59
65 ¹⁾	PN 16	8 × M16	18	43	40
65	PN 40	8 × M16	22	43	40
80	PN 16	8 × M16	20	53	48
80	PN 40	8 × M16	24	53	48
100	PN 16	8 × M16	20	57	51
100	PN 40	8 × M20	24	78	70
125	PN 16	8 × M16	22	75	67
125	PN 40	8 × M24	26	111	99
150	PN 16	8 × M20	22	99	85
150	PN 40	8 × M24	28	136	120
200	PN 10	8 × M20	24	141	101
200	PN 16	12 × M20	24	94	67
200	PN 25	12 × M24	30	138	105
250	PN 10	12 × M20	26	110	–
250	PN 16	12 × M24	26	131	–
250	PN 25	12 × M27	32	200	–
300	PN 10	12 × M20	26	125	–
300	PN 16	12 × M24	28	179	–
300	PN 25	16 × M27	34	204	–
350	PN 10	16 × M20	26	188	–
350	PN 16	16 × M24	30	254	–
350	PN 25	16 × M30	38	380	–
400	PN 10	16 × M24	26	260	–
400	PN 16	16 × M27	32	330	–
400	PN 25	16 × M33	40	488	–
450	PN 10	20 × M24	28	235	–
450	PN 16	20 × M27	40	300	–
450	PN 25	20 × M33	46	385	–
500	PN 10	20 × M24	28	265	–
500	PN 16	20 × M30	34	448	–

Nominal diameter [mm]	Pressure rating [bar]	Screws [mm]	Flange thickness [mm]	Max. screw tightening torque [Nm]	
				PTFE	PFA
500	PN 25	20 × M33	48	533	–
600	PN 10	20 × M27	28	345	–
600 ¹⁾	PN 16	20 × M33	36	658	–
600	PN 25	20 × M36	58	731	–

1) Designed acc. to EN 1092-1 (not to DIN 2501)

Screw tightening torques for EN 1092-1 (DIN 2501), PN 10/16/25, P245GH/stainless; calculated according to EN 1591-1:2014 for flanges as per EN 1092-1:2013

Nominal diameter [mm]	Pressure rating [bar]	Screws [mm]	Flange thickness [mm]	Nom. screw tightening torque [Nm]
				PTFE
350	PN 10	16 × M20	26	60
350	PN 16	16 × M24	30	115
350	PN 25	16 × M30	38	220
400	PN 10	16 × M24	26	90
400	PN 16	16 × M27	32	155
400	PN 25	16 × M33	40	290
450	PN 10	20 × M24	28	90
450	PN 16	20 × M27	34	155
450	PN 25	20 × M33	46	290
500	PN 10	20 × M24	28	100
500	PN 16	20 × M30	36	205
500	PN 25	20 × M33	48	345
600	PN 10	20 × M27	30	150
600	PN 16	20 × M33	40	310
600	PN 25	20 × M36	48	500

Screw tightening torques for ASME B16.5, Class 150/300

Nominal diameter		Pressure rating [psi]	Screws [in]	Max. screw tightening torque [Nm] ([lbf · ft])	
[mm]	[in]			PTFE	PFA
15	½	Class 150	4 × ½	6 (4)	– (–)
15	½	Class 300	4 × ½	6 (4)	– (–)
25	1	Class 150	4 × ½	11 (8)	10 (7)
25	1	Class 300	4 × 5/8	14 (10)	12 (9)
40	1 ½	Class 150	4 × ½	24 (18)	21 (15)
40	1 ½	Class 300	4 × ¾	34 (25)	31 (23)
50	2	Class 150	4 × 5/8	47 (35)	44 (32)
50	2	Class 300	8 × 5/8	23 (17)	22 (16)
80	3	Class 150	4 × 5/8	79 (58)	67 (49)
80	3	Class 300	8 × ¾	47 (35)	42 (31)

Nominal diameter		Pressure rating [psi]	Screws [in]	Max. screw tightening torque [Nm] ([lbf · ft])	
[mm]	[in]			PTFE	PFA
100	4	Class 150	8 × 5/8	56 (41)	50 (37)
100	4	Class 300	8 × ¾	67 (49)	59 (44)
150	6	Class 150	8 × ¾	106 (78)	86 (63)
150	6	Class 300	12 × ¾	73 (54)	67 (49)
200	8	Class 150	8 × ¾	143 (105)	109 (80)
250	10	Class 150	12 × 7/8	135 (100)	- (-)
300	12	Class 150	12 × 7/8	178 (131)	- (-)
350	14	Class 150	12 × 1	260 (192)	- (-)
400	16	Class 150	16 × 1	246 (181)	- (-)
450	18	Class 150	16 × 1 1/8	371 (274)	- (-)
500	20	Class 150	20 × 1 1/8	341 (252)	- (-)
600	24	Class 150	20 × 1 ¼	477 (352)	- (-)

Screw tightening torques for JIS B2220, 10/20K

Nominal diameter [mm]	Pressure rating [bar]	Screws [mm]	Max. screw tightening torque [Nm]	
			PTFE	PFA
25	10K	4 × M16	32	27
25	20K	4 × M16	32	27
32	10K	4 × M16	38	-
32	20K	4 × M16	38	-
40	10K	4 × M16	41	37
40	20K	4 × M16	41	37
50	10K	4 × M16	54	46
50	20K	8 × M16	27	23
65	10K	4 × M16	74	63
65	20K	8 × M16	37	31
80	10K	8 × M16	38	32
80	20K	8 × M20	57	46
100	10K	8 × M16	47	38
100	20K	8 × M20	75	58
125	10K	8 × M20	80	66
125	20K	8 × M22	121	103
150	10K	8 × M20	99	81
150	20K	12 × M22	108	72
200	10K	12 × M20	82	54
200	20K	12 × M22	121	88
250	10K	12 × M22	133	-
250	20K	12 × M24	212	-
300	10K	16 × M22	99	-
300	20K	16 × M24	183	-

Screw tightening torques for JIS B2220, 10/20K

Nominal diameter [mm]	Pressure rating [bar]	Screws [mm]	Nom. screw tightening torque [Nm]	
			PUR	HG
350	10K	16 × M22	109	109
350	20K	16 × M30×3	217	217
400	10K	16 × M24	163	163
400	20K	16 × M30×3	258	258
450	10K	16 × M24	155	155
450	20K	16 × M30×3	272	272
500	10K	16 × M24	183	183
500	20K	16 × M30×3	315	315
600	10K	16 × M30	235	235
600	20K	16 × M36×3	381	381
700	10K	16 × M30	300	300
750	10K	16 × M30	339	339

Screw tightening torques for AS 2129, Table E

Nominal diameter [mm]	Screws [mm]	Max. screw tightening torque [Nm]
		PTFE
25	4 × M12	21
50	4 × M16	42

Screw tightening torques for AS 4087, PN 16

Nominal diameter [mm]	Screws [mm]	Max. screw tightening torque [Nm]
		PTFE
50	4 × M16	42

6.2.4 Mounting the transmitter housing: Proline 500 – digital**⚠ CAUTION****Ambient temperature too high!**

Danger of electronics overheating and housing deformation.

- ▶ Do not exceed the permitted maximum ambient temperature → 26.
- ▶ If operating outdoors: Avoid direct sunlight and exposure to weathering, particularly in warm climatic regions.

⚠ CAUTION**Excessive force can damage the housing!**

- ▶ Avoid excessive mechanical stress.

The transmitter can be mounted in the following ways:

- Post mounting
- Wall mounting

Post mounting



Excessive tightening torque applied to the fixing screws!

Risk of damaging the plastic transmitter.

- ▶ Tighten the fixing screws as per the tightening torque: 2 Nm (1.5 lbf ft)

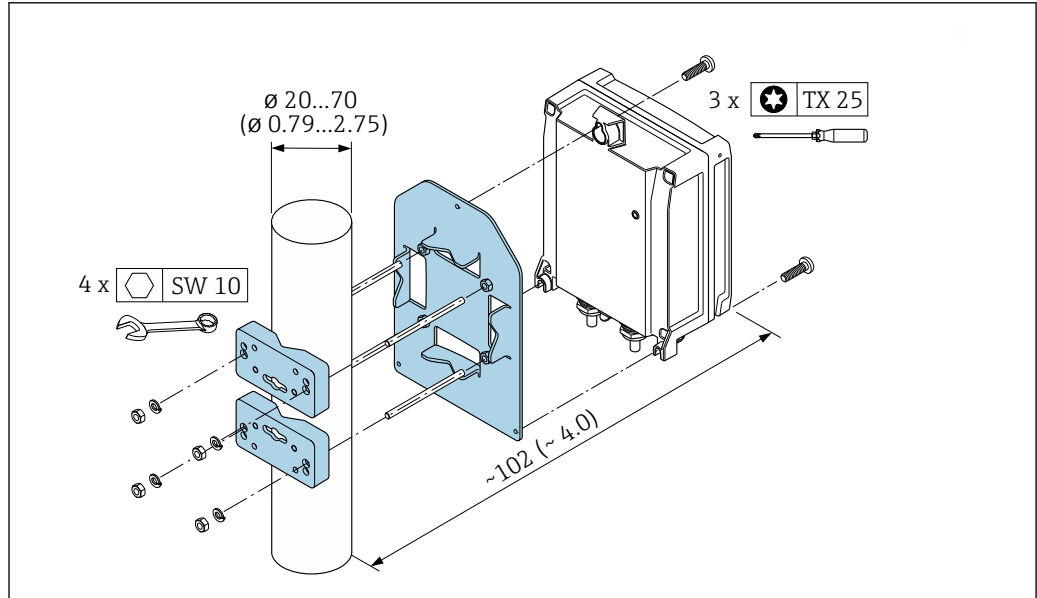

A0029051

12 Engineering unit mm (in)

Wall mounting

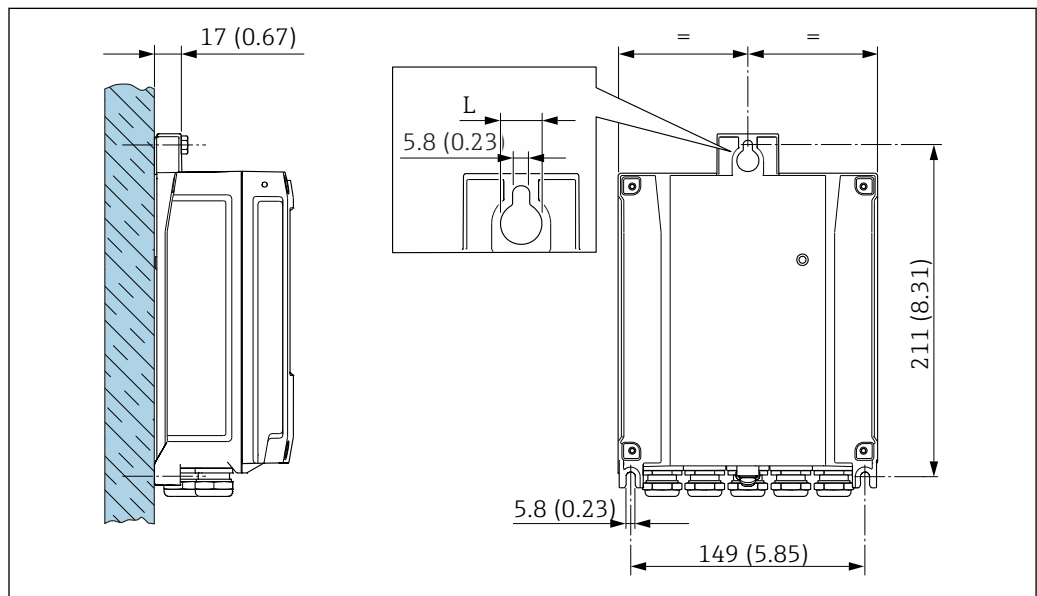

A0029054

13 Engineering unit mm (in)

L Depends on order code for "Transmitter housing"

Order code for "Transmitter housing"

- Option A, aluminum coated: L = 14 mm (0.55 in)
- Option D, polycarbonate: L = 13 mm (0.51 in)

1. Drill the holes.

2. Insert wall plugs into the drilled holes.
3. Screw in the securing screws slightly at first.
4. Fit the transmitter housing over the securing screws and mount in place.
5. Tighten the securing screws.

6.2.5 Mounting the transmitter housing: Proline 500

CAUTION

Ambient temperature too high!

Danger of electronics overheating and housing deformation.

- ▶ Do not exceed the permitted maximum ambient temperature → 26.
- ▶ If operating outdoors: Avoid direct sunlight and exposure to weathering, particularly in warm climatic regions.

CAUTION

Excessive force can damage the housing!

- ▶ Avoid excessive mechanical stress.

The transmitter can be mounted in the following ways:

- Post mounting
- Wall mounting

Wall mounting

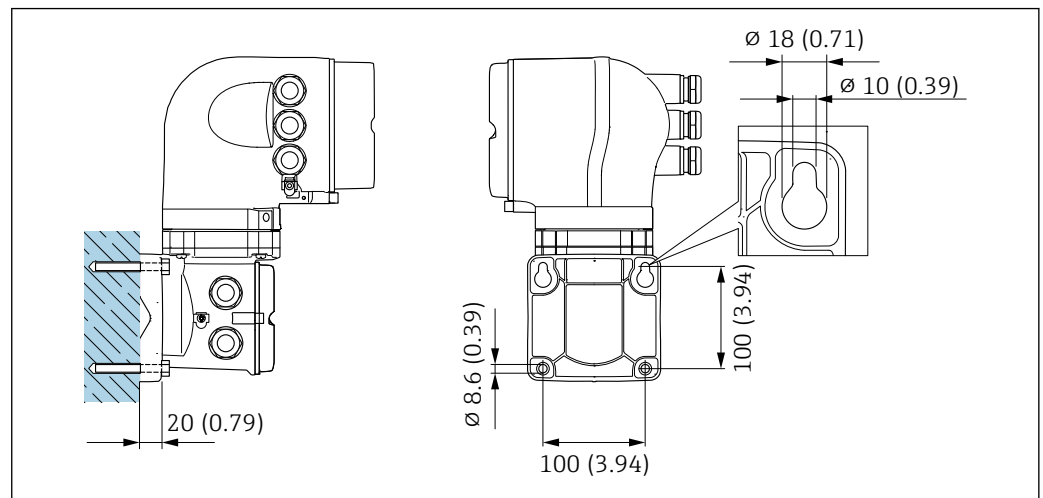

14 Engineering unit mm (in)

1. Drill the holes.
2. Insert wall plugs into the drilled holes.
3. Screw in the securing screws slightly at first.
4. Fit the transmitter housing over the securing screws and mount in place.
5. Tighten the securing screws.

Post mounting

⚠ WARNING

Order code for "Transmitter housing", option L "Cast, stainless": cast transmitters are very heavy.

They are unstable if they are not mounted on a secure, fixed post.

- Only mount the transmitter on a secure, fixed post on a stable surface.

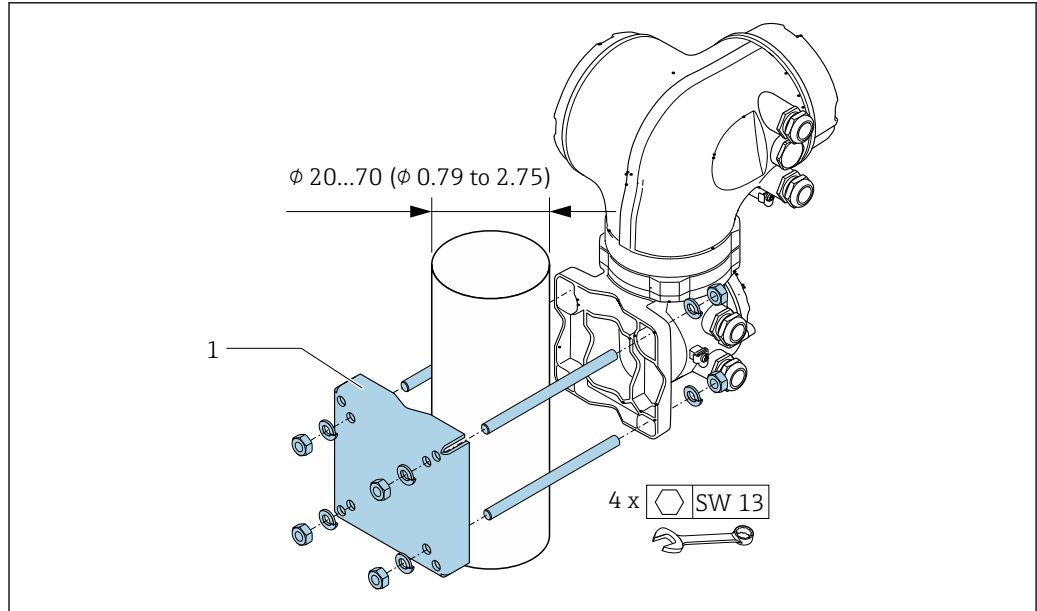

15 Engineering unit mm (in)

6.2.6 Turning the transmitter housing: Proline 500

To provide easier access to the connection compartment or display module, the transmitter housing can be turned.

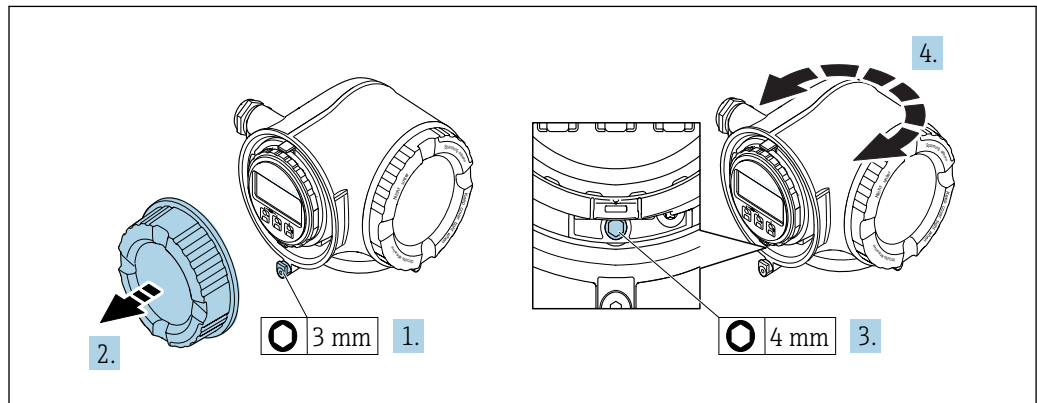

1. Depending on the device version: Loosen the securing clamp of the connection compartment cover.
2. Unscrew the connection compartment cover.
3. Release the fixing screw.
4. Turn the housing to the desired position.
5. Firmly tighten the securing screw.
6. Screw on the connection compartment cover

- 7. Depending on the device version: Attach the securing clamp of the connection compartment cover.

6.2.7 Turning the display module: Proline 500

The display module can be turned to optimize display readability and operability.

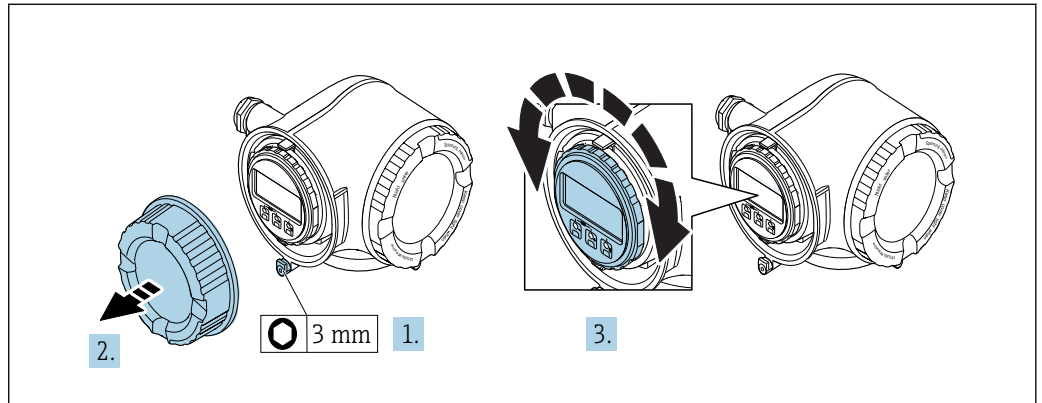

A0030035

- 1. Depending on the device version: Loosen the securing clamp of the connection compartment cover.
- 2. Unscrew the connection compartment cover.
- 3. Turn the display module to the desired position: max. $8 \times 45^\circ$ in each direction.
- 4. Screw on the connection compartment cover.
- 5. Depending on the device version: Attach the securing clamp of the connection compartment cover.

6.3 Post-installation check

Is the device undamaged (visual inspection)?	<input type="checkbox"/>
Does the measuring device conform to the measuring point specifications? For example: <ul style="list-style-type: none"> ▪ Process temperature ▪ Process pressure (refer to the section on "Pressure-temperature ratings" in the "Technical Information" document) ▪ Ambient temperature ▪ Measuring range 	<input type="checkbox"/>
Has the correct orientation for the sensor been selected ? <ul style="list-style-type: none"> ▪ According to sensor type ▪ According to medium temperature ▪ According to medium properties (outgassing, with entrained solids) 	<input type="checkbox"/>
Does the arrow on the sensor nameplate match the direction of flow of the fluid through the piping ?	<input type="checkbox"/>
Are the measuring point identification and labeling correct (visual inspection)?	<input type="checkbox"/>
Is the device adequately protected from precipitation and direct sunlight?	<input type="checkbox"/>
Have the fixing screws been tightened with the correct tightening torque?	<input type="checkbox"/>

7 Electrical connection

NOTICE

The measuring device does not have an internal circuit breaker.

- ▶ For this reason, assign the measuring device a switch or power-circuit breaker so that the power supply line can be easily disconnected from the mains.
- ▶ Although the measuring device is equipped with a fuse, additional overcurrent protection (maximum 10 A) should be integrated into the system installation.

7.1 Connection conditions

7.1.1 Required tools

- For cable entries: Use corresponding tools
- For securing clamp: Allen key 3 mm
- Wire stripper
- When using stranded cables: crimper for wire end ferrule
- For removing cables from terminal: Flat blade screwdriver ≤ 3 mm (0.12 in)

7.1.2 Requirements for connecting cable

The connecting cables provided by the customer must fulfill the following requirements.

Electrical safety

In accordance with applicable federal/national regulations.

Protective ground cable

Cable: 2.1 mm² (14 AWG)

The grounding impedance must be less than 1 Ω .

Permitted temperature range

- The installation guidelines that apply in the country of installation must be observed.
- The cables must be suitable for the minimum and maximum temperatures to be expected.

Power supply cable

Standard installation cable is sufficient.

Signal cable

EtherNet/IP

The standard ANSI/TIA/EIA-568-B.2 Annex specifies CAT 5 as the minimum category for a cable used for EtherNet/IP. CAT 5e and CAT 6 are recommended.



For more information on planning and installing EtherNet/IP networks, please refer to the "Media Planning and Installation Manual. EtherNet/IP" of ODVA Organization

Current output 0/4 to 20 mA

Standard installation cable is sufficient.

Pulse/frequency/switch output

Standard installation cable is sufficient.

Relay output

Standard installation cable is sufficient.

Current input 0/4 to 20 mA

Standard installation cable is sufficient.

Status input

Standard installation cable is sufficient.

Cable diameter

- Cable glands supplied:
M20 × 1.5 with cable Ø 6 to 12 mm (0.24 to 0.47 in)
- Spring-loaded terminals: Suitable for strands and strands with ferrules.
Conductor cross-section 0.2 to 2.5 mm² (24 to 12 AWG).

Choice of connecting cable between the transmitter and sensor

Depends on the type of transmitter and the installation zones

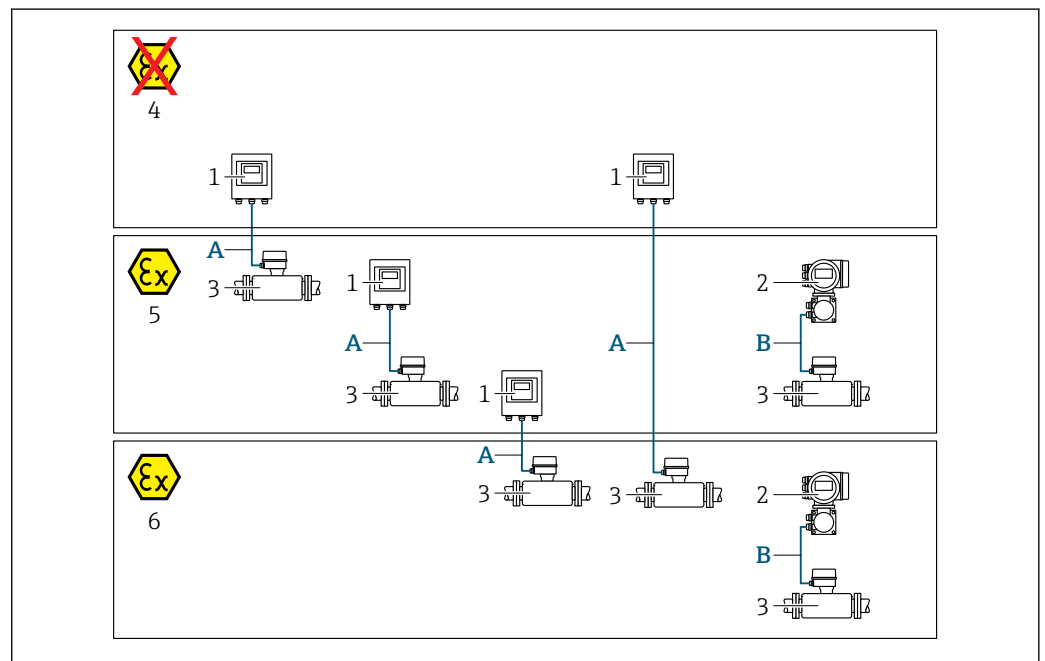

A0032477

- 1 Proline 500 digital transmitter
- 2 Proline 500 transmitter
- 3 Promag sensor
- 4 Non-hazardous area
- 5 Hazardous area: Zone 2; Class I, Division 2
- 6 Hazardous area: Zone 1; Class I, Division 1
- A Standard cable to 500 digital transmitter → 39
Transmitter installed in the non-hazardous area or hazardous area: Zone 2; Class I, Division 2 / sensor installed in the hazardous area: Zone 2; Class I, Division 2 or Zone 1; Class I, Division 1
- B Signal cable to 500 transmitter → 40
Transmitter and sensor installed in the hazardous area: Zone 2; Class I, Division 2 oder Zone 1; Class I, Division 1

A: Connecting cable between sensor and transmitter: Proline 500 – digital

Standard cable

A standard cable with the following specifications can be used as the connecting cable.

Design	4 cores (2 pairs); uninsulated stranded CU wires; pair-stranded with common shield
Shielding	Tin-plated copper-braid, optical cover $\geq 85\%$
Cable length	Maximum 300 m (1000 ft), see the following table.

Cross-section	Cable lengths for use in	
	Non-hazardous area, Hazardous area: Zone 2; Class I, Division 2	Hazardous area: Zone 1; Class I, Division 1
0.34 mm ² (AWG 22)	80 m (270 ft)	50 m (165 ft)
0.50 mm ² (AWG 20)	120 m (400 ft)	60 m (200 ft)
0.75 mm ² (AWG 18)	180 m (600 ft)	90 m (300 ft)
1.00 mm ² (AWG 17)	240 m (800 ft)	120 m (400 ft)
1.50 mm ² (AWG 15)	300 m (1000 ft)	180 m (600 ft)
2.50 mm ² (AWG 13)	300 m (1000 ft)	300 m (1000 ft)

Optionally available connecting cable

Design	2 × 2 × 0.34 mm ² (AWG 22) PVC cable ¹⁾ with common shield (2 pairs, uninsulated stranded CU wires; pair-stranded)
Flame resistance	According to DIN EN 60332-1-2
Oil-resistance	According to DIN EN 60811-2-1
Shielding	Tin-plated copper-braid, optical cover $\geq 85\%$
Operating temperature	When mounted in a fixed position: -50 to +105 °C (-58 to +221 °F); when cable can move freely: -25 to +105 °C (-13 to +221 °F)
Available cable length	Fixed: 20 m (65 ft); variable: up to maximum 50 m (165 ft)

1) UV radiation can impair the cable outer sheath. Protect the cable from direct sunshine where possible.

B: Connecting cable between sensor and transmitter: Proline 500

Signal cable

Design	3 × 0.38 mm ² (20 AWG) with common, braided copper shield ($\varnothing \sim 9.5$ mm (0.37 in)) and individual shielded cores
Conductor resistance	$\leq 50 \Omega/\text{km}$ (0.015 Ω/ft)
Capacitance: core/shield	≤ 420 pF/m (128 pF/ft)
Cable length (max.)	Depends on the medium conductivity, max. 200 m (656 ft)
Cable lengths (available for order)	5 m (15 ft), 10 m (32 ft), 20 m (65 ft) or variable length up to max. 200 m (656 ft)
Operating temperature	-20 to +80 °C (-68 to +176 °F)

Coil current cable

Design	3 × 0.75 mm ² (18 AWG) with common, braided copper shield ($\varnothing \sim 9$ mm (0.35 in)) and individual shielded cores
Conductor resistance	$\leq 37 \Omega/\text{km}$ (0.011 Ω/ft)
Capacitance: core/core, shield grounded	≤ 120 pF/m (37 pF/ft)

Cable length (max.)	Depends on the medium conductivity, max. 200 m (656 ft)
Cable lengths (available for order)	5 m (15 ft), 10 m (32 ft), 20 m (65 ft) or variable length up to max. 200 m (656 ft)
Operating temperature	-20 to +80 °C (-68 to +176 °F)
Test voltage for cable insulation	≤ AC 1433 V rms 50/60 Hz or ≥ DC 2026 V

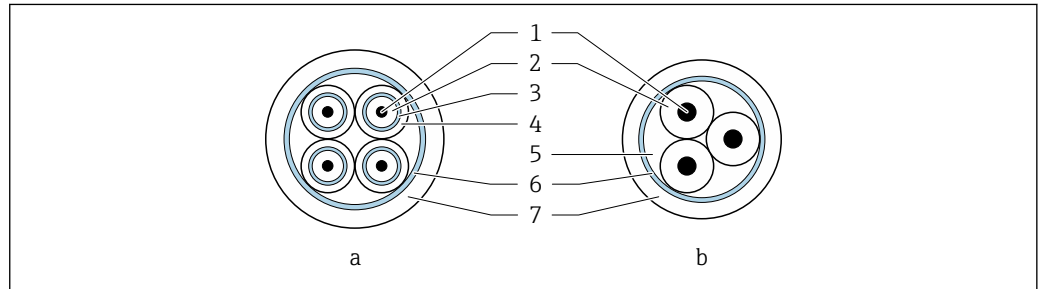

A0029151

16 Cable cross-section

- a Electrode cable
- b Coil current cable
- 1 Core
- 2 Core insulation
- 3 Core shield
- 4 Core jacket
- 5 Core reinforcement
- 6 Cable shield
- 7 Outer jacket

Reinforced connecting cables

Reinforced connecting cables with an additional, reinforcing metal braid should be used for:

- When laying the cable directly in the ground
- Where there is a risk of damage from rodents

Operation in zones of severe electrical interference

The measuring system meets the general safety requirements → 219 and EMC specifications → 206.

Grounding is by means of the ground terminal provided for the purpose inside the connection housing. The stripped and twisted lengths of cable shield to the ground terminal must be as short as possible.

7.1.3 Terminal assignment

Transmitter: supply voltage, input/outputs

The terminal assignment of the inputs and outputs depends on the individual order version of the device. The device-specific terminal assignment is documented on an adhesive label in the terminal cover.

Supply voltage		Input/output 1	Input/output 2		Input/output 3		Input/output 4	
1 (+)	2 (-)	EtherNet/IP (RJ45 Stecker)	24 (+)	25 (-)	22 (+)	23 (-)	20 (+)	21 (-)
Device-specific terminal assignment: adhesive label in terminal cover.								

Transmitter and sensor connection housing: connecting cable

The sensor and transmitter, which are mounted in separate locations, are interconnected by a connecting cable. The cable is connected via the sensor connection housing and the transmitter housing.

Terminal assignment and connection of the connecting cable:

- Proline 500 – digital → 46
- Proline 500 → 54

7.1.4 Device plugs available

i Device plugs may not be used in hazardous areas!

Order code for "Input; output 1", option NA "EtherNet/IP"

Order code for "Electrical connection"	Cable entry/connection	
	2	3
L, N, P, U	Connector M12 × 1	-
R ^{1) 2)} , S ^{1) 2)} , T ^{1) 2)} , V ^{1) 2)}	Connector M12 × 1	Connector M12 × 1

- 1) Cannot be combined with an external WLAN antenna (order code for "Enclosed accessories", option P8) of an RJ45 M12 adapter for the service interface (order code for "Accessories mounted", option NB) or of the remote display and operating module DKX001
- 2) Suitable for integrating the device in a ring topology.

7.1.5 Pin assignment of device plug

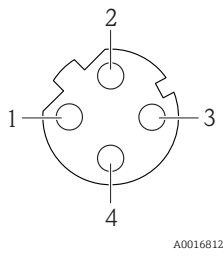
	Pin	Assignment	
	1	+	Tx
	2	+	Rx
	3	-	Tx
	4	-	Rx
Coding	Plug/socket		
D	Socket		

7.1.6 Preparing the measuring device

Carry out the steps in the following order:

1. Mount the sensor and transmitter.
2. Connection housing, sensor: Connect connecting cable.
3. Transmitter: Connect connecting cable.
4. Transmitter: Connect signal cable and cable for supply voltage.

NOTICE

Insufficient sealing of the housing!

Operational reliability of the measuring device could be compromised.

- Use suitable cable glands corresponding to the degree of protection.

1. Remove dummy plug if present.
2. If the measuring device is supplied without cable glands:
Provide suitable cable gland for corresponding connecting cable.

3. If the measuring device is supplied with cable glands:
Observe requirements for connecting cables →  38.

7.1.7 Preparing the connecting cable: Proline 500 – digital

When terminating the connecting cable, pay attention to the following points:

- ▶ For cables with fine-wire cores (stranded cables):
Fit the cores with ferrules.

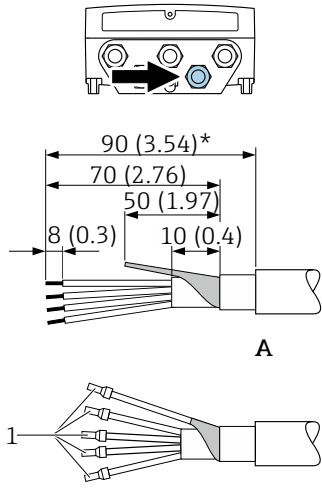
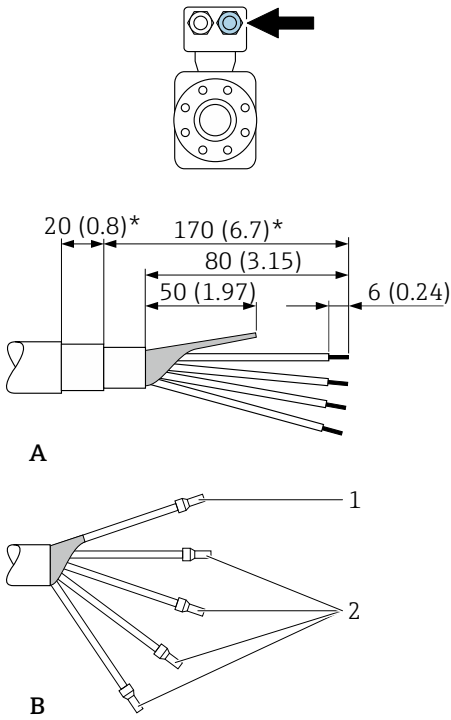
Transmitter	Sensor
 <p style="text-align: right; font-size: small;">A0029330</p>	 <p style="text-align: right; font-size: small;">A0029443</p>
<p>Engineering unit mm (in) A = Terminate the cable B = Fit ferrules on cables with fine-wire cores (stranded cables) 1 = Red ferrules, ϕ 1.0 mm (0.04 in) 2 = White ferrules, ϕ 0.5 mm (0.02 in) * = Stripping only for reinforced cables</p>	

7.1.8 Preparing the connecting cable: Proline 500

When terminating the connecting cable, pay attention to the following points:

1. In the case of the electrode cable:
Make sure that the ferrules do not touch the core shields on the sensor side.
Minimum distance = 1 mm (exception: green "GND" cable)
2. In the case of the coil current cable:
Insulate one core of the three-core cable at the level of the core reinforcement. You only require two cores for the connection.
3. For cables with fine-wire cores (stranded cables):
Fit the cores with ferrules.

Transmitter	
<p>Electrode cable</p> <p style="text-align: right;">A0029326</p>	<p>Coil current cable</p> <p style="text-align: right;">A0029329</p>
Sensor	
<p>Electrode cable</p> <p style="text-align: right;">A0029336</p>	<p>Coil current cable</p> <p style="text-align: right;">A0029337</p>
<p>Engineering unit mm (in) A = Terminate the cable B = Fit ferrules on cables with fine-wire cores (stranded cables) 1 = Red ferrules, ϕ 1.0 mm (0.04 in) 2 = White ferrules, ϕ 0.5 mm (0.02 in) * = Stripping only for reinforced cables</p>	

7.2 Connecting the measuring device: Proline 500 - digital

NOTICE

Limitation of electrical safety due to incorrect connection!

- ▶ Have electrical connection work carried out by appropriately trained specialists only.
- ▶ Observe applicable federal/national installation codes and regulations.
- ▶ Comply with local workplace safety regulations.
- ▶ Always connect the protective ground cable ⊕ before connecting additional cables.
- ▶ For use in potentially explosive atmospheres, observe the information in the device-specific Ex documentation.

7.2.1 Connecting the connecting cable

⚠ WARNING

Risk of damaging the electronic components!

- ▶ Connect the sensor and transmitter to the same potential equalization.
- ▶ Only connect the sensor to a transmitter with the same serial number.
- ▶ Ground the connection housing of the sensor via the external screw terminal.

Connecting cable terminal assignment

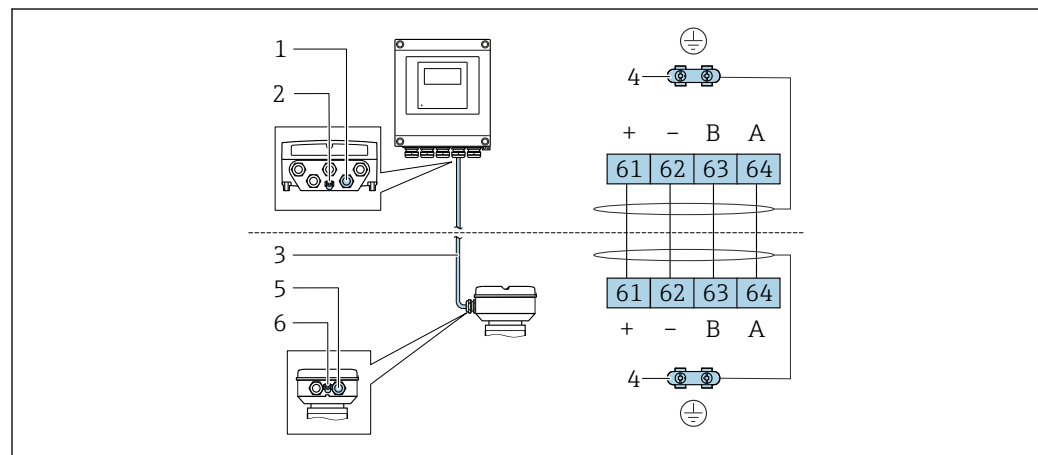

A0028198

- 1 Cable entry for cable on transmitter housing
- 2 Protective earth (PE)
- 3 Connecting cable ISEM communication
- 4 Grounding via ground connection; on device plug versions grounding is through the plug itself
- 5 Cable entry for cable or connection of device plug on sensor connection housing
- 6 Protective earth (PE)

Connecting the connecting cable to the sensor connection housing

Connection via terminals with order code for "Sensor connection housing":

- Option A "Aluminum, coated" → ☰ 47
- Option L "Cast, stainless" → ☰ 47

Connecting the connecting cable to the transmitter

The cable is connected to the transmitter via terminals → ☰ 48.

Connecting the sensor connection housing via terminals

For the device version with the order code for "Sensor connection housing":

- Option **A** "Aluminum coated"
- Option **L** "Cast, stainless"

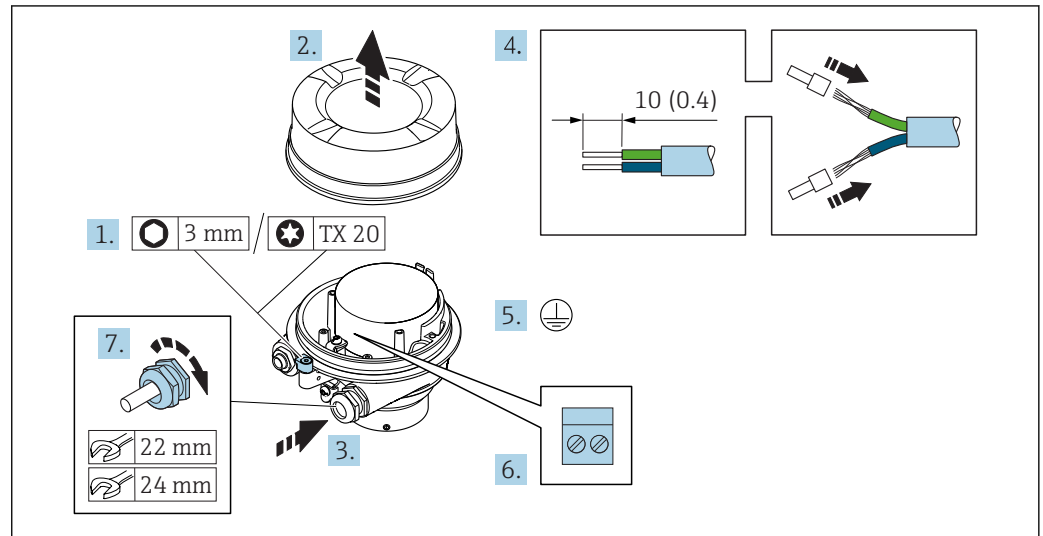

A0029616

1. Loosen the securing clamp of the housing cover.
2. Unscrew the housing cover.
3. Push the cable through the cable entry . To ensure tight sealing, do not remove the sealing ring from the cable entry.
4. Strip the cable and cable ends. In the case of stranded cables, fit ferrules.
5. Connect the protective ground.
6. Connect the cable in accordance with the connecting cable terminal assignment.
7. Firmly tighten the cable glands.
 - ↳ This concludes the process for connecting the connecting cable.

⚠ WARNING

Housing degree of protection voided due to insufficient sealing of the housing.

- ▶ Screw in the thread on the cover without using any lubricant. The thread on the cover is coated with a dry lubricant.

8. Screw on the housing cover.
9. Tighten the securing clamp of the housing cover.

Connecting the connecting cable to the transmitter

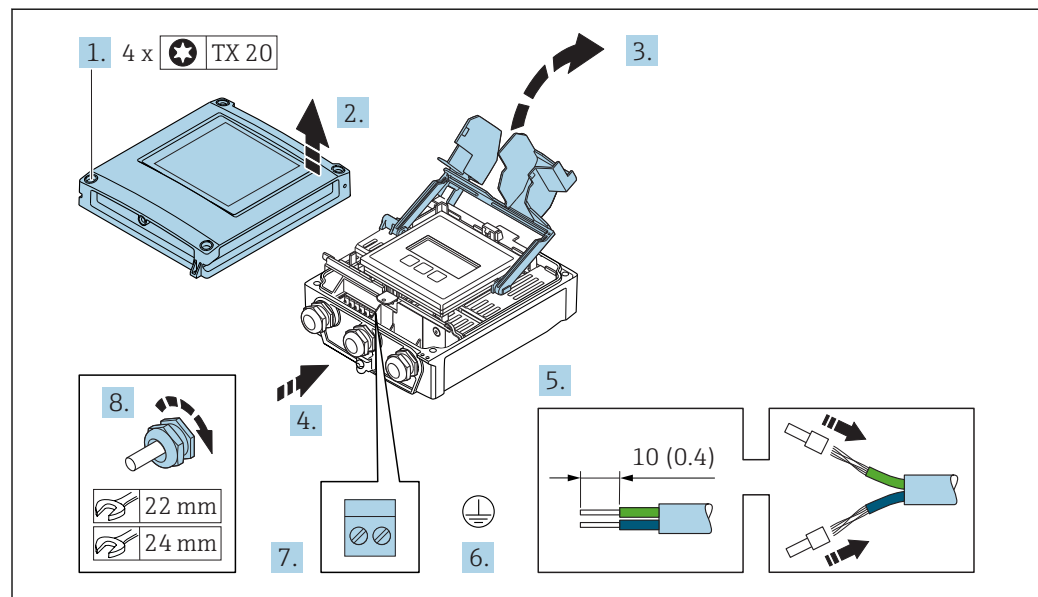

A0029597

1. Loosen the 4 fixing screws on the housing cover.
2. Open the housing cover.
3. Fold open the terminal cover.
4. Push the cable through the cable entry . To ensure tight sealing, do not remove the sealing ring from the cable entry.
5. Strip the cable and cable ends. In the case of stranded cables, fit ferrules.
6. Connect the protective ground.
7. Connect the cable in accordance with the connecting cable terminal assignment → 46.
8. Firmly tighten the cable glands.
 - ↳ This concludes the process for connecting the connecting cable.
9. Close the housing cover.
10. Tighten the securing screw of the housing cover.
11. After connecting the connecting cable:
 - Connect the signal cable and the supply voltage cable → 49.

7.2.2 Connecting the transmitter

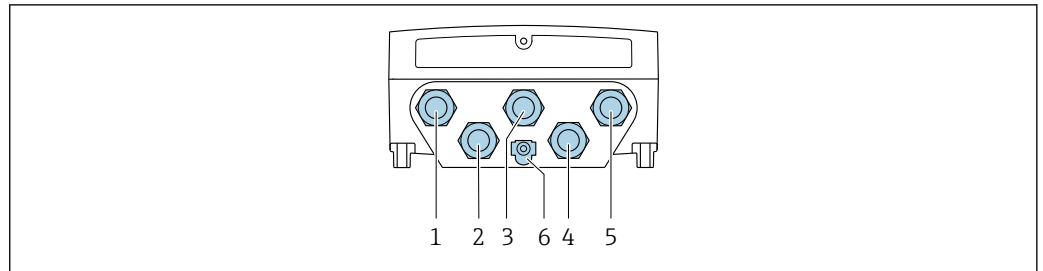

A0028200

- 1 Terminal connection for supply voltage
- 2 Terminal connection for signal transmission, input/output
- 3 Terminal connection for signal transmission, input/output
- 4 Terminal connection for connecting cable between sensor and transmitter
- 5 Terminal connection for signal transmission, input/output or terminal connection for network connection (DHCP client) via service interface (CDI-RJ45); optional: connection for external WLAN antenna
- 6 Protective earth (PE)

i In addition to connecting the device via EtherNet/IP and the available inputs/outputs, additional connection options are also available:

- Integrate into a network via the service interface (CDI-RJ45) → 52.
- Integrate the device into a ring topology → 53.

Connecting the EtherNet/IP connector

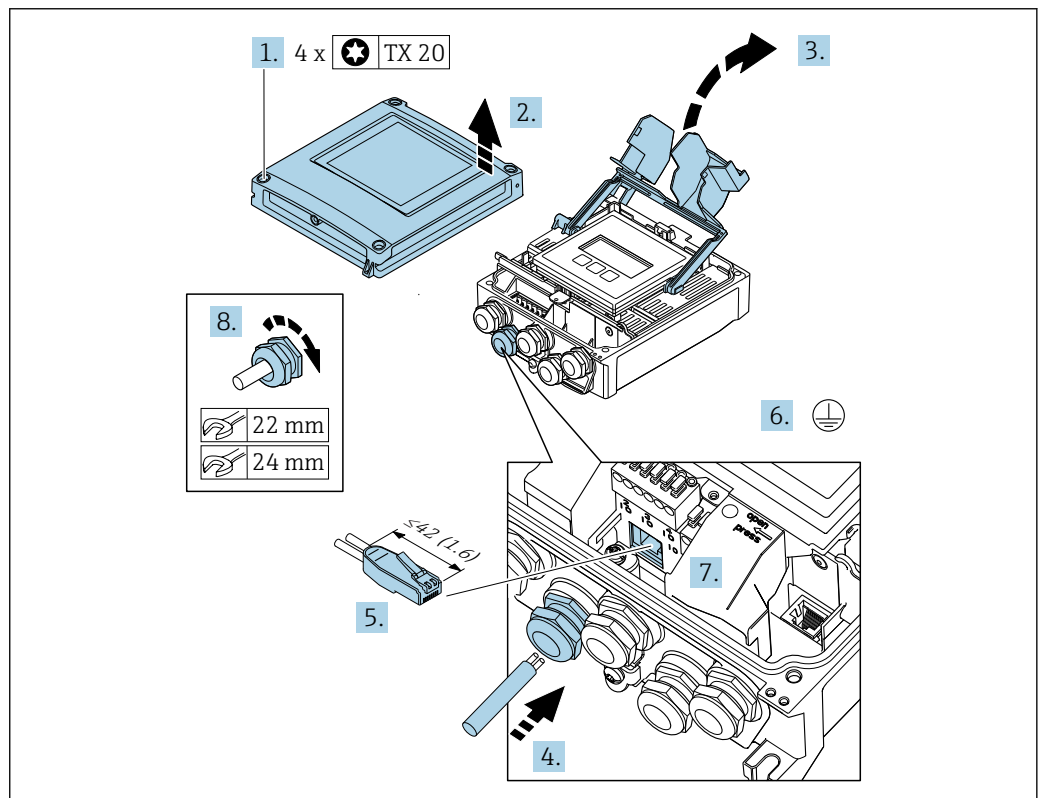

A0033987

1. Loosen the 4 fixing screws on the housing cover.
2. Open the housing cover.
3. Fold open the terminal cover.
4. Push the cable through the cable entry. To ensure tight sealing, do not remove the sealing ring from the cable entry.
5. Strip the cable and cable ends and connect to the RJ45 connector.

6. Connect the protective ground.
7. Plug in the RJ45 connector.
8. Firmly tighten the cable glands.
 - ↳ This concludes the EtherNet/IP connection process.

Connecting the supply voltage and additional inputs/outputs

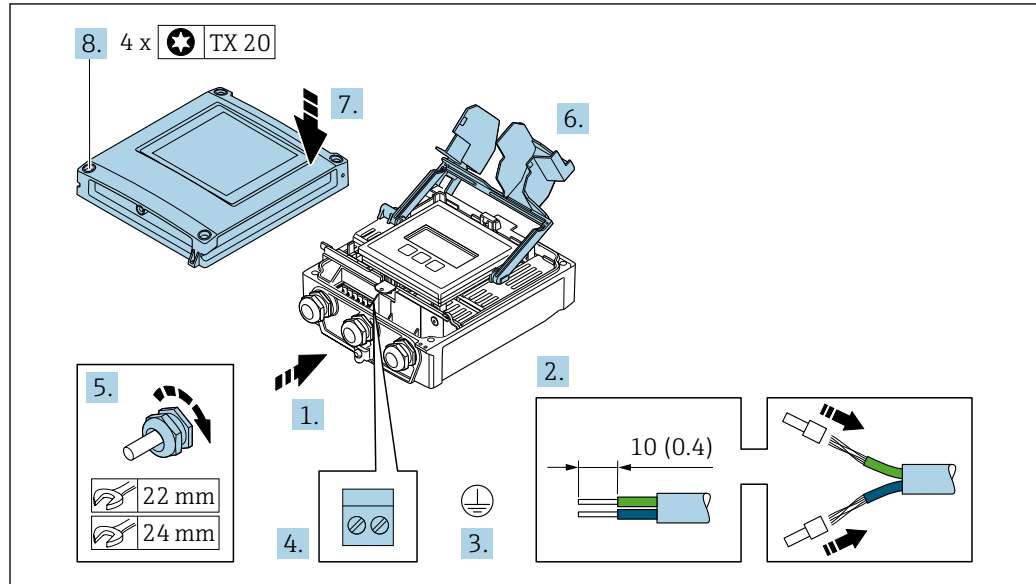

1. Push the cable through the cable entry . To ensure tight sealing, do not remove the sealing ring from the cable entry.
2. Strip the cable and cable ends. In the case of stranded cables, fit ferrules.
3. Connect the protective ground.
4. Connect the cable in accordance with the terminal assignment .
 - ↳ **Signal cable terminal assignment:** The device-specific terminal assignment is documented on an adhesive label in the terminal cover.
 - Supply voltage terminal assignment:** Adhesive label in the terminal cover or → 41.
5. Firmly tighten the cable glands.
 - ↳ This concludes the cable connection process.
6. Close the terminal cover.
7. Close the housing cover.

⚠ WARNING

Housing degree of protection may be voided due to insufficient sealing of the housing.

- ▶ Screw in the screw without using any lubricant.

⚠ WARNING

Excessive tightening torque applied to the fixing screws!

Risk of damaging the plastic transmitter.

- ▶ Tighten the fixing screws as per the tightening torque: 2 Nm (1.5 lbf ft)

8. Tighten the 4 fixing screws on the housing cover.

Removing a cable

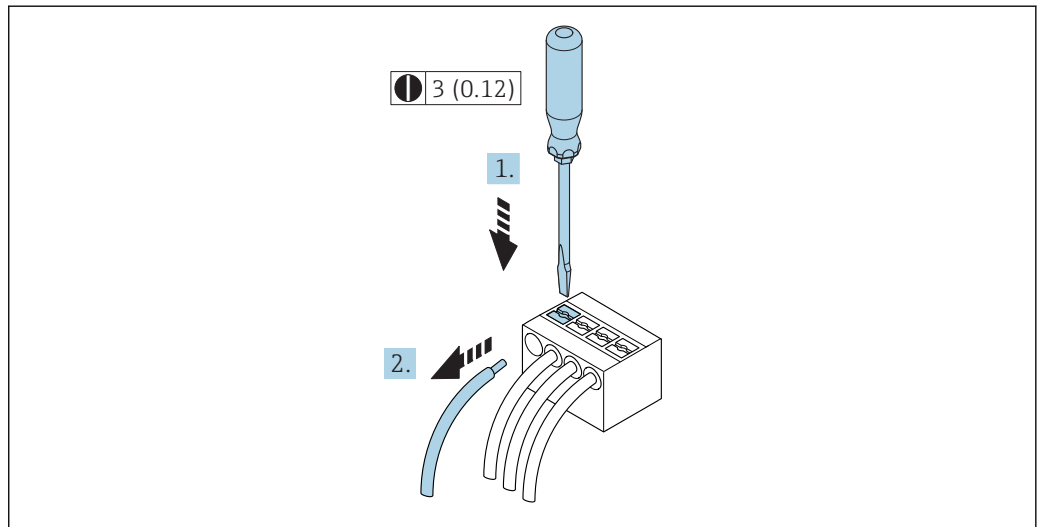

A0029598

17 Engineering unit mm (in)

1. To remove a cable from the terminal, use a flat-blade screwdriver to push the slot between the two terminal holes
2. while simultaneously pulling the cable end out of the terminal.

7.2.3 Integrating the transmitter into a network

This section only presents the basic options for integrating the device into a network.

For information on the procedure to follow to connect the transmitter correctly → 46.

Integrating via the service interface

The device is integrated via the connection to the service interface (CDI-RJ45).

Note the following when connecting:

- Recommended cable: CAT5e, CAT6 or CAT7, with shielded connector
- Maximum cable thickness: 6 mm
- Length of connector including bend protection: 42 mm
- Bending radius: 5 x cable thickness

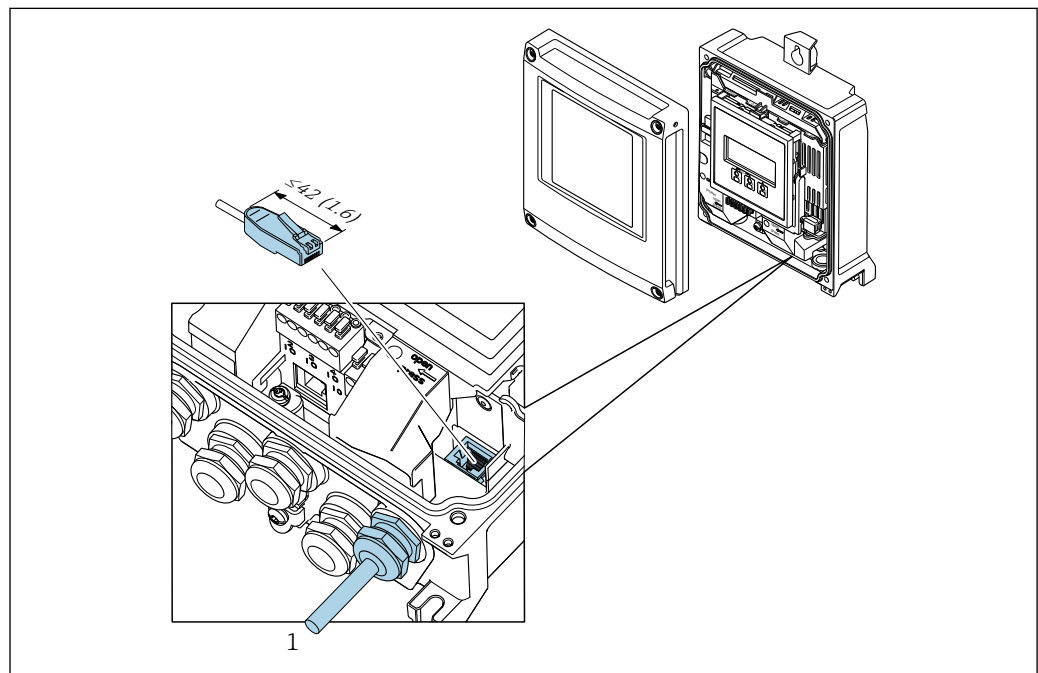

1 Service interface (CDI-RJ45)

i An adapter for RJ45 and the M12 connector is optionally available:
Order code for "Accessories", option **NB**: "Adapter RJ45 M12 (service interface)"

The adapter connects the service interface (CDI-RJ45) to an M12 connector mounted in the cable entry. Therefore the connection to the service interface can be established via an M12 connector without opening the device.

Integrating into a ring topology

The device is integrated via the terminal connection for signal transmission (output 1) and the connection to the service interface (CDI-RJ45).

Note the following when connecting:

- Recommended cable: CAT5e, CAT6 or CAT7, with shielded connector
- Maximum cable thickness: 6 mm
- Length of connector including bend protection: 42 mm
- Bending radius: 2.5 x cable thickness

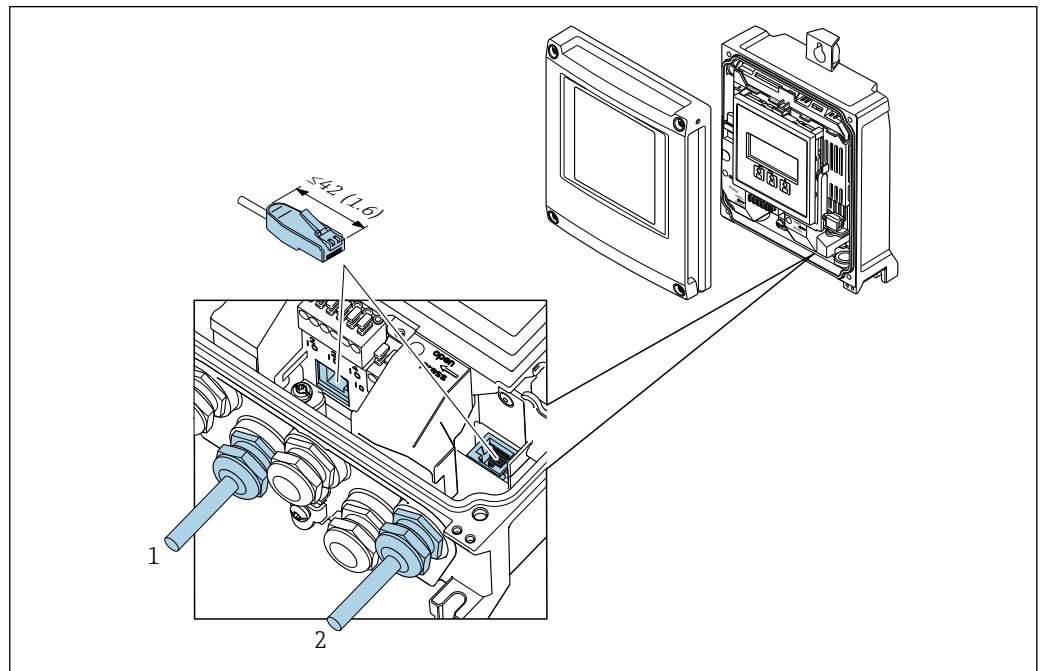

A0033830

- 1 EtherNet/IP connection
2 Service interface (CDI-RJ45)

i An adapter for RJ45 and the M12 connector is optionally available:
Order code for "Accessories", option **NB**: "Adapter RJ45 M12 (service interface)"

The adapter connects the service interface (CDI-RJ45) to an M12 connector mounted in the cable entry. Therefore the connection to the service interface can be established via an M12 connector without opening the device.

7.3 Connecting the measuring device: Proline 500

NOTICE

Limitation of electrical safety due to incorrect connection!

- ▶ Have electrical connection work carried out by appropriately trained specialists only.
- ▶ Observe applicable federal/national installation codes and regulations.
- ▶ Comply with local workplace safety regulations.
- ▶ Always connect the protective ground cable ⊕ before connecting additional cables.
- ▶ For use in potentially explosive atmospheres, observe the information in the device-specific Ex documentation.

7.3.1 Connecting the connecting cable

⚠ WARNING

Risk of damaging the electronic components!

- ▶ Connect the sensor and transmitter to the same potential equalization.
- ▶ Only connect the sensor to a transmitter with the same serial number.
- ▶ Ground the connection housing of the sensor via the external screw terminal.

Connecting cable terminal assignment

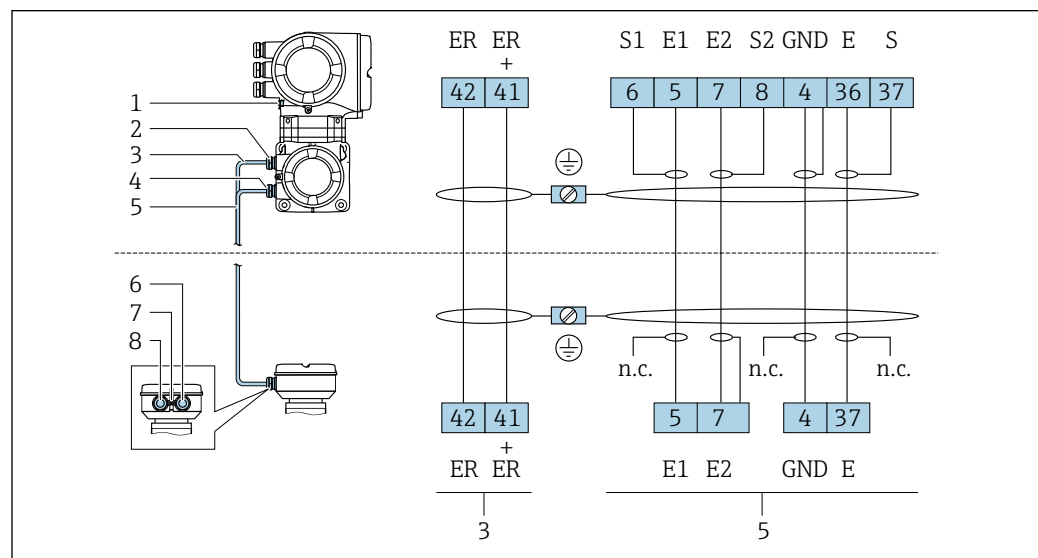

A0029145

- 1 Protective earth (PE)
- 2 Cable entry for coil current cable on transmitter connection housing
- 3 Coil current cable
- 4 Cable entry for signal cable on transmitter connection housing
- 5 Signal cable
- 6 Cable entry for signal cable on sensor connection housing
- 7 Cable entry for coil current cable on sensor connection housing
- 8 Protective earth (PE)

Connecting the connecting cable to the sensor connection housing

Connection via terminals with order code for "Housing":
Option A "Aluminum coated" → 55

Connecting the connecting cable to the transmitter

The cable is connected to the transmitter via terminals → 56.

Connecting the sensor connection housing via terminals

For the device version with the order code for "Housing":

- Option **A** "Aluminum coated"
- Option **L** "Cast, stainless"

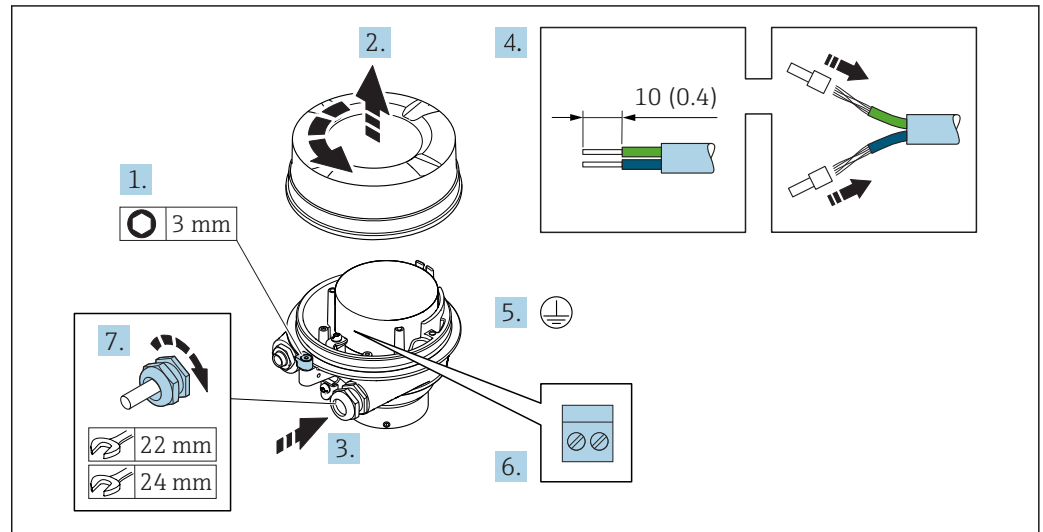

A0029612

1. Loosen the securing clamp of the housing cover.
2. Unscrew the housing cover.
3. Push the cable through the cable entry . To ensure tight sealing, do not remove the sealing ring from the cable entry.
4. Strip the cable and cable ends. In the case of stranded cables, fit ferrules.
5. Connect the protective ground.
6. Connect the cable in accordance with the connecting cable terminal assignment.
7. Firmly tighten the cable glands.
 - ↳ This concludes the process for connecting the connecting cables.

⚠ WARNING

Housing degree of protection voided due to insufficient sealing of the housing.

- ▶ Screw in the thread on the cover without using any lubricant. The thread on the cover is coated with a dry lubricant.
8. Screw on the housing cover.
 9. Tighten the securing clamp of the housing cover.

Connecting the connecting cable to the transmitter

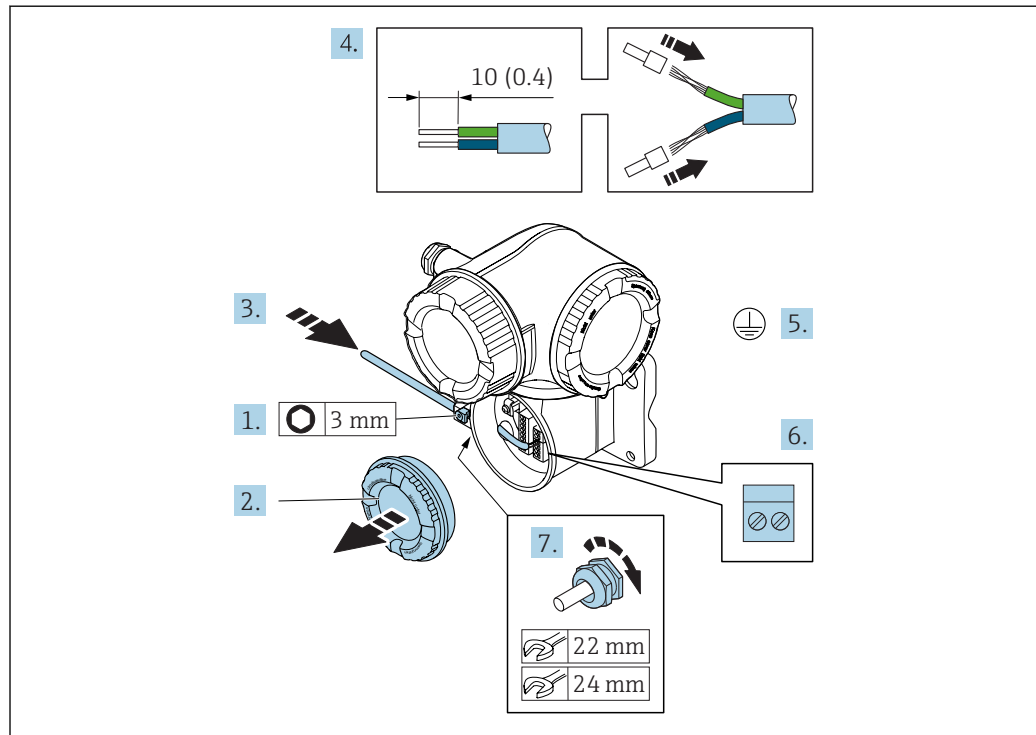

A0029592

1. Loosen the securing clamp of the connection compartment cover.
2. Unscrew the connection compartment cover.
3. Push the cable through the cable entry . To ensure tight sealing, do not remove the sealing ring from the cable entry.
4. Strip the cable and cable ends. In the case of stranded cables, also fit ferrules.
5. Connect the protective ground.
6. Connect the cable in accordance with the connecting cable terminal assignment
→ 54.
7. Firmly tighten the cable glands.
↳ This concludes the process for connecting the connecting cables.
8. Screw on the connection compartment cover.
9. Tighten the securing clamp of the connection compartment cover.
10. After connecting the connecting cables:
Connect the signal cable and the supply voltage cable .

7.3.2 Connecting the transmitter

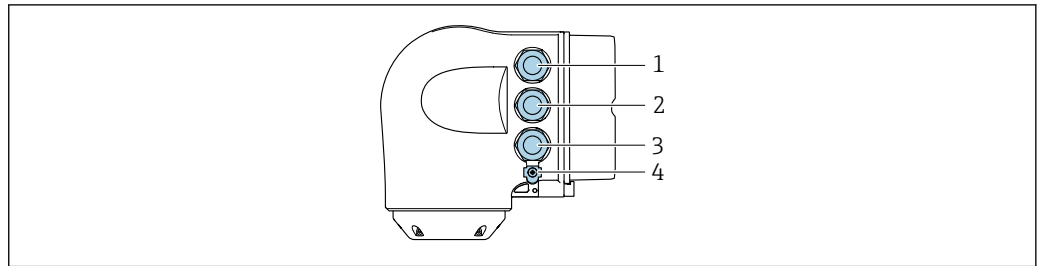

A0026781

- 1 Terminal connection for supply voltage
- 2 Terminal connection for signal transmission, input/output
- 3 Terminal connection for signal transmission, input/output or terminal connection for network connection via service interface (CDI-RJ45)
- 4 Protective earth (PE)

i In addition to connecting the device via EtherNet/IP and the available inputs/outputs, additional connection options are also available:

- Integrate into a network via the service interface (CDI-RJ45) → 60.
- Integrate the device into a ring topology → 61.

Connecting the EtherNet/IP connector

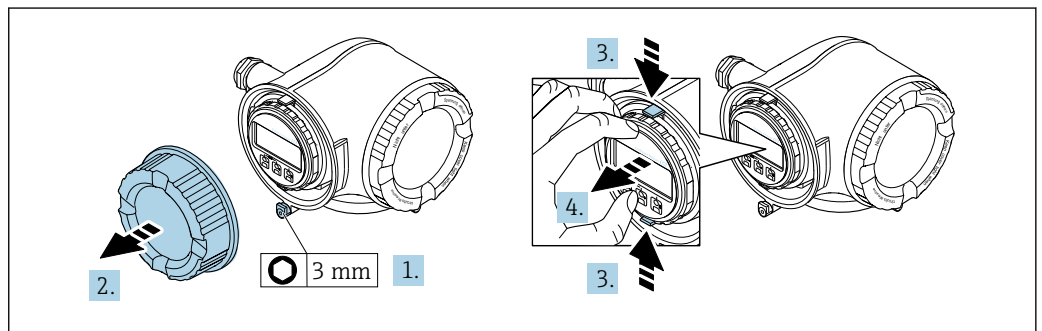

A0029813

1. Loosen the securing clamp of the connection compartment cover.
2. Unscrew the connection compartment cover.
3. Squeeze the tabs of the display module holder together.
4. Remove the display module holder.

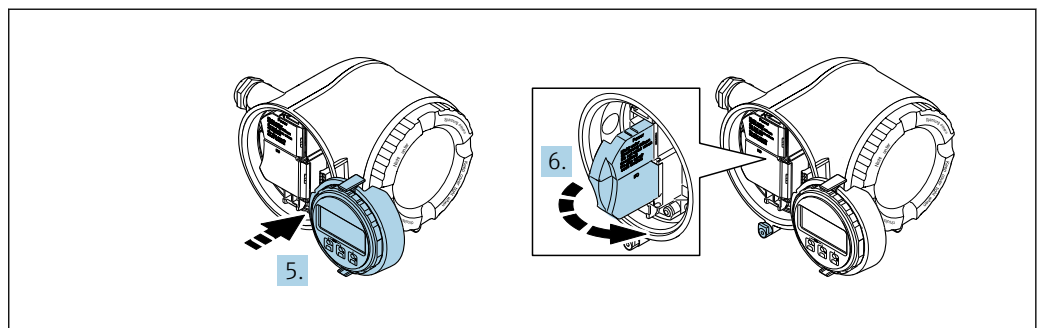

A0029814

5. Attach the holder to the edge of the electronics compartment.
6. Open the terminal cover.

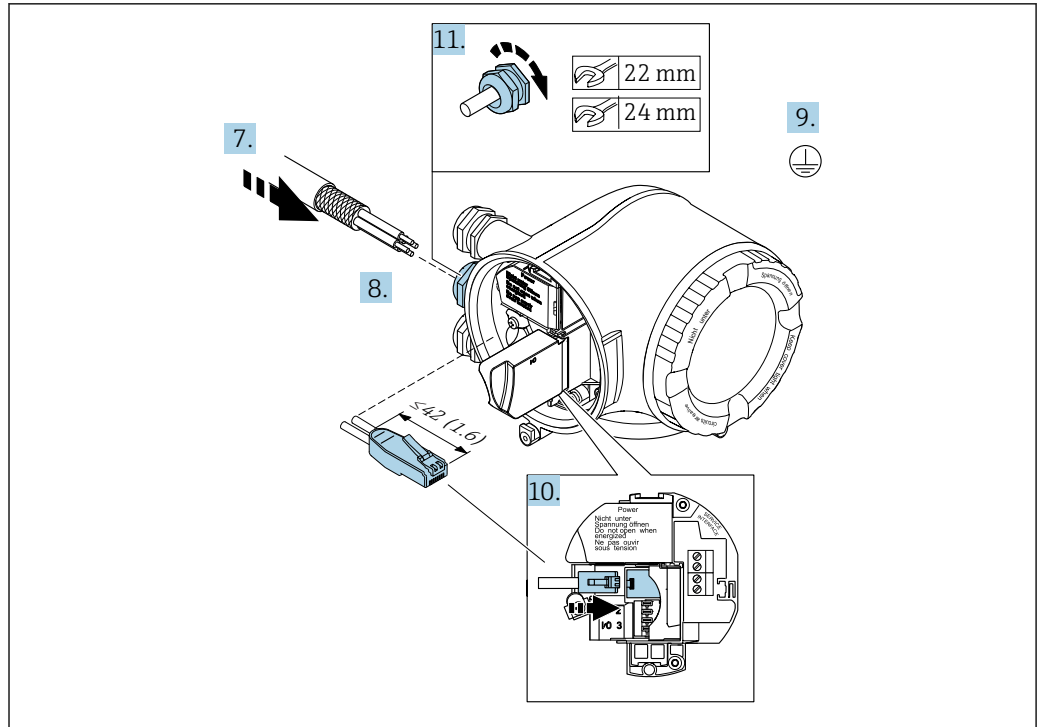

A0033722

7. Push the cable through the cable entry . To ensure tight sealing, do not remove the sealing ring from the cable entry.
8. Strip the cable and cable ends and connect to the RJ45 connector.
9. Connect the protective ground.
10. Plug in the RJ45 connector.
11. Firmly tighten the cable glands.
 - ↳ This concludes the EtherNet/IP connection process.

Connecting the supply voltage and additional inputs/outputs

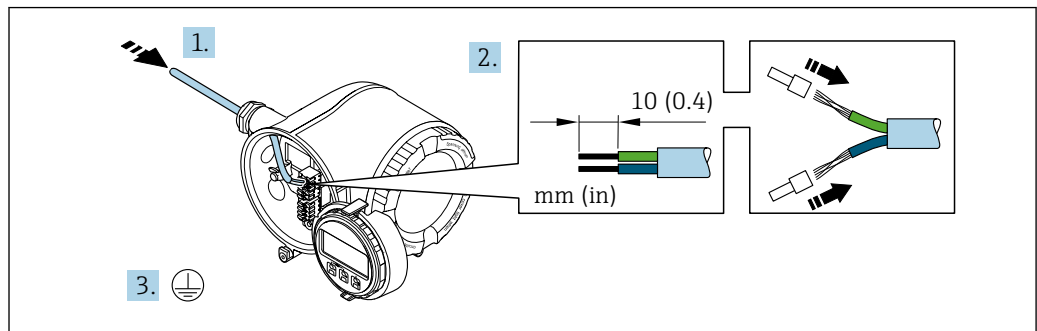

A0033983

1. Push the cable through the cable entry . To ensure tight sealing, do not remove the sealing ring from the cable entry.
2. Strip the cable and cable ends. In the case of stranded cables, also fit ferrules.
3. Connect the protective ground.

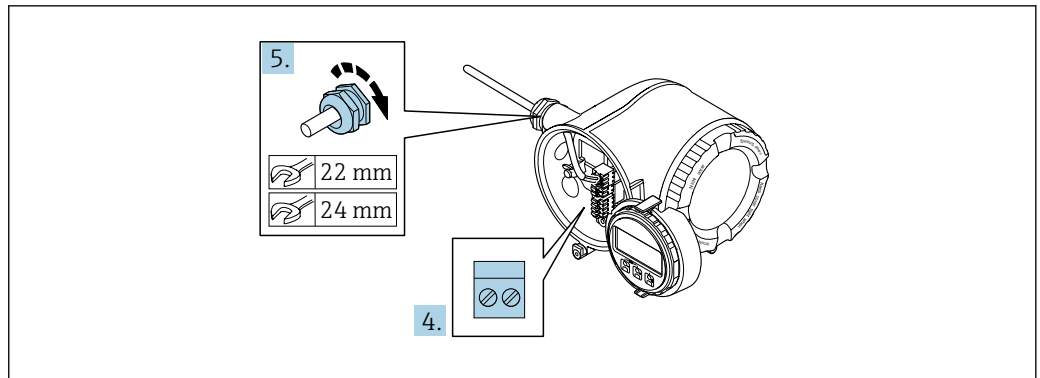

A0033984

4. Connect the cable in accordance with the terminal assignment .
 - ↳ **Signal cable terminal assignment:** The device-specific terminal assignment is documented on an adhesive label in the terminal cover.
 - Supply voltage terminal assignment:** Adhesive label in the terminal cover or → 41.
5. Firmly tighten the cable glands.
 - ↳ This concludes the cable connection process.
6. Close the terminal cover.
7. Fit the display module holder in the electronics compartment.
8. Screw on the connection compartment cover.
9. Secure the securing clamp of the connection compartment cover.

Removing a cable

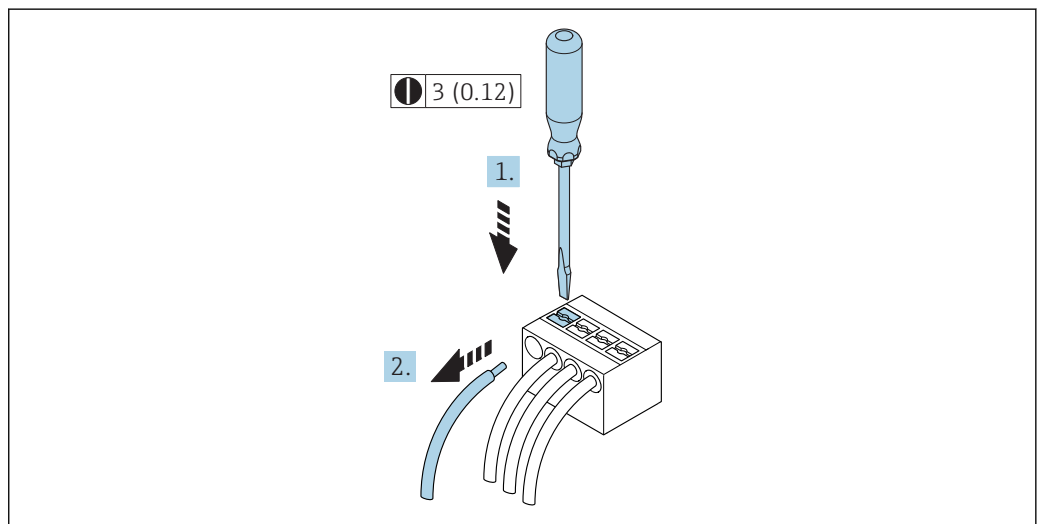

A0029598

18 Engineering unit mm (in)

1. To remove a cable from the terminal, use a flat-blade screwdriver to push the slot between the two terminal holes
2. while simultaneously pulling the cable end out of the terminal.

7.3.3 Integrating the transmitter into a network

This section only presents the basic options for integrating the device into a network.

For information on the procedure to follow to connect the transmitter correctly →  54.

Integrating via the service interface

The device is integrated via the connection to the service interface (CDI-RJ45).

Note the following when connecting:

- Recommended cable: CAT 5e, CAT 6 or CAT 7, with shielded connector
- Maximum cable thickness: 6 mm
- Length of connector including bend protection: 42 mm
- Bending radius: 5 x cable thickness

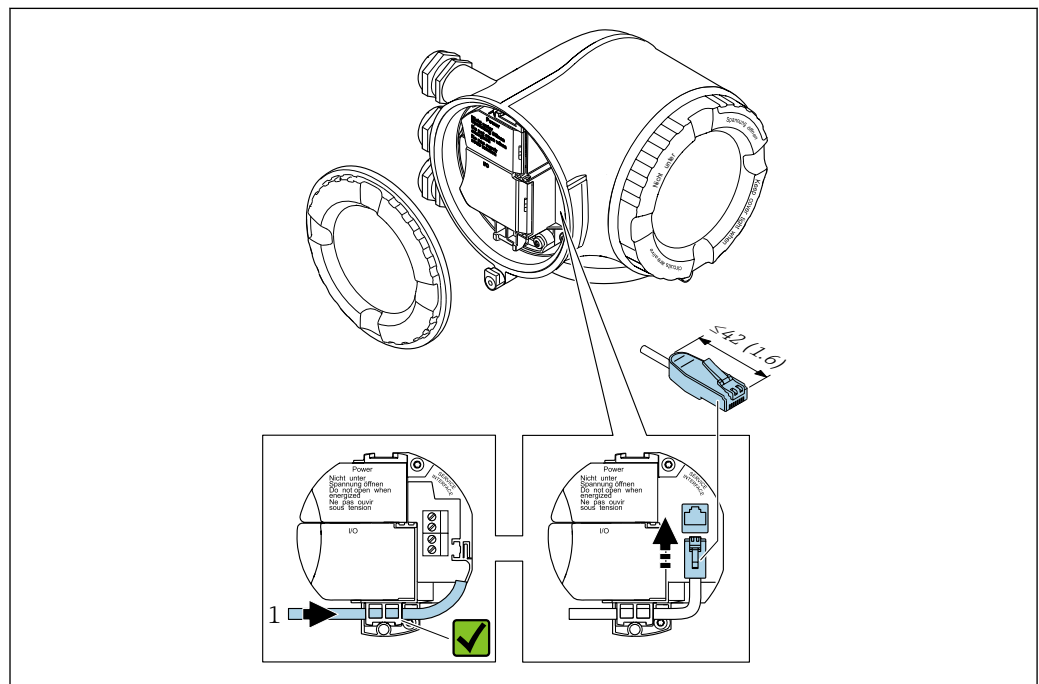

1 Service interface (CDI-RJ45)

-  An adapter for RJ45 and the M12 connector is optionally available:
Order code for "Accessories", option **NB**: "Adapter RJ45 M12 (service interface)"

The adapter connects the service interface (CDI-RJ45) to an M12 connector mounted in the cable entry. Therefore the connection to the service interface can be established via an M12 connector without opening the device.

Integrating into a ring topology

The device is integrated via the terminal connection for signal transmission (output 1) and the connection to the service interface (CDI-RJ45).

Note the following when connecting:

- Recommended cable: CAT5e, CAT6 or CAT7, with shielded connector
- Maximum cable thickness: 6 mm
- Length of connector including bend protection: 42 mm
- Bending radius: 2.5 x cable thickness

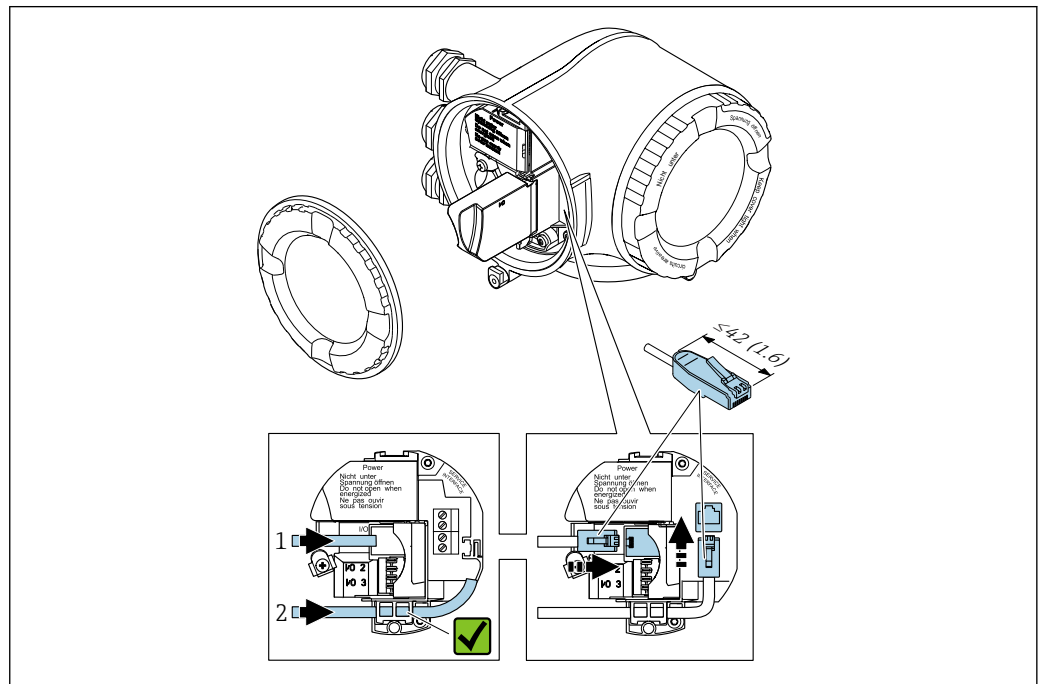

A0033717

- 1 EtherNet/IP connection
- 2 Service interface (CDI-RJ45)

i An adapter for RJ45 and the M12 connector is optionally available:
Order code for "Accessories", option **NB**: "Adapter RJ45 M12 (service interface)"

The adapter connects the service interface (CDI-RJ45) to an M12 connector mounted in the cable entry. Therefore the connection to the service interface can be established via an M12 connector without opening the device.

7.4 Ensure potential equalization

7.4.1 Requirements

CAUTION

Electrode damage can result in the complete failure of the device!

- ▶ Same electrical potential for the medium and sensor
- ▶ Company-internal grounding concepts
- ▶ Pipe material and grounding

7.4.2 Connection example, standard scenario

Metal, grounded pipe

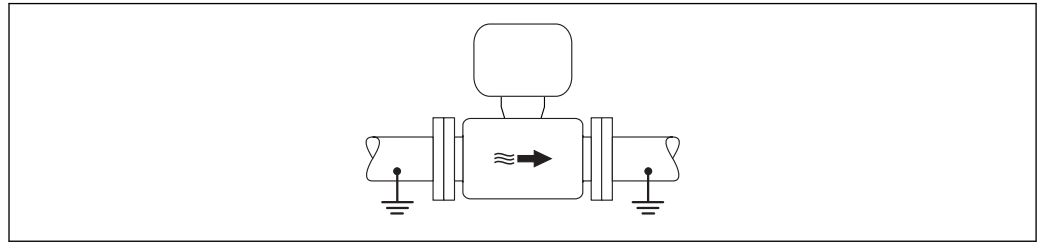

A0016315

19 Potential equalization via measuring tube

7.4.3 Connection example in special situations

Unlined and ungrounded metal pipe

This connection method also applies in situations where:

- The customary potential equalization is not used
- Equalizing currents are present

Ground cable	Copper wire, at least 6 mm ² (0.0093 in ²)
---------------------	---

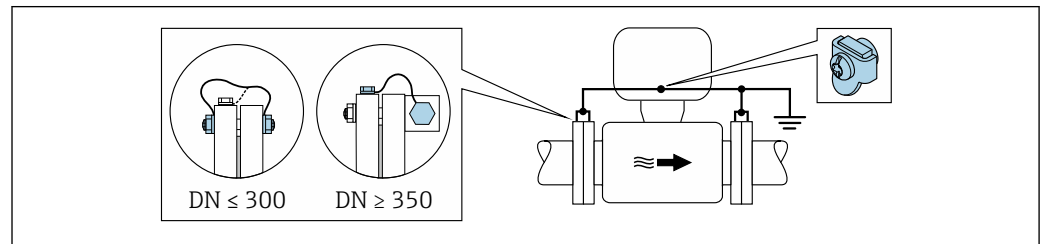

A0029338

20 Potential equalization via ground terminal and pipe flanges

1. Connect both sensor flanges to the pipe flange via a ground cable and ground them.
2. If DN ≤ 300 (12"): Mount the ground cable directly on the conductive flange coating of the sensor with the flange screws.
3. If DN ≥ 350 (14"): Mount the ground cable directly on the metal transport bracket. Observe screw tightening torques: see the Sensor Brief Operating Instructions.
4. Connect the connection housing of the transmitter or sensor to ground potential by means of the ground terminal provided for the purpose.

Plastic pipe or pipe with insulating liner

This connection method also applies in situations where:

- The customary potential equalization is not used
- Equalizing currents are present

Ground cable	Copper wire, at least 6 mm ² (0.0093 in ²)
---------------------	---

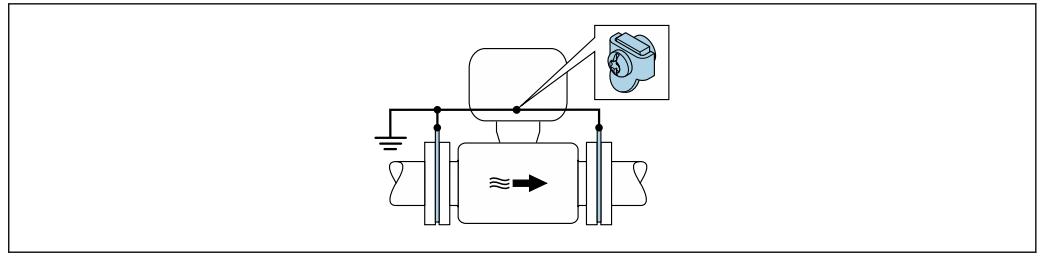

21 Potential equalization via ground terminal and ground disks

1. Connect the ground disks to the ground terminal via the ground cable.
2. Connect the ground disks to ground potential.

Pipe with a cathodic protection unit

This connection method is only used if the following two conditions are met:

- Metal pipe without liner or pipe with electrically conductive liner
- Cathodic protection is integrated in the personal protection equipment

Ground cable	Copper wire, at least 6 mm ² (0.0093 in ²)
---------------------	---

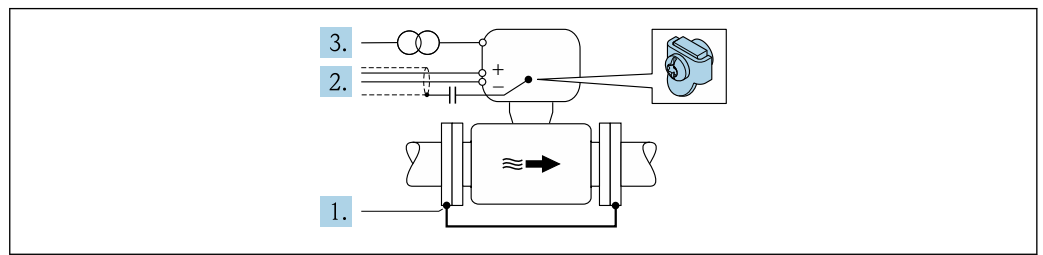

Prerequisite: The sensor is installed in the pipe in a way that provides electrical insulation.

1. Connect the two flanges of the pipe to one another via a ground cable.
2. Guide the shield of the signal lines through a capacitor.
3. Connect the measuring device to the power supply such that it is floating in relation to the protective ground (isolation transformer).

7.5 Special connection instructions

7.5.1 Connection examples

EtherNet/IP

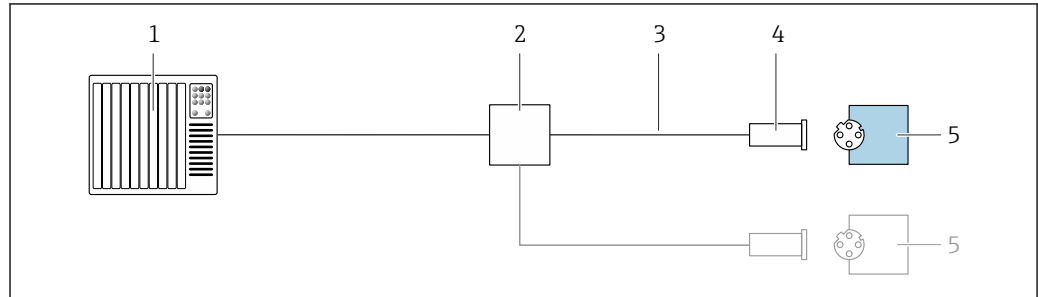

A0028767

22 Connection example for EtherNet/IP

- 1 Control system (e.g. PLC)
- 2 Ethernet switch
- 3 Observe cable specifications
- 4 Device plug
- 5 Transmitter

EtherNet/IP: DLR (Device Level Ring)

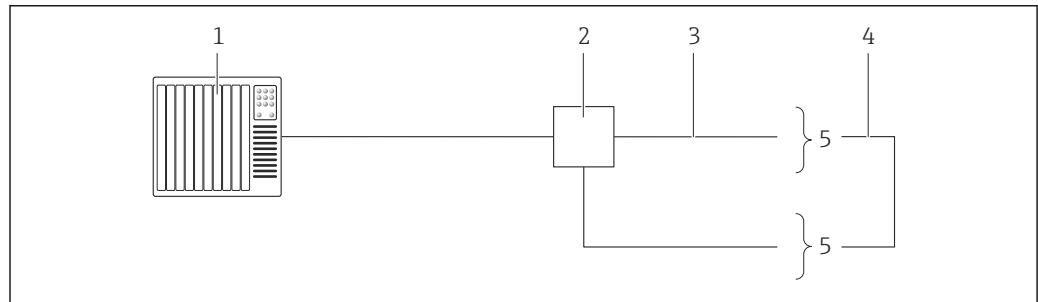

A00287544

- 1 Control system (e.g. PLC)
- 2 Ethernet switch
- 3 Observe cable specifications → 38
- 4 Connecting cable between the two transmitters
- 5 Transmitter

Current output 4-20 mA

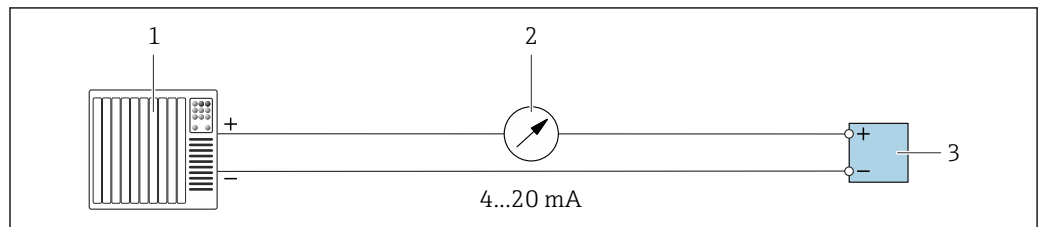

A0028758

23 Connection example for 4-20 mA current output (active)

- 1 Automation system with current input (e.g. PLC)
- 2 Analog display unit: observe maximum load
- 3 Transmitter

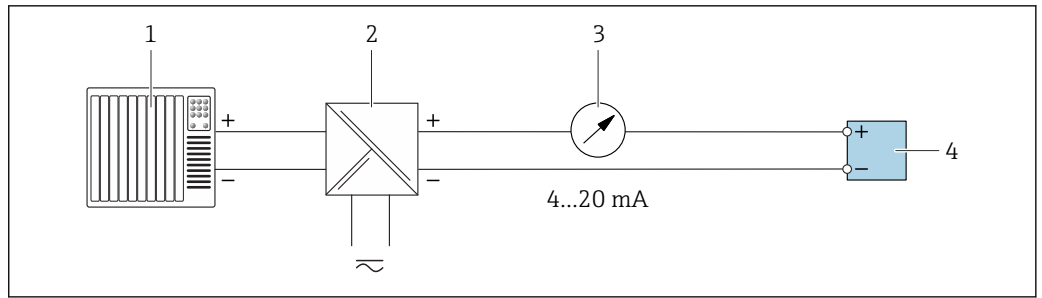

A0028759

24 Connection example for 4-20 mA current output (passive)

- 1 Automation system with current input (e.g. PLC)
- 2 Active barrier for power supply (e.g. RN221N)
- 3 Analog display unit: observe maximum load
- 4 Transmitter

Pulse/frequency output

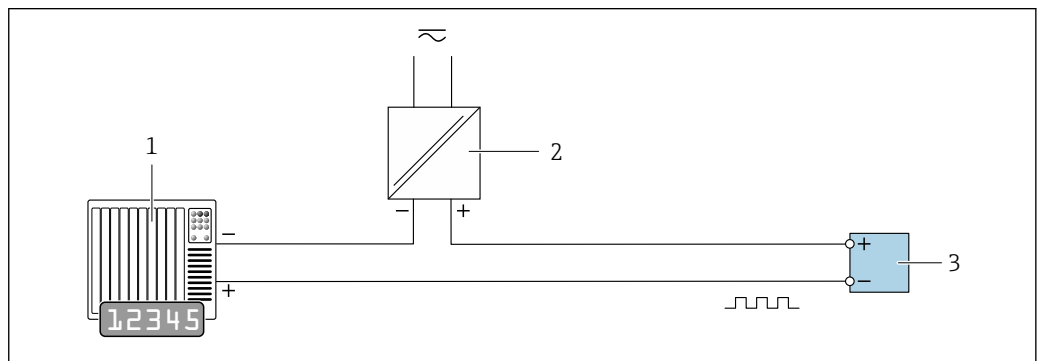

A0028761

25 Connection example for pulse/frequency output (passive)

- 1 Automation system with pulse/frequency input (e.g. PLC)
- 2 Power supply
- 3 Transmitter: Observe input values → 199

Switch output

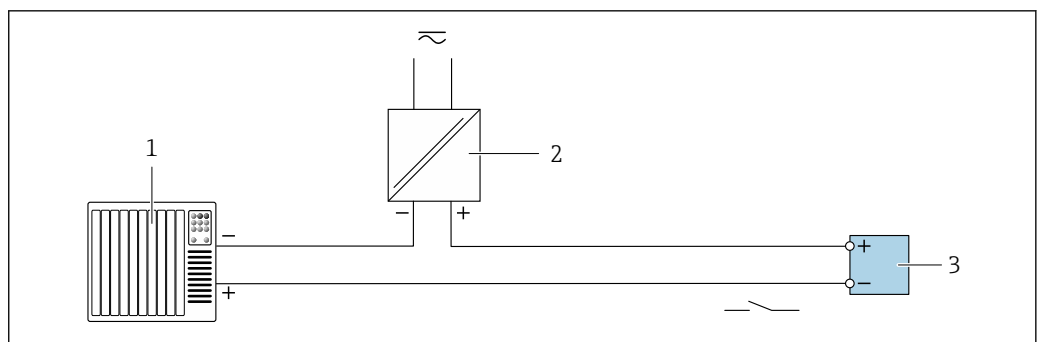

A0028760

26 Connection example for switch output (passive)

- 1 Automation system with switch input (e.g. PLC)
- 2 Power supply
- 3 Transmitter: Observe input values → 199

Relay output

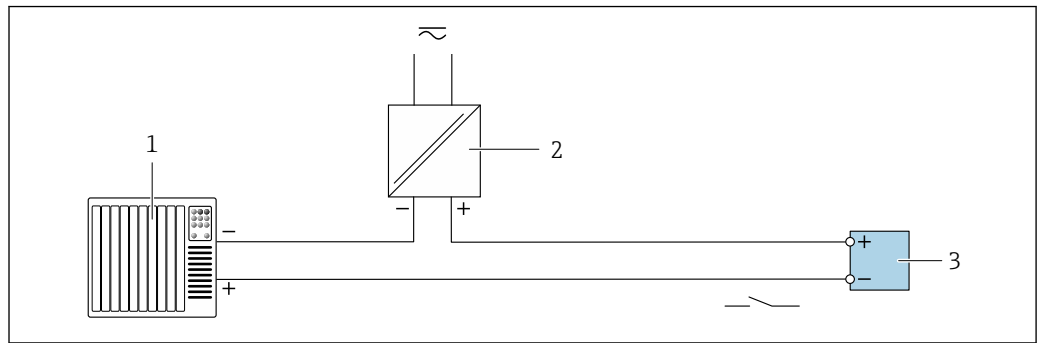

A0028760

27 Connection example for relay output (passive)

- 1 Automation system with relay input (e.g. PLC)
- 2 Power supply
- 3 Transmitter: Observe input values → 200

Current input

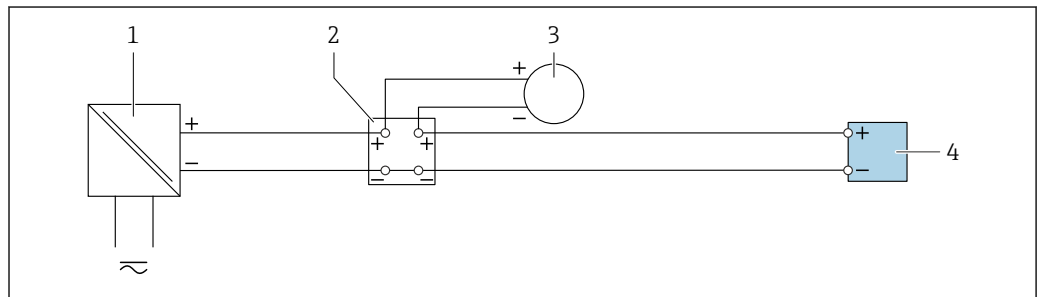

A0028915

28 Connection example for 4 to 20 mA current input

- 1 Power supply
- 2 External measuring device (for reading in pressure or temperature, for instance)
- 3 Transmitter: Observe input values

Status input

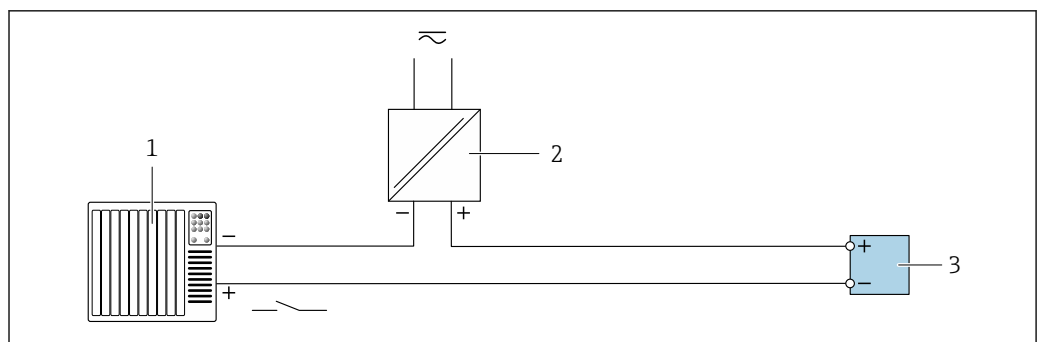

A0028764

29 Connection example for status input

- 1 Automation system with status output (e.g. PLC)
- 2 Power supply
- 3 Transmitter: Observe input values

7.6 Hardware settings

7.6.1 Setting the device address

The IP address of the measuring device can be configured for the network via DIP switches.

Addressing data

IP address and configuration options			
1st octet	2nd octet	3rd octet	4th octet
192.	168.	1.	XXX

↓
Can only be configured via software addressing

↓
Can be configured via software addressing and hardware addressing

IP address range	1 to 254 (4th octet)
IP address broadcast	255
Addressing mode ex works	Software addressing; all DIP switches for hardware addressing are set to OFF.
IP address ex works	DHCP server active

i Software addressing: The IP address is entered via the **IP address** parameter (→  114).

Setting the IP address: Proline 500 - digital

Risk of electric shock when opening the transmitter housing.

- ▶ Before opening the transmitter housing:
- ▶ Disconnect the device from the power supply.

i The default IP address may **not** be activated →  68.

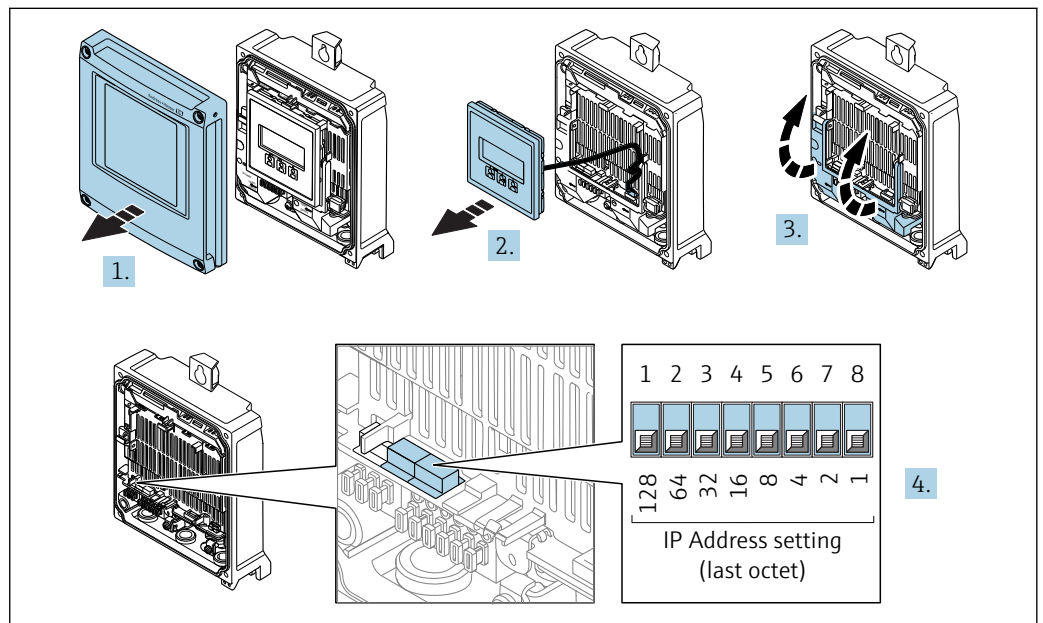

1. Loosen the 4 fixing screws on the housing cover.
2. Open the housing cover.
3. Fold open the terminal cover.

4. Set the desired IP address using the corresponding DIP switches on the I/O electronics module.
5. Reverse the removal procedure to reassemble the transmitter.
6. Reconnect the device to the power supply.
 - ↳ The configured device address is used once the device is restarted.

Setting the IP address: Proline 500

Risk of electric shock when opening the transmitter housing.

- ▶ Before opening the transmitter housing:
- ▶ Disconnect the device from the power supply.

i The default IP address may **not** be activated →  69.

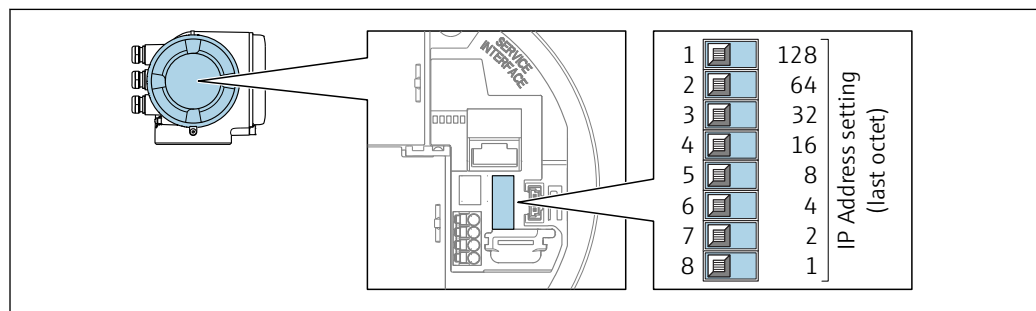

A0029635

1. Depending on the housing version, loosen the securing clamp or fixing screw of the housing cover.
2. Depending on the housing version, unscrew or open the housing cover and disconnect the local display from the main electronics module where necessary.
3. Set the desired IP address using the corresponding DIP switches on the I/O electronics module.
4. Reverse the removal procedure to reassemble the transmitter.
5. Reconnect the device to the power supply.
 - ↳ The configured device address is used once the device is restarted.

7.6.2 Activating the default IP address

The DHCP function is enabled in the device at the factory, i.e. the device expects an IP address to be assigned by the network. This function can be disabled and the device can be set to the default IP address 192.168.1.212 by DIP switch.

Activating the default IP address by DIP switch: Proline 500 - digital

Risk of electric shock when opening the transmitter housing.

- ▶ Before opening the transmitter housing:
- ▶ Disconnect the device from the power supply.

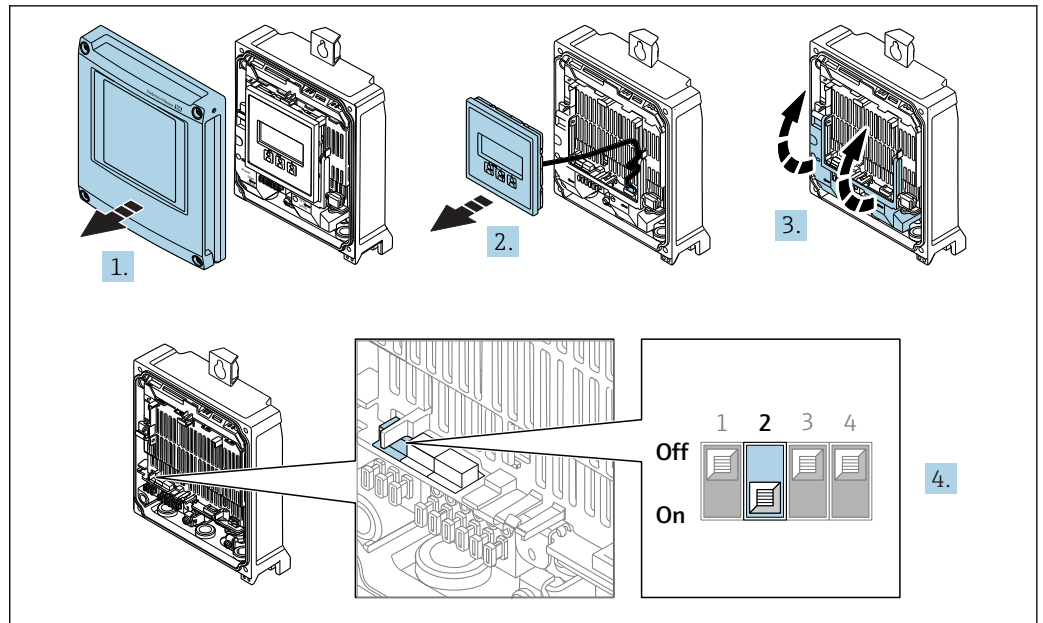

A0034500

1. Loosen the 4 fixing screws on the housing cover.
2. Open the housing cover.
3. Fold open the terminal cover.
4. Set DIP switch No. 2 on the I/O electronics module from **OFF** → **ON**.
5. Reverse the removal procedure to reassemble the transmitter.
6. Reconnect the device to the power supply.
 - ↳ The default IP address is used once the device is restarted.

Activating the default IP address via the DIP switch: Proline 500

Risk of electric shock when opening the transmitter housing.

- ▶ Before opening the transmitter housing:
- ▶ Disconnect the device from the power supply.

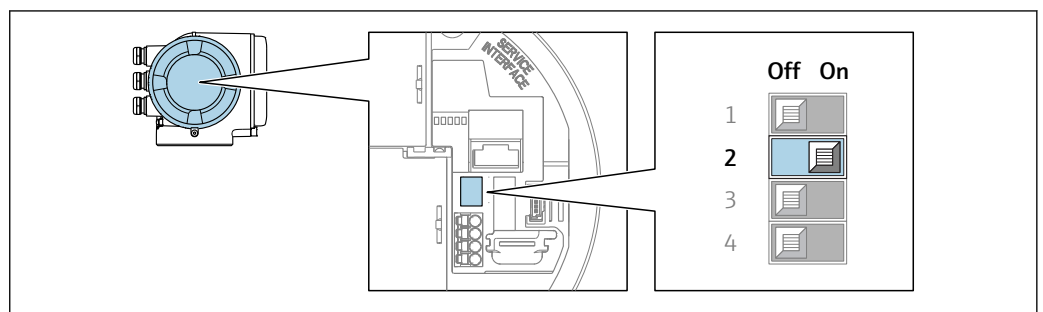

A0034499

1. Depending on the housing version, loosen the securing clamp or fixing screw of the housing cover.
2. Depending on the housing version, unscrew or open the housing cover and disconnect the local display from the main electronics module where necessary .
3. Set DIP switch No. 2 on the I/O electronics module from **OFF** → **ON**.
4. Reverse the removal procedure to reassemble the transmitter.
5. Reconnect the device to the power supply.
 - ↳ The default IP address is used once the device is restarted.

7.7 Ensuring the degree of protection

The measuring device fulfills all the requirements for the IP66/67 degree of protection, Type 4X enclosure.

To guarantee IP66/67 degree of protection, Type 4X enclosure, carry out the following steps after the electrical connection:

1. Check that the housing seals are clean and fitted correctly.
2. Dry, clean or replace the seals if necessary.
3. Tighten all housing screws and screw covers.
4. Firmly tighten the cable glands.
5. To ensure that moisture does not enter the cable entry:
Route the cable so that it loops down before the cable entry ("water trap").

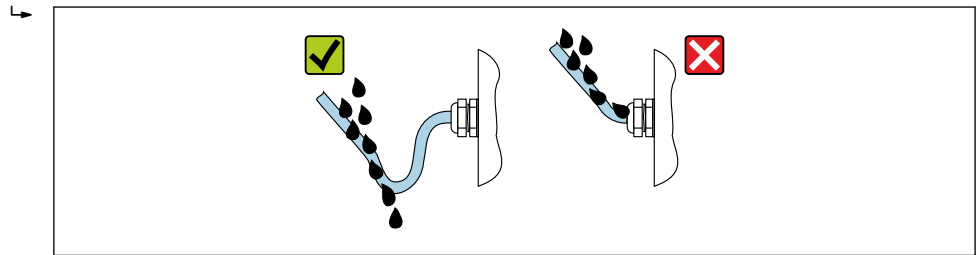

A0029278

6. Insert dummy plugs into unused cable entries.

7.8 Post-connection check

Are cables or the device undamaged (visual inspection)?	<input type="checkbox"/>
Do the cables used meet the requirements?	<input type="checkbox"/>
Do the cables have adequate strain relief?	<input type="checkbox"/>
Are all the cable glands installed, firmly tightened and leak-tight? Cable run with "water trap" → 70 ?	<input type="checkbox"/>
Is the potential equalization established correctly ?	<input type="checkbox"/>

8 Operation options

8.1 Overview of operation options

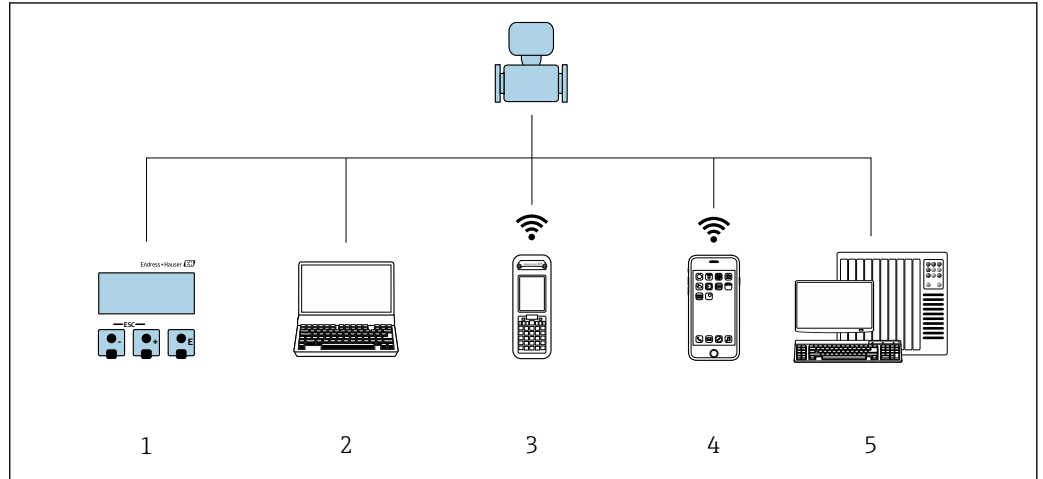



A0034513

- 1 Local operation via display module
- 2 Computer with Web browser (e.g. Internet Explorer) or with operating tool (e.g. FieldCare, DeviceCare, AMS Device Manager, SIMATIC PDM)
- 3 Field Xpert SFX350 or SFX370
- 5 Mobile handheld terminal
- 6 Control system (e.g. PLC)

8.2 Structure and function of the operating menu

8.2.1 Structure of the operating menu

 For an overview of the operating menu for experts: "Description of Device Parameters" document supplied with the device →  221

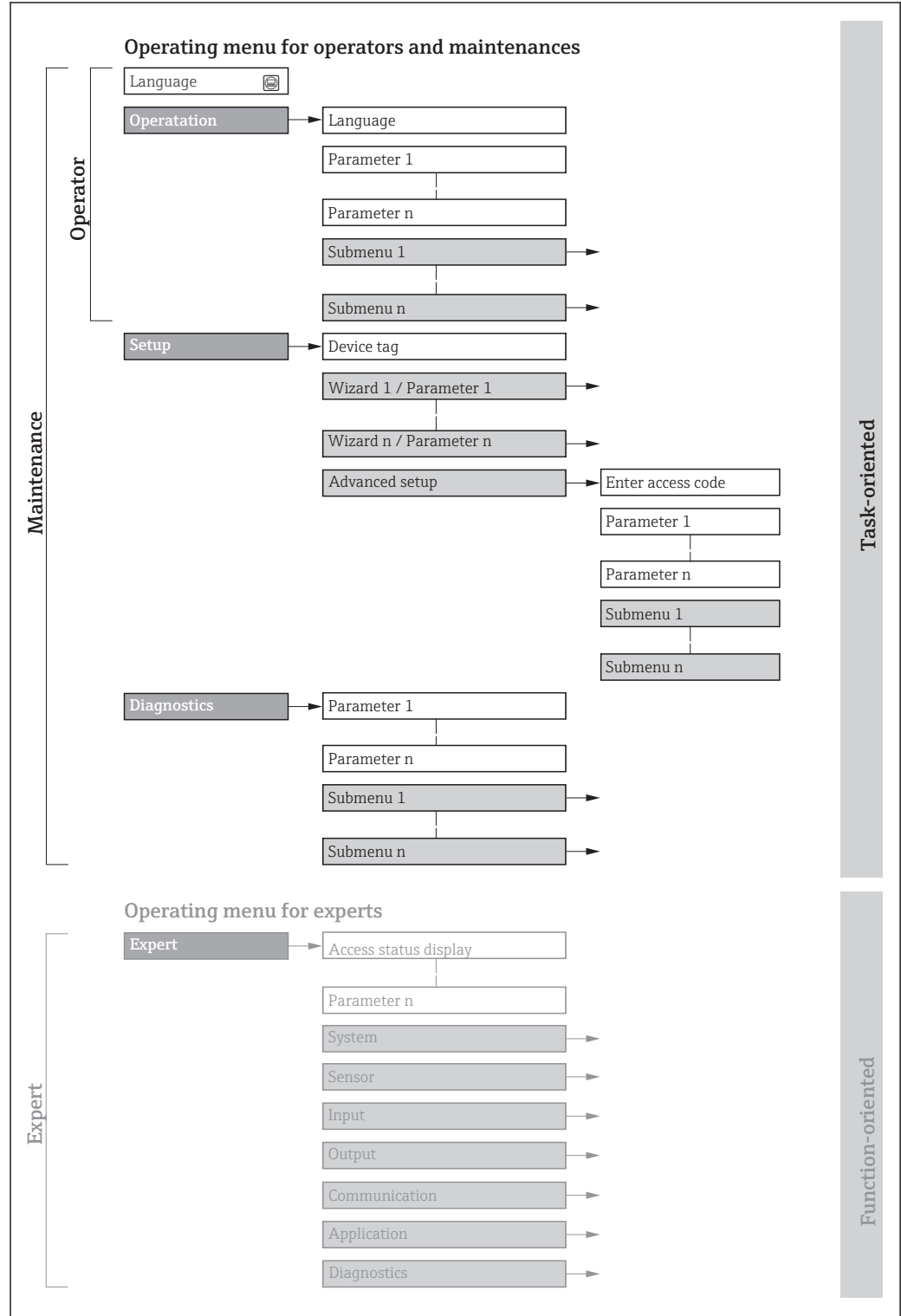

 30 Schematic structure of the operating menu

A0018237-EN

8.2.2 Operating philosophy

The individual parts of the operating menu are assigned to certain user roles (operator, maintenance etc.). Each user role contains typical tasks within the device lifecycle.

Menu/parameter		User role and tasks	Content/meaning
Language	task-oriented	Role "Operator", "Maintenance" Tasks during operation: <ul style="list-style-type: none"> Configuring the operational display Reading measured values 	<ul style="list-style-type: none"> Defining the operating language Defining the Web server operating language Resetting and controlling totalizers
Operation			<ul style="list-style-type: none"> Configuring the operational display (e.g. display format, display contrast) Resetting and controlling totalizers
Setup		"Maintenance" role Commissioning: <ul style="list-style-type: none"> Configuration of the measurement Configuration of the inputs and outputs Configuration of the communication interface 	Wizards for fast commissioning: <ul style="list-style-type: none"> Set the system units Display I/O/configuration Configure the inputs Configure the outputs Configuring the operational display Define the output conditioning Set the low flow cut off Configure empty pipe detection Advanced setup <ul style="list-style-type: none"> For more customized configuration of the measurement (adaptation to special measuring conditions) Configuration of totalizers Configuration of electrode cleaning (optional) Configure the WLAN settings Administration (define access code, reset measuring device)
Diagnostics	"Maintenance" role Fault elimination: <ul style="list-style-type: none"> Diagnostics and elimination of process and device errors Measured value simulation 	Contains all parameters for error detection and analyzing process and device errors: <ul style="list-style-type: none"> Diagnostics list Contains up to 5 currently pending diagnostic messages. Event logbook Contains event messages that have occurred. Device information Contains information for identifying the device. Measured values Contains all current measured values. Data logging submenu with "Extended HistoROM" order option Storage and visualization of measured values Heartbeat The functionality of the device is checked on demand and the verification results are documented. Simulation Is used to simulate measured values or output values. 	
Expert	function-oriented	Tasks that require detailed knowledge of the function of the device: <ul style="list-style-type: none"> Commissioning measurements under difficult conditions Optimal adaptation of the measurement to difficult conditions Detailed configuration of the communication interface Error diagnostics in difficult cases 	Contains all the parameters of the device and makes it possible to access these parameters directly using an access code. The structure of this menu is based on the function blocks of the device: <ul style="list-style-type: none"> System Contains all higher-order device parameters which do not concern the measurement or the communication interface. Sensor Configuration of the measurement. Input Configuring the status input. Output Configuring of the analog current outputs as well as the pulse/frequency and switch output. Communication Configuration of the digital communication interface and the Web server. Application Configure the functions that go beyond the actual measurement (e.g. totalizer). Diagnostics Error detection and analysis of process and device errors and for device simulation and Heartbeat Technology.

8.3 Access to the operating menu via the local display

8.3.1 Operational display

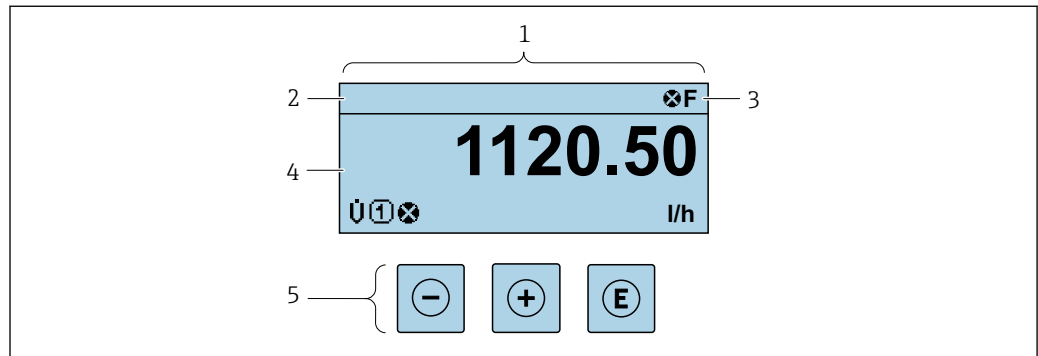

A0029346

- 1 Operational display
- 2 Device tag → 111
- 3 Status area
- 4 Display area for measured values (4-line)
- 5 Operating elements → 79

Status area

The following symbols appear in the status area of the operational display at the top right:

- Status signals → 166
 - **F**: Failure
 - **C**: Function check
 - **S**: Out of specification
 - **M**: Maintenance required
- Diagnostic behavior → 167
 - : Alarm
 - : Warning
- : Locking (the device is locked via the hardware)
- : Communication (communication via remote operation is active)

Display area

In the display area, each measured value is prefaced by certain symbol types for further description:

	Measured variable	Measurement channel number	Diagnostic behavior
	↓	↓	↓
Example			

Appears only if a diagnostics event is present for this measured variable.

Measured values

Symbol	Meaning
U	Volume flow
G	Conductivity

	Mass flow
	Totalizer The measurement channel number indicates which of the three totalizers is displayed.
	Output The measurement channel number indicates which of the outputs is displayed.
	Status input

Measurement channel numbers

Symbol	Meaning
	Measurement channel 1 to 4
The measurement channel number is displayed only if more than one channel is present for the same measured variable type (e.g. Totalizer 1 to 3).	

Diagnostic behavior

The diagnostic behavior pertains to a diagnostic event that is relevant to the displayed measured variable. For information on the symbols → 167

The number and display format of the measured values can be configured via the **Format display** parameter (→ 127).

8.3.2 Navigation view



In the submenu	In the wizard
<p>1 Navigation view 2 Navigation path to current position 3 Status area 4 Display area for navigation 5 Operating elements → 79</p>	

Navigation path

The navigation path - displayed at the top left in the navigation view - consists of the following elements:

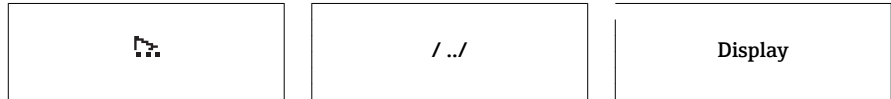
<ul style="list-style-type: none"> In the submenu: Display symbol for menu In the wizard: Display symbol for wizard 	Omission symbol for operating menu levels in between	Name of current <ul style="list-style-type: none"> Submenu Wizard Parameters
↓	↓	↓
Examples		





 For more information about the icons in the menu, refer to the "Display area" section →  76

Status area





The following appears in the status area of the navigation view in the top right corner:

- In the submenu
 - The direct access code for the parameter you are navigating to (e.g. 0022-1)
 - If a diagnostic event is present, the diagnostic behavior and status signal
- In the wizard
 - If a diagnostic event is present, the diagnostic behavior and status signal





-  ▪ For information on the diagnostic behavior and status signal →  166
- For information on the function and entry of the direct access code →  81

Display area

Menus

Symbol	Meaning
	Operation Appears: <ul style="list-style-type: none"> ▪ In the menu next to the "Operation" selection ▪ At the left in the navigation path in the Operation menu
	Setup Appears: <ul style="list-style-type: none"> ▪ In the menu next to the "Setup" selection ▪ At the left in the navigation path in the Setup menu
	Diagnostics Appears: <ul style="list-style-type: none"> ▪ In the menu next to the "Diagnostics" selection ▪ At the left in the navigation path in the Diagnostics menu
	Expert Appears: <ul style="list-style-type: none"> ▪ In the menu next to the "Expert" selection ▪ At the left in the navigation path in the Expert menu



Submenus, wizards, parameters

Symbol	Meaning
	Submenu
	Wizard
	Parameters within a wizard  No display symbol exists for parameters in submenus.

Locking

Symbol	Meaning
	Parameter locked When displayed in front of a parameter name, indicates that the parameter is locked. <ul style="list-style-type: none"> ▪ By a user-specific access code ▪ By the hardware write protection switch

Wizard operation

Symbol	Meaning
	Switches to the previous parameter.
	Confirms the parameter value and switches to the next parameter.
	Opens the editing view of the parameter.

8.3.3 Editing view

Numeric editor

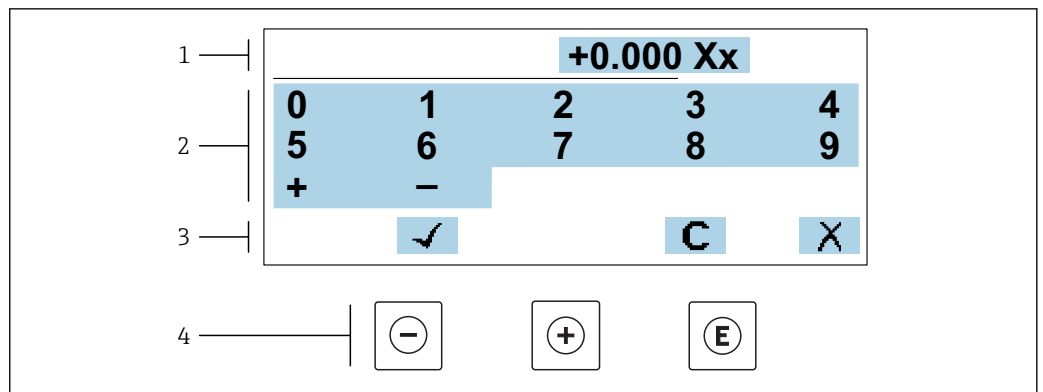

A0034250

31 For entering values in parameters (e.g. limit values)

- 1 Entry display area
- 2 Input screen
- 3 Confirm, delete or reject entry
- 4 Operating elements

Text editor

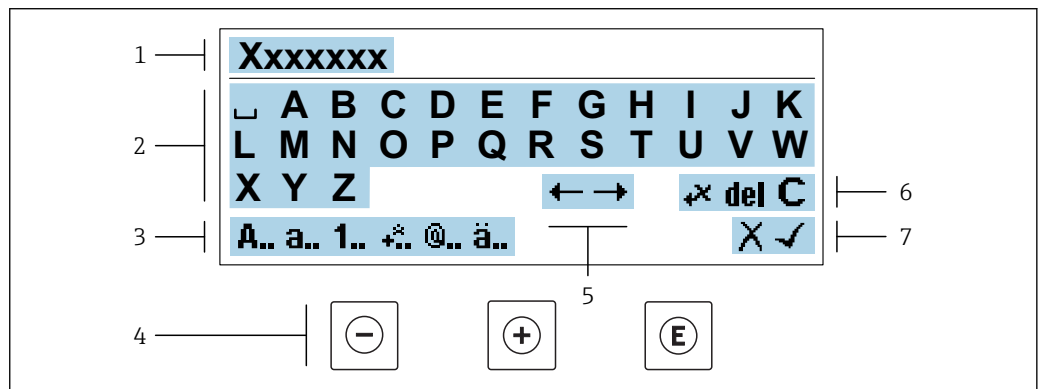

A0034114

32 For entering text in parameters (e.g. tag name)

- 1 Entry display area
- 2 Current input screen
- 3 Change input screen
- 4 Operating elements
- 5 Move entry position
- 6 Delete entry
- 7 Reject or confirm entry

Using the operating elements in the editing view

Operating key(s)	Meaning
	Minus key Move the entry position to the left.
	Plus key Move the entry position to the right.
	Enter key <ul style="list-style-type: none"> ▪ Press the key briefly: confirm your selection. ▪ Press the key for 2 s: confirm the entry.
	Escape key combination (press keys simultaneously) Close the editing view without accepting the changes.





Input screens

Symbol	Meaning
A..	Upper case
a..	Lower case
1..	Numbers
	Punctuation marks and special characters: = + - * / ² ³ ¼ ½ ¾ () [] < > { }
	Punctuation marks and special characters: ' " ^ ` , ; : ? ! % μ ° € \$ £ ¥ § @ # / \ ~ & _
ä..	Umlauts and accents

Controlling data entries

Symbol	Meaning
	Move entry position
	Reject entry
	Confirm entry
	Delete character immediately to the left of the entry position
del	Delete character immediately to the right of the entry position
C	Clear all the characters entered

8.3.4 Operating elements

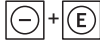
Operating key(s)	Meaning
	<p>Minus key</p> <p><i>In a menu, submenu</i> Moves the selection bar upwards in a choose list.</p> <p><i>With a Wizard</i> Confirms the parameter value and goes to the previous parameter.</p> <p><i>With a text and numeric editor</i> Move the entry position to the left.</p>
	<p>Plus key</p> <p><i>In a menu, submenu</i> Moves the selection bar downwards in a choose list.</p> <p><i>With a Wizard</i> Confirms the parameter value and goes to the next parameter.</p> <p><i>With a text and numeric editor</i> Move the entry position to the right.</p>
	<p>Enter key</p> <p><i>For operational display</i></p> <ul style="list-style-type: none"> ▪ Pressing the key briefly opens the operating menu. ▪ Pressing the key for 2 s opens the context menu including the option for activating the keypad lock. <p><i>In a menu, submenu</i></p> <ul style="list-style-type: none"> ▪ Pressing the key briefly: <ul style="list-style-type: none"> - Opens the selected menu, submenu or parameter. - Starts the wizard. - If help text is open, closes the help text of the parameter. ▪ Pressing the key for 2 s for parameter: <ul style="list-style-type: none"> - If present, opens the help text for the function of the parameter. <p><i>With a Wizard</i> Opens the editing view of the parameter.</p> <p><i>With a text and numeric editor</i></p> <ul style="list-style-type: none"> ▪ Press the key briefly: confirm your selection. ▪ Press the key for 2 s: confirm the entry.
	<p>Escape key combination (press keys simultaneously)</p> <p><i>In a menu, submenu</i></p> <ul style="list-style-type: none"> ▪ Pressing the key briefly: <ul style="list-style-type: none"> - Exits the current menu level and takes you to the next higher level. - If help text is open, closes the help text of the parameter. ▪ Pressing the key for 2 s returns you to the operational display ("home position"). <p><i>With a Wizard</i> Exits the wizard and takes you to the next higher level.</p> <p><i>With a text and numeric editor</i> Close the editing view without accepting the changes.</p>
	<p>Minus/Enter key combination (press the keys simultaneously)</p> <p>Press the key for 3 s: deactivate the keypad lock.</p>

8.3.5 Opening the context menu

Using the context menu, the user can call up the following menus quickly and directly from the operational display:

- Setup
- Data backup
- Simulation

Calling up and closing the context menu

The user is in the operational display.

1. Press \square for 2 s.
↳ The context menu opens.

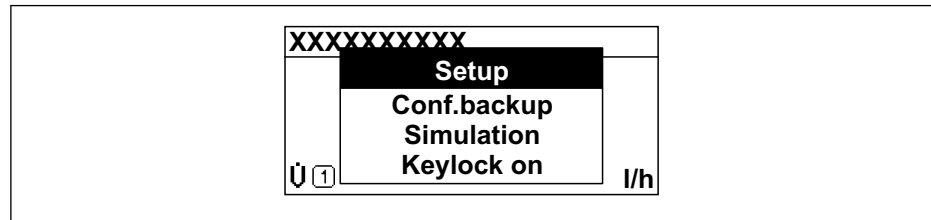

A0034608-EN

2. Press \square + \square simultaneously.
↳ The context menu is closed and the operational display appears.

Calling up the menu via the context menu

1. Open the context menu.
2. Press \uparrow to navigate to the desired menu.
3. Press \square to confirm the selection.
↳ The selected menu opens.

8.3.6 Navigating and selecting from list

Different operating elements are used to navigate through the operating menu. The navigation path is displayed on the left in the header. Icons are displayed in front of the individual menus. These icons are also shown in the header during navigation.

 For an explanation of the navigation view with symbols and operating elements →  75

Example: Setting the number of displayed measured values to "2 values"

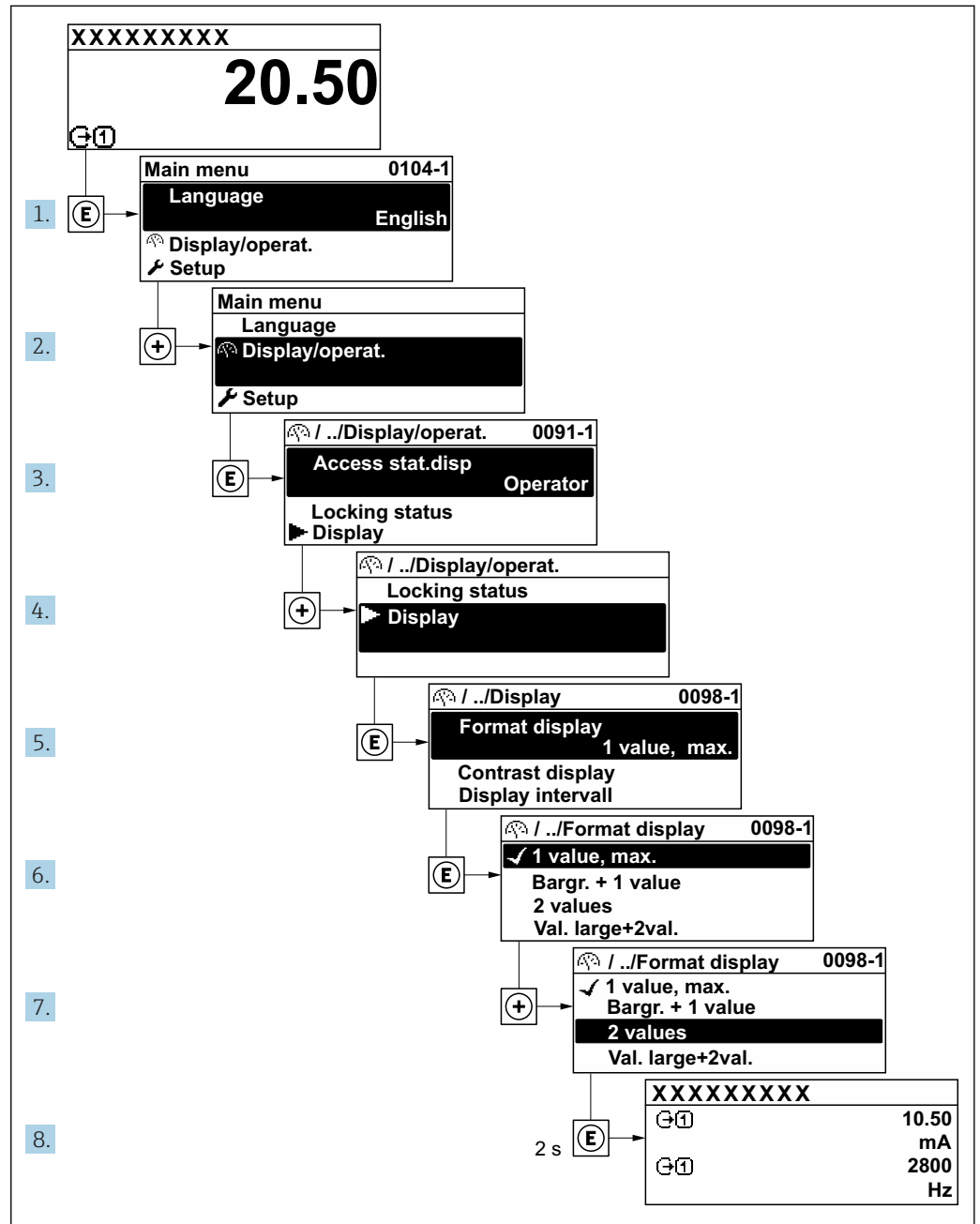

A0029562-EN

8.3.7 Calling the parameter directly

A parameter number is assigned to every parameter to be able to access a parameter directly via the onsite display. Entering this access code in the **Direct access** parameter calls up the desired parameter directly.

Navigation path

Expert → Direct access

The direct access code consists of a 5-digit number (at maximum) and the channel number, which identifies the channel of a process variable: e.g. 00914-2. In the navigation view, this appears on the right-hand side in the header of the selected parameter.

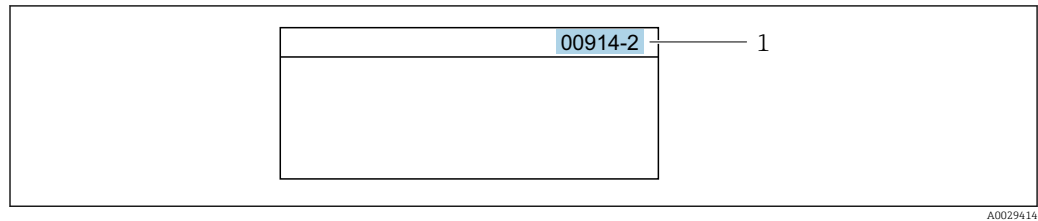

1 Direct access code

Note the following when entering the direct access code:

- The leading zeros in the direct access code do not have to be entered.
Example: Enter "914" instead of "00914"
- If no channel number is entered, channel 1 is accessed automatically.
Example: Enter 00914 → **Assign process variable** parameter
- If a different channel is accessed: Enter the direct access code with the corresponding channel number.
Example: Enter 00914-2 → **Assign process variable** parameter



For the direct access codes of the individual parameters, see the "Description of Device Parameters" document for the device

8.3.8 Calling up help text

Help text is available for some parameters and can be called up from the navigation view. The help text provides a brief explanation of the parameter function and thereby supports swift and safe commissioning.

Calling up and closing the help text

The user is in the navigation view and the selection bar is on a parameter.

1. Press **Enter** for 2 s.
↳ The help text for the selected parameter opens.

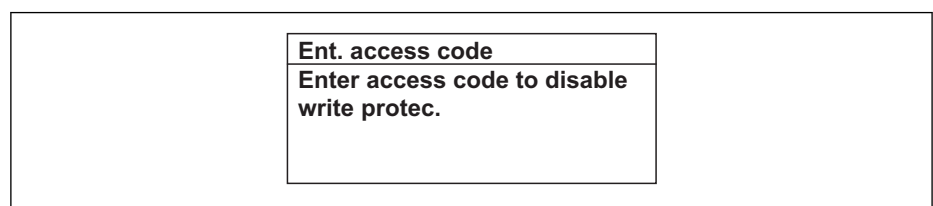

33 Example: Help text for parameter "Enter access code"

2. Press **Esc** + **Enter** simultaneously.
↳ The help text is closed.

8.3.9 Changing the parameters



Parameters can be changed via the numeric editor or text editor.

- Numeric editor: Change values in a parameter, e.g. specifications for limit values.
- Text editor: Enter text in a parameter, e.g. tag name.

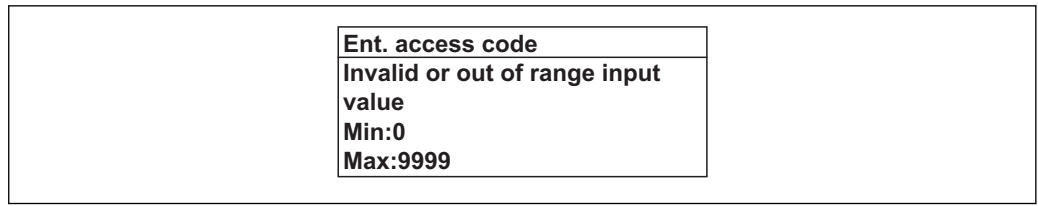
A message is displayed if the value entered is outside the permitted value range.



A0014049-EN

 For a description of the editing view - consisting of the text editor and numeric editor - with symbols →  77, for a description of the operating elements →  79

8.3.10 User roles and related access authorization

The two user roles "Operator" and "Maintenance" have different write access to the parameters if the customer defines a user-specific access code. This protects the device configuration via the local display from unauthorized access →  146.

Defining access authorization for user roles

An access code is not yet defined when the device is delivered from the factory. Access authorization (read and write access) to the device is not restricted and corresponds to the "Maintenance" user role.

- ▶ Define the access code.
 - ↳ The "Operator" user role is redefined in addition to the "Maintenance" user role. Access authorization differs for the two user roles.

Access authorization to parameters: "Maintenance" user role

Access code status	Read access	Write access
An access code has not yet been defined (factory setting).	✓	✓
After an access code has been defined.	✓	✓ ¹⁾

1) The user only has write access after entering the access code.



Access authorization to parameters: "Operator" user role

Access code status	Read access	Write access
After an access code has been defined.	✓	-- ¹⁾

1) Despite the defined access code, certain parameters can always be modified and thus are exempted from the write protection, as they do not affect the measurement. Refer to the "Write protection via access code" section

 The user role with which the user is currently logged on is indicated by the **Access status** parameter. Navigation path: Operation → Access status

8.3.11 Disabling write protection via access code

If the -symbol appears on the local display in front of a parameter, the parameter is write-protected by a user-specific access code and its value cannot be changed at the moment using local operation →  146.

Parameter write protection via local operation can be disabled by entering the user-specific access code in the **Enter access code** parameter (→  132) via the respective access option.

1. After you press , the input prompt for the access code appears.

2. Enter the access code.
 - ↳ The -symbol in front of the parameters disappears; all previously write-protected parameters are now re-enabled.

8.3.12 Enabling and disabling the keypad lock

The keypad lock makes it possible to block access to the entire operating menu via local operation. As a result, it is no longer possible to navigate through the operating menu or change the values of individual parameters. Users can only read the measured values on the operational display.

The keypad lock is switched on and off via the context menu.

Switching on the keypad lock

-  The keypad lock is switched on automatically:
- If the device has not been operated via the display for > 1 minute.
 - Each time the device is restarted.

To activate the keylock manually:

1. The device is in the measured value display.
Press  for at least 2 seconds.
 - ↳ A context menu appears.
2. In the context menu select the **Keylock on** option.
 - ↳ The keypad lock is switched on.

-  If the user attempts to access the operating menu while the keypad lock is active, the **Keylock on** message appears.

Switching off the keypad lock

1. The keypad lock is switched on.
Press  for at least 2 seconds.
 - ↳ A context menu appears.
2. In the context menu select the **Keylock off** option.
 - ↳ The keypad lock is switched off.

8.4 Access to the operating menu via the Web browser

8.4.1 Function range

Thanks to the integrated Web server, the device can be operated and configured via a Web browser and via a service interface (CDI-RJ45) or via a WLAN interface. The structure of the operating menu is the same as for the local display. In addition to the measured values, status information on the device is also displayed and allows the user to monitor the status of the device. Furthermore the device data can be managed and the network parameters can be configured.

A device that has a WLAN interface (can be ordered as an option) is required for the WLAN connection: order code for "Display; operation", option **G** "4-line, illuminated; touch control + WLAN". The device acts as an Access Point and enables communication by computer or a mobile handheld terminal.

-  For additional information on the Web server, refer to the Special Documentation for the device

8.4.2 Prerequisites



Computer hardware

Hardware	Interface	
	CDI-RJ45	WLAN
Interface	The computer must have an RJ45 interface.	The operating unit must have a WLAN interface.
Connection	Standard Ethernet cable with RJ45 connector.	Connection via Wireless LAN.
Screen	Recommended size: ≥ 12" (depends on the screen resolution)	

Computer software



Software	Interface	
	CDI-RJ45	WLAN
Recommended operating systems	<ul style="list-style-type: none"> ▪ Microsoft Windows 7 or higher. ▪ Mobile operating systems: <ul style="list-style-type: none"> - iOS - Android <p> Microsoft Windows XP is supported.</p>	
Web browsers supported	<ul style="list-style-type: none"> ▪ Microsoft Internet Explorer 8 or higher ▪ Microsoft Edge ▪ Mozilla Firefox ▪ Google Chrome ▪ Safari 	

Computer settings



Settings	Interface	
	CDI-RJ45	WLAN
User rights	Appropriate user rights (e.g. administrator rights) for TCP/IP and proxy server settings are necessary (for adjusting the IP address, subnet mask etc.).	
Proxy server settings of the Web browser	The Web browser setting <i>Use a Proxy Server for Your LAN</i> must be deselected .	
JavaScript	JavaScript must be enabled. <p> If JavaScript cannot be enabled: enter <code>http://192.168.1.212/basic.html</code> in the address line of the Web browser. A fully functional but simplified version of the operating menu structure starts in the Web browser.</p> <p> When installing a new firmware version: To enable correct data display, clear the temporary memory (cache) of the Web browser under Internet options.</p>	
Network connections	Only the active network connections to the measuring device should be used.	
	Switch off all other network connections such as WLAN.	Switch off all other network connections.

 In the event of connection problems: →  161

Measuring device: Via CDI-RJ45 service interface

Device	CDI-RJ45 service interface
Measuring device	The measuring device has an RJ45 interface.
Web server	Web server must be enabled; factory setting: ON  For information on enabling the Web server → 91
IP address	If the IP address of the device is not known: <ul style="list-style-type: none"> ▪ The IP address can be read out via local operation: Diagnostics → Device information → IP address ▪ Communication with the Web server can be established via the default IP address 192.168.1.212. The DHCP function is enabled in the device at the factory, i.e. the device expects an IP address to be assigned by the network. This function can be disabled and the device can be set to the default IP address 192.168.1.212: set DIP switch No. 4 from OFF → ON .  Set the default IP address → 68.

Measuring device: via WLAN interface

Device	WLAN interface
Measuring device	The measuring device has a WLAN antenna: <ul style="list-style-type: none"> ▪ Transmitter with integrated WLAN antenna ▪ Transmitter with external WLAN antenna
Web server	Web server and WLAN must be enabled; factory setting: ON  For information on enabling the Web server → 91
IP address	If the IP address of the device is not known: <ul style="list-style-type: none"> ▪ The IP address can be read out via local operation: Diagnostics → Device information → IP address ▪ Communication with the Web server can be established via the default IP address 192.168.1.212. The DHCP function is enabled in the device at the factory, i.e. the device expects an IP address to be assigned by the network. This function can be disabled and the device can be set to the default IP address 192.168.1.212: set DIP switch No. 4 from OFF → ON .  Set the default IP address → 68.

8.4.3 Establishing a connection

Via service interface (CDI-RJ45)

Preparing the measuring device

Proline 500 – digital

1. Loosen the 4 fixing screws on the housing cover.
2. Open the housing cover.
3. The location of the connection socket depends on the measuring device and the communication protocol:
 Connect the computer to the RJ45 connector via the standard Ethernet connecting cable .

Proline 500

1. Depending on the housing version:
 Release the securing clamp or securing screw of the housing cover.

2. Depending on the housing version:
Unscrew or open the housing cover.
3. The location of the connection socket depends on the measuring device and the communication protocol:
Connect the computer to the RJ45 connector via the standard Ethernet connecting cable .

Configuring the Internet protocol of the computer

The IP address can be assigned to the measuring device in a variety of ways:

- Dynamic Host Configuration Protocol (DHCP), factory setting:
The IP address is automatically assigned to the measuring device by the automation system (DHCP server).
- Hardware addressing:
The IP address is set via DIP switches → 67.
- Software addressing:
The IP address is entered via the **IP address** parameter (→ 114) .
- DIP switch for "Default IP address":
To establish the network connection via the service interface (CDI-RJ45): the fixed IP address 192.168.1.212 is used → 68.

The measuring device works with the Dynamic Host Configuration Protocol (DHCP), on leaving the factory, i.e. the IP address of the measuring device is automatically assigned by the automation system (DHCP server).

To establish a network connection via the service interface (CDI-RJ45): the "Default IP address" DIP switch must be set to **ON**. The measuring device then has the fixed IP address: 192.168.1.212. This address can now be used to establish the network connection.

1. Via DIP switch 2, activate the default IP address 192.168.1.212: → 68.
2. Switch on the measuring device.
3. Connect to the computer using a cable → 93.
4. If a 2nd network card is not used, close all the applications on the notebook.
 - ↳ Applications requiring Internet or a network, such as e-mail, SAP applications, Internet or Windows Explorer.
5. Close any open Internet browsers.
6. Configure the properties of the Internet protocol (TCP/IP) as defined in the table:

IP address	192.168.1.XXX; for XXX all numerical sequences except: 0, 212 and 255 → e.g. 192.168.1.213
Subnet mask	255.255.255.0
Default gateway	192.168.1.212 or leave cells empty

Via WLAN interface

Configuring the Internet protocol of the mobile terminal

NOTICE

If the WLAN connection is lost during the configuration, settings made may be lost.

- ▶ Make sure that the WLAN connection is not disconnected while configuring the device.

NOTICE

In principle, avoid simultaneous access to the measuring device via the service interface (CDI-RJ45) and the WLAN interface from the same mobile terminal. This could cause a network conflict.

- ▶ Only activate one service interface (CDI-RJ45 service interface or WLAN interface).
- ▶ If simultaneous communication is necessary: configure different IP address ranges, e.g. 192.168.0.1 (WLAN interface) and 192.168.1.212 (CDI-RJ45 service interface).

Preparing the mobile terminal

- ▶ Enable WLAN reception on the mobile terminal.

Establishing a connection from the mobile terminal to the measuring device

1. In the WLAN settings of the mobile terminal:
Select the measuring device using the SSID (e.g. EH_Promag_500_A802000).
2. If necessary, select the WPA2 encryption method.
3. Enter the password: serial number of the measuring device ex-works (e.g. L100A802000).
 - ↳ LED on display module flashes: it is now possible to operate the measuring device with the Web browser, FieldCare or DeviceCare.

 The serial number can be found on the nameplate.

 To ensure the safe and swift assignment of the WLAN network to the measuring point, it is advisable to change the SSID name. It should be possible to clearly assign the new SSID name to the measuring point (e.g. tag name) because it is displayed as the WLAN network.

Disconnecting

- ▶ After configuring the device:
Terminate the WLAN connection between the operating unit and measuring device.

Starting the Web browser

1. Start the Web browser on the computer.

2. Enter the IP address of the Web server in the address line of the Web browser:
192.168.1.212
↳ The login page appears.

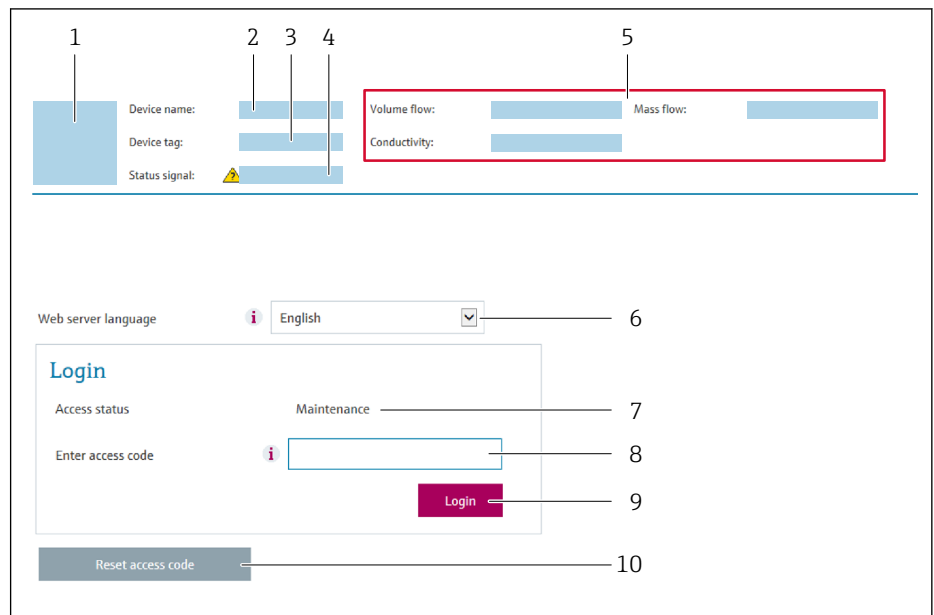

A0029417

- 1 Picture of device
- 2 Device name
- 3 Device tag
- 4 Status signal
- 5 Current measured values
- 6 Operating language
- 7 User role
- 8 Access code
- 9 Login
- 10 Reset access code (→ 143)

i If a login page does not appear, or if the page is incomplete → 161

8.4.4 Logging on

1. Select the preferred operating language for the Web browser.
2. Enter the user-specific access code.
3. Press **OK** to confirm your entry.

Access code	0000 (factory setting); can be changed by customer
--------------------	--

i If no action is performed for 10 minutes, the Web browser automatically returns to the login page.

8.4.5 User interface

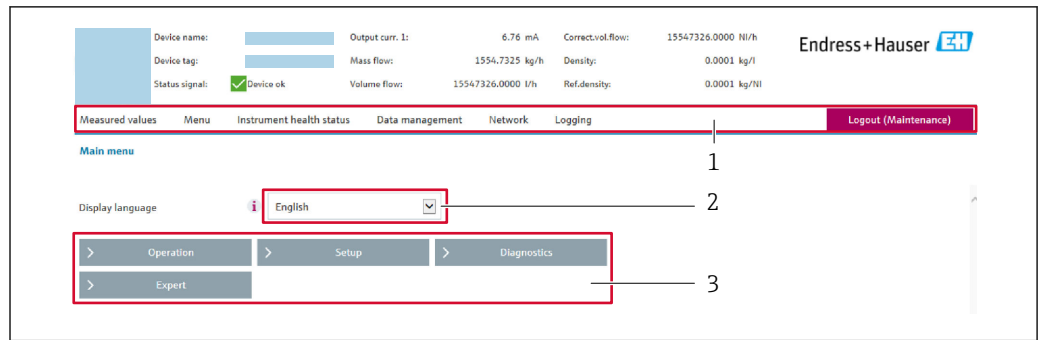

A0029418

- 1 Function row
- 2 Local display language
- 3 Navigation area

Header

The following information appears in the header:

- Device name
- Device tag
- Device status with status signal → 📄 169
- Current measured values

Function row

Functions	Meaning
Measured values	Displays the measured values of the measuring device
Menu	<ul style="list-style-type: none"> ■ Access to the operating menu from the measuring device ■ The structure of the operating menu is the same as for the local display <p>📖 For detailed information on the structure of the operating menu, see the Operating Instructions for the measuring device</p>
Device status	Displays the diagnostic messages currently pending, listed in order of priority
Data management	<p>Data exchange between PC and measuring device:</p> <ul style="list-style-type: none"> ■ Device configuration: <ul style="list-style-type: none"> - Load settings from the device (XML format, save configuration) - Save settings to the device (XML format, restore configuration) ■ Logbook - Export Event logbook (.csv file) ■ Documents - Export documents: <ul style="list-style-type: none"> - Export backup data record (.csv file, create documentation of the measuring point configuration) - Verification report (PDF file, only available with the "Heartbeat Verification" application package) ■ File for system integration - If using fieldbuses, upload device drivers for system integration from the measuring device: <ul style="list-style-type: none"> EtherNet/IP: EDS file ■ Firmware update - Flashing a firmware version
Network configuration	<p>Configuration and checking of all the parameters required for establishing the connection to the measuring device:</p> <ul style="list-style-type: none"> ■ Network settings (e.g. IP address, MAC address) ■ Device information (e.g. serial number, firmware version)
Logout	End the operation and call up the login page

Navigation area

If a function is selected in the function bar, the submenus of the function open in the navigation area. The user can now navigate through the menu structure.

Working area

Depending on the selected function and the related submenus, various actions can be performed in this area:

- Configuring parameters
- Reading measured values
- Calling up help text
- Starting an upload/download

8.4.6 Disabling the Web server

The Web server of the measuring device can be switched on and off as required using the **Web server functionality** parameter.

Navigation

"Expert" menu → Communication → Web server

Parameter overview with brief description

Parameter	Description	Selection	Factory setting
Web server functionality	Switch the Web server on and off.	<ul style="list-style-type: none"> ▪ Off ▪ HTML Off ▪ On 	On

Function scope of the "Web server functionality" parameter

Option	Description
Off	<ul style="list-style-type: none"> ▪ The web server is completely disabled. ▪ Port 80 is locked.
On	<ul style="list-style-type: none"> ▪ The complete functionality of the web server is available. ▪ JavaScript is used. ▪ The password is transferred in an encrypted state. ▪ Any change to the password is also transferred in an encrypted state.

Enabling the Web server

If the Web server is disabled it can only be re-enabled with the **Web server functionality** parameter via the following operating options:

- Via local display
- Via Bedientool "FieldCare"
- Via "DeviceCare" operating tool

8.4.7 Logging out

 Before logging out, perform a data backup via the **Data management** function (upload configuration from device) if necessary.

1. Select the **Logout** entry in the function row.
 - ↳ The home page with the Login box appears.
2. Close the Web browser.

3. If no longer needed:

Reset modified properties of the Internet protocol (TCP/IP) →  87.

-  If communication with the Web server was established via the default IP address 192.168.1.212, DIP switch No. 10 must be reset (from **ON** → **OFF**). Afterwards, the IP address of the device is active again for network communication.

8.5 Access to the operating menu via the operating tool

The structure of the operating menu in the operating tools is the same as for operation via the local display.

8.5.1 Connecting the operating tool

Via EtherNet/IP network

This communication interface is available in device versions with EtherNet/IP.

Star topology

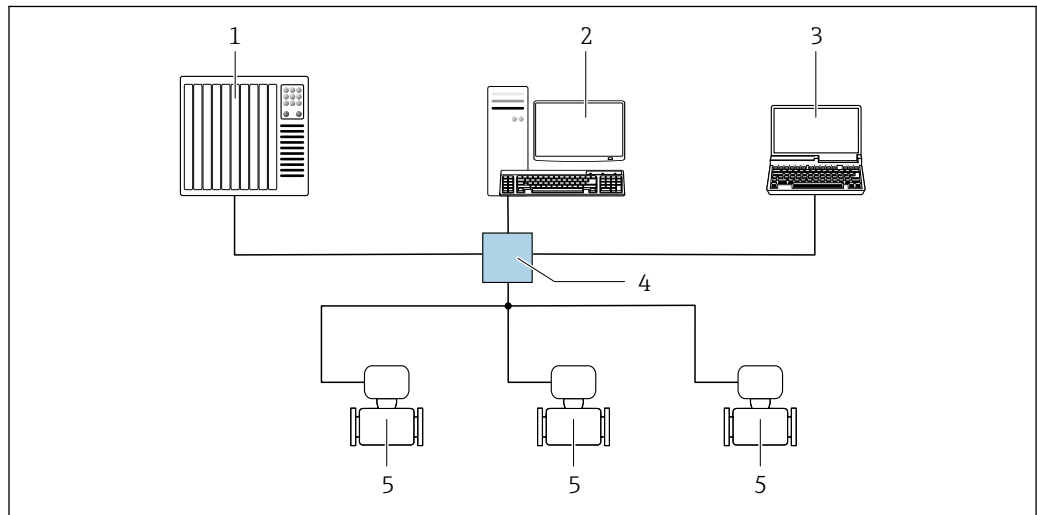

A0032078

 34 Options for remote operation via EtherNet/IP network: star topology

- 1 Automation system, e.g. "RSLogix" (Rockwell Automation)
- 2 Workstation for measuring device operation: with Custom Add-On Profile for "RSLogix 5000" (Rockwell Automation) or with Electronic Data Sheet (EDS)
- 3 Computer with Web browser (e.g. Internet Explorer) for accessing the integrated device Web server or computer with operating tool (e.g. FieldCare, DeviceCare) with COM DTM "CDI Communication TCP/IP"
- 4 Ethernet switch
- 5 Measuring device

Ring topology

The device is integrated via the terminal connection for signal transmission (output 1) and the service interface (CDI-RJ45).

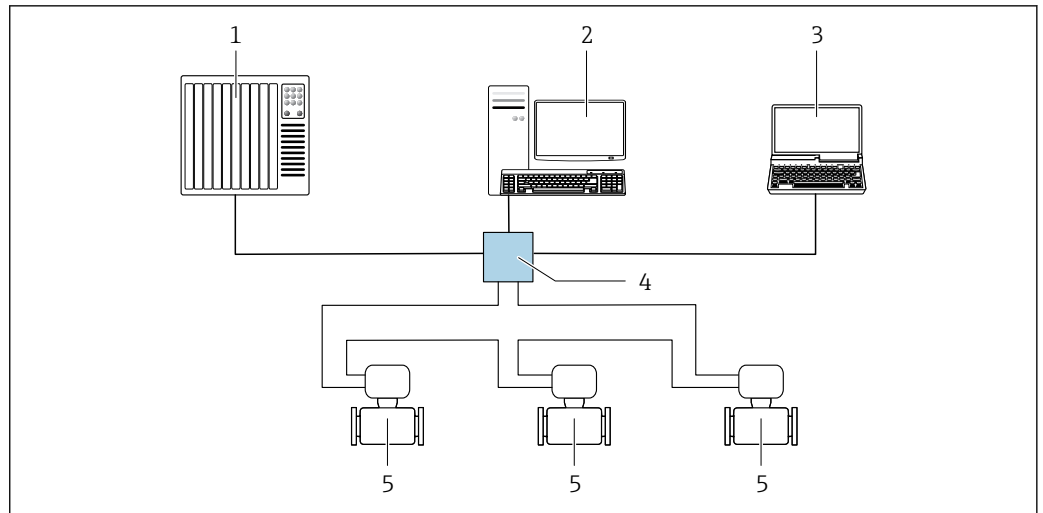

A0033725

35 Options for remote operation via EtherNet/IP network: ring topology

- 1 Automation system, e.g. "RSLogix" (Rockwell Automation)
- 2 Workstation for measuring device operation: with Custom Add-On Profile for "RSLogix 5000" (Rockwell Automation) or with Electronic Data Sheet (EDS)
- 3 Computer with Web browser (e.g. Internet Explorer) for accessing the integrated device Web server or computer with operating tool (e.g. FieldCare, DeviceCare) with COM DTM "CDI Communication TCP/IP"
- 4 Ethernet switch
- 5 Measuring device

Service interface

Via service interface (CDI-RJ45)

A point-to-point connection can be established to configure the device onsite. With the housing open, the connection is established directly via the service interface (CDI-RJ45) of the device.

i An adapter for RJ45 and the M12 connector is optionally available:
 Order code for "Accessories", option **NB**: "Adapter RJ45 M12 (service interface)"

The adapter connects the service interface (CDI-RJ45) to an M12 connector mounted in the cable entry. Therefore the connection to the service interface can be established via an M12 connector without opening the device.

Proline 500 – digital transmitter

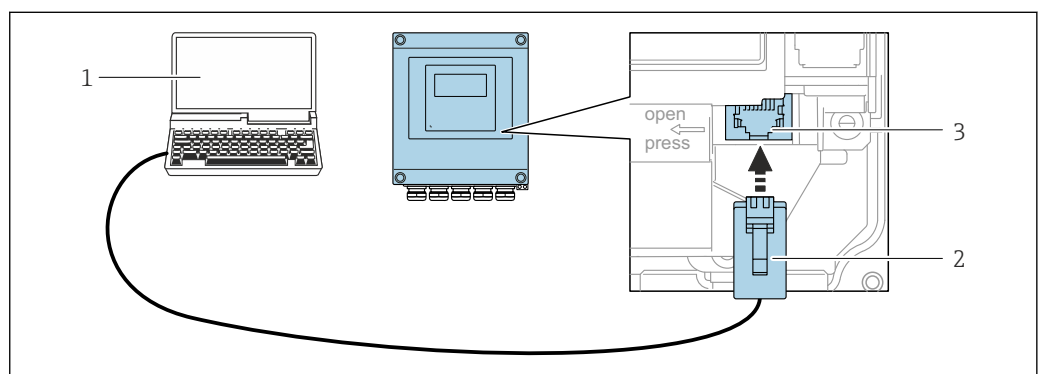

A0029163

36 Connection via service interface (CDI-RJ45)

- 1 Computer with Web browser (e.g. Microsoft Internet Explorer, Microsoft Edge) for accessing the integrated device Web server or with "FieldCare", "DeviceCare" operating tool with COM DTM "CDI Communication TCP/IP"
- 2 Standard Ethernet connecting cable with RJ45 connector
- 3 Service interface (CDI-RJ45) of the measuring device with access to the integrated Web server

Proline 500 transmitter

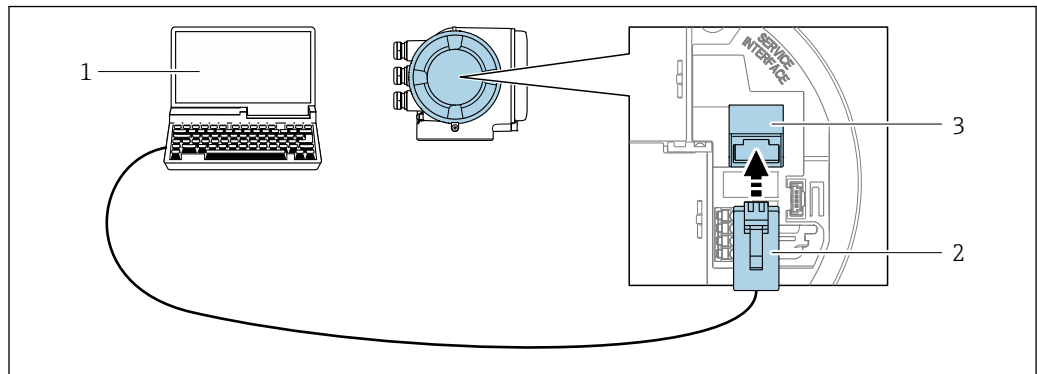

A0027563

37 Connection via service interface (CDI-RJ45)

- 1 Computer with Web browser (e.g. Microsoft Internet Explorer, Microsoft Edge) for accessing the integrated device Web server or with "FieldCare", "DeviceCare" operating tool with COM DTM "CDI Communication TCP/IP"
- 2 Standard Ethernet connecting cable with RJ45 connector
- 3 Service interface (CDI-RJ45) of the measuring device with access to the integrated Web server

Via WLAN interface

The optional WLAN interface is available on the following device version:
 Order code for "Display; operation", option **G** "4-line, illuminated, graphic display; touch control + WLAN"

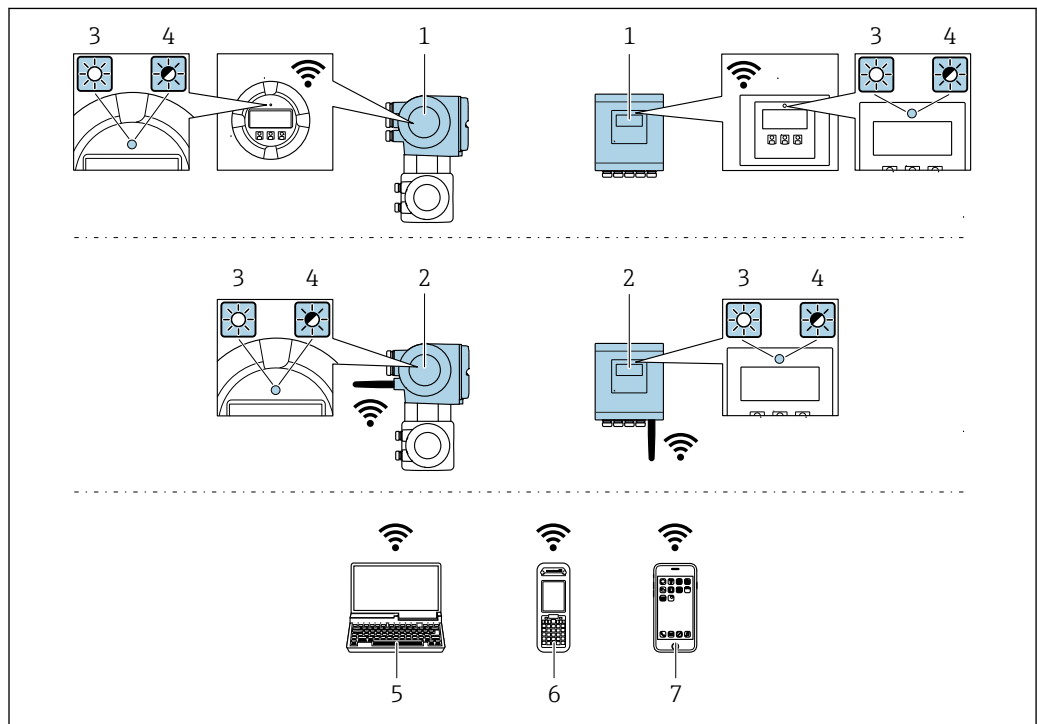

A0034569

- 1 Transmitter with integrated WLAN antenna
- 2 Transmitter with external WLAN antenna
- 3 LED lit constantly: WLAN reception is enabled on measuring device
- 4 LED flashing: WLAN connection established between operating unit and measuring device
- 5 Computer with WLAN interface and Web browser (e.g. Microsoft Internet Explorer, Microsoft Edge) for accessing the integrated device Web server or with operating tool (e.g. FieldCare, DeviceCare)
- 6 Mobile handheld terminal with WLAN interface and Web browser (e.g. Microsoft Internet Explorer, Microsoft Edge) for accessing the integrated device Web server or operating tool (e.g. FieldCare, DeviceCare)
- 7 Smartphone or tablet

Function	WLAN: IEEE 802.11 b/g (2.4 GHz) <ul style="list-style-type: none"> ▪ Access point with DHCP server (default setting) ▪ Network
Encryption	WPA2-PSK/AES 128 bit
Configurable WLAN channels	1 to 11
Degree of protection	IP67
Available antennas	<ul style="list-style-type: none"> ▪ Internal antenna ▪ External antenna (optional) In the event of poor transmission/reception conditions at the place of installation.  Only one antenna active in each case!
Max. range	50 m (164 ft)
Materials: External WLAN antenna	<ul style="list-style-type: none"> ▪ Antenna: ASA plastic (acrylic ester-styrene-acrylonitrile) and nickel-plated brass ▪ Adapter: Stainless steel and nickel-plated brass ▪ Cable: Polyethylene ▪ Connector: Nickel-plated brass ▪ Angle bracket: Stainless steel

Configuring the Internet protocol of the mobile terminal

NOTICE

If the WLAN connection is lost during the configuration, settings made may be lost.

- ▶ Make sure that the WLAN connection is not disconnected while configuring the device.

NOTICE

In principle, avoid simultaneous access to the measuring device via the service interface (CDI-RJ45) and the WLAN interface from the same mobile terminal. This could cause a network conflict.

- ▶ Only activate one service interface (CDI-RJ45 service interface or WLAN interface).
- ▶ If simultaneous communication is necessary: configure different IP address ranges, e.g. 192.168.0.1 (WLAN interface) and 192.168.1.212 (CDI-RJ45 service interface).

Preparing the mobile terminal

- ▶ Enable WLAN reception on the mobile terminal.

Establishing a connection from the mobile terminal to the measuring device

1. In the WLAN settings of the mobile terminal:
Select the measuring device using the SSID (e.g. EH_Promag_500_A802000).
2. If necessary, select the WPA2 encryption method.
3. Enter the password: serial number of the measuring device ex-works (e.g. L100A802000).
 - ↳ LED on display module flashes: it is now possible to operate the measuring device with the Web browser, FieldCare or DeviceCare.

 The serial number can be found on the nameplate.

 To ensure the safe and swift assignment of the WLAN network to the measuring point, it is advisable to change the SSID name. It should be possible to clearly assign the new SSID name to the measuring point (e.g. tag name) because it is displayed as the WLAN network.

Disconnecting



- ▶ After configuring the device:
Terminate the WLAN connection between the operating unit and measuring device.

8.5.2 FieldCare

Function scope

FDT-based plant asset management tool from Endress+Hauser. It can configure all smart field devices in a system and helps you manage them. By using the status information, it is also a simple but effective way of checking their status and condition.

Access is via:

- CDI-RJ45 service interface →  93
- WLAN interface →  94

Typical functions:

- Configuring parameters of transmitters
- Loading and saving device data (upload/download)
- Documentation of the measuring point
- Visualization of the measured value memory (line recorder) and event logbook



For additional information about FieldCare, see Operating Instructions BA00027S and BA00059S

Source for device description files

See information →  98

Establishing a connection

1. Start FieldCare and launch the project.
2. In the network: Add a device.
 - ↳ The **Add device** window opens.
3. Select the **CDI Communication TCP/IP** option from the list and press **OK** to confirm.
4. Right-click **CDI Communication TCP/IP** and select the **Add device** option in the context menu that opens.
5. Select the desired device from the list and press **OK** to confirm.
 - ↳ The **CDI Communication TCP/IP (Configuration)** window opens.
6. Enter the device address in the **IP address** field: 192.168.1.212 and press **Enter** to confirm.
7. Establish the online connection to the device.



For additional information, see Operating Instructions BA00027S and BA00059S

User interface

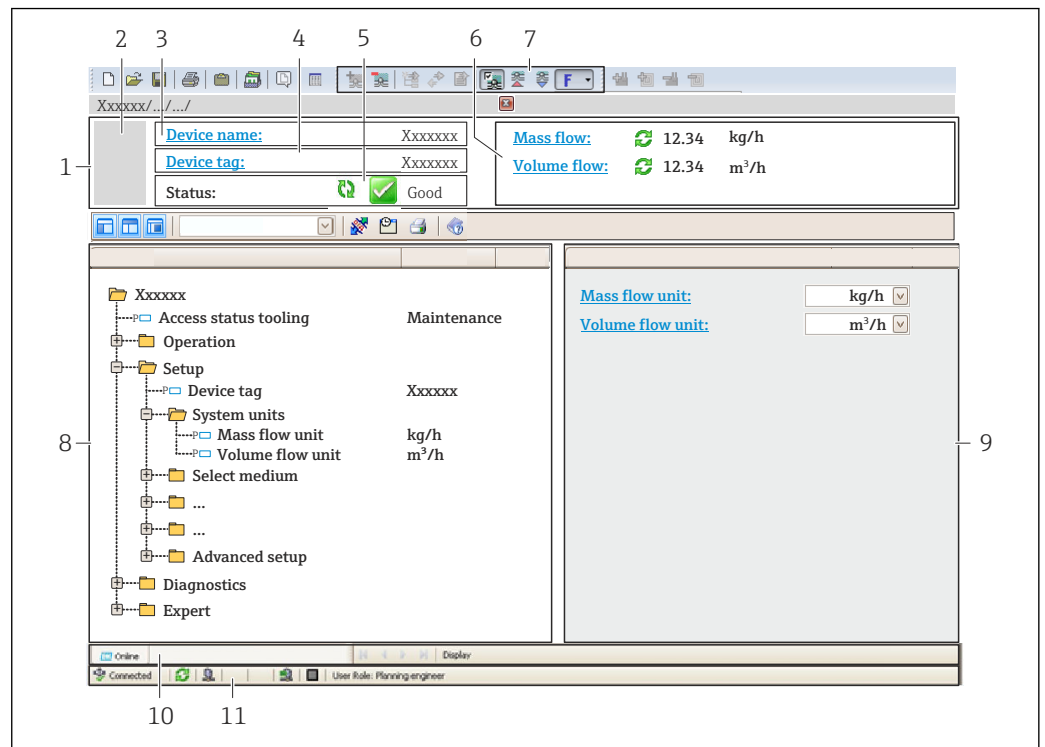

A0021051-EN

- 1 Header
- 2 Picture of device
- 3 Device name
- 4 Tag name
- 5 Status area with status signal → 169
- 6 Display area for current measured values
- 7 Edit toolbar with additional functions such as save/restore, event list and create documentation
- 8 Navigation area with operating menu structure
- 9 Working area
- 10 Range of action
- 11 Status area

8.5.3 DeviceCare

Function scope

Tool to connect and configure Endress+Hauser field devices.

The fastest way to configure Endress+Hauser field devices is with the dedicated "DeviceCare" tool. Together with the device type managers (DTMs) it presents a convenient, comprehensive solution.

 For details, see Innovation Brochure IN01047S

Source for device description files

See information →  98

9 System integration

9.1 Overview of device description files

9.1.1 Current version data for the device

Firmware version	01.00.zz	<ul style="list-style-type: none"> ▪ On the title page of the Operating Instructions ▪ On the transmitter nameplate ▪ Firmware version Diagnostics → Device information → Firmware version
Release date of firmware version	10.2017	---
Manufacturer ID	0x11	Manufacturer ID Diagnostics → Device information → Manufacturer ID
Device type ID	0x103C	Device type Diagnostics → Device information → Device type
Device revision	<ul style="list-style-type: none"> ▪ Major revision 1 ▪ Minor revision 1 	<ul style="list-style-type: none"> ▪ On the transmitter nameplate ▪ Device revision Diagnostics → Device information → Device revision
Device profile	Generic device (product type: 0x2B)	



For an overview of the different firmware versions for the device → 189

9.1.2 Operating tools

The suitable device description file for the individual operating tools is listed in the table below, along with information on where the file can be acquired.

Operating tool via Service interface (CDI)	Sources for obtaining device descriptions
FieldCare	<ul style="list-style-type: none"> ▪ www.endress.com → Download Area ▪ CD-ROM (contact Endress+Hauser) ▪ DVD (contact Endress+Hauser)
DeviceCare	<ul style="list-style-type: none"> ▪ www.endress.com → Download Area ▪ CD-ROM (contact Endress+Hauser) ▪ DVD (contact Endress+Hauser)

9.2 Overview of system files

System files	Version	Description	How to acquire
Electronic Data Sheet (EDS system file)	2.1	Certified in accordance with the following ODVA guidelines: <ul style="list-style-type: none"> ▪ Conformance test ▪ Performance test ▪ PlugFest Embedded EDS Support (File Object 0x37)	<ul style="list-style-type: none"> ▪ www.endress.com → Download-Area ▪ EDS system file integrated in the device: can be downloaded via the Web browser
Add-on Profile Level 3	<ul style="list-style-type: none"> ▪ Major revision 1 ▪ Minor revision 1 	System file for "Studio 5000" software (Rockwell Automation)	www.endress.com → Download-Area

9.3 Integrating the measuring device in the system

 A detailed description of how to integrate the device into an automation system (e.g. from Rockwell Automation) is available as a separate document: www.endress.com → Select country → Automation → Digital communication → Fieldbus device integration → EtherNet/IP







 Protocol-specific data →  203.

9.4 Cyclic data transmission

Cyclic data transmission when using the EDS system file.

9.4.1 Block model

The block model shows which input and output data the measuring device makes available for implicit messaging. Cyclical data exchange is performed using an EtherNet/IP scanner, e.g. a distributed control system etc.

Measuring device				Control system
Transducer Block	Input Assembly Fix (Assem100) 40 byte	→  101	Permanently assigned input group	→
	Volume flow fixed input assembly (Assem106) 38 byte	→  102	Permanently assigned input group	→
	Mass flow fixed input assembly (Assem107) 56 byte	→  102	Permanently assigned input group	→
	Heartbeat monitoring fixed input assembly ¹⁾ (Assem112) 50 byte	→  102	Permanently assigned input group	→
	Input assembly custom (Assem101) 88 byte	→  102	Configurable input group	→
	Output assembly fix (Assem102) 54 byte	→  103	Permanently assigned output group	←
	Config assembly (Assem104) 1512 byte	→  104	Permanently assigned configuration	→
				EtherNet/IP

1) Only available with the Heartbeat Verification application package.

9.4.2 Input and output groups

Possible configurations

Configuration 1: Exclusive Owner Multicast

Input Assembly Fix		Instance	Size (byte)	Min. RPI (ms)
Input Assembly Configurable	Configuration	0 x 64	398	–
Output Assembly Fix	O → T Configuration	0 x 66	64	5
Input Assembly Fix	T → O Configuration	0 x 64	44	5

Configuration 2: Input Only Multicast

Input Assembly Fix		Instance	Size (byte)	Min. RPI (ms)
Input Assembly Configurable	Configuration	0 x 68	398	–
Output Assembly Fix	O → T Configuration	0 x C7	–	–
Input Assembly Fix	T → O Configuration	0 x 64	44	5

Configuration 3: Exclusive Owner Multicast

Input Assembly Configurable		Instance	Size (byte)	Min. RPI (ms)
Input Assembly Configurable	Configuration	0 x 68	398	–
Output Assembly Fix	O → T Configuration	0 x 66	64	5
Input Assembly Fix	T → O Configuration	0 x 65	88	5

Configuration 4: Input Only Multicast

Input Assembly Configurable		Instance	Size (byte)	Min. RPI (ms)
Input Assembly Configurable	Configuration	0 x 68	398	–
Output Assembly Fix	O → T Configuration	0 x C7	–	–
Input Assembly Fix	T → O Configuration	0 x 64	88	5

Configuration 5: Exclusive Owner Multicast

Input Assembly Fix		Instance	Size (byte)	Min. RPI (ms)
Input Assembly Configurable	Configuration	0 x 69	–	–
Output Assembly Fix	O → T Configuration	0 x 66	64	5
Input Assembly Fix	T → O Configuration	0 x 64	44	5

Configuration 6: Input Only Multicast

Input Assembly Fix		Instance	Size (byte)	Min. RPI (ms)
Input Assembly Configurable	Configuration	0 x 69	–	–
Output Assembly Fix	O → T Configuration	0 x C7	–	–
Input Assembly Fix	T → O Configuration	0 x 65	44	5

Configuration 7: Exclusive Owner Multicast

Input Assembly Configurable		Instance	Size (byte)	Min. RPI (ms)
Input Assembly Configurable	Configuration	0 x 69	–	–
Output Assembly Fix	O → T Configuration	0 x 66	64	5
Input Assembly Fix	T → O Configuration	0 x 64	88	5

Configuration 8: Input Only Multicast

Input Assembly Configurable		Instance	Size (byte)	Min. RPI (ms)
Input Assembly Configurable	Configuration	0 x 69	–	–
Output Assembly Fix	O → T Configuration	0 x C7	–	–
Input Assembly Fix	T → O Configuration	0 x 65	88	5

Possible connections

No.	#1	#2	#3	#4	#5
Number of connections	1	1	1	1	1
Input assembly fixed (Assem100)	X				
Volume flow fixed input assembly (Assem106)		X			
Mass flow fixed input assembly (Assem107)			X		
Input assembly custom (Assem101)				X	
Heartbeat monitoring fixed input assembly (Assem112)					X

Permanently assigned input group*Input assembly fixed (Assem100), 40 byte*

Description	Byte
1. File header (not visible)	1-4
2. Current diagnosis ¹⁾	5-8
3. Volume flow	9-12
4. Mass flow	13-16
5. Corrected volume flow	17-20
6. Conductivity	21-24
7. Temperature	25-28
8. Totalizer 1	29-32
9. Totalizer 2	33-36
10. Totalizer 3	37-40

1) Diagnostic information via EtherNet/IP → 106

Volume flow fixed input assembly (Assem106), 40 byte

Description	Byte
1. File header (not visible)	1-4
2. Current diagnosis ¹⁾	5-8
3. Volume flow	9-12
4. Corrected volume flow	13-16
5. Conductivity	17-20
6. Temperature	21-24
7. Totalizer 1	25-28
8. Volume flow unit	29-30
9. Corrected volume flow unit	31-32
10. Conductivity unit	33-34
11. Temperature unit	35-36
12. Totalizer 1 unit	37-38
13. Padding byte	39-40

1) Diagnostic information via EtherNet/IP → 106

Mass flow fixed input assembly (Assem107), 58 byte

Description	Byte
1. Volume flow fixed input assembly	1-40
2. Mass flow	41-44
3. Totalizer 2	45-48
4. Totalizer 3	49-52
5. Mass flow unit	53-54
6. Totalizer 2 unit	55-56
7. Totalizer 3 unit	57-58

Heartbeat monitoring fixed input assembly (Assem112), 56 byte ¹⁾

Description	Byte
1. Volume flow fixed input assembly	1-40
2. Noise	41-44
3. Coil current shot time	45-48
4. Reference electrode potential against PE	49-52
5. Verification status	53-54
6. Verification result	55-56

1) Only available with the Heartbeat Verification application package.

Configurable input group*Input assembly custom (Assem101), 88 byte*

Description	Format
1. - 10. Input values 1 to 10	Real
11. - 20. Input values 11 to 20	Double integer

Possible input values

Possible input values 1 to 10:		
▪ Off	▪ Flow velocity	▪ Electronic temperature
▪ Volume flow	▪ Conductivity	▪ Totalizer 1
▪ Mass flow	▪ Corrected conductivity	▪ Totalizer 2
▪ Corrected volume flow	▪ Temperature	▪ Totalizer 3

Possible input values 11 to 20:		
▪ Off	▪ Temperature unit	▪ Verification results ¹⁾
▪ Actual diagnostics	▪ Conductivity unit	▪ Verification status
▪ Previous diagnosis	▪ Totalizer 1 unit	
▪ Mass flow unit	▪ Totalizer 2 unit	
▪ Volume flow unit	▪ Totalizer 3 unit	
▪ Corrected volume flow unit		

1) Only available with the Heartbeat Verification application package.

Permanently assigned output group

Output assembly fix (Assem102), 30 byte

Description (format)	Byte	Bit	Value
1. Totalizer 1	1	0	<ul style="list-style-type: none"> ▪ 0: Enable ▪ 1: Disable
2. Totalizer 2		1	
3. Totalizer 3		2	
4. External density		3	
5. Compensation, temperature		4	
6. Verification		5	
7. Flow override		6	
8. Not used		7	
9. Not used	2	8	-
10. Not used	3-4	16	-
11. Control totalizer 1 (integer)	5-6	16	<ul style="list-style-type: none"> ▪ 32226 (0): Add ▪ 32490 (1): Reset and stop ▪ 32228 (2): Default value and stop ▪ 198 (3): Reset and add ▪ 199 (4): Default value and add ▪ 32928 (3): Stop
12. Control totalizer 2 (integer)	7-8	16	
13. Control totalizer 3 (integer)	9-10	16	
14. Not used	11-12	16	-
15. External density (real)	13-16	32	Data format: Byte 1 to 4: External density Floating-point number (IEEE754)

Description (format)	Byte	Bit	Value
16. External density unit (integer)	17-18	16	<ul style="list-style-type: none"> ▪ 1100 (91) : g/cm³ ▪ 1101 (204) : g/m³ ▪ 1103 (96) : kg/l ▪ 1099 (240) : kg/dm³ ▪ 1097 (92) : kg/m³ ▪ 1628 (240) : SD4°C ▪ 1629 (240) : SD15°C ▪ 1630 (240) : SD20°C ▪ 32833 (240) : SG4°C ▪ 32832 (240) : SG15°C ▪ 32831 (240) : SG20°C ▪ 1107 (94) : lb/ft³ ▪ 1108 (93) : lb/gal (us) ▪ 32836 (240) : lb/bbl (us;liq.) ▪ 32835 (240) : lb/bbl (us;beer) ▪ 32837 (240) : lb/bbl (us;oil) ▪ 32834 (240) : lb/bbl (us;tank) ▪ 1430 (240) : lb/gal (imp) ▪ 32838 (240) : lb/bbl (imp;beer) ▪ 32839 (240) : lb/bbl (imp;oil)
17. Not used	19-20	16	–
18. External temperature (real)	21-24	32	Data format: Byte 1 to 4: External temperature Floating-point number (IEEE754)
19. External temperature unit (integer)	25-26	16	<ul style="list-style-type: none"> ▪ 1001 (32): °C ▪ 1002 (33): °F ▪ 1000 (35): K ▪ 1003 (34): °R
20. Start verification (integer)	27-28	16	<ul style="list-style-type: none"> ▪ 32823 (0): Cancel ▪ 33158 (1): Start
21. Flow override monitoring	29-30	16	<ul style="list-style-type: none"> ▪ 33004 (0): Off ▪ 33006 (1): On

Permanently assigned configuration group

Config assembly (Assem104), 1512 byte

Description (format)	Bits	Byte	Offset
1. None	32	4	0
2. Parameter 28 – Write protection	8	4	4
3. None	8	4	5
4. Parameter 74 System units Mass flow unit	16	4	6
5. Parameter 73 System units Mass unit	16	4	8
6. Parameter 77 System units Volume flow unit	16	4	10
7. Parameter 76 System units Volume unit	16	4	12
8. Parameter 71 System units Corrected volume flow unit	16	4	14
9. Parameter 72 System units Density unit	16	4	16
10. Parameter 75 System units Temperature unit	16	4	18
11. Parameter 69 System units Conductivity unit	16	4	20
12. None	192	4	22
13. Parameter 147 – Enter access code	16	4	46
14. Parameter 78 Totalizer 1 Assign process variable	16	4	48
15. Parameter 90 Totalizer 1 Unit totalizer	16	4	50
16. Parameter 87 Totalizer 1 Totalizer operation mode	16	4	52

Description (format)				Bits	Byte	Offset
17.	Parameter 84	Totalizer 1	Failure mode	16	4	54
18.	Parameter 149	Totalizer operation	Preset value tot. 1	32	4	56
19.	Parameter 81	Totalizer operation	Control totalizer 1	16	4	60
20.	Parameter 79	Totalizer 2	Assign process variable	16	4	62
21.	Parameter 91	Totalizer 2	Unit totalizer	16	4	64
22.	Parameter 88	Totalizer 2	Totalizer operation mode	16	4	66
23.	Parameter 85	Totalizer 2	Failure mode	16	4	68
24.	Parameter 82	Totalizer operation	Control totalizer 2	16	4	70
25.	Parameter 150	Totalizer operation	Preset value tot. 2	32	4	72
26.	Parameter 80	Totalizer 3	Assign process variable	16	4	76
27.	Parameter 92	Totalizer 3	Unit totalizer	16	4	78
28.	Parameter 89	Totalizer 3	Totalizer operation mode	16	4	80
29.	Parameter 86	Totalizer 3	Failure mode	16	4	82
30.	Parameter 130	Totalizer operation	Preset value tot. 3	32	4	84
31.	Parameter 83	Totalizer operation	Control totalizer 3	16	4	88
32.	Parameter 8	Configurable input assembly	Input assembly position 1	16	4	90
33.	Parameter 19	Configurable input assembly	Input assembly position 2	16	4	92
34.	Parameter 21	Configurable input assembly	Input assembly position 3	16	4	94
35.	Parameter 22	Configurable input assembly	Input assembly position 4	16	4	96
36.	Parameter 23	Configurable input assembly	Input assembly position 5	16	4	98
37.	Parameter 24	Configurable input assembly	Input assembly position 6	16	4	100
38.	Parameter 25	Configurable input assembly	Input assembly position 7	16	4	102
39.	Parameter 26	Configurable input assembly	Input assembly position 8	16	4	104
40.	Parameter 27	Configurable input assembly	Input assembly position 9	16	4	106
41.	Parameter 9	Configurable input assembly	Input assembly position 10	16	4	108
42.	Parameter 10	Configurable input assembly	Input assembly position 11	16	4	110
43.	Parameter 11	Configurable input assembly	Input assembly position 12	16	4	112
44.	Parameter 12	Configurable input assembly	Input assembly position 13	16	4	114
45.	Parameter 13	Configurable input assembly	Input assembly position 14	16	4	116
46.	Parameter 14	Configurable input assembly	Input assembly position 15	16	4	118
47.	Parameter 15	Configurable input assembly	Input assembly position 16	16	4	120
48.	Parameter 16	Configurable input assembly	Input assembly position 17	16	4	122
49.	Parameter 17	Configurable input assembly	Input assembly position 18	16	4	124
50.	Parameter 18	Configurable input assembly	Input assembly position 19	16	4	126
51.	Parameter 20	Configurable input assembly	Input assembly position 20	16	4	128
52.	Parameter 30	Sensor adjustment	Flow direction	16	4	130
53.	Parameter 29	Low flow cut off	Assign process variable	16	4	132
54.	Parameter 31	Empty pipe detection	Assign process variable	16	4	134
55.	Parameter 110	Low flow cut off	On value low flow cut off	32	4	136
56.	Parameter 109	Low flow cut off	Off value low flow cutoff	32	4	140
57.	Parameter 118	Low flow cut off	Pressure shock suppression	32	4	144
58.	Parameter 111	Empty pipe detection	Response time part. filled pipe detect.	32	4	148
59.	Parameter 106	Process parameter	Conductivity damping	32	4	152

Description (format)				Bits	Byte	Offset
60.	Parameter 32	Process parameter	Flow override	16	4	156
61.	Parameter 45	Empty pipe detection	New adjustment	16	4	158
62.	Parameter 42	External compensation	Density source	16	4	160
63.	Parameter 49	External compensation	Temperature source	16	4	162
64.	Parameter 138	Empty pipe detection	Switch point empty pipe detection	32	4	164
65.	Parameter 140	External compensation	Fixed density	32	4	168
66.	Parameter 48	Process parameter	Filter options	16	4	172
67.	Parameter 141	Process parameter	Flow damping	8	4	174
68.	None			8	4	175
69.	Parameter 146	Diagnostic settings	Alarm delay	32	4	176
70.	Parameter 53	Diagnostic behavior	Assign behavior for diagnostic information 832	8	4	180
71.	Parameter 54	Diagnostic behavior	Assign behavior for diagnostic information 833	8	4	181
72.	Parameter 55	Diagnostic behavior	Assign behavior for diagnostic information 834	8	4	182
73.	Parameter 56	Diagnostic behavior	Assign behavior for diagnostic information 835	8	4	183
74.	Parameter 57	Diagnostic behavior	Assign behavior for diagnostic information 962	8	4	184
75.	Parameter 52	Diagnostic behavior	Assign behavior for diagnostic information 531	8	4	185
76.	Parameter 58	Diagnostic behavior	Assign behavior for diagnostic information 937	8	4	186
77.	Parameter 51	Diagnostic behavior	Assign behavior for diagnostic information 302	8	4	187

9.5 Diagnostic information via EtherNet/IP

Status signal	No.	Short text	Value
	000	–	0
F	882	Input signal	16777265
F	281	Electronic initialization	16777276
F	437	Configuration incompatible	16777312
F	242	Software incompatible	16777319
F	252	Modules incompatible	16777323
F	272	Main electronic failure	16777337
F	270	Main electronic failure	16777340
F	271	Main electronic failure	16777341
F	270	Main electronic failure	16777343
F	270	Main electronic failure	16777344
F	410	Data transfer	16777355
F	273	Main electronic failure	16777368
F	270	Main electronic failure	16777375
F	083	Memory content	16777376

Status signal	No.	Short text	Value
F	833	Electronic temperature too low	16777409
F	832	Electronic temperature too high	16777411
F	834	Process temperature too high	16777413
F	835	Process temperature too low	16777414
F	022	Sensor temperature	16777429
F	022	Sensor temperature	16777430
F	311	Electronic failure	16777441
F	273	Main electronic failure	16777445
F	082	Data storage	16777447
F	190	Special event 1	16777450
F	273	Main electronic failure	16777483
F	390	Special event 2	16777490
F	222	Electronic drift	16777497
F	938	EMC interference	16777499
F	062	Sensor connection	16777500
F	590	Special event 3	16777508
F	990	Special event 4	16777509
F	262	Module connection	16777545
F	537	Configuration	16777546
F	201	Device failure	16777547
F	937	EMC interference	16777556
F	500	Electrode 1 potential exceeded	16777563
F	500	Electrode 2 potential exceeded	16777564
F	500	Electrode difference voltage too high	16777565
F	382	Data storage	16777581
F	383	Memory content	16777582
F	283	Memory content	16777583
C	411	Up-/download active	33554536
C	411	Up-/download active	33554537
C	411	Up-/download active	33554540
C	484	Simulation failure mode	33554576
C	485	Simulation measured variable	33554579
C	453	Flow override	33554580
C	833	Electronic temperature too low	33554625
C	832	Electronic temperature too high	33554627
C	834	Process temperature too high	33554629
C	835	Process temperature too low	33554630
C	937	EMC interference	33554772
C	530	Electrode cleaning is running	33554778
C	495	Simulation diagnostic event	33554782
C	302	Device verification active	33554926
M	438	Dataset	67108970
M	833	Electronic temperature too low	67109057

Status signal	No.	Short text	Value
M	832	Electronic temperature too high	67109059
M	834	Process temperature too high	67109061
M	835	Process temperature too low	67109062
M	311	Electronic failure	67109090
M	937	EMC interference	67109204
S	842	Process limit	134217873
S	862	Empty pipe	134217874
S	833	Electronic temperature too low	134217921
S	832	Electronic temperature too high	134217923
S	834	Process temperature too high	134217925
S	835	Process temperature too low	134217926
S	004	Sensor	134218013
S	043	Sensor short circuit	134218067
S	937	EMC interference	134218068
S	322	Electronic drift	134218071
S	322	Electronic drift	134218072
S	531	Empty pipe detection	134218091

10 Commissioning

10.1 Function check

Before commissioning the measuring device:

- ▶ Make sure that the post-installation and post-connection checks have been performed.
- "Post-installation check" checklist → 37
- "Post-connection check" checklist → 70

10.2 Switching on the measuring device

- ▶ After a successful function check, switch on the measuring device.
 - ↳ After a successful startup, the local display switches automatically from the startup display to the operational display.

i If nothing appears on the local display or a diagnostic message is displayed, refer to the section on "Diagnostics and troubleshooting" → 160.

10.3 Connecting via FieldCare

- For FieldCare → 93 connection
- For connecting via FieldCare → 96
- For the FieldCare → 97 user interface

10.4 Setting the operating language

Factory setting: English or ordered local language

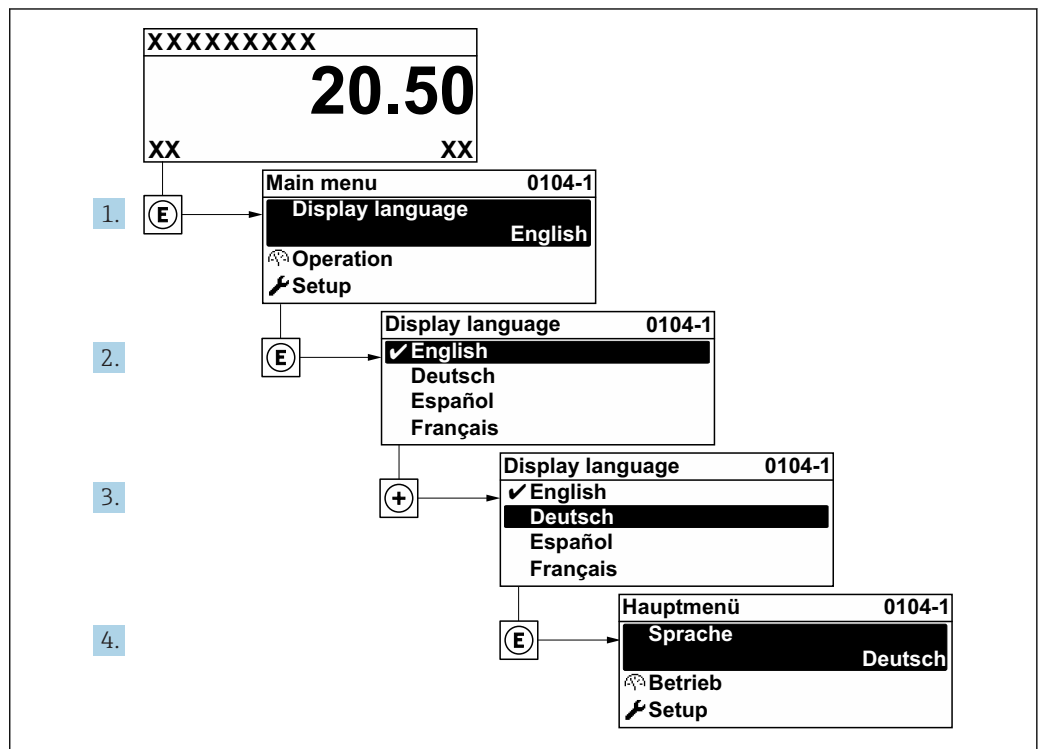

38 Taking the example of the local display

A0029420

10.5 Configuring the measuring device

- The **Setup** menu with its guided wizards contains all the parameters needed for standard operation.
- Navigation to the **Setup** menu

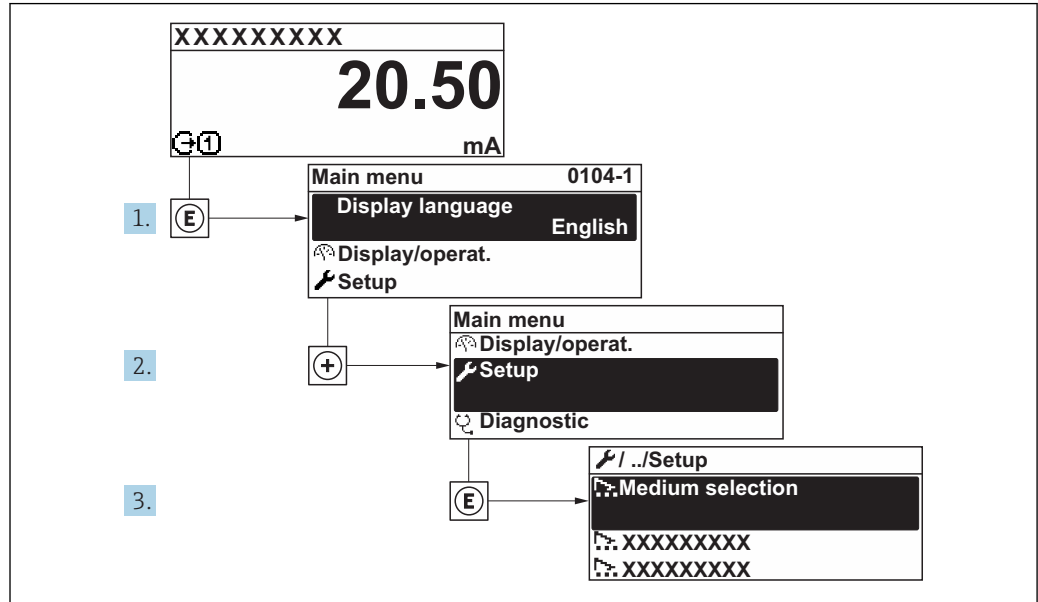

A0032222-EN

39 Taking the example of the local display

i Depending on the device version, not all submenus and parameters are available in every device. The selection can vary depending on the order code.

Navigation

"Setup" menu

🔧 Setup	
Device tag	→ 📖 111
▶ System units	→ 📖 111
▶ Communication	→ 📖 113
▶ I/O configuration	→ 📖 114
▶ Current input 1 to n	→ 📖 115
▶ Status input 1 to n	→ 📖 116
▶ Current output 1 to n	→ 📖 116
▶ Pulse/frequency/switch output 1 to n	→ 📖 119
▶ Relay output 1 to n	→ 📖 125

▶ Display	→ 126
▶ Low flow cut off	→ 129
▶ Empty pipe detection	→ 130
▶ Advanced setup	→ 131

10.5.1 Defining the tag name

To enable fast identification of the measuring point within the system, you can enter a unique designation using the **Device tag** parameter and thus change the factory setting.

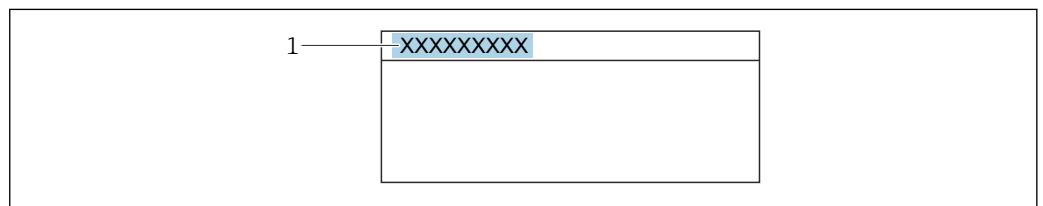

A0029422

40 Header of the operational display with tag name

1 Tag name

i Enter the tag name in the "FieldCare" operating tool → 97

Navigation

"Setup" menu → Device tag

Parameter overview with brief description

Parameter	Description	User entry	Factory setting
Device tag	Enter the name for the measuring point.	Max. 32 characters, such as letters, numbers or special characters (e.g. @, %, /).	Promag

10.5.2 Setting the system units







In the **System units** submenu the units of all the measured values can be set.

i Depending on the device version, not all submenus and parameters are available in every device. The selection can vary depending on the order code.

Navigation

"Setup" menu → System units

▶ System units	
Volume flow unit	→ 112
Volume unit	→ 112

Conductivity unit	→  112
Temperature unit	→  112
Mass flow unit	→  112
Mass unit	→  112
Density unit	→  112
Corrected volume flow unit	→  113
Corrected volume unit	→  113

Parameter overview with brief description

Parameter	Prerequisite	Description	Selection	Factory setting
Volume flow unit	–	Select volume flow unit. <i>Result</i> The selected unit applies for: <ul style="list-style-type: none"> ▪ Output ▪ Low flow cut off ▪ Simulation process variable 	Unit choose list	Country-specific: <ul style="list-style-type: none"> ▪ l/h ▪ gal/min (us)
Volume unit	–	Select volume unit.	Unit choose list	Country-specific: <ul style="list-style-type: none"> ▪ m³ ▪ gal (us)
Conductivity unit	The On option is selected in the Conductivity measurement parameter parameter.	Select conductivity unit. <i>Effect</i> The selected unit applies for: Simulation process variable	Unit choose list	µS/cm
Temperature unit	–	Select temperature unit. <i>Result</i> The selected unit applies for: <ul style="list-style-type: none"> ▪ Temperature parameter ▪ Maximum value parameter ▪ Minimum value parameter ▪ External temperature parameter ▪ Maximum value parameter ▪ Minimum value parameter 	Unit choose list	Country-specific: <ul style="list-style-type: none"> ▪ °C ▪ °F
Mass flow unit	–	Select mass flow unit. <i>Result</i> The selected unit applies for: <ul style="list-style-type: none"> ▪ Output ▪ Low flow cut off ▪ Simulation process variable 	Unit choose list	Country-specific: <ul style="list-style-type: none"> ▪ kg/h ▪ lb/min
Mass unit	–	Select mass unit.	Unit choose list	Country-specific: <ul style="list-style-type: none"> ▪ kg ▪ lb
Density unit	–	Select density unit. <i>Result</i> The selected unit applies for: <ul style="list-style-type: none"> ▪ Output ▪ Simulation process variable 	Unit choose list	Country-specific: <ul style="list-style-type: none"> ▪ kg/l ▪ lb/ft³

Parameter	Prerequisite	Description	Selection	Factory setting
Corrected volume flow unit	–	Select corrected volume flow unit. <i>Result</i> The selected unit applies for: Corrected volume flow parameter (→ ⓘ 151)	Unit choose list	Country-specific: ▪ NI/h ▪ Sft ³ /h
Corrected volume unit	–	Select corrected volume unit.	Unit choose list	Country-specific: ▪ Nm ³ ▪ Sft ³

10.5.3 Configuring the communication interface

The **Communication** submenu guides you systematically through all the parameters that have to be configured for selecting and setting the communication interface.



Navigation

"Setup" menu → Communication

► **Communication**

- MAC address → ⓘ 113
- Default network settings → ⓘ 113
- DHCP client → ⓘ 113
- IP address → ⓘ 114
- Subnet mask → ⓘ 114
- Default gateway → ⓘ 114

Parameter overview with brief description

Parameter	Description	User interface / Selection / User entry	Factory setting
MAC address	Displays the MAC address of the measuring device.  MAC = Media Access Control	Unique 12-digit character string comprising letters and numbers, e.g.: 00:07:05:10:01:5F	Each measuring device is given an individual address.
Default network settings	Select whether to restore network settings.	▪ Off ▪ On	Off
DHCP client	Select to activate/deactivate DHCP client functionality. Result If the DHCP client functionality of the Web server is activated, the IP address, Subnet mask and Default gateway are set automatically.  Identification is via the MAC address of the measuring device.	▪ Off ▪ On	Off

Parameter	Description	User interface / Selection / User entry	Factory setting
IP address	Displays the IP address of the Web server of the measuring device.	4 octet: 0 to 255 (in the particular octet)	192.168.1.212
Subnet mask	Displays the subnet mask.	4 octet: 0 to 255 (in the particular octet)	255.255.255.0
Default gateway	Displays the default gateway.	4 octet: 0 to 255 (in the particular octet)	0.0.0.0

10.5.4 Displaying the I/O configuration

The **I/O configuration** submenu guides the user systematically through all the parameters in which the configuration of the I/O modules is displayed.

Navigation

"Setup" menu → I/O configuration

► I/O configuration	
I/O module 1 to n terminal numbers	→ 114
I/O module 1 to n information	→ 114
I/O module 1 to n type	→ 114
Apply I/O configuration	→ 114
Alteration code	→ 114

Parameter overview with brief description

Parameter	Description	User interface / Selection / User entry	Factory setting
I/O module 1 to n terminal numbers	Shows the terminal numbers used by the I/O module.	<ul style="list-style-type: none"> ▪ Not used ▪ 26-27 (I/O 1) ▪ 24-25 (I/O 2) ▪ 22-23 (I/O 3) ▪ 20-21 (I/O 4) 	–
I/O module 1 to n information	Shows information of the plugged I/O module.	<ul style="list-style-type: none"> ▪ Not plugged ▪ Invalid ▪ Not configurable ▪ Configurable ▪ EtherNet/IP 	–
I/O module 1 to n type	Shows the I/O module type.	<ul style="list-style-type: none"> ▪ Off ▪ Current output[*] ▪ Current input[*] ▪ Status input[*] ▪ Pulse/frequency/switch output[*] 	Off
Apply I/O configuration	Apply parameterization of the freely configurable I/O module.	<ul style="list-style-type: none"> ▪ No ▪ Yes 	No
Alteration code	Enter the code in order to change the I/O configuration.	Positive integer	0

* Visibility depends on order options or device settings

10.5.5 Configuring the current input

The "Current input" wizard guides the user systematically through all the parameters that have to be set for configuring the current input.

Navigation

"Setup" menu → Current input

▶ Current input 1 to n

Terminal number	→ ⓘ 115
Signal mode	→ ⓘ 115
0/4 mA value	→ ⓘ 115
20 mA value	→ ⓘ 115
Current span	→ ⓘ 115
Failure mode	→ ⓘ 115
Failure value	→ ⓘ 115

Parameter overview with brief description

Parameter	Prerequisite	Description	User interface / Selection / User entry	Factory setting
Terminal number	–	Shows the terminal numbers used by the current input module.	<ul style="list-style-type: none"> ▪ Not used ▪ 24-25 (I/O 2) ▪ 22-23 (I/O 3) ▪ 20-21 (I/O 4) 	–
Signal mode	The measuring device is not approved for use in the hazardous area with type of protection Ex-i.	Select the signal mode for the current input.	<ul style="list-style-type: none"> ▪ Passive ▪ Active 	Active
0/4 mA value	–	Enter 4 mA value.	Signed floating-point number	0
20 mA value	–	Enter 20 mA value.	Signed floating-point number	Depends on country and nominal diameter
Current span	–	Select current range for process value output and upper/lower level for alarm signal.	<ul style="list-style-type: none"> ▪ 4...20 mA ▪ 4...20 mA NAMUR ▪ 4...20 mA US ▪ 0...20 mA 	Country-specific: <ul style="list-style-type: none"> ▪ 4...20 mA NAMUR ▪ 4...20 mA US
Failure mode	–	Define input behavior in alarm condition.	<ul style="list-style-type: none"> ▪ Alarm ▪ Last valid value ▪ Defined value 	Alarm
Failure value	In the Failure mode parameter, the Defined value option is selected.	Enter value to be used by the device if input value from external device is missing.	Signed floating-point number	0

10.5.6 Configuring the status input

The **Status input** submenu guides the user systematically through all the parameters that have to be set for configuring the status input.

Navigation

"Setup" menu → Status input

▶ Status input 1 to n

Assign status input	→ 116
Terminal number	→ 116
Active level	→ 116
Terminal number	→ 116
Response time status input	→ 116
Terminal number	→ 116

Parameter overview with brief description

Parameter	Description	User interface / Selection / User entry	Factory setting
Terminal number	Shows the terminal numbers used by the status input module.	<ul style="list-style-type: none"> ▪ Not used ▪ 24-25 (I/O 2) ▪ 22-23 (I/O 3) ▪ 20-21 (I/O 4) 	–
Assign status input	Select function for the status input.	<ul style="list-style-type: none"> ▪ Off ▪ Reset totalizer 1 ▪ Reset totalizer 2 ▪ Reset totalizer 3 ▪ Reset all totalizers ▪ Flow override 	Off
Active level	Define input signal level at which the assigned function is triggered.	<ul style="list-style-type: none"> ▪ High ▪ Low 	High
Response time status input	Define the minimum amount of time the input signal level must be present before the selected function is triggered.	5 to 200 ms	50 ms

10.5.7 Configuring the current output









The **Current output** wizard guides you systematically through all the parameters that have to be set for configuring the current output.

Navigation



"Setup" menu → Current output

▶ Current output 1 to n

Terminal number	→ 117
-----------------	--------

Signal mode	→  117
Assign current output 1 to n	→  117
Current span	→  117
0/4 mA value	→  117
20 mA value	→  117
Fixed current	→  118
Damping output 1 to n	→  118
Failure mode	→  118
Failure current	→  118

Parameter overview with brief description

Parameter	Prerequisite	Description	User interface / Selection / User entry	Factory setting
Terminal number	–	Shows the terminal numbers used by the current output module.	<ul style="list-style-type: none"> ▪ Not used ▪ 24-25 (I/O 2) ▪ 22-23 (I/O 3) ▪ 20-21 (I/O 4) 	–
Signal mode	–	Select the signal mode for the current output.	<ul style="list-style-type: none"> ▪ Passive ▪ Active 	Active
Assign current output 1 to n	–	Select process variable for current output.	<ul style="list-style-type: none"> ▪ Off ▪ Volume flow ▪ Mass flow ▪ Corrected volume flow ▪ Flow velocity ▪ Conductivity* ▪ Electronic temperature 	Volume flow
Current span	–	Select current range for process value output and upper/lower level for alarm signal.	<ul style="list-style-type: none"> ▪ 4...20 mA NAMUR ▪ 4...20 mA US ▪ 4...20 mA ▪ 0...20 mA ▪ Fixed current 	Country-specific: <ul style="list-style-type: none"> ▪ 4...20 mA NAMUR ▪ 4...20 mA US
0/4 mA value	One of the following options is selected in the Current span parameter (→  117): <ul style="list-style-type: none"> ▪ 4...20 mA NAMUR ▪ 4...20 mA US ▪ 4...20 mA ▪ 0...20 mA 	Enter 4 mA value.	Signed floating-point number	Country-specific: <ul style="list-style-type: none"> ▪ 0 l/h ▪ 0 gal/min (us)
20 mA value	One of the following options is selected in the Current span parameter (→  117): <ul style="list-style-type: none"> ▪ 4...20 mA NAMUR ▪ 4...20 mA US ▪ 4...20 mA ▪ 0...20 mA 	Enter 20 mA value.	Signed floating-point number	Depends on country and nominal diameter

Parameter	Prerequisite	Description	User interface / Selection / User entry	Factory setting
Fixed current	The Fixed current option is selected in the Current span parameter (→ 117).	Defines the fixed output current.	0 to 22.5 mA	22.5 mA
Damping output 1 to n	One of the following options is selected in the Assign current output parameter (→ 117): <ul style="list-style-type: none"> ▪ Volume flow ▪ Mass flow ▪ Corrected volume flow ▪ Flow velocity ▪ Conductivity* ▪ Electronic temperature One of the following options is selected in the Current span parameter (→ 117): <ul style="list-style-type: none"> ▪ 4...20 mA NAMUR ▪ 4...20 mA US ▪ 4...20 mA ▪ 0...20 mA 	Set reaction time for output signal to fluctuations in the measured value.	0.0 to 999.9 s	1.0 s
Failure mode	One of the following options is selected in the Assign current output parameter (→ 117): <ul style="list-style-type: none"> ▪ Volume flow ▪ Mass flow ▪ Corrected volume flow ▪ Flow velocity ▪ Conductivity* ▪ Electronic temperature One of the following options is selected in the Current span parameter (→ 117): <ul style="list-style-type: none"> ▪ 4...20 mA NAMUR ▪ 4...20 mA US ▪ 4...20 mA ▪ 0...20 mA 	Define output behavior in alarm condition.	<ul style="list-style-type: none"> ▪ Min. ▪ Max. ▪ Last valid value ▪ Actual value ▪ Defined value 	Max.
Failure current	The Defined value option is selected in the Failure mode parameter.	Enter current output value in alarm condition.	0 to 22.5 mA	22.5 mA

* Visibility depends on order options or device settings

10.5.8 Configuring the pulse/frequency/switch output

The **Pulse/frequency/switch output** wizard guides you systematically through all the parameters that can be set for configuring the selected output type.

Navigation

"Setup" menu → Advanced setup → Pulse/frequency/switch output

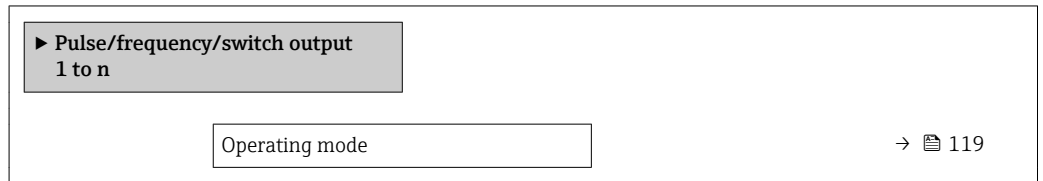

Parameter overview with brief description

Parameter	Description	Selection	Factory setting
Operating mode	Define the output as a pulse, frequency or switch output.	<ul style="list-style-type: none"> ■ Pulse ■ Frequency ■ Switch 	Pulse



Configuring the pulse output

Navigation

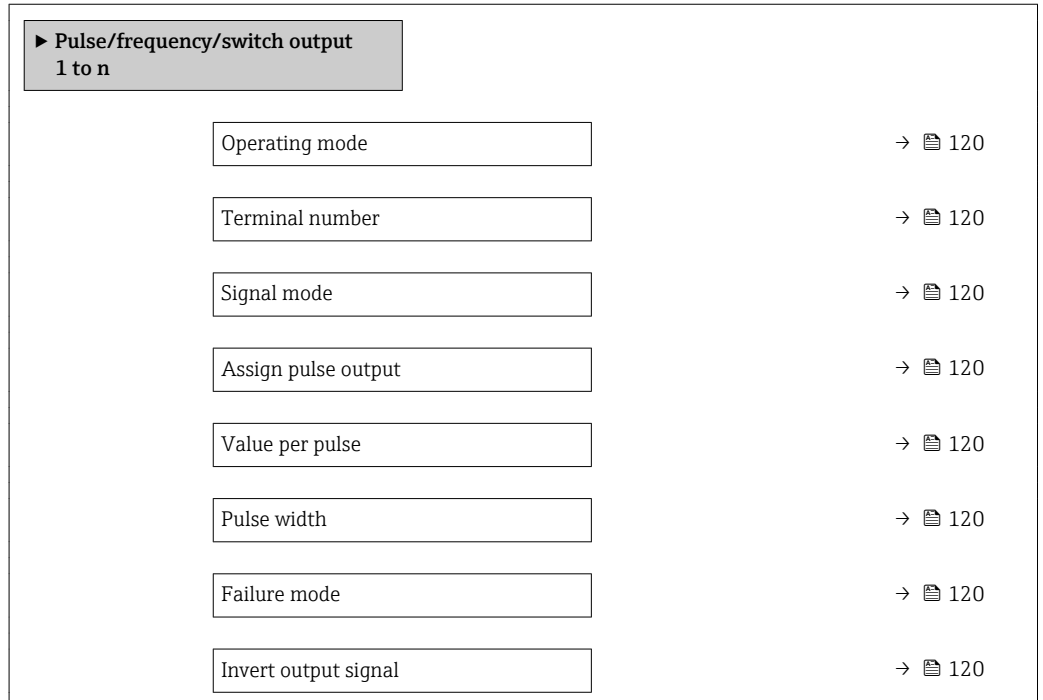
"Setup" menu → Pulse/frequency/switch output



Parameter overview with brief description





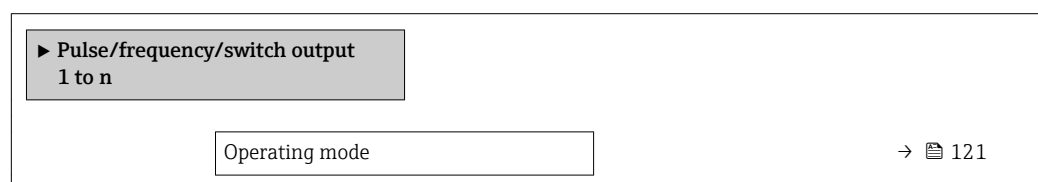

Parameter	Prerequisite	Description	Selection / User interface / User entry	Factory setting
Operating mode	–	Define the output as a pulse, frequency or switch output.	<ul style="list-style-type: none"> ▪ Pulse ▪ Frequency ▪ Switch 	Pulse
Terminal number	–	Shows the terminal numbers used by the PFS output module.	<ul style="list-style-type: none"> ▪ Not used ▪ 24-25 (I/O 2) ▪ 22-23 (I/O 3) ▪ 20-21 (I/O 4) 	–
Signal mode	–	Select the signal mode for the PFS output.	<ul style="list-style-type: none"> ▪ Passive ▪ Active 	Passive
Assign pulse output 1 to n	The Pulse option is selected in the Operating mode parameter.	Select process variable for pulse output.	<ul style="list-style-type: none"> ▪ Off ▪ Volume flow ▪ Mass flow ▪ Corrected volume flow 	Off
Value per pulse	In the Operating mode parameter, the Pulse option is selected, and one of the following options is selected in the Assign pulse output parameter (→  120): <ul style="list-style-type: none"> ▪ Mass flow ▪ Volume flow ▪ Corrected volume flow 	Enter measured value at which a pulse is output.	Signed floating-point number	Depends on country and nominal diameter
Pulse width	In the Operating mode parameter, the Pulse option is selected, and one of the following options is selected in the Assign pulse output parameter (→  120): <ul style="list-style-type: none"> ▪ Mass flow ▪ Volume flow ▪ Corrected volume flow 	Define time width of the output pulse.	0.05 to 2 000 ms	100 ms
Failure mode	In the Operating mode parameter, the Pulse option is selected, and one of the following options is selected in the Assign pulse output parameter (→  120): <ul style="list-style-type: none"> ▪ Mass flow ▪ Volume flow ▪ Corrected volume flow 	Define output behavior in alarm condition.	<ul style="list-style-type: none"> ▪ Actual value ▪ No pulses 	No pulses
Invert output signal	–	Invert the output signal.	<ul style="list-style-type: none"> ▪ No ▪ Yes 	No

Configuring the frequency output



Navigation





"Setup" menu → Pulse/frequency/switch output



Terminal number	→  121
Signal mode	→  121
Assign frequency output	→  121
Minimum frequency value	→  121
Maximum frequency value	→  122
Measuring value at minimum frequency	→  122
Measuring value at maximum frequency	→  122
Failure mode	→  122
Failure frequency	→  122
Invert output signal	→  122

Parameter overview with brief description

Parameter	Prerequisite	Description	Selection / User interface / User entry	Factory setting
Operating mode	–	Define the output as a pulse, frequency or switch output.	<ul style="list-style-type: none"> ■ Pulse ■ Frequency ■ Switch 	Pulse
Terminal number	–	Shows the terminal numbers used by the PFS output module.	<ul style="list-style-type: none"> ■ Not used ■ 24-25 (I/O 2) ■ 22-23 (I/O 3) ■ 20-21 (I/O 4) 	–
Signal mode	–	Select the signal mode for the PFS output.	<ul style="list-style-type: none"> ■ Passive ■ Active 	Passive
Assign frequency output	The Frequency option is selected in the Operating mode parameter (→  119).	Select process variable for frequency output.	<ul style="list-style-type: none"> ■ Off ■ Volume flow ■ Mass flow ■ Corrected volume flow ■ Flow velocity* ■ Conductivity* ■ Electronic temperature 	Off
Minimum frequency value	One of the following options is selected in the Assign current output parameter (→  117): <ul style="list-style-type: none"> ■ Volume flow ■ Mass flow ■ Corrected volume flow ■ Flow velocity ■ Conductivity* ■ Electronic temperature 	Enter minimum frequency.	0.0 to 10 000.0 Hz	0.0 Hz

Parameter	Prerequisite	Description	Selection / User interface / User entry	Factory setting
Maximum frequency value	One of the following options is selected in the Assign current output parameter (→  117): <ul style="list-style-type: none"> ▪ Volume flow ▪ Mass flow ▪ Corrected volume flow ▪ Flow velocity ▪ Conductivity* ▪ Electronic temperature 	Enter maximum frequency.	0.0 to 10 000.0 Hz	10000.0 Hz
Measuring value at minimum frequency	One of the following options is selected in the Assign current output parameter (→  117): <ul style="list-style-type: none"> ▪ Volume flow ▪ Mass flow ▪ Corrected volume flow ▪ Flow velocity ▪ Conductivity* ▪ Electronic temperature 	Enter measured value for minimum frequency.	Signed floating-point number	Depends on country and nominal diameter
Measuring value at maximum frequency	One of the following options is selected in the Assign current output parameter (→  117): <ul style="list-style-type: none"> ▪ Volume flow ▪ Mass flow ▪ Corrected volume flow ▪ Flow velocity ▪ Conductivity* ▪ Electronic temperature 	Enter measured value for maximum frequency.	Signed floating-point number	Depends on country and nominal diameter
Failure mode	One of the following options is selected in the Assign current output parameter (→  117): <ul style="list-style-type: none"> ▪ Volume flow ▪ Mass flow ▪ Corrected volume flow ▪ Flow velocity ▪ Conductivity* ▪ Electronic temperature 	Define output behavior in alarm condition.	<ul style="list-style-type: none"> ▪ Actual value ▪ Defined value ▪ 0 Hz 	0 Hz
Failure frequency	One of the following options is selected in the Assign current output parameter (→  117): <ul style="list-style-type: none"> ▪ Volume flow ▪ Mass flow ▪ Corrected volume flow ▪ Flow velocity ▪ Conductivity* ▪ Electronic temperature 	Enter frequency output value in alarm condition.	0.0 to 12 500.0 Hz	0.0 Hz
Invert output signal	–	Invert the output signal.	<ul style="list-style-type: none"> ▪ No ▪ Yes 	No

* Visibility depends on order options or device settings

Configuring the switch output

Navigation

"Setup" menu → Pulse/frequency/switch output

► Pulse/frequency/switch output 1 to n		
Operating mode	→	📖 123
Terminal number	→	📖 123
Signal mode	→	📖 123
Switch output function	→	📖 124
Assign diagnostic behavior	→	📖 124
Assign limit	→	📖 124
Assign flow direction check	→	📖 124
Assign status	→	📖 124
Switch-on value	→	📖 124
Switch-off value	→	📖 124
Switch-on delay	→	📖 124
Switch-off delay	→	📖 125
Failure mode	→	📖 125
Invert output signal	→	📖 125

Parameter overview with brief description

Parameter	Prerequisite	Description	Selection / User interface / User entry	Factory setting
Operating mode	–	Define the output as a pulse, frequency or switch output.	<ul style="list-style-type: none"> ■ Pulse ■ Frequency ■ Switch 	Pulse
Terminal number	–	Shows the terminal numbers used by the PFS output module.	<ul style="list-style-type: none"> ■ Not used ■ 24-25 (I/O 2) ■ 22-23 (I/O 3) ■ 20-21 (I/O 4) 	–
Signal mode	–	Select the signal mode for the PFS output.	<ul style="list-style-type: none"> ■ Passive ■ Active 	Passive

Parameter	Prerequisite	Description	Selection / User interface / User entry	Factory setting
Switch output function	The Switch option is selected in the Operating mode parameter.	Select function for switch output.	<ul style="list-style-type: none"> ▪ Off ▪ On ▪ Diagnostic behavior ▪ Limit ▪ Flow direction check ▪ Status 	Off
Assign diagnostic behavior	<ul style="list-style-type: none"> ▪ In the Operating mode parameter, the Switch option is selected. ▪ In the Switch output function parameter, the Diagnostic behavior option is selected. 	Select diagnostic behavior for switch output.	<ul style="list-style-type: none"> ▪ Alarm ▪ Alarm or warning ▪ Warning 	Alarm
Assign limit	<ul style="list-style-type: none"> ▪ The Switch option is selected in the Operating mode parameter. ▪ The Limit option is selected in the Switch output function parameter. 	Select process variable for limit function.	<ul style="list-style-type: none"> ▪ Off ▪ Volume flow ▪ Mass flow ▪ Corrected volume flow ▪ Flow velocity* ▪ Conductivity* ▪ Totalizer 1 ▪ Totalizer 2 ▪ Totalizer 3 ▪ Electronic temperature 	Volume flow
Assign flow direction check	<ul style="list-style-type: none"> ▪ The Switch option is selected in the Operating mode parameter. ▪ The Flow direction check option is selected in the Switch output function parameter. 	Select process variable for flow direction monitoring.	<ul style="list-style-type: none"> ▪ Off ▪ Volume flow ▪ Mass flow ▪ Corrected volume flow 	Volume flow
Assign status	<ul style="list-style-type: none"> ▪ The Switch option is selected in the Operating mode parameter. ▪ The Status option is selected in the Switch output function parameter. 	Select device status for switch output.	<ul style="list-style-type: none"> ▪ Empty pipe detection ▪ Low flow cut off 	Empty pipe detection
Switch-on value	<ul style="list-style-type: none"> ▪ In the Operating mode parameter, the Switch option is selected. ▪ In the Switch output function parameter, the Limit option is selected. 	Enter measured value for the switch-on point.	Signed floating-point number	Country-specific: <ul style="list-style-type: none"> ▪ 0 l/h ▪ 0 gal/min (us)
Switch-off value	<ul style="list-style-type: none"> ▪ In the Operating mode parameter, the Switch option is selected. ▪ In the Switch output function parameter, the Limit option is selected. 	Enter measured value for the switch-off point.	Signed floating-point number	Country-specific: <ul style="list-style-type: none"> ▪ 0 l/h ▪ 0 gal/min (us)
Switch-on delay	<ul style="list-style-type: none"> ▪ The Switch option is selected in the Operating mode parameter. ▪ The Limit option is selected in the Switch output function parameter. 	Define delay for the switch-on of status output.	0.0 to 100.0 s	0.0 s

Parameter	Prerequisite	Description	Selection / User interface / User entry	Factory setting
Switch-off delay	<ul style="list-style-type: none"> ▪ The Switch option is selected in the Operating mode parameter. ▪ The Limit option is selected in the Switch output function parameter. 	Define delay for the switch-off of status output.	0.0 to 100.0 s	0.0 s
Failure mode	–	Define output behavior in alarm condition.	<ul style="list-style-type: none"> ▪ Actual status ▪ Open ▪ Closed 	Open
Invert output signal	–	Invert the output signal.	<ul style="list-style-type: none"> ▪ No ▪ Yes 	No

* Visibility depends on order options or device settings

10.5.9 Configuring the relay output

The **Relay output** wizard guides the user systematically through all the parameters that have to be set for configuring the relay output.

Navigation

"Setup" menu → Relay output 1 to n

▶ RelaisOutput 1 to n

Switch output function	→ 126
Assign flow direction check	→ 126
Assign limit	→ 126
Assign diagnostic behavior	→ 126
Assign status	→ 126
Switch-off value	→ 126
Switch-on value	→ 126
Failure mode	→ 126

Parameter overview with brief description

Parameter	Prerequisite	Description	Selection / User interface / User entry	Factory setting
Relay output function	–	Select the function for the relay output.	<ul style="list-style-type: none"> ▪ Closed ▪ Open ▪ Diagnostic behavior ▪ Limit ▪ Flow direction check ▪ Digital Output 	Closed
Terminal number	–	Shows the terminal numbers used by the relay output module.	<ul style="list-style-type: none"> ▪ Not used ▪ 24-25 (I/O 2) ▪ 22-23 (I/O 3) ▪ 20-21 (I/O 4) 	–
Assign flow direction check	In the Relay output function parameter, the Flow direction check option is selected.	Select process variable for flow direction monitoring.	<ul style="list-style-type: none"> ▪ Off ▪ Volume flow ▪ Mass flow ▪ Corrected volume flow 	Volume flow
Assign limit	In the Relay output function parameter, the Limit option is selected.	Select process variable for limit function.	<ul style="list-style-type: none"> ▪ Off ▪ Volume flow ▪ Mass flow ▪ Corrected volume flow ▪ Flow velocity* ▪ Conductivity* ▪ Totalizer 1 ▪ Totalizer 2 ▪ Totalizer 3 ▪ Electronic temperature 	Volume flow
Assign diagnostic behavior	In the Relay output function parameter, the Diagnostic behavior option is selected.	Select diagnostic behavior for switch output.	<ul style="list-style-type: none"> ▪ Alarm ▪ Alarm or warning ▪ Warning 	Alarm
Assign status	In the Relay output function parameter, the Digital Output option is selected.	Select device status for switch output.	<ul style="list-style-type: none"> ▪ Partially filled pipe detection ▪ Low flow cut off 	Partially filled pipe detection
Switch-off value	In the Relay output function parameter, the Limit option is selected.	Enter measured value for the switch-off point.	Signed floating-point number	Country-specific: <ul style="list-style-type: none"> ▪ 0 l/h ▪ 0 gal(us)/min
Switch-off delay	In the Relay output function parameter, the Limit option is selected.	Define delay for the switch-off of status output.	0.0 to 100.0 s	0.0 s
Switch-on value	In the Relay output function parameter, the Limit option is selected.	Enter measured value for the switch-on point.	Signed floating-point number	Country-specific: <ul style="list-style-type: none"> ▪ 0 l/h ▪ 0 gal(us)/min
Switch-on delay	In the Relay output function parameter, the Limit option is selected.	Define delay for the switch-on of status output.	0.0 to 100.0 s	0.0 s
Failure mode	–	Define output behavior in alarm condition.	<ul style="list-style-type: none"> ▪ Actual status ▪ Open ▪ Closed 	Open

* Visibility depends on order options or device settings

10.5.10 Configuring the local display

The **Display** wizard guides you systematically through all the parameters that can be configured for configuring the local display.

Navigation
 "Setup" menu → Display

▶ Display		
Format display	→	📖 127
Value 1 display	→	📖 127
0% bargraph value 1	→	📖 127
100% bargraph value 1	→	📖 127
Value 2 display	→	📖 128
Value 3 display	→	📖 128
0% bargraph value 3	→	📖 128
100% bargraph value 3	→	📖 128
Value 4 display	→	📖 128

Parameter overview with brief description

Parameter	Prerequisite	Description	Selection / User entry	Factory setting
Format display	A local display is provided.	Select how measured values are shown on the display.	<ul style="list-style-type: none"> ▪ 1 value, max. size ▪ 1 bargraph + 1 value ▪ 2 values ▪ 1 value large + 2 values ▪ 4 values 	1 value, max. size
Value 1 display	A local display is provided.	Select the measured value that is shown on the local display.	<ul style="list-style-type: none"> ▪ Volume flow ▪ Mass flow ▪ Corrected volume flow ▪ Flow velocity ▪ Totalizer 1 ▪ Totalizer 2 ▪ Totalizer 3 ▪ Current output 1 ▪ Current output 2 * ▪ Current output 3 * ▪ Current output 4 * ▪ Electronic temperature 	Volume flow
0% bargraph value 1	A local display is provided.	Enter 0% value for bar graph display.	Signed floating-point number	Country-specific: <ul style="list-style-type: none"> ▪ 0 l/h ▪ 0 gal/min (us)
100% bargraph value 1	A local display is provided.	Enter 100% value for bar graph display.	Signed floating-point number	Depends on country and nominal diameter

Parameter	Prerequisite	Description	Selection / User entry	Factory setting
Value 2 display	A local display is provided.	Select the measured value that is shown on the local display.	<ul style="list-style-type: none"> ▪ None ▪ Volume flow ▪ Mass flow ▪ Corrected volume flow ▪ Flow velocity ▪ Conductivity ▪ Corrected conductivity ▪ Totalizer 1 ▪ Totalizer 2 ▪ Totalizer 3 ▪ Current output 1 ▪ Current output 2 * ▪ Current output 3 * ▪ Current output 4 * ▪ Temperature ▪ Electronic temperature 	None
Value 3 display	A local display is provided.	Select the measured value that is shown on the local display.	<ul style="list-style-type: none"> ▪ None ▪ Volume flow ▪ Mass flow ▪ Corrected volume flow ▪ Flow velocity ▪ Conductivity ▪ Corrected conductivity ▪ Totalizer 1 ▪ Totalizer 2 ▪ Totalizer 3 ▪ Current output 1 ▪ Current output 2 * ▪ Current output 3 * ▪ Current output 4 * ▪ Temperature ▪ Electronic temperature 	None
0% bargraph value 3	A selection was made in the Value 3 display parameter.	Enter 0% value for bar graph display.	Signed floating-point number	Country-specific: <ul style="list-style-type: none"> ▪ 0 l/h ▪ 0 gal/min (us)
100% bargraph value 3	A selection was made in the Value 3 display parameter.	Enter 100% value for bar graph display.	Signed floating-point number	0
Value 4 display	A local display is provided.	Select the measured value that is shown on the local display.	<ul style="list-style-type: none"> ▪ None ▪ Volume flow ▪ Mass flow ▪ Corrected volume flow ▪ Flow velocity ▪ Conductivity ▪ Corrected conductivity ▪ Totalizer 1 ▪ Totalizer 2 ▪ Totalizer 3 ▪ Current output 1 ▪ Current output 2 * ▪ Current output 3 * ▪ Current output 4 * ▪ Temperature ▪ Electronic temperature 	None

* Visibility depends on order options or device settings

10.5.11 Configuring the low flow cut off

The **Low flow cut off** wizard systematically guides the user through all the parameters that must be set to configure low flow cut off.

Navigation

"Setup" menu → Low flow cut off

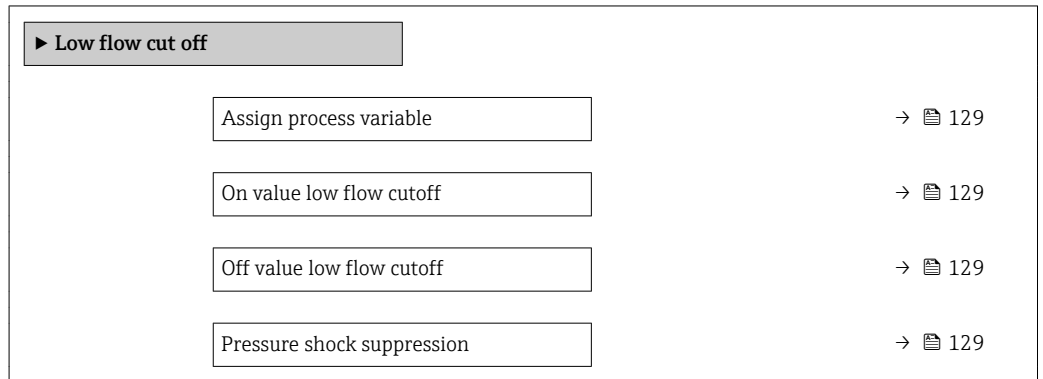

Parameter overview with brief description





Parameter	Prerequisite	Description	Selection / User entry	Factory setting
Assign process variable	–	Select process variable for low flow cut off.	<ul style="list-style-type: none"> ▪ Off ▪ Volume flow ▪ Mass flow ▪ Corrected volume flow 	Volume flow
On value low flow cutoff	One of the following options is selected in the Assign process variable parameter (→ 129): <ul style="list-style-type: none"> ▪ Volume flow ▪ Mass flow 	Enter on value for low flow cut off.	Positive floating-point number	Depends on country and nominal diameter
Off value low flow cutoff	One of the following options is selected in the Assign process variable parameter (→ 129): <ul style="list-style-type: none"> ▪ Volume flow ▪ Mass flow ▪ Corrected volume flow 	Enter off value for low flow cut off.	0 to 100.0 %	50 %
Pressure shock suppression	One of the following options is selected in the Assign process variable parameter (→ 129): <ul style="list-style-type: none"> ▪ Volume flow ▪ Mass flow ▪ Corrected volume flow 	Enter time frame for signal suppression (= active pressure shock suppression).	0 to 100 s	0 s

10.5.12 Configuring empty pipe detection

The **Empty pipe detection** submenu contains parameters that must be configured for the configuration of empty pipe detection.

Navigation

"Setup" menu → Empty pipe detection

▶ Empty pipe detection	
Empty pipe detection	→  130
New adjustment	→  130
Progress	→  130
Switch point empty pipe detection	→  130
Response time empty pipe detection	→  130

Parameter overview with brief description

Parameter	Prerequisite	Description	Selection / User interface / User entry	Factory setting
Empty pipe detection	–	Switch empty pipe detection on and off.	<ul style="list-style-type: none"> ▪ Off ▪ On 	Off
New adjustment	The On option is selected in the Empty pipe detection parameter.	Select type of adjustment.	<ul style="list-style-type: none"> ▪ Cancel ▪ Empty pipe adjust ▪ Full pipe adjust 	Cancel
Progress	The On option is selected in the Empty pipe detection parameter.	Shows the progress.	<ul style="list-style-type: none"> ▪ Ok ▪ Busy ▪ Not ok 	–
Switch point empty pipe detection	The On option is selected in the Empty pipe detection parameter.	Enter hysteresis in %, below this value the measuring tube will be detected as empty.	0 to 100 %	10 %
Response time empty pipe detection	In the Empty pipe detection parameter (→  130), the On option is selected.	Enter the time before diagnostic message S862 'Pipe empty' is displayed for empty pipe detection.	0 to 100 s	1 s

10.6 Advanced settings

The **Advanced setup** submenu together with its submenus contains parameters for specific settings.

Navigation to the "Advanced setup" submenu

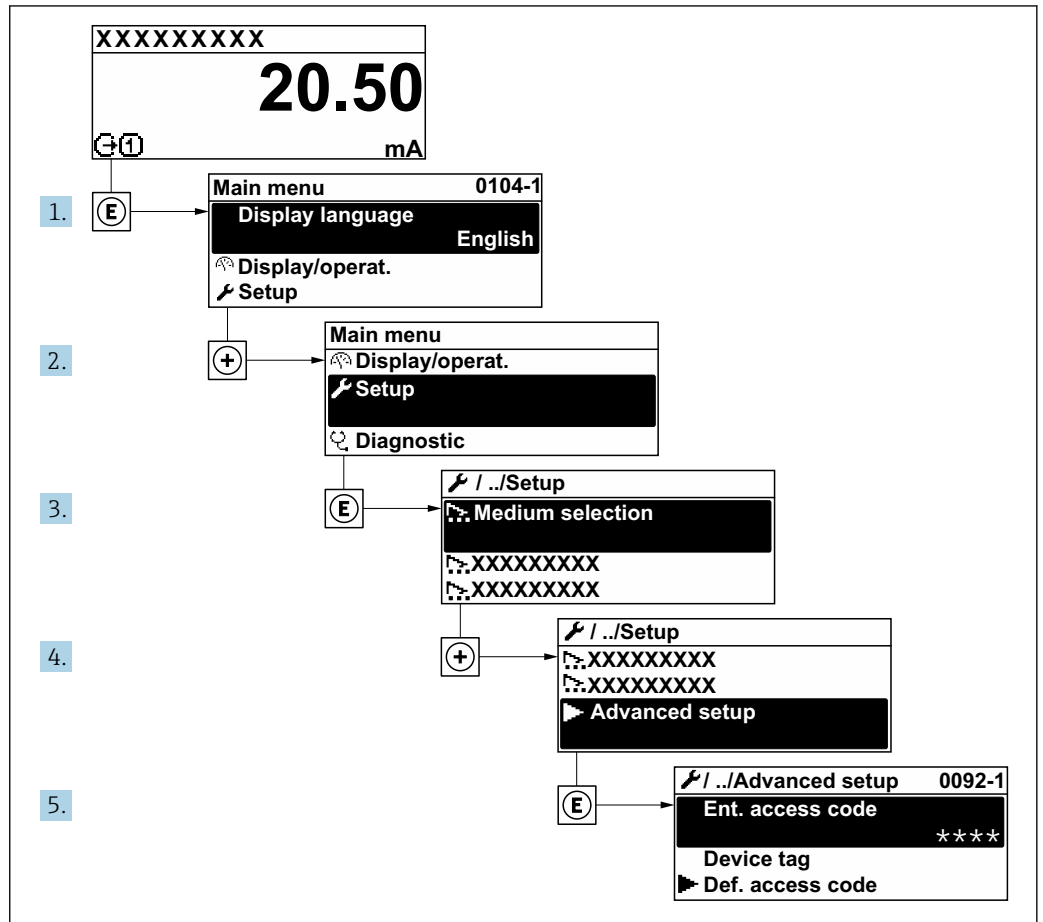

A003223-EN

i The number of submenus can vary depending on the device version. Some submenus are not dealt with in the Operating Instructions. These submenus and the parameters they contain are explained in the Special Documentation for the device.

Navigation

"Setup" menu → Advanced setup

▶ Advanced setup	
Enter access code	→ ⓘ 132
▶ Sensor adjustment	→ ⓘ 132
▶ Totalizer 1 to n	→ ⓘ 132
▶ Display	→ ⓘ 134
▶ Electrode cleaning circuit	→ ⓘ 137

▶ WLAN settings	→ 📄 138
▶ Heartbeat setup	
▶ Configuration backup	→ 📄 140
▶ Administration	→ 📄 141

10.6.1 Using the parameter to enter the access code

Navigation

"Setup" menu → Advanced setup

Parameter overview with brief description

Parameter	Description	User entry
Enter access code	Enter access code to disable write protection of parameters.	0 to 9999

10.6.2 Carrying out a sensor adjustment

The **Sensor adjustment** submenu contains parameters that pertain to the functionality of the sensor.

Navigation

"Setup" menu → Advanced setup → Sensor adjustment

▶ Sensor adjustment	
Installation direction	→ 📄 132

Parameter overview with brief description

Parameter	Description	Selection	Factory setting
Installation direction	Set sign of flow direction to match the direction of the arrow on the sensor.	<ul style="list-style-type: none"> ▪ Flow in arrow direction ▪ Flow against arrow direction 	Flow in arrow direction



10.6.3 Configuring the totalizer

In the **"Totalizer 1 to n"** submenu the individual totalizer can be configured.

Navigation

"Setup" menu → Advanced setup → Totalizer 1 to n

▶ Totalizer 1 to n	
Assign process variable	→ 📄 133
Unit totalizer 1 to n	→ 📄 133

Totalizer operation mode	→  133
Failure mode	→  133

Parameter overview with brief description





















Parameter	Prerequisite	Description	Selection	Factory setting
Assign process variable	–	Select process variable for totalizer.	<ul style="list-style-type: none"> ▪ Off ▪ Volume flow ▪ Mass flow ▪ Corrected volume flow 	Volume flow
Unit totalizer 1 to n	One of the following options is selected in the Assign process variable parameter (→  133) of the Totalizer 1 to n submenu: <ul style="list-style-type: none"> ▪ Volume flow ▪ Mass flow ▪ Corrected volume flow 	Select process variable totalizer unit.	Unit choose list	1
Totalizer operation mode	–	Select totalizer calculation mode.	<ul style="list-style-type: none"> ▪ Net flow total ▪ Forward flow total ▪ Reverse flow total 	Net flow total
Failure mode	–	Define totalizer behavior in alarm condition.	<ul style="list-style-type: none"> ▪ Stop ▪ Actual value ▪ Last valid value 	Stop

10.6.4 Carrying out additional display configurations

In the **Display** submenu you can set all the parameters associated with the configuration of the local display.

Navigation

"Setup" menu → Advanced setup → Display

► Display	
Format display	→  135
Value 1 display	→  135
0% bargraph value 1	→  135
100% bargraph value 1	→  135
Decimal places 1	→  135
Value 2 display	→  135
Decimal places 2	→  135
Value 3 display	→  136
0% bargraph value 3	→  136
100% bargraph value 3	→  136
Decimal places 3	→  136
Value 4 display	→  136
Decimal places 4	→  136
Display language	→  137
Display interval	→  137
Display damping	→  137
Header	→  137
Header text	→  137
Separator	→  137
Backlight	→  137

Parameter overview with brief description

Parameter	Prerequisite	Description	Selection / User entry	Factory setting
Format display	A local display is provided.	Select how measured values are shown on the display.	<ul style="list-style-type: none"> ■ 1 value, max. size ■ 1 bargraph + 1 value ■ 2 values ■ 1 value large + 2 values ■ 4 values 	1 value, max. size
Value 1 display	A local display is provided.	Select the measured value that is shown on the local display.	<ul style="list-style-type: none"> ■ Volume flow ■ Mass flow ■ Corrected volume flow ■ Flow velocity ■ Totalizer 1 ■ Totalizer 2 ■ Totalizer 3 ■ Current output 1 ■ Current output 2 * ■ Current output 3 * ■ Current output 4 * ■ Electronic temperature 	Volume flow
0% bargraph value 1	A local display is provided.	Enter 0% value for bar graph display.	Signed floating-point number	Country-specific: <ul style="list-style-type: none"> ■ 0 l/h ■ 0 gal/min (us)
100% bargraph value 1	A local display is provided.	Enter 100% value for bar graph display.	Signed floating-point number	Depends on country and nominal diameter
Decimal places 1	A measured value is specified in the Value 1 display parameter.	Select the number of decimal places for the display value.	<ul style="list-style-type: none"> ■ x ■ x.x ■ x.xx ■ x.xxx ■ x.xxxx 	x.xx
Value 2 display	A local display is provided.	Select the measured value that is shown on the local display.	<ul style="list-style-type: none"> ■ None ■ Volume flow ■ Mass flow ■ Corrected volume flow ■ Flow velocity ■ Conductivity ■ Corrected conductivity ■ Totalizer 1 ■ Totalizer 2 ■ Totalizer 3 ■ Current output 1 ■ Current output 2 * ■ Current output 3 * ■ Current output 4 * ■ Temperature ■ Electronic temperature 	None
Decimal places 2	A measured value is specified in the Value 2 display parameter.	Select the number of decimal places for the display value.	<ul style="list-style-type: none"> ■ x ■ x.x ■ x.xx ■ x.xxx ■ x.xxxx 	x.xx

Parameter	Prerequisite	Description	Selection / User entry	Factory setting
Value 3 display	A local display is provided.	Select the measured value that is shown on the local display.	<ul style="list-style-type: none"> ▪ None ▪ Volume flow ▪ Mass flow ▪ Corrected volume flow ▪ Flow velocity ▪ Conductivity ▪ Corrected conductivity ▪ Totalizer 1 ▪ Totalizer 2 ▪ Totalizer 3 ▪ Current output 1 ▪ Current output 2 * ▪ Current output 3 * ▪ Current output 4 * ▪ Temperature ▪ Electronic temperature 	None
0% bargraph value 3	A selection was made in the Value 3 display parameter.	Enter 0% value for bar graph display.	Signed floating-point number	Country-specific: <ul style="list-style-type: none"> ▪ 0 l/h ▪ 0 gal/min (us)
100% bargraph value 3	A selection was made in the Value 3 display parameter.	Enter 100% value for bar graph display.	Signed floating-point number	0
Decimal places 3	A measured value is specified in the Value 3 display parameter.	Select the number of decimal places for the display value.	<ul style="list-style-type: none"> ▪ x ▪ x.x ▪ x.xx ▪ x.xxx ▪ x.xxxx 	x.xx
Value 4 display	A local display is provided.	Select the measured value that is shown on the local display.	<ul style="list-style-type: none"> ▪ None ▪ Volume flow ▪ Mass flow ▪ Corrected volume flow ▪ Flow velocity ▪ Conductivity ▪ Corrected conductivity ▪ Totalizer 1 ▪ Totalizer 2 ▪ Totalizer 3 ▪ Current output 1 ▪ Current output 2 * ▪ Current output 3 * ▪ Current output 4 * ▪ Temperature ▪ Electronic temperature 	None
Decimal places 4	A measured value is specified in the Value 4 display parameter.	Select the number of decimal places for the display value.	<ul style="list-style-type: none"> ▪ x ▪ x.x ▪ x.xx ▪ x.xxx ▪ x.xxxx 	x.xx

Parameter	Prerequisite	Description	Selection / User entry	Factory setting
Display language	A local display is provided.	Set display language.	<ul style="list-style-type: none"> ■ English * ■ Deutsch * ■ Français * ■ Español * ■ Italiano * ■ Nederlands * ■ Portuguesa * ■ Polski * ■ русский язык (Russian) * ■ Svenska * ■ Türkçe * ■ 中文 (Chinese) * ■ 日本語 (Japanese) * ■ 한국어 (Korean) * ■ العربية (Arabic) * ■ Bahasa Indonesia * ■ ภาษาไทย (Thai) * ■ tiếng Việt (Vietnamese) * ■ čeština (Czech) * 	English (alternatively, the ordered language is preset in the device)
Display interval	A local display is provided.	Set time measured values are shown on display if display alternates between values.	1 to 10 s	5 s
Display damping	A local display is provided.	Set display reaction time to fluctuations in the measured value.	0.0 to 999.9 s	0.0 s
Header	A local display is provided.	Select header contents on local display.	<ul style="list-style-type: none"> ■ Device tag ■ Free text 	Device tag
Header text	In the Header parameter, the Free text option is selected.	Enter display header text.	Max. 12 characters such as letters, numbers or special characters (e.g. @, %, /)	-----
Separator	A local display is provided.	Select decimal separator for displaying numerical values.	<ul style="list-style-type: none"> ■ . (point) ■ , (comma) 	. (point)
Backlight	One of the following conditions is met: <ul style="list-style-type: none"> ■ Order code for "Display; operation", option F "4-line, illum.; touch control" ■ Order code for "Display; operation", option G "4-line, illum.; touch control +WLAN" 	Switch the local display backlight on and off.	<ul style="list-style-type: none"> ■ Disable ■ Enable 	Enable

* Visibility depends on order options or device settings

10.6.5 Performing electrode cleaning

The **Electrode cleaning circuit** submenu contains parameters that must be configured for the configuration of electrode cleaning.



The submenu is only available if the device was ordered with electrode cleaning.

Navigation

"Setup" menu → Advanced setup → Electrode cleaning circuit

▶ Electrode cleaning circuit	
Electrode cleaning circuit	→ 138
ECC duration	→ 138
ECC recovery time	→ 138
ECC cleaning cycle	→ 138
ECC Polarity	→ 138

Parameter overview with brief description

Parameter	Prerequisite	Description	Selection / User entry / User interface	Factory setting
Electrode cleaning circuit	For the following order code: "Application package", option EC "ECC electrode cleaning"	Enable the cyclic electrode cleaning circuit.	<ul style="list-style-type: none"> ▪ Off ▪ On 	Off
ECC duration	For the following order code: "Application package", option EC "ECC electrode cleaning"	Enter the duration of electrode cleaning in seconds.	0.01 to 30 s	2 s
ECC recovery time	For the following order code: "Application package", option EC "ECC electrode cleaning"	Define recovery time after electrode cleaning. During this time the current output values will be held at last valid value.	1 to 600 s	60 s
ECC cleaning cycle	For the following order code: "Application package", option EC "ECC electrode cleaning"	Enter the pause duration between electrode cleaning cycles.	0.5 to 168 h	0.5 h
ECC Polarity	For the following order code: "Application package", option EC "ECC electrode cleaning"	Select the polarity of the electrode cleaning circuit.	<ul style="list-style-type: none"> ▪ Positive ▪ Negative 	Depends on the electrode material: <ul style="list-style-type: none"> ▪ Platinum: Negative option ▪ Tantalum, Alloy C22, stainless steel: Positive option

10.6.6 WLAN configuration

The **WLAN Settings** submenu guides the user systematically through all the parameters that have to be set for the WLAN configuration.

Navigation



"Setup" menu → Advanced setup → WLAN settings

▶ WLAN settings	
WLAN	→ 139

WLAN mode	→ ⓘ 139
SSID name	→ ⓘ 139
Network security	→ ⓘ 139
Security identification	→ ⓘ 139
User name	→ ⓘ 139
WLAN password	→ ⓘ 139
WLAN IP address	→ ⓘ 139
WLAN passphrase	→ ⓘ 140
Assign SSID name	→ ⓘ 140
SSID name	→ ⓘ 140
Connection state	→ ⓘ 140
Received signal strength	→ ⓘ 140

Parameter overview with brief description

Parameter	Prerequisite	Description	Selection / User entry / User interface	Factory setting
WLAN	-	Switch WLAN on and off.	<ul style="list-style-type: none"> ■ Disable ■ Enable 	Enable
WLAN mode	-	Select WLAN mode.	<ul style="list-style-type: none"> ■ WLAN access point ■ WLAN Client 	WLAN access point
SSID name	The client is activated.	Enter the user-defined SSID name (max. 32 characters).	-	-
Network security	-	Select the security type of the WLAN network.	<ul style="list-style-type: none"> ■ Unsecured ■ WPA2-PSK ■ EAP-PEAP with MSCHAPv2 ■ EAP-PEAP MSCHAPv2 no server authentic. ■ EAP-TLS 	WPA2-PSK
Security identification	-	Select security settings and download these settings via menu Data management > Security > WLAN.	<ul style="list-style-type: none"> ■ Root certificate ■ Device certificate ■ Device private key 	-
User name	-	Enter user name.	-	-
WLAN password	-	Enter WLAN password.	-	-
WLAN IP address	-	Enter IP address of the device WLAN interface.	4 octet: 0 to 255 (in the particular octet)	192.168.1.212

Parameter	Prerequisite	Description	Selection / User entry / User interface	Factory setting
WLAN passphrase	The WPA2-PSK option is selected in the Security type parameter.	Enter the network key (8 to 32 characters).  The network key supplied with the device should be changed during commissioning for security reasons.	8 to 32-digit character string comprising numbers, letters and special characters	Serial number of the measuring device (e.g. L100A802000)
Assign SSID name	–	Select which name will be used for SSID: device tag or user-defined name.	<ul style="list-style-type: none"> ▪ Device tag ▪ User-defined 	User-defined
SSID name	<ul style="list-style-type: none"> ▪ The User-defined option is selected in the Assign SSID name parameter. ▪ The WLAN access point option is selected in the WLAN mode parameter. 	Enter the user-defined SSID name (max. 32 characters).  The user-defined SSID name may only be assigned once. If the SSID name is assigned more than once, the devices can interfere with one another.	Max. 32-digit character string comprising numbers, letters and special characters	EH_device designation_last 7 digits of the serial number (e.g. EH_Promag_500_A 802000)
Connection state	–	Displays the connection status.	<ul style="list-style-type: none"> ▪ Connected ▪ Not connected 	Not connected
Received signal strength	–	Shows the received signal strength.	<ul style="list-style-type: none"> ▪ Low ▪ Medium ▪ High 	High

10.6.7 Configuration management

After commissioning, you can save the current device configuration or restore the previous device configuration.

You can do so using the **Configuration management** parameter and the related options found in the **Configuration backup** submenu.

Navigation

"Setup" menu → Advanced setup → Configuration backup

► Configuration backup	
Operating time	→ ⓘ 141
Last backup	→ ⓘ 141
Configuration management	→ ⓘ 141
Backup state	→ ⓘ 141
Comparison result	→ ⓘ 141

Parameter overview with brief description

Parameter	Description	User interface / Selection	Factory setting
Operating time	Indicates how long the device has been in operation.	Days (d), hours (h), minutes (m) and seconds (s)	–
Last backup	Shows when the last data backup was saved to HistoROM backup.	Days (d), hours (h), minutes (m) and seconds (s)	–
Configuration management	Select action for managing the device data in the HistoROM backup.	<ul style="list-style-type: none"> ■ Cancel ■ Execute backup ■ Restore ■ Compare ■ Clear backup data 	Cancel
Backup state	Shows the current status of data saving or restoring.	<ul style="list-style-type: none"> ■ None ■ Backup in progress ■ Restoring in progress ■ Delete in progress ■ Compare in progress ■ Restoring failed ■ Backup failed 	None
Comparison result	Comparison of current device data with HistoROM backup.	<ul style="list-style-type: none"> ■ Settings identical ■ Settings not identical ■ No backup available ■ Backup settings corrupt ■ Check not done ■ Dataset incompatible 	Check not done

Function scope of the "Configuration management" parameter

Options	Description
Cancel	No action is executed and the user exits the parameter.
Execute backup	A backup copy of the current device configuration is saved from the HistoROM backup to the memory of the device. The backup copy includes the transmitter data of the device.
Restore	The last backup copy of the device configuration is restored from the device memory to the device's HistoROM backup. The backup copy includes the transmitter data of the device.
Compare	The device configuration saved in the device memory is compared with the current device configuration of the HistoROM backup.
Clear backup data	The backup copy of the device configuration is deleted from the memory of the device.



HistoROM backup

A HistoROM is a "non-volatile" device memory in the form of an EEPROM.



While this action is in progress, the configuration cannot be edited via the local display and a message on the processing status appears on the display.

10.6.8 Using parameters for device administration

The **Administration** submenu systematically guides the user through all the parameters that can be used for device administration purposes.

Navigation

"Setup" menu → Advanced setup → Administration

▶ Administration

▶ Define access code → 142

Define access code → 142

Confirm access code → 142

▶ Reset access code → 143

Operating time → 143

Reset access code → 143

Device reset → 143

Using the parameter to define the access code

Navigation

"Setup" menu → Advanced setup → Administration → Define access code

▶ Define access code

Define access code → 142

Confirm access code → 142

Parameter overview with brief description

Parameter	Description	User entry
Define access code	Restrict write-access to parameters to protect the configuration of the device against unintentional changes.	Max. 16-digit character string comprising numbers, letters and special characters
Confirm access code	Confirm the entered access code.	Max. 16-digit character string comprising numbers, letters and special characters

Using the parameter to reset the access code

Navigation

"Setup" menu → Advanced setup → Administration → Reset access code

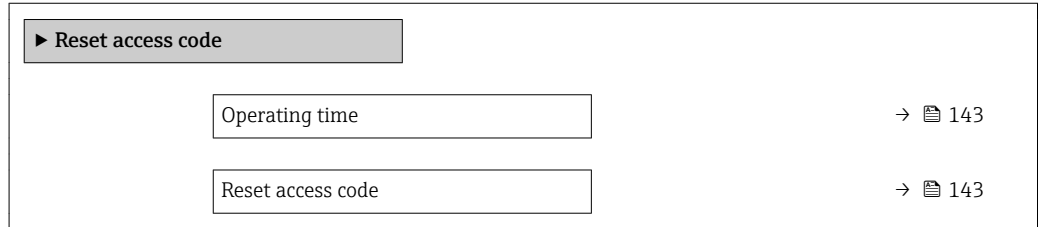

Parameter overview with brief description

Parameter	Description	User interface / User entry	Factory setting
Operating time	Indicates how long the device has been in operation.	Days (d), hours (h), minutes (m) and seconds (s)	-
Reset access code	Reset access code to factory settings.  For a reset code, contact your Endress+Hauser service organization. The reset code can only be entered via: <ul style="list-style-type: none"> ▪ Web browser ▪ DeviceCare, FieldCare (via service interface CDI-RJ45) ▪ Fieldbus 	Character string comprising numbers, letters and special characters	0x00

Using the parameter to reset the device

Navigation

"Setup" menu → Advanced setup → Administration

Parameter overview with brief description

Parameter	Description	Selection	Factory setting
Device reset	Reset the device configuration - either entirely or in part - to a defined state.	<ul style="list-style-type: none"> ▪ Cancel ▪ To delivery settings ▪ Restart device ▪ Restore S-DAT backup 	Cancel









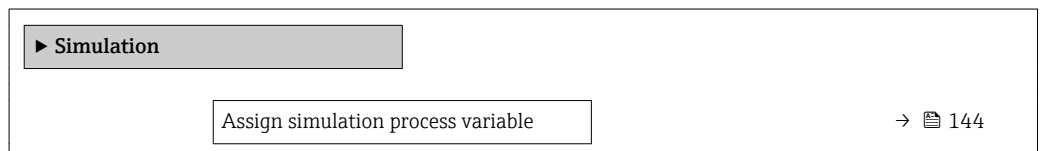









10.7 Simulation

The **Simulation** submenu enables you to simulate, without a real flow situation, various process variables in the process and the device alarm mode and to verify downstream signal chains (switching valves or closed-control loops).

Navigation



"Diagnostics" menu → Simulation



Process variable value	→  144
Status input simulation	→  145
Input signal level	→  145
Current input 1 to n simulation	→  145
Value current input 1 to n	→  145
Current output 1 to n simulation	→  145
Value current output 1 to n	→  145
Frequency output simulation 1 to n	→  145
Frequency value 1 to n	→  145
Pulse output simulation 1 to n	→  145
Pulse value 1 to n	→  145
Switch output simulation 1 to n	→  145
Switch status 1 to n	→  145
Relay output 1 to n simulation	→  145
Switch status 1 to n	→  145
Device alarm simulation	→  145
Diagnostic event category	→  146
Diagnostic event simulation	→  146

Parameter overview with brief description

Parameter	Prerequisite	Description	Selection / User entry / User interface	Factory setting
Assign simulation process variable	-	Select a process variable for the simulation process that is activated.	<ul style="list-style-type: none"> ▪ Off ▪ Volume flow ▪ Mass flow ▪ Corrected volume flow ▪ Flow velocity* ▪ Conductivity* 	Off
Process variable value	-	Enter the simulation value for the selected process variable.	Depends on the process variable selected	0



Parameter	Prerequisite	Description	Selection / User entry / User interface	Factory setting
Status input simulation	–	Switch simulation of the status input on and off.	<ul style="list-style-type: none"> ■ Off ■ On 	Off
Input signal level	In the Status input simulation parameter, the On option is selected.	Select the signal level for the simulation of the status input.	<ul style="list-style-type: none"> ■ High ■ Low 	High
Current input 1 to n simulation	–	Switch simulation of the current input on and off.	<ul style="list-style-type: none"> ■ Off ■ On 	Off
Value current input 1 to n	In the Current input 1 to n simulation parameter, the On option is selected.	Enter the current value for simulation.	0 to 22.5 mA	0 mA
Current output 1 to n simulation	–	Switch the simulation of the current output on and off.	<ul style="list-style-type: none"> ■ Off ■ On 	Off
Value current output 1 to n	In the Current output 1 to n simulation parameter, the On option is selected.	Enter the current value for simulation.	3.59 to 22.5 mA	3.59 mA
Frequency output simulation 1 to n	In the Operating mode parameter, the Frequency option is selected.	Switch the simulation of the frequency output on and off.	<ul style="list-style-type: none"> ■ Off ■ On 	Off
Frequency value 1 to n	In the Frequency output simulation 1 to n parameter, the On option is selected.	Enter the frequency value for the simulation.	0.0 to 12 500.0 Hz	0.0 Hz
Pulse output simulation 1 to n	In the Operating mode parameter, the Pulse option is selected.	Set and switch off the pulse output simulation.  For Fixed value option: Pulse width parameter (→  120) defines the pulse width of the pulses output.	<ul style="list-style-type: none"> ■ Off ■ Fixed value ■ Down-counting value 	Off
Pulse value 1 to n	In the Pulse output simulation 1 to n parameter, the Down-counting value option is selected.	Enter the number of pulses for simulation.	0 to 65 535	0
Switch output simulation 1 to n	In the Operating mode parameter, the Switch option is selected.	Switch the simulation of the switch output on and off.	<ul style="list-style-type: none"> ■ Off ■ On 	Off
Switch status 1 to n	–	Select the status of the status output for the simulation.	<ul style="list-style-type: none"> ■ Open ■ Closed 	Open
Relay output 1 to n simulation	–	Switch simulation of the relay output on and off.	<ul style="list-style-type: none"> ■ Off ■ On 	Off
Switch status 1 to n	The On option is selected in the Switch output simulation 1 to n parameter parameter.	Select status of the relay output for the simulation.	<ul style="list-style-type: none"> ■ Open ■ Closed 	Open
Pulse output simulation	–	Set and switch off the pulse output simulation.  For Fixed value option: Pulse width parameter defines the pulse width of the pulses output.	<ul style="list-style-type: none"> ■ Off ■ Fixed value ■ Down-counting value 	Off
Pulse value	In the Pulse output simulation parameter, the Down-counting value option is selected.	Set and switch off the pulse output simulation.	0 to 65 535	0
Device alarm simulation	–	Switch the device alarm on and off.	<ul style="list-style-type: none"> ■ Off ■ On 	Off

Parameter	Prerequisite	Description	Selection / User entry / User interface	Factory setting
Diagnostic event category	–	Select a diagnostic event category.	<ul style="list-style-type: none"> ▪ Sensor ▪ Electronics ▪ Configuration ▪ Process 	Process
Diagnostic event simulation	–	Select a diagnostic event to simulate this event.	<ul style="list-style-type: none"> ▪ Off ▪ Diagnostic event picklist (depends on the category selected) 	Off
Logging interval	–	Define the logging interval tlog for data logging. This value defines the time interval between the individual data points in the memory.	1.0 to 3 600.0 s	–

* Visibility depends on order options or device settings

10.8 Protecting settings from unauthorized access

The following write protection options exist in order to protect the configuration of the measuring device from unintentional modification:



- Protect access to parameters via access code →  146
- Protect access to local operation via key locking →  84
- Protect access to measuring device via write protection switch →  147

10.8.1 Write protection via access code



The effects of the user-specific access code are as follows:

- Via local operation, the parameters for the measuring device configuration are write-protected and their values can no longer be changed.
- Device access is protected via the Web browser, as are the parameters for the measuring device configuration.
- Device access is protected via FieldCare or DeviceCare (via CDI-RJ45 service interface), as are the parameters for the measuring device configuration.

Defining the access code via local display

1. Navigate to the **Define access code** parameter (→  142).
2. Define a max. 16-digit character string comprising numbers, letters and special characters as the access code.
3. Enter the access code again in the **Confirm access code** parameter (→  142) to confirm the code.
 - ↳ The -symbol appears in front of all write-protected parameters.

The device automatically locks the write-protected parameters again if a key is not pressed for 10 minutes in the navigation and editing view. The device locks the write-protected parameters automatically after 60 s if the user skips back to the operational display mode from the navigation and editing view.



-  ▪ If parameter write protection is activated via an access code, it can also only be deactivated via this access code →  83.
- The user role with which the user is currently logged on via the local display is indicated by the →  83 **Access status** parameter. Navigation path: Operation → Access status

Parameters which can always be modified via the local display

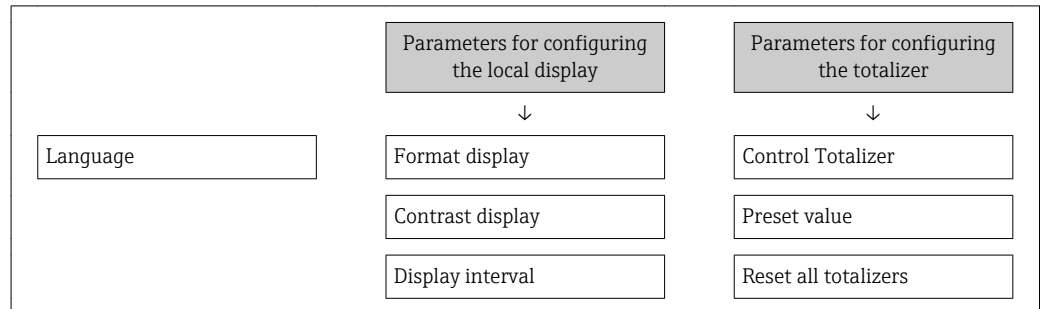

Certain parameters that do not affect the measurement are excepted from parameter write protection via the local display. Despite the user-specific access code, they can always be modified, even if the other parameters are locked.



Defining the access code via the Web browser

1. Navigate to the **Define access code** parameter (→  142).
2. Define a max. 16-digit numeric code as an access code.
3. Enter the access code again in the **Confirm access code** parameter (→  142) to confirm the code.
 - ↳ The Web browser switches to the login page.

 If no action is performed for 10 minutes, the Web browser automatically returns to the login page.



- 
 - If parameter write protection is activated via an access code, it can also only be deactivated via this access code →  83.
 - The user role with which the user is currently logged on via Web browser is indicated by the **Access status** parameter. Navigation path: Operation → Access status

Resetting the access code

If you misplace the user-specific access code, it is possible to reset the code to the factory setting. A reset code must be entered for this purpose. The user-specific access code can then be defined again afterwards.

Via Web browser, FieldCare, DeviceCare (via CDI-RJ45 service interface), fieldbus

 For a reset code, contact your Endress+Hauser service organization.

1. Navigate to the **Reset access code** parameter (→  143).
2. Enter the reset code.
 - ↳ The access code has been reset to the factory setting **0000**. It can be redefined →  146.

10.8.2 Write protection via write protection switch

Unlike parameter write protection via a user-specific access code, this allows write access to the entire operating menu - except for the **"Contrast display" parameter** - to be locked.

The parameter values are now read only and cannot be edited any more (exception **"Contrast display" parameter**):

- Via local display
- Via EtherNet/IP protocol

Proline 500 – digital

⚠ WARNING**Excessive tightening torque applied to the fixing screws!**

Risk of damaging the plastic transmitter.

- ▶ Tighten the fixing screws as per the tightening torque: 2 Nm (1.5 lbf ft)

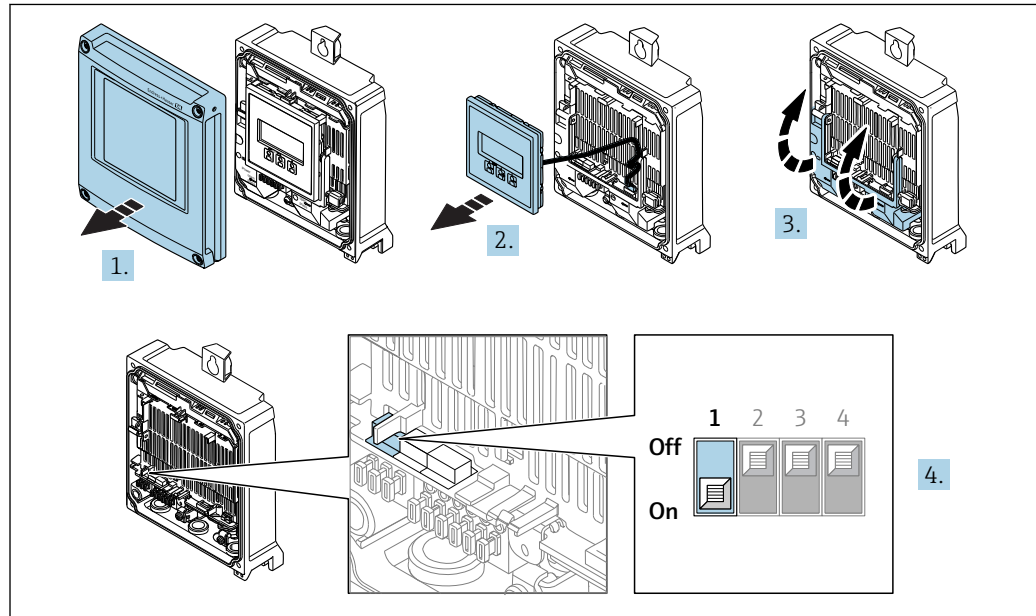

A0029673

1. Open the housing cover.
2. Remove the display module.
3. Fold open the terminal cover.
4. Setting the write protection (WP) switch on the main electronics module to the **ON** position enables hardware write protection.
 - ↳ In the **Locking status** parameter the **Hardware locked** option is displayed → 150. In addition, on the local display the -symbol appears in front of the parameters in the header of the operational display and in the navigation view.

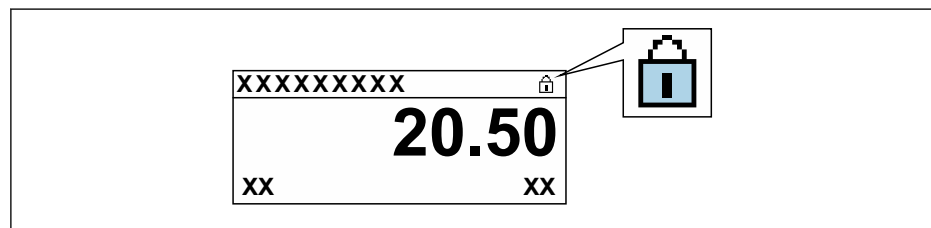

A0029425

5. Setting the write protection (WP) switch on the main electronics module to the **OFF** position (factory setting) disables hardware write protection.
 - ↳ No option is displayed in the **Locking status** parameter → 150. On the local display, the -symbol disappears from in front of the parameters in the header of the operational display and in the navigation view.

Proline 500

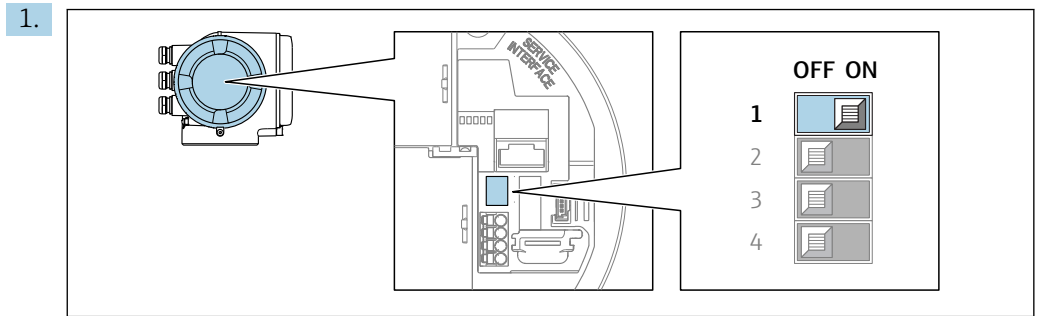

A0029630

Setting the write protection (WP) switch on the main electronics module to the **ON** position enables hardware write protection.

- ↳ In the **Locking status** parameter the **Hardware locked** option is displayed → 150. In addition, on the local display the -symbol appears in front of the parameters in the header of the operational display and in the navigation view.

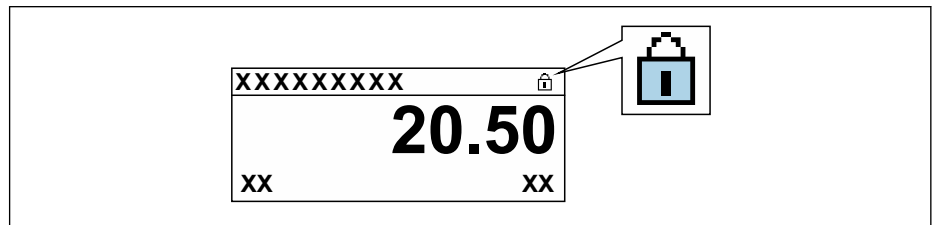

A0029425

2. Setting the write protection (WP) switch on the main electronics module to the **OFF** position (factory setting) disables hardware write protection.

- ↳ No option is displayed in the **Locking status** parameter → 150. On the local display, the -symbol disappears from in front of the parameters in the header of the operational display and in the navigation view.

11 Operation

11.1 Reading the device locking status

Device active write protection: **Locking status** parameter



Operation → Locking status

Function scope of the "Locking status" parameter

Options	Description
None	The access status displayed in the Access status parameter applies →  83. Only appears on local display.
Hardware locked	The DIP switch for hardware locking is activated on the PCB board. This locks write access to the parameters (e.g. via local display or operating tool) .
Temporarily locked	Write access to the parameters is temporarily locked on account of internal processes running in the device (e.g. data upload/download, reset etc.). Once the internal processing has been completed, the parameters can be changed once again.



11.2 Adjusting the operating language

 Detailed information:

- To configure the operating language →  109
- For information on the operating languages supported by the measuring device →  215

11.3 Configuring the display

Detailed information:





- On the basic settings for the local display →  126
- On the advanced settings for the local display →  134

11.4 Reading measured values

With the **Measured values** submenu, it is possible to read all the measured values.

Navigation

"Diagnostics" menu → Measured values

▶ Measured values	
▶ Process variables	→  151
▶ Input values	→  152
▶ Output values	→  154
▶ Totalizer	→  152

11.4.1 "Process variables" submenu

The **Process variables** submenu contains all the parameters needed to display the current measured values for each process variable.

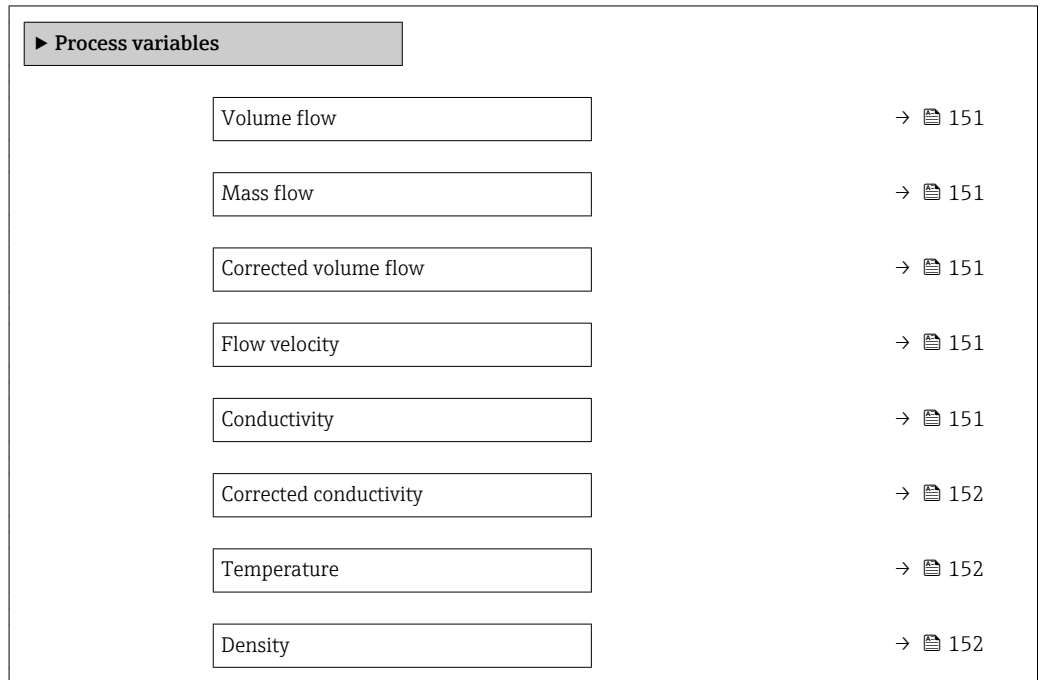

Navigation

"Diagnostics" menu → Measured values → Process variables



Parameter overview with brief description

Parameter	Prerequisite	Description	User interface
Volume flow	–	Displays the volume flow currently measured. <i>Dependency</i> The unit is taken from the Volume flow unit parameter (→ 112).	Signed floating-point number
Mass flow	–	Displays the mass flow currently calculated. <i>Dependency</i> The unit is taken from the Mass flow unit parameter (→ 112).	Signed floating-point number
Corrected volume flow	–	Displays the corrected volume flow currently calculated. <i>Dependency</i> The unit is taken from the Corrected volume flow unit parameter (→ 113).	Signed floating-point number
Flow velocity	–	Displays the flow velocity currently calculated.	Signed floating-point number
Conductivity	–	Displays the conductivity currently measured. <i>Dependency</i> The unit is taken from the Conductivity unit parameter (→ 112).	Signed floating-point number

Parameter	Prerequisite	Description	User interface
Corrected conductivity	One of the following conditions is met: <ul style="list-style-type: none"> Order code for "Sensor option", option CI "Medium temperature measurement" or The temperature is read into the flowmeter from an external device. 	Displays the conductivity currently corrected. <i>Dependency</i> The unit is taken from the Conductivity unit parameter (→  112).	Positive floating-point number
Temperature	One of the following conditions is met: <ul style="list-style-type: none"> Order code for "Sensor option", option CI "Medium temperature measurement" or The temperature is read into the flowmeter from an external device. 	Displays the temperature currently calculated. <i>Dependency</i> The unit is taken from the Temperature unit parameter (→  112).	Positive floating-point number
Density	–	Displays the current fixed density or density read in from an external device. <i>Dependency</i> The unit is taken from the Density unit parameter.	Signed floating-point number

11.4.2 "Totalizer" submenu



The **Totalizer** submenu contains all the parameters needed to display the current measured values for every totalizer.

Navigation

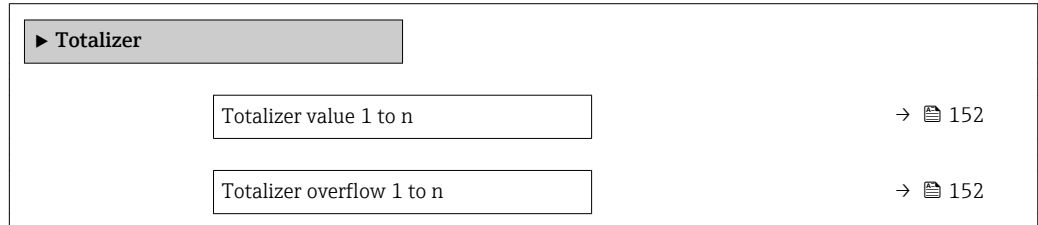
"Diagnostics" menu → Measured values → Totalizer



Parameter overview with brief description

Parameter	Prerequisite	Description	User interface
Totalizer value 1 to n	A process variable is selected in the Assign process variable parameter (→  133) of the Totalizer 1 to n submenu.	Displays the current totalizer counter value.	Signed floating-point number
Totalizer overflow 1 to n	A process variable is selected in the Assign process variable parameter (→  133) of the Totalizer 1 to n submenu.	Displays the current totalizer overflow.	Integer with sign

11.4.3 "Input values" submenu

The **Input values** submenu guides you systematically to the individual input values.

Navigation

"Diagnostics" menu → Measured values → Input values

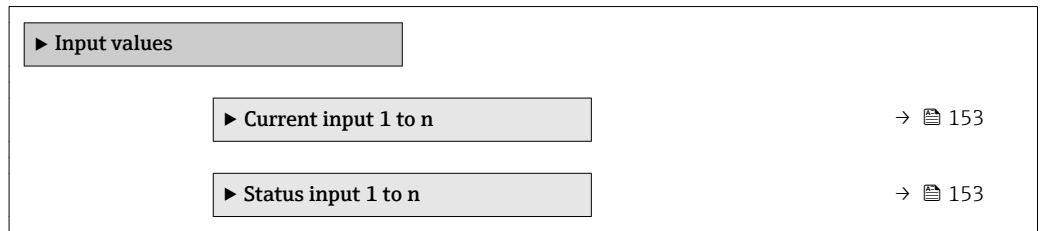

Input values of current input

The **Current input 1 to n** submenu contains all the parameters needed to display the current measured values for every current input.

Navigation

"Diagnostics" menu → Measured values → Input values → Current input 1 to n

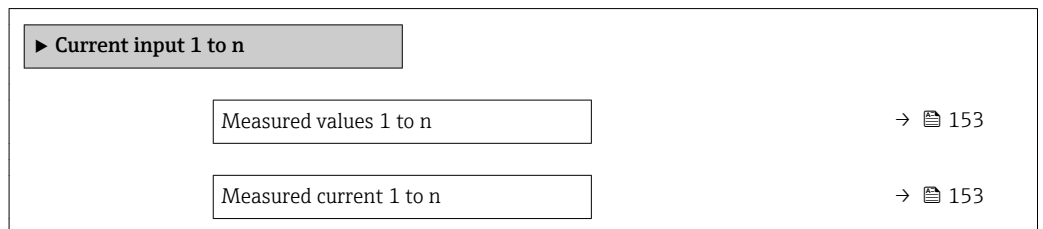

Parameter overview with brief description

Parameter	Description	User interface
Measured values 1 to n	Displays the current input value.	Signed floating-point number
Measured current 1 to n	Displays the current value of the current input.	0 to 22.5 mA

Input values of status input

The **Status input 1 to n** submenu contains all the parameters needed to display the current measured values for every status input.

Navigation

"Diagnostics" menu → Measured values → Input values → Status input 1 to n

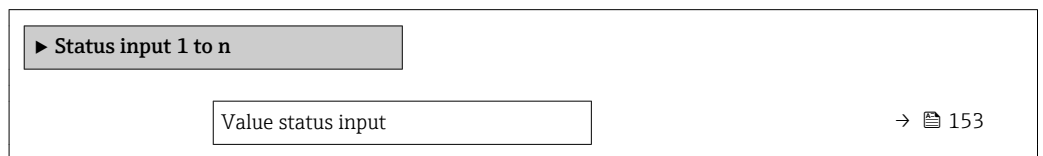

Parameter overview with brief description

Parameter	Description	User interface
Value status input	Shows the current input signal level.	<ul style="list-style-type: none"> ■ High ■ Low

11.4.4 Output values

The **Output values** submenu contains all the parameters needed to display the current measured values for every output.

Navigation

"Diagnostics" menu → Measured values → Output values

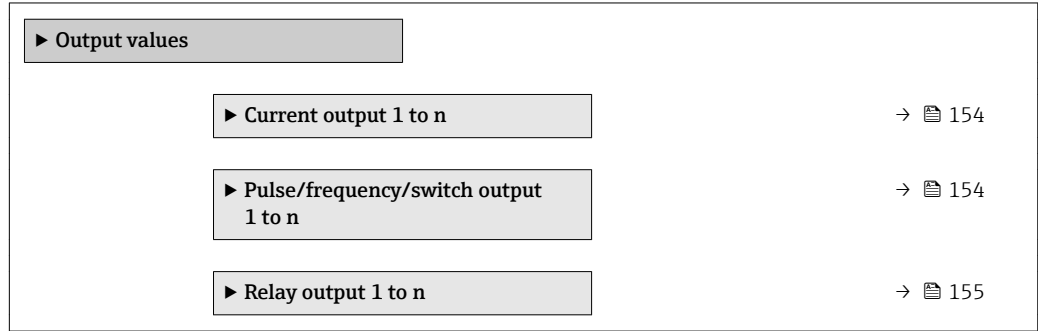

Output values of current output

The **Value current output** submenu contains all the parameters needed to display the current measured values for every current output.

Navigation

"Diagnostics" menu → Measured values → Output values → Value current output 1 to n

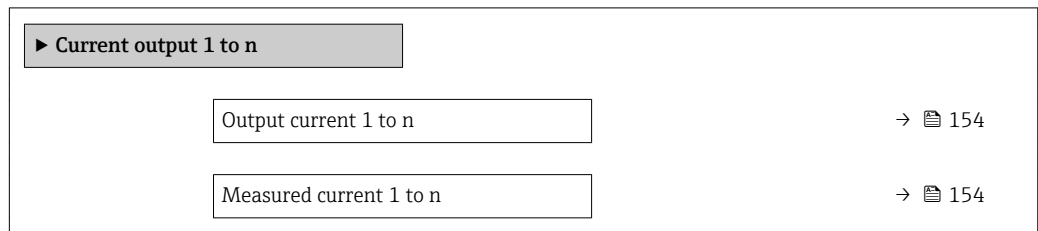

Parameter overview with brief description

Parameter	Description	User interface
Output current 1	Displays the current value currently calculated for the current output.	3.59 to 22.5 mA
Measured current	Displays the current value currently measured for the current output.	0 to 30 mA

Output values for pulse/frequency/switch output

The **Pulse/frequency/switch output 1 to n** submenu contains all the parameters needed to display the current measured values for every pulse/frequency/switch output.

Navigation

"Diagnostics" menu → Measured values → Output values → Pulse/frequency/switch output 1 to n

▶ Pulse/frequency/switch output 1 to n

Output frequency 1 to n	→ 155
Pulse output 1 to n	→ 155
Switch status 1 to n	→ 155

Parameter overview with brief description

Parameter	Prerequisite	Description	User interface
Output frequency 1 to n	In the Operating mode parameter, the Frequency option is selected.	Displays the value currently measured for the frequency output.	0.0 to 12 500.0 Hz
Pulse output 1 to n	In the Operating mode parameter, the Pulse option is selected.	Displays the pulse frequency currently output.	Positive floating-point number
Switch status 1 to n	The Switch option is selected in the Operating mode parameter.	Displays the current switch output status.	<ul style="list-style-type: none"> ■ Open ■ Closed

Output values for relay output

The **Relay output 1 to n** submenu contains all the parameters needed to display the current measured values for every relay output.

Navigation

"Diagnostics" menu → Measured values → Output values → Relay output 1 to n

▶ Relay output 1 to n

Switch status	→ 155
Switch cycles	→ 155
Max. switch cycles number	→ 155

Parameter overview with brief description

Parameter	Description	User interface
Switch status	Shows the current relay switch status.	<ul style="list-style-type: none"> ■ Open ■ Closed
Switch cycles	Shows number of all performed switch cycles.	Positive integer
Max. switch cycles number	Shows the maximal number of guaranteed switch cycles.	Positive integer

11.5 Adapting the measuring device to the process conditions



The following are available for this purpose:

- Basic settings using the **Setup** menu (→  110)
- Advanced settings using the **Advanced setup** submenu (→  131)





11.6 Performing a totalizer reset

Navigation

"Operation" menu → Totalizer handling

▶ Totalizer handling	
Control Totalizer 1 to n	→  156
Preset value 1 to n	→  156
Reset all totalizers	→  156

Parameter overview with brief description

Parameter	Prerequisite	Description	Selection / User entry	Factory setting
Control Totalizer 1 to n	One of the following options is selected in the Assign process variable parameter (→  133) of the Totalizer 1 to n submenu: Volume flow	Control totalizer value.	<ul style="list-style-type: none"> ▪ Totalize ▪ Reset + hold ▪ Preset + hold ▪ Reset + totalize ▪ Preset + totalize ▪ Hold 	Totalize
Preset value 1 to n	One of the following options is selected in the Assign process variable parameter (→  133) of the Totalizer 1 to n submenu: Volume flow	Specify start value for totalizer. <i>Dependency</i>  The unit of the selected process variable is specified for the totalizer in the Unit totalizer parameter (→  133).	Signed floating-point number	0 l
Reset all totalizers	–	Reset all totalizers to 0 and start.	<ul style="list-style-type: none"> ▪ Cancel ▪ Reset + totalize 	Cancel

11.6.1 Function scope of the "Control Totalizer" parameter



Options	Description
Totalize	The totalizer is started or continues running.
Reset + hold	The totaling process is stopped and the totalizer is reset to 0.
Preset + hold	The totaling process is stopped and the totalizer is set to its defined start value from the Preset value parameter.
Reset + totalize	The totalizer is reset to 0 and the totaling process is restarted.
Preset + totalize	The totalizer is set to the defined start value from the Preset value parameter and the totaling process is restarted.
Hold	Totalizing is stopped.

11.6.2 Function scope of the "Reset all totalizers" parameter

Options	Description
Cancel	No action is executed and the user exits the parameter.
Reset + totalize	Resets all totalizers to 0 and restarts the totaling process. This deletes all the flow values previously totalized.

11.7 Showing data logging

The **Extended HistoROM** application package must be enabled in the device (order option) for the **Data logging** submenu to appear. This contains all the parameters for the measured value history.

-  Data logging is also available via:
 - Plant Asset Management Tool FieldCare →  96.
 - Web browser

Function range

- A total of 1000 measured values can be stored
- 4 logging channels
- Adjustable logging interval for data logging
- Display of the measured value trend for each logging channel in the form of a chart

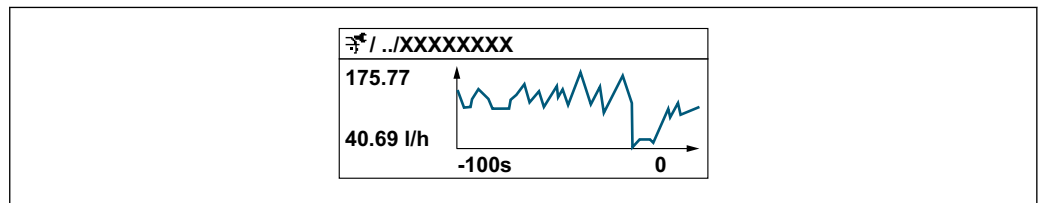

A0034352







- x-axis: depending on the number of channels selected displays 250 to 1000 measured values of a process variable.
- y-axis: displays the approximate measured value span and constantly adapts this to the ongoing measurement.



-  If the length of the logging interval or the assignment of the process variables to the channels is changed, the content of the data logging is deleted.

Navigation





"Diagnostics" menu → Data logging



▶ Data logging

Assign channel 1	→  158
Assign channel 2	→  158
Assign channel 3	→  158
Assign channel 4	→  159
Logging interval	→  159
Clear logging data	→  159

Data logging	→  159
Logging delay	→  159
Data logging control	→  159
Data logging status	→  159
Entire logging duration	→  159
▶ Display channel 1	
▶ Display channel 2	
▶ Display channel 3	
▶ Display channel 4	

Parameter overview with brief description

Parameter	Prerequisite	Description	Selection / User entry / User interface	Factory setting
Assign channel 1	The Extended HistoROM application package is available.  The software options currently enabled are displayed in the Software option overview parameter.	Assign a process variable to logging channel.	<ul style="list-style-type: none"> ▪ Off ▪ Volume flow ▪ Mass flow ▪ Corrected volume flow ▪ Flow velocity ▪ Conductivity * ▪ Corrected conductivity * ▪ Current output 1 ▪ Current output 2 * ▪ Current output 3 * ▪ Current output 4 * ▪ Temperature * ▪ Electronic temperature 	Off
Assign channel 2	The Extended HistoROM application package is available.  The software options currently enabled are displayed in the Software option overview parameter.	Assign process variable to logging channel.	Picklist, see Assign channel 1 parameter (→  158)	Off
Assign channel 3	The Extended HistoROM application package is available.  The software options currently enabled are displayed in the Software option overview parameter.	Assign process variable to logging channel.	Picklist, see Assign channel 1 parameter (→  158)	Off

Parameter	Prerequisite	Description	Selection / User entry / User interface	Factory setting
Assign channel 4	The Extended HistoROM application package is available.  The software options currently enabled are displayed in the Software option overview parameter.	Assign process variable to logging channel.	Picklist, see Assign channel 1 parameter (→  158)	Off
Logging interval	The Extended HistoROM application package is available.	Define the logging interval for data logging. This value defines the time interval between the individual data points in the memory.	0.1 to 3 600.0 s	1.0 s
Clear logging data	The Extended HistoROM application package is available.	Clear the entire logging data.	<ul style="list-style-type: none"> ■ Cancel ■ Clear data 	Cancel
Data logging	–	Select the data logging method.	<ul style="list-style-type: none"> ■ Overwriting ■ Not overwriting 	Overwriting
Logging delay	In the Data logging parameter, the Not overwriting option is selected.	Enter the time delay for measured value logging.	0 to 999 h	0 h
Data logging control	In the Data logging parameter, the Not overwriting option is selected.	Start and stop measured value logging.	<ul style="list-style-type: none"> ■ None ■ Delete + start ■ Stop 	None
Data logging status	In the Data logging parameter, the Not overwriting option is selected.	Displays the measured value logging status.	<ul style="list-style-type: none"> ■ Done ■ Delay active ■ Active ■ Stopped 	Done
Entire logging duration	In the Data logging parameter, the Not overwriting option is selected.	Displays the total logging duration.	Positive floating-point number	0 s

* Visibility depends on order options or device settings

12 Diagnostics and troubleshooting

12.1 General troubleshooting







For local display

Error	Possible causes	Solution
Local display dark and no output signals	Supply voltage does not match the value indicated on the nameplate.	Apply the correct supply voltage .
Local display dark and no output signals	The polarity of the supply voltage is wrong.	Correct the polarity.
Local display dark and no output signals	No contact between connecting cables and terminals.	Check the connection of the cables and correct if necessary.
Local display dark and no output signals	Terminals are not plugged into the I/O electronics module correctly. Terminals are not plugged into the main electronics module correctly.	Check terminals.
Local display dark and no output signals	I/O electronics module is defective. Main electronics module is defective.	Order spare part → 191.
Local display dark and no output signals	The connector between the main electronics module and display module is not plugged in correctly.	Check the connection and correct if necessary.
Local display dark and no output signals	The connecting cable is not plugged in correctly.	1. Check the connection of the electrode cable and correct if necessary. 2. Check the connection of the coil current cable and correct if necessary.
Local display is dark, but signal output is within the valid range	Display is set too bright or too dark.	<ul style="list-style-type: none"> ▪ Set the display brighter by simultaneously pressing + . ▪ Set the display darker by simultaneously pressing + .
Local display is dark, but signal output is within the valid range	The cable of the display module is not plugged in correctly.	Insert the plug correctly into the main electronics module and display module.
Local display is dark, but signal output is within the valid range	Display module is defective.	Order spare part → 191.
Backlighting of local display is red	Diagnostic event with "Alarm" diagnostic behavior has occurred.	Take remedial measures
Text on local display appears in a foreign language and cannot be understood.	Incorrect operating language is configured.	1. Press + for 2 s ("home position"). 2. Press .3. Set the desired language in the Display language parameter (→ 137).
Message on local display: "Communication Error" "Check Electronics"	Communication between the display module and the electronics is interrupted.	<ul style="list-style-type: none"> ▪ Check the cable and the connector between the main electronics module and display module. ▪ Order spare part → 191.

For output signals

Error	Possible causes	Solution
Signal output outside the valid range	Main electronics module is defective.	Order spare part →  191.
Device shows correct value on local display, but signal output is incorrect, though in the valid range.	Configuration error	Check and correct the parameter configuration.
Device measures incorrectly.	Configuration error or device is operated outside the application.	1. Check and correct parameter configuration. 2. Observe limit values specified in the "Technical Data".

For access

Error	Possible causes	Solution
No write access to parameters	Hardware write protection enabled	Set the write protection switch on main electronics module to the OFF position →  147.
No write access to parameters	Current user role has limited access authorization	1. Check user role →  83. 2. Enter correct customer-specific access code →  83.
No connection via EtherNet/IP	Device plug connected incorrectly	Check the pin assignment of the connector .
Not connecting to Web server	Web server disabled	Using the "FieldCare" or "DeviceCare" operating tool, check whether the Web server of the measuring device is enabled, and enable it if necessary →  91.
	Incorrect setting for the Ethernet interface of the computer	1. Check the properties of the Internet protocol (TCP/IP) →  87. 2. Check the network settings with the IT manager.
Not connecting to Web server	<ul style="list-style-type: none"> ▪ Incorrect IP address ▪ IP address is not known 	1. If addressing via hardware: open the transmitter and check the IP address configured (last octet). 2. Check the IP address of the measuring device with the network manager. 3. If the IP address is not known, set DIP switch no. 10 to ON, restart the device and enter the factory IP address 192.168.1.212.  EtherNet/IP communication is interrupted by enabling the DIP switch.
	Web browser setting "Use a Proxy Server for Your LAN" is enabled	Disable the use of the proxy server in the Web browser settings of the computer. Using the example of MS Internet Explorer: 1. Under <i>Control Panel</i> open <i>Internet options</i> . 2. Select the <i>Connections</i> tab and then double-click <i>LAN settings</i> . 3. In the <i>LAN settings</i> disable the use of the proxy server and select <i>OK</i> to confirm.

Error	Possible causes	Solution
	Apart from the active network connection to the measuring device, other network connections are also being used.	<ul style="list-style-type: none"> ▪ Make sure that no other network connections are established by the computer (also no WLAN) and close other programs with network access to the computer. ▪ If using a docking station for notebooks, make sure that a network connection to another network is not active.
Not connecting to Web server	Incorrect WLAN access data	<ul style="list-style-type: none"> ▪ Check WLAN network status. ▪ Log on to the device again using WLAN access data. ▪ Verify that WLAN is enabled on the measuring device and operating device .
	WLAN communication disabled	–
Not connecting to Web server, FieldCare or DeviceCare	No WLAN network available	<ul style="list-style-type: none"> ▪ Check if WLAN reception is present: LED on display module is lit blue ▪ Check if WLAN connection is enabled: LED on display module flashes blue ▪ Switch on instrument function.
Network connection not present or unstable	WLAN network is weak.	<ul style="list-style-type: none"> ▪ Operating device is outside of reception range: Check network status on operating device. ▪ To improve network performance, use an external WLAN antenna.
	Parallel WLAN and Ethernet communication	<ul style="list-style-type: none"> ▪ Check network settings. ▪ Temporarily enable only the WLAN as an interface.
Web browser frozen and operation no longer possible	Data transfer active	Wait until data transfer or current action is finished.
	Connection lost	<ol style="list-style-type: none"> 1. Check cable connection and power supply. 2. Refresh the Web browser and restart if necessary.
Content of Web browser incomplete or difficult to read	Not using optimum version of Web server.	<ol style="list-style-type: none"> 1. Use the correct Web browser version . 2. Clear the Web browser cache and restart the Web browser.
	Unsuitable view settings.	Change the font size/display ratio of the Web browser.
No or incomplete display of contents in the Web browser	<ul style="list-style-type: none"> ▪ JavaScript not enabled ▪ JavaScript cannot be enabled 	<ol style="list-style-type: none"> 1. Enable JavaScript. 2. Enter http://XXX.XXX.X.XXX/basic.html as the IP address.
Operation with FieldCare or DeviceCare via CDI-RJ45 service interface (port 8000)	Firewall of computer or network is preventing communication	Depending on the settings of the firewall used on the computer or in the network, the firewall must be adapted or disabled to allow FieldCare/DeviceCare access.
Flashing of firmware with FieldCare or DeviceCare via CDI-RJ45 service interface (via port 8000 or TFTP ports)	Firewall of computer or network is preventing communication	Depending on the settings of the firewall used on the computer or in the network, the firewall must be adapted or disabled to allow FieldCare/DeviceCare access.

12.2 Diagnostic information via light emitting diodes

12.2.1 Transmitter

Proline 500 – digital

Different LEDs in the transmitter provide information on the device status.

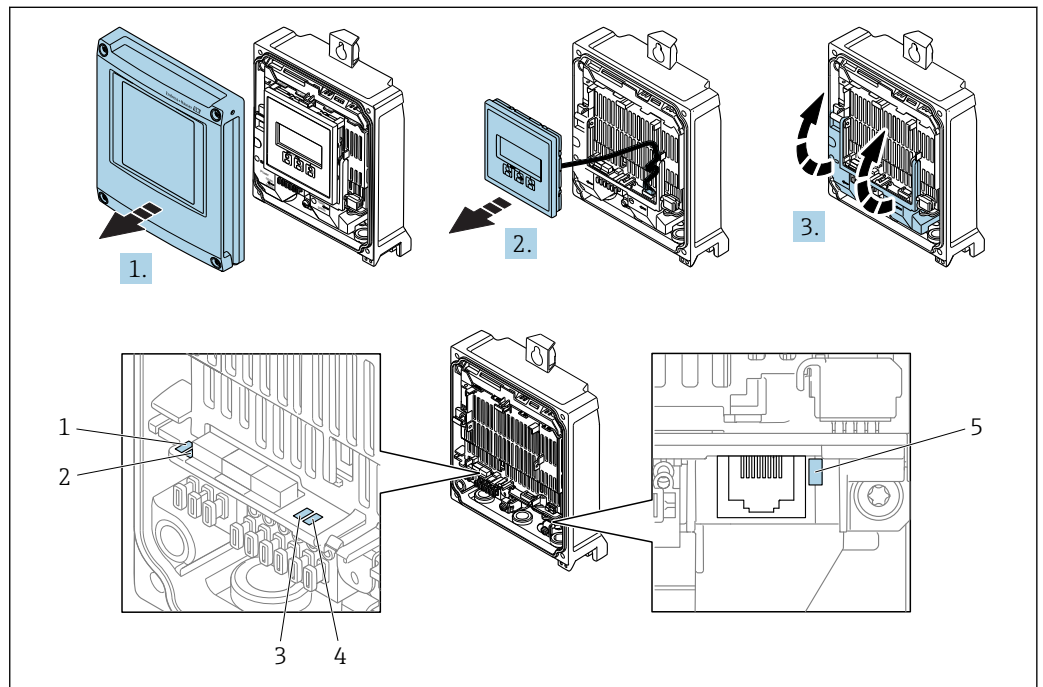

A0029689

- 1 Supply voltage
- 2 Device status
- 3 network status
- 4 Port 1 active: EtherNet/IP
- 5 Port 2 active: EtherNet/IP and service interface (CDI)

1. Open the housing cover.
2. Remove the display module.
3. Fold open the terminal cover.

LED	Color	Meaning
1 Supply voltage	Off	Supply voltage is off or too low.
	Green	Supply voltage is ok.
2 Device status/module status	Off	Firmware error
	Green	Device status is ok.
	Flashing green	Device is not configured.
	Flashing red	A diagnostic event with "Warning" diagnostic behavior has occurred.
	Red	A diagnostic event with "Alarm" diagnostic behavior has occurred.
3 Network status	Off	The device does not have an EtherNet/IP address.
	Green	EtherNet/IP connection is active.
	Flashing green	The device has an Ethernet/IP address but no EtherNet/IP connection is active.

LED	Color	Meaning
	Red	The EtherNet/IP address of the device has been assigned twice.
	Flashing red	EtherNet/IP connection is in the "time out" mode.
	Flashing red/green	The device restarts/self-test.
4 Port 1 active: Ethernet/IP	Off	Not connected or no connection established.
	White	Connected and connection established.
	Flashing white	Communication not active.
5 Port 2 active: Ethernet/IP and service interface (CDI)	Off	Not connected or no connection established.
	Yellow	Connected and connection established.
	Flashing yellow	Communication not active.

Proline 500

Different LEDs in the transmitter provide information on the device status.

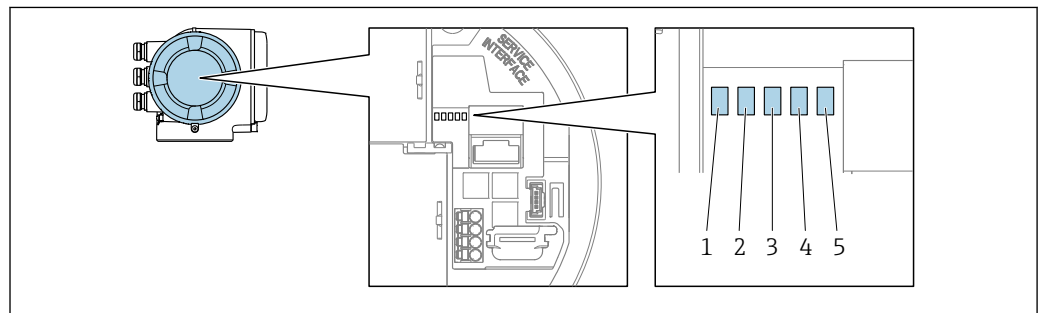

A0029629

- 1 Supply voltage
- 2 Device status
- 3 network status
- 4 Port 1 active: EtherNet/IP
- 5 Port 2 active: EtherNet/IP and service interface (CDI)

LED	Color	Meaning
1 Supply voltage	Off	Supply voltage is off or too low.
	Green	Supply voltage is ok.
2 Device status/module status	Off	Firmware error.
	Green	Device status is ok.
	Flashing green	Device is not configured.
	Flashing red	A diagnostic event with "Warning" diagnostic behavior has occurred.
	Red	A diagnostic event with "Alarm" diagnostic behavior has occurred.
	Flashing red/green	The device restarts/self-test.
3 Network status	Off	The device does not have an EtherNet/IP address.
	Green	EtherNet/IP connection is active.
	Flashing green	The device has an Ethernet/IP address but no EtherNet/IP connection is active.
	Red	The EtherNet/IP address of the device has been assigned twice.
	Flashing red	EtherNet/IP connection is in the "time out" mode.
	Flashing red/green	The device restarts/self-test.

LED	Color	Meaning
4 Port 1 active: Ethernet/IP	Off	Not connected or no connection established.
	White	Connected and connection established.
	Flashing white	Communication not active.
5 Port 2 active: Ethernet/IP and service interface (CDI)	Off	Not connected or no connection established.
	Yellow	Connected and connection established.
	Flashing yellow	Communication not active.

12.2.2 Sensor connection housing

Proline 500 – digital

Various light emitting diodes (LED) on the ISEM electronics (Intelligent Sensor Electronic Module) in the sensor connection housing provide information on the device status.

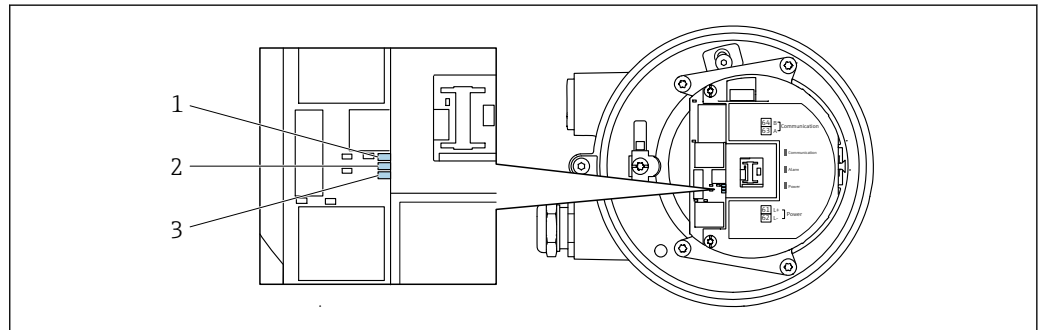

A0029699

- 1 Communication
- 2 Device status
- 3 Supply voltage

LED	Color	Meaning
1 Communication	White	Communication active
2 Device status	Red	Error
	Flashing red	Warning
3 Supply voltage	Green	Supply voltage is ok
	Off	Supply voltage is off or too low

12.3 Diagnostic information on local display

12.3.1 Diagnostic message

Faults detected by the self-monitoring system of the measuring device are displayed as a diagnostic message in alternation with the operational display.

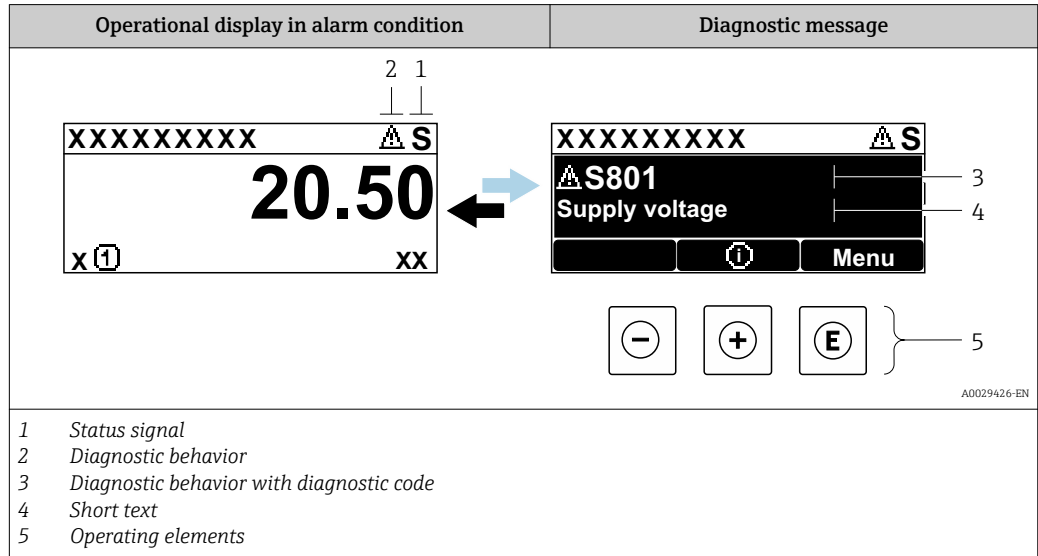

If two or more diagnostic events are pending simultaneously, only the message of the diagnostic event with the highest priority is shown.

- i** Other diagnostic events that have occurred can be displayed in the **Diagnostics** menu:
 - Via parameter
 - Via submenus → 185



Status signals

The status signals provide information on the state and reliability of the device by categorizing the cause of the diagnostic information (diagnostic event).

- i** The status signals are categorized according to VDI/VDE 2650 and NAMUR Recommendation NE 107: F = Failure, C = Function Check, S = Out of Specification, M = Maintenance Required

Symbol	Meaning
F	Failure A device error has occurred. The measured value is no longer valid.
C	Function check The device is in service mode (e.g. during a simulation).
S	Out of specification The device is operated: Outside its technical specification limits (e.g. outside the process temperature range)
M	Maintenance required Maintenance is required. The measured value remains valid.

Diagnostic behavior



Symbol	Meaning
	Alarm <ul style="list-style-type: none"> Measurement is interrupted. Signal outputs and totalizers assume the defined alarm condition. A diagnostic message is generated.
	Warning Measurement is resumed. The signal outputs and totalizers are not affected. A diagnostic message is generated.

Diagnostic information

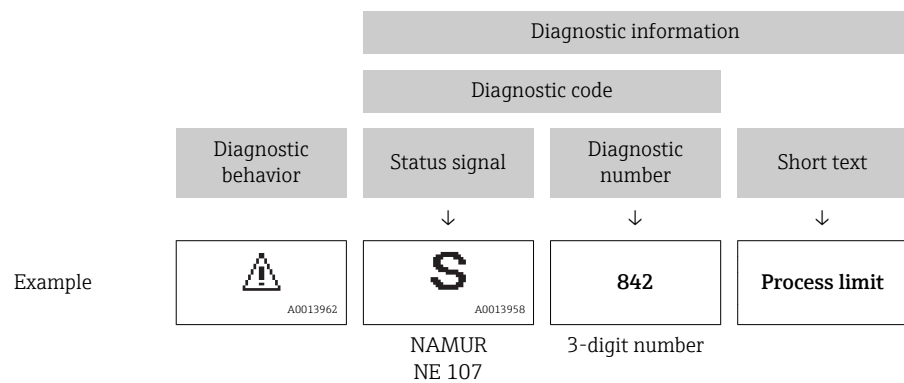
The fault can be identified using the diagnostic information. The short text helps you by providing information about the fault. In addition, the corresponding symbol for the diagnostic behavior is displayed in front of the diagnostic information on the local display.



Operating elements

Key	Meaning
	Plus key <i>In a menu, submenu</i> Opens the message about remedy information.
	Enter key <i>In a menu, submenu</i> Opens the operating menu.

12.3.2 Calling up remedial measures

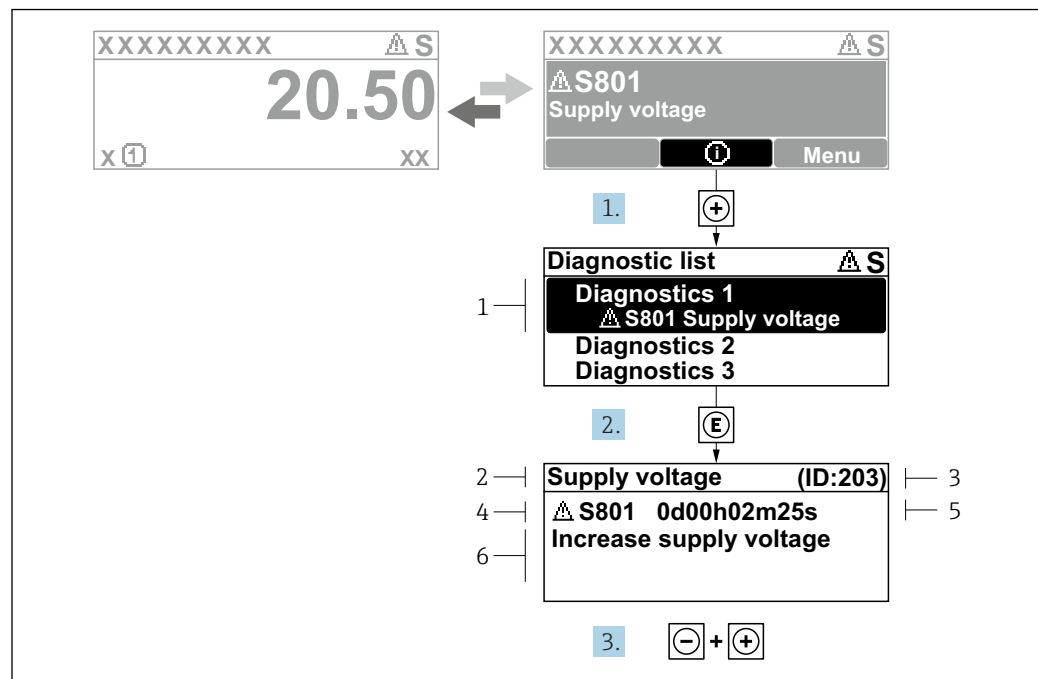

41 Message about remedial measures

- 1 Diagnostic information
- 2 Short text
- 3 Service ID
- 4 Diagnostic behavior with diagnostic code
- 5 Operation time of occurrence
- 6 Remedial measures

1. The user is in the diagnostic message.
Press \oplus (ⓘ symbol).
↳ The **Diagnostic list** submenu opens.
2. Select the desired diagnostic event with \oplus or \ominus and press \boxplus .
↳ The message about the remedial measures opens.
3. Press $\ominus + \oplus$ simultaneously.
↳ The message about the remedial measures closes.

The user is in the **Diagnostics** menu at an entry for a diagnostics event, e.g. in the **Diagnostic list** submenu or **Previous diagnostics** parameter.

1. Press \boxplus .
↳ The message for the remedial measures for the selected diagnostic event opens.
2. Press $\ominus + \oplus$ simultaneously.
↳ The message for the remedial measures closes.

12.4 Diagnostic information in the Web browser

12.4.1 Diagnostic options

Any faults detected by the measuring device are displayed in the Web browser on the home page once the user has logged on.

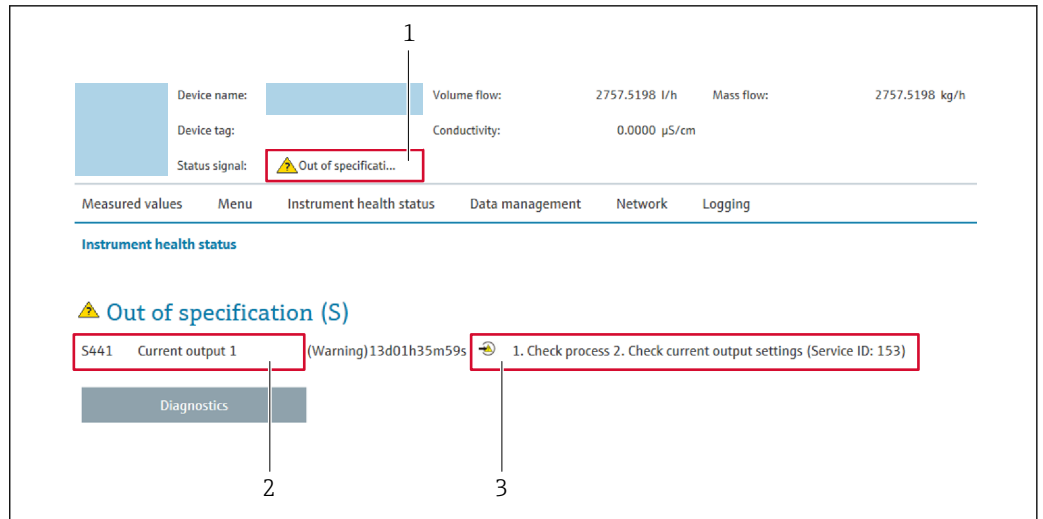

- 1 Status area with status signal
- 2 Diagnostic information → 167
- 3 Remedy information with Service ID

i In addition, diagnostic events which have occurred can be shown in the **Diagnostics** menu:

- Via parameter
- Via submenu → 185

Status signals

The status signals provide information on the state and reliability of the device by categorizing the cause of the diagnostic information (diagnostic event).

Symbol	Meaning
	Failure A device error has occurred. The measured value is no longer valid.
	Function check The device is in service mode (e.g. during a simulation).
	Out of specification The device is operated: Outside its technical specification limits (e.g. outside the process temperature range)
	Maintenance required Maintenance is required. The measured value is still valid.

i The status signals are categorized in accordance with VDI/VDE 2650 and NAMUR Recommendation NE 107.

12.4.2 Calling up remedy information

Remedy information is provided for every diagnostic event to ensure that problems can be rectified quickly. These measures are displayed in red along with the diagnostic event and the related diagnostic information.

12.5 Diagnostic information in DeviceCare or FieldCare

12.5.1 Diagnostic options

Any faults detected by the measuring device are displayed on the home page of the operating tool once the connection has been established.

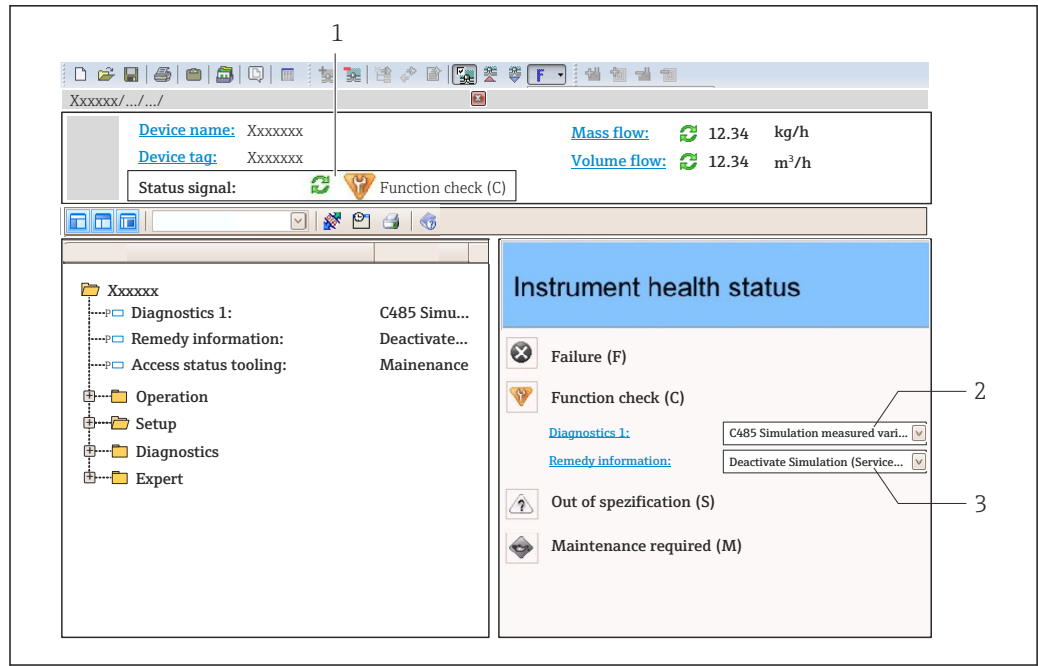

- 1 Status area with status signal → 166
- 2 Diagnostic information → 167
- 3 Remedy information with Service ID

i In addition, diagnostic events which have occurred can be shown in the **Diagnostics** menu:

- Via parameter
- Via submenu → 185

Diagnostic information

The fault can be identified using the diagnostic information. The short text helps you by providing information about the fault. In addition, the corresponding symbol for the diagnostic behavior is displayed in front of the diagnostic information on the local display.

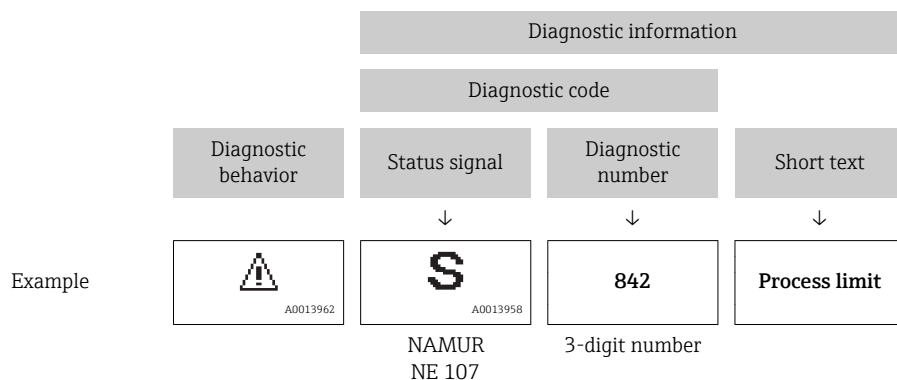

12.5.2 Calling up remedy information

Remedy information is provided for every diagnostic event to ensure that problems can be rectified quickly:

- On the home page
Remedy information is displayed in a separate field below the diagnostics information.
- In the **Diagnostics** menu
Remedy information can be called up in the working area of the user interface.

The user is in the **Diagnostics** menu.

1. Call up the desired parameter.
2. On the right in the working area, mouse over the parameter.
 - ↳ A tool tip with remedy information for the diagnostic event appears.

12.6 Diagnostic information via communication interface

12.6.1 Reading out diagnostic information

The current diagnostic event and associated diagnostic information can be read out via the input assembly (fix assembly):

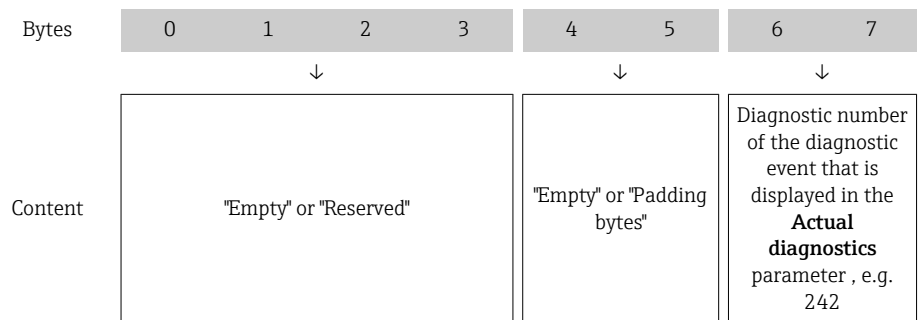

 For the content of bytes 8 to 16

12.7 Adapting the diagnostic information

12.7.1 Adapting the diagnostic behavior

Each item of diagnostic information is assigned a specific diagnostic behavior at the factory. The user can change this assignment for specific diagnostic information in the **Diagnostic behavior** submenu.



Expert → System → Diagnostic handling → Diagnostic behavior

You can assign the following options to the diagnostic number as the diagnostic behavior:

Options	Description
Alarm	The device stops measurement. The totalizers assume the defined alarm condition. A diagnostic message is generated. The background lighting changes to red.
Warning	The device continues to measure. The totalizers are not affected. A diagnostic message is generated.
Logbook entry only	The device continues to measure. The diagnostic message is displayed only in the Event logbook submenu (Event list submenu) and is not displayed in alternation with the operational display.
Off	The diagnostic event is ignored, and no diagnostic message is generated or entered.

12.8 Overview of diagnostic information

 The amount of diagnostic information and the number of measured variables affected increase if the measuring device has one or more application packages.

 In the case of some items of diagnostic information, the diagnostic behavior can be changed. Change the diagnostic information →  171

12.8.1 Diagnostic of sensor

Diagnostic information		Remedy instructions	Coding of diagnostic information (hex)	
No.	Short text			
043	Sensor short circuit	1. Check sensor cable and sensor 2. Execute Heartbeat Verification 3. Replace sensor cable or sensor	0x8000153	
	Status signal			S
	Diagnostic behavior [from the factory] ¹⁾			Warning

1) Diagnostic behavior can be changed.

Diagnostic information		Remedy instructions	Coding of diagnostic information (hex)	
No.	Short text			
082	Data storage	1. Check module connections 2. Contact service	0x10000E7	
	Status signal			F
	Diagnostic behavior			Alarm

Diagnostic information		Remedy instructions	Coding of diagnostic information (hex)	
No.	Short text			
083	Memory content	1. Restart device 2. Restore HistoROM S-DAT backup ('Device reset' parameter) 3. Replace HistoROM S-DAT	0x10000A0	
	Status signal			F
	Diagnostic behavior			Alarm

Diagnostic information		Remedy instructions	Coding of diagnostic information (hex)	
No.	Short text			
169	Conductivity measurement failed	1. Check grounding conditions 2. Deactivate conductivity measurement	0x400038A	
	Status signal			M
	Diagnostic behavior			Warning

Diagnostic information		Remedy instructions	Coding of diagnostic information (hex)	
No.	Short text			
170	Coil resistance	Check ambient and process temperature	<ul style="list-style-type: none"> ■ 0x10002D8 ■ 0x10002D9 	
	Status signal			F
	Diagnostic behavior			Alarm

Diagnostic information		Remedy instructions	Coding of diagnostic information (hex)	
No.	Short text			
180	Temperature sensor defective	<ol style="list-style-type: none"> 1. Check sensor connections 2. Replace sensor cable or sensor 3. Turn off temperature measurement 	<ul style="list-style-type: none"> ■ 0x1000D5 ■ 0x1000D6 	
	Status signal			F
	Diagnostic behavior			Warning

Diagnostic information		Remedy instructions	Coding of diagnostic information (hex)	
No.	Short text			
181	Sensor connection	<ol style="list-style-type: none"> 1. Check sensor cable and sensor 2. Execute Heartbeat Verification 3. Replace sensor cable or sensor 	<ul style="list-style-type: none"> ■ 0x100011C ■ 0x10002E0 	
	Status signal			F
	Diagnostic behavior			Alarm

12.8.2 Diagnostic of electronic

Diagnostic information		Remedy instructions	Coding of diagnostic information (hex)	
No.	Short text			
201	Device failure	<ol style="list-style-type: none"> 1. Restart device 2. Contact service 	0x100014B	
	Status signal			F
	Diagnostic behavior			Alarm

Diagnostic information		Remedy instructions	Coding of diagnostic information (hex)	
No.	Short text			
242	Software incompatible	<ol style="list-style-type: none"> 1. Check software 2. Flash or change main electronics module 	0x1000067	
	Status signal			F
	Diagnostic behavior			Alarm

Diagnostic information		Remedy instructions	Coding of diagnostic information (hex)	
No.	Short text			
252	Modules incompatible	<ol style="list-style-type: none"> 1. Check electronic modules 2. Change electronic modules 	0x100006B	
	Status signal			F
	Diagnostic behavior			Alarm

Diagnostic information		Remedy instructions	Coding of diagnostic information (hex)	
No.	Short text			
252	Modules incompatible	<ol style="list-style-type: none"> 1. Check if correct electronic modul is plugged 2. Replace electronic module 	0x10002C0	
	Status signal			F
	Diagnostic behavior			Alarm

Diagnostic information		Remedy instructions	Coding of diagnostic information (hex)
No.	Short text		
262	Sensor electronic connection faulty		0x1000149
	Status signal	F	
	Diagnostic behavior	Alarm	

Diagnostic information		Remedy instructions	Coding of diagnostic information (hex)
No.	Short text		
270	Main electronic failure		<ul style="list-style-type: none"> ■ 0x1000078 ■ 0x100007C ■ 0x1000080 ■ 0x100009F ■ 0x10002D7
	Status signal	F	
	Diagnostic behavior	Alarm	

Diagnostic information		Remedy instructions	Coding of diagnostic information (hex)
No.	Short text		
271	Main electronic failure		0x100007D
	Status signal	F	
	Diagnostic behavior	Alarm	

Diagnostic information		Remedy instructions	Coding of diagnostic information (hex)
No.	Short text		
272	Main electronic failure		0x1000079
	Status signal	F	
	Diagnostic behavior	Alarm	

Diagnostic information		Remedy instructions	Coding of diagnostic information (hex)
No.	Short text		
273	Main electronic failure		<ul style="list-style-type: none"> ■ 0x1000098 ■ 0x10000E5
	Status signal	F	
	Diagnostic behavior	Alarm	

Diagnostic information		Remedy instructions	Coding of diagnostic information (hex)
No.	Short text		
275	I/O module 1 to n defective		0x100007A
	Status signal	F	
	Diagnostic behavior	Alarm	

Diagnostic information		Remedy instructions	Coding of diagnostic information (hex)	
No.	Short text			
276	I/O module 1 to n faulty	1. Restart device 2. Change I/O module	<ul style="list-style-type: none"> ■ 0x100007B ■ 0x1000081 	
	Status signal			F
	Diagnostic behavior			Alarm

Diagnostic information		Remedy instructions	Coding of diagnostic information (hex)	
No.	Short text			
283	Memory content	1. Reset device 2. Contact service	<ul style="list-style-type: none"> ■ 0x10000E1 ■ 0x100016F 	
	Status signal			F
	Diagnostic behavior			Alarm

Diagnostic information		Remedy instructions	Coding of diagnostic information (hex)	
No.	Short text			
302	Device verification active	Device verification active, please wait.	0x20001EE	
	Status signal			C
	Diagnostic behavior			Warning

Diagnostic information		Remedy instructions	Coding of diagnostic information (hex)	
No.	Short text			
311	Electronic failure	1. Do not reset device 2. Contact service	0x40000E2	
	Status signal			M
	Diagnostic behavior			Warning

Diagnostic information		Remedy instructions	Coding of diagnostic information (hex)	
No.	Short text			
332	Writing in HistoROM backup failed	Replace user interface board Ex d/XP: replace transmitter	0x10002C7	
	Status signal			F
	Diagnostic behavior			Alarm

Diagnostic information		Remedy instructions	Coding of diagnostic information (hex)	
No.	Short text			
361	I/O module 1 to n faulty	1. Restart device 2. Check electronic modules 3. Change I/O Modul or main electronics	0x1000095	
	Status signal			F
	Diagnostic behavior			Alarm

Diagnostic information		Remedy instructions	Coding of diagnostic information (hex)	
No.	Short text			
372	Sensor electronic (ISEM) faulty	<ol style="list-style-type: none"> Restart device Check if failure recurs Replace sensor electronic module (ISEM) 	<ul style="list-style-type: none"> ■ 0x10002CB ■ 0x10002CC ■ 0x10002CD ■ 0x10002CE ■ 0x10002CF ■ 0x10002D0 	
	Status signal			F
	Diagnostic behavior			Alarm

Diagnostic information		Remedy instructions	Coding of diagnostic information (hex)	
No.	Short text			
373	Sensor electronic (ISEM) faulty	<ol style="list-style-type: none"> Transfer data or reset device Contact service 	0x10002D1	
	Status signal			F
	Diagnostic behavior			Alarm

Diagnostic information		Remedy instructions	Coding of diagnostic information (hex)	
No.	Short text			
375	I/O- 1 to n communication failed	<ol style="list-style-type: none"> Restart device Check if failure recurs Replace module rack inclusive electronic modules 	0x1000107	
	Status signal			F
	Diagnostic behavior			Alarm

Diagnostic information		Remedy instructions	Coding of diagnostic information (hex)	
No.	Short text			
376	Sensor electronic (ISEM) faulty	<ol style="list-style-type: none"> Replace sensor electronic module (ISEM) Turn off diagnostic message 	<ul style="list-style-type: none"> ■ 0x8000119 ■ 0x800016A ■ 0x80002DA ■ 0x80002DB ■ 0x80002DC ■ 0x80002DD ■ 0x80002DF 	
	Status signal			S
	Diagnostic behavior [from the factory] ¹⁾			Warning

1) Diagnostic behavior can be changed.

Diagnostic information		Remedy instructions	Coding of diagnostic information (hex)	
No.	Short text			
377	Sensor electronic (ISEM) faulty	<ol style="list-style-type: none"> Check sensor cable and sensor Perform Heartbeat Verification Replace sensor cable or sensor 	0x80002DE	
	Status signal			S
	Diagnostic behavior [from the factory] ¹⁾			Warning

1) Diagnostic behavior can be changed.

Diagnostic information		Remedy instructions	Coding of diagnostic information (hex)	
No.	Short text			
382	Data storage	<ol style="list-style-type: none"> Insert T-DAT Replace T-DAT 	0x100016D	
	Status signal			F
	Diagnostic behavior			Alarm

Diagnostic information		Remedy instructions	Coding of diagnostic information (hex)	
No.	Short text			
383	Memory content	1. Restart device 2. Delete T-DAT via 'Reset device' parameter 3. Replace T-DAT	0x100016E	
	Status signal			F
	Diagnostic behavior			Alarm

Diagnostic information		Remedy instructions	Coding of diagnostic information (hex)	
No.	Short text			
387	HistoROM backup failed	Contact service organization	0x1000288	
	Status signal			F
	Diagnostic behavior			Alarm

Diagnostic information		Remedy instructions	Coding of diagnostic information (hex)	
No.	Short text			
512	Sensor electronic (ISEM) faulty	1. Check ECC recovery time 2. Turn off ECC	0x1000120	
	Status signal			F
	Diagnostic behavior			Alarm

12.8.3 Diagnostic of configuration

Diagnostic information		Remedy instructions	Coding of diagnostic information (hex)	
No.	Short text			
303	I/O 1 to n configuration changed	1. Apply I/O module configuration (parameter 'Apply I/O configuration') 2. Afterwards reload device description and check wiring	0x400026C	
	Status signal			M
	Diagnostic behavior			Warning

Diagnostic information		Remedy instructions	Coding of diagnostic information (hex)	
No.	Short text			
330	Flash file invalid	1. Update firmware of device 2. Restart device	0x40002C9	
	Status signal			M
	Diagnostic behavior			Warning

Diagnostic information		Remedy instructions	Coding of diagnostic information (hex)	
No.	Short text			
331	Firmware update failed	1. Update firmware of device 2. Restart device	0x10002CA	
	Status signal			F
	Diagnostic behavior			Warning

Diagnostic information		Remedy instructions	Coding of diagnostic information (hex)	
No.	Short text			
410	Data transfer	1. Check connection 2. Retry data transfer	0x100008B	
	Status signal			F
	Diagnostic behavior			Alarm

Diagnostic information		Remedy instructions	Coding of diagnostic information (hex)	
No.	Short text			
412	Processing download	Download active, please wait	0x2000204	
	Status signal			C
	Diagnostic behavior			Warning

Diagnostic information		Remedy instructions	Coding of diagnostic information (hex)	
No.	Short text			
431	Trim 1 to n	Carry out trim	0x2000004	
	Status signal			C
	Diagnostic behavior			Warning

Diagnostic information		Remedy instructions	Coding of diagnostic information (hex)	
No.	Short text			
437	Configuration incompatible	1. Restart device 2. Contact service	0x1000060	
	Status signal			F
	Diagnostic behavior			Alarm

Diagnostic information		Remedy instructions	Coding of diagnostic information (hex)	
No.	Short text			
438	Dataset	1. Check data set file 2. Check device configuration 3. Up- and download new configuration	0x400006A	
	Status signal			M
	Diagnostic behavior			Warning

Diagnostic information		Remedy instructions	Coding of diagnostic information (hex)	
No.	Short text			
441	Current output 1 to n	1. Check process 2. Check current output settings	<ul style="list-style-type: none"> ■ 0x8000099 ■ 0x80000B6 	
	Status signal			S
	Diagnostic behavior			Warning

Diagnostic information		Remedy instructions	Coding of diagnostic information (hex)	
No.	Short text			
442	Frequency output 1 to n	1. Check process 2. Check frequency output settings	<ul style="list-style-type: none"> ■ 0x800008A ■ 0x8000122 	
	Status signal			S
	Diagnostic behavior			Warning

Diagnostic information		Remedy instructions	Coding of diagnostic information (hex)	
No.	Short text			
443	Pulse output 1 to n	1. Check process 2. Check pulse output settings	<ul style="list-style-type: none"> ■ 0x800008C ■ 0x8000121 	
	Status signal			S
	Diagnostic behavior			Warning

Diagnostic information		Remedy instructions	Coding of diagnostic information (hex)	
No.	Short text			
444	Current input 1 to n	1. Check process 2. Check current input settings	0x80001EB	
	Status signal			S
	Diagnostic behavior			Warning

Diagnostic information		Remedy instructions	Coding of diagnostic information (hex)	
No.	Short text			
453	Flow override	Deactivate flow override	0x2000094	
	Status signal			C
	Diagnostic behavior			Warning

Diagnostic information		Remedy instructions	Coding of diagnostic information (hex)	
No.	Short text			
484	Failure mode simulation	Deactivate simulation	0x2000090	
	Status signal			C
	Diagnostic behavior			Alarm

Diagnostic information		Remedy instructions	Coding of diagnostic information (hex)	
No.	Short text			
485	Measured variable simulation	Deactivate simulation	0x2000093	
	Status signal			C
	Diagnostic behavior			Warning

Diagnostic information		Remedy instructions	Coding of diagnostic information (hex)	
No.	Short text			
486	Current input 1 to n simulation	Deactivate simulation	0x20001EC	
	Status signal			C
	Diagnostic behavior			Warning

Diagnostic information		Remedy instructions	Coding of diagnostic information (hex)	
No.	Short text			
491	Current output 1 to n simulation	Deactivate simulation	0x200000E	
	Status signal			C
	Diagnostic behavior			Warning

Diagnostic information		Remedy instructions	Coding of diagnostic information (hex)	
No.	Short text			
492	Simulation frequency output 1 to n	Deactivate simulation frequency output	0x200008D	
	Status signal			C
	Diagnostic behavior			Warning

Diagnostic information		Remedy instructions	Coding of diagnostic information (hex)	
No.	Short text			
493	Simulation pulse output 1 to n	Deactivate simulation pulse output	0x200008E	
	Status signal			C
	Diagnostic behavior			Warning

Diagnostic information		Remedy instructions	Coding of diagnostic information (hex)	
No.	Short text			
494	Switch output simulation 1 to n	Deactivate simulation switch output	0x200008F	
	Status signal			C
	Diagnostic behavior			Warning

Diagnostic information		Remedy instructions	Coding of diagnostic information (hex)	
No.	Short text			
495	Diagnostic event simulation	Deactivate simulation	0x200015E	
	Status signal			C
	Diagnostic behavior			Warning

Diagnostic information		Remedy instructions	Coding of diagnostic information (hex)	
No.	Short text			
496	Status input simulation	Deactivate simulation status input	0x2000170	
	Status signal			C
	Diagnostic behavior			Warning

Diagnostic information		Remedy instructions	Coding of diagnostic information (hex)	
No.	Short text			
511	ISEM settings faulty	1. Check measuring period and integration time 2. Check sensor properties	0x200031C	
	Status signal			C
	Diagnostic behavior			Alarm

Diagnostic information		Remedy instructions	Coding of diagnostic information (hex)	
No.	Short text			
520	I/O 1 to n hardware configuration invalid	1. Check I/O hardware configuration 2. Replace wrong I/O module 3. Plug the module of double pulse output on correct slot	0x1000276	
	Status signal			F
	Diagnostic behavior			Alarm

Diagnostic information		Remedy instructions	Coding of diagnostic information (hex)	
No.	Short text			
530	Electrode cleaning is running	Turn off ECC	0x200015A	
	Status signal			C
	Diagnostic behavior			Warning

Diagnostic information		Remedy instructions	Coding of diagnostic information (hex)	
No.	Short text			
531	Empty pipe adjustment faulty	Execute EPD adjustment	0x800016B	
	Status signal			S
	Diagnostic behavior [from the factory] ¹⁾			Warning

1) Diagnostic behavior can be changed.

Diagnostic information		Remedy instructions	Coding of diagnostic information (hex)	
No.	Short text			
537	Configuration	1. Check IP addresses in network 2. Change IP address	0x100014A	
	Status signal			F
	Diagnostic behavior			Warning

Diagnostic information		Remedy instructions	Coding of diagnostic information (hex)	
No.	Short text			
594	Relay output simulation	Deactivate simulation switch output	0x20002BA	
	Status signal			C
	Diagnostic behavior			Warning

12.8.4 Diagnostic of process

Diagnostic information		Remedy instructions	Coding of diagnostic information (hex)	
No.	Short text			
803	Current loop	1. Check wiring 2. Change I/O module	0x10000AD	
	Status signal			F
	Diagnostic behavior			Alarm

Diagnostic information		Remedy instructions	Coding of diagnostic information (hex)	
No.	Short text			
832	Electronic temperature too high	Reduce ambient temperature	<ul style="list-style-type: none"> ■ 0x80000C3 ■ 0x80002D4 	
	Status signal			S
	Diagnostic behavior [from the factory] ¹⁾			Warning

1) Diagnostic behavior can be changed.

Diagnostic information		Remedy instructions	Coding of diagnostic information (hex)	
No.	Short text			
833	Electronic temperature too low	Increase ambient temperature	<ul style="list-style-type: none"> ■ 0x80000C1 ■ 0x80002D3 	
	Status signal			S
	Diagnostic behavior [from the factory] ¹⁾			Warning

1) Diagnostic behavior can be changed.

Diagnostic information		Remedy instructions	Coding of diagnostic information (hex)	
No.	Short text			
834	Process temperature too high	Reduce process temperature	0x80000C5	
	Status signal			S
	Diagnostic behavior [from the factory] ¹⁾			Warning

1) Diagnostic behavior can be changed.

Diagnostic information		Remedy instructions	Coding of diagnostic information (hex)	
No.	Short text			
835	Process temperature too low	Increase process temperature	0x80000C6	
	Status signal			S
	Diagnostic behavior [from the factory] ¹⁾			Warning

1) Diagnostic behavior can be changed.

Diagnostic information		Remedy instructions	Coding of diagnostic information (hex)	
No.	Short text			
842	Process limit	Low flow cut off active! 1. Check low flow cut off configuration	0x8000091	
	Status signal			S
	Diagnostic behavior			Warning

Diagnostic information		Remedy instructions	Coding of diagnostic information (hex)	
No.	Short text			
882	Input signal	1. Check input configuration 2. Check external device or process conditions	0x1000031	
	Status signal			F
	Diagnostic behavior			Alarm

Diagnostic information		Remedy instructions	Coding of diagnostic information (hex)	
No.	Short text			
937	Sensor symmetry	1. Eliminate external magnetic field near sensor 2. Turn off diagnostic message	0x8000154	
	Status signal			S
	Diagnostic behavior [from the factory] ¹⁾			Warning

1) Diagnostic behavior can be changed.

Diagnostic information		Remedy instructions	Coding of diagnostic information (hex)	
No.	Short text			
938	EMC interference	1. Check ambient conditions regarding EMC influence 2. Turn off diagnostic message	0x100011B	
	Status signal			F
	Diagnostic behavior [from the factory] ¹⁾			Alarm

1) Diagnostic behavior can be changed.

Diagnostic information		Remedy instructions	Coding of diagnostic information (hex)	
No.	Short text			
961	Electrode potential out of specification	1. Check process conditions 2. Check ambient conditions	0x8000155	
	Status signal			S
	Diagnostic behavior			Warning





No.	Diagnostic information		Remedy instructions	Coding of diagnostic information (hex)
	Short text			
962	Pipe empty		1. Perform full pipe adjustment 2. Perform empty pipe adjustment 3. Turn off empty pipe detection	0x8000092
	Status signal	S		
	Diagnostic behavior [from the factory] ¹⁾	Warning		

1) Diagnostic behavior can be changed.

12.9 Pending diagnostic events

The **Diagnostics** menu allows the user to view the current diagnostic event and the previous diagnostic event separately.





i To call up the measures to rectify a diagnostic event:

- Via local display →  168
- Via Web browser →  169
- Via "FieldCare" operating tool →  170
- Via "DeviceCare" operating tool →  170

i Other pending diagnostic events can be displayed in the **Diagnostic list** submenu →  185

Navigation

"Diagnostics" menu

Diagnostics	
Actual diagnostics	→  184
Previous diagnostics	→  184
Operating time from restart	→  185
Operating time	→  185

Parameter overview with brief description

Parameter	Prerequisite	Description	User interface
Actual diagnostics	A diagnostic event has occurred.	Shows the current occurred diagnostic event along with its diagnostic information. i If two or more messages occur simultaneously, the message with the highest priority is shown on the display.	Symbol for diagnostic behavior, diagnostic code and short message.
Previous diagnostics	Two diagnostic events have already occurred.	Shows the diagnostic event that occurred prior to the current diagnostic event along with its diagnostic information.	Symbol for diagnostic behavior, diagnostic code and short message.

Parameter	Prerequisite	Description	User interface
Operating time from restart	-	Shows the time the device has been in operation since the last device restart.	Days (d), hours (h), minutes (m) and seconds (s)
Operating time	-	Indicates how long the device has been in operation.	Days (d), hours (h), minutes (m) and seconds (s)

12.10 Diagnostic list

Up to 5 currently pending diagnostic events can be displayed in the **Diagnostic list** submenu along with the associated diagnostic information. If more than 5 diagnostic events are pending, the events with the highest priority are shown on the display.

Navigation path

Diagnostics → Diagnostic list

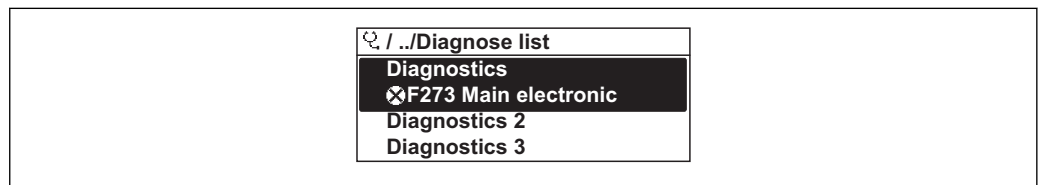

A0014006-EN

42 Taking the example of the local display

i To call up the measures to rectify a diagnostic event:

- Via local display → 168
- Via Web browser → 169
- Via "FieldCare" operating tool → 170
- Via "DeviceCare" operating tool → 170

12.11 Event logbook

12.11.1 Reading out the event logbook

A chronological overview of the event messages that have occurred is provided in the **Events list** submenu.

Navigation path

Diagnostics menu → **Event logbook** submenu → Event list

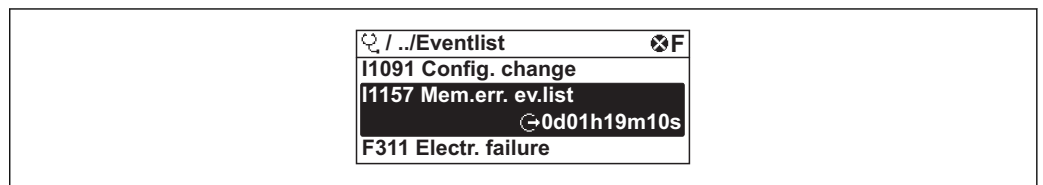

A0014008-EN

43 Taking the example of the local display

- A maximum of 20 event messages can be displayed in chronological order.
- If the **Extended HistoROM** application package (order option) is enabled in the device, the event list can contain up to 100 entries .





The event history includes entries for:

- Diagnostic events → 172
- Information events → 186

In addition to the operation time of its occurrence, each event is also assigned a symbol that indicates whether the event has occurred or is ended:

- Diagnostic event
 - ☺: Occurrence of the event
 - ☹: End of the event
- Information event
 - ☺: Occurrence of the event

 To call up the measures to rectify a diagnostic event:

- Via local display →  168
- Via Web browser →  169
- Via "FieldCare" operating tool →  170
- Via "DeviceCare" operating tool →  170

 For filtering the displayed event messages →  186

12.11.2 Filtering the event logbook

Using the **Filter options** parameter you can define which category of event message is displayed in the **Events list** submenu.

Navigation path

Diagnostics → Event logbook → Filter options

Filter categories

- All
- Failure (F)
- Function check (C)
- Out of specification (S)
- Maintenance required (M)
- Information (I)

12.11.3 Overview of information events

Unlike a diagnostic event, an information event is displayed in the event logbook only and not in the diagnostic list.

Info number	Info name
I1000	----- (Device ok)
I1079	Sensor changed
I1089	Power on
I1090	Configuration reset
I1091	Configuration changed
I1092	HistoROM backup deleted
I1137	Electronic changed
I1151	History reset
I1155	Reset electronic temperature
I1156	Memory error trend
I1157	Memory error event list
I1184	Display connected
I1256	Display: access status changed
I1278	I/O module reset detected
I1335	Firmware changed
I1351	Empty pipe detection adjustment failure

Info number	Info name
I1353	Empty pipe detection adjustment ok
I1361	Web server: login failed
I1397	Fieldbus: access status changed
I1398	CDI: access status changed
I1443	Coating thickness not determined
I1444	Device verification passed
I1445	Device verification failed
I1457	Measured error verification failed
I1459	I/O module verification failed
I1461	Sensor verification failed
I1462	Sensor electronic module verific. failed
I1512	Download started
I1513	Download finished
I1514	Upload started
I1515	Upload finished
I1618	I/O module 2 replaced
I1619	I/O module 3 replaced
I1621	I/O module 4 replaced
I1622	Calibration changed
I1624	Reset all totalizers
I1625	Write protection activated
I1626	Write protection deactivated
I1627	Web server: login successful
I1628	Display: login successful
I1629	CDI: login successful
I1631	Web server access changed
I1632	Display: login failed
I1633	CDI: login failed
I1634	Reset to factory settings
I1635	Reset to delivery settings
I1639	Max. switch cycles number reached
I1649	Hardware write protection activated
I1650	Hardware write protection deactivated
I1712	New flash file received
I1725	Sensor electronic module (ISEM) changed
I1726	Configuration backup failed

12.12 Resetting the measuring device

Using the **Device reset** parameter (→  143) it is possible to reset the entire device configuration or some of the configuration to a defined state.

12.12.1 Function scope of the "Device reset" parameter

Options	Description
Cancel	No action is executed and the user exits the parameter.
To delivery settings	Every parameter for which a customer-specific default setting was ordered is reset to this customer-specific value. All other parameters are reset to the factory setting.
Restart device	The restart resets every parameter whose data are in the volatile memory (RAM) to the factory setting (e.g. measured value data). The device configuration remains unchanged.
Restore S-DAT backup	Restore the data that are saved on the S-DAT. The data record is restored from the electronics memory to the S-DAT.

12.13 Device information

The **Device information** submenu contains all parameters that display different information for device identification.





Navigation

"Diagnostics" menu → Device information

► Device information	
Device tag	→ ⓘ 188
Serial number	→ ⓘ 188
Firmware version	→ ⓘ 189
Device name	→ ⓘ 189
Order code	→ ⓘ 189
Extended order code 1	→ ⓘ 189
Extended order code 2	→ ⓘ 189
Extended order code 3	→ ⓘ 189
ENP version	→ ⓘ 189



Parameter overview with brief description

Parameter	Description	User interface	Factory setting
Device tag	Shows name of measuring point.	Max. 32 characters, such as letters, numbers or special characters (e.g. @, %, /).	Promag
Serial number	Shows the serial number of the measuring device.	A maximum of 11-digit character string comprising letters and numbers.	-

Parameter	Description	User interface	Factory setting
Firmware version	Shows the device firmware version installed.	Character string in the format xx.yy.zz	–
Device name	Shows the name of the transmitter.  The name can be found on the nameplate of the transmitter.	Promag300/500	–
Order code	Shows the device order code.  The order code can be found on the nameplate of the sensor and transmitter in the "Order code" field.	Character string composed of letters, numbers and certain punctuation marks (e.g. /).	–
Extended order code 1	Shows the 1st part of the extended order code.  The extended order code can also be found on the nameplate of the sensor and transmitter in the "Ext. ord. cd." field.	Character string	–
Extended order code 2	Shows the 2nd part of the extended order code.  The extended order code can also be found on the nameplate of the sensor and transmitter in the "Ext. ord. cd." field.	Character string	–
Extended order code 3	Shows the 3rd part of the extended order code.  The extended order code can also be found on the nameplate of the sensor and transmitter in the "Ext. ord. cd." field.	Character string	–
ENP version	Shows the version of the electronic nameplate (ENP).	Character string	2.02.00

12.14 Firmware history

Release date	Firmware version	Order code for "Firmware version"	Firmware changes	Documentation type	Documentation
10.2017	01.00.zz	Option 77	Original firmware	Operating Instructions	BA01721D

-  It is possible to flash the firmware to the current version or the previous version using the service interface.
-  For the compatibility of the firmware version with the previous version, the installed device description files and operating tools, observe the information about the device in the "Manufacturer's information" document.
-  The manufacturer's information is available:
 - In the Download Area of the Endress+Hauser web site: www.endress.com → Downloads
 - Specify the following details:
 - Product root: e.g. 5P5B
The product root is the first part of the order code: see the nameplate on the device.
 - Text search: Manufacturer's information
 - Media type: Documentation – Technical Documentation

13 Maintenance

13.1 Maintenance tasks

No special maintenance work is required.

13.1.1 Exterior cleaning

When cleaning the exterior of measuring devices, always use cleaning agents that do not attack the surface of the housing or the seals.

13.1.2 Interior cleaning

No interior cleaning is planned for the device.

13.1.3 Replacing seals

The sensor's seals (particularly aseptic molded seals) must be replaced periodically.

The interval between changes depends on the frequency of the cleaning cycles, the cleaning temperature and the medium temperature.

Replacement seals (accessory part) →  221

13.2 Measuring and test equipment

Endress+Hauser offers a wide variety of measuring and test equipment, such as W@M or device tests.

 Your Endress+Hauser Sales Center can provide detailed information on the services.

List of some of the measuring and testing equipment: →  193

13.3 Endress+Hauser services

Endress+Hauser offers a wide variety of services for maintenance such as recalibration, maintenance service or device tests.

 Your Endress+Hauser Sales Center can provide detailed information on the services.

14 Repairs

14.1 General notes

14.1.1 Repair and conversion concept

The Endress+Hauser repair and conversion concept provides for the following:

- The measuring devices have a modular design.
- Spare parts are grouped into logical kits with the associated Installation Instructions.
- Repairs are carried out by Endress+Hauser Service or by appropriately trained customers.
- Certified devices can only be converted to other certified devices by Endress+Hauser Service or at the factory.

14.1.2 Notes for repair and conversion



For repair and modification of a measuring device, observe the following notes:

- ▶ Use only original Endress+Hauser spare parts.
- ▶ Carry out the repair according to the Installation Instructions.
- ▶ Observe the applicable standards, federal/national regulations, Ex documentation (XA) and certificates.
- ▶ Document every repair and each conversion and enter them into the *W@M* life cycle management database.

14.2 Spare parts

W@M Device Viewer (www.endress.com/deviceviewer):

All the spare parts for the measuring device, along with the order code, are listed here and can be ordered. If available, users can also download the associated Installation Instructions.

-  Measuring device serial number:
 - Is located on the nameplate of the device.
 - Can be read out via the **Serial number** parameter (→  188) in the **Device information** submenu.

14.3 Endress+Hauser services

Endress+Hauser offers a wide range of services.

-  Your Endress+Hauser Sales Center can provide detailed information on the services.

14.4 Return

The measuring device must be returned if it is need of repair or a factory calibration, or if the wrong measuring device has been delivered or ordered. Legal specifications require Endress+Hauser, as an ISO-certified company, to follow certain procedures when handling products that are in contact with the medium.

To ensure safe, swift and professional device returns, please refer to the procedure and conditions for returning devices provided on the Endress+Hauser website at <http://www.endress.com/support/return-material>

14.5 Disposal

14.5.1 Removing the measuring device

1. Switch off the device.

⚠ WARNING

Danger to persons from process conditions.

- ▶ Beware of hazardous process conditions such as pressure in the measuring device, high temperatures or aggressive fluids.

2. Carry out the mounting and connection steps from the "Mounting the measuring device" and "Connecting the measuring device" sections in reverse order. Observe the safety instructions.

14.5.2 Disposing of the measuring device

⚠ WARNING

Danger to personnel and environment from fluids that are hazardous to health.

- ▶ Ensure that the measuring device and all cavities are free of fluid residues that are hazardous to health or the environment, e.g. substances that have permeated into crevices or diffused through plastic.

Observe the following notes during disposal:











- ▶ Observe valid federal/national regulations.
- ▶ Ensure proper separation and reuse of the device components.



15 Accessories

Various accessories, which can be ordered with the device or subsequently from Endress+Hauser, are available for the device. Detailed information on the order code in question is available from your local Endress+Hauser sales center or on the product page of the Endress+Hauser website: www.endress.com.

15.1 Device-specific accessories

15.1.1 For the transmitter



Accessories	Description
Transmitter <ul style="list-style-type: none"> ▪ Proline 500 – digital ▪ Proline 500 	Transmitter for replacement or storage. Use the order code to define the following specifications: <ul style="list-style-type: none"> ▪ Approvals ▪ Output ▪ Input ▪ Display / operation ▪ Housing ▪ Software <ul style="list-style-type: none">  ▪ Proline 500 – digital transmitter: Order code: 5X5BXX-XXXXXXXXXA ▪ Proline 500 transmitter: Order code: 5X5BXX-XXXXXXXXXB <ul style="list-style-type: none">  Proline 500 transmitter for replacement: It is essential to specify the serial number of the current transmitter when ordering. Based on the serial number, the device-specific data (e.g., calibration factors) of the replacement device can be used for the new transmitter. <ul style="list-style-type: none">  For details <ul style="list-style-type: none"> ▪ Proline 500 – digital transmitter: Installation Instructions EA01151 ▪ Proline 500 transmitter: Installation Instructions EA01152
External WLAN antenna	External WLAN antenna with 2 m (6.6 ft) connecting cable and two angle brackets. Order code for "Enclosed accessories", option P8 "Wireless antenna wide area". <ul style="list-style-type: none">  Further information on the WLAN interface →  94.
Pipe mounting set	Pipe mounting set for transmitter. <ul style="list-style-type: none">  ▪ Proline 500 – digital transmitter Order number: 71346427 ▪ Proline 500 transmitter Order number: 71346428
Protective cover Transmitter <ul style="list-style-type: none"> ▪ Proline 500 – digital ▪ Proline 500 	Is used to protect the measuring device from the effects of the weather: e.g. rainwater, excess heating from direct sunlight. <ul style="list-style-type: none">  ▪ Proline 500 – digital transmitter Order number: 71343504 ▪ Proline 500 transmitter Order number: 71343505 <ul style="list-style-type: none">  For details, see Installation Instructions EA01160
Display guard Proline 500 – digital	Is used to protect the measuring device from the effects of the weather: e.g. rainwater, excess heating from direct sunlight. <ul style="list-style-type: none">  Order number: 71228792 <ul style="list-style-type: none">  For details, see Installation Instructions EA01161
Ground cable	Set, consisting of two ground cables for potential equalization.

<p>Connecting cable Proline 500 – digital Sensor – Transmitter</p>	<p>The connecting cable can be ordered directly with the measuring device (order code for "Cable, sensor connection") or as an accessory (order number DK5012).</p> <p>The following cable lengths are available: order code for "Cable, sensor connection"</p> <ul style="list-style-type: none"> ▪ Option B: 20 m (65 ft) ▪ Option E: User configurable up to max. 50 m ▪ Option F: User configurable up to max. 165 ft <p> Maximum possible cable length for a Proline 500 – digital connecting cable: 300 m (1000 ft)</p>
<p>Connecting cable Proline 500 Sensor – Transmitter</p>	<p>The connecting cable can be ordered directly with the measuring device (order code for "Cable, sensor connection") or as an accessory (order number DK5012).</p> <p>The following cable lengths are available: order code for "Cable, sensor connection"</p> <ul style="list-style-type: none"> ▪ Option 1: 5 m (16 ft) ▪ Option 2: 10 m (32 ft) ▪ Option 3: 20 m (65 ft) ▪ Option 4: User configurable cable length (m) ▪ Option 5: User configurable cable length (ft) <p>Reinforced connecting cable with an additional, reinforcing metal braid:</p> <ul style="list-style-type: none"> ▪ Option 6: User configurable cable length (m) ▪ Option 7: User configurable cable length (ft) <p> Possible cable length for a Proline 500 connecting cable: depends on the medium conductivity, max. 200 m (660 ft)</p>



15.1.2 For the sensor

Accessories	Description
<p>Ground disks</p>	<p>Are used to ground the medium in lined measuring tubes to ensure proper measurement.</p> <p> For details, see Installation Instructions EA00070D</p>

15.2 Communication-specific accessories

Accessories	Description
<p>Field Xpert SFX350</p>	<p>Field Xpert SFX350 is a mobile computer for commissioning and maintenance. It enables efficient device configuration and diagnostics for and can be used in non-hazardous areas.</p> <p> For details, see Operating Instructions BA01202S</p>
<p>Field Xpert SFX370</p>	<p>Field Xpert SFX370 is a mobile computer for commissioning and maintenance. It enables efficient device configuration and diagnostics for and can be used in the non-hazardous area and in the hazardous area.</p> <p> For details, see Operating Instructions BA01202S</p>

15.3 Service-specific accessories

Accessories	Description
Applicator	<p>Software for selecting and sizing Endress+Hauser measuring devices:</p> <ul style="list-style-type: none"> ▪ Choice of measuring devices for industrial requirements ▪ Calculation of all the necessary data for identifying the optimum flowmeter: e.g. nominal diameter, pressure loss, flow velocity and accuracy. ▪ Graphic illustration of the calculation results ▪ Determination of the partial order code, administration, documentation and access to all project-related data and parameters over the entire life cycle of a project. <p>Applicator is available:</p> <ul style="list-style-type: none"> ▪ Via the Internet: https://wapps.endress.com/applicator ▪ As a downloadable DVD for local PC installation.
W@M	<p>W@M Life Cycle Management Improved productivity with information at your fingertips. Data relevant to a plant and its components is generated from the first stages of planning and during the asset's complete life cycle.</p> <p>W@M Life Cycle Management is an open and flexible information platform with online and on-site tools. Instant access for your staff to current, in-depth data shortens your plant's engineering time, speeds up procurement processes and increases plant uptime.</p> <p>Combined with the right services, W@M Life Cycle Management boosts productivity in every phase. For more information, visit www.endress.com/lifecyclemanagement</p>
FieldCare	<p>FDT-based plant asset management tool from Endress+Hauser. It can configure all smart field units in your system and helps you manage them. By using the status information, it is also a simple but effective way of checking their status and condition.</p> <p> For details, see Operating Instructions BA00027S and BA00059S</p>
DeviceCare	<p>Tool for connecting and configuring Endress+Hauser field devices.</p> <p> For details, see Innovation brochure IN01047S</p>

15.4 System components

Accessories	Description
Memograph M graphic data manager	<p>The Memograph M graphic data manager provides information on all the relevant measured variables. Measured values are recorded correctly, limit values are monitored and measuring points analyzed. The data are stored in the 256 MB internal memory and also on a SD card or USB stick.</p> <p> For details, see "Technical Information" TI00133R and Operating Instructions BA00247R</p>

16 Technical data

16.1 Application

The measuring device is only suitable for flow measurement of liquids with a minimum conductivity of 5 µS/cm.

Depending on the version ordered, the measuring device can also measure potentially explosive, flammable, poisonous and oxidizing media.

To ensure that the device remains in proper operating condition for its service life, use the measuring device only for media against which the process-wetted materials are sufficiently resistant.

16.2 Function and system design

Measuring principle Electromagnetic flow measurement on the basis of *Faraday's law of magnetic induction*.

Measuring system The measuring system consists of a transmitter and a sensor. The transmitter and sensor are mounted in physically separate locations. They are interconnected by one or two connecting cable(s).

For information on the structure of the device →  14

16.3 Input

Measured variable **Direct measured variables**

- Volume flow (proportional to induced voltage)
- Electrical conductivity

Calculated measured variables

- Mass flow
- Corrected volume flow

Measuring range Typically $v = 0.01$ to 10 m/s (0.03 to 33 ft/s) with the specified accuracy

Flow characteristic values in SI units

Nominal diameter		Recommended flow min./max. full scale value ($v \sim 0.3/10$ m/s) [dm ³ /min]	Factory settings		
[mm]	[in]		Full scale value current output ($v \sim 2.5$ m/s) [dm ³ /min]	Pulse value (~ 2 pulse/s) [dm ³]	Low flow cut off ($v \sim 0.04$ m/s) [dm ³ /min]
15	½	4 to 100	25	0.2	0.5
25	1	9 to 300	75	0.5	1
32	–	15 to 500	125	1	2
40	1 ½	25 to 700	200	1.5	3
50	2	35 to 1100	300	2.5	5
65	–	60 to 2000	500	5	8

Nominal diameter		Recommended flow min./max. full scale value (v ~ 0.3/10 m/s)	Factory settings		
[mm]	[in]		Full scale value current output (v ~ 2.5 m/s)	Pulse value (~ 2 pulse/s)	Low flow cut off (v ~ 0.04 m/s)
		[dm ³ /min]	[dm ³ /min]	[dm ³]	[dm ³ /min]
80	3	90 to 3 000	750	5	12
100	4	145 to 4 700	1200	10	20
125	–	220 to 7 500	1850	15	30
150	6	20 to 600 m ³ /h	150 m ³ /h	0.03 m ³	2.5 m ³ /h
200	8	35 to 1 100 m ³ /h	300 m ³ /h	0.05 m ³	5 m ³ /h
250	10	55 to 1 700 m ³ /h	500 m ³ /h	0.05 m ³	7.5 m ³ /h
300	12	80 to 2 400 m ³ /h	750 m ³ /h	0.1 m ³	10 m ³ /h
350	14	110 to 3 300 m ³ /h	1 000 m ³ /h	0.1 m ³	15 m ³ /h
400	16	140 to 4 200 m ³ /h	1 200 m ³ /h	0.15 m ³	20 m ³ /h
450	18	180 to 5 400 m ³ /h	1 500 m ³ /h	0.25 m ³	25 m ³ /h
500	20	220 to 6 600 m ³ /h	2 000 m ³ /h	0.25 m ³	30 m ³ /h
600	24	310 to 9 600 m ³ /h	2 500 m ³ /h	0.3 m ³	40 m ³ /h

Flow characteristic values in US units

Nominal diameter		Recommended flow min./max. full scale value (v ~ 0.3/10 m/s)	Factory settings		
[in]	[mm]		Full scale value current output (v ~ 2.5 m/s)	Pulse value (~ 2 pulse/s)	Low flow cut off (v ~ 0.04 m/s)
		[gal/min]	[gal/min]	[gal]	[gal/min]
½	15	1.0 to 27	6	0.1	0.15
1	25	2.5 to 80	18	0.2	0.25
1 ½	40	7 to 190	50	0.5	0.75
2	50	10 to 300	75	0.5	1.25
3	80	24 to 800	200	2	2.5
4	100	40 to 1 250	300	2	4
6	150	90 to 2 650	600	5	12
8	200	155 to 4 850	1200	10	15
10	250	250 to 7 500	1500	15	30
12	300	350 to 10 600	2400	25	45
14	350	500 to 15 000	3600	30	60
16	400	600 to 19 000	4800	50	60
18	450	800 to 24 000	6000	50	90
20	500	1 000 to 30 000	7500	75	120
24	600	1 400 to 44 000	10500	100	180

Recommended measuring range



"Flow limit" section →  209

Input signal

External measured values

To increase the accuracy of certain measured variables or to calculate the corrected volume flow, the automation system can continuously write different measured values to the measuring device:

- Medium temperature to increase the accuracy of the electrical conductivity (e.g. iTEMP)
- Reference density for calculating the corrected volume flow

 Various pressure transmitters and temperature measuring devices can be ordered from Endress+Hauser: see "Accessories" section →  195

It is recommended to read in external measured values to calculate the following measured variables:

Corrected volume flow

Current input

The measured values are written from the automation system to the measuring device via the current input →  198.

Digital communication

The measured values are written from the automation system to the measuring device via EtherNet/IP.

Current input 0/4 to 20 mA

Current input	0/4 to 20 mA (active/passive)
Current span	<ul style="list-style-type: none"> ▪ 4 to 20 mA (active) ▪ 0/4 to 20 mA (passive)
Resolution	1 µA
Voltage drop	Typically: 0.6 to 2 V for 3.6 to 22 mA (passive)
Maximum input voltage	≤ 30 V (passive)
Open-circuit voltage	≤ 28.8 V (active)
Possible input variables	<ul style="list-style-type: none"> ▪ Pressure ▪ Temperature ▪ Density

Status input

Maximum input values	<ul style="list-style-type: none"> ▪ DC -3 to 30 V ▪ If status input is active (ON): $R_i > 3 \text{ k}\Omega$
Response time	Adjustable: 5 to 200 ms
Input signal level	<ul style="list-style-type: none"> ▪ Low signal: DC -3 to +5 V ▪ High signal: DC 12 to 30 V
Assignable functions	<ul style="list-style-type: none"> ▪ Off ▪ Reset the individual totalizers separately ▪ Reset all totalizers ▪ Flow override

16.4 Output

Output signal

EtherNet/IP

Standards	In accordance with IEEE 802.3
-----------	-------------------------------

Current output 0/4 to 20 mA

Current output	0/4 to 20 mA
Maximum output values	22.5 mA
Current span	Can be set to: <ul style="list-style-type: none"> ▪ 4 to 20 mA (active) ▪ 0/4 to 20 mA (passive)  Ex-i, passive
Open-circuit voltage	DC 28.8 V (active)
Maximum input voltage	DC 30 V (passive)
Load	0 to 700 Ω
Resolution	0.38 μA
Damping	Adjustable: 0.07 to 999 s
Assignable measured variables	<ul style="list-style-type: none"> ▪ Volume flow ▪ Mass flow ▪ Corrected volume flow ▪ Flow velocity ▪ Conductivity ▪ Corrected conductivity ▪ Temperature ▪ Electronic temperature

Pulse/frequency/switch output

Function	Can be set to pulse, frequency or switch output
Version	Open collector Can be set to: <ul style="list-style-type: none"> ▪ Active ▪ Passive  Ex-i, passive
Maximum input values	DC 30 V, 250 mA (passive)
Open-circuit voltage	DC 28.8 V (active)
Voltage drop	For 22.5 mA: ≤ DC 2 V
Pulse output	
Maximum input values	DC 30 V, 250 mA (passive)
Maximum output current	22.5 mA (active)
Open-circuit voltage	DC 28.8 V (active)
Pulse width	Adjustable: 0.05 to 2 000 ms
Maximum pulse rate	10 000 Impulse/s
Pulse value	Adjustable
Assignable measured variables	<ul style="list-style-type: none"> ▪ Volume flow ▪ Mass flow ▪ Corrected volume flow

Frequency output	
Maximum input values	DC 30 V, 250 mA (passive)
Maximum output current	22.5 mA (active)
Open-circuit voltage	DC 28.8 V (active)
Output frequency	Adjustable: end value frequency 2 to 10 000 Hz ($f_{max} = 12\,500$ Hz)
Damping	Adjustable: 0 to 999 s
Pulse/pause ratio	1:1
Assignable measured variables	<ul style="list-style-type: none"> ■ Volume flow ■ Mass flow ■ Corrected volume flow ■ Flow velocity ■ Conductivity ■ Corrected conductivity ■ Temperature ■ Electronic temperature
Switch output	
Maximum input values	DC 30 V, 250 mA (passive)
Open-circuit voltage	DC 28.8 V (active)
Switching behavior	Binary, conductive or non-conductive
Switching delay	Adjustable: 0 to 100 s
Number of switching cycles	Unlimited
Assignable functions	<ul style="list-style-type: none"> ■ Off ■ On ■ Diagnostic behavior ■ Limit value: <ul style="list-style-type: none"> - Off - Volume flow - Mass flow - Corrected volume flow - Flow velocity - Conductivity - Corrected conductivity - Totalizer 1-3 - Temperature - Electronic temperature ■ Flow direction monitoring ■ Status <ul style="list-style-type: none"> - Empty pipe detection - Low flow cut off

Relay output

Function	Switch output
Version	Relay output, galvanically isolated
Switching behavior	Can be set to: <ul style="list-style-type: none"> ■ NO (normally open), factory setting ■ NC (normally closed)

Maximum switching capacity (passive)	<ul style="list-style-type: none"> ▪ DC 30 V, 0.1 A ▪ AC 30 V, 0.5 A
Assignable functions	<ul style="list-style-type: none"> ▪ Off ▪ On ▪ Diagnostic behavior ▪ Limit value: <ul style="list-style-type: none"> - Off - Volume flow - Mass flow - Corrected volume flow - Flow velocity - Conductivity - Corrected conductivity - Totalizer 1-3 - Temperature - Electronic temperature ▪ Flow direction monitoring ▪ Status <ul style="list-style-type: none"> - Empty pipe detection - Low flow cut off

User configurable input/output

One specific input or output is assigned to a user-configurable input/output (configurable I/O) during device commissioning.

The following inputs and outputs are available for assignment:

- Choice of current output: 4 to 20 mA (active), 0/4 to 20 mA (passive)
- Pulse/frequency/switch output
- Choice of current input: 4 to 20 mA (active), 0/4 to 20 mA (passive)
- Status input

The technical values correspond to those of the inputs and outputs described in this section.

Signal on alarm

Depending on the interface, failure information is displayed as follows:

EtherNet/IP

Device diagnostics	Device condition can be read out in Input Assembly
---------------------------	--

Current output 0/4 to 20 mA

4 to 20 mA

Failure mode	Choose from: <ul style="list-style-type: none"> ▪ 4 to 20 mA in accordance with NAMUR recommendation NE 43 ▪ 4 to 20 mA in accordance with US ▪ Min. value: 3.59 mA ▪ Max. value: 22.5 mA ▪ Freely definable value between: 3.59 to 22.5 mA ▪ Actual value ▪ Last valid value
---------------------	--

0 to 20 mA

Failure mode	Choose from: <ul style="list-style-type: none"> ▪ Maximum alarm: 22 mA ▪ Freely definable value between: 0 to 20.5 mA
---------------------	---

Pulse/frequency/switch output

Pulse output	
Failure mode	Choose from: <ul style="list-style-type: none"> ■ Actual value ■ No pulses
Frequency output	
Failure mode	Choose from: <ul style="list-style-type: none"> ■ Actual value ■ 0 Hz ■ Defined value (f_{max} 2 to 12 500 Hz)
Switch output	
Failure mode	Choose from: <ul style="list-style-type: none"> ■ Current status ■ Open ■ Closed

Relay output

Failure mode	Choose from: <ul style="list-style-type: none"> ■ Current status ■ Open ■ Closed
--------------	---

Local display

Plain text display	With information on cause and remedial measures
Backlight	Red backlighting indicates a device error.

 Status signal as per NAMUR recommendation NE 107

Interface/protocol

- Via digital communication:
 - EtherNet/IP
- Via service interface
 - CDI-RJ45 service interface
 - WLAN interface

Plain text display	With information on cause and remedial measures
--------------------	---

Web server

Plain text display	With information on cause and remedial measures
--------------------	---

Light emitting diodes (LED)

Status information	Status indicated by various light emitting diodes The following information is displayed depending on the device version: <ul style="list-style-type: none"> ▪ Supply voltage active ▪ Data transmission active ▪ Device alarm/error has occurred ▪ EtherNet/IP network available ▪ EtherNet/IP connection established  Diagnostic information via light emitting diodes
---------------------------	---

Low flow cut off The switch points for low flow cut off are user-selectable.

Galvanic isolation The outputs are galvanically isolated from one another and from earth (PE).

Protocol-specific data	Protocol	<ul style="list-style-type: none"> ▪ The CIP Networks Library Volume 1: Common Industrial Protocol ▪ The CIP Networks Library Volume 2: EtherNet/IP Adaptation of CIP
	Communication type	<ul style="list-style-type: none"> ▪ 10Base-T ▪ 100Base-TX
	Device profile	Generic device (product type: 0x2B)
	Manufacturer ID	0x11
	Device type ID	0x103C
	Baud rates	Automatic ¹⁰ / ₁₀₀ Mbit with half-duplex and full-duplex detection
	Polarity	Auto-polarity for automatic correction of crossed Tx/D and Rx/D pairs
	Supported CIP connections	Max. 3 connections
	Explicit connections	Max. 6 connections
	I/O connections	Max. 6 connections (scanner)
	Configuration options for measuring device	<ul style="list-style-type: none"> ▪ DIP switches on the electronics module for IP addressing ▪ Manufacturer-specific software (FieldCare) ▪ Add-on Profile Level 3 for Rockwell Automation control systems ▪ Web browser ▪ Electronic Data Sheet (EDS) integrated in the measuring device
	Configuration of the EtherNet interface	<ul style="list-style-type: none"> ▪ Speed: 10 MBit, 100 MBit, auto (factory setting) ▪ Duplex: half-duplex, full-duplex, auto (factory setting)
	Configuration of the device address	<ul style="list-style-type: none"> ▪ DIP switches on the electronics module for IP addressing (last octet) ▪ DHCP ▪ Manufacturer-specific software (FieldCare) ▪ Add-on Profile Level 3 for Rockwell Automation control systems ▪ Web browser ▪ EtherNet/IP tools, e.g. RSLinx (Rockwell Automation)
	Device Level Ring (DLR)	Yes
System integration	Information regarding system integration →  99. <ul style="list-style-type: none"> ▪ Cyclic data transmission ▪ Block model ▪ Input and output groups 	

16.5 Power supply

Terminal assignment →  41

Device plugs available →  42

Supply voltage	Order code for "Power supply"	terminal voltage		Frequency range
	Option D	DC24 V	±20%	–
Option E	AC100 to 240 V	–15...+10%	50/60 Hz, ±4 Hz	
Option I	DC24 V	±20%	–	
	AC100 to 240 V	–15...+10%	50/60 Hz, ±4 Hz	

Power consumption **Transmitter**
Max. 10 W (active power)

Current consumption **Transmitter**

- Max. 400 mA (24 V)
- Max. 200 mA (110 V, 50/60 Hz; 230 V, 50/60 Hz)

Power supply failure

- Totalizers stop at the last value measured.
- Configuration is retained in the plug-in memory (HistoROM DAT).
- Error messages (incl. total operated hours) are stored.

Electrical connection →  54

Potential equalization →  61

terminals Spring-loaded terminals: Suitable for strands and strands with ferrules.
Conductor cross-section 0.2 to 2.5 mm² (24 to 12 AWG).

Cable entries

- Cable gland: M20 × 1.5 with cable Ø 6 to 12 mm (0.24 to 0.47 in)
- Thread for cable entry:
 - NPT ½"
 - G ½"
 - M20
- Device plug for digital communication: M12

Cable specification →  38

16.6 Performance characteristics

Reference operating conditions

- Error limits following DIN EN 29104, in future ISO 20456
- Water, typically +15 to +45 °C (+59 to +113 °F); 0.5 to 7 bar (73 to 101 psi)
- Data as indicated in the calibration protocol
- Accuracy based on accredited calibration rigs according to ISO 17025

Maximum measured error **Error limits under reference operating conditions**
o.r. = of reading

Volume flow

- ±0.5 % o.r. ± 1 mm/s (0.04 in/s)
- Optional: ±0.2 % o.r. ± 2 mm/s (0.08 in/s)

 Fluctuations in the supply voltage do not have any effect within the specified range.

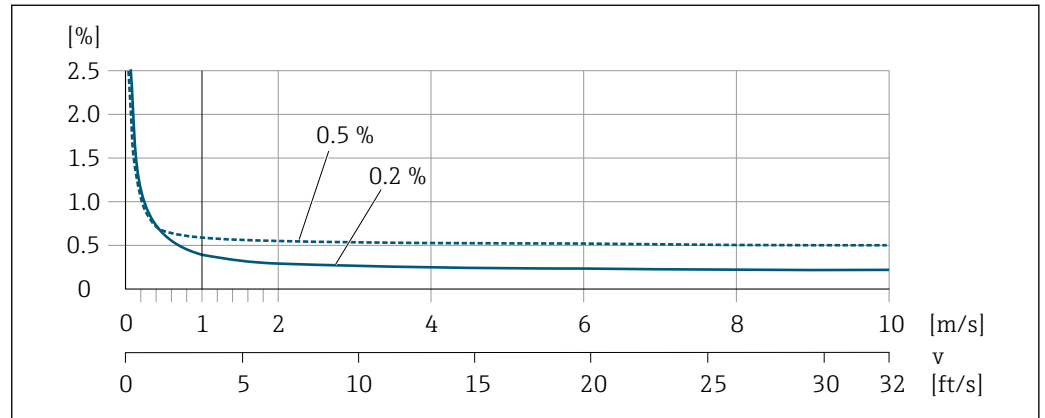

 44 Maximum measured error in % o.r.

Electrical conductivity

Max. measured error not specified.

Repeatability

o.r. = of reading

Volume flow

Max. ±0.1 % o.r. ± 0.5 mm/s (0.02 in/s)

Electrical conductivity

Max. ±5 % o.r.

Influence of ambient temperature

Current output

Temperature coefficient	Max. 1 $\mu\text{A}/^\circ\text{C}$
-------------------------	-------------------------------------

Pulse/frequency output

Temperature coefficient	No additional effect. Included in accuracy.
-------------------------	---

16.7 Installation

"Mounting requirements"

16.8 Environment

Ambient temperature range

→  26

Temperature tables

 Observe the interdependencies between the permitted ambient and fluid temperatures when operating the device in hazardous areas.

 For detailed information on the temperature tables, see the separate document entitled "Safety Instructions" (XA) for the device.

Storage temperature -50 to +80 °C (-58 to +176 °F)

- Protect the measuring device against direct sunlight during storage in order to avoid unacceptably high surface temperatures.
- Select a storage location where moisture cannot collect in the measuring device as fungus or bacteria infestation can damage the liner.
- If protection caps or protective covers are mounted these should never be removed before installing the measuring device.

Degree of protection **Transmitter**

- As standard: IP66/67, type 4X enclosure
- When housing is open: IP20, type 1 enclosure
- Display module: IP20, type 1 enclosure

Sensor
As standard: IP66/67, type 4X enclosure

External WLAN antenna
IP67

Vibration resistance

- Vibration, sinusoidal according to IEC 60068-2-6
 - 2 to 8.4 Hz, 7.5 mm peak
 - 8.4 to 2 000 Hz, 2 g peak
- Vibration broad-band random, according to IEC 60068-2-64
 - 10 to 200 Hz, 0.01 g²/Hz
 - 200 to 2 000 Hz, 0.003 g²/Hz
 - Total: 2.70 g rms

Shock resistance Shock, half-sine according to IEC 60068-2-27
6 ms 50 g

Impact resistance Rough handling shocks according to IEC 60068-2-31

Mechanical load

- Protect the transmitter housing against mechanical effects, such as shock or impact.
- Never use the transmitter housing as a ladder or climbing aid.

Electromagnetic compatibility (EMC) As per IEC/EN 61326 and NAMUR Recommendation 21 (NE 21)

 Details are provided in the Declaration of Conformity.

16.9 Process

Medium temperature range

- -20 to +150 °C (-4 to +302 °F) for PFA, DN 25 to 200 (1 to 8")
- -20 to +180 °C (-4 to +356 °F) for PFA high-temperature, DN 25 to 200 (1 to 8")
- -40 to +130 °C (-40 to +266 °F) for PTFE, DN 15 to 600 (½ to 24")

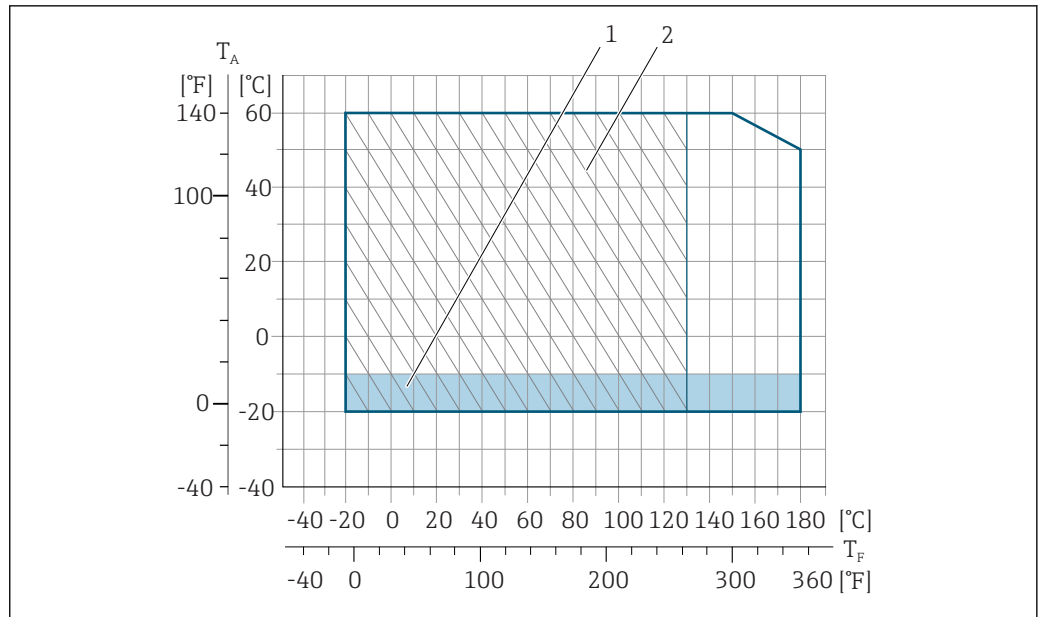

A0029347

45 PFA

T_A Ambient temperature range

T_F Fluid temperature

- 1 Colored area: the ambient temperature range -10 to -20 °C (+14 to -4 °F) applies to stainless flanges only
- 2 Hatched area: harsh environment IP69 only for fluid temperature range -20 to +130 °C (-4 to +266 °F)

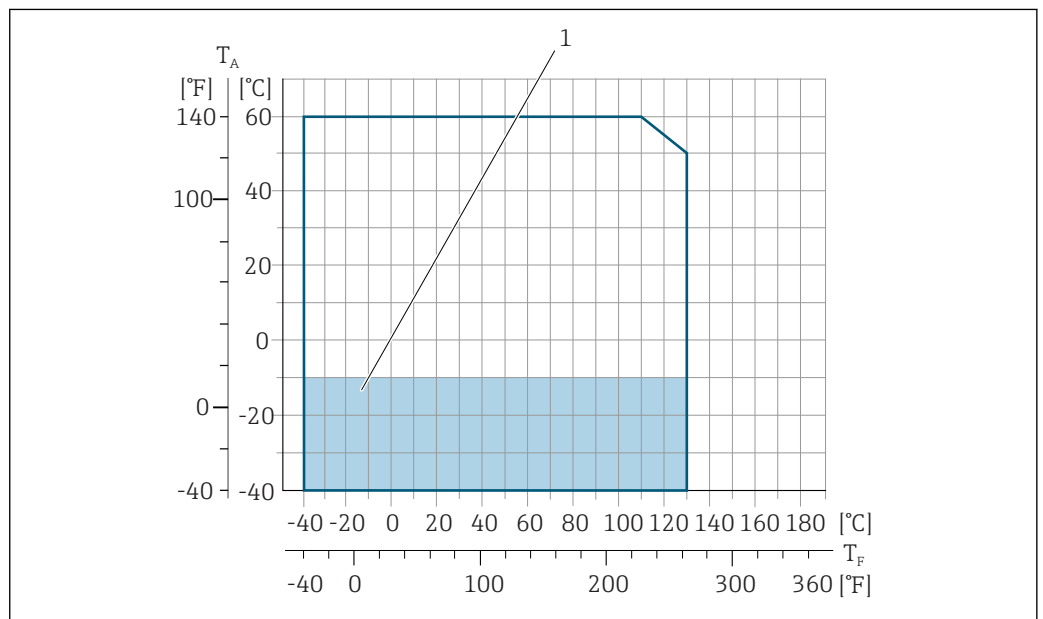

A0029808

46 PTFE

T_A Ambient temperature range

T_F Fluid temperature

- 1 Colored area: the ambient temperature range of -10 to -40 °C (+14 to -40 °F) applies to stainless flanges only

Conductivity

≥ 5 μS/cm for liquids in general. Stronger filter damping is required for very low conductivity values.



Proline 500

The necessary minimum conductivity also depends on the cable length .

Pressure-temperature ratings



An overview of the pressure-temperature ratings for the process connections is provided in the "Technical Information" document

Pressure tightness

"-" = no specifications possible

Liner: PFA

Nominal diameter		Limit values for absolute pressure in [mbar] ([psi]) for medium temperatures:		
[mm]	[in]	+25 °C (+77 °F)	+80 °C (+176 °F)	+100 to +180 °C (+212 to +356 °F)
25	1	0 (0)	0 (0)	0 (0)
32	-	0 (0)	0 (0)	0 (0)
40	1 ½	0 (0)	0 (0)	0 (0)
50	2	0 (0)	0 (0)	0 (0)
65	-	0 (0)	0 (0)	0 (0)
80	3	0 (0)	0 (0)	0 (0)
100	4	0 (0)	0 (0)	0 (0)
125	-	0 (0)	0 (0)	0 (0)
150	6	0 (0)	0 (0)	0 (0)
200	8	0 (0)	0 (0)	0 (0)

Liner: PTFE

Nominal diameter		Limit values for absolute pressure in [mbar] ([psi]) for medium temperatures:			
[mm]	[in]	+25 °C (+77 °F)	+80 °C (+176 °F)	+100 °C (+212 °F)	+130 °C (+266 °F)
15	½	0 (0)	0 (0)	0 (0)	100 (1.45)
25	1	0 (0)	0 (0)	0 (0)	100 (1.45)
32	-	0 (0)	0 (0)	0 (0)	100 (1.45)
40	1 ½	0 (0)	0 (0)	0 (0)	100 (1.45)
50	2	0 (0)	0 (0)	0 (0)	100 (1.45)
65	-	0 (0)	-	40 (0.58)	130 (1.89)
80	3	0 (0)	-	40 (0.58)	130 (1.89)
100	4	0 (0)	-	135 (1.96)	170 (2.47)
125	-	135 (1.96)	-	240 (3.48)	385 (5.58)
150	6	135 (1.96)	-	240 (3.48)	385 (5.58)
200	8	200 (2.90)	-	290 (4.21)	410 (5.95)
250	10	330 (4.79)	-	400 (5.80)	530 (7.69)
300	12	400 (5.80)	-	500 (7.25)	630 (9.14)
350	14	470 (6.82)	-	600 (8.70)	730 (10.6)
400	16	540 (7.83)	-	670 (9.72)	800 (11.6)
450	18	No negative pressure permitted!			
500	20				
600	24				

Flow limit

The diameter of the pipe and the flow rate determine the nominal diameter of the sensor. The optimum velocity of flow is between 2 to 3 m/s (6.56 to 9.84 ft/s). Also match the velocity of flow (v) to the physical properties of the fluid:

- $v < 2 \text{ m/s}$ (6.56 ft/s): for abrasive fluids (e.g. potter's clay, lime milk, ore slurry)
- $v > 2 \text{ m/s}$ (6.56 ft/s): for fluids producing buildup (e.g. wastewater sludge)

i A necessary increase in the flow velocity can be achieved by reducing the sensor nominal diameter.

i For an overview of the full scale values for the measuring range, see the "Measuring range" section → 196

Pressure loss

- No pressure loss occurs if the sensor is installed in a pipe with the same nominal diameter.
- Pressure losses for configurations incorporating adapters according to DIN EN 545 → 27

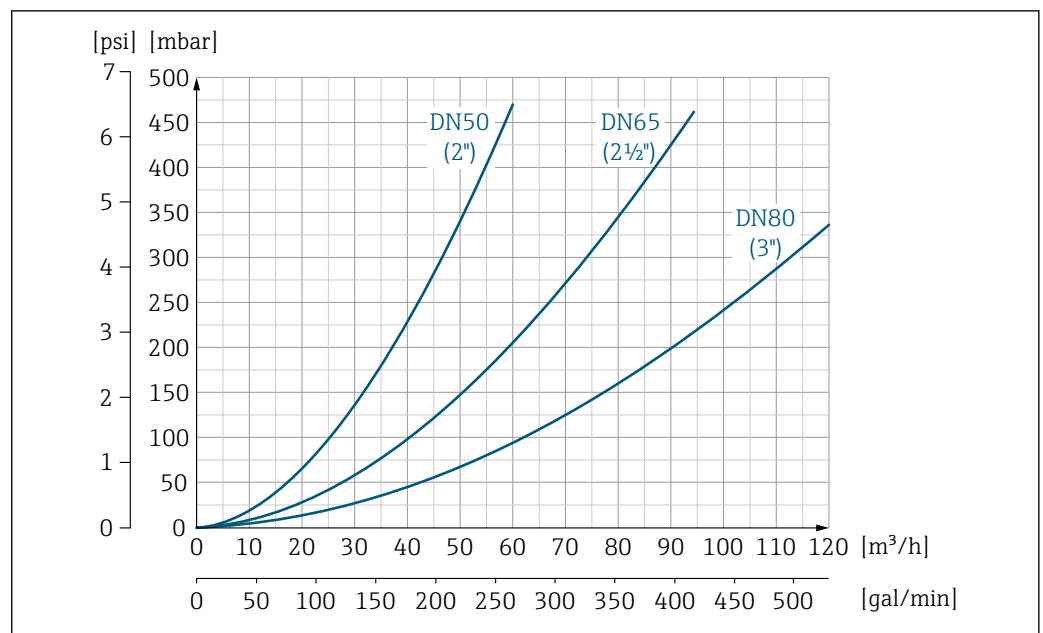

47 Pressure loss DN 50 to 80 (2 to 3") in the case of order code for "Design", option C "Insertion length short ISO/DVGW to DN300, without inlet/outlet runs, constricted meas.tube"

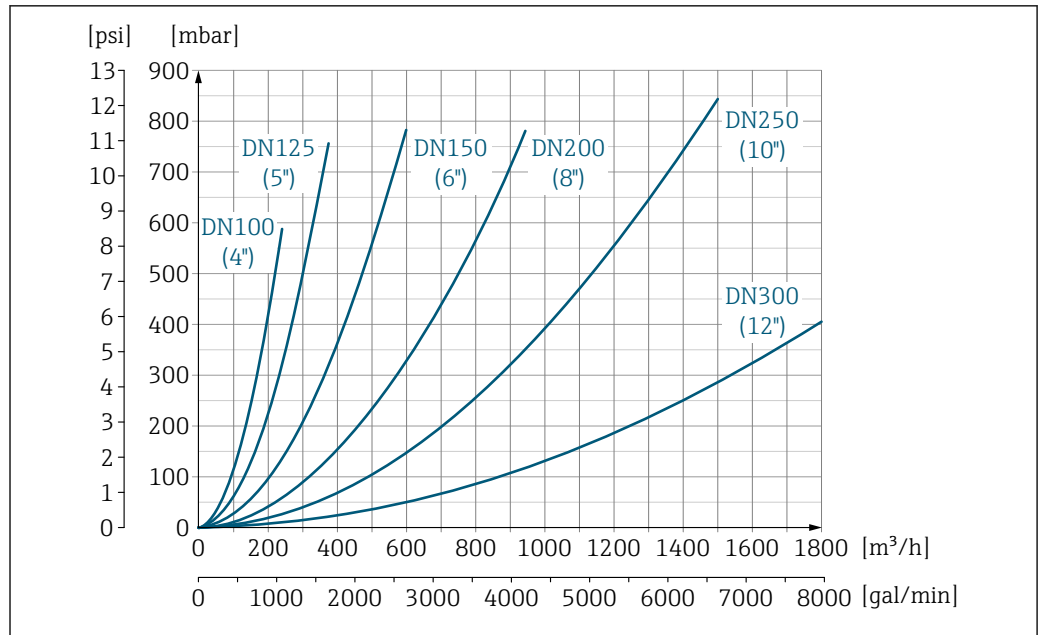

A0032668-EN

48 Pressure loss DN 100 to 300 (4 to 12") in the case of order code for "Design", option C "Insertion length short ISO/DVGW to DN300, without inlet/outlet runs, constricted meas.tube"

System pressure → 26

Vibrations → 26

16.10 Mechanical construction

Design, dimensions

 For the dimensions and installation lengths of the device, see the "Technical Information" document, "Mechanical construction" section.

Weight

All values (weight exclusive of packaging material) refer to devices for standard pressure ratings.

Different values due to different transmitter versions:

Transmitter

- Proline 500 – digital polycarbonate: 1.4 kg (3.1 lbs)
- Proline 500 – digital aluminum: 2.4 kg (5.3 lbs)
- Proline 500 aluminum: 6.5 kg (14.3 lbs)
- Proline 500 cast, stainless: 15.6 kg (34.4 lbs)

Sensor

- Sensor with aluminum connection housing version: see the information in the following table
- Cast connection housing version, stainless: +3.7 kg (+8.2 lbs)

Weight in SI units

Nominal diameter		EN (DIN), AS ¹		ASME		JIS	
[mm]	[in]	Pressure rating	[kg]	Pressure rating	[kg]	Pressure rating	[kg]
15	½	PN 40	4.5	Class 150	4.5	10K	4.5
25	1	PN 40	5.3	Class 150	5.3	10K	5.3

Nominal diameter		EN (DIN), AS ¹⁾		ASME		JIS	
[mm]	[in]	Pressure rating	[kg]	Pressure rating	[kg]	Pressure rating	[kg]
32	–	PN 40	6	Class 150	–	10K	5.3
40	1 ½	PN 40	7.4	Class 150	7.4	10K	6.3
50	2	PN 40	8.6	Class 150	8.6	10K	7.3
65	–	PN 16	10	Class 150	–	10K	9.1
80	3	PN 16	12	Class 150	12	10K	10.5
100	4	PN 16	14	Class 150	14	10K	12.7
125	–	PN 16	19.5	Class 150	–	10K	19
150	6	PN 16	23.5	Class 150	23.5	10K	22.5
200	8	PN 10	43	Class 150	43	10K	39.9
250	10	PN 10	63	Class 150	73	10K	67.4
300	12	PN 10	68	Class 150	108	10K	70.3
350	14	PN 10	103	Class 150	173	10K	79
400	16	PN 10	118	Class 150	203	10K	100
450	18	PN 10	159	Class 150	253	10K	128
500	20	PN 10	154	Class 150	283	10K	142
600	24	PN 10	206	Class 150	403	10K	188

1) For flanges to AS, only DN 25 and 50 are available.

Weight in US units

Nominal diameter		ASME	
[mm]	[in]	Pressure rating	[lbs]
15	½	Class 150	9.92
25	1	Class 150	11.7
40	1 ½	Class 150	16.3
50	2	Class 150	19.0
80	3	Class 150	26.5
100	4	Class 150	30.9
150	6	Class 150	51.8
200	8	Class 150	94.8
250	10	Class 150	161.0
300	12	Class 150	238.1
350	14	Class 150	381.5
400	16	Class 150	447.6
450	18	Class 150	557.9
500	20	Class 150	624.0
600	24	Class 150	888.6

Measuring tube specification

Nominal diameter		Pressure rating					Process connection internal diameter			
		EN (DIN)	ASME	AS 2129	AS 4087	JIS	PFA		PTFE	
[mm]	[in]	[bar]	[psi]	[bar]	[bar]	[bar]	[mm]	[in]	[mm]	[in]
15	½	PN 40	Class 150	-	-	20K	-	-	15	0.59
25	1	PN 40	Class 150	Table E	-	20K	23	0.91	26	1.02
32	-	PN 40	-	-	-	20K	32	1.26	35	1.38
40	1 ½	PN 40	Class 150	-	-	20K	36	1.42	41	1.61
50	2	PN 40	Class 150	Table E	PN 16	10K	48	1.89	52	2.05
65	-	PN 16	-	-	-	10K	63	2.48	67	2.64
80	3	PN 16	Class 150	-	-	10K	75	2.95	80	3.15
100	4	PN 16	Class 150	-	-	10K	101	3.98	104	4.09
125	-	PN 16	-	-	-	10K	126	4.96	129	5.08
150	6	PN 16	Class 150	-	-	10K	154	6.06	156	6.14
200	8	PN 10	Class 150	-	-	10K	201	7.91	202	7.95
250	10	PN 10	Class 150	-	-	10K	-	-	256	10.1
300	12	PN 10	Class 150	-	-	10K	-	-	306	12.0
350	14	PN 10	Class 150	-	-	10K	-	-	337	13.3
400	16	PN 10	Class 150	-	-	10K	-	-	387	15.2
450	18	PN 10	Class 150	-	-	10K	-	-	432	17.0
500	20	PN 10	Class 150	-	-	10K	-	-	487	19.2
600	24	PN 10	Class 150	-	-	10K	-	-	593	23.3

Materials

Transmitter housing

Proline 500 – digital transmitter housing

Order code for "Transmitter housing":

- Option **A** "Aluminum coated": aluminum, AlSi10Mg, coated
- Option **D** "Polycarbonate": polycarbonate

Proline 500 transmitter housing

Order code for "Transmitter housing":

- Option **A** "Aluminum coated": aluminum, AlSi10Mg, coated
- Option **L** "Cast, stainless": cast, stainless steel, 1.4409 (CF3M) similar to 316L

Window material

Order code for "Transmitter housing":



- Option **A** "Aluminum, coated": glass
- Option **D** "Polycarbonate": plastic
- Option **L** "Cast, stainless": glass

Sensor connection housing

Order code for "Sensor connection housing":

- Option **A** "Aluminum coated": aluminum, AlSi10Mg, coated
- Option **L** "Cast, stainless": 1.4409 (CF3M) similar to 316L

Cable entries/cable glands

Cable entries and adapters	Material
Cable gland M20 × 1.5	Plastic
<ul style="list-style-type: none"> ▪ Adapter for cable entry with internal thread G ½" ▪ Adapter for cable entry with internal thread NPT ½" <p> Only available for certain device versions:</p> <ul style="list-style-type: none"> ▪ Order code for "Transmitter housing": <ul style="list-style-type: none"> - Option A "Aluminum, coated" - Option D "Polycarbonate" ▪ Order code for "Sensor connection housing": <ul style="list-style-type: none"> - Proline 500 – digital: <ul style="list-style-type: none"> Option A "Aluminum coated" Option L "Cast, stainless" - Proline 500: <ul style="list-style-type: none"> Option A "Aluminum coated" Option L "Cast, stainless" 	Nickel-plated brass
<ul style="list-style-type: none"> ▪ Adapter for cable entry with internal thread G ½" ▪ Adapter for cable entry with internal thread NPT ½" <p> Only available for certain device versions:</p> <ul style="list-style-type: none"> ▪ Order code for "Transmitter housing": <ul style="list-style-type: none"> Option L "Cast, stainless" ▪ Order code for "Sensor connection housing": <ul style="list-style-type: none"> Option L "Cast, stainless" 	Stainless steel, 1.4404 (316L)

Connecting cable

Connecting cable for sensor - Proline 500 – digital transmitter

PVC cable with copper shield

Connecting cable for sensor - Proline 500 transmitter

- Standard cable: PVC cable with copper shield
- Reinforced cable: PVC cable with copper shield and additional steel wire braided jacket

 UV rays can impair the cable outer sheath. Protect the cable from exposure to sun as much as possible.

Sensor housing

- DN 15 to 300 (½ to 12"): coated aluminum AlSi10Mg
- DN 350 to 600 (14 to 24"): carbon steel with protective varnish

Measuring tubes

Stainless steel, 1.4301/304/1.4306/304L; for flanges made of carbon with Al/Zn protective coating (DN 15 to 300 (½ to 12")) or protective varnish (DN 350 to 600 (14 to 24"))

Liner

- PFA
- PTFE

Process connections

EN 1092-1 (DIN 2501)

Stainless steel, 1.4571 (F316L); carbon steel, E250C¹⁾/S235JRG2/P245GH

ASME B16.5

Stainless steel, F316L; carbon steel, A105¹⁾

1) DN 15 to 300 (½ to 12") with Al/Zn protective coating; DN 350 to 600 (14 to 24") with protective varnish

JIS B2220
 Stainless steel, 1.0425 (F316L)¹⁾; carbon steel, A105/A350 LF2
 AS 2129 Table E
 ■ DN 25 (1"): carbon steel, A105/S235JRG2
 ■ DN 40 (1 ½"): carbon steel, A105/S275JR
 AS 4087 PN 16
 Carbon steel, A105/S275JR

Electrodes

Stainless steel, 1.4435 (F316L); Alloy C22, 2.4602 (UNS N06022); platinum; tantalum; titanium

Seals

As per DIN EN 1514-1, form IBC

Accessories

Protective cover

Stainless steel, 1.4404 (316L)

External WLAN antenna

- Antenna: ASA plastic (acrylic ester-styrene-acrylonitrile) and nickel-plated brass
- Adapter: Stainless steel and nickel-plated brass
- Cable: Polyethylene
- Plug: Nickel-plated brass
- Angle bracket: Stainless steel

Ground disks

Stainless steel, 1.4435 (F316L); Alloy C22, 2.4602 (UNS N06022); tantalum; titanium

Fitted electrodes

Measuring electrodes, reference electrodes and electrodes for empty pipe detection:
 ■ Standard: stainless steel, 1.4435 (F316L); Alloy C22, 2.4602 (UNS N06022); tantalum, titanium
 ■ Optional: only platinum measuring electrodes

Surface roughness

Stainless steel electrodes, 1.4435 (F316L); Alloy C22, 2.4602 (UNS N06022); platinum; tantalum; titanium:
 ≤ 0.3 to 0.5 µm (11.8 to 19.7 µin)
 (All data relate to parts in contact with fluid)
 Liner with PFA:
 ≤ 0.4 µm (15.7 µin)
 (All data relate to parts in contact with fluid)

16.11 Operability

Languages

Can be operated in the following languages:



- Via local operation
 - English, German, French, Spanish, Italian, Dutch, Portuguese, Polish, Russian, Turkish, Chinese, Japanese, Korean, Bahasa (Indonesian), Vietnamese, Czech, Swedish
- Via Web browser
 - English, German, French, Spanish, Italian, Dutch, Portuguese, Polish, Russian, Turkish, Chinese, Japanese, Korean, Bahasa (Indonesian), Vietnamese, Czech, Swedish
- Via "FieldCare", "DeviceCare" operating tool: English, German, French, Spanish, Italian, Chinese, Japanese

Local operation

Via display module

Two display modules are available:

- Order code for "Display; operation", option **F** "4-line, illuminated, graphic display; touch control"
- Order code for "Display; operation", option **G** "4-line, illuminated, graphic display; touch control + WLAN"

 Information about WLAN interface →  94

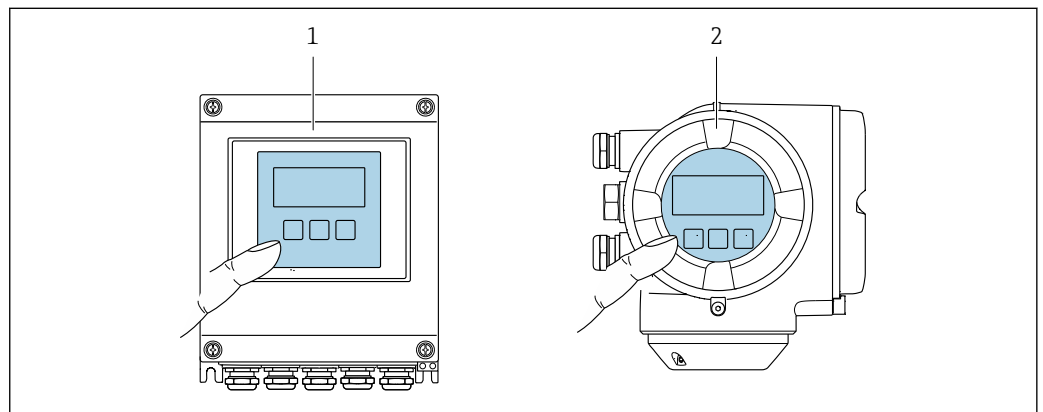



 49 Operation with touch control

- 1 Proline 500 – digital
- 2 Proline 500

Display elements

- 4-line, illuminated, graphic display
- White background lighting; switches to red in event of device errors
- Format for displaying measured variables and status variables can be individually configured
- Permitted ambient temperature for the display: -20 to $+60$ °C (-4 to $+140$ °F)
The readability of the display may be impaired at temperatures outside the temperature range.

Operating elements



- External operation via touch control (3 optical keys) without opening the housing: , , 
- Operating elements also accessible in the various zones of the hazardous area

Remote operation

→  92

Service interface →  93

Supported operating tools Different operating tools can be used for local or remote access to the measuring device. Depending on the operating tool used, access is possible with different operating units and via a variety of interfaces.

Supported operating tools	Operating unit	Interface	Additional information
Web browser	Notebook, PC or tablet with Web browser	<ul style="list-style-type: none"> ■ CDI-RJ45 service interface ■ WLAN interface ■ Ethernet-based fieldbus (EtherNet/IP, PROFINET) 	Special Documentation for device
DeviceCare SFE100	Notebook, PC or tablet with Microsoft Windows system	<ul style="list-style-type: none"> ■ CDI-RJ45 service interface ■ WLAN interface ■ Fieldbus protocol 	→  195
FieldCare SFE500	Notebook, PC or tablet with Microsoft Windows system	<ul style="list-style-type: none"> ■ CDI-RJ45 service interface ■ WLAN interface ■ Fieldbus protocol 	→  195

 Other operating tools based on FDT technology with a device driver such as DTM/iDTM or DD/EDD can be used for device operation. These operating tools are available from the individual manufacturers. Integration into the following operating tools, among others, is supported:

- Field Device Manager (FDM) by Honeywell → www.honeywellprocess.com
- FieldMate by Yokogawa → www.yokogawa.com
- PACTWare → www.pactware.com

The associated device description files are available at: www.endress.com → Downloads

Web server

Thanks to the integrated Web server, the device can be operated and configured via a Web browser and via a service interface (CDI-RJ45) or via a WLAN interface. The structure of the operating menu is the same as for the local display. In addition to the measured values, status information on the device is also displayed and allows the user to monitor the status of the device. Furthermore the device data can be managed and the network parameters can be configured.

A device that has a WLAN interface (can be ordered as an option) is required for the WLAN connection: order code for "Display; operation", option **G** "4-line, illuminated; touch control + WLAN". The device acts as an Access Point and enables communication by computer or a mobile handheld terminal.

Supported functions

Data exchange between the operating unit (such as a notebook for example) and the measuring device:

- Upload the configuration from the measuring device (XML format, configuration backup)
- Save the configuration to the measuring device (XML format, restore configuration)
- Export event list (.csv file)
- Export parameter settings (.csv file or PDF file, document the measuring point configuration)
- Export the Heartbeat verification log (PDF file, only available with the "Heartbeat Verification" application package)

- Flash firmware version for device firmware upgrade, for instance
- Download driver for system integration
- Visualize up to 1000 saved measured values (only available with the **Extended HistoROM** application package →  220)

 Webservice special documentation →  222

HistoROM data management

The measuring device features HistoROM data management. HistoROM data management comprises both the storage and import/export of key device and process data, making operation and servicing far more reliable, secure and efficient.

 When the device is delivered, the factory settings of the configuration data are stored as a backup in the device memory. This memory can be overwritten with an updated data record, for example after commissioning.

Additional information on the data storage concept

There are different types of data storage units in which device data are stored and used by the device:

	Device memory	T-DAT	S-DAT
Available data	<ul style="list-style-type: none"> ▪ Event logbook such as diagnostic events for example ▪ Parameter data record backup ▪ Device firmware package ▪ Driver for system integration for exporting via Web server, e.g.: EDS for EtherNet/IP 	<ul style="list-style-type: none"> ▪ Measured value logging ("Extended HistoROM" order option) ▪ Current parameter data record (used by firmware at run time) ▪ Maximum indicators (min/max values) ▪ Totalizer values 	<ul style="list-style-type: none"> ▪ Sensor data: nominal diameter etc. ▪ Serial number ▪ Calibration data ▪ Device configuration (e.g. SW options, fixed I/O or multi I/O)
Storage location	Fixed on the user interface board in the connection compartment	Attachable to the user interface board in the connection compartment	In the sensor plug in the transmitter neck part

Data backup

Automatic

- The most important device data (sensor and transmitter) are automatically saved in the DAT modules
- If the transmitter or measuring device is replaced: once the T-DAT containing the previous device data has been exchanged, the new measuring device is ready for operation again immediately without any errors
- If the sensor is replaced: once the sensor has been replaced, new sensor data are transferred from the S-DAT in the measuring device and the measuring device is ready for operation again immediately without any errors
- If exchanging the electronics module (e.g. I/O electronics module): Once the electronics module has been replaced, the software of the module is compared against the current device firmware. The module software is upgraded or downgraded where necessary. The electronics module is available for use immediately afterwards and no compatibility problems occur.

Manual

Additional parameter data record (complete parameter settings) in the integrated device memory HistoROM backup for:

- Data backup function
Backup and subsequent restoration of a device configuration in the device memory HistoROM backup
- Data comparison function
Comparison of the current device configuration with the device configuration saved in the device memory HistoROM backup

Data transfer

Manual

- Transfer of a device configuration to another device using the export function of the specific operating tool, e.g. with FieldCare, DeviceCare or Web server: to duplicate the configuration or to store in an archive (e.g. for backup purposes)
- Transmission of the drivers for system integration via Web server, e.g.: EDS for EtherNet/IP

Event list

Automatic

- Chronological display of up to 20 event messages in the events list
- If the **Extended HistoROM** application package (order option) is enabled: up to 100 event messages are displayed in the events list along with a time stamp, plain text description and remedial measures
- The events list can be exported and displayed via a variety of interfaces and operating tools e.g. DeviceCare, FieldCare or Web server

Data logging

Manual

If the **Extended HistoROM** application package (order option) is enabled:

- Record up to 1 000 measured values via 1 to 4 channels
- User configurable recording interval
- Record up to 250 measured values via each of the 4 memory channels
- Export the measured value log via a variety of interfaces and operating tools e.g. FieldCare, DeviceCare or web server



16.12 Certificates and approvals

CE mark	The measuring system is in conformity with the statutory requirements of the applicable EU Directives. These are listed in the corresponding EU Declaration of Conformity along with the standards applied. Endress+Hauser confirms successful testing of the device by affixing to it the CE mark.
---------	--

C-Tick symbol	The measuring system meets the EMC requirements of the "Australian Communications and Media Authority (ACMA)".
---------------	--

Ex approval	The devices are certified for use in hazardous areas and the relevant safety instructions are provided in the separate "Safety Instructions" (XA) document. Reference is made to this document on the nameplate.
-------------	--

Pharmaceutical compatibility	<ul style="list-style-type: none"> ■ FDA ■ USP Class VI ■ TSE/BSE certificate of suitability
------------------------------	---

EtherNet/IP certification	<p>The measuring device is certified and registered by the ODVA (Open Device Vendor Association). The measuring system meets all the requirements of the following specifications:</p> <ul style="list-style-type: none"> ■ Certified in accordance with the ODVA Conformance Test ■ EtherNet/IP Performance Test ■ EtherNet/IP PlugFest compliance ■ The device can also be operated with certified devices of other manufacturers (interoperability)
Radio approval	<p>The measuring device has radio approval.</p> <p> For detailed information on the radio approval, see the Special Documentation</p>
Pressure Equipment Directive	<ul style="list-style-type: none"> ■ With the identification PED/G1/x (x = category) on the sensor nameplate, Endress+Hauser confirms conformity with the "Essential Safety Requirements" specified in Appendix I of the Pressure Equipment Directive 2014/68/EC. ■ Devices not bearing this marking (PED) are designed and manufactured according to good engineering practice. They meet the requirements of Art. 4, Par. 3 of the Pressure Equipment Directive 2014/68/EU. The range of application is indicated in tables 6 to 9 in Annex II of the Pressure Equipment Directive 2014/68/EC.
Measuring instrument approval	<p>The measuring device is qualified to OIML R117 and has an OIML Certificate of Conformity (optional).</p>
Additional certification	<p>PWIS-free</p> <p>PWIS = paint-wetting impairment substances</p> <p>Order code for "Service":</p> <ul style="list-style-type: none"> ■ Option HC: PWIS-free (version A) ■ Option HD: PWIS-free (version B) ■ Option HE: PWIS-free (version C) <p> For more information on PWIS-free certification, see "Test specification" document TS01028D</p>
Other standards and guidelines	<ul style="list-style-type: none"> ■ EN 60529 Degrees of protection provided by enclosures (IP code) ■ EN 61010-1 Safety requirements for electrical equipment for measurement, control and laboratory use - general requirements ■ IEC/EN 61326 Emission in accordance with Class A requirements. Electromagnetic compatibility (EMC requirements). ■ NAMUR NE 21 Electromagnetic compatibility (EMC) of industrial process and laboratory control equipment ■ NAMUR NE 32 Data retention in the event of a power failure in field and control instruments with microprocessors ■ NAMUR NE 43 Standardization of the signal level for the breakdown information of digital transmitters with analog output signal. ■ NAMUR NE 53 Software of field devices and signal-processing devices with digital electronics

- NAMUR NE 105
Specifications for integrating fieldbus devices in engineering tools for field devices
- NAMUR NE 107
Self-monitoring and diagnosis of field devices
- NAMUR NE 131
Requirements for field devices for standard applications

16.13 Application packages

Many different application packages are available to enhance the functionality of the device. Such packages might be needed to address safety aspects or specific application requirements.

The application packages can be ordered with the device or subsequently from Endress+Hauser. Detailed information on the order code in question is available from your local Endress+Hauser sales center or on the product page of the Endress+Hauser website: www.endress.com.

Diagnostics functions

Package	Description
Extended HistoROM	<p>Comprises extended functions concerning the event log and the activation of the measured value memory.</p> <p>Event log: Memory volume is extended from 20 message entries (standard version) to up to 100 entries.</p> <p>Data logging (line recorder):</p> <ul style="list-style-type: none"> ■ Memory capacity for up to 1000 measured values is activated. ■ 250 measured values can be output via each of the 4 memory channels. The recording interval can be defined and configured by the user. ■ Measured value logs can be accessed via the local display or operating tool e.g. FieldCare, DeviceCare or Web server.



Heartbeat Technology

Package	Description
Heartbeat Verification +Monitoring	<p>Heartbeat Verification Meets the requirement for traceable verification to DIN ISO 9001:2008 Chapter 7.6 a) "Control of monitoring and measuring equipment".</p> <ul style="list-style-type: none"> ■ Functional testing in the installed state without interrupting the process. ■ Traceable verification results on request, including a report. ■ Simple testing process via local operation or other operating interfaces. ■ Clear measuring point assessment (pass/fail) with high test coverage within the framework of manufacturer specifications. ■ Extension of calibration intervals according to operator's risk assessment. <p>Heartbeat Monitoring Continuously supplies data, which are characteristic of the measuring principle, to an external condition monitoring system for the purpose of preventive maintenance or process analysis. These data enable the operator to:</p> <ul style="list-style-type: none"> ■ Draw conclusions - using these data and other information - about the impact process influences (such as corrosion, abrasion, buildup etc.) have on the measuring performance over time. ■ Schedule servicing in time. ■ Monitor the process or product quality, e.g. gas pockets.

Cleaning

Package	Description
Electrode cleaning circuit (ECC)	<p>The electrode cleaning circuit (ECC) function has been developed to have a solution for applications where magnetite (Fe₃O₄) deposits frequently occur (e.g. hot water). Since magnetite is highly conductive this build up leads to measuring errors and ultimately to the loss of signal. The application package is designed to AVOID build up of highly conductive matter and thin layers (typical of magnetite).</p>

16.14 Accessories

 Overview of accessories available for order →  193

16.15 Supplementary documentation

 For an overview of the scope of the associated Technical Documentation, refer to the following:

- The *W@M Device Viewer* : Enter the serial number from the nameplate (www.endress.com/deviceviewer)
- The *Endress+Hauser Operations App*: Enter the serial number from the nameplate or scan the 2-D matrix code (QR code) on the nameplate.

Standard documentation **Brief Operating Instructions**

Brief Operating Instructions for the sensor

Measuring device	Documentation code
Proline Promag P	KA01290D

Brief Operating Instructions for transmitter

Measuring device	Documentation code
Proline 500 – digital	KA01343D
Proline 500	KA01342D

Technical Information

Measuring device	Documentation code
Promag P 500	TI01226D

Description of device parameters

Measuring device	Documentation code
Promag 500	GP01118D

Device-dependent
additional documentation

Safety instructions

Safety instructions for electrical equipment for hazardous areas.



Contents	Documentation code
ATEX/IECEX Ex i	XA01522D
ATEX/IECEX Ex ec	XA01523D
cCSAus IS	XA01524D
cCSAus Ex e ia/Ex d ia	XA01525D
cCSAus Ex nA	XA01526D
INMETRO Ex i	XA01527D
INMETRO Ex ec	XA01528D
NEPSI Ex i	XA01529D
NEPSI Ex nA	XA01530D

Special Documentation

Contents	Documentation code
Information on the Pressure Equipment Directive	SD01614D
Radio approvals for WLAN interface for A309/A310 display module	SD01793D

Contents	Documentation code
Heartbeat Technology	SD01981D
Web server	SD01978D

Installation Instructions

Contents	Comment
Installation instructions for spare part sets and accessories	<ul style="list-style-type: none"> ▪ Access the overview of all the available spare part sets via <i>W@M Device Viewer</i> →  191 ▪ Accessories available for order with Installation Instructions →  193

Index

A

- Access authorization to parameters
 - Read access 83
 - Write access 83
- Access code 83
 - Incorrect input 83
- Adapters 27
- Adapting the diagnostic behavior 171
- Additional certification 219
- Ambient temperature
 - Influence 205
- Ambient temperature range 26
- Application 196
- Applicator 196
- Approvals 218

C

- C-Tick symbol 218
- Cable entries
 - Technical data 204
- Cable entry
 - Degree of protection 70
- CE mark 10, 218
- Certificates 218
- Checklist
 - Post-connection check 70
 - Post-installation check 37
- Cleaning
 - Exterior cleaning 190
 - Interior cleaning 190
- Commissioning 109
 - Advanced settings 131
 - Configuring the measuring device 110
- Conductivity 207
- Connecting cable 38
- Connecting the connecting cable
 - Proline 500 – digital transmitter 48
 - Proline 500 terminal assignment 54
 - Proline 500 transmitter 56
 - Sensor connection housing, Proline 500 54
 - Sensor connection housing, Proline 500 - digital 46
 - Terminal assignment of Proline 500 - digital 46
- Connecting the measuring device
 - Proline 500 54
 - Proline 500 – digital 46
- Connecting the signal cable/supply voltage cable
 - Proline 500 – digital transmitter 49
- Connecting the signal cables 57
- Connecting the supply voltage cables 57
- Connection
 - see Electrical connection
- Connection examples, potential equalization 62
- Connection preparations 42
- Connection tools 38
- Context menu
 - Calling up 79

- Closing 79
- Explanation 79
- Current consumption 204
- Cyclic data transmission 99

D

- Declaration of Conformity 10
- Define access code 146, 147
- Degree of protection 70, 206
- Designated use 9
- Device components 14
- Device description files 98
- Device documentation
 - Supplementary documentation 8
- Device locking, status 150
- Device name
 - Sensor 19
 - Transmitter 17
- Device repair 191
- Device revision 98
- Device type ID 98
- DeviceCare 97
 - Device description file 98
- Diagnostic behavior
 - Explanation 167
 - Symbols 167
- Diagnostic information
 - Communication interface 171
 - Design, description 167, 170
 - DeviceCare 169
 - FieldCare 169
 - Light emitting diodes 163
 - Onsite display 166
 - Overview 172
 - Remedial measures 172
 - Web browser 168
- Diagnostic list 185
- Diagnostic message 166
- Diagnostics
 - Symbols 166
- DIP switch
 - see Write protection switch
- Direct access 81
- Direct access code 76
- Disabling write protection 146
- Display
 - see Onsite display
- Display area
 - For operational display 74
 - In the navigation view 76
- Display values
 - For locking status 150
- Disposal 192
- Document
 - Function 6
 - Symbols used 6

- Document function 6
- Down pipe 23
- E**
- ECC 137
- Editing view 77
 - Input screen 78
 - Using operating elements 78
- Electrical connection
 - Degree of protection 70
 - Measuring device 38
 - Operating tools
 - Via Ethernet network 92
 - Via service interface (CDI-RJ45) 93
 - Via WLAN interface 94
 - RSLogix 5000 92
 - Web server 93
 - WLAN interface 94
- Electromagnetic compatibility 206
- Electronics module 14
- Enabling write protection 146
- Enabling/disabling the keypad lock 84
- Endress+Hauser services
 - Maintenance 190
 - Repair 191
- Environment
 - Ambient temperature range 26
 - Impact resistance 206
 - Mechanical load 206
 - Shock resistance 206
 - Storage temperature 206
 - Vibration resistance 206
- Error messages
 - see Diagnostic messages
- EtherNet/IP
 - Diagnostic information 171
- EtherNet/IP certification 219
- Event list 185
- Event logbook 185
- Ex approval 218
- Extended order code
 - Sensor 19
 - Transmitter 17
- Exterior cleaning 190
- F**
- FDA 218
- Field of application
 - Residual risks 10
- FieldCare 96
 - Device description file 98
 - Establishing a connection 96
 - Function 96
 - User interface 97
- Filtering the event logbook 186
- Firmware
 - Release date 98
 - Version 98
- Firmware history 189
- Fitted electrodes 214
- Fix assembly 171
- Flow direction 24
- Flow limit 209
- Function check 109
- Functions
 - see Parameter
- G**
- Galvanic isolation 203
- H**
- Hardware write protection 147
- Heavy sensors 24
- Help text
 - Calling up 82
 - Closing 82
 - Explanation 82
- HistoROM 140
- I**
- Identifying the measuring device 16
- Impact resistance 206
- Incoming acceptance 16
- Influence
 - Ambient temperature 205
- Information on the document 6
- Inlet runs 25
- Input 196
- Inspection
 - Installation 37
 - Received goods 16
- Inspection check
 - Connection 70
- Installation 23
- Installation conditions
 - Adapters 27
 - Down pipe 23
 - Heavy sensors 24
 - Inlet and outlet runs 25
 - Installation dimensions 25
 - Mounting location 23
 - Orientation 24
 - Partially filled pipe 23
 - System pressure 26
 - Thermal insulation 27
 - Vibrations 26
- Installation dimensions 25
- Interior cleaning 190
- L**
- Languages, operation options 215
- Line recorder 157
- Local display
 - Navigation view 75
 - see Operational display
- Low flow cut off 203
- M**
- Main electronics module 14

- Maintenance tasks 190
 - Replacing seals 190
 - Managing the device configuration 140
 - Manufacturer ID 98
 - Manufacturing date 17, 19
 - Materials 212
 - Maximum measured error 204
 - Measured values
 - Calculated 196
 - Measured 196
 - see Process variables
 - Measuring and test equipment 190
 - Measuring device
 - Configuration 110
 - Conversion 191
 - Disposal 192
 - Integrating via communication protocol 98
 - Mounting the sensor 29
 - Mounting the ground cable/ground disks 29
 - Mounting the seals 29
 - Screw tightening torques 30
 - Preparing for electrical connection 42
 - Preparing for mounting 29
 - Removing 192
 - Repairs 191
 - Structure 14
 - Switch-on 109
 - Measuring instrument approval 219
 - Measuring principle 196
 - Measuring range 196
 - Measuring system 196
 - Measuring tube specification 212
 - Mechanical load 206
 - Medium temperature range 206
 - Menu
 - Diagnostics 184
 - Setup 110, 111
 - Menus
 - For measuring device configuration 110
 - For specific settings 131
 - Mounting dimensions
 - see Installation dimensions
 - Mounting location 23
 - Mounting preparations 29
 - Mounting tools 28
- N**
- Nameplate
 - Sensor 19
 - Transmitter 17
 - Navigation path (navigation view) 75
 - Navigation view
 - In the submenu 75
 - In the wizard 75
 - Numeric editor 77
- O**
- Onsite display 215
 - Numeric editor 77
 - see Diagnostic message
 - see In alarm condition
 - Text editor 77
 - Operable flow range 197
 - Operating elements 79, 167
 - Operating keys
 - see Operating elements
 - Operating menu
 - Menus, submenus 72
 - Structure 72
 - Submenus and user roles 73
 - Operating philosophy 73
 - Operation 150
 - Operation options 71
 - Operational display 74
 - Operational safety 10
 - Order code 17, 19
 - Orientation (vertical, horizontal) 24
 - Outlet runs 25
 - Output 199
 - Output signal 199
- P**
- Packaging disposal 22
 - Parameter
 - Changing 82
 - Entering values or text 82
 - Parameter settings
 - Administration (Submenu) 143
 - Advanced setup (Submenu) 132
 - Communication (Submenu) 113
 - Configuration backup (Submenu) 140
 - Current input 115
 - Current input (Wizard) 115
 - Current input 1 to n (Submenu) 153
 - Current output 116
 - Current output (Wizard) 116
 - Data logging (Submenu) 157
 - Define access code (Wizard) 142
 - Device information (Submenu) 188
 - Diagnostics (Menu) 184
 - Display (Submenu) 134
 - Display (Wizard) 126
 - Electrode cleaning circuit (Submenu) 137
 - Empty pipe detection (Wizard) 130
 - I/O configuration 114
 - I/O configuration (Submenu) 114
 - Low flow cut off (Wizard) 129
 - Process variables (Submenu) 151
 - Pulse/frequency/switch output 119
 - Pulse/frequency/switch output (Wizard) 119, 120, 123
 - Pulse/frequency/switch output 1 to n (Submenu) 154
 - Relay output 125
 - Relay output 1 to n (Submenu) 155
 - Relay output 1 to n (Wizard) 125
 - Reset access code (Submenu) 143
 - Sensor adjustment (Submenu) 132
 - Setup (Menu) 111

- Simulation (Submenu) 143
- Status input 116
- Status input (Submenu) 116
- Status input 1 to n (Submenu) 153
- System units (Submenu) 111
- Totalizer (Submenu) 152
- Totalizer 1 to n (Submenu) 132
- Totalizer handling (Submenu) 156
- Value current output 1 to n (Submenu) 154
- Web server (Submenu) 91
- WLAN settings (Wizard) 138
- Partially filled pipe 23
- Performance characteristics 204
- Pharmaceutical compatibility 218
- Post-connection check (checklist) 70
- Post-installation check 109
- Post-installation check (checklist) 37
- Potential equalization 61
- Power consumption 204
- Power supply failure 204
- Pressure Equipment Directive 219
- Pressure loss 209
- Pressure tightness 208
- Pressure-temperature ratings 208
- Process conditions
 - Conductivity 207
 - Flow limit 209
 - Fluid temperature 206
 - Pressure loss 209
 - Pressure tightness 208
- Product safety 10
- Proline 500 – digital transmitter
 - Connecting the signal cable/supply voltage cable 49
- Proline 500 connecting cable terminal assignment
 - Sensor connection housing 54
- Protecting parameter settings 146
- R**
- Radio approval 219
- Read access 83
- Reading measured values 150
- Reading out diagnostic information, EtherNet/IP 171
- Recalibration 190
- Reference operating conditions 204
- Registered trademarks 8
- Remedial measures
 - Calling up 168
 - Closing 168
- Remote operation 215
- Repair of a device 191
- Repairs 191
 - Notes 191
- Repeatability 205
- Replacement
 - Device components 191
- Replacing seals 190
- Requirements for personnel 9
- Return 191
- S**
- Safety 9
- Screw tightening torques 30
- Sensor
 - Mounting 29
- Serial number 17, 19
- Setting the operating language 109
- Settings
 - Adapting the measuring device to the process conditions 156
 - Administration 141
 - Advanced display configurations 134
 - Communication interface 113
 - Current input 115
 - Current output 116
 - Device reset 187
 - Device tag 111
 - Electrode cleaning circuit (ECC) 137
 - Empty pipe detection (EPD) 130
 - I/O configuration 114
 - Low flow cut off 129
 - Managing the device configuration 140
 - Onsite display 126
 - Operating language 109
 - Pulse output 119
 - Pulse/frequency/switch output 119, 120
 - Relay output 125
 - Resetting the totalizer 156
 - Sensor adjustment 132
 - Simulation 143
 - Status input 116
 - Switch output 123
 - System units 111
 - Totalizer 132
 - Totalizer reset 156
 - WLAN 138
- Shock resistance 206
- Showing data logging 157
- Signal on alarm 201
- Software release 98
- Spare part 191
- Spare parts 191
- Special connection instructions 64
- Standards and guidelines 219
- Status area
 - For operational display 74
 - In the navigation view 76
- Status signals 166, 169
- Storage conditions 21
- Storage temperature 21
- Storage temperature range 206
- Structure
 - Measuring device 14
 - Operating menu 72
- Submenu
 - Administration 141, 143
 - Advanced setup 131, 132
 - Communication 113
 - Configuration backup 140

- Current input 1 to n 153
 - Data logging 157
 - Device information 188
 - Display 134
 - Electrode cleaning circuit 137
 - Event list 185
 - I/O configuration 114
 - Input values 152
 - Measured values 150
 - Output values 154
 - Overview 73
 - Process variables 151
 - Pulse/frequency/switch output 1 to n 154
 - Relay output 1 to n 155
 - Reset access code 143
 - Sensor adjustment 132
 - Simulation 143
 - Status input 116
 - Status input 1 to n 153
 - System units 111
 - Totalizer 152
 - Totalizer 1 to n 132
 - Totalizer handling 156
 - Value current output 1 to n 154
 - Web server 91
 - Supplementary documentation 221
 - Supply voltage 204
 - Surface roughness 214
 - Switch output 200
 - Symbols
 - Controlling data entries 78
 - For communication 74
 - For diagnostic behavior 74
 - For locking 74
 - For measured variable 74
 - For measurement channel number 74
 - For menus 76
 - For parameters 76
 - For status signal 74
 - For submenu 76
 - For wizard 76
 - In the status area of the local display 74
 - Input screen 78
 - Operating elements 78
 - System design
 - Measuring system 196
 - see Measuring device design
 - System file
 - Release date 98
 - Source 98
 - Version 98
 - System integration 98
 - System pressure 26
- T**
- Technical data, overview 196
 - Temperature range
 - Ambient temperature range for display 215
 - Storage temperature 21
 - Terminal assignment 41
 - Terminal assignment of connecting cable for Proline 500- digital
 - Sensor connection housing 46
 - terminals 204
 - Text editor 77
 - Thermal insulation 27
 - Tool tip
 - see Help text
 - Tools
 - Electrical connection 38
 - For mounting 28
 - Transport 21
 - Totalizer
 - Configuration 132
 - Transmitter
 - Turning the display module 37
 - Turning the housing 36
 - Transporting the measuring device 21
 - Troubleshooting
 - General 160
 - TSE/BSE certificate of suitability 218
 - Turning the display module 37
 - Turning the electronics housing
 - see Turning the transmitter housing
 - Turning the transmitter housing 36
- U**
- Use of the measuring device
 - Borderline cases 9
 - Incorrect use 9
 - see Designated use
 - User interface
 - Current diagnostic event 184
 - Previous diagnostic event 184
 - User roles 73
 - USP Class VI 218
- V**
- Version data for the device 98
 - Vibration resistance 206
 - Vibrations 26
- W**
- W@M 190, 191
 - W@M Device Viewer 16, 191
 - Weight
 - Transport (notes) 21
 - Wizard
 - Current input 115
 - Current output 116
 - Define access code 142
 - Display 126
 - Empty pipe detection 130
 - Low flow cut off 129
 - Pulse/frequency/switch output 119, 120, 123
 - Relay output 1 to n 125
 - WLAN settings 138
 - WLAN settings 138

Workplace safety	10
Write access	83
Write protection	
Via access code	146
Via write protection switch	147
Write protection switch	147

www.addresses.endress.com
