

Operating Instructions

Micropilot FMR67

HART

Free space radar

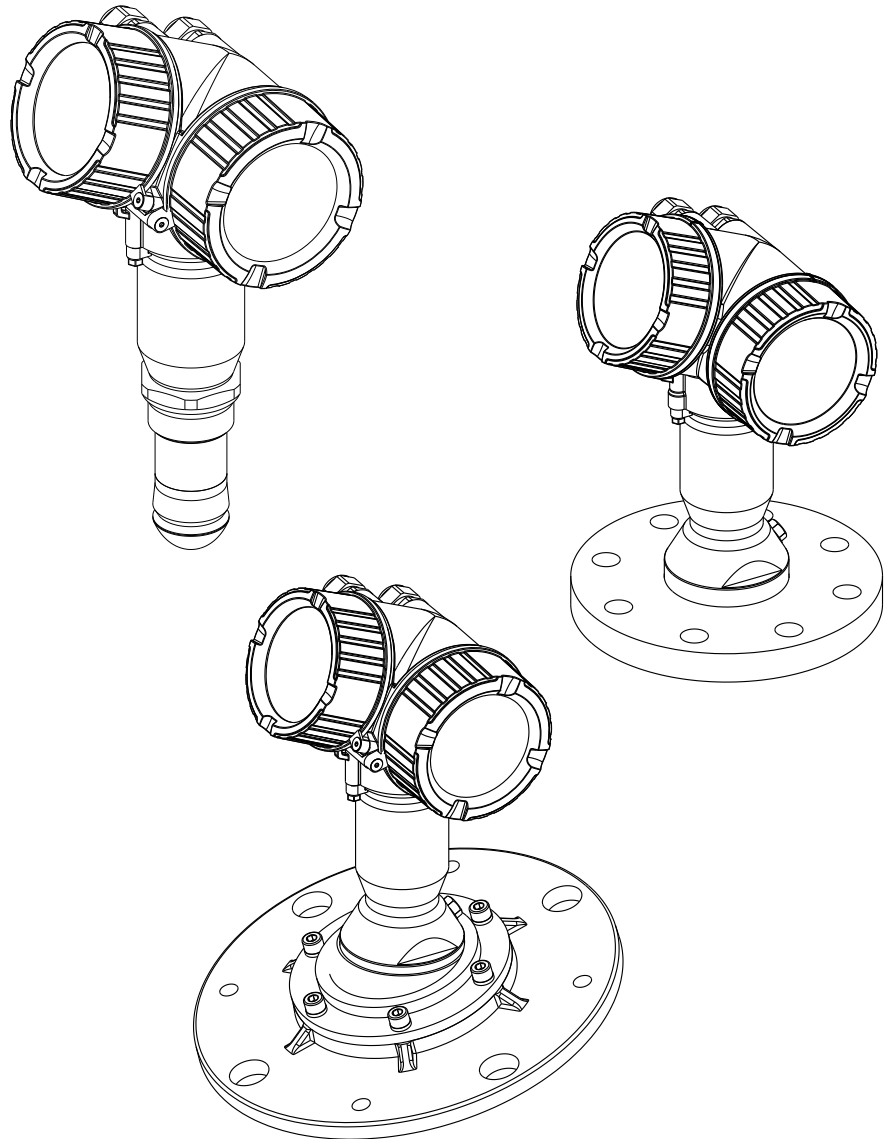

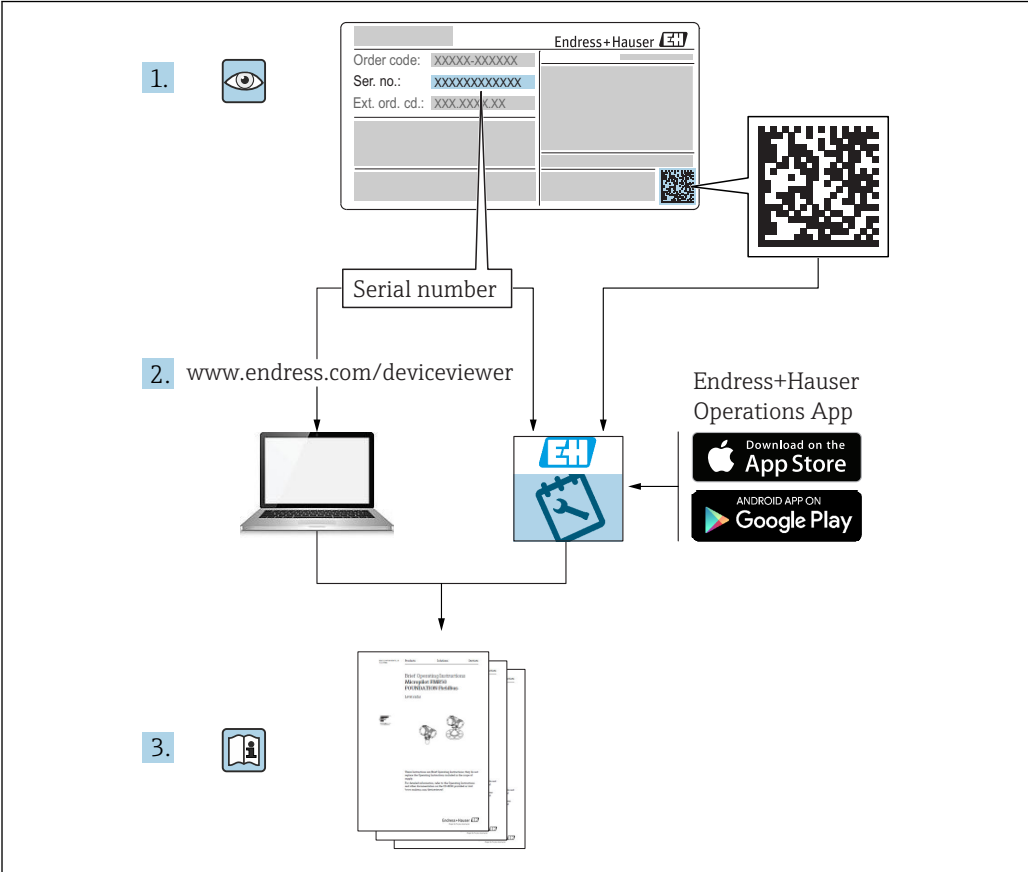

A0023555

Table of contents

1	Important document information	5		
1.1	Document function	5		
1.2	Symbols	5		
1.2.1	Safety symbols	5		
1.2.2	Electrical symbols	5		
1.2.3	Tool symbols	5		
1.2.4	Symbols for certain types of information	6		
1.2.5	Symbols in graphics	6		
1.2.6	Symbols at the device	7		
1.3	Documentation	7		
1.4	Terms and abbreviations	8		
1.5	Registered trademarks	9		
2	Basic safety instructions	10		
2.1	Requirements for the personnel	10		
2.2	Designated use	10		
2.3	Workplace safety	11		
2.4	Operational safety	11		
2.5	Product safety	11		
2.5.1	CE mark	11		
2.5.2	EAC conformity	11		
2.6	Safety Instructions (XA)	12		
3	Product description	14		
3.1	Product design	14		
3.1.1	Micropilot FMR67	14		
3.1.2	Electronics housing	15		
4	Incoming acceptance and product identification	16		
4.1	Incoming acceptance	16		
4.2	Product identification	16		
4.2.1	Nameplate	17		
5	Storage, Transport	18		
5.1	Storage conditions	18		
5.2	Transporting the product to the measuring point	18		
6	Installation	19		
6.1	Installation conditions	19		
6.1.1	Orientation - Solid media	19		
6.1.2	Optimization options	21		
6.1.3	Beam angle	22		
6.1.4	External measurement through plastic cover or dielectric windows	23		
6.2	Installation: Drip-off antenna, PTFE 50 mm / 2"	24		
6.2.1	FMR67 - Aligning the antenna axis	24		
6.2.2	Radial alignment of the antenna	24		
6.2.3	Information concerning nozzles	24		
6.2.4	Information concerning threaded connections	25		
6.3	Installation: FMR67 - Flush-mounted antenna	25		
6.3.1	Aligning the antenna axis	25		
6.3.2	Radial alignment of the antenna	26		
6.3.3	Information concerning nozzles	26		
6.4	FMR67 - Purge air connection	27		
6.4.1	Purge air adapter for drip-off antennas	27		
6.4.2	Integrated purge air connection for flush-mounted antennas	27		
6.4.3	Use	28		
6.5	Container with heat insulation	28		
6.6	Turning the transmitter housing	29		
6.7	Turning the display	29		
6.7.1	Opening cover	29		
6.7.2	Turning the display module	30		
6.7.3	Closing electronics compartment cover	30		
6.8	Post-installation check	30		
7	Electrical connection	31		
7.1	Connection conditions	31		
7.1.1	Terminal assignment	31		
7.1.2	Cable specification	34		
7.1.3	Device plug connectors	35		
7.1.4	Supply voltage	36		
7.1.5	Overvoltage protection	37		
7.1.6	Connecting the measuring device	38		
7.1.7	Post-connection check	40		
8	Operation options	41		
8.1	Overview	41		
8.1.1	Local operation	41		
8.1.2	Operation with remote display and operating module FHX50	42		
8.1.3	Operation via Bluetooth® wireless technology	43		
8.1.4	Remote operation	44		
8.2	Structure and function of the operating menu	45		
8.2.1	Structure of the operating menu	45		
8.2.2	User roles and related access authorization	47		
8.2.3	Data access - Security	47		
8.3	Display and operating module	52		
8.3.1	Display appearance	52		
8.3.2	Operating elements	55		
8.3.3	Entering numbers and text	56		
8.3.4	Opening the context menu	58		
8.3.5	Envelope curve on the display and operating module	59		

9	System integration via HART protocol	60	15	Repairs	86
9.1	Overview of the Device Description files (DD)	60	15.1	General information on repairs	86
9.2	Measured values via HART protocol	60	15.1.1	Repair concept	86
10	Commissioning via SmartBlue (app)	61	15.1.2	Repairs to Ex-approved devices	86
10.1	Requirements	61	15.1.3	Replacement of an electronics module	86
10.2	Commissioning	61	15.1.4	Replacement of a device	86
11	Commissioning via wizard	65	15.2	Spare parts	87
12	Commissioning via operating menu	66	15.3	Return	87
12.1	Installation and function check	66	15.4	Disposal	87
12.2	Setting the operating language	66	16	Accessories	88
12.3	Configuration of a level measurement	67	16.1	Device-specific accessories	88
12.4	Recording the reference curve	69	16.1.1	Weather protection cover	88
12.5	Configuration of the on-site display	70	16.1.2	Adjustable flange seal	89
12.5.1	Factory settings of the on-site display	70	16.1.3	Mounting bracket adjustable	91
12.5.2	Adjustment of the on-site display	70	16.1.4	Remote display FHX50	92
12.6	Configuration of the current outputs	70	16.1.5	Overvoltage protection	93
12.6.1	Factory setting of the current outputs	70	16.1.6	Bluetooth module for HART devices	94
12.6.2	Adjustment of the current outputs	70	16.2	Communication-specific accessories	95
12.7	Configuration management	71	16.3	Service-specific accessories	96
12.8	Protection of the settings against unauthorized changes	72	16.4	System components	97
13	Diagnostics and troubleshooting	73	17	Operating menu	98
13.1	General trouble shooting	73	17.1	Overview of the operating menu (SmartBlue)	98
13.1.1	General errors	73	17.2	Overview of the operating menu (display module)	103
13.1.2	Error - SmartBlue operation	74	17.3	Overview of the operating menu (operating tool)	109
13.1.3	Parametrization errors	74	17.4	"Setup" menu	115
13.2	Diagnostic information on local display	76	17.4.1	"Mapping" wizard	122
13.2.1	Diagnostic message	76	17.4.2	"Advanced setup" submenu	124
13.2.2	Calling up remedial measures	78	17.5	"Diagnostics" menu	168
13.3	Diagnostic event in the operating tool	79	17.5.1	"Diagnostic list" submenu	170
13.4	Diagnostic list	80	17.5.2	"Event logbook" submenu	171
13.5	Overview of diagnostic events	81	17.5.3	"Device information" submenu	172
13.6	Event logbook	82	17.5.4	"Measured values" submenu	175
13.6.1	Event history	82	17.5.5	"Data logging" submenu	177
13.6.2	Filtering the event logbook	83	17.5.6	"Simulation" submenu	180
13.6.3	Overview of information events	83	17.5.7	"Device check" submenu	185
13.7	Firmware history	84	17.5.8	"Heartbeat" submenu	186
14	Maintenance	85	Index		187
14.1	Exterior cleaning	85			
14.2	Replacing seals	85			





1 Important document information

1.1 Document function





These Operating Instructions contain all the information that is required in various phases of the life cycle of the device: from product identification, incoming acceptance and storage, to mounting, connection, operation and commissioning through to troubleshooting, maintenance and disposal.

1.2 Symbols



1.2.1 Safety symbols



Symbol	Meaning
	DANGER! This symbol alerts you to a dangerous situation. Failure to avoid this situation will result in serious or fatal injury.
	WARNING! This symbol alerts you to a dangerous situation. Failure to avoid this situation can result in serious or fatal injury.
	CAUTION! This symbol alerts you to a dangerous situation. Failure to avoid this situation can result in minor or medium injury.
	NOTE! This symbol contains information on procedures and other facts which do not result in personal injury.

1.2.2 Electrical symbols





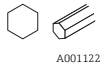







Symbol	Meaning
	Direct current
	Alternating current
	Direct current and alternating current
	Ground connection A grounded terminal which, as far as the operator is concerned, is grounded via a grounding system.
	Protective Earth (PE) A terminal which must be connected to ground prior to establishing any other connections. The ground terminals are situated inside and outside the device: <ul style="list-style-type: none"> ▪ Inner ground terminal: Connects the protective earth to the mains supply. ▪ Outer ground terminal: Connects the device to the plant grounding system.

1.2.3 Tool symbols

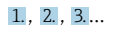

Symbol	Meaning
	Torx screwdriver
	Flat blade screwdriver

Symbol	Meaning
 A0011219	Cross-head screwdriver
 A0011221	Allen key
 A0011222	Hexagon wrench

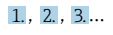

1.2.4 Symbols for certain types of information

Symbol	Meaning
	Permitted Procedures, processes or actions that are permitted.
	Preferred Procedures, processes or actions that are preferred.
	Forbidden Procedures, processes or actions that are forbidden.
	Tip Indicates additional information.
	Reference to documentation.
	Reference to page.
	Reference to graphic.
	Notice or individual step to be observed.
	Series of steps.
	Result of a step.
	Help in the event of a problem.
	Visual inspection.

1.2.5 Symbols in graphics

Symbol	Meaning
1, 2, 3 ...	Item numbers
	Series of steps
A, B, C, ...	Views
A-A, B-B, C-C, ...	Sections
	Hazardous area Indicates a hazardous area.
	Safe area (non-hazardous area) Indicates the non-hazardous area.

1.2.6 Symbols at the device

Symbol	Meaning
	Safety instructions Observe the safety instructions contained in the associated Operating Instructions.
	Temperature resistance of the connection cables Specifies the minimum value of the temperature resistance of the connection cables.

1.3 Documentation

Document	Purpose and content of the document
Technical Information TI01304F	Planning aid for your device The document contains all the technical data on the device and provides an overview of the accessories and other products that can be ordered for the device.
Brief Operating Instructions KA01253F	Guide that takes you quickly to the 1st measured value The Brief Operating Instructions contain all the essential information from incoming acceptance to initial commissioning.
Description of Device Parameters GP01101F	Reference for your parameters The document provides a detailed explanation of each individual parameter in the operating menu. The description is aimed at those who work with the device over the entire life cycle and perform specific configurations.
Special Documentation SD01087F	Functional Safety Manual The document is part of the Operating Instructions and serves as a reference for application-specific parameters and notes.
Special Documentation SD01870F	Manual for Heartbeat Verification and Heartbeat Monitoring The document contains a description of the additional parameters and technical data that are available with the Heartbeat Verification and Heartbeat Monitoring application packages.

-  For an overview of the scope of the associated Technical Documentation, refer to the following:
- The *W@M Device Viewer*: enter the serial number from the nameplate (www.endress.com/deviceviewer)
 - The *Endress+Hauser Operations App*: Enter the serial number from the nameplate or scan the 2-D matrix code (QR code) on the nameplate.

1.4 Terms and abbreviations

Term/abbreviation	Explanation
BA	Document type "Operating Instructions"
KA	Document type "Brief Operating Instructions"
TI	Document type "Technical Information"
SD	Document type "Special Documentation"
XA	Document type "Safety Instructions"
PN	Nominal pressure
MWP	Maximum Working Pressure The MWP can also be found on the nameplate.
ToF	Time of Flight
FieldCare	Scalable software tool for device configuration and integrated plant asset management solutions
DeviceCare	Universal configuration software for Endress+Hauser HART, PROFIBUS, FOUNDATION Fieldbus and Ethernet field devices
DTM	Device Type Manager
DD	Device Description for HART communication protocol
ϵ_r (DC value)	Relative dielectric constant
Operating tool	The term "operating tool" is used in place of the following operating software: <ul style="list-style-type: none"> ▪ FieldCare / DeviceCare, for operation via HART communication and PC ▪ SmartBlue (app), for operation using an Android or iOS smartphone or tablet.
BD	Blocking Distance; no signals are analyzed within the BD.
PLC	Programmable Logic Controller
CDI	Common Data Interface
PFS	Pulse Frequency Status (Switching output)

1.5 Registered trademarks

HART®

Registered trademark of the HART Communication Foundation, Austin, USA

Bluetooth®

The Bluetooth® word mark and logos are registered trademarks owned by the Bluetooth SIG, Inc. and any use of such marks by Endress+Hauser is under license. Other trademarks and trade names are those of their respective owners.

Apple®

Apple, the Apple logo, iPhone, and iPod touch are trademarks of Apple Inc., registered in the U.S. and other countries. App Store is a service mark of Apple Inc.

Android®

Android, Google Play and the Google Play logo are trademarks of Google Inc.

KALREZ®, VITON®

Registered trademark of DuPont Performance Elastomers L.L.C., Wilmington, USA

TEFLON®

Registered trademark of E.I. DuPont de Nemours & Co., Wilmington, USA

2 Basic safety instructions

2.1 Requirements for the personnel

The personnel for installation, commissioning, diagnostics and maintenance must fulfill the following requirements:

- ▶ Trained, qualified specialists must have a relevant qualification for this specific function and task.
- ▶ Are authorized by the plant owner/operator.
- ▶ Are familiar with federal/national regulations.
- ▶ Before starting work, read and understand the instructions in the manual and supplementary documentation as well as the certificates (depending on the application).
- ▶ Follow instructions and comply with basic conditions.

The operating personnel must fulfill the following requirements:

- ▶ Are instructed and authorized according to the requirements of the task by the facility's owner-operator.
- ▶ Follow the instructions in this manual.

2.2 Designated use

Application and media

The measuring device described in these Operating Instructions is intended for continuous, non-contact level measurement primarily in bulk solids. Because of its operating frequency of approx. 80 GHz, a maximum radiated peak power of 6.3 mW and an average power output of 63 μ W, unrestricted use outside of closed, metallic vessels is also permitted (for example over heaps). Operation does not pose any danger whatsoever to humans and animals.

If the limit values specified in the "Technical data" and the conditions listed in the instructions and additional documentation are observed, the measuring device may be used for the following measurements only:

- ▶ Measured process variables: level, distance, signal strength
- ▶ Calculable process variables: volume or mass in any shape of vessel

To ensure that the measuring device remains in proper condition for the operation time:

- ▶ Use the measuring device only for media against which the process-wetted materials are adequately resistant.
- ▶ Observe the limit values in "Technical data".

Incorrect use

The manufacturer is not liable for damage caused by improper or non-designated use.

Verification for borderline cases:

- ▶ For special fluids and fluids for cleaning, Endress+Hauser is glad to provide assistance in verifying the corrosion resistance of fluid-wetted materials, but does not accept any warranty or liability.

Residual risks

Due to heat transfer from the process as well as power loss in the electronics, the temperature of the electronics housing and the assemblies it contains (e.g. display module, main electronics module and I/O electronics module) may rise to 80 °C (176 °F). When in operation, the sensor may reach a temperature close to the medium temperature.

Danger of burns from contact with surfaces!

- ▶ For elevated fluid temperature, ensure protection against contact to prevent burns.

2.3 Workplace safety

For work on and with the device:

- ▶ Wear the required personal protective equipment according to federal/national regulations.

2.4 Operational safety

Risk of injury.

- ▶ Operate the device in proper technical condition and fail-safe condition only.
- ▶ The operator is responsible for interference-free operation of the device.

Conversions to the device

Unauthorized modifications to the device are not permitted and can lead to unforeseeable dangers.

- ▶ If, despite this, modifications are required, consult with the manufacturer.

Repair

To ensure continued operational safety and reliability,

- ▶ Carry out repairs on the device only if they are expressly permitted.
- ▶ Observe federal/national regulations pertaining to repair of an electrical device.
- ▶ Use original spare parts and accessories from the manufacturer only.

Hazardous area

To eliminate a danger for persons or for the facility when the device is used in the hazardous area (e.g. explosion protection, pressure vessel safety):

- ▶ Based on the nameplate, check whether the ordered device is permitted for the intended use in the hazardous area.
- ▶ Observe the specifications in the separate supplementary documentation that is an integral part of these Instructions.

2.5 Product safety

This measuring device is designed in accordance with good engineering practice to meet state-of-the-art safety requirements, has been tested, and left the factory in a condition in which it is safe to operate. It meets general safety standards and legal requirements.

NOTICE

Loss of degree of protection by opening of the device in humid environments

- ▶ If the device is opened in a humid environment, the degree of protection indicated on the nameplate is no longer valid. This may also impair the safe operation of the device.

2.5.1 CE mark

The measuring system meets the legal requirements of the applicable EC guidelines. These are listed in the corresponding EC Declaration of Conformity together with the standards applied.

Endress+Hauser confirms successful testing of the device by affixing to it the CE mark.

2.5.2 EAC conformity

The measuring system meets the legal requirements of the applicable EAC guidelines. These are listed in the corresponding EAC Declaration of Conformity together with the standards applied.

Endress+Hauser confirms successful testing of the device by affixing to it the EAC mark.

2.6 Safety Instructions (XA)

Depending on the approval, the following Safety Instructions (XA) are supplied with the device. They are an integral part of the Operating Instructions.



The nameplate indicates the Safety Instructions (XA) that are relevant to the device.

Feature 010	Approval	Feature 020 "Power Supply; Output"		
		A ¹⁾	B ²⁾	C ³⁾
BA	ATEX II 1G Ex ia IIC T6 Ga	XA01549F	XA01549F	XA01549F
BB	ATEX II 1/2G Ex ia IIC T6 Ga/Gb	XA01549F	XA01549F	XA01549F
BC	ATEX II 1/2G Ex ia/db [ia Ga] IIC T6 Ga/Gb	XA01552F	XA01552F	XA01552F
BD	ATEX II 1/2/3G Ex ia/ic [ia Ga] IIC T6 Ga/Gb/Gc	XA01550F	XA01550F	XA01550F
BE	ATEX II 1D Ex ta IIIC Da	* 4)	* 4)	* 4)
BF	ATEX II 1/2D Ex ta/tb IIIC T85°C Da/Db	XA01554F	XA01554F	XA01554F
BG	ATEX II 3G Ex ec IIC T6 Gc	XA01551F	XA01551F	XA01551F
BH	ATEX II 3G Ex ic IIC T6 Gc	XA01551F	XA01551F	XA01551F
BL	ATEX II 1/2/3G Ex ia/ec [ia Ga] IIC T6 Ga/Gb/Gc	XA01550F	XA01550F	XA01550F
B2	ATEX II 1/2G Ex ia IIC T6 Ga/Gb, 1/2D Ex ia IIIC T85°C Da/Db	XA01555F	XA01555F	XA01555F
B3	ATEX II 1/2G Ex ia/db [ia Ga] IIC T6, Ga/Gb 1/2D Ex ta/tb IIIC T85°C Da/Db	XA01556F	XA01556F	XA01556F
CB	CSA IS Cl.I Div.1 Gr.A-D	XA01612F	XA01612F	XA01612F
CD	CSA DIP Cl.II,III Div.1 Gr.E-G [Ex ia]	XA01613F	XA01613F	XA01613F
C2	CSA IS Cl.I,II,III Div.1 Gr.A-G, Ex ia, NI Cl.1 Div.2 [Ex ia]	XA01612F	XA01612F	XA01612F
C3	CSA XP Cl.I,II,III Div.1 Gr.A-G, Zn0/1, NI Cl.I Div.2 [Ex ia]	XA01613F	XA01613F	XA01613F
FA	FM IS Cl.I Div.1 Gr.A-D	XA01615F	XA01615F	XA01615F
FB	FM IS Cl.I,II,III Div.1 Gr.A-G, AEx ia, NI Cl.1 Div.2	XA01615F	XA01615F	XA01615F
FC	FM XP-IS Cl.I Div.1 Gr.A-D, AIS Cl.I Div.1 Gr.A-D	XA01616F	XA01616F	XA01616F
FD	FM XP-IS Cl.I Div.1 Gr.A-D, Zn0/1, DIP-IS Cl.II,III Div.1 Gr.E-G, NI Cl.I Div.2	XA01616F	XA01616F	XA01616F
FE	FM DIP Cl.II,III Div.1 Gr.E-G	XA01616F	XA01616F	XA01616F
GA	EAC 0Ex ia IIC T6...T3 Ga X	XA01617F	XA01617F	XA01617F
GB	EAC Ga/Gb Ex ia IIC T6...T3 X	XA01617F	XA01617F	XA01617F
GC	EAC Ga/Gb Ex ia/db [ia Ga] IIC T6...T3 X	XA01618F	XA01618F	XA01618F
GE	EAC Ex ta IIIC Da	* 4)	* 4)	* 4)
GF	EAC Ex ta/tb IIIC T85°C Da/Db X	XA01619F	XA01619F	XA01619F
IA	IEC Ex ia IIC T6 Ga	XA01549F	XA01549F	XA01549F
IB	IEC Ex ia IIC T6 Ga/Gb	XA01549F	XA01549F	XA01549F
IC	IEC Ex ia/db [ia Ga] IIC T6 Ga/Gb	XA01552F	XA01552F	XA01552F
ID	IEC Ex ia/ic [ia Ga] IIC T6 Ga/Gb/Gc	XA01550F	XA01550F	XA01550F
IE	IEC Ex ta IIIC Da	* 4)	* 4)	* 4)
IF	IEC Ex ta/tb IIIC T85°C Da/Db	XA01554F	XA01554F	XA01554F
IG	IEC Ex ec IIC T6 Gc	XA01551F	XA01551F	XA01551F
IH	IEC Ex ic IIC T6 Gc	XA01551F	XA01551F	XA01551F
IL	IEC Ex ia/ec [ia Ga] IIC T6 Ga/Gb/Gc	XA01550F	XA01550F	XA01550F
I2	IEC Ex ia IIC T6 Ga/Gb, Ex ia IIIC T85°C Da/Db	XA01555F	XA01555F	XA01555F
I3	IEC Ex ia/db [ia Ga] IIC T6 Ga/Gb, Ex ta/tb IIIC T85°C Da/Db	XA01556F	XA01556F	XA01556F
JA	JPN Ex ia IIC T6 Ga	XA01631F ⁴⁾	XA01631F ⁴⁾	XA01631F ⁴⁾

Feature 010	Approval	Feature 020 "Power Supply; Output"		
		A ¹⁾	B ²⁾	C ³⁾
JB	JPN Ex ia IIC T6 Ga/Gb	XA01631F ⁴⁾	XA01631F ⁴⁾	XA01631F ⁴⁾
JC	JPN Ex d [ia] IIC T6 Ga/Gb	XA01632F ⁴⁾	XA01632F ⁴⁾	XA01632F ⁴⁾
JG	JPN Ex nA IIC T6 Gc	XA01725F ⁴⁾	XA01725F ⁴⁾	XA01725F ⁴⁾
JH	JPN Ex ic IIC T6 Gc	XA01725F ⁴⁾	XA01725F ⁴⁾	XA01725F ⁴⁾
J2	JPN Ex ia IIC T6 Ga/Gb, JPN Ex ia IIIC T85°C Da/Db	XA01728F ⁴⁾	XA01728F ⁴⁾	XA01728F ⁴⁾
J3	JPN Ex d [ia] IIC T6 Ga/Gb, JPN Ex ta/tb IIIC T85°C Da/Db	XA01729F ⁴⁾	XA01729F ⁴⁾	XA01729F ⁴⁾
KA	KC Ex ia IIC T6 Ga	XA01623F	XA01623F	XA01623F
KB	KC Ex ia IIC T6 Ga/Gb	XA01623F	XA01623F	XA01623F
KC	KC Ex ia/db [ia Ga] IIC T6 Ga/Gb	XA01624F	XA01624F	XA01624F
MA	INMETRO Ex ia IIC T6 Ga	XA01620F	XA01620F	XA01620F
MB	INMETRO Ex ia IIC T6 Ga/Gb	XA01620F	XA01620F	XA01620F
ME	INMETRO Ex ta IIIC Da	* 4)	* 4)	* 4)
MG	INMETRO Ex ec IIC T6 Gc	XA01621F	XA01621F	XA01621F
MH	INMETRO Ex ic IIC T6 Gc	XA01621F	XA01621F	XA01621F
NA	NEPSI Ex ia IIC T6 Ga	XA01625F	XA01625F	XA01625F
NB	NEPSI Ex ia IIC T6 Ga/Gb	XA01625F	XA01625F	XA01625F
NC	NEPSI Ex ia/d [ia Ga] IIC T6 Ga/Gb	XA01627F	XA01627F	XA01627F
NF	NEPSI Ex tD A20/A21 IP6X T85°C	XA01628F	XA01628F	XA01628F
NG	NEPSI Ex nA IIC T6 Gc	XA01626F	XA01626F	XA01626F
NH	NEPSI Ex ic IIC T6 Gc	XA01626F	XA01626F	XA01626F
N2	NEPSI Ex ia IIC T6 Ga/Gb, NEPSI Ex iaD 20/21 T85	XA01629F	XA01629F	XA01629F
N3	NEPSI Ex ia/d [ia Ga] IIC T6 Ga/Gb, NEPSI Ex tD A20/A21 IP6X T85°C	XA01630F	XA01630F	XA01630F
8A	FM/CSA IS+XP-IS Cl.I,II,III Div.1 Gr.A-G, AIS Cl.I,II,III Div.1 Gr.A-G	XA01612F XA01615F XA01616F	XA01612F XA01615F XA01616F	XA01612F XA01615F XA01616F
* 4)				

- 1) 2-wire; 4-20mA HART
- 2) 2-wire; 4-20mA HART, switch output
- 3) 2-wire; 4-20mA HART, 4-20mA
- 4) in preparation

3 Product description

3.1 Product design

3.1.1 Micropilot FMR67

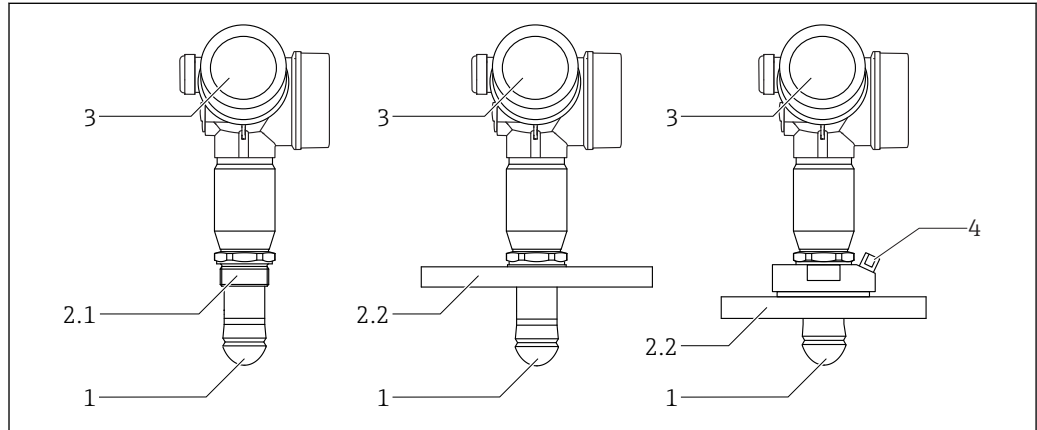

A0032714

1 Design of the Micropilot FMR67

- 1 Drip-off antenna PTFE
- 2.1 Process connection (Thread)
- 2.2 Process connection (Flange)
- 3 Electronics housing
- 4 Purge air connection

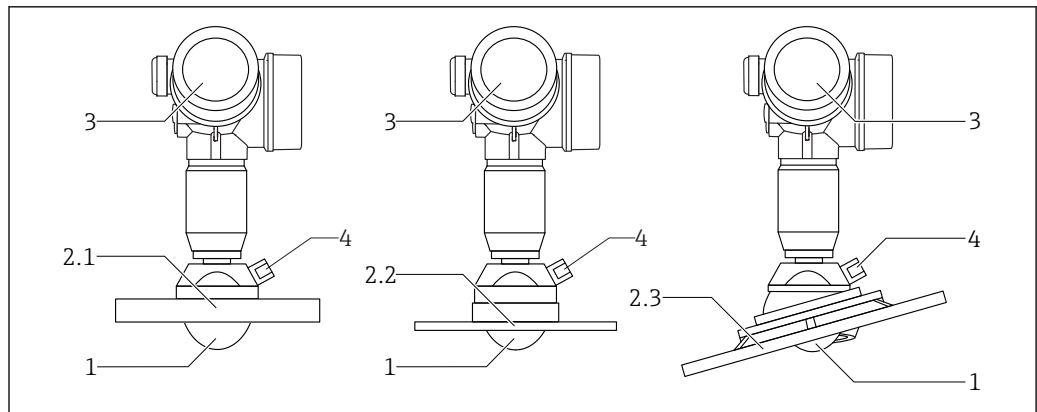

A0032782

2 Design of the Micropilot FMR67

- 1 PTFE antenna
- 2.1 Process connection (Flange)
- 2.2 Process connection (UNI-Flange)
- 2.3 Process connection (Flange with alignment device)
- 3 Electronics housing
- 4 Purge air connection

3.1.2 Electronics housing

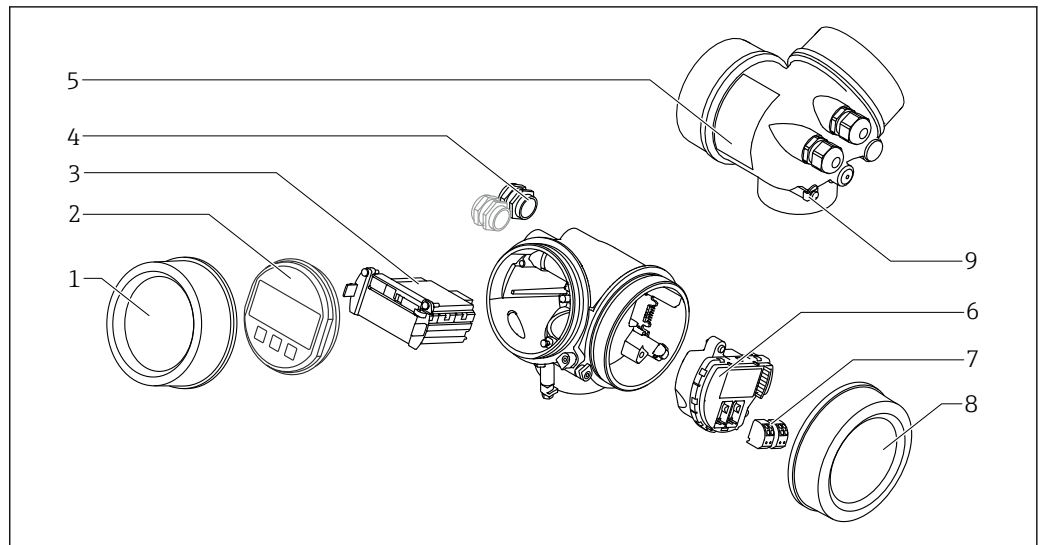

A0012422

3 Design of the electronics housing

- 1 Electronics compartment cover
- 2 Display module
- 3 Main electronics module
- 4 Cable glands (1 or 2, depending on instrument version)
- 5 Nameplate
- 6 I/O electronics module
- 7 Terminals (pluggable spring terminals)
- 8 Connection compartment cover
- 9 Grounding terminal

4 Incoming acceptance and product identification

4.1 Incoming acceptance

Check the following during incoming acceptance:

- Are the order codes on the delivery note and the product sticker identical?
- Are the goods undamaged?
- Do the nameplate data match the ordering information on the delivery note?
- If required (see nameplate): Are the safety instructions (XA) present?



If one of these conditions does not apply, please contact your Endress+Hauser sales office.

4.2 Product identification

The following options are available for identification of the measuring device:

- Nameplate specifications
- Extended order code with breakdown of the device features on the delivery note
- Enter the serial number on the nameplate into *W@M Device Viewer* (www.endress.com/deviceviewer): all the information about the measuring device is displayed.
- Enter the serial number on the nameplate into the *Endress+Hauser Operations App* or scan the 2-D matrix code (QR code) on the nameplate with the *Endress+Hauser Operations App*: all the information about the measuring device is displayed.

For an overview of the scope of the associated Technical Documentation, refer to the following:

- The *W@M Device Viewer*: enter the serial number from the nameplate (www.endress.com/deviceviewer)
- The *Endress+Hauser Operations App*: Enter the serial number from the nameplate or scan the 2-D matrix code (QR code) on the nameplate.

4.2.1 Nameplate

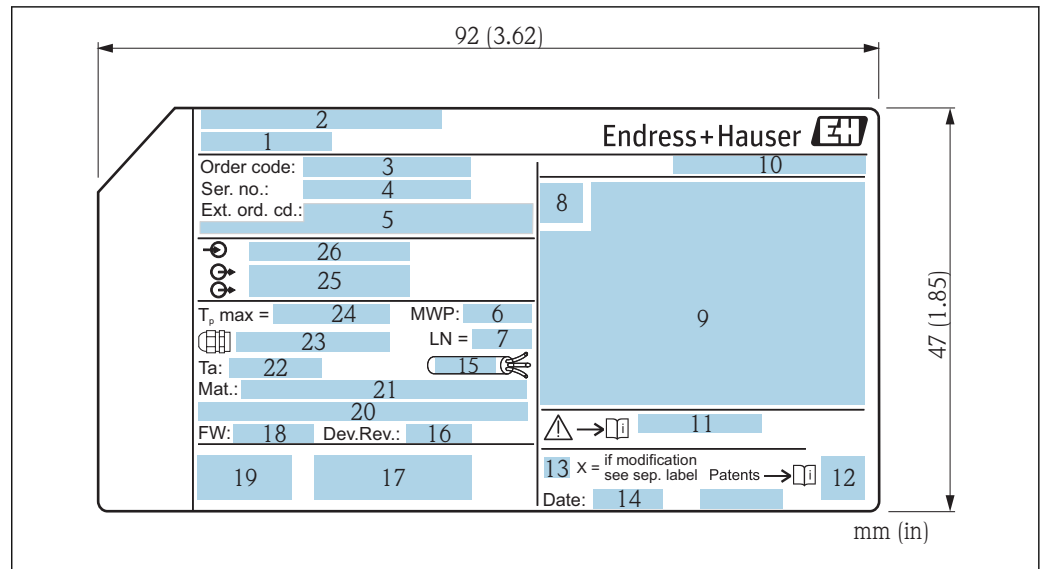

4 Nameplate of the Micropilot

- 1 Device name
- 2 Manufacturer's address
- 3 Order code
- 4 Serial number (ser. no.)
- 5 Extended order code (Ext. ord. cd.)
- 6 Process pressure
- 7 Antenna length reference length
- 8 Certificate symbol
- 9 Certificate and approval relevant data
- 10 Degree of protection: e.g. IP, NEMA
- 11 Document number of the Safety Instructions: e.g. XA, ZD, ZE
- 12 2-D matrix code (QR code)
- 13 Modification mark
- 14 Manufacturing date: year-month
- 15 Temperature resistance of cable
- 16 Device revision (Dev.Rev.)
- 17 Additional information about the device version (certificates, approvals, communication protocol)
- 18 Firmware version (FW)
- 19 CE mark, C-Tick
- 20 Profibus PA: Profile Version; FOUNDATION Fieldbus: Device ID
- 21 Materials in contact with process
- 22 Permitted ambient temperature (T_a)
- 23 Size of the cable gland thread
- 24 Maximum process temperature
- 25 Signal outputs
- 26 Supply voltage

i Up to 33 characters of the extended order code are indicated on the nameplate. If the extended order code contains additional characters, these cannot be displayed.

However, the complete extended order code can also be displayed via the device operating menu: **Extended order code 1 to 3** parameter

5 Storage, Transport

5.1 Storage conditions

- Permitted storage temperature: -40 to +80 °C (-40 to +176 °F)
- Use original packaging.

5.2 Transporting the product to the measuring point

NOTICE

Housing or sensor may become damaged or pull off.

Risk of injury!

- ▶ Transport the measuring device to the measuring point in its original packaging or by the process connection.
- ▶ Always secure lifting equipment (slings, eyes, etc.) at the process connection and never lift the device by the electronic housing or sensor. Pay attention to the center of gravity of the device so that it does not tilt or slip unintentionally.
- ▶ Follow the safety instructions and transport conditions for devices over 18 kg (39.6 lbs), (IEC61010).

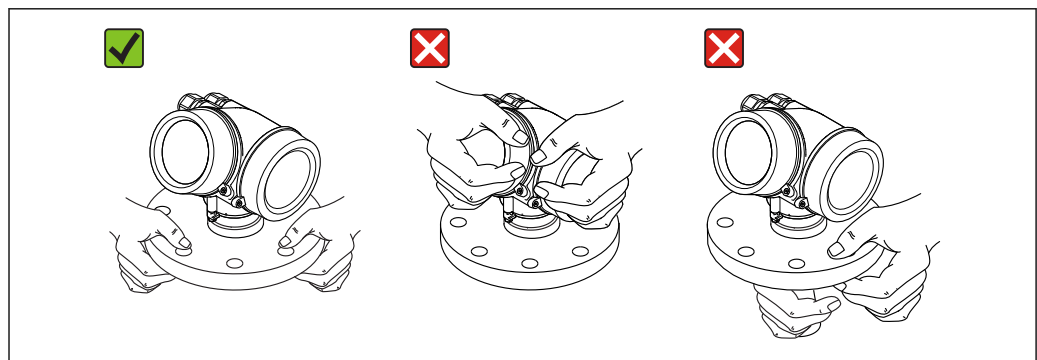

A0032300

6 Installation

6.1 Installation conditions

6.1.1 Orientation - Solid media

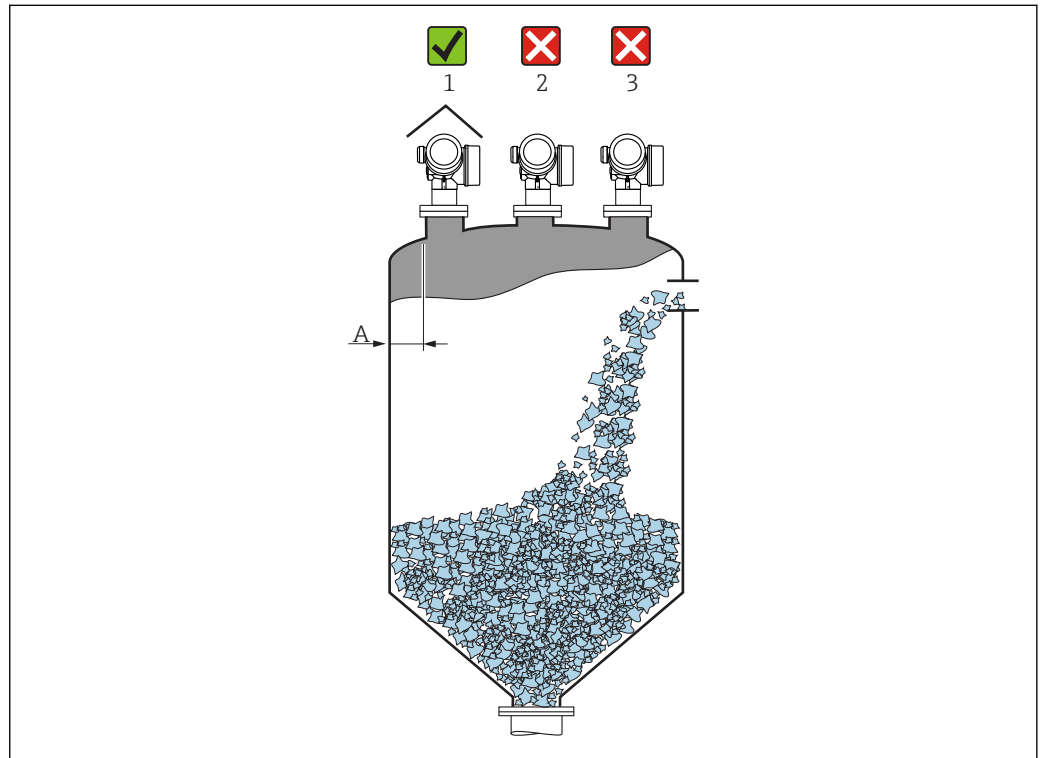

A0016883

- Recommended distance **A** wall - nozzle outer edge: $\sim 1/6$ of the container diameter. However, the device must not under any circumstances be mounted closer than 20 cm (7.87 in) to the container wall. If the container wall is not smooth (corrugated iron, welding seams, joints, etc.) it is recommended to maintain the largest possible distance from the wall. Where necessary use an alignment unit to avoid interference reflections from the container wall → 25.
- Not in the center (2) as interference can cause signal loss.
- Not above the filling curtain (3).
- The use of a weather protection cover (1) is recommended to protect the transmitter from direct sunlight or rain.
- In applications with strong dust emissions, the integrated purge air connection can prevent the antenna from becoming clogged.

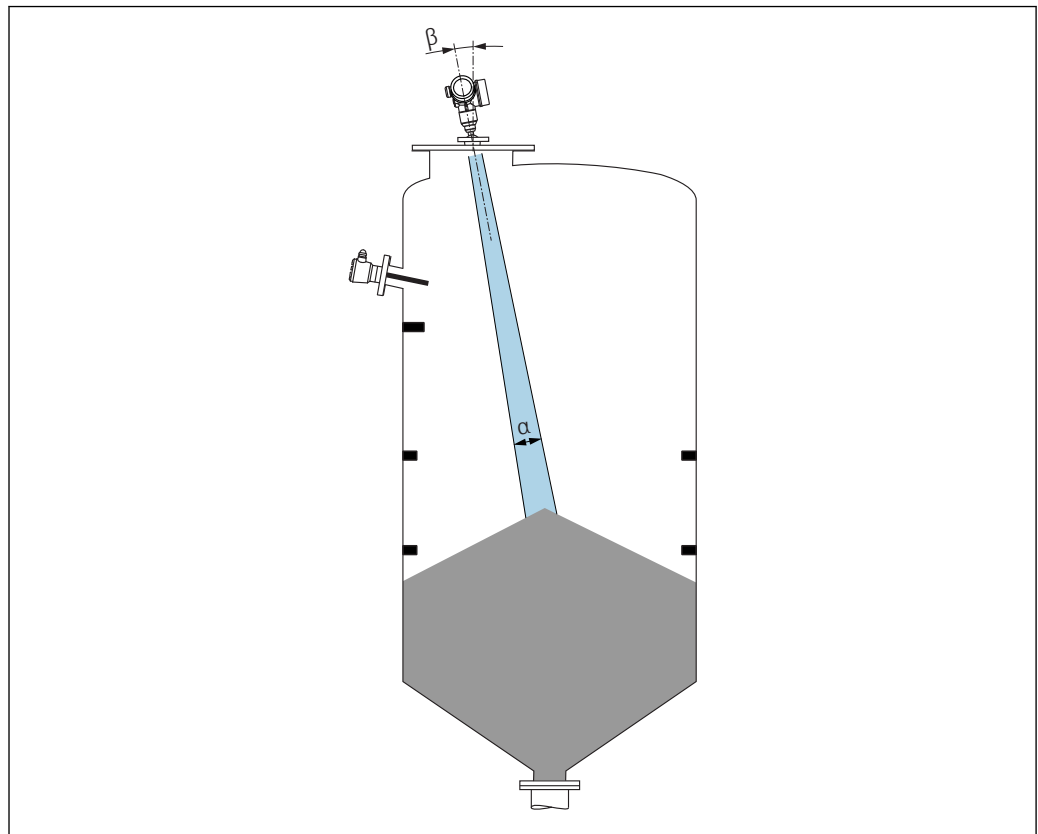
Internal container fittings

A0031814

Avoid the location of internal fittings (limit switches, temperature sensors, struts etc.) inside the signal beam. Take into account the beam angle .

Avoiding interference echoes

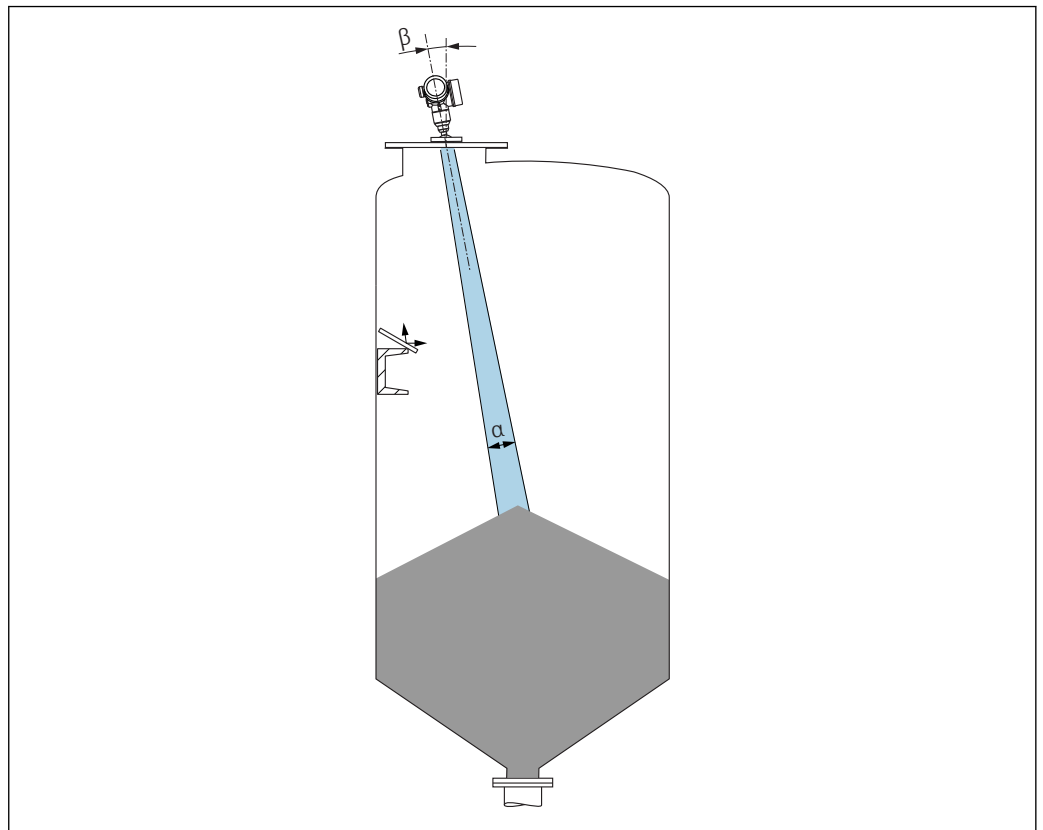

A0031817

Metal deflector plates, installed at an angle to scatter the radar signals, help prevent interference echoes.

6.1.2 Optimization options

- **Antenna size**
The larger the antenna the smaller the beam angle α , resulting in fewer interference echoes → ☰ 22.
- **Mapping**
Measurement can be optimized by electronically suppressing interference echoes. See also **Confirm distance** parameter.
- **Adjustable flange seal for FMR67**
Adjustable flange seals sized from DN80 to DN150 (3" to 6") are available for the FMR67 with drip-off antenna ¹⁾. They can be used to align the device to the product surface. Maximum angle of alignment: 8°. How to order:
 - Order with the device ²⁾
 - Order as an accessory: → ☰ 89
- **Alignment unit for FMR67**
Flanges from 4" / DN100 are optionally available with an alignment unit ³⁾. They allow the sensor to be optimally aligned to suit conditions in the container in order to prevent interference reflections. The maximum angle is $\pm 15^\circ$. The purpose of sensor alignment is primarily to:
 - Prevent interference reflections
 - Increase the maximum possible measuring range in conical outlets

1) Feature 070 in product structure, "Antenna", option GA

2) Feature 100 in product structure "Process connection", options PL, PM, PN, PO, PQ, PR

3) See feature 100 in product structure, "Process connection".

6.1.3 Beam angle

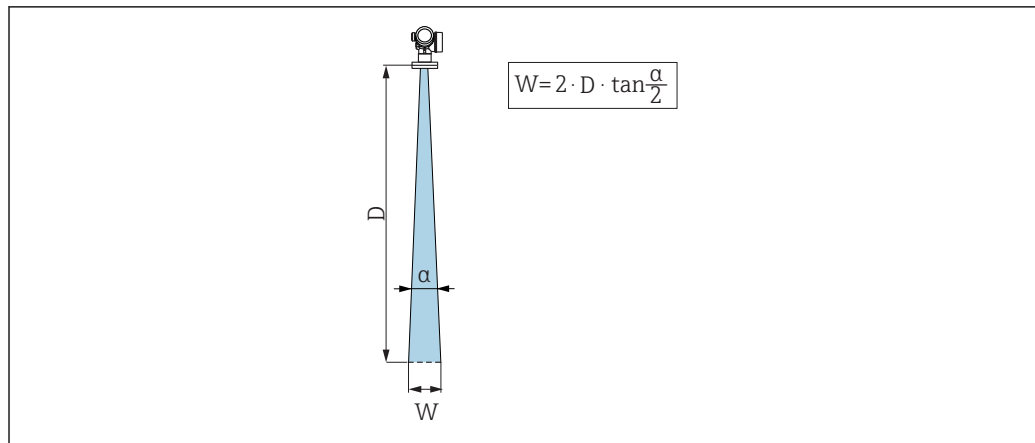

5 Relationship between beam angle α , distance D and beamwidth diameter W

The beam angle is defined as the angle α where the energy density of the radar waves reaches half the value of the maximum energy density (3dB width). Microwaves are also emitted outside the signal beam and can be reflected off interfering installations.

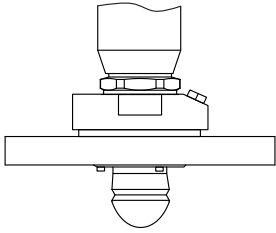
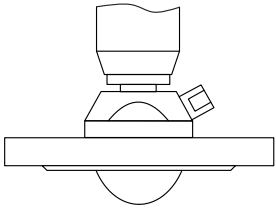
FMR67		
		
Antenna ¹⁾	Drip-off, PTFE 50 mm / 2"	PTFE flush-mounted 80 mm / 3"
Beam angle α	6 °	4 °
Distance (D)	Beamwidth diameter W	
5 m (16 ft)	0.52 m (1.70 ft)	0.35 m (1.15 ft)
10 m (33 ft)	1.05 m (3.44 ft)	0.70 m (2.30 ft)
15 m (49 ft)	1.57 m (5.15 ft)	1.05 m (3.44 ft)
20 m (66 ft)	2.10 m (6.89 ft)	1.40 m (4.59 ft)
25 m (82 ft)	2.62 m (8.60 ft)	1.75 m (5.74 ft)
30 m (98 ft)	3.14 m (10.30 ft)	2.10 m (6.89 ft)
35 m (115 ft)	3.67 m (12.04 ft)	2.44 m (8.00 ft)
40 m (131 ft)	4.19 m (13.75 ft)	2.79 m (9.15 ft)
45 m (148 ft)	4.72 m (15.49 ft)	3.14 m (10.30 ft)
50 m (164 ft)	5.24 m (17.19 ft)	3.49 m (11.45 ft)
60 m (197 ft)	-	4.19 m (13.75 ft)
70 m (230 ft)	-	4.89 m (16.04 ft)
80 m (262 ft)	-	5.59 m (18.34 ft)
90 m (295 ft)	-	6.29 m (20.64 ft)
100 m (328 ft)	-	6.98 m (22.90 ft)
110 m (361 ft)	-	7.68 m (25.20 ft)
120 m (394 ft)	-	8.38 m (27.49 ft)
125 m (410 ft)	-	8.73 m (28.64 ft)

1) Feature 070 in product structure

6.1.4 External measurement through plastic cover or dielectric windows

- Dielectric constant of medium: $\epsilon_r \geq 10$
- The distance from the tip of the antenna to the tank should be approx. 100 mm (4 in).
- If possible, avoid installation positions in which condensate or buildup can form between the antenna and the vessel.
- In the case of outdoor installations, ensure that the area between the antenna and the tank is protected from the weather.
- Do not install any fittings or attachments between the antenna and the tank that could reflect the signal.

Suitable thickness of tank roof or window

Material	PE	PTFE	PP	Perspex
ϵ_r (Dielectric constant of medium)	2.3	2.1	2.3	3.1
Optimum thickness	1.25 mm (0.049 in) ¹⁾	1.3 mm (0.051) ¹⁾	1.25 mm (0.049 in) ¹⁾	1.07 mm (0.042 in) ¹⁾

1) or an integer that is a multiple of this value; it should be noted here that the microwave transparency decreases significantly with increasing window thickness.

6.2 Installation: Drip-off antenna, PTFE 50 mm / 2"

6.2.1 FMR67 - Aligning the antenna axis

Align the antenna vertically to the product surface.

If necessary, the antenna can be aligned by means of a adjustable flange seal (available as an accessory).



Attention:

The maximum reach of the antenna can be reduced if it is not installed perpendicular to the product.

6.2.2 Radial alignment of the antenna

Based on the directional characteristic, radial alignment of the antenna is not necessary.

6.2.3 Information concerning nozzles

The maximum nozzle length H_{max} depends on the nozzle diameter D :

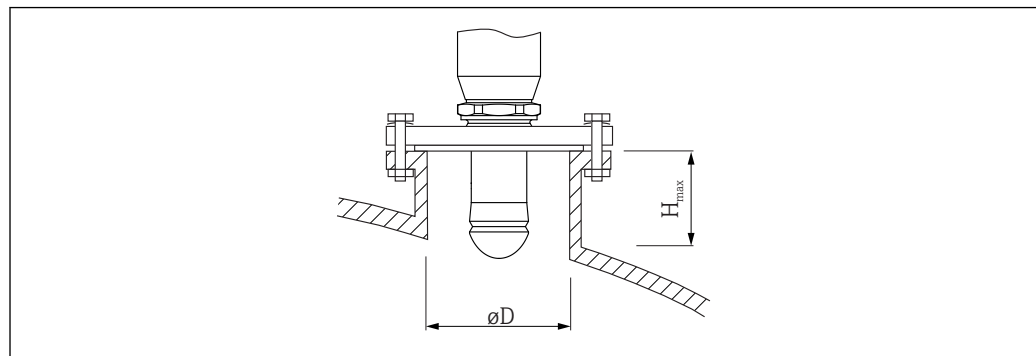

A0032209

Nozzle diameter ($\varnothing D$)	Maximum nozzle length (H_{max}) ¹⁾
50 to 80 mm (2 to 3.2 in)	750 mm (30 in)
80 to 100 mm (3.2 to 4 in)	1 150 mm (46 in)

Nozzle diameter (ØD)	Maximum nozzle length (H _{max}) ¹⁾
100 to 150 mm (4 to 6 in)	1 450 mm (58 in)
≥150 mm (6 in)	2 200 mm (88 in)

1) In the case of longer nozzles, a reduced measuring performance must be anticipated.



Note the following if the antenna does not project out of the nozzle:

- The end of the nozzle must be smooth and free from burrs. The edge of the nozzle should be rounded if possible.
- Mapping must be performed.
- Please contact Endress+Hauser for applications with nozzles that are higher than indicated in the table.

6.2.4 Information concerning threaded connections

- When screwing in, turn by the hex bolt only.
- Tool: open-ended wrench 55 mm
- Maximum permissible torque: 50 Nm (36 lbf ft)

6.3 Installation: FMR67 - Flush-mounted antenna

6.3.1 Aligning the antenna axis

UNI flanges with an integrated alignment unit are available for FMR67 devices with a flush mount antenna. An angle of inclination of up to 15° in all directions can be set for the antenna axis using the alignment unit. The alignment unit is used to optimally align the radar beam to the bulk solid.

Process connection with Alignment unit ¹⁾	UNI flange	Material	Pressure rating	Suitable for
XCA	UNI 4" / DN100 / 100A	Aluminum	max. 14.5lbs / PN1 / 1K	<ul style="list-style-type: none"> ▪ 4" 150lbs ▪ DN100 PN16 ▪ 10K 100A
XDA	UNI 6" / DN150 / 150A	Aluminum	max. 14.5lbs / PN1 / 1K	<ul style="list-style-type: none"> ▪ 6" 150lbs ▪ DN150 PN16 ▪ 10K 150A
XEA	UNI 8" / DN200 / 200A	Aluminum	max. 14.5lbs / PN1 / 1K	<ul style="list-style-type: none"> ▪ 8" 150lbs ▪ DN200 PN16 ▪ 10K 200A
XFA	UNI 10" / DN250 / 250A	Aluminum	max. 14.5lbs / PN1 / 1K	<ul style="list-style-type: none"> ▪ 10" 150lbs ▪ DN250 PN16 ▪ 10K 250A

1) Feature 100 in product structure

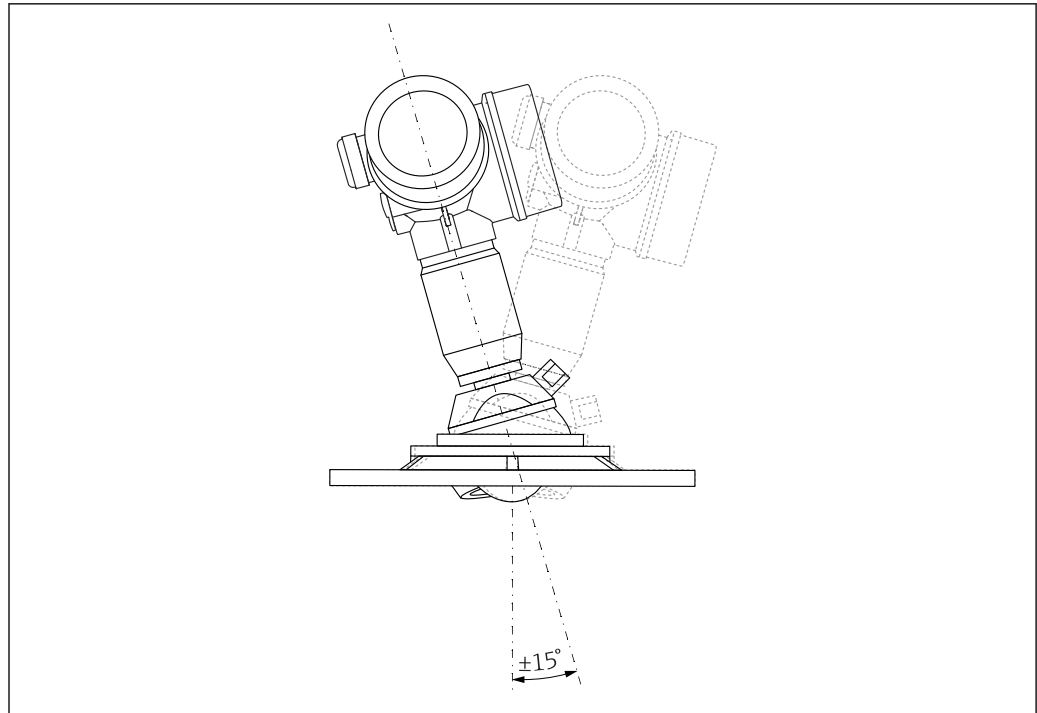

A0032097

6 Micropilot FMR67 with alignment unit

Aligning the antenna axis

1. Release the screws
2. Align the antenna axis (up to max. $\pm 15^\circ$ possible in all directions)
3. Tighten the screws with 10 Nm (7.4 lbf ft)

6.3.2 Radial alignment of the antenna

Based on the directional characteristic, radial alignment of the antenna is not necessary.

6.3.3 Information concerning nozzles

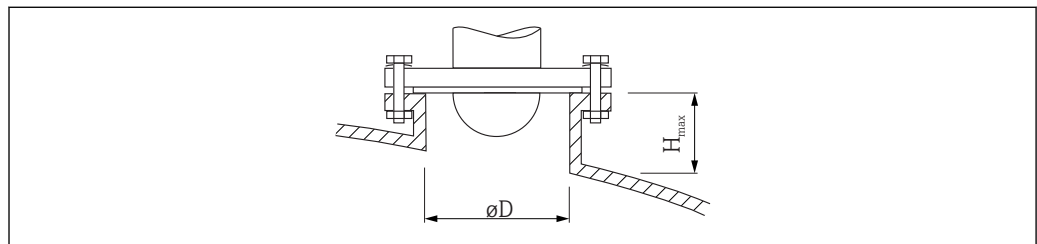

A0032206

Internal diameter of nozzle D	Maximum nozzle height H_{max}
min. 80 to 100 mm (3 to 4 in)	1450 mm (57 in)
100 to 150 mm (4 to 6 in)	1800 mm (71 in)
≥ 150 mm (6 in)	2700 mm (106 in)

- i** Note the following if the antenna does not project out of the nozzle:
- The end of the nozzle must be smooth and free from burrs. The edge of the nozzle should be rounded if possible.
 - Mapping must be performed.
 - Please contact Endress+Hauser for applications with nozzles that are higher than indicated in the table.

6.4 FMR67 - Purge air connection

6.4.1 Purge air adapter for drip-off antennas

Purge air connection ¹⁾	Meaning
A	None
3	Purge air adapter G 1/4"
4	Purge air adapter NPT 1/4"

1) Feature 110 in product structure

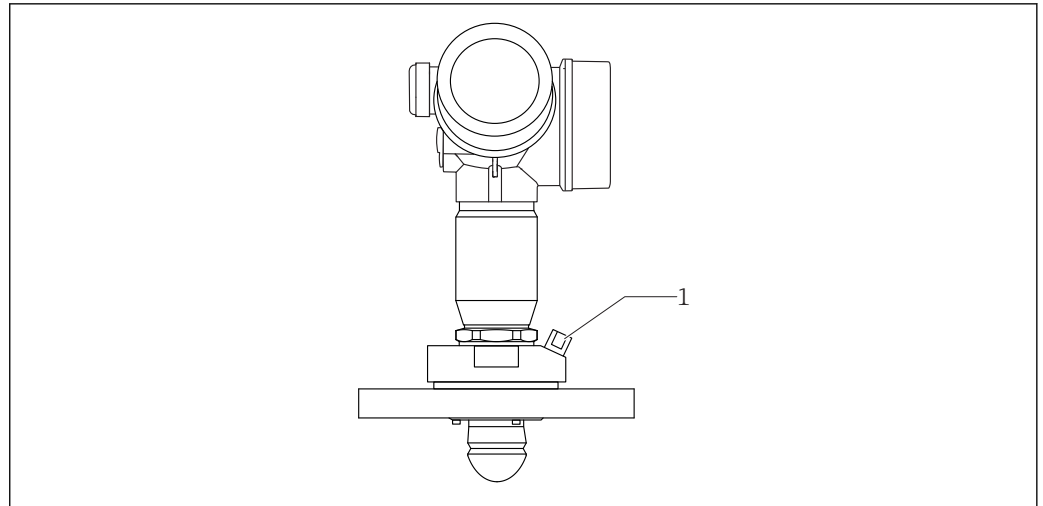

A0032098

1 Purge air connection NPT 1/4" or G 1/4"

6.4.2 Integrated purge air connection for flush-mounted antennas

Purge air connection ¹⁾	Meaning
1	Purge air connection G 1/4"
2	Purge air connection NPT 1/4"

1) Feature 110 in product structure

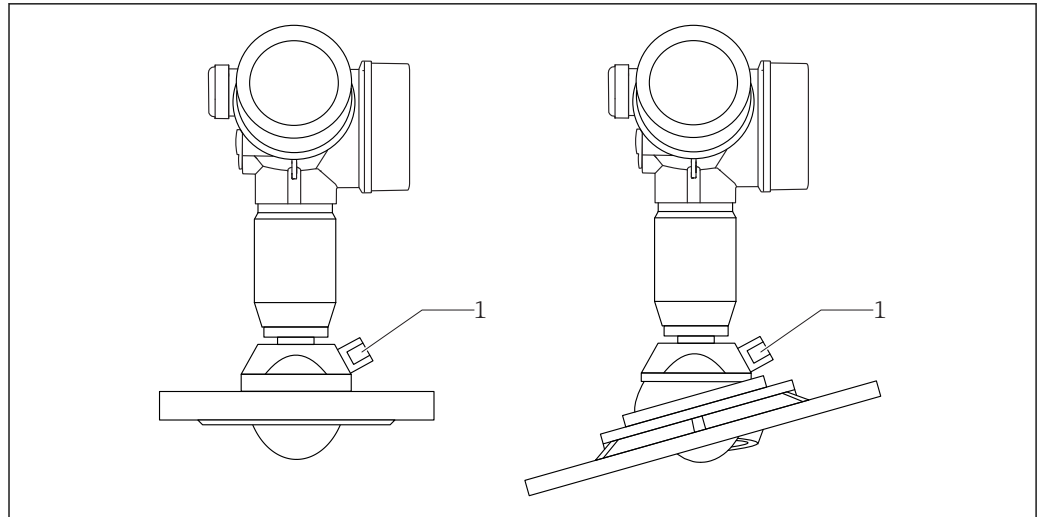

A0032099

1 Purge air connection NPT 1/4" or G 1/4"

6.4.3 Use

In applications with strong dust emissions, the integrated purge air connection can prevent the antenna from becoming clogged. Pulse operation is recommended.

Purge air pressure range

- **Pulse operation :**
Max. 6 bar (87 psi)
- **Continuous operation:**
200 to 500 mbar (3 to 7.25 psi)

Purge air connection

- **Tool:**
 - Open-ended wrench 13 mm (G 1/4")
 - Open-ended wrench 14 mm (NPT)
 - Open-ended wrench 17 mm (NPT "adapter")
- remains stable for a minimum of torque: 6 Nm (4.4 lbf ft)
- Max. torque: 7 Nm

i Always use dry purge air.

i In general, purging should only be performed to the extent necessary as excess purging can cause mechanical damage (abrasion).

6.5 Container with heat insulation

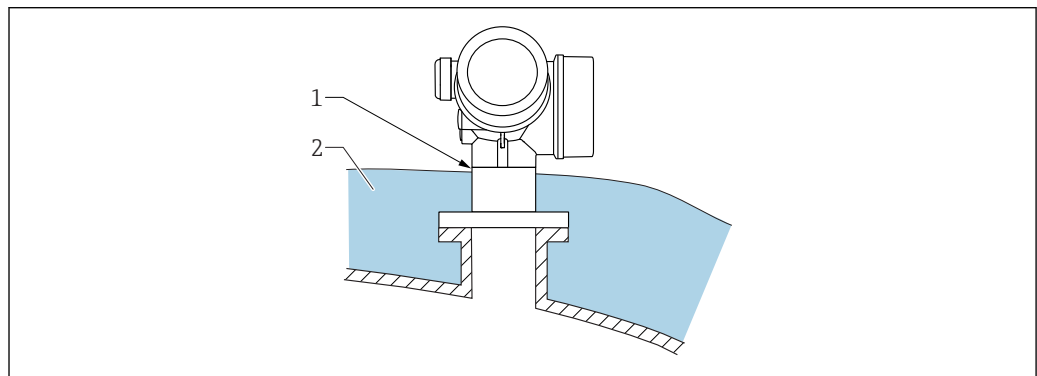

A0032207

If process temperatures are high, the device should be included in the usual container insulation system (2) to prevent the electronics from heating as a result of thermal radiation or convection. The insulation should not be higher than the neck of the device (1).

6.6 Turning the transmitter housing

To provide easier access to the connection compartment or display module, the transmitter housing can be turned:

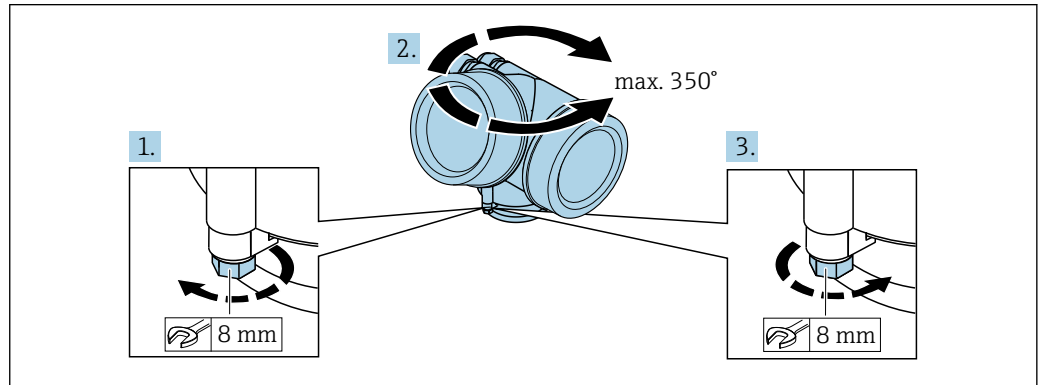

A0032242

1. Unscrew the securing screw using an open-ended wrench.
2. Rotate the housing in the desired direction.
3. Tighten the securing screw (1.5 Nm for plastic housing; 2.5 Nm for aluminum or stainless steel housing).

6.7 Turning the display

6.7.1 Opening cover

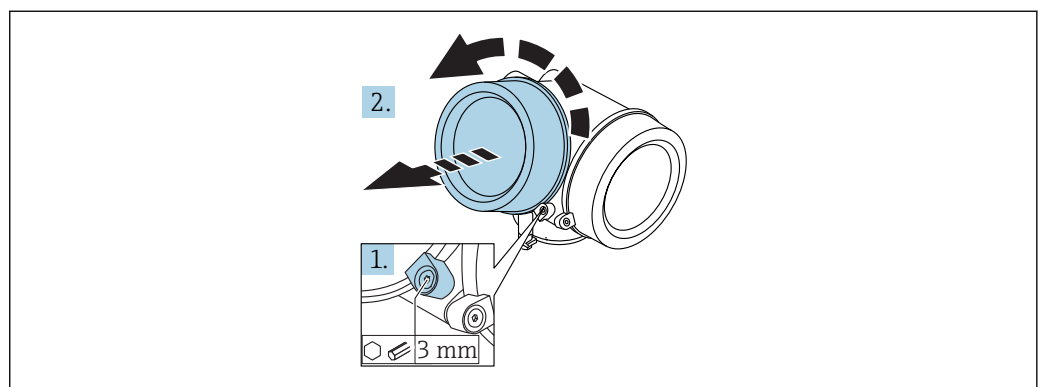

A0021430

1. Loosen the screw of the securing clamp of the electronics compartment cover using an Allen key (3 mm) and turn the clamp 90° counterclockwise.
2. Unscrew cover and check lid gasket, replace if necessary.

6.7.2 Turning the display module

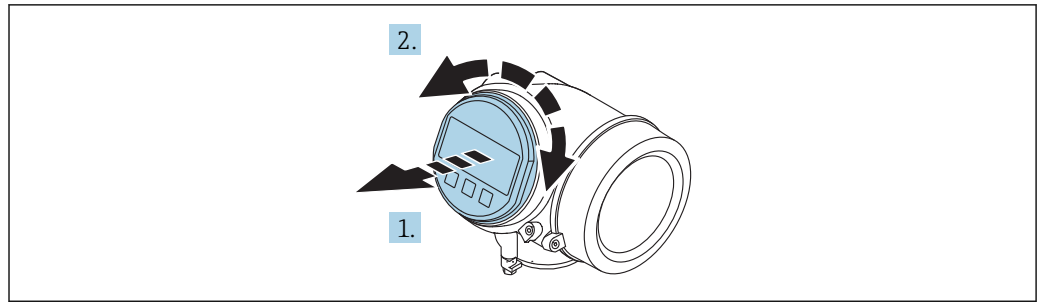

A0036401

1. Pull out the display module with a gentle rotational movement.
2. Rotate the display module to the desired position: max. $8 \times 45^\circ$ in each direction.
3. Feed the coiled cable into the gap between the housing and main electronics module and plug the display module into the electronics compartment until it engages.

6.7.3 Closing electronics compartment cover

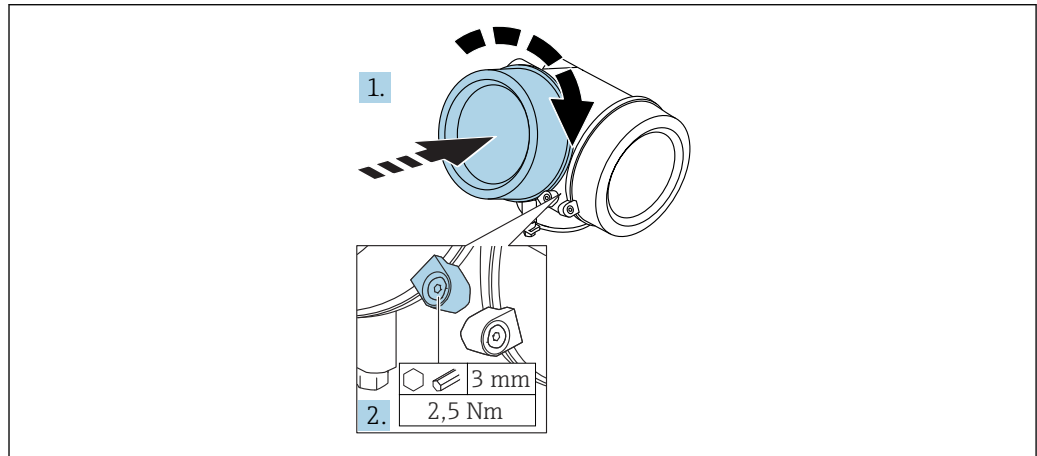

A0021451

1. Screw back firmly electronics compartment cover.
2. Turning securing clamp 90° clockwise and tighten the clamp with 2.5 Nm using the Allen key (3 mm).

6.8 Post-installation check

<input type="checkbox"/>	Is the device undamaged (visual inspection)?
<input type="checkbox"/>	Does the device conform to the measuring point specifications? For example: <ul style="list-style-type: none"> ▪ Process temperature ▪ Process pressure (refer to the chapter on "Material load curves" of the "Technical Information" document) ▪ Ambient temperature range ▪ Measuring range
<input type="checkbox"/>	Are the measuring point identification and labeling correct (visual inspection)?
<input type="checkbox"/>	Is the device adequately protected from precipitation and direct sunlight?
<input type="checkbox"/>	Are the securing screw and securing clamp tightened securely?

7 Electrical connection

7.1 Connection conditions

7.1.1 Terminal assignment

Terminal assignment 2-wire: 4-20 mA HART

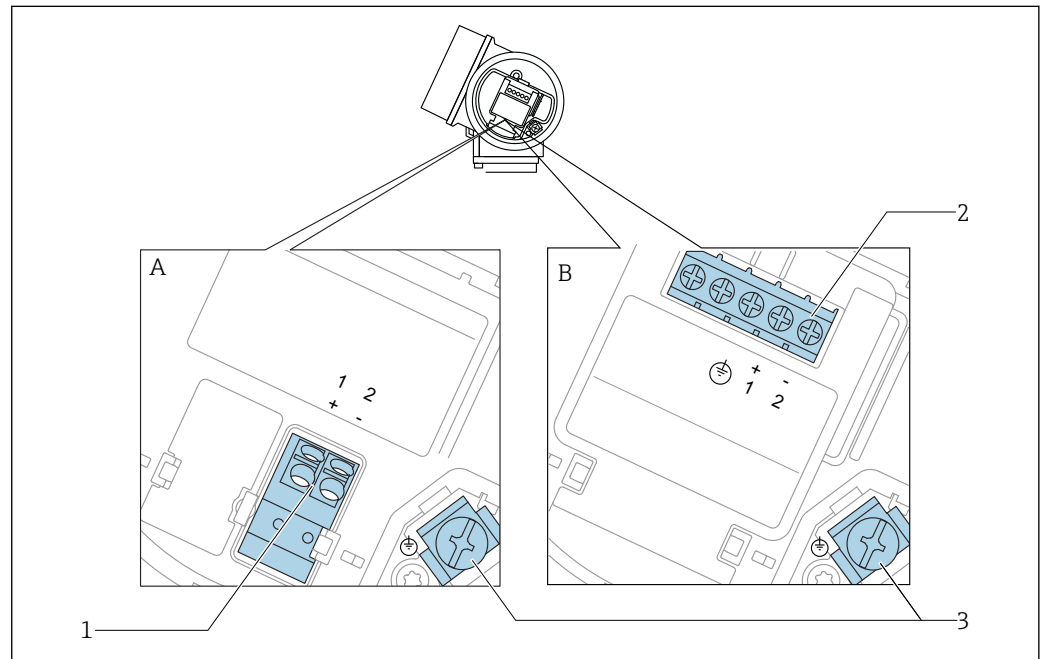

7 Terminal assignment 2-wire: 4-20 mA HART

A Without integrated overvoltage protection

B With integrated overvoltage protection

1 Connection 4-20 mA HART passive: terminals 1 and 2, without integrated overvoltage protection

2 Connection 4-20 mA HART passive: terminals 1 and 2, with integrated overvoltage protection

3 Terminal for cable screen

Block diagram 2-wire: 4-20 mA HART

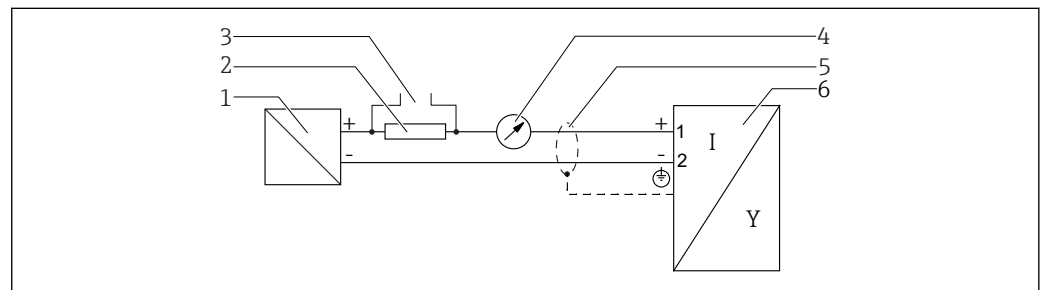

8 Block diagram 2-wire: 4-20 mA HART

1 Active barrier with power supply (e.g. RN221N); observe terminal voltage

2 HART communication resistor ($\geq 250 \Omega$); observe maximum load

3 Connection for Commubox FXA195 or FieldXpert SFX350/SFX370 (via VIATOR Bluetooth modem)

4 Analog display device; observe maximum load

5 Cable screen; observe cable specification

6 Measuring device

Terminal assignment 2-wire: 4-20 mA HART, switch output

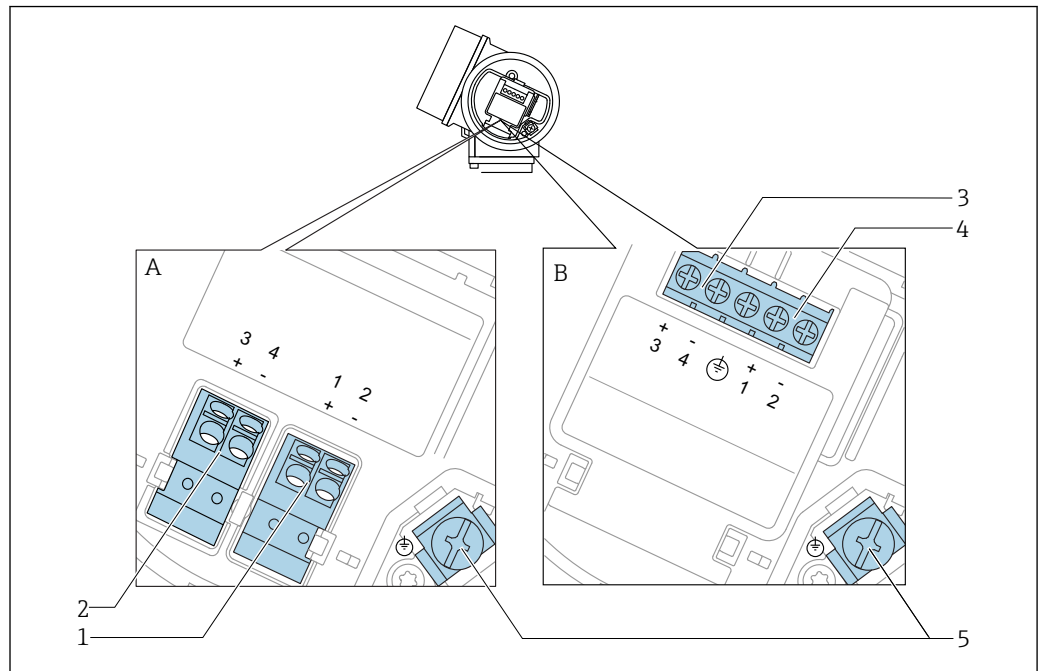

A0036500

9 Terminal assignment 2-wire: 4-20 mA HART, switch output

- A Without integrated overvoltage protection
 B With integrated overvoltage protection
 1 Connection 4-20 mA HART passive: terminals 1 and 2, without integrated overvoltage protection
 2 Connection switch output (Open Collector): terminals 3 and 4, without integrated overvoltage protection
 3 Connection switch output (Open Collector): terminals 3 and 4, with integrated overvoltage protection
 4 Connection 4-20 mA HART passive: terminals 1 and 2, with integrated overvoltage protection
 5 Terminal for cable screen

Block diagram 2-wire: 4-20 mA HART, switch output

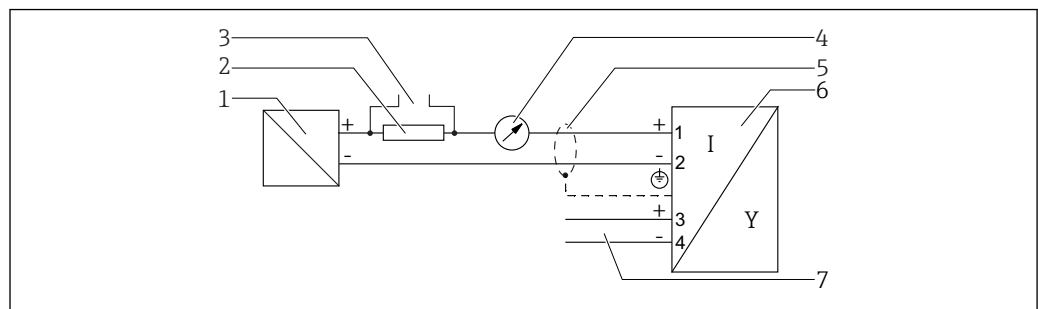

A0036501

10 Block diagram 2-wire: 4-20 mA HART, switch output

- 1 Active barrier with power supply (e.g. RN221N); observe terminal voltage
 2 HART communication resistor ($\geq 250 \Omega$); observe maximum load
 3 Connection for Commubox FXA195 or FieldXpert SFX350/SFX370 (via VIATOR Bluetooth modem)
 4 Analog display device; observe maximum load
 5 Cable screen; observe cable specification
 6 Measuring device
 7 Switch output (Open Collector)

Terminal assignment 2-wire: 4-20 mA HART, 4-20 mA

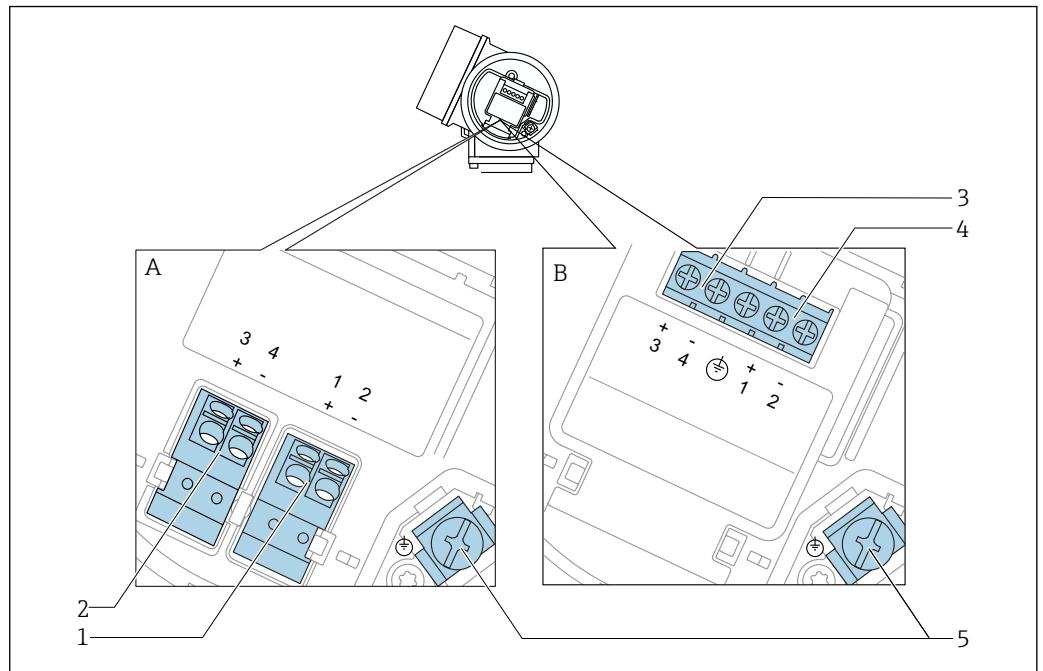

A0036500

11 Terminal assignment 2-wire: 4-20 mA HART, 4-20 mA

A Without integrated overvoltage protection

B With integrated overvoltage protection

1 Connection current output 1, 4-20 mA HART passive: terminals 1 and 2, without integrated overvoltage protection

2 Connection current output 2, 4-20 mA: terminals 3 and 4, without integrated overvoltage protection

3 Connection current output 2, 4-20 mA: terminals 3 and 4, with integrated overvoltage protection

4 Connection current output 1, 4-20 mA HART passive: terminals 1 and 2, with integrated overvoltage protection

5 Terminal for cable screen

Block diagram 2-wire: 4-20 mA HART, 4-20 mA

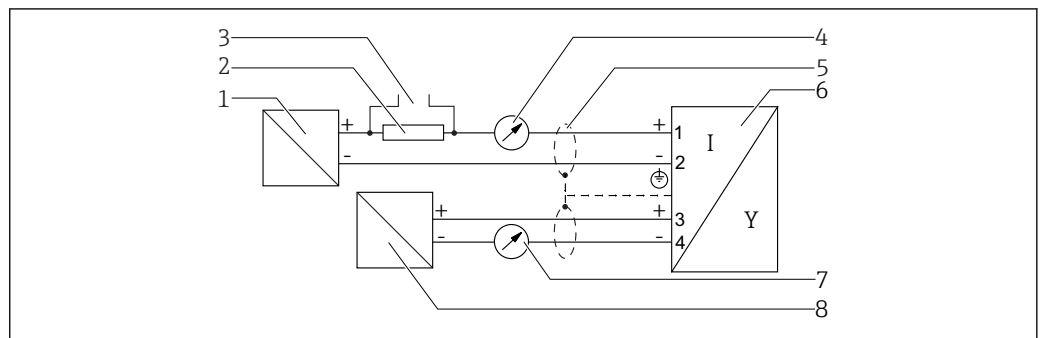

A0036502

12 Block diagram 2-wire: 4-20 mA HART, 4-20 mA

1 Active barrier with power supply (e.g. RN221N); observe terminal voltage

2 HART communication resistor ($\geq 250 \Omega$); observe maximum load

3 Connection for Commubox FXA195 or FieldXpert SFX350/SFX370 (via VIATOR Bluetooth modem)

4 Analog display device; observe maximum load

5 Cable screen; observe cable specification

6 Measuring device

7 Analog display device; observe maximum load

8 Active barrier with power supply (e.g. RN221N), current output 2; observe terminal voltage

Connection examples for the switch output

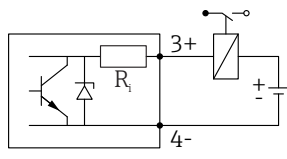
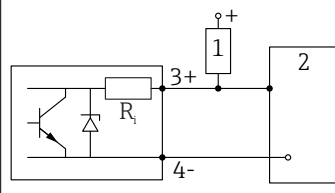
 <p>13 Connection of a relay</p> <p>Suitable relays (examples):</p> <ul style="list-style-type: none"> ▪ Solid-state relay: Phoenix Contact OV-24DC/480AC/5 with mounting rail connector UMK-1 OM-R/AMS ▪ Electromechanical relay: Phoenix Contact PLC-RSC-12DC/21 	 <p>14 Connection of a digital input</p> <p>1 Pull-up resistor 2 Digital input</p>
--	--

i For optimum interference immunity we recommend to connect an external resistor (internal resistance of the relay or Pull-up resistor) of $< 1\ 000\ \Omega$.

7.1.2 Cable specification

▪ Devices without integrated overvoltage protection

Pluggable spring-force terminals for wire cross-sections 0.5 to $2.5\ \text{mm}^2$ (20 to 14 AWG)

▪ Devices with integrated overvoltage protection

Screw terminals for wire cross-sections 0.2 to $2.5\ \text{mm}^2$ (24 to 14 AWG)

- For ambient temperature $T_U \geq 60\ ^\circ\text{C}$ ($140\ ^\circ\text{F}$): use cable for temperature $T_U + 20\ \text{K}$.

HART

- A normal device cable suffices if only the analog signal is used.
- A shielded cable is recommended if using the HART protocol. Observe grounding concept of the plant.

7.1.3 Device plug connectors

i For the versions with fieldbus plug connector (M12 or 7/8"), the signal line can be connected without opening the housing.

Pin assignment of the M12 plug connector

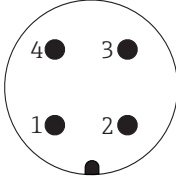
 <p style="text-align: right; font-size: small;">A0011175</p>	Pin	Meaning
	1	Signal +
	2	not connected
	3	Signal -
	4	Ground

Pin assignment of the 7/8" plug connector

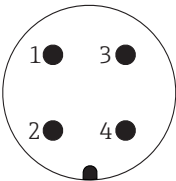
 <p style="text-align: right; font-size: small;">A0011176</p>	Pin	Meaning
	1	Signal -
	2	Signal +
	3	Not connected
	4	Screen

7.1.4 Supply voltage

2-wire, 4-20 mA HART, passive

"Power supply, output" ¹⁾	"Approval" ²⁾	Terminal voltage U at device	Maximum load R, depending on the supply voltage U ₀ of the power supply unit
A: 2-wire; 4-20 mA HART	<ul style="list-style-type: none"> ▪ Non-hazardous ▪ Ex nA ▪ Ex ic ▪ CSA GP 	14 to 35 V ³⁾	<p style="text-align: right; font-size: small;">A0031745</p>
	Ex ia / IS	14 to 30 V ³⁾	
	<ul style="list-style-type: none"> ▪ Ex d(ia) / XP ▪ Ex ic(ia) ▪ Ex nA(ia) ▪ Ex ta / DIP 	14 to 35 V ^{3) 4)}	
	Ex ia + Ex d(ia) / IS + XP	14 to 30 V ³⁾	

- 1) Feature 020 in the product structure
- 2) Feature 010 in the product structure
- 3) If the Bluetooth modem is used, the minimum supply voltage increases by 2 V.
- 4) At ambient temperatures $TT_a \leq -20^\circ\text{C}$, a terminal voltage $U \geq 16\text{ V}$ is required to start the device with the minimum failure current (3.6 mA).

"Power supply, output" ¹⁾	"Approval" ²⁾	Terminal voltage U at device	Maximum load R, depending on the supply voltage U ₀ of the power supply unit
B: 2-wire; 4-20 mA HART, switch output	<ul style="list-style-type: none"> ▪ Non-hazardous ▪ Ex nA ▪ Ex nA(ia) ▪ Ex ic ▪ Ex ic(ia) ▪ Ex d(ia) / XP ▪ Ex ta / DIP ▪ CSA GP 	16 to 35 V ³⁾	<p style="text-align: right; font-size: small;">A0031746</p>
	<ul style="list-style-type: none"> ▪ Ex ia / IS ▪ Ex ia + Ex d(ia) / IS + XP 	16 to 30 V ³⁾	

- 1) Feature 020 in the product structure
- 2) Feature 010 in the product structure
- 3) If the Bluetooth modem is used, the minimum supply voltage increases by 2 V.

"Power supply, output" ¹⁾	"Approval" ²⁾	Terminal voltage U at device	Maximum load R, depending on the supply voltage U ₀ of the power supply unit
C: 2-wire; 4-20 mA HART, 4-20 mA	All	16 to 30 V ³⁾	<p style="text-align: right; font-size: small;">A0031746</p>

- 1) Feature 020 in the product structure
- 2) Feature 010 in the product structure
- 3) If the Bluetooth modem is used, the minimum supply voltage increases by 2 V.

Integrated polarity reversal protection	Yes
Permitted residual ripple with f = 0 to 100 Hz	U _{SS} < 1 V
Permitted residual ripple with f = 100 to 10 000 Hz	U _{SS} < 10 mV

7.1.5 Overvoltage protection

If the measuring device is used for level measurement in flammable liquids which requires the use of overvoltage protection according to DIN EN 60079-14, standard for test procedures 60060-1 (10 kA, pulse 8/20 μs), an overvoltage protection module has to be installed.

Integrated overvoltage protection module

An integrated overvoltage protection module is available for 2-wire HART devices.

Product structure: Feature 610 "Accessory mounted", option NA "Overvoltage protection".

Technical data	
Resistance per channel	2 × 0.5 Ω max.
Threshold DC voltage	400 to 700 V
Threshold impulse voltage	< 800 V
Capacitance at 1 MHz	< 1.5 pF
Nominal arrest impulse voltage (8/20 μs)	10 kA

External overvoltage protection module

HAW562 or HAW569 from Endress+Hauser are suited as external overvoltage protection.

7.1.6 Connecting the measuring device

⚠ WARNING**Risk of explosion!**

- ▶ Observe applicable national standards.
- ▶ Comply with the specifications in the Safety Instructions (XA).
- ▶ Use specified cable glands only.
- ▶ Check to ensure that the power supply matches the information on the nameplate.
- ▶ Switch off the power supply before connecting the device.
- ▶ Connect the potential matching line to the outer ground terminal before applying the power supply.

Required tools/accessories:

- For devices with a cover lock: Allen key AF3
- Wire stripper
- When using stranded cables: One ferrule for every wire to be connected.

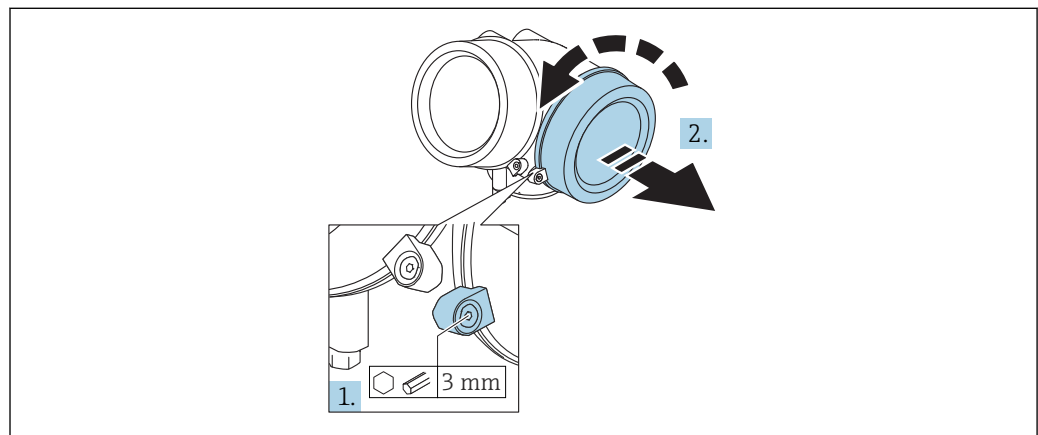
Opening connection compartment cover

A0021490

1. Loosen the screw of the securing clamp of the connection compartment cover using an Allen key (3 mm) and turn the clamp 90° clockwise.
2. Afterwards unscrew connection compartment cover and check lid gasket, replace if necessary.

Connecting

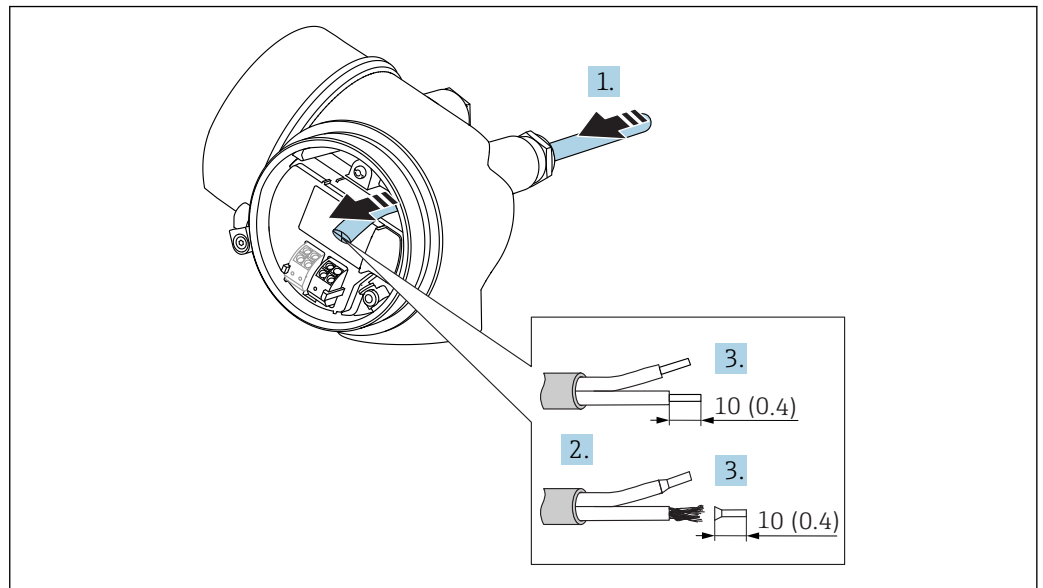

A0036418

15 Dimensions: mm (in)

1. Push the cable through the cable entry . To ensure tight sealing, do not remove the sealing ring from the cable entry.
2. Remove the cable sheath.
3. Strip the cable ends over a length of 10 mm (0.4 in). In the case of stranded cables, also fit ferrules.
4. Firmly tighten the cable glands.
5. Connect the cable in accordance with the terminal assignment.

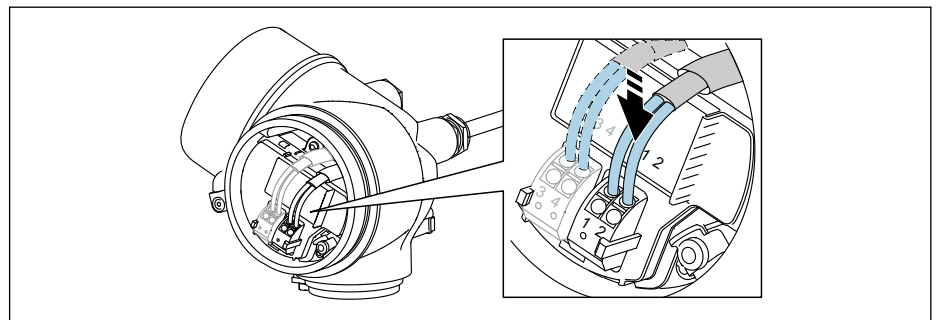

A0034682

6. If using shielded cables: Connect the cable shield to the ground terminal.

Plug-in spring-force terminals

In the case of devices without integrated overvoltage protection, electrical connection is via plug-in spring-force terminals. Rigid conductors or flexible conductors with ferrules can be inserted directly into the terminal without using the lever, and create a contact automatically.

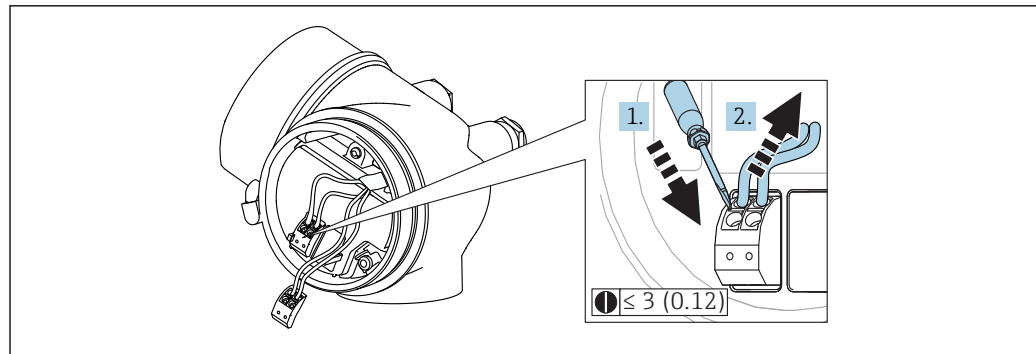

A0013661

16 Dimensions: mm (in)

To remove cables from the terminal:

1. Using a flat-blade screwdriver ≤ 3 mm, press down on the slot between the two terminal holes
2. while simultaneously pulling the cable end out of the terminal.

Closing connection compartment cover

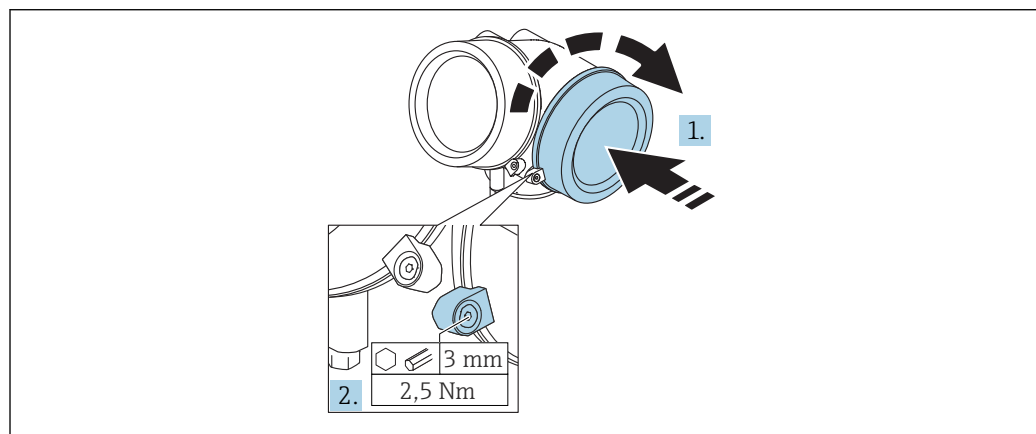

A0021491

1. Screw back firmly connection compartment cover.
2. Turning securing clamp 90° counterclockwise and tighten the clamp with 2.5 Nm (1.84 lbf ft) again using the Allen key (3 mm).

7.1.7 Post-connection check

<input type="checkbox"/>	Is the device or cable undamaged (visual check)?
<input type="checkbox"/>	Do the cables comply with the requirements ?
<input type="checkbox"/>	Do the cables have adequate strain relief?
<input type="checkbox"/>	Are all cable glands installed, securely tightened and leak-tight?
<input type="checkbox"/>	Does the supply voltage match the specifications on the nameplate?
<input type="checkbox"/>	Is the terminal assignment correct?
<input type="checkbox"/>	If required: Has protective ground connection been established ?
<input type="checkbox"/>	If supply voltage is present, is the device ready for operation and do values appear on the display module?
<input type="checkbox"/>	Are all housing covers installed and securely tightened?
<input type="checkbox"/>	Is the securing clamp tightened correctly?

8 Operation options

8.1 Overview

8.1.1 Local operation

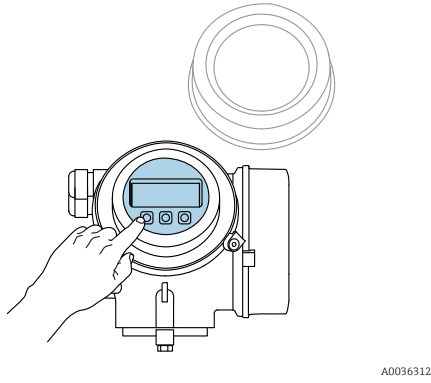
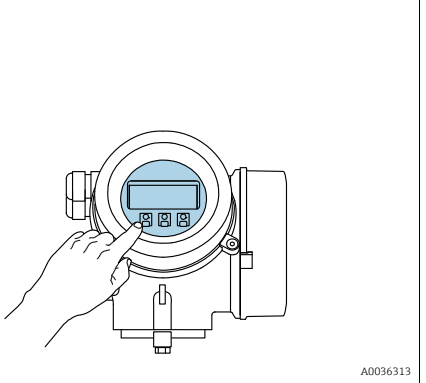
Operation with	Pushbuttons	Touch Control
Order code for "Display; Operation"	Option C "SD02"	Option E "SD03"
	 <p>A0036312</p>	 <p>A0036313</p>
Display elements	4-line display	4-line display white background lighting; switches to red in event of device error
	Format for displaying measured variables and status variables can be individually configured	
	Permitted ambient temperature for the display: -20 to +70 °C (-4 to +158 °F) The readability of the display may be impaired at temperatures outside the temperature range.	
Operating elements	local operation with 3 push buttons (⊕, ⊖, ⊞)	external operation via touch control; 3 optical keys: ⊕, ⊖, ⊞
	Operating elements also accessible in various hazardous areas	
Additional functionality	Data backup function The device configuration can be saved in the display module.	
	Data comparison function The device configuration saved in the display module can be compared to the current device configuration.	
	Data transfer function The transmitter configuration can be transmitted to another device using the display module.	

8.1.2 Operation with remote display and operating module FHX50

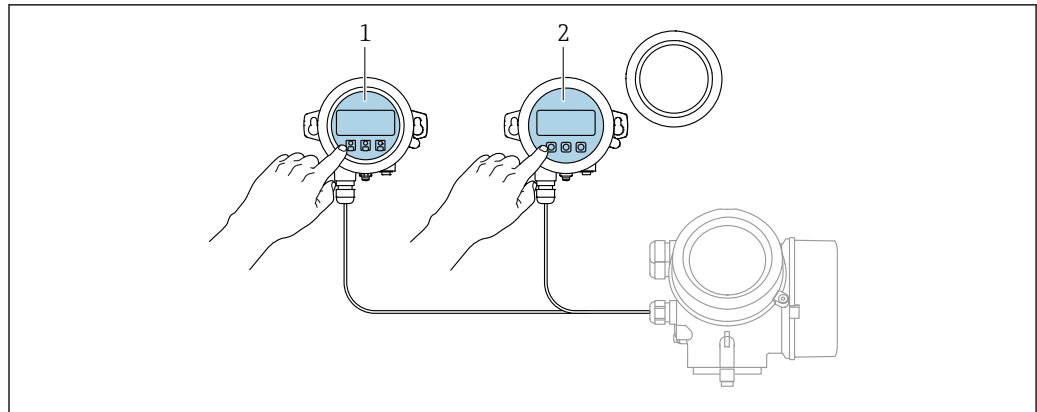

A0036314

17 FHX50 operating options

- 1 Display and operating module SD03, optical keys; can be operated through the glass of the cover
- 2 Display and operating module SD02, push buttons; cover must be removed

8.1.3 Operation via Bluetooth® wireless technology

Requirements

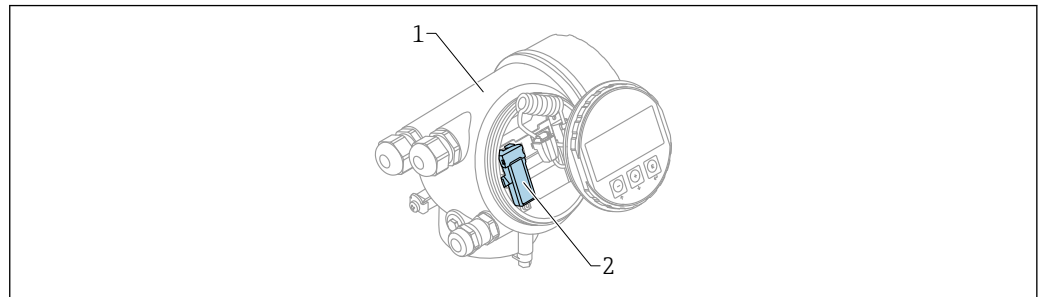

A0036790

18 Device with Bluetooth module

- 1 Electronics housing of the device
- 2 Bluetooth module

This operation option is only available for devices with Bluetooth module. There are the following options:

- The device has been ordered with a Bluetooth module:
Feature 610 "Accessory Mounted", option NF "Bluetooth"
- The Bluetooth module has been ordered as an accessory (ordering number: 71377355) and has been mounted. See Special Documentation SD02252F.

Operation via SmartBlue (app)

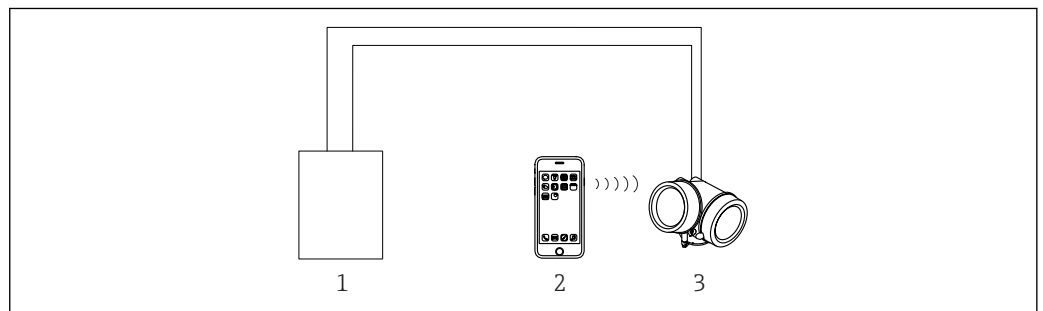

A0034939

19 Operation via SmartBlue (app)

- 1 Transmitter power supply unit
- 2 Smartphone / tablet with SmartBlue (app)
- 3 Transmitter with Bluetooth module

8.1.4 Remote operation

Via HART protocol

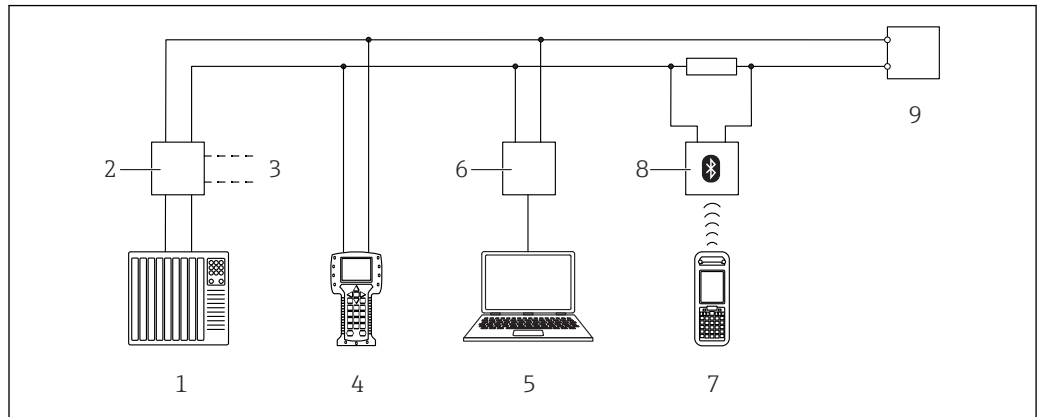

A0036169

20 Options for remote operation via HART protocol

- 1 PLC (Programmable Logic Controller)
- 2 Transmitter power supply unit, e.g. RN221N (with communication resistor)
- 3 Connection for Commubox FXA191, FXA195 and Field Communicator 375, 475
- 4 Field Communicator 475
- 5 Computer with operating tool (e.g. DeviceCare/FieldCare, AMS Device Manager, SIMATIC PDM)
- 6 Commubox FXA191 (RS232) or FXA195 (USB)
- 7 Field Xpert SFX350/SFX370
- 8 VIATOR Bluetooth modem with connecting cable
- 9 Transmitter

DeviceCare/FieldCare via service interface (CDI)

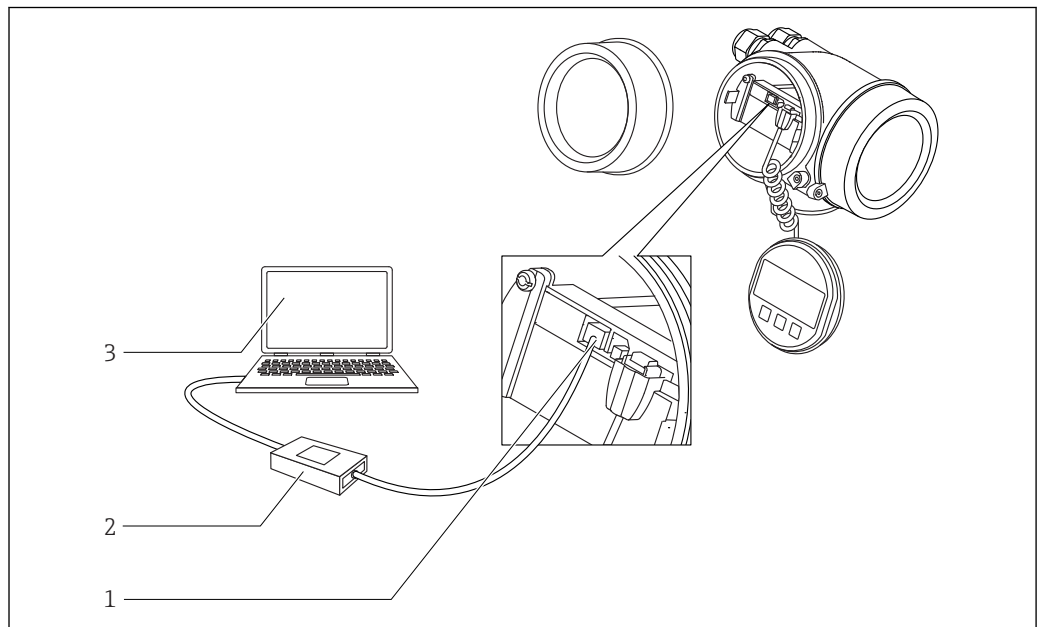

A0032466

21 DeviceCare/FieldCare via service interface (CDI)

- 1 Service interface (CDI) of the instrument (= Endress+Hauser Common Data Interface)
- 2 Commubox FXA291
- 3 Computer with DeviceCare/FieldCare operating tool

8.2 Structure and function of the operating menu

8.2.1 Structure of the operating menu

Menu	Submenu / parameter	Meaning
	Language ¹⁾	Defines the operating language of the on-site display
Commissioning ²⁾		Launches the interactive wizard for guided commissioning. Additional settings generally do not need to be made in the other menus when the wizard is finished.
Setup	Parameter 1 ... Parameter N	Once values have been set for these parameters, the measurement should generally be completely configured.
	Advanced setup	Contains additional submenus and parameters: <ul style="list-style-type: none"> ▪ to adapt the device to special measuring conditions. ▪ to process the measured value (scaling, linearization). ▪ to configure the signal output.
Diagnostics	Diagnostic list	Contains up to 5 currently active error messages.
	Event logbook ³⁾	Contains the last 20 messages (which are no longer active).
	Device information	Contains information for identifying the device.
	Measured values	Contains all current measured values.
	Data logging	Contains the history of the individual measuring values.
	Simulation	Is used to simulate measured values or output values.
	Device check	Contains all parameters needed to check the measurement capability of the device.
Expert ⁵⁾ Contains all parameters of the device (including those that are already in one of the other menus). This menu is organized according to the function blocks of the device. The parameters of the Expert menu are described in: GPO1101F (HART)	System	Contains all higher-order device parameters that do not concern the measurement or measured value communication.
	Sensor	Contains all parameters needed to configure the measurement.
	Output	<ul style="list-style-type: none"> ▪ Contains all parameters needed to configure the current output. ▪ Contains all parameters needed to configure the switch output (PFS).

Menu	Submenu / parameter	Meaning
	Communication	Contains all parameters needed to configure the digital communication interface.
	Diagnostics	Contains all parameters needed to detect and analyze operational errors.

- 1) If operating via operating tools (e.g. FieldCare), the "Language" parameter is located under "Setup → Advanced setup → Display"
- 2) Only if operating via an FDT/DTM system
- 3) only available with local operation
- 4) only available if operating via DeviceCare or FieldCare
- 5) On entering the "Expert" menu, an access code is always requested. If a customer specific access code has not been defined, "0000" has to be entered.

8.2.2 User roles and related access authorization

The two user roles **Operator** and **Maintenance** have different write access to the parameters if a device-specific access code has been defined. This protects the device configuration via the local display from unauthorized access →  47.

Access authorization to parameters

User role	Read access		Write access	
	Without access code (from the factory)	With access code	Without access code (from the factory)	With access code
Operator	✓	✓	✓	--
Maintenance	✓	✓	✓	✓

If an incorrect access code is entered, the user obtains the access rights of the **Operator** role.

 The user role with which the user is currently logged on is indicated by the **Access status display** parameter (for display operation) or **Access status tooling** parameter (for tool operation).

8.2.3 Data access - Security

Write protection via access code

Using the device-specific access code, the parameters for the measuring device configuration are write-protected and their values can no longer be changed via local operation.

Define access code via local display

1. Navigate to: Setup → Advanced setup → Administration → Define access code → Define access code
2. Define a max. 4-digit numeric code as an access code.
3. Repeat the same code in **Confirm access code** parameter.
 - ↳ The -symbol appears in front of all write-protected parameters.



Define access code via operating tool (e.g. FieldCare)

1. Navigate to: Setup → Advanced setup → Administration → Define access code
2. Define a max. 4-digit numeric code as an access code.
 - ↳ Write protection is active.



Parameters that can always be changed

The write protection does not include certain parameters that do not affect the measurement. Despite the defined access code, they can always be modified, even if the other parameters are locked.



The device automatically locks the write-protected parameters again if a key is not pressed for 10 minutes in the navigation and editing view. The device locks the write-protected parameters automatically after 60 s if the user skips back to the measured value display mode from the navigation and editing view.

-  If write access is activated via access code, it can be also be deactivated only via the access code →  48.
- In the "Description of Device Parameters" documents, each write-protected parameter is identified with the -symbol.

Disabling write protection via access code

If the -symbol appears on the local display in front of a parameter, the parameter is write-protected by a device-specific access code and its value cannot be changed at the moment using the local display →  47.

The locking of the write access via local operation can be disabled by entering the device-specific access code.

1. After you press , the input prompt for the access code appears.
2. Enter the access code.
 - ↳ The -symbol in front of the parameters disappears; all previously write-protected parameters are now re-enabled.

Deactivation of the write protection via access code

Via local display

1. Navigate to: Setup → Advanced setup → Administration → Define access code → Define access code
2. Enter **0000**.
3. Repeat **0000** in **Confirm access code** parameter.
 - ↳ The write protection is deactivated. Parameters can be changed without entering an access code.

Via an operating tool (e.g. FieldCare)

1. Navigate to: Setup → Advanced setup → Administration → Define access code
2. Enter **0000**.
 - ↳ The write protection is deactivated. Parameters can be changed without entering an access code.

Write protection via write protection switch

Unlike parameter write protection via a user-specific access code, this allows write access to the entire operating menu - except for the **"Contrast display" parameter** - to be locked.

The parameter values are now read only and cannot be edited any more (exception **"Contrast display" parameter**):

- Via local display
- Via service interface (CDI)
- Via HART protocol

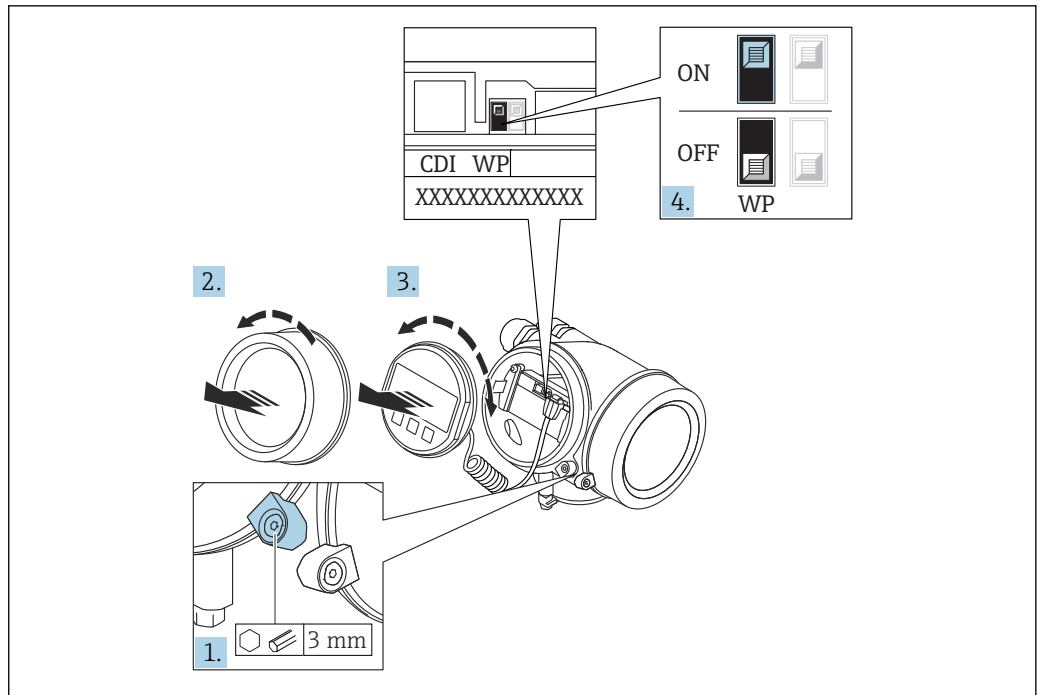

A0026157

1. Loosen the securing clamp.
2. Unscrew the electronics compartment cover.
3. Pull out the display module with a gentle rotational movement. To make it easier to access the lock switch, attach the display module to the edge of the electronics compartment.

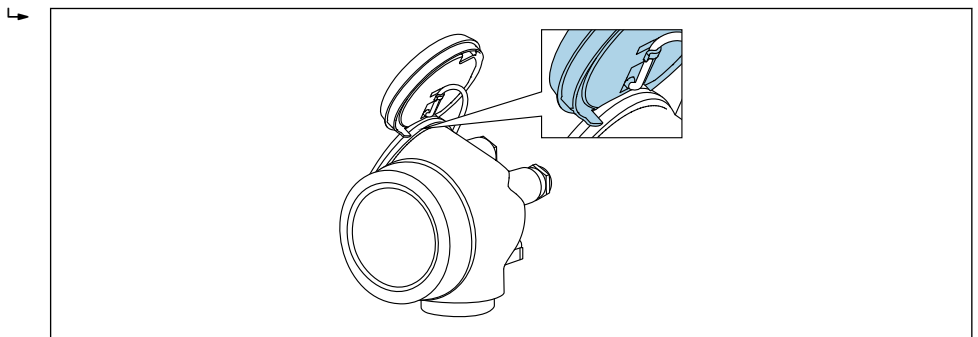

A0036086

4. Setting the write protection switch (WP) on the main electronics module to the **ON** position enables hardware write protection. Setting the write protection switch (WP) on the main electronics module to the **OFF** position (factory setting) disables hardware write protection.
 - ↳ If the hardware write protection is enabled: The **Hardware locked** option is displayed in the **Locking status** parameter. In addition, on the local display the -symbol appears in front of the parameters in the header of the operational display and in the navigation view.

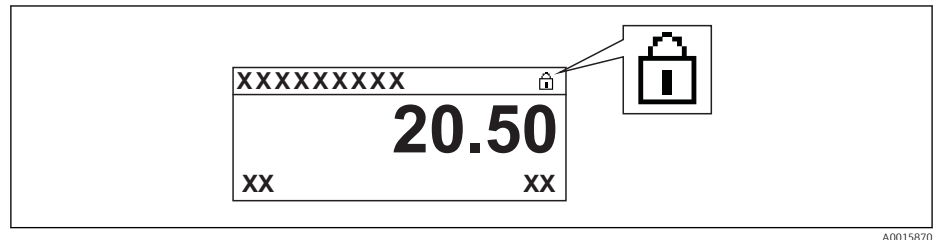

If the hardware write protection is disabled: No option is displayed in the **Locking status** parameter. On the local display, the -symbol disappears from in front of the parameters in the header of the operational display and in the navigation view.

5. Feed the cable into the gap between the housing and main electronics module and plug the display module into the electronics compartment in the desired direction until it engages.
6. Reverse the removal procedure to reassemble the transmitter.

Enabling and disabling the keypad lock

The keypad lock makes it possible to block access to the entire operating menu via local operation. As a result, it is no longer possible to navigate through the operating menu or change the values of individual parameters. Users can only read the measured values on the operational display.

The keypad lock is switched on and off via the context menu.

Switching on the keypad lock

For the SD03 display only

The keypad lock is switched on automatically:

- If the device has not been operated via the display for > 1 minute.
- Each time the device is restarted.

To activate the keylock manually:

1. The device is in the measured value display.
Press  for at least 2 seconds.
↳ A context menu appears.
2. In the context menu select the **Keylock on** option.
↳ The keypad lock is switched on.

 If the user attempts to access the operating menu while the keypad lock is active, the message **Keylock on** appears.

Switching off the keypad lock

1. The keypad lock is switched on.
Press  for at least 2 seconds.
↳ A context menu appears.
2. In the context menu select the **Keylock off** option.
↳ The keypad lock is switched off.

Bluetooth® wireless technology

Signal transmission via Bluetooth® wireless technology uses a cryptographic technique tested by the Fraunhofer Institute

- The device is not visible via *Bluetooth®* wireless technology without the SmartBlue app
- Only one point-to-point connection between **one** sensor and **one** smartphone or tablet is established

8.3 Display and operating module

8.3.1 Display appearance

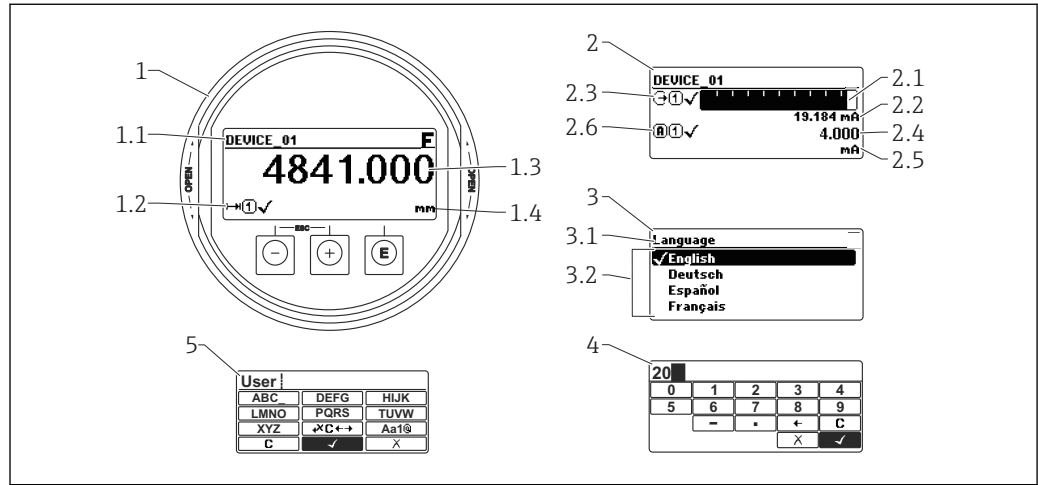





A0012635

22 Appearance of the display and operation module for on-site operation

- 1 Measured value display (1 value max. size)
- 1.1 Header containing tag and error symbol (if an error is active)
- 1.2 Measured value symbols
- 1.3 Measured value
- 1.4 Unit
- 2 Measured value display (1 bargraph + 1 value)
- 2.1 Bargraph for measured value 1
- 2.2 Measured value 1 (including unit)
- 2.3 Measured value symbols for measured value 1
- 2.4 Measured value 2
- 2.5 Unit for measured value 2
- 2.6 Measured value symbols for measured value 2
- 3 Representation of a parameter (here: a parameter with selection list)
- 3.1 Header containing parameter name and error symbol (if an error is active)
- 3.2 Selection list; marks the current parameter value.
- 4 Input matrix for numbers
- 5 Input matrix for alphanumeric and special characters



Display symbols for the submenus

Symbol	Meaning
 <small>A0018367</small>	<p>Display/operation</p> <p>Is displayed:</p> <ul style="list-style-type: none"> in the main menu next to the selection "Display/operation" in the header, if you are in the "Display/operation" menu
 <small>A0018364</small>	<p>Setup</p> <p>Is displayed:</p> <ul style="list-style-type: none"> in the main menu next to the selection "Setup" in the header, if you are in the "Setup" menu
 <small>A0018365</small>	<p>Expert</p> <p>Is displayed:</p> <ul style="list-style-type: none"> in the main menu next to the selection "Expert" in the header, if you are in the "Expert" menu
 <small>A0018366</small>	<p>Diagnostics</p> <p>Is displayed:</p> <ul style="list-style-type: none"> in the main menu next to the selection "Diagnostics" in the header, if you are in the "Diagnostics" menu











Status signals

<p>F</p> <small>A0032902</small>	<p>"Failure"</p> <p>A device error is present. The measured value is no longer valid.</p>
<p>C</p> <small>A0032903</small>	<p>"Function check"</p> <p>The device is in service mode (e.g. during a simulation).</p>
<p>S</p> <small>A0032904</small>	<p>"Out of specification"</p> <p>The device is operated:</p> <ul style="list-style-type: none"> Outside of its technical specifications (e.g. during startup or a cleaning) Outside of the configuration carried out by the user (e.g. level outside configured span)
<p>M</p> <small>A0032905</small>	<p>"Maintenance required"</p> <p>Maintenance is required. The measured value is still valid.</p>







Display symbols for the locking state

Symbol	Meaning
 <small>A0013148</small>	<p>Display parameter</p> <p>Marks display-only parameters which can not be edited.</p>
 <small>A0013150</small>	<p>Device locked</p> <ul style="list-style-type: none"> In front of a parameter name: The device is locked via software and/or hardware. In the header of the measured value screen: The device is locked via hardware.

Measured value symbols

Symbol	Meaning
Measured values	
 A0032892	Level
 A0032893	Distance
 A0032908	Current output
 A0032894	Measured current
 A0032895	Terminal voltage
 A0032896	Temperature of the electronics or the sensor
Measuring channels	
 A0032897	Measuring channel 1
 A0032898	Measuring channel 2
Status of the measured value	
 A0018361	Status "Alarm" The measurement is interrupted. The output assumes the defined alarm value. A diagnostic message is generated.
 A0018360	Status "Warning" The device continues measuring. A diagnostic message is generated.

8.3.2 Operating elements

Key	Meaning
 <small>A0018330</small>	<p>Minus key</p> <p><i>For menu, submenu</i> Moves the selection bar upwards in a picklist.</p> <p><i>For text and numeric editor</i> In the input mask, moves the selection bar to the left (backwards).</p>
 <small>A0018329</small>	<p>Plus key</p> <p><i>For menu, submenu</i> Moves the selection bar downwards in a picklist.</p> <p><i>For text and numeric editor</i> In the input mask, moves the selection bar to the right (forwards).</p>
 <small>A0018328</small>	<p>Enter key</p> <p><i>For measured value display</i></p> <ul style="list-style-type: none"> ▪ Pressing the key briefly opens the operating menu. ▪ Pressing the key for 2 s opens the context menu. <p><i>For menu, submenu</i></p> <ul style="list-style-type: none"> ▪ Pressing the key briefly Opens the selected menu, submenu or parameter. ▪ Pressing the key for 2 s for parameter: If present, opens the help text for the function of the parameter. <p><i>For text and numeric editor</i></p> <ul style="list-style-type: none"> ▪ Pressing the key briefly <ul style="list-style-type: none"> - Opens the selected group. - Carries out the selected action. ▪ Pressing the key for 2 s confirms the edited parameter value.
 <small>A0032909</small>	<p>Escape key combination (press keys simultaneously)</p> <p><i>For menu, submenu</i></p> <ul style="list-style-type: none"> ▪ Pressing the key briefly <ul style="list-style-type: none"> - Exits the current menu level and takes you to the next higher level. - If help text is open, closes the help text of the parameter. ▪ Pressing the key for 2 s returns you to the measured value display ("home position"). <p><i>For text and numeric editor</i> Closes the text or numeric editor without applying changes.</p>
 <small>A0032910</small>	<p>Minus/Enter key combination (press and hold down the keys simultaneously)</p> <p>Reduces the contrast (brighter setting).</p>
 <small>A0032911</small>	<p>Plus/Enter key combination (press and hold down the keys simultaneously)</p> <p>Increases the contrast (darker setting).</p>



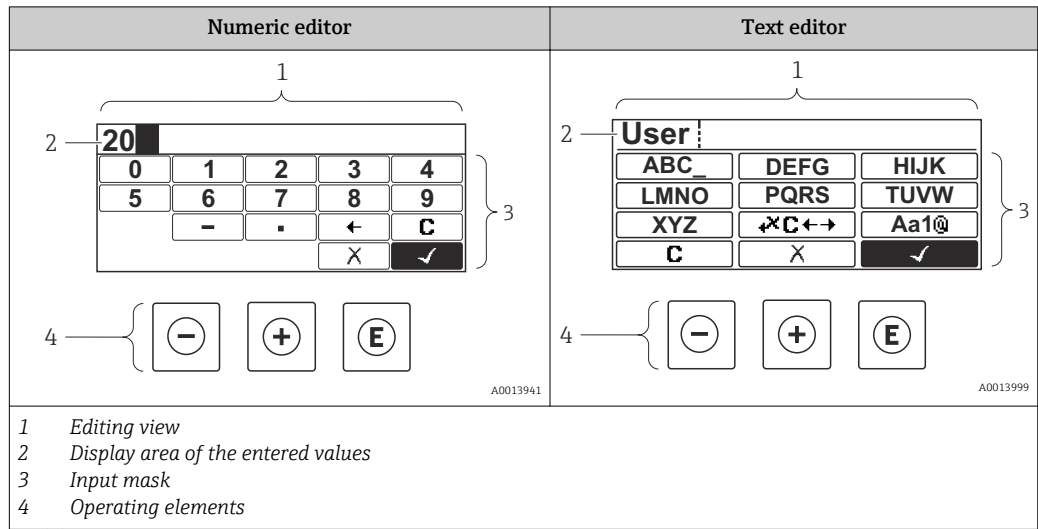



8.3.3 Entering numbers and text

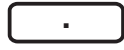

Input mask





The following input symbols are available in the input mask of the numeric and text editor:

Numeric editor symbols

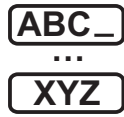
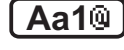



Symbol	Meaning
 <small>A0013998</small>	Selection of numbers from 0 to 9.
 <small>A0016619</small>	Inserts decimal separator at the input position.
 <small>A0016620</small>	Inserts minus sign at the input position.
 <small>A0013985</small>	Confirms selection.
 <small>A0016621</small>	Moves the input position one position to the left.
 <small>A0013986</small>	Exits the input without applying the changes.
 <small>A0014040</small>	Clears all entered characters.

Text editor symbols

Symbol	Meaning
 <small>A0013997</small>	Selection of letters from A to Z
 <small>A0013981</small>	Toggle <ul style="list-style-type: none"> Between upper-case and lower-case letters For entering numbers For entering special characters

 <small>A0013985</small>	Confirms selection.
 <small>A0013987</small>	Switches to the selection of the correction tools.
 <small>A0013986</small>	Exits the input without applying the changes.
 <small>A0014040</small>	Clears all entered characters.

Correction symbols under 

Symbol	Meaning
 <small>A0032907</small>	Clears all entered characters.
 <small>A0018324</small>	Moves the input position one position to the right.
 <small>A0018326</small>	Moves the input position one position to the left.
 <small>A0032906</small>	Deletes one character immediately to the left of the input position.

8.3.4 Opening the context menu

Using the context menu, the user can call up the following menus quickly and directly from the operational display:

- Setup
- Conf. backup disp.
- Env. curve
- Keylock on

Opening and closing the context menu

The user is in the operational display.

1. Press \square for 2 s.
 - ↳ The context menu opens.

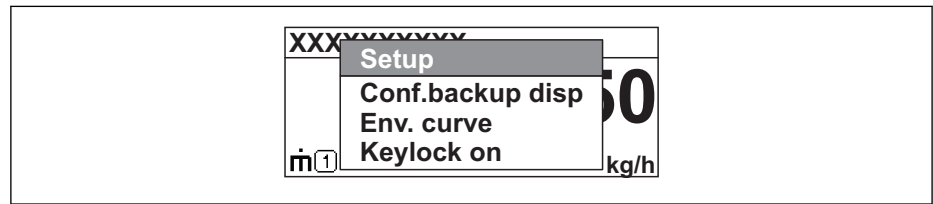

2. Press \square + \oplus simultaneously.
 - ↳ The context menu is closed and the operational display appears.

Calling up the menu via the context menu

1. Open the context menu.
2. Press \oplus to navigate to the desired menu.
3. Press \square to confirm the selection.
 - ↳ The selected menu opens.

8.3.5 Envelope curve on the display and operating module

In order to assess the measuring signal, the envelope curve and - if a mapping has been recorded - the mapping curve can be displayed:

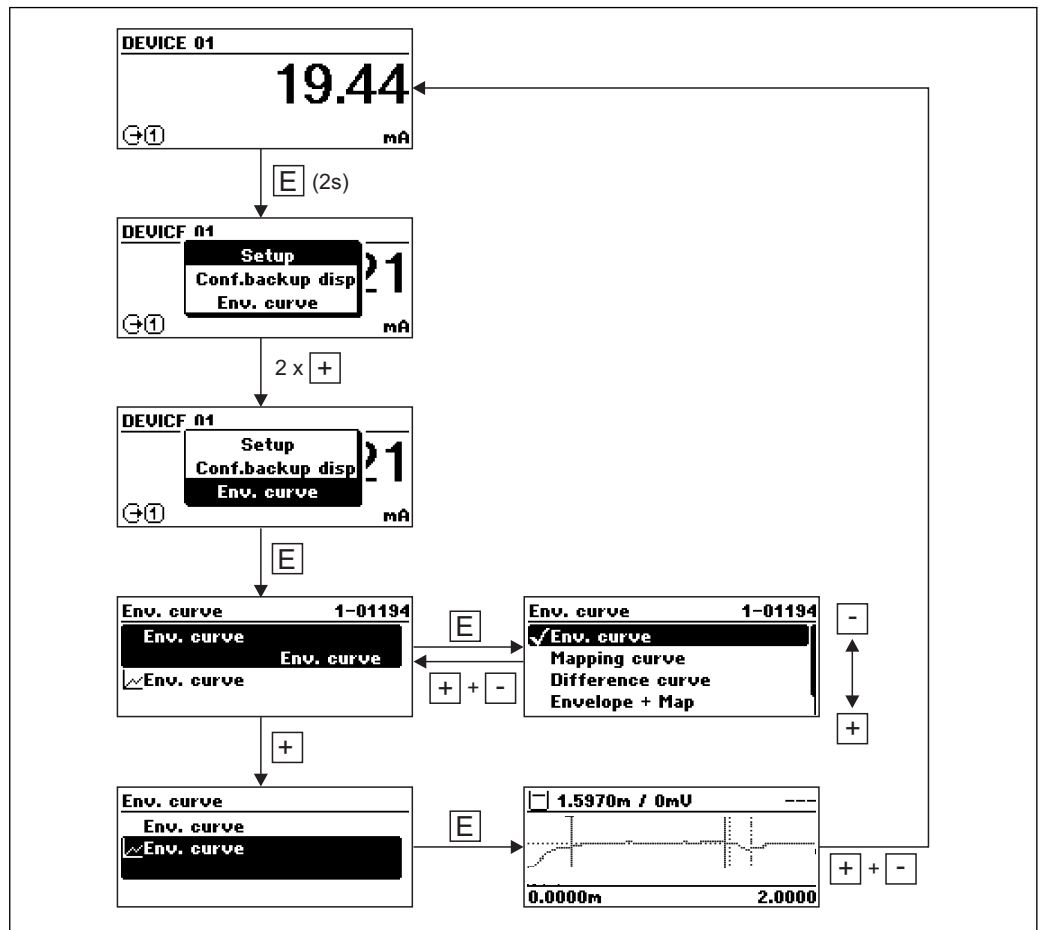

A0014277

9 System integration via HART protocol

9.1 Overview of the Device Description files (DD)

Manufacturer ID	17 (0x11)
Device type	0x112B
HART specification	7.0
DD files	For information and files see: <ul style="list-style-type: none"> ▪ www.endress.com ▪ www.hartcomm.org

9.2 Measured values via HART protocol

On delivery the following measuring values are assigned to the HART device variables:

Device variable	Measuring value
Primary variable (PV)	Level linearized
Secondary variable (SV)	Distance
Tertiary variable (TV)	Absolute echo amplitude
Quaternary variable (QV)	Relative echo amplitude

 The allocation of the device variables can be changed in the operating menu:
Expert → Communication → Output

 In a HART multidrop loop only one device may use the output current for signal transmission. For all other devices the following must be set:

- "Current span" parameter = "Fixed current" option
- "Fixed current" parameter = 4 mA

10 Commissioning via SmartBlue (app)

10.1 Requirements

Device requirements

Commissioning via SmartBlue is only possible if the device has a Bluetooth module.

System requirements SmartBlue

SmartBlue is available as download for Android devices from the Google Play Store and for iOS devices from the iTunes Store.

- iOS devices:
 - iPhone 4S or higher from iOS9.0; iPad2 or higher from iOS9.0; iPod Touch 5th generation or higher from iOS9.0
- Devices with Android:
 - from Android 4.4 KitKat and *Bluetooth*® 4.0

Initial password

The ID of the Bluetooth module serves as the initial password used to establish the first connection to the device. It can be found:

- on the information sheet which is supplied with the device. This serial number specific sheet is also stored in W@M.
- on the nameplate of the Bluetooth module.

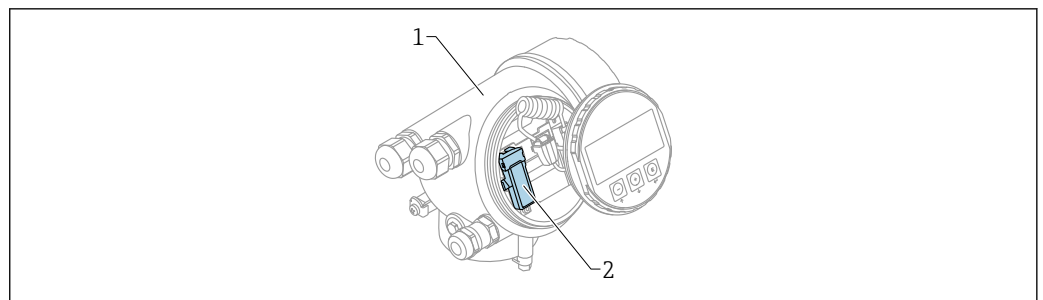

A0036790

23 Device with Bluetooth module

1 Electronics housing of the device

2 Nameplate of the Bluetooth module; the ID on this nameplate serves as initial password.

- i** All login data (including the password changed by the user) are not stored in the device but in the Bluetooth module. This must be taken into account when the module is removed from one device and inserted into a different device.

10.2 Commissioning

Download and install SmartBlue

1. To download the app, scan the QR code or enter "SmartBlue" in the search field

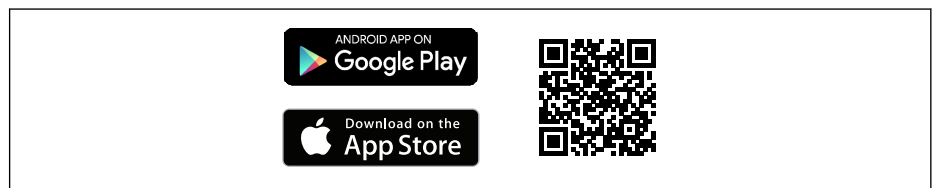

A0033202

24 Download link

2. Start SmartBlue



A0029747

25 SmartBlue pictogram

3. Select device from displayed livelist (available devices only)

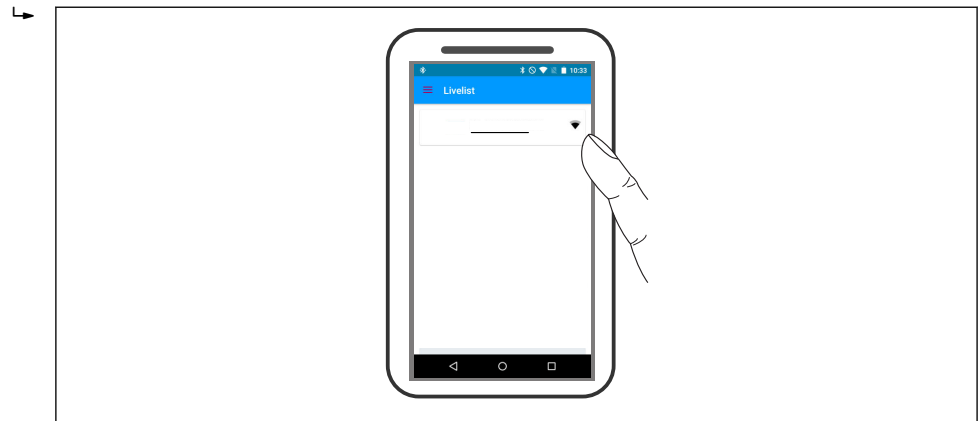

A0029502

26 Livelist

i Only one point-to-point connection can be established between **one** sensor and **one** smartphone or tablet.

4. Perform login

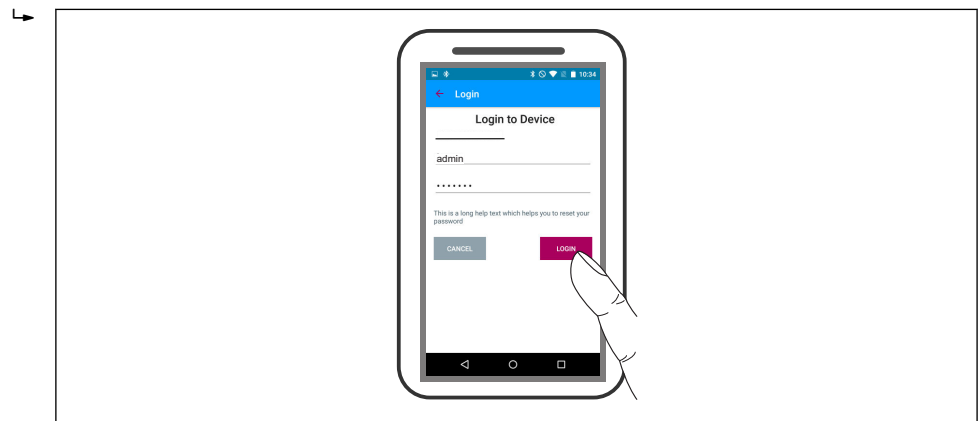

A0029503

27 Login

5. Enter user name -> admin
6. Enter initial password -> ID of the Bluetooth module
7. Change the password after logging in for the first time

- 8. By wiping from the side, additional information (e.g. main menu) can be dragged into the image

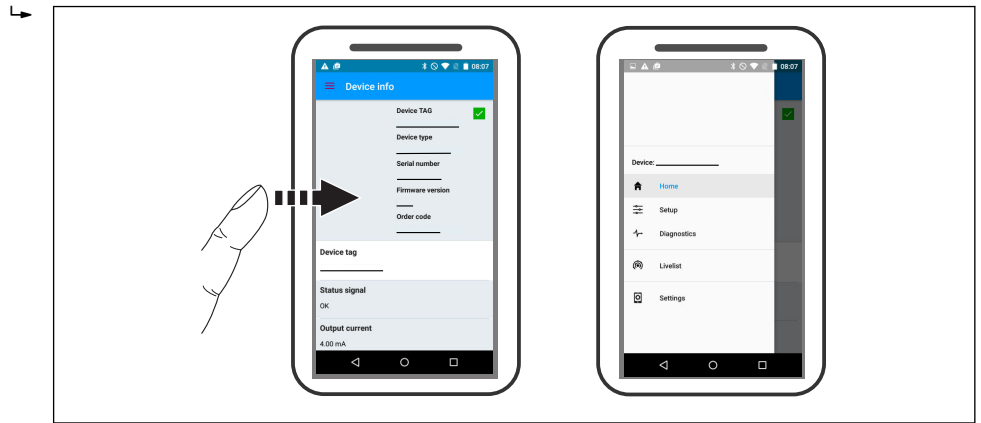

28 Main menu

i Envelope curves can be displayed and recorded

Additionally to the envelope curve, the following values are displayed:

- D = Distance
- L = Level
- A = Absolute amplitude
- In the case of screenshots, the displayed section (zoom function) is saved
- In video sequences, always the whole area without zoom function is saved

It is also possible to send envelope curves (video sequences) using the relevant smartphone or tablet functions.

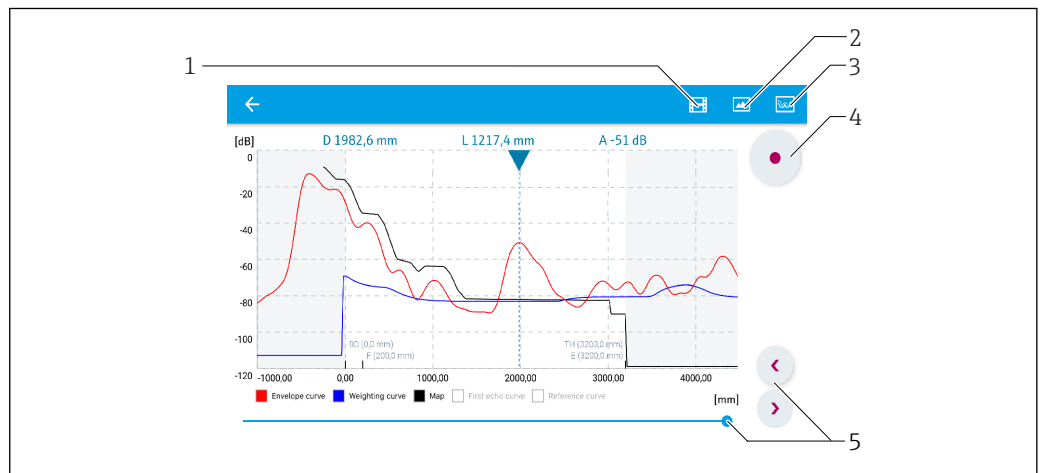

29 Envelope curve display (example) in SmartBlue; Android view

- 1 Record video
- 2 Create screenshot
- 3 Navigation to mapping menu
- 4 Start / stop video recording
- 5 Move time on time axis

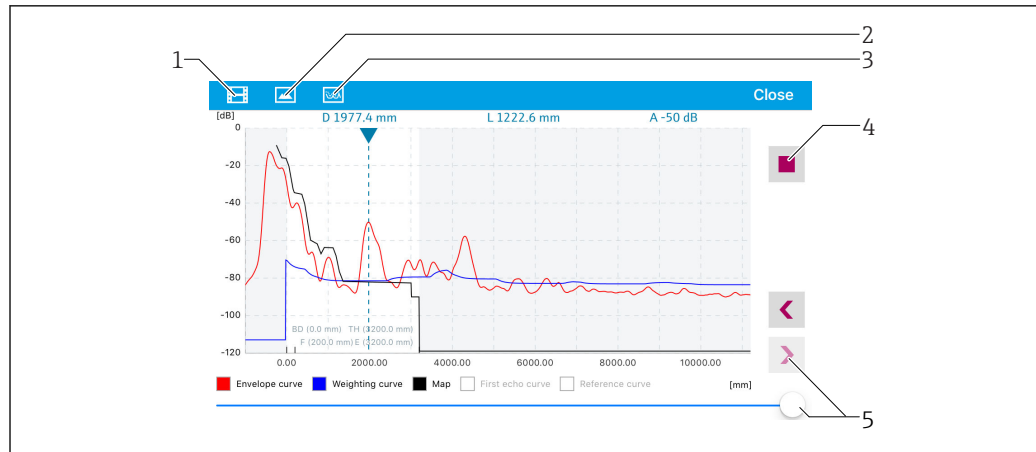

A0029487

30 Envelope curve display (example) in SmartBlue; IoS view

- 1 Record video
- 2 Create screenshot
- 3 Navigation to mapping menu
- 4 Start / stop video recording
- 5 Move time on time axis

11 Commissioning via wizard

A wizard guiding the user through the initial setup is available in FieldCare and DeviceCare ⁴⁾.

1. Connect the device to FieldCare or DeviceCare → 44.
2. Open the device in FieldCare or DeviceCare.
 - ↳ The dashboard (home page) of the device appears:

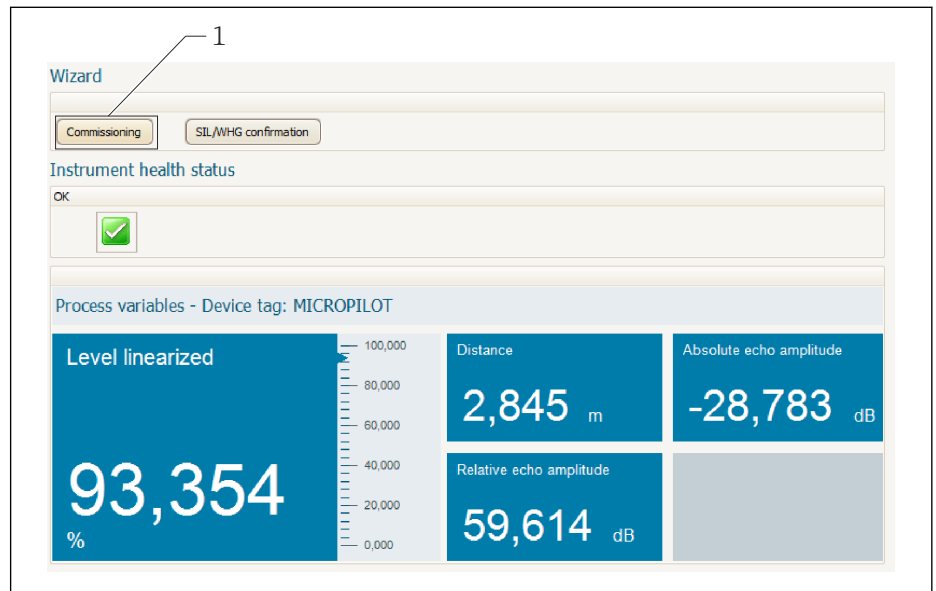

1 "Commissioning" button calls up the wizard.

3. Click on "Commissioning" to call up the wizard.
4. Enter or select the appropriate value for each parameter. These values are immediately written to the device.
5. Click "Next" to switch to the next page.
6. After finishing the last page, click "End of sequence" to close the wizard.

i If the wizard is cancelled before all necessary parameters have been set, the device may be in an undefined state. A reset to the default settings is recommended in this case.

4) DeviceCare is available for download at www.software-products.endress.com. The download requires a registration in the Endress+Hauser software portal.

12 Commissioning via operating menu

12.1 Installation and function check

Make sure that all final checks have been completed before you start up your measuring point:

- Checklist "Post-installation check" → 30
- Checklist "Post-connection check" → 40

12.2 Setting the operating language

Factory setting: English or ordered local language

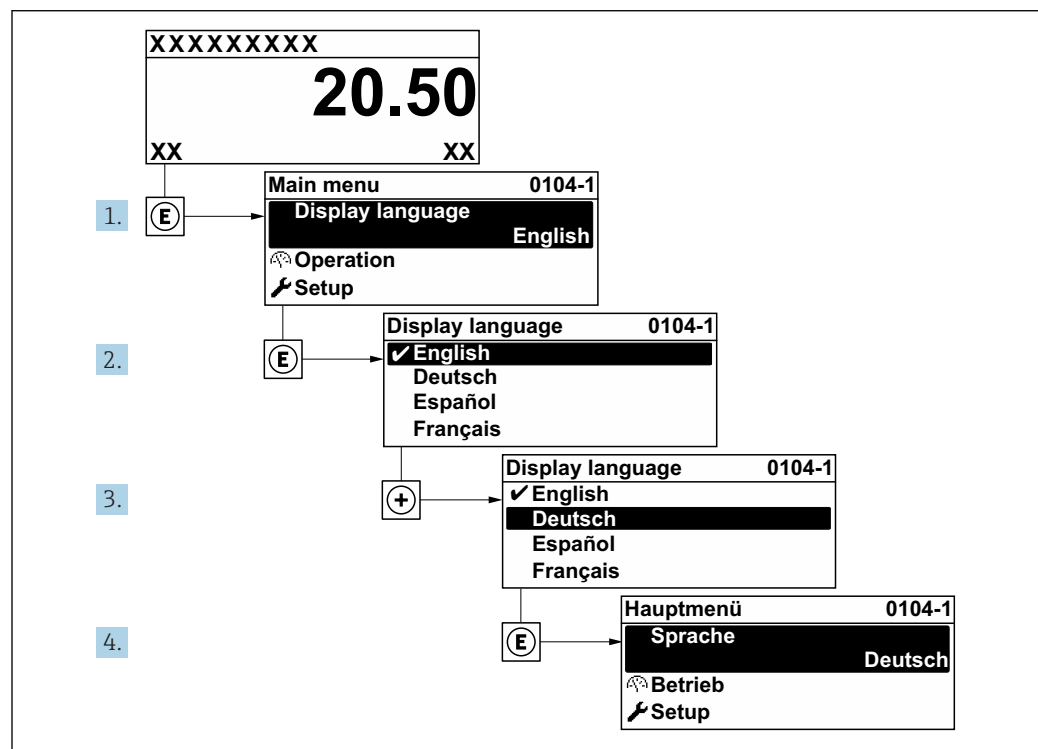

A0029420

31 Using the example of the local display

12.3 Configuration of a level measurement

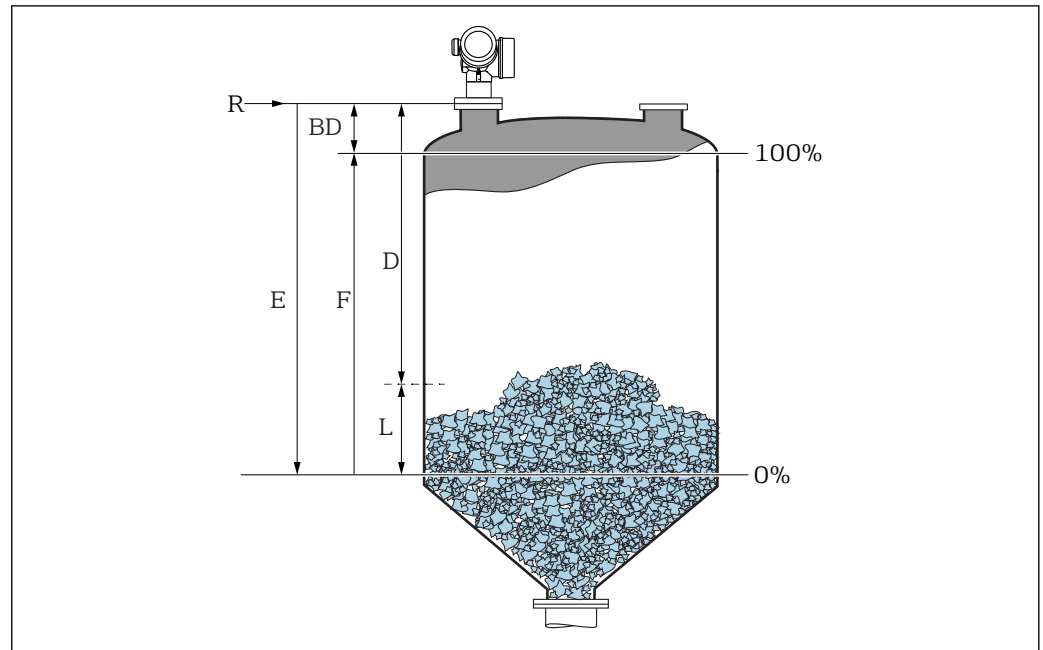

32 Configuration parameters for level measurements in bulk solids

- R Reference point of the measurement
- D Distance
- L Level
- E Empty calibration (= zero)
- F Full calibration (= span)

1. Setup → Device tag
 - ↳ Enter device tag.
2. Setup → Distance unit
 - ↳ Select distance unit.
3. Setup → Bin type
 - ↳ Select bin type.
4. Setup → Max. filling speed solid
 - ↳ Enter maximum expected filling speed.
5. Setup → Max. draining speed solid
 - ↳ Enter maximum expected draining speed.
6. Setup → Empty calibration
 - ↳ Enter empty distance E (Distance from reference point R to the 0% level)
7. If the measuring range covers only an upper part of the tank or silo (E is much less than the tank/silo height), it is mandatory to enter the actual tank or silo height into the parameter. If there is an outlet cone, the tank or silo height should not be adjusted as usually E is not much less than the tank/silo height in these applications.
 - ↳ Setup → Advanced setup → Level → Tank/silo height
8. Setup → Full calibration
 - ↳ Enter full distance F (Distance from the 0% to the 100% level).
9. Setup → Level
 - ↳ Indicates the measured level L.
10. Setup → Distance
 - ↳ Indicates the measured distance from the reference point R to the level L.

11. Setup → Signal quality
 - ↳ Indicates the quality of the evaluated level echo.
 12. Setup → Mapping → Confirm distance
 - ↳ Compare distance indicated on the display to real distance in order to start the recording of an interference echo map.
 13. Setup → Advanced setup → Level → Level unit
 - ↳ Select level unit: %, m, mm, ft, in (Factory setting: %)
-  It is strongly recommended to adjust the maximum filling and draining speed to the actual process.

12.4 Recording the reference curve

After the configuration of the measurement it is recommended to record the current envelope curve as a reference curve. The reference curve can be used later on in the process for diagnostic purposes. To record the reference curve use the **Save reference curve** parameter.

Navigation in the menu

Expert → Diagnostics → Envelope diagnostics → Save reference curve

Meaning of the options

- No
No action
- Yes
The current envelope curve is saved as reference curve.

 The reference curve can only be displayed in the envelope curve diagram of FieldCare after it has been loaded from the device into FieldCare. This is performed by the "Load Reference Curve" function in FieldCare.



 33 The "Load Reference Curve" function

12.5 Configuration of the on-site display

12.5.1 Factory settings of the on-site display

Parameter	Factory setting
Language	English
Value 1 display	Level linearized
Value 2 display	None
Value 3 display	None
Value 4 display	None

12.5.2 Adjustment of the on-site display

The on-site display can be adjusted in the following submenu:
Setup → Advanced setup → Display

12.6 Configuration of the current outputs

12.6.1 Factory setting of the current outputs

Current output	Allocated measuring value	4 mA value	20 mA value
1	Level linearized	0% or the corresponding linearized value	100% or the corresponding linearized value
2 ¹⁾	Distance	0	Empty calibration

1) for devices with 2 current outputs

12.6.2 Adjustment of the current outputs

The current outputs can be adjusted in the following menus:

Basic settings

Setup → Advanced setup → Current output 1 to 2

Advanced settings

Expert → Output → Current output 1

See "Description of Device Parameters", GP01101F

12.7 Configuration management

After commissioning, you can save the current device configuration, copy it to another measuring point or restore the previous device configuration. You can do so using the **Configuration management** parameter and its options.

Navigation path in the operating menu

Setup → Advanced setup → Configuration backup display → Configuration management

Meaning of the options

- **Cancel**

No action is executed and the user exits the parameter.

- **Execute backup**

A backup copy of the current device configuration in the HistoROM (built-in in the device) is saved to the display module of the device. The backup copy comprises the transmitter and sensor data of the device.

- **Restore**

The last backup copy of the device configuration is copied from the display module to the HistoROM of the device. The backup copy comprises the transmitter and sensor data of the device.

- **Duplicate**

The transmitter configuration is duplicated to another device using the transmitter display module. The following parameters, which characterize the individual measuring point are **not** included in the transmitted configuration:

- HART date code
- HART short tag
- HART message
- HART descriptor
- HART address
- Device tag
- Medium type

- **Compare**

The device configuration saved in the display module is compared to the current device configuration of the HistoROM. The result of this comparison is displayed in the **Comparison result** parameter angezeigt.

- **Clear backup data**

The backup copy of the device configuration is deleted from the display module of the device.



While this action is in progress, the configuration cannot be edited via the local display and a message on the processing status appears on the display.





If an existing backup is restored to a different device using the **Restore** option, it may occur that some device functionalities are no longer available. In some cases even a device reset will not restore the original status.

In order to transmit a configuration to a different device, the **Duplicate** option should always be used.

12.8 Protection of the settings against unauthorized changes





There are two ways to protect the settings against unauthorized changes:

- Via parameter settings (software locking) →  47
- Via locking switch (hardware locking) →  48

13 Diagnostics and troubleshooting

13.1 General trouble shooting

13.1.1 General errors

Error	Possible cause	Remedial action
Device does not respond.	Supply voltage does not match the value indicated on the nameplate.	Connect the correct voltage.
	The polarity of the supply voltage is wrong.	Correct the polarity.
	The cables do not contact the terminals properly.	Ensure electrical contact between the cable and the terminal.
Values on the display invisible	Contrast setting is too weak or too strong.	<ul style="list-style-type: none"> ▪ Increase contrast by pressing  and  simultaneously. ▪ Decrease contrast by pressing  and  simultaneously.
	The plug of the display cable is not connected correctly.	Connect the plug correctly.
	Display is defective.	Replace display.
"Communication error" is indicated on the display when starting the device or connecting the display	Electromagnetic interference	Check grounding of the device.
	Broken display cable or display plug.	Replace display.
Duplicating of the parameters from one device to another via the display doesn't work. Only the "Save" and "Abort" options are available.	Display with backup is not recognized if no data backup has been performed at the device before.	Connect display (with the backup) and restart the device.
Output current <3.6 mA	Signal cable connection incorrect.	Check connection.
	Electronics is defective.	Replace electronics.
HART communication does not function.	Communication resistor missing or incorrectly installed.	Install the communication resistor(250 Ω) correctly.
	Commubox connected incorrectly.	Connect Commubox correctly.
	Commubox not switched to HART mode.	Set the selection switch of the Commubox to the HART position.
CDI communication does not work.	Wrong setting of the COM port on the computer.	Check the setting of the COM port on the computer and change it if necessary.
Device measures incorrectly.	Parametrization error	Check and adjust parameterization.
Device not accessible via SmartBlue	No Bluetooth connection	Enable Bluetooth function on smartphone or tablet.
	Device already linked to another smartphone / tablet	Disconnect device from smartphone/tablet.
	Bluetooth module not connected.	Connect Bluetooth module (see SD02252F).
Login via SmartBlue not possible	Device is being put into operation for the first time	Enter initial password (ID of the Bluetooth module) and change.
Device cannot be operated via SmartBlue	Incorrect password entered	Enter correct password
	Password forgotten	Contact Endress+Hauser Service (www.addresses.endress.com)

13.1.2 Error - SmartBlue operation

Error	Possible cause	Solution
Device is not visible in the live list	No Bluetooth connection	Enable Bluetooth® function on smartphone or tablet
		Bluetooth® function of sensor disabled, perform recovery sequence
Device is not visible in the live list	The device is already connected with another smartphone/tablet	Only one point-to-point connection is established between a sensor and a smartphone or tablet
Device is visible in the live list but cannot be accessed via SmartBlue	Android end device	Is the location function enabled for the app, was it approved the first time?
		GPS or positioning function must be activated for certain Android versions in conjunction with Bluetooth®
		Activate GPS - close the app fully and restart - enable the positioning function for the app
Device is visible in the live list but cannot be accessed via SmartBlue	Apple end device	Log in as standard Enter user name "admin" Enter initial password (ID of the Bluetooth module) paying attention to lower/upper case
Login via SmartBlue not possible	Device is being put into operation for the first time	Enter initial password (ID of the Bluetooth module) and change; paying attention to lower/upper case
Device cannot be operated via SmartBlue	Incorrect password entered	Enter correct password
Device cannot be operated via SmartBlue	Password forgotten	Contact the Endress+Hauser Service department (www.addresses.endress.com)

13.1.3 Parametrization errors

Error	Possible cause	Remedy
Measured value incorrect	If measured distance (Setup → Distance) matches the real distance: Calibration error	<ul style="list-style-type: none"> ▪ Check and adjust Empty calibration parameter if necessary. ▪ Check and adjust Full calibration parameter if necessary. ▪ Check and adjust linearization if necessary (Linearization submenu).
	Level correction set incorrectly	Enter correct value in Level correction parameter.
	If measured distance (Setup → Distance) does not match the real distance: Interference echo	Carry out tank mapping (Confirm distance parameter).
No change of measured value on filling / emptying	Interference echo from installations, nozzle or build-up on the antenna.	<ul style="list-style-type: none"> ▪ Carry out tank mapping (Confirm distance parameter). ▪ If possible, align antenna in the direction of the solid surface in order to prevent interference echoes. ▪ If necessary, clean antenna (purge air). ▪ If necessary, select a better mounting position and/or larger antenna.

Error	Possible cause	Remedy
During filling/emptying or measurement, the measured value jumps sporadically to a higher level.	Signal is weakened (e.g. by fluidisation of the surface, extreme dust formation) - the interference echoes are sometimes stronger. Strong build-up, filling stream in path of beam.	<ul style="list-style-type: none"> ▪ Carry out tank mapping (Confirm distance parameter). ▪ Increase integration time (Expert → Sensor → Distance → Integration time) ▪ Optimize alignment of antenna ▪ If necessary, select a better mounting position and/or larger antenna. ▪ If necessary, clean antenna (purge air).
Error message F941 or S941 "Echo lost"	Level echo is too weak. Possible causes: <ul style="list-style-type: none"> ▪ Fluidisation of the surface ▪ Extreme dust formation ▪ Angle or repose 	<ul style="list-style-type: none"> ▪ Optimize alignment of antenna ▪ If necessary, select a better mounting position and/or larger antenna.
Measured values jumps to higher levels and remains there.	<ul style="list-style-type: none"> ▪ Build-up at container ▪ Build-up at antenna ▪ Strong condensate formation at antenna 	<ul style="list-style-type: none"> ▪ Periodic cleaning ▪ Carry out tank mapping (Confirm distance parameter). ▪ Increase integration time (Expert → Sensor → Distance → Integration time) ▪ Optimize alignment of antenna ▪ If necessary, select a better mounting position and/or larger antenna.
Device displays a level when the tank is empty.	Interference echo	Carry out mapping over entire measuring range when the silo is empty (Confirm distance parameter).
Wrong slope of the level throughout the complete measuring range	Bin property or process properties incorrect	<ul style="list-style-type: none"> ▪ Select the correct option in Bin type parameter. ▪ Enter the actual values in "Max. filling speed solid" parameter and "Max. draining speed solid" parameter.

13.2 Diagnostic information on local display

13.2.1 Diagnostic message

Faults detected by the self-monitoring system of the measuring device are displayed as a diagnostic message in alternation with the measured value display.

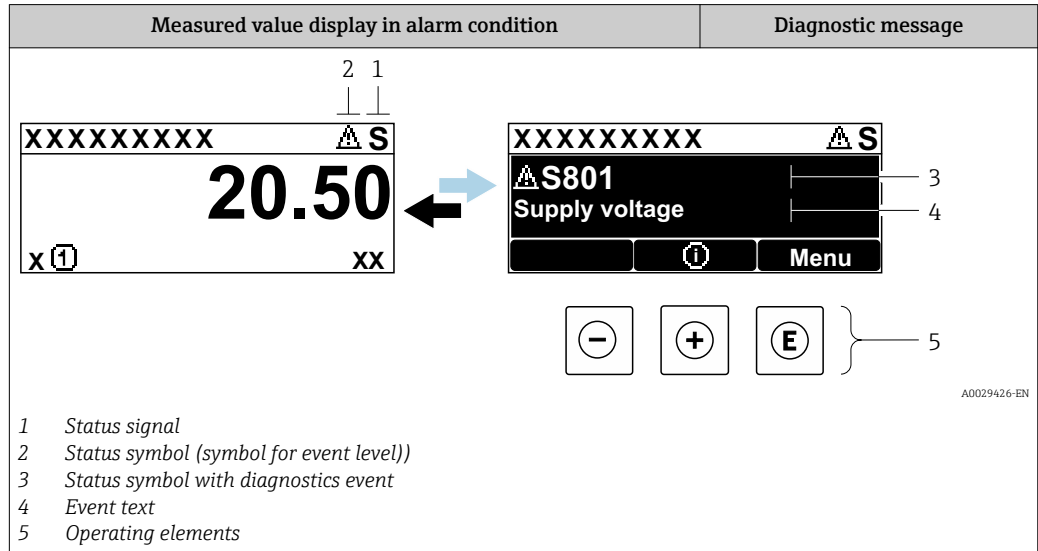

Status signals

F <small>A0032902</small>	"Failure (F)" option A device error is present. The measured value is no longer valid.
C <small>A0032903</small>	"Function check (C)" option The device is in service mode (e.g. during a simulation).
S <small>A0032904</small>	"Out of specification (S)" option The device is operated: <ul style="list-style-type: none"> ▪ Outside of its technical specifications (e.g. during startup or a cleaning) ▪ Outside of the configuration carried out by the user (e.g. level outside configured span)
M <small>A0032905</small>	"Maintenance required (M)" option Maintenance is required. The measured value is still valid.

Status symbol (symbol for event level)

⊗	"Alarm" status The measurement is interrupted. The signal outputs take on the defined alarm condition. A diagnostic message is generated.
⚠	"Warning" status The device continues to measure. A diagnostic message is generated.

Diagnostics event and event text

The fault can be identified using the diagnostics event. The event text helps you by providing information about the fault. In addition, the corresponding symbol is displayed before the diagnostics event.

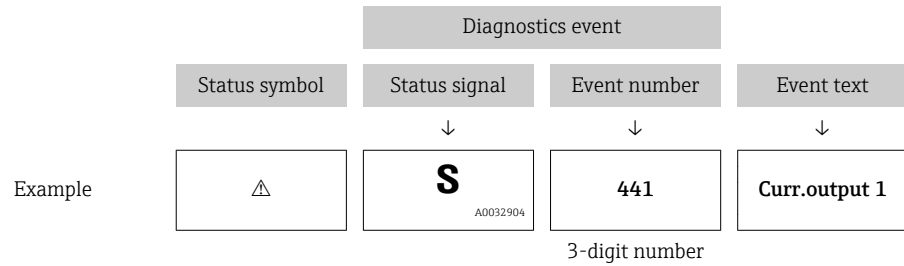

If two or more diagnostic messages are pending simultaneously, only the message with the highest priority is shown. Additional pending diagnostic messages can be shown in the **Diagnostic list** submenu.

-  Past diagnostic messages that are no longer pending are shown as follows:
 - On the local display:
in the **Event logbook** submenu
 - In FieldCare:
via the "Event List /HistoROM" function.

Operating elements

Operating functions in menu, submenu	
+	Plus key Opens the message about the remedial measures.
E	Enter key Opens the operating menu.

13.2.2 Calling up remedial measures

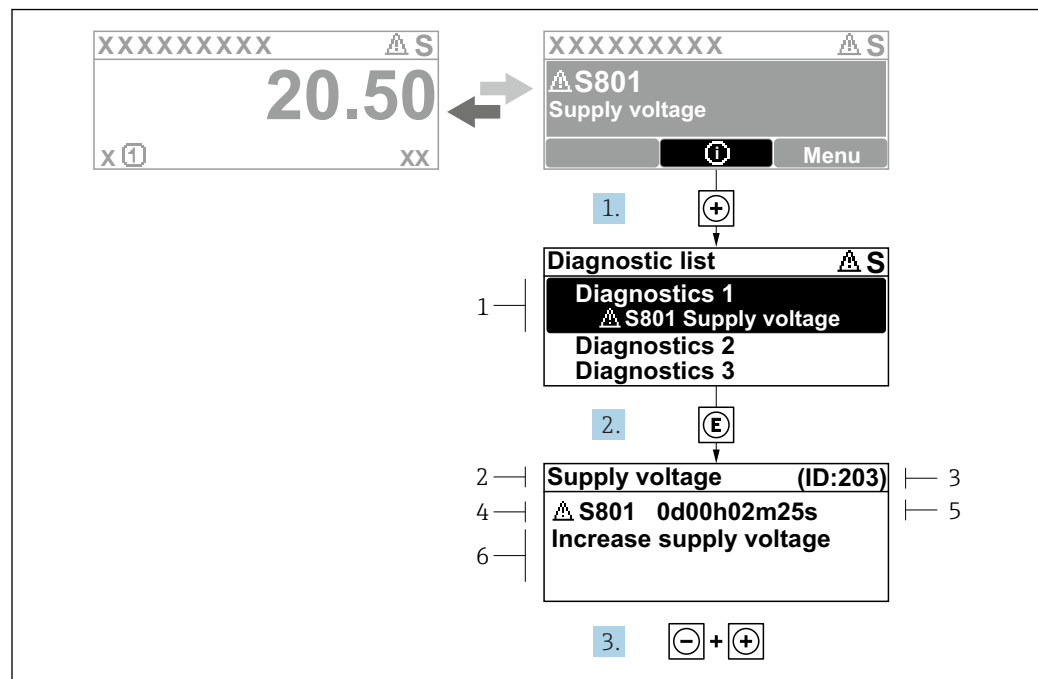

34 Message for remedial measures

A0029431-EN

- 1 Diagnostic information
- 2 Short text
- 3 Service ID
- 4 Diagnostic behavior with diagnostic code
- 5 Operation time of occurrence
- 6 Remedial measures

The user is in the diagnostic message.

1. Press ⊕ (⊕-Symbol).
 - ↳ **Diagnostic list** submenu opens.
2. Select the desired diagnostic event with ⊕ or ⊖ and press ⊞.
 - ↳ The message for the remedial measures for the selected diagnostic event opens.
3. Press ⊞ + ⊕ simultaneously.
 - ↳ The message for the remedial measures closes.

The user is in the **Diagnostics** menu at an entry for a diagnostics event, e.g. in **Diagnostic list** submenu or in **Previous diagnostics**.

1. Press ⊞.
 - ↳ The message for the remedial measures for the selected diagnostic event opens.
2. Press ⊞ + ⊕ simultaneously.
 - ↳ The message for the remedial measures closes.

13.3 Diagnostic event in the operating tool

If a diagnostic event is present in the device, the status signal appears in the top left status in the operating tool along with the corresponding symbol for event level in accordance with NAMUR NE 107:

- Failure (F)
- Function check (C)
- Out of specification (S)
- Maintenance required (M)

A: Via the operating menu

1. Navigate to the **Diagnostics** menu.
 - ↳ In the **Actual diagnostics** parameter, the diagnostic event is shown with event text.
2. On the right in the display range, hover the cursor over the **Actual diagnostics** parameter.

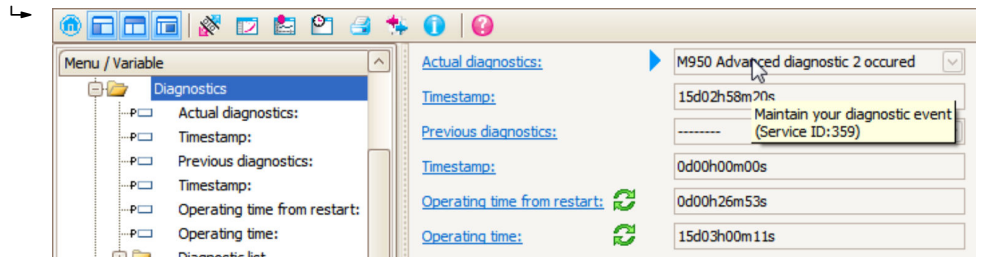

A tool tip with remedial measures for the diagnostic event appears.

B: Via the "Create documentation" function

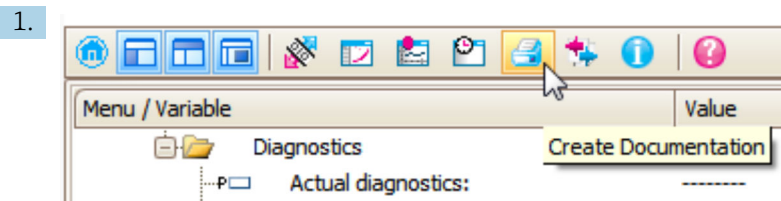

Select the "Create documentation" function.

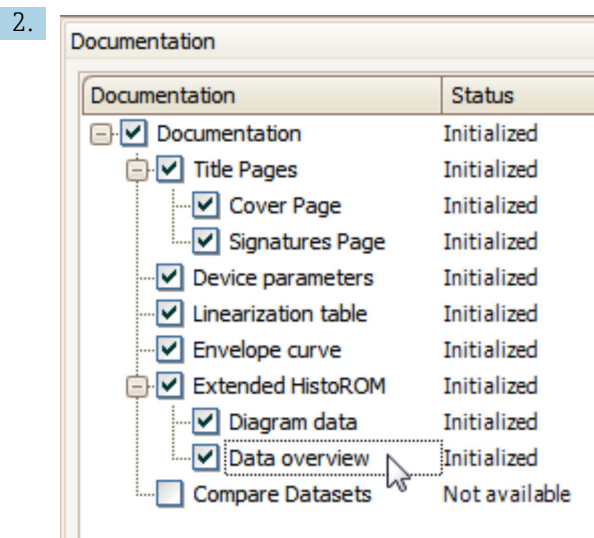

Make sure "Data overview" is marked.

3. Click "Save as ..." and save a PDF of the protocol.
 - ↳ The protocol contains the diagnostic messages and remedy information.

C: Via the "Eventlist / Extended HistoROM" function

1.

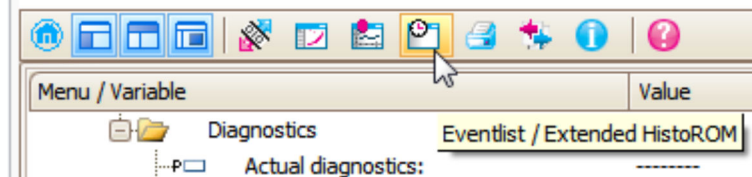

Select the "Eventlist / Extended HistoROM" function.

2.

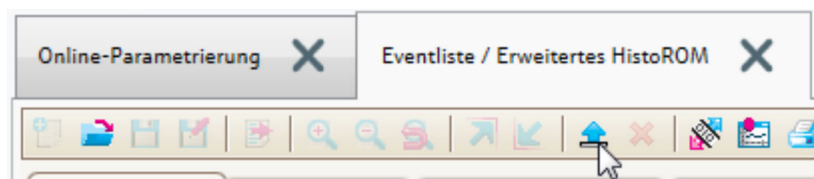

Select the "Load Eventlist" function.

- ↳ The list of events, including remedy information, is shown in the "Data overview" window.

13.4 Diagnostic list

In the **Diagnostic list** submenu submenu, up to 5 currently pending diagnostic messages can be displayed. If more than 5 messages are pending, the messages with the highest priority are shown on the display.

Navigation path

Diagnostics → Diagnostic list

Calling up and closing the remedial measures

1. Press \square .
 - ↳ The message for the remedial measures for the selected diagnostic event opens.
2. Press \square + \oplus simultaneously.
 - ↳ The message about the remedial measures closes.

13.5 Overview of diagnostic events

Diagnostic number	Short text	Remedy instructions	Status signal [from the factory]	Diagnostic behavior [from the factory]
Diagnostic of sensor				
046	Build-up detected	Clean sensor	F	Alarm ¹⁾
102	Sensor incompatible error	1. Restart device 2. Contact service	F	Alarm
151	Sensor electronic failure	Replace sensor electronic module	F	Alarm
Diagnostic of electronic				
242	Software incompatible	1. Check software 2. Flash or change main electronics module	F	Alarm
252	Modules incompatible	1. Check electronic modules 2. Change I/O or main electronic module	F	Alarm
261	Electronic modules	1. Restart device 2. Check electronic modules 3. Change I/O Modul or main electronics	F	Alarm
262	Module connection	1. Check module connections 2. Change electronic modules	F	Alarm
270	Main electronic failure	Change main electronic module	F	Alarm
271	Main electronic failure	1. Restart device 2. Change main electronic module	F	Alarm
272	Main electronic failure	1. Restart device 2. Contact service	F	Alarm
273	Main electronic failure	1. Emergency operation via display 2. Change main electronics	F	Alarm
275	I/O module defective	Change I/O module	F	Alarm
276	I/O module faulty	1. Restart device 2. Change I/O module	F	Alarm
276	I/O module failure		F	Alarm
282	Data storage	1. Restart device 2. Contact service	F	Alarm
283	Memory content	1. Transfer data or reset device 2. Contact service	F	Alarm
311	Electronic failure	Maintenance required! 1. Do not perform reset 2. Contact service	M	Warning
Diagnostic of configuration				
410	Data transfer	1. Check connection 2. Retry data transfer	F	Alarm
411	Up-/download active	Up-/download active, please wait	C	Warning
412	Processing download	Download active, please wait	C	Warning
431	Trim 1 to 2	Carry out trim	C	Warning
435	Linearization	Check linearization table	F	Alarm
437	Configuration incompatible	1. Restart device 2. Contact service	F	Alarm

Diagnostic number	Short text	Remedy instructions	Status signal [from the factory]	Diagnostic behavior [from the factory]
438	Dataset	1. Check data set file 2. Check device configuration 3. Up- and download new configuration	M	Warning
441	Current output 1 to 2	1. Check process 2. Check current output settings	S	Warning
484	Failure mode simulation	Deactivate simulation	C	Alarm
485	Simulation measured value	Deactivate simulation	C	Warning
491	Current output 1 to 2 simulation	Deactivate simulation	C	Warning
494	Switch output simulation	Deactivate simulation switch output	C	Warning
495	Diagnostic event simulation	Deactivate simulation	C	Warning
585	Simulation distance	Deactivate simulation	C	Warning
586	Record map	Recording of mapping please wait	C	Warning
Diagnostic of process				
801	Energy too low	Increase supply voltage	S	Warning
803	Current loop	1. Check wiring 2. Change I/O module	F	Alarm
825	Operating temperature	1. Check ambient temperature 2. Check process temperature	S	Warning
825	Operating temperature		F	Alarm
921	Change of reference	1. Check reference configuration 2. Check pressure 3. Check sensor	S	Warning
941	Echo lost	Check parameter 'DC value'	S	Warning ¹⁾
942	In safety distance	1. Check level 2. Check safety distance 3. Reset self holding	S	Alarm ¹⁾
943	In blocking distance	Reduced accuracy Check level	S	Warning
950	Advanced diagnostic 1 to 4 occurred	Maintain your diagnostic event	M	Warning ¹⁾
952	Foam detected	Check process conditions	F	Alarm ¹⁾

1) Diagnostic behavior can be changed.

13.6 Event logbook

13.6.1 Event history

A chronological overview of the event messages that have occurred is provided in the **Event list** submenu⁵⁾.

5) This submenu is only available for operation via local display. In the case of operation via FieldCare, the event list can be displayed with the "Event List / HistoROM" functionality of FieldCare.

Navigation path

Diagnostics → Event logbook → Event list

A maximum of 100 event messages can be displayed in chronological order.



Die Ereignishistorie umfasst Einträge zu:

- Diagnostic events
- Information events

In addition to the operation time of its occurrence, each event is also assigned a symbol that indicates whether the event has occurred or is ended:

- Diagnostic event
 - ☺: Event has occurred
 - ☹: Event has ended
- Information event
 - ☺: Event has occurred

Calling up and closing the remedial measures

1. Press 
 - ↳ The message for the remedial measures for the selected diagnostic event opens.
2. Press  +  simultaneously.
 - ↳ The message about the remedial measures closes.

13.6.2 Filtering the event logbook

Using the **Filter options** parameter, you can define which category of event messages is displayed in the **Event list** submenu.

Navigation path

Diagnostics → Event logbook → Filter options

Filter categories

- All
- Failure (F)
- Function check (C)
- Out of specification (S)
- Maintenance required (M)
- Information

13.6.3 Overview of information events

Info number	Info name
I1000	----- (Device ok)
I1089	Power on
I1090	Configuration reset
I1091	Configuration changed
I1092	Embedded HistoROM deleted
I1110	Write protection switch changed
I1137	Electronic changed
I1151	History reset
I1154	Reset terminal voltage min/max
I1155	Reset electronic temperature
I1156	Memory error trend
I1157	Memory error event list

Info number	Info name
I1184	Display connected
I1185	Display backup done
I1186	Restore via display done
I1187	Settings downloaded with display
I1188	Display data cleared
I1189	Backup compared
I1256	Display: access status changed
I1264	Safety sequence aborted
I1335	Firmware changed
I1397	Fieldbus: access status changed
I1398	CDI: access status changed
I1512	Download started
I1513	Download finished
I1514	Upload started
I1515	Upload finished
I1554	Safety sequence started
I1555	Safety sequence confirmed
I1556	Safety mode off

13.7 Firmware history

Date	Firmware version	Modifications	Documentation (FMR67, HART)	
			Operating Instructions	Description of Parameters
01.2017	01.00.zz	Original software	BA01620F/00/EN/01.17 ¹⁾ BA01620F/00/EN/02.18 ²⁾	GP01101F/00/EN/01.17

- 1) Contains information on the Heartbeat wizards which are available in the latest DTM version for DeviceCare and FieldCare.
- 2) Contains information on the Bluetooth interface.

 The firmware version can explicitly be ordered via the product structure. In this way it is possible to ensure compatibility of the firmware version with an existing or planned system integration.

14 Maintenance

The measuring device requires no special maintenance.

14.1 Exterior cleaning

When exterior-cleaning the device, always use cleaning agents that do not attack the surface of the housing and the seals.

14.2 Replacing seals

The process seals of the sensors (at the process connection) must be replaced periodically, particularly if molded seals (aseptic construction) are used. The period between changes depends on the frequency of cleaning cycles and on the temperature of the measured substance and the cleaning temperature.

15 Repairs

15.1 General information on repairs

15.1.1 Repair concept

The Endress+Hauser repair concept assumes that the devices have a modular design and that repairs can be done by the Endress+Hauser service or specially trained customers.

Spare parts are contained in suitable kits. They contain the related replacement instructions.

For more information on service and spare parts, contact the Service Department at Endress+Hauser.

15.1.2 Repairs to Ex-approved devices

When carrying out repairs to Ex-approved devices, please note the following:

- Repairs to Ex-approved devices may only be carried out by trained personnel or by the Endress+Hauser Service.
- Comply with the prevailing standards, national Ex-area regulations, safety instructions (XA) and certificates.
- Only use original spare parts from Endress+Hauser.
- When ordering a spare part, please note the device designation on the nameplate. Only replace parts with identical parts.
- Carry out repairs according to the instructions. On completion of repairs, carry out the specified routine test on the device.
- Only Endress+Hauser Service may convert a certified device into a different certified variant.
- Document all repair work and conversions.

15.1.3 Replacement of an electronics module

If an electronics module has been replaced, it is not necessary to perform a new basic setup as the calibration parameters are stored in the HistoROM which is located in the housing. However, after exchanging the main electronics module it may be necessary to record a new mapping (interference echo suppression).

15.1.4 Replacement of a device

After a complete device or electronic module has been replaced, the parameters can be downloaded into the instrument again in one of the following ways:

- Via the display module
Condition: The configuration of the old device has been saved in the display module
→  162.
- Via FieldCare
Condition: The configuration of the old device has been saved to the computer via FieldCare.

You can continue to measure without carrying out a new setup. Only a linearization and a tank map (interference echo suppression) have to be recorded again.

15.2 Spare parts

- A few interchangeable measuring device components are identified by a spare part nameplate. This contains information about the spare part.
- The connection compartment cover of the device contains a spare part nameplate that includes the following information:
 - A list of the most important spare parts for the measuring device, including their ordering information.
 - The URL for the *W@M Device Viewer* (www.endress.com/deviceviewer):
There, all spare parts for the measuring device are listed, including the order code, and can be ordered. If available, the corresponding Installation Instructions can also be downloaded there.

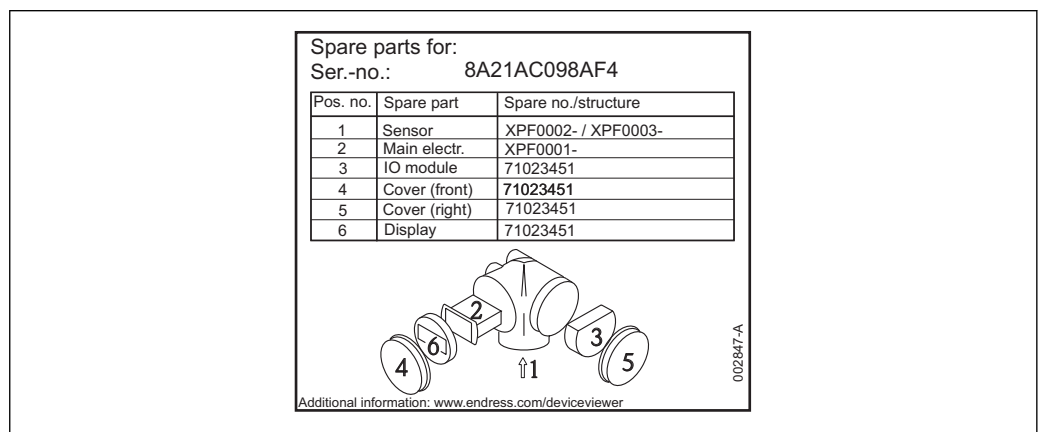

35 Example for spare part nameplate in connection compartment cover

- i** Measuring device serial number:
 - Is located on the device and spare part nameplate.
 - Can be read out via the "Serial number" parameter in the "Device information" submenu.

15.3 Return

The measuring device must be returned if it is need of repair or a factory calibration, or if the wrong measuring device has been delivered or ordered. Legal specifications require Endress+Hauser, as an ISO-certified company, to follow certain procedures when handling products that are in contact with the medium.

To ensure safe, swift and professional device returns, please refer to the procedure and conditions for returning devices provided on the Endress+Hauser website at <http://www.endress.com/support/return-material>

15.4 Disposal



Observe the following notes during disposal:

- Observe valid federal/national regulations.
- Ensure proper separation and reuse of the device components.

16 Accessories

16.1 Device-specific accessories

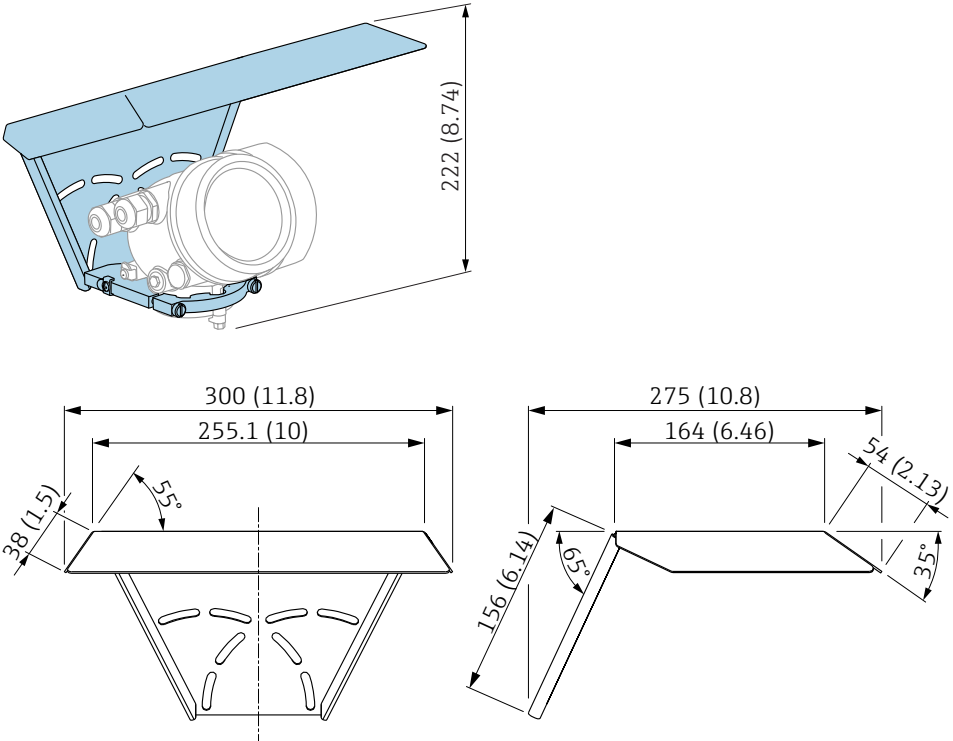
16.1.1 Weather protection cover

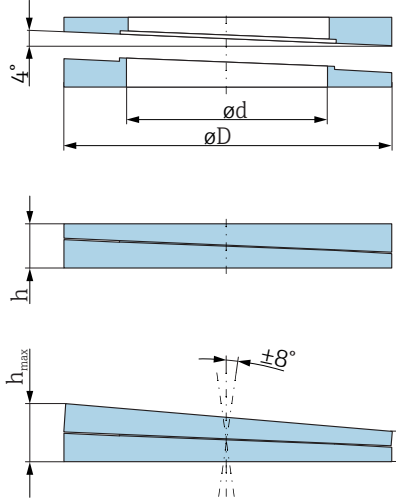
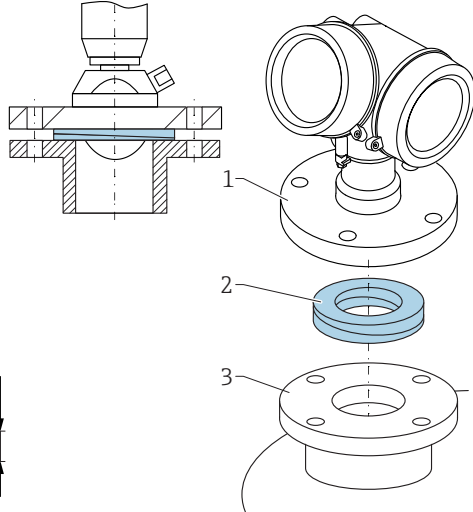

Accessory	Description
Weather protection cover	 <p data-bbox="1380 862 1436 884">A0015466</p> <p data-bbox="1380 1276 1436 1299">A0015472</p> <p data-bbox="327 1299 837 1332">  36 Weather protection cover; Dimensions: mm (in) </p> <p data-bbox="327 1355 1404 1433">  The weather protection cover can be ordered together with the device (product structure, feature 620 "Accessory Enclosed", option PB "Weather Protection Cover"). Alternatively, it can be separately ordered as an accessory; order code 71162242. </p>

16.1.2 Adjustable flange seal

Accessories	Description		
Adjustable flange seal	<div style="display: flex; justify-content: space-between;"> <div style="width: 45%;">  </div> <div style="width: 45%;">  </div> </div> <p style="text-align: right; font-size: small;">A0032292</p> <ol style="list-style-type: none"> 1 UNI slip-on flange 2 Adjustable flange seal 3 Nozzle <ul style="list-style-type: none"> The material properties and process conditions of the adjustable flange seal must be compatible with the properties (temperature, pressure, resistance) of the process. The adjustable flange seal can also be ordered directly with the device (product structure: feature 620 "Accessories enclosed", options PL, PM, PN, PO, PQ, PR). 		
Technical data: version DN/JIS			
Order number	71074263	71074264	71074265
Compatible with	DN80 PN10/40	DN100 PN10/16	<ul style="list-style-type: none"> ▪ DN150 PN10/16 ▪ JIS 10K 150A
Recommended screw length	100 mm (3.9 in)	100 mm (3.9 in)	110 mm (4.3 in)
Recommended screw size	M14	M14	M18
Material	EPDM		
Process pressure	-0.1 to 0.1 bar (-1.45 to 1.45 psi)		
Process temperature	-40 to +80 °C (-40 to +176 °F)		
D	142 mm (5.59 in)	162 mm (6.38 in)	218 mm (8.58 in)
d	89 mm (3.5 in)	115 mm (4.53 in)	169 mm (6.65 in)
h	22 mm (0.87 in)	23.5 mm (0.93 in)	26.5 mm (1.04 in)
h _{min}	14 mm (0.55 in)	14 mm (0.55 in)	14 mm (0.55 in)
h _{max}	30 mm (1.18 in)	33 mm (1.3 in)	39 mm (1.45 in)

Accessories	Description			
	Technical data: version ASME/JIS			
Order number	71249070	71249072	71249073	
Compatible with	<ul style="list-style-type: none"> ▪ ASME 3" 150lbs ▪ JIS 80A 10K 	ASME 4" 150lbs	ASME 6" 150lbs	
Recommended screw length	100 mm (3.9 in)	100 mm (3.9 in)	110 mm (4.3 in)	
Recommended screw size	M14	M14	M18	
Material	EPDM			
Process pressure	-0.1 to 0.1 bar (-1.45 to 1.45 psi)			
Process temperature	-40 to +80 °C (-40 to +176 °F)			
D	133 mm (5.2 in)	171 mm (6.7 in)	219 mm (8.6 in)	
d	89 mm (3.5 in)	115 mm (4.53 in)	168 mm (6.6 in)	
h	22 mm (0.87 in)	23.5 mm (0.93 in)	26.5 mm (1.04 in)	
h _{min}	14 mm (0.55 in)	14 mm (0.55 in)	14 mm (0.55 in)	
h _{max}	30 mm (1.18 in)	33 mm (1.3 in)	39 mm (1.45 in)	

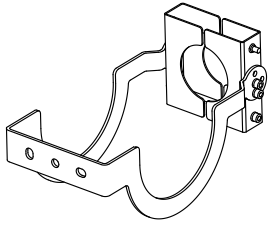
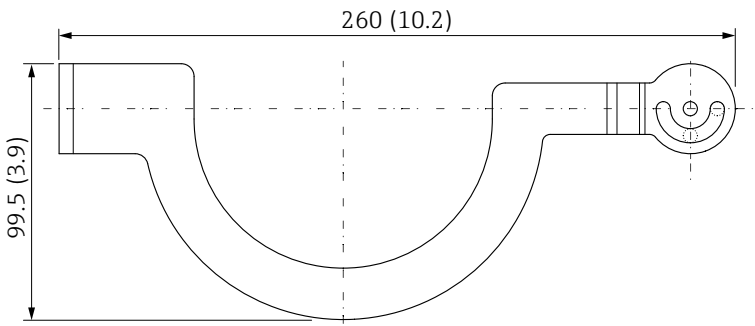
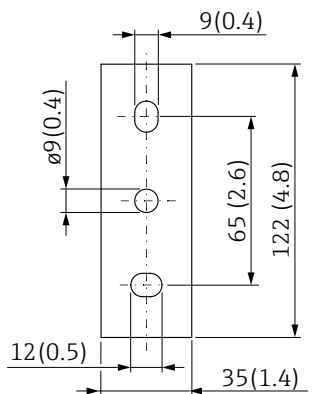
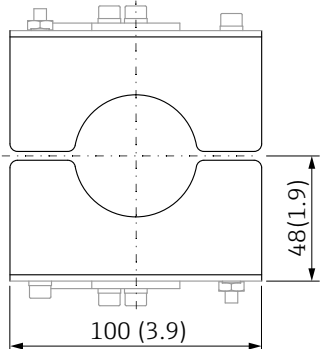
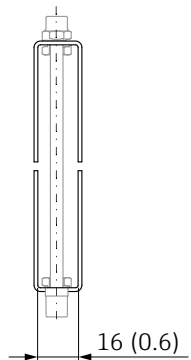
16.1.3 Mounting bracket adjustable

Accessories	Description
<p>Mounting bracket adjustable</p>	<div style="text-align: right; margin-bottom: 20px;">  </div> <div style="text-align: center; margin-bottom: 20px;">  </div> <div style="display: flex; justify-content: space-around; align-items: flex-start;"> <div style="text-align: center;">  </div> <div style="text-align: center;">  </div> <div style="text-align: center;">  </div> </div> <p>Material: 304 (1.4301)</p> <p>Suitable for housing¹⁾:</p> <ul style="list-style-type: none"> - A: GT19 dual compartment, plastic PBT - C: GT20 dual compartment, Alu, coated <p>Suitable for antenna²⁾:</p> <p>GA: Drip-off, PTFE DN50</p> <p>Suitable for process connection³⁾:</p> <ul style="list-style-type: none"> - GGJ: thread ISO228 G1-1/2, 316L - RGJ: thread ANSI MNPT1-1/2, 316L <p>Order number: 71336522</p> <p> There is no conductive connection between the mounting bracket and the transmitter housing.</p> <ul style="list-style-type: none"> ■ Risk of electrostatic charge. ■ Integrate the mounting bracket in the local potential equalization system. ■ Only to be fastened at stable materials (e.g. metal, brick, concrete) using suitable fastening material (to be supplied by customer).

A0032295

- 1) Feature 040 in the product structure
- 2) Feature 070 in the product structure
- 3) Feature 100 in the product structure

16.1.4 Remote display FHX50

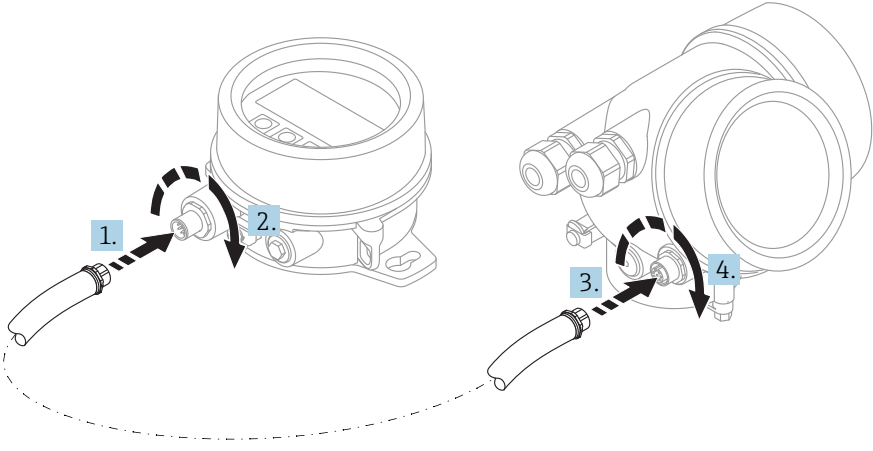
Accessories	Description
Remote display FHX50	<div style="text-align: center;">  </div> <p style="text-align: right;">A0019128</p> <ul style="list-style-type: none"> ▪ Material: <ul style="list-style-type: none"> – Plastic PBT – 316L/1.4404 – Aluminum ▪ Degree of protection: IP68 / NEMA 6P and IP66 / NEMA 4x ▪ Suitable for display modules: <ul style="list-style-type: none"> – SD02 (push buttons) – SD03 (touch control) ▪ Connecting cable: <ul style="list-style-type: none"> – Cable supplied with device up to 30 m (98 ft) – Standard cable supplied by customer up to 60 m (196 ft) ▪ Ambient temperature range: –40 to 80 °C (–40 to 176 °F) ▪ Ambient temperature range (option): –50 to 80 °C (–58 to 176 °F) ¹⁾ <p> i If the remote display should be used, order the device version "Prepared for display FHX50" (feature 030, version L, M or N). For the FHX50, you must select option A: "Prepared for display FHX50" under feature 050 "Measuring device version". </p> <p> i If the device version "Prepared for display FHX50" was not originally ordered and a FHX50 display is to be retrofitted, you must select version B "Not prepared for display FHX50" under feature 050: "Measuring device version" when ordering the FHX50. In this case, a retrofit kit for the device is supplied with the FHX50. The kit can be used to prepare the device so that the FHX50 can be used. </p> <p> i Use of the FHX50 may be restricted for transmitters with an approval. A device can only be retrofitted with the FHX50 if the option L, M or N ("Prepared for FHX50") is listed under <i>Basic specifications</i>, item 4 "Display, operation" in the Safety Instructions (XA) for the device. Also pay attention to the Safety Instructions (XA) of the FHX50. </p> <p> i Retrofitting is not possible on transmitters with: <ul style="list-style-type: none"> ▪ An approval for use in areas with flammable dust (dust ignition-proof approval) ▪ Ex nA type of protection </p> <p> i For details, see document SD01007F. </p>

1) This range is valid if option JN "Ambient temperature transmitter –50 °C (–58 °F)" has been selected in ordering feature 580 "Test, Certificate". If the temperature is permanently below –40 °C (–40 °F), failure rates may be increased.

16.1.5 Overvoltage protection

Accessory	Description
Overvoltage protection for 2-wire-devices OVP10 (1 channel) OVP20 (2 channel)	<div data-bbox="416 327 804 658" style="text-align: center;"> </div> <div data-bbox="1474 667 1528 680" style="text-align: right; font-size: small;">A0021734</div> <p data-bbox="416 712 560 734">Technical data</p> <ul data-bbox="416 739 1007 898" style="list-style-type: none"> ▪ Resistance per channel: $2 * 0.5 \Omega_{max}$ ▪ Threshold DC voltage: 400 to 700 V ▪ Threshold impulse voltage: < 800 V ▪ Capacitance at 1 MHz: < 1.5 pF ▪ Nominal arrest impulse voltage (8/20 μs): 10 kA ▪ Suited for wire cross-sections: 0.2 to 2.5 mm² (24 to 14 AWG) <p data-bbox="416 909 671 931">i Ordering with device</p> <p data-bbox="469 936 1477 1010">The overvoltage protection module is preferably ordered with the device. See product structure, feature 610 "Accessory mounted", option NA "Overvoltage protection". Separate ordering of the module is only necessary if a device is to be retrofitted with the overvoltage protection.</p> <p data-bbox="416 1025 722 1048">i Order code for retrofitting</p> <ul data-bbox="469 1052 995 1155" style="list-style-type: none"> ▪ For 1-channel devices (feature 020, option A) OVP10: 71128617 ▪ For 2-channel devices (feature 020, option B, C, E or G) OVP20 : 71128619 <p data-bbox="469 1171 727 1193">Housing lid for retrofitting</p> <p data-bbox="469 1198 1509 1249">In order to keep the necessary safety distances, the housing lid needs to be replaced if the device is retrofitted with the overvoltage protection. Depending on the housing type, the order code of the suitable lid is as follows:</p> <ul data-bbox="469 1252 767 1328" style="list-style-type: none"> ▪ GT18 housing: Lid 71185516 ▪ GT19 housing: Lid 71185518 ▪ GT20 housing: Lid 71185516 <p data-bbox="416 1344 732 1366">i Restrictions for retrofitting</p> <p data-bbox="469 1370 1517 1444">Depending on the approval of the transmitter the usage of the OVP module may be restricted. A device may only be retrofitted with an OVP module if the option NA (overvoltage protection) is quoted under <i>Optional Specifications</i> in the Safety Instructions (XA) pertaining to the device.</p> <p data-bbox="416 1460 746 1482">i For details refer to SD01090F.</p>

16.1.6 Bluetooth module for HART devices

Accessory	Description
Bluetooth module	<div data-bbox="327 324 973 772" data-label="Image"> </div> <div data-bbox="1380 779 1437 795" data-label="Text"> <p>A0036493</p> </div> <ul style="list-style-type: none"> ▪ Quick and easy commissioning via SmartBlue (app) ▪ No additional tools or adapters required ▪ Signal curve via SmartBlue (app) ▪ Encrypted single point-to-point data transmission (tested by Fraunhofer institute) and password protected communication via Bluetooth® wireless technology ▪ Range under reference conditions: > 10 m (33 ft) <p>i When using the Bluetooth module the minimum supply voltage increases by up to 3 V.</p> <p>i Ordering with device The Bluetooth module is preferably ordered with the device. See product structure, feature 610 "Accessory Mounted", option NF "Bluetooth". A separate order is only necessary in case of retrofitting.</p> <p>i Order code for retrofitting Bluetooth module (BT10): 71377355</p> <p>i Restrictions in case of retrofitting Depending on the approval of the transmitter, application of the Bluetooth module may be restricted. A device may only be retrofitted with a Bluetooth module if the option <i>NF</i> (Bluetooth) is listed in the associated Safety Instructions (XA) under <i>Optional specifications</i>.</p> <p>i For details refer to SD02252F.</p>

16.2 Communication-specific accessories

Accessory	Description
Commubox FXA195 HART	For intrinsically safe HART communication with FieldCare via the USB interface.  For details refer to Technical Information TI00404F

Accessory	Description
Commubox FXA291	Connects Endress+Hauser field devices with CDI interface (= Endress+Hauser Common Data Interface) to the USB interface of a computer. Order code: 51516983  For details refer to Technical Information TI00405C

Accessory	Description
HART Loop Converter HMX50	Evaluates the dynamic HART variables and converts them to analog current signals or limit values. Order code: 71063562  For details refer to Technical Information TI00429F and Operating Instructions BA00371F

Accessory	Description
WirelessHART Adapter SWA70	Connects field devices to a WirelessHART network. The WirelessHART adapter can be mounted directly at a HART device and is easily integrated into an existing HART network. It ensures safe data transmission and can be operated in parallel with other wireless networks.  For details refer to Operating Instructions BA00061S

Accessories	Description
Connect Sensor FXA30/FXA30B	Fully integrated, battery-powered gateway for simple applications with SupplyCare Hosting. Up to 4 field devices with 4 to 20 mA communication (FXA30/FXA30B), serial Modbus (FXA30B) or HART (FXA30B) can be connected. With its robust design and ability to run for years on the battery, it is ideal for remote monitoring in isolated locations. Version with LTE (USA, Canada and Mexico only) or 3G mobile transmission for worldwide communication.  For details, see "Technical Information" TI01356S and Operating Instructions BA01710S.

Accessories	Description
Fieldgate FXA42	Fieldgates enable communication between connected 4 to 20 mA, Modbus RS485 and Modbus TCP devices and SupplyCare Hosting or SupplyCare Enterprise. The signals are transmitted either via Ethernet TCP/IP, WLAN or mobile communications (UMTS). Advanced automation capabilities are available, such as an integrated Web-PLC, OpenVPN and other functions.  For details, see "Technical Information" TI01297S and Operating Instructions BA01778S.



Accessories	Description
SupplyCare Enterprise SCE30B	<p>Inventory management software that visualizes levels, volumes, masses, temperatures, pressures, densities or other tank parameters. The parameters are recorded and transmitted by means of gateways of the type Fieldgate FXA42.</p> <p>This Web-based software is installed on a local server and can also be visualized and operated with mobile terminals such as a smartphone or tablet.</p> <p> For details, see "Technical Information" TI01228S and Operating Instructions BA00055S</p>

Accessories	Description
SupplyCare Hosting SCH30	<p>Inventory management software that visualizes levels, volumes, masses, temperatures, pressures, densities or other tank parameters. The parameters are recorded and transmitted by means of gateways of the type Fieldgate FXA42, FXA30 and FXA30B.</p> <p>SupplyCare Hosting is offered as a hosting service (Software as a Service, SaaS). In the Endress+Hauser portal, the user is provided with the data over the Internet.</p> <p> For details, see "Technical Information" TI01229S and Operating Instructions BA00050S.</p>



Accessory	Description
Field Xpert SFX350	<p>Field Xpert SFX350 is a mobile computer for commissioning and maintenance. It enables efficient device configuration and diagnostics for HART and FOUNDATION fieldbus devices in the non-Ex area.</p> <p> For details, see Operating Instructions BA01202S</p>

Accessory	Description
Field Xpert SFX370	<p>Field Xpert SFX370 is a mobile computer for commissioning and maintenance. It enables efficient device configuration and diagnostics for HART and FOUNDATION fieldbus devices in the non-Ex area and the Ex area.</p> <p> For details, see Operating Instructions BA01202S</p>

16.3 Service-specific accessories

Accessory	Description
DeviceCare SFE100	<p>Configuration tool for HART, PROFIBUS and FOUNDATION Fieldbus devices</p> <p> Technical Information TI01134S</p> <p> <ul style="list-style-type: none"> DeviceCare is available for download at www.software-products.endress.com. The download requires a registration in the Endress+Hauser software portal. Alternatively, a DeviceCare DVD can be ordered with the device. Product structure: Feature 570 "Service", Option IV "Tooling DVD (DeviceCare Setup)". </p>
FieldCare SFE500	<p>FDT-based Plant Asset Management tool.</p> <p>Helps to configure and maintain all field devices of your plant. By supplying status information it also supports the diagnosis of the devices.</p> <p> Technical Information TI00028S</p>





















16.4 System components

























Accessory	Description
Graphic Data Manager Memograph M	<p>The graphic data manager Memograph M provides information on all the relevant process variables. Measured values are recorded correctly, limit values are monitored and measuring points analyzed. The data are stored in the 256 MB internal memory and also on an SD card or USB stick.</p> <p> For details refer to Technical Information TI00133R and Operating Instructions BA00247R</p>
RN221N	<p>Active barrier with power supply for safe separation of 4 to 20 mA current circuits. Provides bi-directional HART transmission.</p> <p> For details refer to Technical Information TI00073R and Operating Instructions BA00202R</p>
RNS221	<p>Transmitter supply for 2-wire sensors or transmitters exclusively for non-Ex areas. Provides bi-directional communication using the HART communication sockets.</p> <p> For details refer to Technical Information TI00081R and Operating Instructions KA00110R</p>

17 Operating menu























17.1 Overview of the operating menu (SmartBlue)

Navigation  Operating menu

Setup	→  115
Device tag	→  115
Distance unit	→  115
Bin type	→  115
Max. draining speed solid	→  116
Max. filling speed solid	→  116
Empty calibration	→  117
Full calibration	→  118
Level	→  119
Distance	→  119
Signal quality	→  119
Confirm distance	→  119
Present mapping	→  121
Mapping end point	→  121
Record map	→  121
▶ Advanced setup	→  124
Locking status	→  124
Access status tooling	→  124
Enter access code	→  125
▶ Level	→  126
Medium type	→  126

Medium property	→  126
Max. filling speed liquid	→  127
Max. draining speed liquid	→  127
Level unit	→  128
Blocking distance	→  129
Level correction	→  129
Tank/silo height	→  129
► Linearization	→  132
Linearization type	→  134
Unit after linearization	→  135
Free text	→  136
Level linearized	→  136
Maximum value	→  137
Diameter	→  137
Intermediate height	→  137
Table mode	→  138
Table number	→  139
Level	→  139
Level	→  140
Customer value	→  140
Activate table	→  140
► Safety settings	→  141
Output echo lost	→  141
Value echo lost	→  141

Ramp at echo lost	→ 📖 142
Blocking distance	→ 📖 129
▶ Current output 1 to 2	→ 📖 146
Assign current output	→ 📖 146
Current span	→ 📖 147
Fixed current	→ 📖 147
Damping output	→ 📖 148
Failure mode	→ 📖 148
Failure current	→ 📖 149
Output current 1 to 2	→ 📖 149
▶ Switch output	→ 📖 150
Switch output function	→ 📖 150
Assign status	→ 📖 151
Assign limit	→ 📖 151
Assign diagnostic behavior	→ 📖 151
Switch-on value	→ 📖 152
Switch-on delay	→ 📖 153
Switch-off value	→ 📖 153
Switch-off delay	→ 📖 154
Failure mode	→ 📖 154
Switch status	→ 📖 154
Invert output signal	→ 📖 154
🔍 Diagnostics	→ 📖 168
Actual diagnostics	→ 📖 168
Timestamp	→ 📖 168

Previous diagnostics	→  168
Timestamp	→  169
Operating time from restart	→  169
Operating time	→  162
▶ Diagnostic list	→  170
Diagnostics 1 to 5	→  170
Timestamp	→  170
▶ Device information	→  172
Device tag	→  172
Serial number	→  172
Firmware version	→  172
Device name	→  172
Order code	→  173
Extended order code 1 to 3	→  173
Device revision	→  173
Device ID	→  173
Device type	→  174
Manufacturer ID	→  174
▶ Measured values	→  175
Distance	→  175
Level linearized	→  136
Output current 1 to 2	→  149
Measured current 1	→  176

Terminal voltage 1	→ 176
Sensor temperature	→ 176
► Simulation	→ 181
Assign measurement variable	→ 182
Process variable value	→ 182
Current output 1 to 2 simulation	→ 182
Value current output 1 to 2	→ 183
Switch output simulation	→ 183
Switch status	→ 183
Device alarm simulation	→ 184
Diagnostic event simulation	→ 184

17.2 Overview of the operating menu (display module)

Navigation





















































Operating menu

Language	→ 156
Setup	→ 115
Device tag	→ 115
Distance unit	→ 115
Bin type	→ 115
Max. draining speed solid	→ 116
Max. filling speed solid	→ 116
Empty calibration	→ 117
Full calibration	→ 118
Level	→ 119
Distance	→ 119
Signal quality	→ 119
Mapping	→ 122
Confirm distance	→ 122
Mapping end point	→ 122
Present mapping	→ 121
Record map	→ 121
Distance	→ 119
Prepare recording map	→ 122
Advanced setup	→ 124
Locking status	→ 124
Access status display	→ 125
Enter access code	→ 125

▶ Level	→ 126
Medium type	→ 126
Medium property	→ 126
Level unit	→ 128
Blocking distance	→ 129
Level correction	→ 129
Tank/silo height	→ 129
▶ Linearization	→ 132
Linearization type	→ 134
Unit after linearization	→ 135
Free text	→ 136
Maximum value	→ 137
Diameter	→ 137
Intermediate height	→ 137
Table mode	→ 138
▶ Edit table	
Level	→ 139
Customer value	→ 140
Activate table	→ 140
▶ Safety settings	→ 141
Output echo lost	→ 141
Value echo lost	→ 141
Ramp at echo lost	→ 142
Blocking distance	→ 129
▶ SIL/WHG confirmation	→ 144

▶ Deactivate SIL/WHG	→ 145
Reset write protection	→ 145
Code incorrect	→ 145
▶ Current output 1 to 2	→ 146
Assign current output	→ 146
Current span	→ 147
Fixed current	→ 147
Damping output	→ 148
Failure mode	→ 148
Failure current	→ 149
Output current 1 to 2	→ 149
▶ Switch output	→ 150
Switch output function	→ 150
Assign status	→ 151
Assign limit	→ 151
Assign diagnostic behavior	→ 151
Switch-on value	→ 152
Switch-on delay	→ 153
Switch-off value	→ 153
Switch-off delay	→ 154
Failure mode	→ 154
Switch status	→ 154
Invert output signal	→ 154
▶ Display	→ 156
Language	→ 156























Format display	→  156
Value 1 to 4 display	→  158
Decimal places 1 to 4	→  158
Display interval	→  158
Display damping	→  159
Header	→  159
Header text	→  160
Separator	→  160
Number format	→  160
Decimal places menu	→  160
Backlight	→  161
Contrast display	→  161
► Configuration backup display	→  162
Operating time	→  162
Last backup	→  162
Configuration management	→  162
Backup state	→  163
Comparison result	→  163
► Administration	→  165
► Define access code	→  167
Define access code	→  167
Confirm access code	→  167
Device reset	→  165
 Diagnostics	→  168
Actual diagnostics	→  168

























Previous diagnostics	→  168
Operating time from restart	→  169
Operating time	→  162
▶ Diagnostic list	→  170
Diagnostics 1 to 5	→  170
▶ Event logbook	→  171
Filter options	→  171
▶ Event list	→  171
▶ Device information	→  172
Device tag	→  172
Serial number	→  172
Firmware version	→  172
Device name	→  172
Order code	→  173
Extended order code 1 to 3	→  173
Device revision	→  173
Device ID	→  173
Device type	→  174
Manufacturer ID	→  174
▶ Measured values	→  175
Distance	→  175
Level linearized	→  136
Output current 1 to 2	→  149
Measured current 1	→  176

Terminal voltage 1	→ 176
Sensor temperature	→ 176
► Data logging	→ 177
Assign channel 1 to 4	→ 177
Logging interval	→ 177
Clear logging data	→ 178
► Display channel 1 to 4	→ 179
► Simulation	→ 181
Assign measurement variable	→ 182
Process variable value	→ 182
Current output 1 to 2 simulation	→ 182
Value current output 1 to 2	→ 183
Switch output simulation	→ 183
Switch status	→ 183
Device alarm simulation	→ 184
Diagnostic event category	→ 184
Diagnostic event simulation	→ 184
► Device check	→ 185
Start device check	→ 185
Result device check	→ 185
Last check time	→ 185



























17.3 Overview of the operating menu (operating tool)

























Navigation  Operating menu

Setup	→  115
Device tag	→  115
Distance unit	→  115
Bin type	→  115
Max. draining speed solid	→  116
Max. filling speed solid	→  116
Empty calibration	→  117
Full calibration	→  118
Level	→  119
Distance	→  119
Signal quality	→  119
Confirm distance	→  119
Present mapping	→  121
Mapping end point	→  121
Record map	→  121
▶ Advanced setup	→  124
Locking status	→  124
Access status tooling	→  124
Enter access code	→  125
▶ Level	→  126
Medium type	→  126
Medium property	→  126
Max. filling speed liquid	→  127

Max. draining speed liquid	→  127
Level unit	→  128
Blocking distance	→  129
Level correction	→  129
Tank/silo height	→  129
► Linearization	→  132
Linearization type	→  134
Unit after linearization	→  135
Free text	→  136
Level linearized	→  136
Maximum value	→  137
Diameter	→  137
Intermediate height	→  137
Table mode	→  138
Table number	→  139
Level	→  139
Level	→  140
Customer value	→  140
Activate table	→  140
► Safety settings	→  141
Output echo lost	→  141
Value echo lost	→  141
Ramp at echo lost	→  142
Blocking distance	→  129
► SIL/WHG confirmation	→  144

▶ Deactivate SIL/WHG	→ 145
Reset write protection	→ 145
Code incorrect	→ 145
▶ Current output 1 to 2	→ 146
Assign current output	→ 146
Current span	→ 147
Fixed current	→ 147
Damping output	→ 148
Failure mode	→ 148
Failure current	→ 149
Output current 1 to 2	→ 149
▶ Switch output	→ 150
Switch output function	→ 150
Assign status	→ 151
Assign limit	→ 151
Assign diagnostic behavior	→ 151
Switch-on value	→ 152
Switch-on delay	→ 153
Switch-off value	→ 153
Switch-off delay	→ 154
Failure mode	→ 154
Switch status	→ 154
Invert output signal	→ 154
▶ Display	→ 156
Language	→ 156

Format display	→  156
Value 1 to 4 display	→  158
Decimal places 1 to 4	→  158
Display interval	→  158
Display damping	→  159
Header	→  159
Header text	→  160
Separator	→  160
Number format	→  160
Decimal places menu	→  160
Backlight	→  161
Contrast display	→  161
► Configuration backup display	→  162
Operating time	→  162
Last backup	→  162
Configuration management	→  162
Backup state	→  163
Comparison result	→  163
► Administration	→  165
Define access code	→  165
Device reset	→  165
 Diagnostics	→  168
Actual diagnostics	→  168
Timestamp	→  168
Previous diagnostics	→  168

Timestamp	→  169
Operating time from restart	→  169
Operating time	→  162
▶ Diagnostic list	→  170
Diagnostics 1 to 5	→  170
Timestamp	→  170
▶ Device information	→  172
Device tag	→  172
Serial number	→  172
Firmware version	→  172
Device name	→  172
Order code	→  173
Extended order code 1 to 3	→  173
Device revision	→  173
Device ID	→  173
Device type	→  174
Manufacturer ID	→  174
▶ Measured values	→  175
Distance	→  175
Level linearized	→  136
Output current 1 to 2	→  149
Measured current 1	→  176
Terminal voltage 1	→  176
Sensor temperature	→  176

▶ Data logging	→ 177
Assign channel 1 to 4	→ 177
Logging interval	→ 177
Clear logging data	→ 178
▶ Simulation	→ 181
Assign measurement variable	→ 182
Process variable value	→ 182
Current output 1 to 2 simulation	→ 182
Value current output 1 to 2	→ 183
Switch output simulation	→ 183
Switch status	→ 183
Device alarm simulation	→ 184
Diagnostic event simulation	→ 184
▶ Device check	→ 185
Start device check	→ 185
Result device check	→ 185
Last check time	→ 185
▶ Heartbeat	→ 186

17.4 "Setup" menu

- i
 - ☰ : Marks the navigation path to the parameter via the display and operating module.
 - ☰ : Marks the navigation path to the parameter via an operating tool (e.g. FieldCare).
 - 🔒 : Marks parameters which can be locked via the software locking.

Navigation ☰☰ Setup

Device tag 🔒

- Navigation** ☰☰ Setup → Device tag
- Description** Enter a unique name for the measuring point to identify the device quickly within the plant.
- Factory setting** FMR6x

Distance unit 🔒

- Navigation** ☰☰ Setup → Distance unit
- Description** Used for the basic calibration (Empty / Full).
- Selection**

<i>SI units</i>	<i>US units</i>
▪ mm	▪ ft
▪ m	▪ in
- Factory setting** m

Bin type 🔒

- Navigation** ☰☰ Setup → Bin type
- Prerequisite** **Medium type** (→ ☰ 126) = **Solid**
- Description** Optimizes the signal filters for the respective bin type. Note: 'Workbench test' deactivates all filters. This option should exclusively be used for tests.
- Selection**
 - Buffer silo (fast)
 - Bin / Pile
 - Crusher / belt
 - Silo
 - Workbench test

Factory setting Silo

Additional information  **Workbench test** deactivates all filters. This option is intended for tests only.

Max. draining speed solid 

Navigation   Setup → Max. draining speed solid

Prerequisite **Medium type (→  126) = Solid**

Description Select maximum expected draining speed.

- Selection**
- Very slow < 0.5m (1.6ft) /h
 - Slow < 1m (3.3ft) /h
 - Standard < 2m (6,5ft) /h
 - Medium < 4m (13ft) /h
 - Fast < 8m (26ft) /h
 - Very fast > 8m (26ft) /h
 - No filter / test

Factory setting No filter / test

Additional information By specifying the maximum filling and draining speed the signal evaluation is automatically optimized for the process.

Max. draining speed liquid	Step response time / s
Very slow < 0.5m (1.6ft) /h	850
Slow < 1m (3.3ft) /h	710
Standard < 2m (6,5ft) /h	300
Medium < 4m (13ft) /h	155
Fast < 8m (26ft) /h	70
Very fast > 8m (26ft) /h	6
No filter / test	< 1

 The filling and draining speed can be set separately as filling and draining may be different processes.

 When selecting the **No filter / test** option all filters of the signal evaluation are deactivated. This option is intended for tests only.

Max. filling speed solid 

Navigation   Setup → Max. filling speed solid

Prerequisite **Medium type (→  126) = Solid**

Description Select expected maximum filling speed.

- Selection**
- Very slow < 0.5m (1.6ft) /h
 - Slow < 1m (3.3ft) /h
 - Standard < 2m (6,5ft) /h
 - Medium < 4m (13ft) /h
 - Fast < 8m (26ft) /h
 - Very fast > 8m (26ft) /h
 - No filter / test

Factory setting No filter / test

Additional information By specifying the maximum filling and draining speed the signal evaluation is automatically optimized for the process.

Max. draining speed liquid	Sprungantwortzeit / s
Very slow < 0.5m (1.6ft) /h	850
Slow < 1m (3.3ft) /h	710
Standard < 2m (6,5ft) /h	300
Medium < 4m (13ft) /h	155
Fast < 8m (26ft) /h	70
Very fast > 8m (26ft) /h	6
No filter / test	< 1

 The filling and draining speed can be set separately as filling and draining may be different processes.

 When selecting the **No filter / test** option all filters of the signal evaluation are deactivated. This option is intended for tests only.

Empty calibration

Navigation   Setup → Empty calibration

Description Distance between process connection and minimum level (0%).

User entry Depending on the antenna

Factory setting Depending on the antenna

Additional information

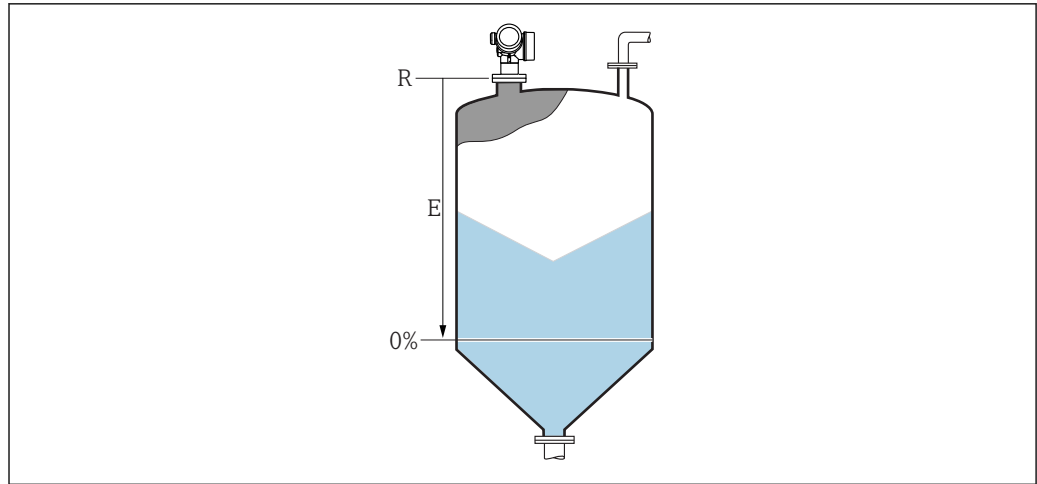

A0019488

37 Empty calibration (E) for level measurements in bulk solids.

i The measuring range starts at the point at which the radar beam hits the tank or silo bottom. In the case of dished boiler ends or conical outlets levels below this point can not be measured.

Full calibration



Navigation

Setup → Full calibration

Description

Distance between minimum level (0%) and maximum level (100%).

User entry

Depending on the antenna

Factory setting

Depending on the antenna

Additional information

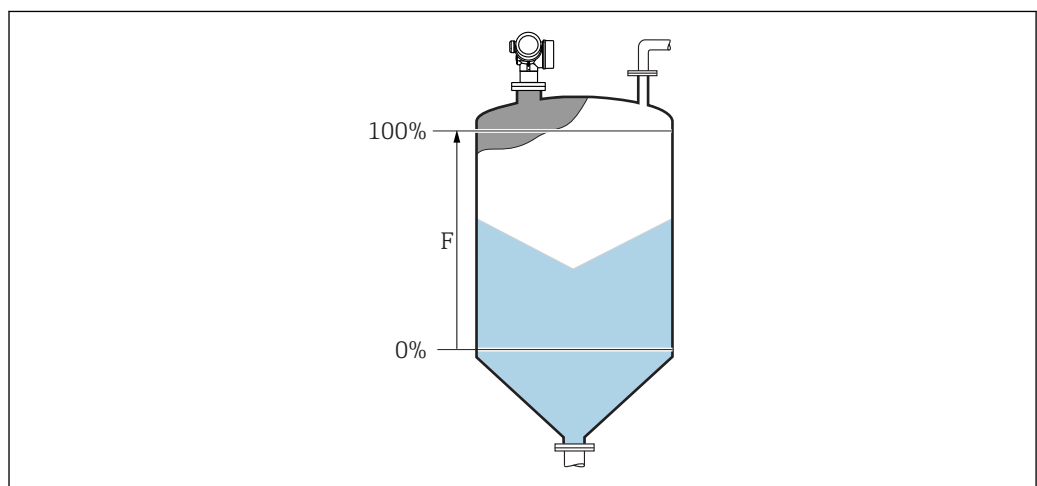

A0019489

38 Full calibration (F) for level measurements in bulk solids

Level

Navigation   Setup → Level

Description Displays measured level L (before linearization).

Additional information

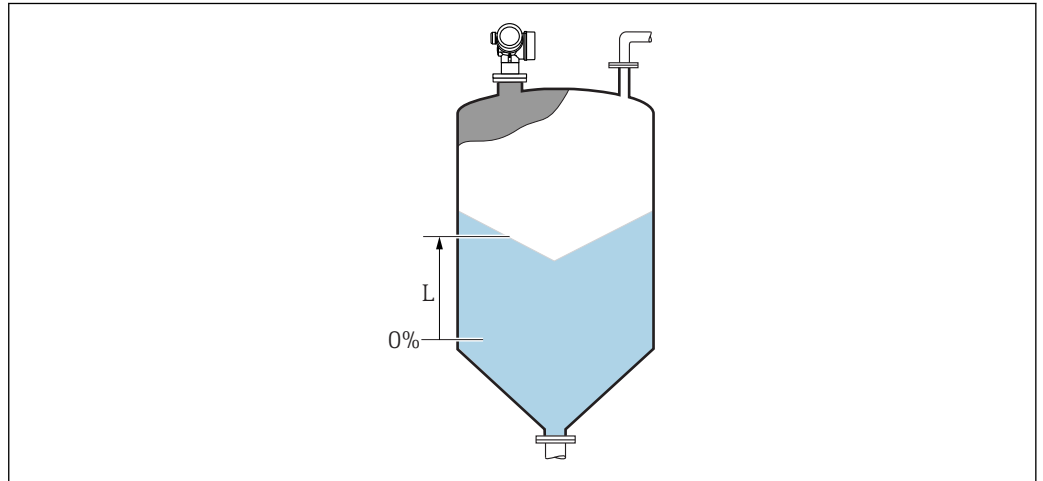

 39 *Level in case of bulk solid measurements*



 The unit is defined in the **Level unit** parameter (→  128).

Distance

Navigation   Setup → Distance

Description Distance between lower edge of flange or thread and medium surface.

Signal quality

Navigation   Setup → Signal quality

Description Shows the quality of the evaluated level signal.

Confirm distance

Navigation  Setup → Confirm distance

Description Specify, whether the measured distance matches the real distance. Depending on the selection the device automatically sets the range of mapping.

Selection

- Manual map
- Distance ok
- Distance unknown
- Distance too small *
- Distance too big *
- Tank empty
- Factory map

Factory setting

Distance unknown

Additional information**Meaning of the options**■ **Manual map**

To be selected if the range of mapping is to be defined manually in the **Mapping end point** parameter. In this case it is not necessary to confirm the distance.

■ **Distance ok**

To be selected if the measured distance matches the actual distance. The device performs a mapping.

■ **Distance unknown**

To be selected if the actual distance is unknown. A mapping can not be performed in this case.

■ **Distance too small** ⁶⁾

To be selected if the measured distance is smaller than the actual distance. The device searches for the next echo and returns to the **Confirm distance** parameter. The distance is recalculated and displayed. The comparison must be repeated until the displayed distance matches the actual distance. After this, the recording of the map can be started by selecting **Distance ok**.

■ **Distance too big**

To be selected if the measured distance exceeds the actual distance. The device adjusts the signal evaluation and returns to the **Confirm distance** parameter. The distance is recalculated and displayed. The comparison must be repeated until the displayed distance matches the actual distance. After this, the recording of the map can be started by selecting **Distance ok**.

■ **Tank empty**

To be selected if the tank is completely empty. The device records a mapping covering the complete measuring range as defined by the **Tank/silo height** parameter. By default, **Tank/silo height = Empty calibration**.

Take into account that in case of conical outlets, for example, a measurement is only possible up to the point at which the radar hits the bottom of the tank or silo. If the **Tank empty** option is used, **Empty calibration** (→  117) and **Tank/silo height** may not reach below this point as otherwise the empty signal is suppressed.

■ **Factory map**

The factory map permanently stored in the device is used.



No factory map is required for the FMR6x device generation. Therefore, a constant line of -116 dB is stored as the factory map. On commissioning, a map can be recorded which optimally fits the actual installation.



When operating via the display module, the measured distance is displayed together with this parameter for reference purposes.



If the teaching procedure with the **Distance too small** option or **Distance too big** option is quit before the distance has been confirmed, a map is **not** recorded and the teaching procedure is reset after 60 s.

* Visibility depends on order options or device settings

6) Only available for "Expert → Sensor → Echo tracking → **Evaluation mode** parameter" ≠ "**History off** option"

Present mapping

Navigation  Setup → Present mapping

Description Present end of mapping.

Mapping end point 

Navigation  Setup → Mapping end point

Prerequisite **Confirm distance** (→  119) = **Manual map** or **Distance too small**

Description New end point of mapping.

User entry 0.0001 to 999 999.9 m

Factory setting 0.1 m

Record map

Navigation  Setup → Record map



Prerequisite **Confirm distance** = **Manual map** or **Distance too small**

Selection

- No
- Record map
- Overlay map
- Factory map
- Delete partial map

Factory setting No

17.4.1 "Mapping" wizard

 The **Mapping** wizard is only available when operating via the local display. When operating via an operating tool, all parameters concerning the mapping are located directly in the **Setup** menu (→  115)

 In the **Mapping** wizard two parameters are displayed simultaneously on the display module at any one time. The upper parameter can be edited, whereas the lower parameter is displayed for reference purposes only.

Navigation  Setup → Mapping

Confirm distance

Navigation  Setup → Mapping → Confirm distance

Description →  119

Mapping end point

Navigation  Setup → Mapping → Mapping end point

Description →  121

Record map

Navigation  Setup → Mapping → Record map

Description →  121

Distance

Navigation  Setup → Mapping → Distance

Description →  119

Prepare recording map

Navigation  Setup → Mapping → Prepare recording map

Description Zeigt Status der Aufnahme der Ausblendung.





User interface

- Init. recording
- In progress
- Finished





17.4.2 "Advanced setup" submenu

Navigation  Setup → Advanced setup





Locking status

Navigation	  Setup → Advanced setup → Locking status
Description	Indicates the write protection with the highest priority that is currently active.
User interface	<ul style="list-style-type: none"> ■ Hardware locked ■ SIL locked ■ WHG locked ■ Temporarily locked
Additional information	<p>Meaning and priorities of the types of write protection</p> <ul style="list-style-type: none"> ■ Hardware locked (priority 1) The DIP switch for hardware locking is activated on the main electronics module. This locks write access to the parameters. ■ SIL locked (priority 2) The SIL mode is activated. Writing access to the relevant parameters is denied. ■ WHG locked (priority 3) The WHG mode is activated. Writing access to the relevant parameters is denied. ■ Temporarily locked (priority 4) Write access to the parameters is temporarily locked on account of internal processes in progress in the device (e.g. data upload/download, reset etc.). The parameters can be modified as soon as the processes are complete. <p> On the display module, the -symbol appears in front of parameters that cannot be modified since they are write-protected.</p>





Access status tooling

Navigation	 Setup → Advanced setup → Access status tooling
Description	Shows the access authorization to the parameters via the operating tool.
Additional information	<p> The access authorization can be changed via the Enter access code parameter (→  125).</p> <p> If additional write protection is active, this restricts the current access authorization even further. The write protection status can be viewed via the Locking status parameter (→  124).</p>

Access status display

Navigation	 Setup → Advanced setup → Access status display
Prerequisite	The device has a local display.
Description	Indicates access authorization to parameters via local display.
Additional information	<p> The access authorization can be changed via the Enter access code parameter (→  125).</p> <p> If additional write protection is active, this restricts the current access authorization even further. The write protection status can be viewed via the Locking status parameter (→  124).</p>

Enter access code

Navigation	 Setup → Advanced setup → Enter access code
Description	Enter access code to disable write protection of parameters.
User entry	0 to 9999
Additional information	<ul style="list-style-type: none"> ▪ For local operation, the customer-specific access code, which has been defined in the Define access code parameter (→  165), has to be entered. ▪ If an incorrect access code is entered, the user retains his current access authorization. ▪ The write protection affects all parameters marked with the -symbol in this document. On the local display, the -symbol in front of a parameter indicates that the parameter is write-protected. ▪ If no key is pressed for 10 min, or the user switches from the navigation and editing mode back to the measured value display mode, the device automatically locks the write-protected parameters after another 60 s. <p> Please contact your Endress+Hauser Sales Center if you lose your access code.</p>

"Level" submenu

Navigation  Setup → Advanced setup → Level

Medium type 

Navigation  Setup → Advanced setup → Level → Medium type

Description Specify medium type.

User interface

- Liquid
- Solid

Factory setting Solid

Additional information  This parameter determines the value of several other parameters and strongly influences the complete signal evaluation. Therefore, it is strongly recommended **not to change** the factory setting.

Medium property 

Navigation  Setup → Advanced setup → Level → Medium property



Description Specify relative dielectric constant ϵ_r of the medium.

Selection

- Unknown
- DC 1.4 ... 1.6
- DC 1.6 ... 1.9
- DC 1.9 ... 2.5
- DC 2.5 ... 4
- DC 4 ... 7
- DC 7 ... 15
- DC > 15

Factory setting Depending on the **Medium type** (→  126) and **Medium group** parameters.

Additional information *Dependence on "Medium type" and "Medium group"*

Medium type (→  126)	Medium group	Medium property (→  126)
Solid		Unknown
Liquid	Water based (DC >= 4)	DC 4 ... 7
	Others	Unknown

 For dielectric constants (DC values) of many media commonly used in various industries refer to:

- the Endress+Hauser DC manual (CP01076F)
- the Endress+Hauser "DC Values App" (available for Android and iOS)

Max. filling speed liquid



Navigation Setup → Advanced setup → Level → Max. filling speed liquid

Prerequisite **Medium type** (→ 126) = **Liquid**

Description Select expected maximum filling speed.

- Selection**
- Slow < 1cm (0.4in) /min
 - Medium < 10cm (4in) /min
 - Standard < 1m (40in) /min
 - Fast < 2m (80in) /min
 - Very fast > 2m (80in) /min
 - No filter / test

Factory setting Depending on the **Tank type** parameter

Additional information By selecting the maximum expected filling and draining speed the signal evaluation is automatically optimized for the process.

Max. draining speed liquid	Step response time / s
Slow < 1cm (0.4in) /min	90
Medium < 10cm (4in) /min	50
Standard < 1m (40in) /min	19
Fast < 2m (80in) /min	8
Very fast > 2m (80in) /min	6
No filter / test	< 1

- The filling and draining speeds can be set separately as the filling and draining procedures may be different.
- With the **No filter / test** option all signal evaluation filters are deactivated. This option should exclusively be used for tests.
- Max. filling speed liquid** is preset by **Tank type**. It can, however, be adjusted to the process in the vessel at any time. If **Tank type** is changed again, it may be necessary to repeat the fine adjustment.

Max. draining speed liquid



Navigation Setup → Advanced setup → Level → Max. draining speed liquid

Prerequisite **Tank type** = **Liquid**

Description Select expected maximum draining speed.

- Selection**
- Slow < 1cm (0.4in) /min
 - Medium < 10cm (4in) /min
 - Standard < 1m (40in) /min

- Fast < 2m (80in) /min
- Very fast > 2m (80in) /min
- No filter / test



Factory setting

Depending on the **Tank type** parameter

Additional information

By selecting the maximum expected filling and draining speed the signal evaluation is automatically optimized for the process.



Max. draining speed liquid	Step response time / s
Slow < 1cm (0.4in) /min	90
Medium < 10cm (4in) /min	50
Standard < 1m (40in) /min	19
Fast < 2m (80in) /min	8
Very fast > 2m (80in) /min	6
No filter / test	< 1

-  The filling and draining speeds can be set separately as the filling and draining procedures may be different.
-  With the **No filter / test** option all signal evaluation filters are deactivated. This option should exclusively be used for tests.
-  **Max. draining speed liquid** is preset by **Tank type**. It can, however, be adjusted to the process in the vessel at any time. If **Tank type** is changed again, it may be necessary to repeat the fine adjustment.

Level unit



Navigation

  Setup → Advanced setup → Level → Level unit

Description

Select level unit.

Selection



- | | |
|---|---|
| <p><i>SI units</i></p> <ul style="list-style-type: none"> ■ % ■ m ■ mm | <p><i>US units</i></p> <ul style="list-style-type: none"> ■ ft ■ in |
|---|---|

Factory setting

%

Additional information

The level unit may differ from the distance unit defined in the **Distance unit** parameter (→  115):

- The unit defined in the **Distance unit** parameter is used for the basic calibration (**Empty calibration** (→  117) and **Full calibration** (→  118)).
- The unit defined in the **Level unit** parameter is used to display the (nonlinearized) level.

Blocking distance

Navigation	Setup → Advanced setup → Level → Blocking distance
Description	Dead band in front of the process connection.
User entry	0 to 200 m
Factory setting	<ul style="list-style-type: none"> ■ Empty calibration - Full calibration - 200 mm (8 in) ■ Minimum value: 150 mm (6 in)
Additional information	The blocking distance can be used to suppress interference echos in the vicinity of the antenna.

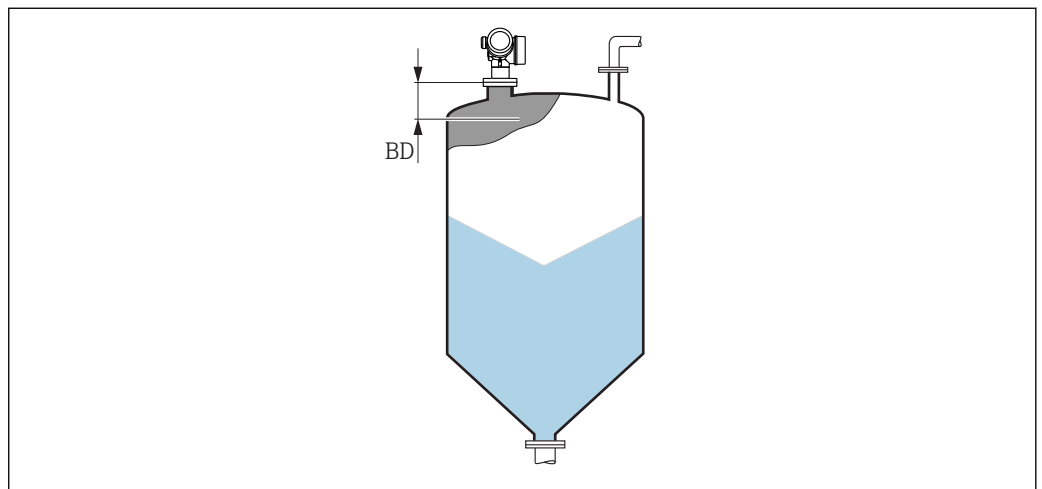

A0023041

40 *Blocking distance (BD) for bulk solid measurements*

Level correction

Navigation	Setup → Advanced setup → Level → Level correction
Description	Specify level correction (if required).
User entry	-200 000.0 to 200 000.0 %
Factory setting	0.0 %
Additional information	The value specified in this parameter is added to the measured level (before linearization).

Tank/silo height

Navigation	Setup → Advanced setup → Level → Tank/silo height
Description	Total height of the tank or silo (measured from the process connection)

User entry -999.9999 to 999.9999 m

Factory setting **Empty calibration** (→  117)

Additional information If the parametrized measuring range differs significantly from the tank or silo height, it is recommended to enter the tank or silo height. Example: Continuous level monitoring in the upper third of a tank or silo.

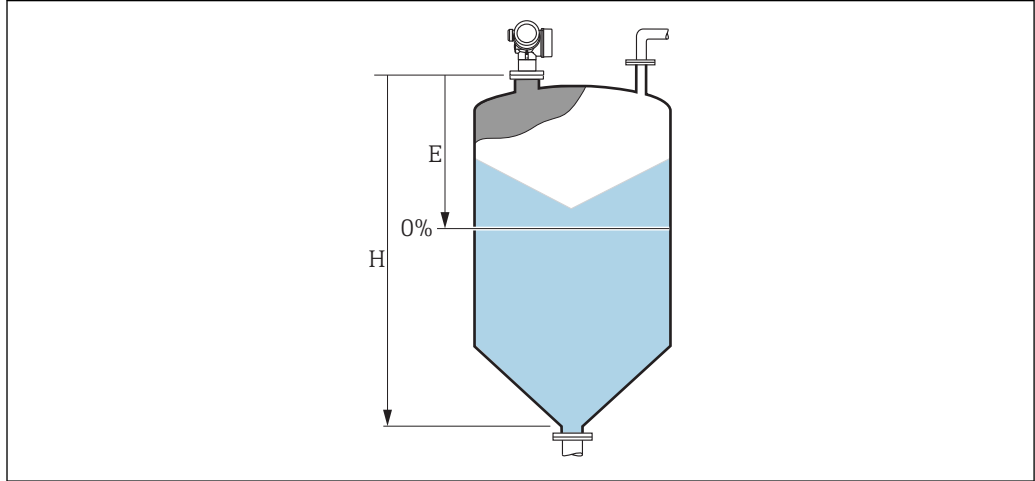



A0019868

 41 "Tank/silo height" parameter for measurements in bulk solids

E Empty calibration (→  117)

H Tank/silo height (→  129)

 For tanks with conical outlet, **Tank/silo height** should not be changed as in this type of applications **Empty calibration** (→  117) is usually **not** much less than the tank or silo height.

"Linearization" submenu

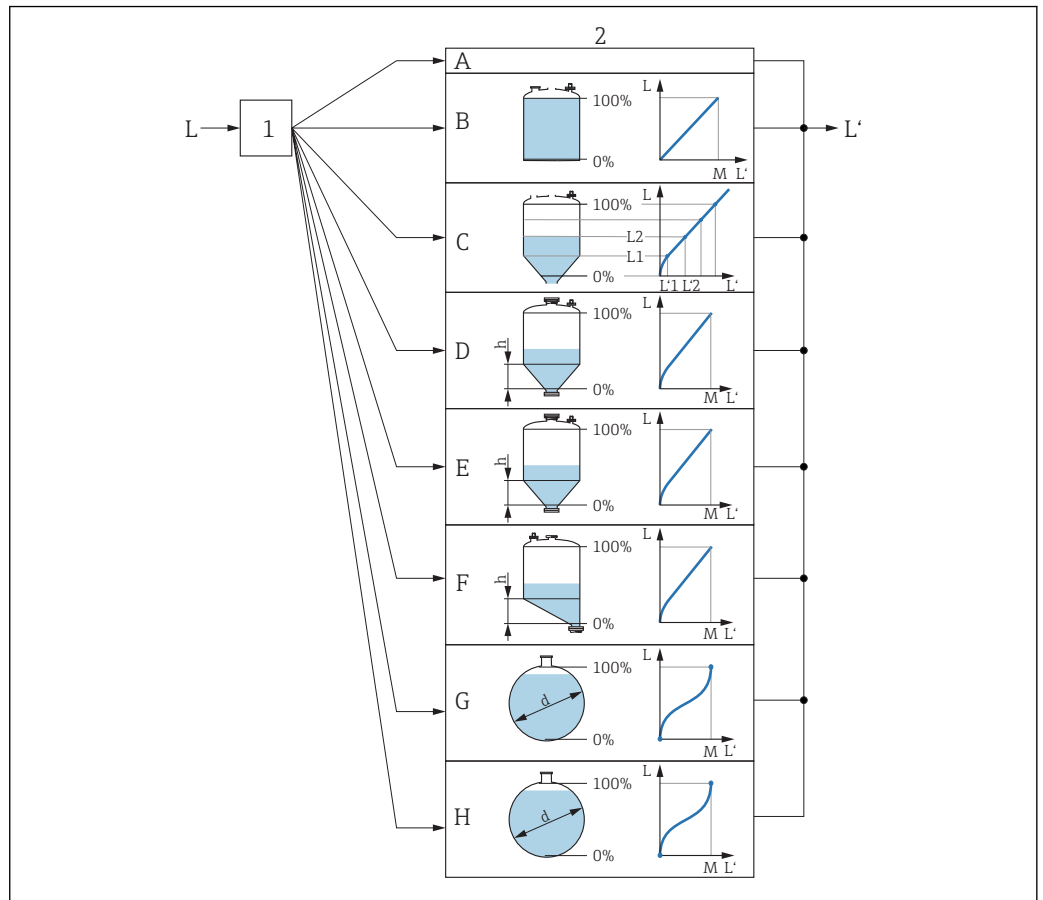











A0019648

42 Linearization: Transformation of the level and (if relevant) the interface height into a volume or weight; the transformation is dependent on the shape of the vessel.

- 1 Selection of linearization type and unit
- 2 Configuration of the linearization
- A Linearization type (→ 134) = None
- B Linearization type (→ 134) = Linear
- C Linearization type (→ 134) = Table
- D Linearization type (→ 134) = Pyramid bottom
- E Linearization type (→ 134) = Conical bottom
- F Linearization type (→ 134) = Angled bottom
- G Linearization type (→ 134) = Horizontal cylinder
- H Linearization type (→ 134) = Sphere
- L Level before linearization (measured in distance units)
- L' Level linearized (→ 136) (corresponds to volume or weight)
- M Maximum value (→ 137)
- d Diameter (→ 137)
- h Intermediate height (→ 137)













Structure of the submenu on the display module

Navigation  Setup → Advanced setup → Linearization

► Linearization		
Linearization type		→  134
Unit after linearization		→  135
Free text		→  136
Maximum value		→  137
Diameter		→  137
Intermediate height		→  137
Table mode		→  138
► Edit table		
	Level	→  139
	Customer value	→  140
	Activate table	→  140

Structure of the submenu in an operating tool (e.g. FieldCare)

Navigation  Setup → Advanced setup → Linearization

► Linearization	
Linearization type	→  134
Unit after linearization	→  135
Free text	→  136
Level linearized	→  136
Maximum value	→  137
Diameter	→  137
Intermediate height	→  137
Table mode	→  138
Table number	→  139
Level	→  139
Level	→  140
Customer value	→  140
Activate table	→  140

Description of parameters

Navigation  Setup → Advanced setup → Linearization

Linearization type 

Navigation  Setup → Advanced setup → Linearization → Linearization type

Description Select linearization type.

- Selection**
- None
 - Linear
 - Table
 - Pyramid bottom
 - Conical bottom
 - Angled bottom
 - Horizontal cylinder
 - Sphere

Factory setting None

Additional information

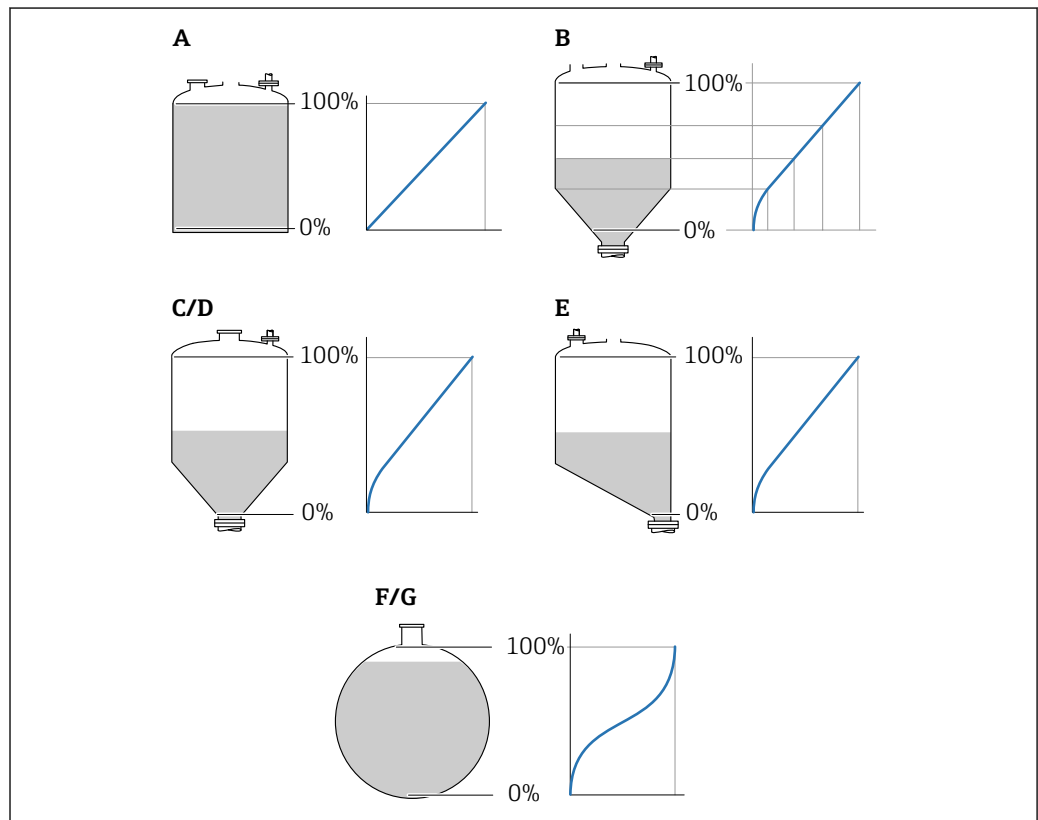

A0021476

 43 *Linearization types*



- A None
- B Table
- C Pyramid bottom
- D Conical bottom
- E Angled bottom
- F Sphere
- G Horizontal cylinder

Meaning of the options**■ None**

The level is transmitted in the level unit without linearization.





■ Linear

The output value (volume/weight) is directly proportional to the level L. This is valid, for example, for vertical cylinders. The following additional parameters have to be specified:

- **Unit after linearization** (→  135)
- **Maximum value** (→  137): Maximum volume or weight



■ Table

The relationship between the measured level L and the output value (volume/weight) is given by a linearization table consisting of up to 32 pairs of values "level - volume" or "level - weight", respectively. The following additional parameters have to be specified:

- **Unit after linearization** (→  135)
- **Table mode** (→  138)
- For each table point: **Level** (→  139)
- For each table point: **Customer value** (→  140)
- **Activate table** (→  140)



■ Pyramid bottom

The output value corresponds to the volume or weight in a silo with pyramid bottom. The following additional parameters have to be specified:

- **Unit after linearization** (→  135)
- **Maximum value** (→  137): Maximum volume or weight
- **Intermediate height** (→  137): The height of the pyramid



■ Conical bottom

The output value corresponds to the volume or weight in a tank with conical bottom. The following additional parameters have to be specified:

- **Unit after linearization** (→  135)
- **Maximum value** (→  137): Maximum volume or weight
- **Intermediate height** (→  137): The height of the conical part of the tank



■ Angled bottom

The output value corresponds to the volume or weight in a silo with an angled bottom. The following additional parameters have to be specified:

- **Unit after linearization** (→  135)
- **Maximum value** (→  137): Maximum volume or weight
- **Intermediate height** (→  137): Height of the angled bottom



■ Horizontal cylinder

The output value corresponds to the volume or weight in a horizontal cylinder. The following additional parameters have to be specified:

- **Unit after linearization** (→  135)
- **Maximum value** (→  137): Maximum volume or weight
- **Diameter** (→  137)

■ Sphere

The output value corresponds to the volume or weight in a spherical tank. The following additional parameters have to be specified:

- **Unit after linearization** (→  135)
- **Maximum value** (→  137): Maximum volume or weight
- **Diameter** (→  137)

Unit after linearization**Navigation**

  Setup → Advanced setup → Linearization → Unit after linearization

Prerequisite

Linearization type (→  134) ≠ None

Description

Select unit of the linearized value.



Selection	<i>SI units</i> <ul style="list-style-type: none"> ■ STon ■ t ■ kg ■ cm³ ■ dm³ ■ m³ ■ hl ■ l ■ % ■ mm ■ m 	<i>US units</i> <ul style="list-style-type: none"> ■ lb ■ UsGal ■ ft³ ■ ft ■ in 	<i>Imperial units</i> impGal
------------------	---	---	---------------------------------

Custom-specific units



Free text

Factory setting %

Additional information The selected unit is only used to be indicated on the display. The measured value is **not** transformed according to the selected unit.

 It is also possible to configure a distance-to-distance linearization, i.e. a transformation from the level unit to a different distance unit. To do so, select the **Linear** linearization mode. In order to define the new level unit, select the **Free text** option in the **Unit after linearization** parameter and enter the required unit into the **Free text** parameter (→  136).

Free text 

Navigation   Setup → Advanced setup → Linearization → Free text

Prerequisite **Unit after linearization** (→  135) = **Free text**

Description Enter unit symbol.



User entry Up to 32 alphanumerical characters (letters, numbers, special characters)

Factory setting Free text

Level linearized



Navigation  Setup → Advanced setup → Linearization → Level linearized

Description Displays linearized level.

Additional information  The unit is defined by the **Unit after linearization** parameter →  135.





Maximum value



Navigation	  Setup → Advanced setup → Linearization → Maximum value
Prerequisite	Linearization type (→  134) has one of the following values: <ul style="list-style-type: none"> ■ Linear ■ Pyramid bottom ■ Conical bottom ■ Angled bottom ■ Horizontal cylinder ■ Sphere
Description	Linearized value corresponding to a level of 100%.
User entry	-50 000.0 to 50 000.0 %
Factory setting	100.0 %



Diameter



Navigation	  Setup → Advanced setup → Linearization → Diameter
Prerequisite	Linearization type (→  134) has one of the following values: <ul style="list-style-type: none"> ■ Horizontal cylinder ■ Sphere
Description	Diameter of the cylindrical or spherical tank.
User entry	0 to 9 999.999 m
Factory setting	2 m
Additional information	The unit is defined in the Distance unit parameter (→  115).

Intermediate height



Navigation	  Setup → Advanced setup → Linearization → Intermediate height
Prerequisite	Linearization type (→  134) has one of the following values: <ul style="list-style-type: none"> ■ Pyramid bottom ■ Conical bottom ■ Angled bottom
Description	Height of the pyramid, conical or angled bottom.
User entry	0 to 200 m
Factory setting	0 m

Additional information

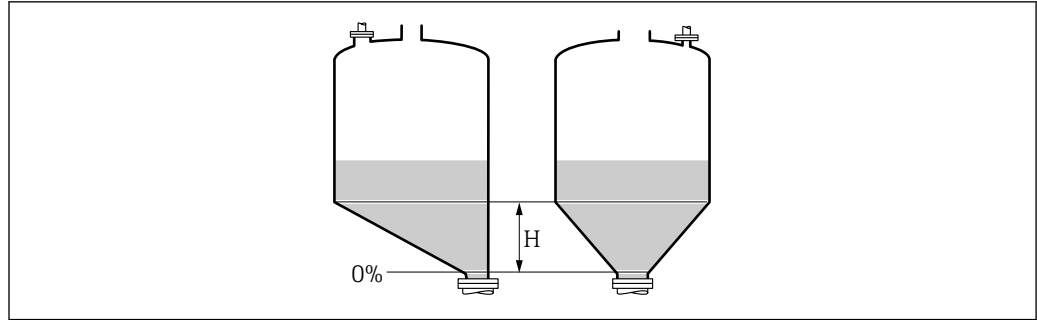

A0013264

H Intermediate height

The unit is defined in the **Distance unit** parameter (→ 115).

Table mode

Navigation

Setup → Advanced setup → Linearization → Table mode

Prerequisite

Linearization type (→ 134) = **Table**

Description

Select editing mode of the linearization table.

Selection

- Manual
- Semiautomatic
- Clear table
- Sort table

Factory setting

Manual

Additional information

Meaning of the options

- **Manual**
The level and the associated linearized value are entered manually for each linearization point.
- **Semiautomatic**
The level is measured by the device for each linearization point. The associated linearized value is entered manually.
- **Clear table**
Deletes the existing linearization table.
- **Sort table**
Rearranges the linearization points into an ascending order.



Conditions the linearization table must meet:



- The table may consist of up to 32 pairs of values "Level - Linearized Value".
- The table must be monotonic (monotonically increasing or decreasing).
- The first linearization point must refer to the minimum level.
- The last linearization point must refer to the maximum level.

Before entering a linearization table, the values for **Empty calibration** (→ 117) and **Full calibration** (→ 118) must be set correctly.

If values of the table need to be changed after the full or empty calibration have been changed, a correct evaluation is only ensured if the existing table is deleted and the complete table is entered again. To do so delete the existing table (**Table mode** (→ 138) = **Clear table**). Then enter a new table.

How to enter the table

- Via FieldCare
The table points can be entered via the **Table number** (→  139), **Level** (→  139) and **Customer value** (→  140) parameters. As an alternative, the graphic table editor may be used: Device Operation → Device Functions → Additional Functions → Linearization (Online/Offline)
- Via local display
Select the **Edit table** submenu to call up the graphic table editor. The table is displayed and can be edited line by line.

 The factory setting for the level unit is "%". If you want to enter the linearization table in physical units, you must select the appropriate unit in the **Level unit** parameter (→  128) beforehand.











 If a decreasing table is entered, the values for 20 mA and 4 mA of the current output are interchanged. That means: 20 mA refers to the lowest level, whereas 4 mA refers to the highest level.

Table number	
<hr/>	
Navigation	 Setup → Advanced setup → Linearization → Table number
Prerequisite	Linearization type (→  134) = Table
Description	Select table point you are going to enter or change.
User entry	1 to 32
Factory setting	1



Level (Manual)	
<hr/>	
Navigation	 Setup → Advanced setup → Linearization → Level
Prerequisite	<ul style="list-style-type: none"> ▪ Linearization type (→  134) = Table ▪ Table mode (→  138) = Manual
Description	Enter level value of the table point (value before linearization).
User entry	Signed floating-point number
Factory setting	0 %

Level (Semiautomatic)

Navigation	 Setup → Advanced setup → Linearization → Level
Prerequisite	<ul style="list-style-type: none"> ▪ Linearization type (→  134) = Table ▪ Table mode (→  138) = Semiautomatic
Description	Displays measured level (value before linearization). This value is transmitted to the table.





Customer value



Navigation	 Setup → Advanced setup → Linearization → Customer value
Prerequisite	Linearization type (→  134) = Table
Description	Enter linearized value for the table point.
User entry	Signed floating-point number
Factory setting	0 %

Activate table



Navigation	  Setup → Advanced setup → Linearization → Activate table
Prerequisite	Linearization type (→  134) = Table
Description	Activate (enable) or deactivate (disable) the linearization table.
Selection	<ul style="list-style-type: none"> ▪ Disable ▪ Enable
Factory setting	Disable
Additional information	<p>Meaning of the options</p> <ul style="list-style-type: none"> ▪ Disable The measured level is not linearized. If Linearization type (→  134) = Table at the same time, the device issues error message F435. ▪ Enable The measured level is linearized according to the table. <p> When editing the table, the Activate table parameter is automatically reset to Disable and must be reset to Enable after the table has been entered.</p>

"Safety settings" submenu

Navigation  Setup → Advanced setup → Safety settings

Output echo lost 



Navigation  Setup → Advanced setup → Safety settings → Output echo lost

Description Output signal in case of a lost echo.

- Selection**
- Last valid value
 - Ramp at echo lost
 - Value echo lost
 - Alarm

Factory setting Last valid value

Additional information **Meaning of the options**

- **Last valid value**
The last valid value is kept in the case of a lost echo.
- **Ramp at echo lost**⁷⁾
In the case of a lost echo the output value is continuously shifted towards 0% or 100%. The slope of the ramp is defined in the **Ramp at echo lost** parameter (→  142).
- **Value echo lost**⁷⁾
In the case of a lost echo the output assumes the value defined in the **Value echo lost** parameter (→  141).
- **Alarm**
In the case of a lost echo the device generates an alarm; see the **Failure mode** parameter (→  148)

Value echo lost 

Navigation  Setup → Advanced setup → Safety settings → Value echo lost



Prerequisite **Output echo lost** (→  141) = **Value echo lost**

Description Output value in case of a lost echo

User entry 0 to 200 000.0 %

Factory setting 0.0 %

Additional information Use the unit which has been defined for the measured value output:

- without linearization: **Level unit** (→  128)
- with linearization: **Unit after linearization** (→  135)

7) Only visible if "Linearization type" (→  134) = "None"

Ramp at echo lost



Navigation Setup → Advanced setup → Safety settings → Ramp at echo lost

Prerequisite **Output echo lost (→ 141) = Ramp at echo lost**

Description Slope of the ramp in the case of a lost echo

User entry Signed floating-point number

Factory setting 0.0 %/min

Additional information

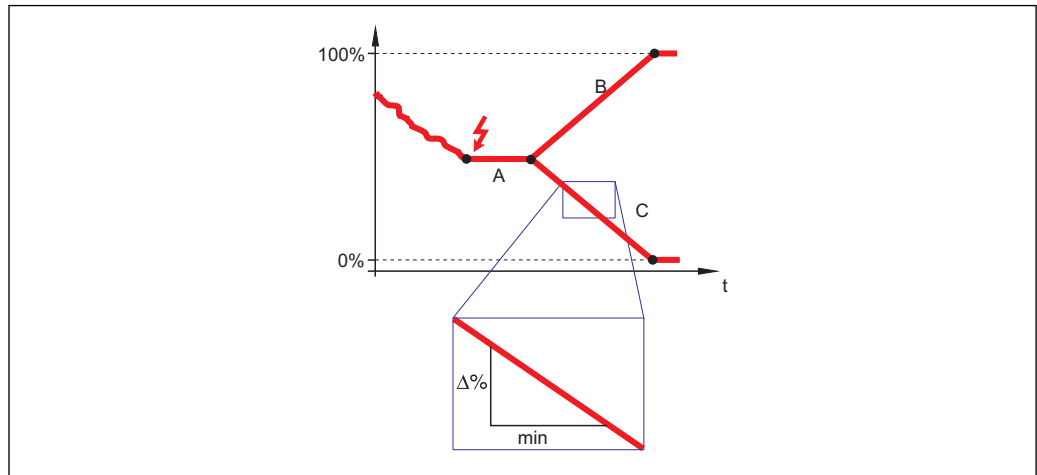

A0013269

- A Delay time echo lost
- B Ramp at echo lost (→ 142) (positive value)
- C Ramp at echo lost (→ 142) (negative value)

- The unit for the slope of the ramp is "percentage of the measuring range per minute" (%/min).
- For a negative slope of the ramp: The measured value is continuously decreased until it reaches 0%.
- For a positive slope of the ramp: The measured value is continuously increased until it reaches 100%.

Blocking distance



Navigation Setup → Advanced setup → Safety settings → Blocking distance

Description Specify blocking distance BD.

User entry 0 to 200 m

Factory setting 0 mm (0 in)

Additional information Signals in the blocking distance are only evaluated if they have been outside the blocking distance when the device was switched on and move into the blocking distance due to a

level change during operation. Signals which are already in the blocking distance when the device is switched on, are ignored.

 If required, a different behavior for signals in the blocking distance can be defined by the Endress+Hauser service.

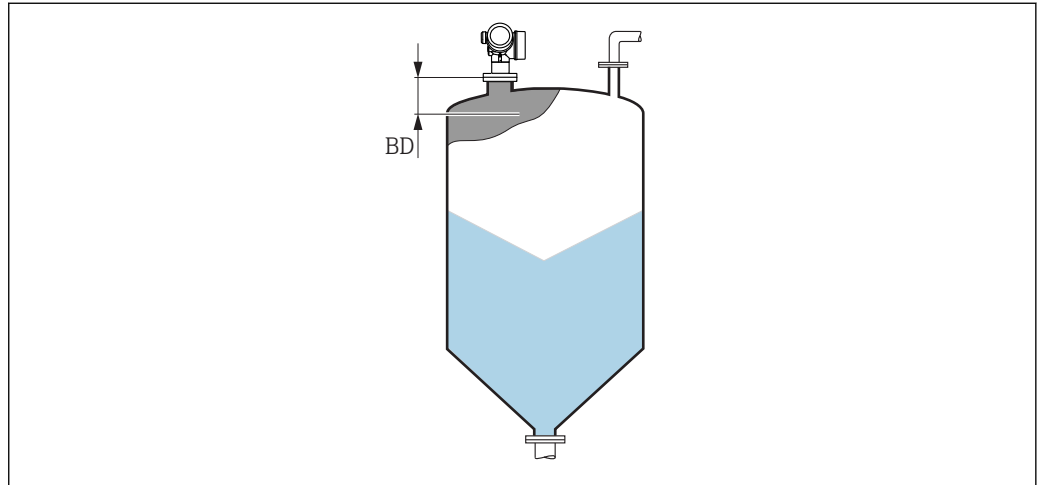

 44 Blocking distance (BD) for bulk solid measurements

A0023041



"SIL/WHG confirmation" wizard

 The **SIL/WHG confirmation** wizard is only available for devices with SIL or WHG approval (Feature 590: "Additional Approval", option LA: "SIL" or LC: "WHG overflow prevention") which are currently **not** in the SIL- or WHG-locked state.

The **SIL/WHG confirmation** wizard is required to lock the device according to SIL or WHG. For details refer to the "Functional Safety Manual" of the respective device, which describes the locking procedure and the parameters of the sequence.



Navigation  Setup → Advanced setup → SIL/WHG confirmation

"Deactivate SIL/WHG" wizard



 The **Deactivate SIL/WHG** wizard (→  145) is only visible if the device is SIL-locked or WHG-locked. For details refer to the "Functional Safety Manual" of the respective device.

Navigation   Setup → Advanced setup → Deactivate SIL/WHG



Reset write protection

Navigation	  Setup → Advanced setup → Deactivate SIL/WHG → Reset write protection
Description	Enter unlocking code.
User entry	0 to 65 535
Factory setting	0

Code incorrect

Navigation	  Setup → Advanced setup → Deactivate SIL/WHG → Code incorrect
Description	Indicates that a wrong unlocking code has been entered. Select procedure.
Selection	<ul style="list-style-type: none"> ■ Reenter code ■ Abort sequence
Factory setting	Reenter code

"Current output 1 to 2" submenu

 The **Current output 2** submenu (→  146) is only available for devices with two current outputs.

Navigation  Setup → Advanced setup → Current output 1 to 2

Assign current output 1 to 2 

Navigation  Setup → Advanced setup → Current output 1 to 2 → Assign current output



Description Select process variable for current output.

- Selection**
- Level linearized
 - Distance
 - Electronic temperature
 - Relative echo amplitude
 - Analog output adv. diagnostics 1
 - Analog output adv. diagnostics 2
 - Area of incoupling

- Factory setting**
- Current output 1: Level linearized
 - Current output 2 ⁸⁾: Level linearized

Additional information *Definition of the current range for the process variables*

Process variable	4 mA value	20 mA value
Level linearized	0 % ¹⁾ or the associated linearized value	100 % ²⁾ or the associated linearized value
Distance	0 (i.e. level is at the reference point)	Empty calibration (→  117) (i.e. level is at 0 %)
Electronic temperature	-50 °C (-58 °F)	100 °C (212 °F)
Analog output adv. diagnostics 1/2	depending on the parametrization of the Advanced Diagnostics	

- 1) the 0% level is defined by **Empty calibration** parameter (→  117)
 2) The 100% level is defined by **Full calibration** parameter (→  118)

-  This can be done by the following parameters:
- Expert → Output → Current output 1 to 2 → Turn down
 - Expert → Output → Current output 1 to 2 → 4 mA value
 - Expert → Output → Current output 1 to 2 → 20 mA value

8) only for devices with two current outputs

Current span



Navigation Setup → Advanced setup → Current output 1 to 2 → Current span

Description Determines the current range used to transmit the measured value. '4...20mA': Measured variable: 4 ...20 mA '4...20mA NAMUR': Measured variable: 3.8 ... 20.5 mA '4...20mA US': Measured variable: 3.9 ... 20.8 mA 'Fixed current': Measured variable transmitted via HART only Note: Currents below 3.6 mA or above 21.95 mA can be used to signal an alarm.

- Selection**
- 4...20 mA
 - 4...20 mA NAMUR
 - 4...20 mA US
 - Fixed current

Factory setting 4...20 mA NAMUR

Additional information *Meaning of the options*

Option	Current range for process variable	Lower alarm signal level	Upper alarm signal level
4...20 mA	4 to 20.5 mA	< 3.6 mA	> 21.95 mA
4...20 mA NAMUR	3.8 to 20.5 mA	< 3.6 mA	> 21.95 mA
4...20 mA US	3.9 to 20.8 mA	< 3.6 mA	> 21.95 mA
Fixed current	Constant current, defined in the Fixed current parameter (→ 147).		

- In the case of an error, the output current assumes the value defined in the **Failure mode** parameter (→ 148).
- If the measured value is out of the measuring range, diagnostic message **Current output** is issued.
- In a HART multidrop loop only one device can use the analog current to transmit a signal. For all other devices one must set:
 - **Current span = Fixed current**
 - **Fixed current** (→ 147) = **4 mA**

Fixed current



Navigation Setup → Advanced setup → Current output 1 to 2 → Fixed current

Prerequisite **Current span** (→ 147) = **Fixed current**

Description Define constant value of the output current.

User entry 4 to 22.5 mA

Factory setting 4 mA

Damping output

Navigation	Setup → Advanced setup → Current output 1 to 2 → Damping output
Description	Reaction time of the output signal on fluctuation in the measured value.
User entry	0.0 to 999.9 s
Factory setting	0.0 s
Additional information	Fluctuations of the measured value affect the output current with an exponential delay, the time constant τ of which is defined in this parameter. With a small time constant the output reacts immediately to changes of the measured value. With a big time constant the reaction of the output is more delayed. For $\tau = 0$ (factory setting) there is no damping.

Failure mode

Navigation	Setup → Advanced setup → Current output 1 to 2 → Failure mode
Prerequisite	Current span (→ 147) ≠ Fixed current
Description	Defines which current the output assumes in the case of an error. 'Min.': < 3.6mA 'Max.': > 21.95mA 'Last valid value': Last valid value before occurrence of the error. 'Actual value': Output current is equal to the measured value; error is ignored. 'Defined value': User defined value.
Selection	<ul style="list-style-type: none"> ▪ Min. ▪ Max. ▪ Last valid value ▪ Actual value ▪ Defined value
Factory setting	Max.
Additional information	<p>Meaning of the options</p> <ul style="list-style-type: none"> ▪ Min. The current output adopts the value of the lower alarm level according to the Current span parameter (→ 147). ▪ Max. The current output adopts the value of the upper alarm level according to the Current span parameter (→ 147). ▪ Last valid value The current remains constant at the last value it had before the error occurred. ▪ Actual value The output current follows the actual measured value; the error is ignored. ▪ Defined value The output current assumes the value defined in the Failure current parameter (→ 149). <p> The error behavior of other output channels is not influenced by these settings but is defined in separate parameters.</p>

Failure current





Navigation	Setup → Advanced setup → Current output 1 to 2 → Failure current
Prerequisite	Failure mode (→ 148) = Defined value
Description	Defines which current the output assumes in case of an error.
User entry	3.59 to 22.5 mA
Factory setting	22.5 mA

Output current 1 to 2

Navigation	Setup → Advanced setup → Current output 1 to 2 → Output current 1 to 2
Description	Shows the actual calculated value of the output current.

"Switch output" submenu

 The **Switch output** submenu (→  150) is only visible for devices with switch output.⁹⁾

Navigation  Setup → Advanced setup → Switch output

Switch output function**Navigation**

 Setup → Advanced setup → Switch output → Switch output function

Description

Defines the function of the switch output. 'Off' The switch output is always open (non-conductive) 'On' The switch output is always closed (conductive). 'Diagnostic behavior' The switch output is normally closed and is only opened if a diagnostic event is present. 'Limit' The switch output is normally closed and is only opened if a measured variable exceeds a defined limit. 'Digital output' The switch output is controlled by one of the digital output blocks of the device.





Selection

- Off
- On
- Diagnostic behavior
- Limit
- Digital Output

Factory setting

Off

Additional information**Meaning of the options**

- **Off**
The output is always open (non-conductive).
- **On**
The output is always closed (conductive).
- **Diagnostic behavior**
The output is normally closed and is only opened if a diagnostic event is present. The **Assign diagnostic behavior** parameter (→  151) determines for which type of event the output is opened.
- **Limit**
The output is normally closed and is only opened if a measured variable exceeds or falls below a defined limit. The limit values are defined by the following parameters:
 - **Assign limit** (→  151)
 - **Switch-on value** (→  152)
 - **Switch-off value** (→  153)
- **Digital Output**
The switching state of the output tracks the output value of a DI function block. The function block is selected in the **Assign status** parameter (→  151).

 The **Off** and **On** options can be used to simulate the switch output.

9) Ordering feature 020 "Power supply; Output", option B, E or G

Assign status
**Navigation**

Setup → Advanced setup → Switch output → Assign status

Prerequisite**Switch output function (→ 150) = Digital Output****Selection**

- Off
- Digital output AD 1
- Digital output AD 2
- Digital output AD 3
- Digital output AD 4

Factory setting

Off

Additional information

The **Digital output AD 1/2/3/4** options refer to the Advanced Diagnostic Blocks. A switch signal generated in these blocks can be transmitted via the switch output.

Assign limit
**Navigation**

Setup → Advanced setup → Switch output → Assign limit

Prerequisite**Switch output function (→ 150) = Limit****Selection**

- Off
- Level linearized
- Distance
- Terminal voltage
- Electronic temperature
- Relative echo amplitude
- Area of incoupling

Factory setting

Off

Assign diagnostic behavior
**Navigation**

Setup → Advanced setup → Switch output → Assign diagnostic behavior

Prerequisite**Switch output function (→ 150) = Diagnostic behavior****Description**

Defines to which behavior of diagnostic events the switch output reacts.

Selection

- Alarm
- Alarm or warning
- Warning

Factory setting

Alarm

Switch-on value



Navigation

Setup → Advanced setup → Switch output → Switch-on value

Prerequisite

Switch output function (→ 150) = **Limit**

Description

Defines the switch-on point. The output is closed if the assigned process variable rises above this point.

User entry

Signed floating-point number

Factory setting

0

Additional information

The switching behavior depends on the relative position of the **Switch-on value** and **Switch-off value** parameters:

Switch-on value > Switch-off value

- The output is closed if the measured value is larger than **Switch-on value**.
- The output is opened if the measured value is smaller than **Switch-off value**.

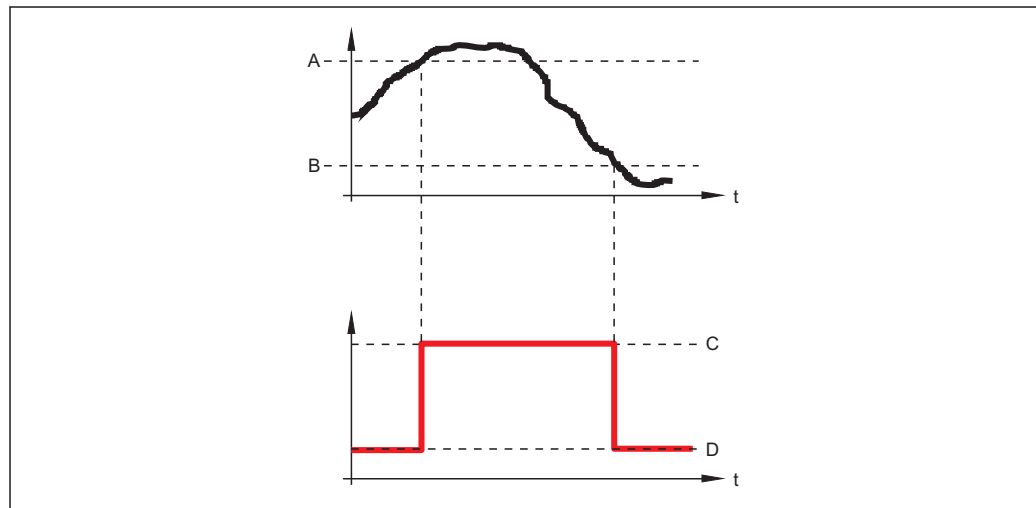

A0015585

- A *Switch-on value*
- B *Switch-off value*
- C *Output closed (conductive)*
- D *Output opened (non-conductive)*

Switch-on value < Switch-off value

- The output is closed if the measured value is smaller than **Switch-on value**.
- The output is opened if the measured value is larger than **Switch-off value**.

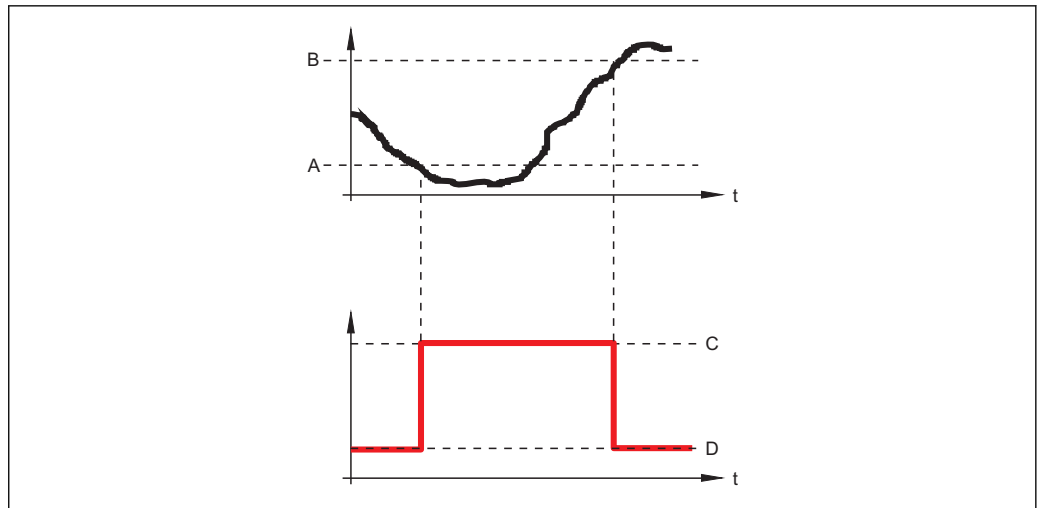

A0015586

- A Switch-on value
- B Switch-off value
- C Output closed (conductive)
- D Output opened (non-conductive)

Switch-on delay







Navigation	☰☰ Setup → Advanced setup → Switch output → Switch-on delay
Prerequisite	<ul style="list-style-type: none"> ▪ Switch output function (→ ☰ 150) = Limit ▪ Assign limit (→ ☰ 151) ≠ Off
Description	Defines the delay applied before the output is switched on.
User entry	0.0 to 100.0 s
Factory setting	0.0 s

Switch-off value





Navigation	☰☰ Setup → Advanced setup → Switch output → Switch-off value
Prerequisite	Switch output function (→ ☰ 150) = Limit
Description	Defines the switch-off point. The output is opened if the assigned process variable falls below this point.
User entry	Signed floating-point number
Factory setting	0
Additional information	The switching behavior depends on the relative position of the Switch-on value and Switch-off value parameters; description: see the Switch-on value parameter (→ ☰ 152).

Switch-off delay 



Navigation	  Setup → Advanced setup → Switch output → Switch-off delay
Prerequisite	<ul style="list-style-type: none"> ▪ Switch output function (→  150) = Limit ▪ Assign limit (→  151) ≠ Off
Description	Defines the delay applied before the output is switched off.
User entry	0.0 to 100.0 s
Factory setting	0.0 s

Failure mode 



Navigation	  Setup → Advanced setup → Switch output → Failure mode
Prerequisite	Switch output function (→  150) = Limit or Digital Output
Description	Defines the state of the switch output in case of an error.
Selection	<ul style="list-style-type: none"> ▪ Actual status ▪ Open ▪ Closed
Factory setting	Open

Additional information

Switch status

Navigation	  Setup → Advanced setup → Switch output → Switch status
Description	Current status of the switch output.

Invert output signal 

Navigation	  Setup → Advanced setup → Switch output → Invert output signal
Description	'No' The switch output behaves as per its parameter setting. 'Yes' The switching behavior is inverted as compared to its parameter setting.
Selection	<ul style="list-style-type: none"> ▪ No ▪ Yes

Factory setting

No

Additional information**Meaning of the options**■ **No**

The behavior of the switch output is as described above.

■ **Yes**The states **Open** and **Closed** are inverted as compared to the description above.

"Display" submenu

 The **Display** submenu is only visible if a display module is connected to the device.

Navigation  Setup → Advanced setup → Display

Language**Navigation**

 Setup → Advanced setup → Display → Language

Description

Set display language.

Selection

- English
- Deutsch *
- Français *
- Español *
- Italiano *
- Nederlands *
- Portuguesa *
- Polski *
- русский язык (Russian) *
- Svenska *
- Türkçe *
- 中文 (Chinese) *
- 日本語 (Japanese) *
- 한국어 (Korean) *
- Bahasa Indonesia *
- tiếng Việt (Vietnamese) *
- čeština (Czech) *

Factory setting

The language selected in feature 500 of the product structure.
If no language has been selected: **English**

Additional information**Format display****Navigation**

 Setup → Advanced setup → Display → Format display

Description

Select how measured values are shown on the display.

Selection

- 1 value, max. size
- 1 bargraph + 1 value
- 2 values
- 1 value large + 2 values
- 4 values

Factory setting

1 value, max. size

* Visibility depends on order options or device settings

Additional information

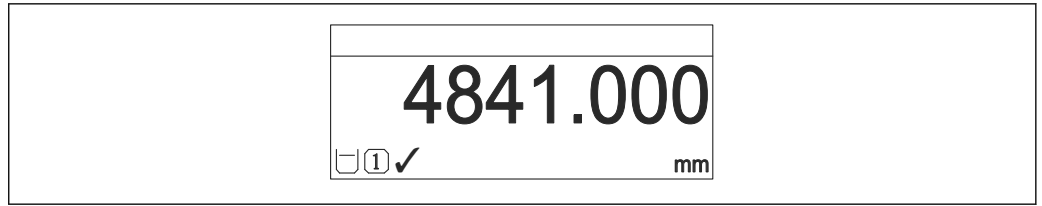

A0019963

45 "Format display" = "1 value, max. size"

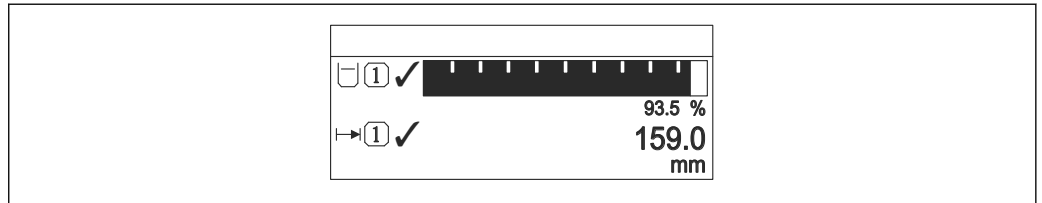

A0019964

46 "Format display" = "1 bargraph + 1 value"

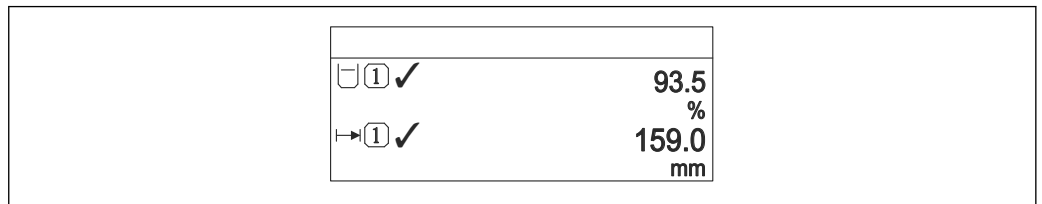

A0019965

47 "Format display" = "2 values"

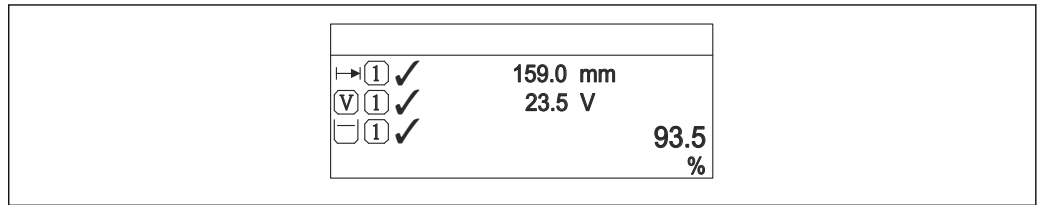

A0019966

48 "Format display" = "1 value large + 2 values"

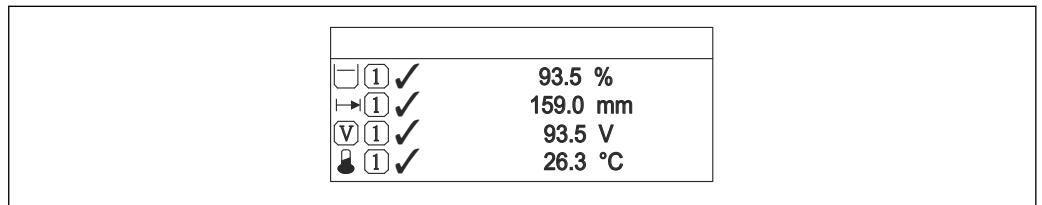

A0019968

49 "Format display" = "4 values"

- i
■
The Value 1 to 4 display → 158 parameters specify which measured values are shown on the display and in which order.
- If more measured values are specified than the current display mode permits, the values alternate on the device display. The display time until the next change is configured in the **Display interval** parameter (→ 158).

Value 1 to 4 display

Navigation Setup → Advanced setup → Display → Value 1 display

Description Select the measured value that is shown on the local display.

Selection

- Level linearized
- Distance
- Absolute echo amplitude
- Relative echo amplitude
- Area of incoupling
- Current output 1
- Measured current
- Current output 2 *
- Terminal voltage
- Electronic temperature
- Analog output adv. diagnostics 1
- Analog output adv. diagnostics 2
- Analog output adv. diagnostics 3
- Analog output adv. diagnostics 4

Factory setting

- Value 1 display: Level linearized
- Value 2 display: None
- Value 3 display: None
- Value 4 display: None

Decimal places 1 to 4

Navigation Setup → Advanced setup → Display → Decimal places 1

Description This selection does not affect the measurement and calculation accuracy of the device.

Selection

- x
- x.x
- x.xx
- x.xxx
- x.xxxx

Factory setting x.xx

Additional information The setting does not affect the measuring or computational accuracy of the device.

Display interval

Navigation Setup → Advanced setup → Display → Display interval

Description Set time measured values are shown on display if display alternates between values.

* Visibility depends on order options or device settings

User entry	1 to 10 s
Factory setting	5 s
Additional information	This parameter is only relevant if the number of selected measuring values exceeds the number of values the selected display format can display simultaneously.

Display damping



Navigation	Setup → Advanced setup → Display → Display damping
Description	Set display reaction time to fluctuations in the measured value.
User entry	0.0 to 999.9 s
Factory setting	0.0 s

Header



Navigation	Setup → Advanced setup → Display → Header
Description	Select header contents on local display.
Selection	<ul style="list-style-type: none"> ■ Device tag ■ Free text
Factory setting	Device tag

Additional information

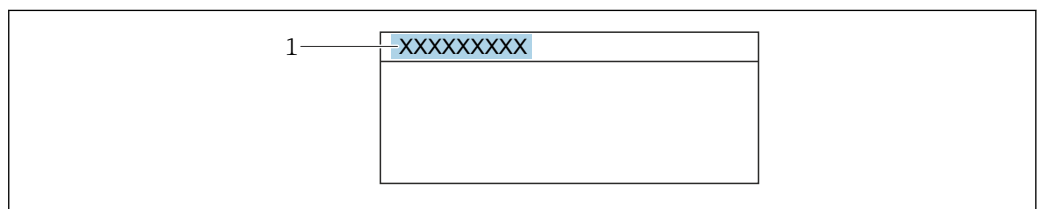



A0029422

1 Position of the header text on the display



Meaning of the options

- **Device tag**
Is defined in the **Device tag** parameter (→ 115)
- **Free text**
Is defined in the **Header text** parameter (→ 160)



Header text 

Navigation	  Setup → Advanced setup → Display → Header text
Prerequisite	Header (→  159) = Free text
Description	Enter display header text.
Factory setting	-----
Additional information	The number of characters which can be displayed depends on the characters used.



Separator 

Navigation	  Setup → Advanced setup → Display → Separator
Description	Select decimal separator for displaying numerical values.
Selection	<ul style="list-style-type: none"> ▪ . ▪ ,
Factory setting	.

Number format 



Navigation	  Setup → Advanced setup → Display → Number format
Description	Choose number format for the display.
Selection	<ul style="list-style-type: none"> ▪ Decimal ▪ ft-in-1/16"
Factory setting	Decimal
Additional information	The ft-in-1/16" option is only valid for distance units.

Decimal places menu 







Navigation	  Setup → Advanced setup → Display → Decimal places menu
Description	Select number of decimal places for the representation of numbers within the operating menu.

Selection	<ul style="list-style-type: none"> ■ X ■ X.X ■ X.XX ■ X.XXX ■ X.XXXX
Factory setting	x.xxx
Additional information	<ul style="list-style-type: none"> ■ Is only valid for numbers in the operating menu (e.g. Empty calibration, Full calibration), but not for the measured value display. The number of decimal places for the measured value display is defined in the Decimal places 1 to 4 →  158 parameters. ■ The setting does not affect the accuracy of the measurement or the calculations.

Backlight

Navigation	  Setup → Advanced setup → Display → Backlight
Prerequisite	The device has the SD03 local display (with optical keys).
Description	Switch the local display backlight on and off.
Selection	<ul style="list-style-type: none"> ■ Disable ■ Enable
Factory setting	Disable
Additional information	<p>Meaning of the options</p> <ul style="list-style-type: none"> ■ Disable Switches the backlight off. ■ Enable Switches the backlight on. <p> Regardless of the setting in this parameter the backlight may be automatically switched off by the device if the supply voltage is too low.</p>

Contrast display

Navigation	  Setup → Advanced setup → Display → Contrast display
Description	Adjust local display contrast setting to ambient conditions (e.g. lighting or reading angle).
User entry	20 to 80 %
Factory setting	Dependent on the display.
Additional information	<p> Setting the contrast via push-buttons:</p> <ul style="list-style-type: none"> ■ Darker: press the   buttons simultaneously. ■ Brighter: press the   buttons simultaneously.

"Configuration backup display" submenu

 This submenu is only visible if a display module is connected to the device.

The configuration of the device can be saved to the display module at a certain point of time (backup). The saved configuration can be restored to the device if required, e.g. in order to bring the device back into a defined state. The configuration can also be transferred to a different device of the same type using the display module.

Navigation  Setup → Advanced setup → Configuration backup display

Operating time

Navigation  Setup → Advanced setup → Configuration backup display → Operating time

Description Indicates how long the device has been in operation.

Additional information *Maximum time*
9999 d (≈ 27 years)

Last backup

Navigation  Setup → Advanced setup → Configuration backup display → Last backup

Description Indicates when the last data backup was saved to the display module.

Configuration management

Navigation  Setup → Advanced setup → Configuration backup display → Configuration management

Description Select action for managing the device data in the display module.



Selection

- Cancel
- Execute backup
- Restore
- Duplicate
- Compare
- Clear backup data



Factory setting Cancel

Additional information

Meaning of the options



- **Cancel**
No action is executed and the user exits the parameter.
 - **Execute backup**
A backup copy of the current device configuration in the HistoROM (built-in in the device) is saved to the display module of the device.
 - **Restore**
The last backup copy of the device configuration is copied from the display module to the HistoROM of the device.
 - **Duplicate**
The transmitter configuration is duplicated to another device using the transmitter display module. The following parameters, which characterize the individual measuring point are **not** included in the transmitted configuration:
 - HART date code
 - HART short tag
 - HART message
 - HART descriptor
 - HART address
 - Device tag
 - Medium type
 - **Compare**
The device configuration saved in the display module is compared to the current device configuration of the HistoROM. The result of this comparison is displayed in the **Comparison result** parameter (→  163).
 - **Clear backup data**
The backup copy of the device configuration is deleted from the display module of the device.
-  While this action is in progress, the configuration cannot be edited via the local display and a message on the processing status appears on the display.
-  If an existing backup is restored to a different device using the **Restore** option, it may occur that some device functionalities are no longer available. In some cases even a device reset will not restore the original status.
- In order to transmit a configuration to a different device, the **Duplicate** option should always be used.

Backup state

Navigation   Setup → Advanced setup → Configuration backup display → Backup state

Description Displays which backup action is currently in progress.

Comparison result

Navigation   Setup → Advanced setup → Configuration backup display → Comparison result

Description Comparison between present device data and display backup.

Additional information**Meaning of the display options****■ Settings identical**

The current device configuration of the HistoROM is identical to the backup copy in the display module.

■ Settings not identical

The current device configuration of the HistoROM is not identical to the backup copy in the display module.

■ No backup available

There is no backup copy of the device configuration of the HistoROM in the display module.

■ Backup settings corrupt

The current configuration of the HistoROM is corrupt or not compatible with the backup copy in the display module.

■ Check not done

The device configuration of the HistoROM has not yet been compared to the backup copy in the display module.

■ Dataset incompatible

The data sets are incompatible and can not be compared.





To start the comparison, set **Configuration management** (→  162) = **Compare**.













If the transmitter configuration has been duplicated from a different device by **Configuration management** (→  162) = **Duplicate**, the new device configuration in the HistoROM is only partially identical to the configuration stored in the display module: Sensor specific properties (e.g. the mapping curve) are not duplicated. Thus, the result of the comparison will be **Settings not identical**.



"Administration" submenu

Navigation  Setup → Advanced setup → Administration

Define access code 

Navigation	 Setup → Advanced setup → Administration → Define access code
Description	Define release code for write access to parameters.
User entry	0 to 9999
Factory setting	0
Additional information	<p> If the factory setting is not changed or 0 is defined as the access code, the parameters are not write-protected and the configuration data of the device can then always be modified. The user is logged on in the <i>Maintenance</i> role.</p> <p> The write protection affects all parameters marked with the  symbol in this document. On the local display, the  symbol in front of a parameter indicates that the parameter is write-protected.</p> <p> Once the access code has been defined, write-protected parameters can only be modified if the access code is entered in the Enter access code parameter (→  125).</p> <p> Please contact your Endress+Hauser Sales Center if you lose your access code.</p> <p> For display operation: The new access code is only valid after it has been confirmed in the Confirm access code parameter (→  167).</p>

Device reset 

Navigation	  Setup → Advanced setup → Administration → Device reset
Description	Reset the device configuration - either entirely or in part - to a defined state.
Selection	<ul style="list-style-type: none"> ■ Cancel ■ To factory defaults ■ To delivery settings ■ Of customer settings ■ To transducer defaults ■ Restart device
Factory setting	Cancel

Additional information**Meaning of the options****■ Cancel**

No action

■ To factory defaults

All parameters are reset to the order-code specific factory setting.

■ To delivery settings

All parameters are reset to the delivery setting. The delivery setting may differ from the factory default if customer specific settings have been ordered.

This option is only visible if customer specific settings have been ordered.

■ Of customer settings

All customer parameters are reset to their factory setting. Service parameters, however, remain unchanged.

■ To transducer defaults

Every measurement-related parameter is reset to its factory setting. Service parameters and communication-related parameters, however, remain unchanged.

■ Restart device

The restart resets every parameter which is stored in the volatile memory (RAM) to the factory setting (e.g. measured value data). The device configuration remains unchanged.

"Define access code" wizard

 The **Define access code** wizard is only available when operating via the local display. When operating via an operating tool, the **Define access code** parameter is located directly in the **Administration** submenu. The **Confirm access code** parameter is not available for operation via operating tool.

Navigation  Setup → Advanced setup → Administration → Define access code

Define access code 

Navigation  Setup → Advanced setup → Administration → Define access code → Define access code

Description →  165

Confirm access code 

Navigation  Setup → Advanced setup → Administration → Define access code → Confirm access code

Description Confirm the entered access code.

User entry 0 to 9999

Factory setting 0

17.5 "Diagnostics" menu

Navigation  Diagnostics

Actual diagnostics



Navigation  Diagnostics → Actual diagnostics

Description Displays current diagnostic message.

Additional information The display consists of:

- Symbol for event behavior
- Code for diagnostic behavior
- Operating time of occurrence
- Event text

 If several messages are active at the same time, the messages with the highest priority is displayed.

 Information on what is causing the message, and remedy measures, can be viewed via the  symbol on the display.

Timestamp

Navigation  Diagnostics → Timestamp

Description Displays the timestamp for the currently active diagnostic message.



Previous diagnostics

Navigation  Diagnostics → Previous diagnostics

Description Displays the last diagnostic message which has been active before the current message.

Additional information The display consists of:

- Symbol for event behavior
- Code for diagnostic behavior
- Operating time of occurrence
- Event text

 The condition displayed may still apply. Information on what is causing the message, and remedy measures, can be viewed via the  symbol on the display.

Timestamp

Navigation  Diagnostics → Timestamp

Description Shows the timestamp of the previous diagnostic message.

Operating time from restart

Navigation   Diagnostics → Operating time from restart

Description Displays the time the device has been in operation since the last device restart.

Operating time

Navigation   Diagnostics → Operating time

Description Indicates how long the device has been in operation.

Additional information *Maximum time*
9999 d (≈ 27 years)

17.5.1 "Diagnostic list" submenu

Navigation  Diagnostics → Diagnostic list

Diagnostics 1 to 5

Navigation

 Diagnostics → Diagnostic list → Diagnostics 1

Description

Display the current diagnostics messages with the highest to fifth-highest priority.

Additional information

The display consists of:

- Symbol for event behavior
- Code for diagnostic behavior
- Operating time of occurrence
- Event text

Timestamp 1 to 5

Navigation

 Diagnostics → Diagnostic list → Timestamp

Description



Timestamp of the diagnostic message.

17.5.2 "Event logbook" submenu

 The **Event logbook** submenu is only available when operating via the local display. When operating via FieldCare, the event list can be displayed in the FieldCare function "Event List / HistoROM".

Navigation  Diagnostics → Event logbook



Filter options



Navigation	 Diagnostics → Event logbook → Filter options
Description	Define which category of event messages is shown in the Events list submenu.
Selection	<ul style="list-style-type: none"> ▪ All ▪ Failure (F) ▪ Function check (C) ▪ Out of specification (S) ▪ Maintenance required (M) ▪ Information (I)
Factory setting	All
Additional information	 <ul style="list-style-type: none"> ▪ This parameter is only used for operation via the local display. ▪ The status signals are categorized according to NAMUR NE 107.

"Event list" submenu

The **Event list** submenu displays the history of past events of the category selected in the **Filter options** parameter (→  171). A maximum of 100 events are displayed in chronological order.

The following symbols indicate whether an event has occurred or has ended:

- : Event has occurred
- : Event has ended

 Information on what is causing the message, and remedy instructions, can be viewed via the -button.

Display format

- For event messages in category I: information event, event text, "recording event" symbol and time the event occurred
- For event messages in category F, M, C, S (status signal): diagnostics event, event text, "recording event" symbol and time the event occurred

Navigation  Diagnostics → Event logbook → Event list



17.5.3 "Device information" submenu

Navigation  Diagnostics → Device information



Device tag

Navigation	 Diagnostics → Device information → Device tag
Description	Enter the name for the measuring point.
Factory setting	FMR6x

Serial number

Navigation	 Diagnostics → Device information → Serial number
Description	Shows the serial number of the measuring device.
Additional information	<p> Uses of the serial number</p> <ul style="list-style-type: none"> ▪ To identify the device quickly, e.g. when contacting Endress+Hauser. ▪ To obtain specific information on the device using the Device Viewer: www.endress.com/deviceviewer <p> The serial number is also indicated on the nameplate.</p>

Firmware version

Navigation	 Diagnostics → Device information → Firmware version
Description	Shows the device firmware version installed.
User interface	xx.yy.zz
Additional information	 For firmware versions differing only in the last two digits ("zz") there is no difference concerning functionality or operation.

Device name

Navigation	 Diagnostics → Device information → Device name
Description	Shows the name of the transmitter.

Order code

**Navigation**

Diagnostics → Device information → Order code

Description

Shows the device order code.

Additional information

The order code is generated from the extended order code, which defines all device features of the product structure. In contrast, the device features can not be read directly from the order code.

Extended order code 1 to 3

**Navigation**

Diagnostics → Device information → Extended order code 1

Description

Display the three parts of the extended order code.

Additional information

The extended order code indicates the version of all the features of the product structure and thus uniquely identifies the device.

Device revision

Navigation

Diagnostics → Device information → Device revision

Description

Shows the device revision with which the device is registered with the HART Communication Foundation.

Additional information

The device revision is used to allocate the correct Device Description file (DD) to the device.

Device ID

Navigation

Diagnostics → Device information → Device ID

Description

Shows the device ID for identifying the device in a HART network.

Additional information

In addition to the Device type and Manufacturer ID, the Device ID is part of the unique device identification (Unique ID) which characterizes each HART device unambiguously.

Device type

Navigation	 Diagnostics → Device information → Device type
Description	Shows the device type with which the measuring device is registered with the HART Communication Foundation.
Additional information	The device type is needed to allocate the suitable Device Description (DD) to the device.



Manufacturer ID

Navigation	 Diagnostics → Device information → Manufacturer ID
Description	Use this function to view the manufacturer ID with which the measuring device is registered with the HART Communication Foundation.
User interface	2-digit hexadecimal number
Factory setting	0x11 (for Endress+Hauser)

17.5.4 "Measured values" submenu

Navigation   Diagnostics → Measured values

Distance

Navigation   Diagnostics → Measured values → Distance

Description Distance between lower edge of flange or thread and medium surface.

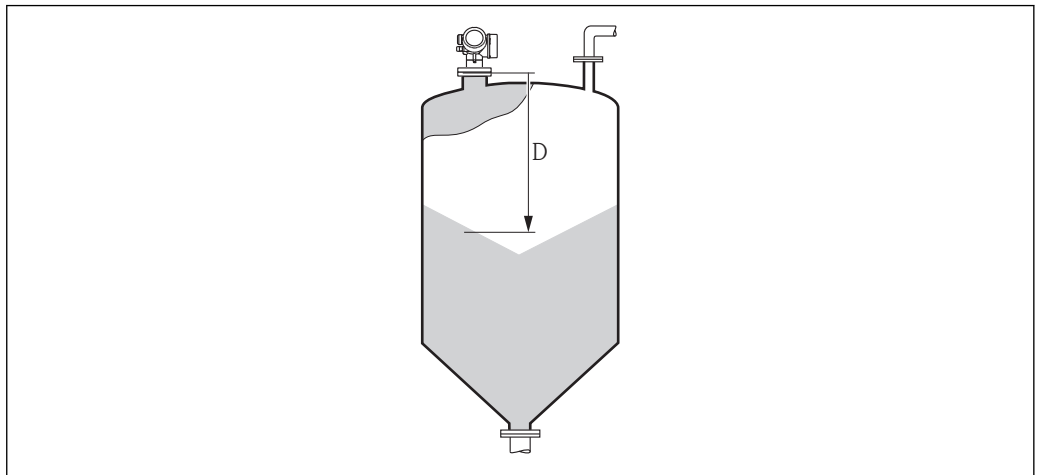

Additional information



 50 Distance for bulk solid measurements

A0019485

Level linearized

Navigation   Diagnostics → Measured values → Level linearized

Description Displays linearized level.

Additional information  The unit is defined by the **Unit after linearization** parameter →  135.

Output current 1 to 2

Navigation   Diagnostics → Measured values → Output current 1 to 2

Description Shows the actual calculated value of the output current.

Measured current 1

Navigation	 Diagnostics → Measured values → Measured current 1
Prerequisite	Only available for current output 1
Description	Shows the current value of the current output which is currently measured.

Terminal voltage 1

Navigation	 Diagnostics → Measured values → Terminal voltage 1
Description	Shows the current terminal voltage that is applied at the output.



Sensor temperature

Navigation	 Diagnostics → Measured values → Sensor temperature
Description	Indicates the current sensor temperature.

17.5.5 "Data logging" submenu

Navigation   Diagnostics → Data logging

Assign channel 1 to 4

Navigation   Diagnostics → Data logging → Assign channel 1 to 4

Description Assign a process variable to logging channel.

Selection

- Off
- Level linearized
- Distance
- Current output 1
- Measured current
- Current output 2 *
- Terminal voltage
- Electronic temperature
- Analog output adv. diagnostics 1
- Analog output adv. diagnostics 2
- Analog output adv. diagnostics 3
- Analog output adv. diagnostics 4

Factory setting Off

Additional information A total of 1000 measured values can be logged. This means:

- 1000 data points if 1 logging channel is used
- 500 data points if 2 logging channels are used
- 333 data points if 3 logging channels are used
- 250 data points if 4 logging channels are used

If the maximum number of data points is reached, the oldest data points in the data log are cyclically overwritten in such a way that the last 1000, 500, 333 or 250 measured values are always in the log (ring memory principle).

 The logged data are deleted if a new option is selected in this parameter.

Logging interval

Navigation  Diagnostics → Data logging → Logging interval

 Diagnostics → Data logging → Logging interval

Description Define the logging interval tlog for data logging. This value defines the time interval between the individual data points in the memory.

User entry 1.0 to 3 600.0 s

Factory setting 30.0 s

* Visibility depends on order options or device settings

Additional information

This parameter defines the interval between the individual data points in the data log, and thus the maximum loggable process time T_{\log} :

- If 1 logging channel is used: $T_{\log} = 1000 \cdot t_{\log}$
- If 2 logging channels are used: $T_{\log} = 500 \cdot t_{\log}$
- If 3 logging channels are used: $T_{\log} = 333 \cdot t_{\log}$
- If 4 logging channels are used: $T_{\log} = 250 \cdot t_{\log}$

Once this time elapses, the oldest data points in the data log are cyclically overwritten such that a time of T_{\log} always remains in the memory (ring memory principle).



The logged data are deleted if this parameter is changed.

*Example***When using 1 logging channel**

- $T_{\log} = 1000 \cdot 1 \text{ s} = 1000 \text{ s} \approx 16.5 \text{ min}$
- $T_{\log} = 1000 \cdot 10 \text{ s} = 10000 \text{ s} \approx 2.75 \text{ h}$
- $T_{\log} = 1000 \cdot 80 \text{ s} = 80000 \text{ s} \approx 22 \text{ h}$
- $T_{\log} = 1000 \cdot 3600 \text{ s} = 3600000 \text{ s} \approx 41 \text{ d}$

Clear logging data**Navigation**

- Diagnostics → Data logging → Clear logging data
- Diagnostics → Data logging → Clear logging data

Description

Clear the entire logging data.

Selection

- Cancel
- Clear data

Factory setting

Cancel

"Display channel 1 to 4" submenu

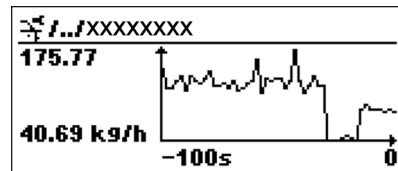

i The **Display channel 1 to 4** submenus are only available for operation via the local display. When operating via FieldCare, the logging diagram can be displayed in the FieldCare function "Event List / HistoROM" .

The **Display channel 1 to 4** submenus invoke a diagram of the logging history of the respective channel.



- x-axis: depending on the number of selected channels, 250 to 1000 measured values of a process variable are displayed.
- y-axis: covers the approximate measured value span and constantly adapts this to the measurement.







i To return to the operating menu, press \oplus and \ominus simultaneously.

Navigation   Diagnostics → Data logging → Display channel 1 to 4

17.5.6 "Simulation" submenu







The **Simulation** submenu is used to simulate specific measuring values or other conditions. This helps to check the correct configuration of the device and connected control units.

Conditions which can be simulated

Condition to be simulated	Associated parameters
Specific value of a process variable	<ul style="list-style-type: none"> ▪ Assign measurement variable (→  182) ▪ Process variable value (→  182)
Specific value of the output current	<ul style="list-style-type: none"> ▪ Current output simulation (→  182) ▪ Value current output (→  183)
Specific state of the switch output	<ul style="list-style-type: none"> ▪ Switch output simulation (→  183) ▪ Switch status (→  183)
Existence of an alarm	Device alarm simulation (→  184)

Structure of the submenu



Navigation  Diagnostics → Simulation

► Simulation	
Assign measurement variable	→  182
Process variable value	→  182
Current output 1 to 2 simulation	→  182
Value current output 1 to 2	→  183
Switch output simulation	→  183
Switch status	→  183
Device alarm simulation	→  184



Description of parameters

Navigation  Diagnostics → Simulation

Assign measurement variable

Navigation	 Diagnostics → Simulation → Assign measurement variable
Selection	<ul style="list-style-type: none"> ■ Off ■ Level ■ Level linearized
Factory setting	Off
Additional information	<ul style="list-style-type: none"> ■ The value of the variable to be simulated is defined in the Process variable value parameter (→  182). ■ If Assign measurement variable ≠ Off, a simulation is active. This is indicated by a diagnostic message of the <i>Function check (C)</i> category.

Process variable value

Navigation	 Diagnostics → Simulation → Process variable value
Prerequisite	Assign measurement variable (→  182) ≠ Off
User entry	Signed floating-point number
Factory setting	0
Additional information	Downstream measured value processing and the signal output use this simulation value. In this way, users can verify whether the measuring device has been configured correctly.

Current output 1 to 2 simulation

Navigation	 Diagnostics → Simulation → Current output 1 to 2 simulation
Description	Switch the simulation of the current output on and off.
Selection	<ul style="list-style-type: none"> ■ Off ■ On
Factory setting	Off
Additional information	An active simulation is indicated by a diagnostic message of the <i>Function check (C)</i> category.

Value current output 1 to 2





Navigation	Diagnostics → Simulation → Value current output 1 to 2
Prerequisite	Current output simulation (→ 182) = On
Description	Defines the value of the simulated output current.
User entry	3.59 to 22.5 mA
Factory setting	3.59 mA
Additional information	The current output assumes the value specified in this parameter. In this way, users can verify the correct adjustment of the current output and the correct function of connected control units.





Switch output simulation





Navigation	Diagnostics → Simulation → Switch output simulation
Description	Switch the simulation of the switch output on and off.
Selection	<ul style="list-style-type: none"> ■ Off ■ On
Factory setting	Off

Switch status

Navigation	Diagnostics → Simulation → Switch status
Prerequisite	Switch output simulation (→ 183) = On
Description	Current status of the switch output.
Selection	<ul style="list-style-type: none"> ■ Open ■ Closed
Factory setting	Open
Additional information	The switch status assumes the value defined in this parameter. This helps to check correct operation of connected control units.

Device alarm simulation		
Navigation	  Diagnostics → Simulation → Device alarm simulation	
Description	Switch the device alarm on and off.	
Selection	<ul style="list-style-type: none"> ■ Off ■ On 	
Factory setting	Off	
Additional information	<p>When selecting the On option, the device generates an alarm. This helps to check the correct output behavior of the device in the case of an alarm.</p> <p>An active simulation is indicated by the diagnostic message  C484 Failure mode simulation.</p>	



Diagnostic event category		
Navigation	 Diagnostics → Simulation → Diagnostic event category	
Description	Select event category for the simulation.	
Selection	<ul style="list-style-type: none"> ■ Sensor ■ Electronics ■ Configuration ■ Process 	
Factory setting	Process	
Additional information	<p>Only events of the selected category are available in the selection list of the Diagnostic event simulation parameter (→  184).</p> <p> When operated via tool, all diagnostic messages are always available in Diagnostic event simulation. Therefore, Diagnostic event category appears only on the local display.</p>	

Diagnostic event simulation		
Navigation	  Diagnostics → Simulation → Diagnostic event simulation	
Description	Select the diagnostic event to be simulated. Note: To terminate the simulation, select 'Off'.	
Factory setting	Off	
Additional information	When operated via the local display, the selection list can be filtered according to the event categories (Diagnostic event category parameter (→  184)).	



17.5.7 "Device check" submenu

Navigation   Diagnostics → Device check



Start device check

Navigation	  Diagnostics → Device check → Start device check
Description	Yes starts a device check.
Selection	<ul style="list-style-type: none"> ▪ No ▪ Yes
Factory setting	No
Additional information	<ul style="list-style-type: none"> ▪ In case of an echo loss a device check cannot be performed. ▪ The minimum distance to the medium is 1.5 m (5 ft).

Result device check

Navigation   Diagnostics → Device check → Result device check

Last check time

Navigation	  Diagnostics → Device check → Last check time
Description	Indicates the operating time at which the last device check has been performed.

17.5.8 "Heartbeat" submenu

 The **Heartbeat** submenu is only available via **FieldCare** or **DeviceCare**. It contains the wizards which are part of the **Heartbeat Verification** and **Heartbeat Monitoring** application packages.

Detailed description

SD01870F

Navigation

 Diagnostics → Heartbeat

Index

A

Access authorization to parameters	
Read access	47
Write access	47
Access code	47
Incorrect input	47
Access status display (Parameter)	125
Access status tooling (Parameter)	124
Accessories	
Communication specific	95
Device-specific	88
Service specific	96
Activate table (Parameter)	140
Actual diagnostics (Parameter)	168
Administration (Submenu)	165
Advanced setup (Submenu)	124
Application	10
Assign channel 1 to 4 (Parameter)	177
Assign current output (Parameter)	146
Assign diagnostic behavior (Parameter)	151
Assign limit (Parameter)	151
Assign measurement variable (Parameter)	182
Assign status (Parameter)	151

B

Backlight (Parameter)	161
Backup state (Parameter)	163
Bin type (Parameter)	115
Blocking distance (Parameter)	129, 142
Bluetooth® wireless technology	43

C

CE mark	11
Cleaning	85
Clear logging data (Parameter)	178
Code incorrect (Parameter)	145
Comparison result (Parameter)	163
Configuration backup display (Submenu)	162
Configuration management (Parameter)	162
Configuration of a level measurement	67
Confirm access code (Parameter)	167
Confirm distance (Parameter)	119, 122
Context menu	58
Contrast display (Parameter)	161
Current output 1 to 2 (Submenu)	146
Current output 1 to 2 simulation (Parameter)	182
Current span (Parameter)	147
Customer value (Parameter)	140

D

Damping output (Parameter)	148
Data logging (Submenu)	177
DD	60
Deactivate SIL/WHG (Wizard)	145
Decimal places 1 (Parameter)	158
Decimal places menu (Parameter)	160

Declaration of Conformity	11
Define access code	47
Define access code (Parameter)	165, 167
Define access code (Wizard)	167
Designated use	10
Device alarm simulation (Parameter)	184
Device check (Submenu)	185
Device Descriptions	60
Device ID (Parameter)	173
Device information (Submenu)	172
Device name (Parameter)	172
Device replacement	86
Device reset (Parameter)	165
Device revision (Parameter)	173
Device tag (Parameter)	115, 172
Device type (Parameter)	174
Diagnostic event	
In the operating tool	79
Diagnostic event category (Parameter)	184
Diagnostic event simulation (Parameter)	184
Diagnostic events	76
Diagnostic list	80
Diagnostic list (Submenu)	170
Diagnostic message	76
Diagnostics	
Symbols	76
Diagnostics (Menu)	168
Diagnostics 1 (Parameter)	170
Diagnostics event	77
Diameter (Parameter)	137
DIP switch	
see Write protection switch	
Display (Submenu)	156
Display and operating module FHX50	42
Display channel 1 to 4 (Submenu)	179
Display damping (Parameter)	159
Display interval (Parameter)	158
Display module	52
Display symbols for submenus	53
Display symbols for the locking state	53
Disposal	87
Distance (Parameter)	119, 122, 175
Distance unit (Parameter)	115
Document	
Function	5
Document function	5

E

Electronics housing	
Design	15
Empty calibration (Parameter)	117
Enter access code (Parameter)	125
Envelope curve display	59
Event history	82
Event level	
Explanation	76

Symbols	76
Event list (Submenu)	171
Event logbook (Submenu)	171
Event text	77
Events list	82
Extended order code 1 (Parameter)	173
Exterior cleaning	85

F

Failure current (Parameter)	149
Failure mode (Parameter)	148, 154
FHX50	42
Field of application	
Residual risks	10
Filter options (Parameter)	171
Filtering the event logbook	83
Firmware version (Parameter)	172
Fixed current (Parameter)	147
Format display (Parameter)	156
Free text (Parameter)	136
Full calibration (Parameter)	118
FV (HART device variable)	60

H

Hardware write protection	48
HART device variables	60
HART integration	60
HART protocol	44
Header (Parameter)	159
Header text (Parameter)	160
Heartbeat (Submenu)	186
Housing	
Design	15
Turning	29

I

Input mask	56
Intermediate height (Parameter)	137
Invert output signal (Parameter)	154

K

Keypad lock	
Disabling	51
Switching on	51

L

Language (Parameter)	156
Last backup (Parameter)	162
Last check time (Parameter)	185
Level (Parameter)	119, 139, 140
Level (Submenu)	126
Level correction (Parameter)	129
Level linearized (Parameter)	136, 175
Level measurement configuration	67
Level unit (Parameter)	128
Linearization (Submenu)	132, 133, 134
Linearization type (Parameter)	134
Local display	41
see Diagnostics message	
see In alarm condition	

Locking status (Parameter)	124
Logging interval (Parameter)	177

M

Maintenance	85
Manage device configuration	71
Manufacturer ID (Parameter)	174
Mapping (Wizard)	122
Mapping end point (Parameter)	121, 122
Max. draining speed liquid (Parameter)	127
Max. draining speed solid (Parameter)	116
Max. filling speed liquid (Parameter)	127
Max. filling speed solid (Parameter)	116
Maximum value (Parameter)	137
Measured current 1 (Parameter)	176
Measured value symbols	54
Measured values (Submenu)	175
Media	10
Medium property (Parameter)	126
Medium type (Parameter)	126
Menu	
Diagnostics	168
Setup	115

N

Number format (Parameter)	160
---------------------------	-----

O

Operating elements	
Diagnostics message	77
Operating module	52
Operating time (Parameter)	162, 169
Operating time from restart (Parameter)	169
Operational safety	11
Order code (Parameter)	173
Output current 1 to 2 (Parameter)	149, 175
Output echo lost (Parameter)	141
Overvoltage protection	
General information	37

P

Prepare recording map (Parameter)	122
Present mapping (Parameter)	121
Previous diagnostics (Parameter)	168
Process variable value (Parameter)	182
Product safety	11
PV (HART device variable)	60

R

Ramp at echo lost (Parameter)	142
Read access	47
Record map (Parameter)	121, 122
Registered trademarks	9
Remedial measures	
Calling up	78
Closing	78
Remote operation	44
Repair concept	86
Replacing a device	86
Requirements for personnel	10

- Reset write protection (Parameter) 145
- Result device check (Parameter) 185
- Return 87
- S**
- Safety instructions
 - Basic 10
- Safety Instructions (XA) 12
- Safety settings (Submenu) 141
- Sensor temperature (Parameter) 176
- Separator (Parameter) 160
- Serial number (Parameter) 172
- Service interface (CDI) 44
- Setting the operating language 66
- Settings
 - Manage device configuration 71
 - Operating language 66
- Setup (Menu) 115
- Signal quality (Parameter) 119
- SIL/WHG confirmation (Wizard) 144
- Simulation (Submenu) 181, 182
- Spare parts 87
 - Nameplate 87
- Start device check (Parameter) 185
- Status signals 53, 76
- Störungsbehebung 73
- Submenu
 - Administration 165
 - Advanced setup 124
 - Configuration backup display 162
 - Current output 1 to 2 146
 - Data logging 177
 - Device check 185
 - Device information 172
 - Diagnostic list 170
 - Display 156
 - Display channel 1 to 4 179
 - Event list 171
 - Event logbook 171
 - Events list 82
 - Heartbeat 186
 - Level 126
 - Linearization 132, 133, 134
 - Measured values 175
 - Safety settings 141
 - Simulation 181, 182
 - Switch output 150
- SV (HART device variable) 60
- Switch output (Submenu) 150
- Switch output function (Parameter) 150
- Switch output simulation (Parameter) 183
- Switch status (Parameter) 154, 183
- Switch-off delay (Parameter) 154
- Switch-off value (Parameter) 153
- Switch-on delay (Parameter) 153
- Switch-on value (Parameter) 152
- Symbols
 - For correction 56
 - In the text and numeric editor 56
- System components 97
- T**
- Table mode (Parameter) 138
- Table number (Parameter) 139
- Tank/silo height (Parameter) 129
- Terminal voltage 1 (Parameter) 176
- Timestamp (Parameter) 168, 169, 170
- Transmitter
 - Turning the display 29
 - Turning the display module 30
- Transmitter housing
 - Turning 29
- Turning the display 29
- Turning the display module 30
- TV (HART device variable) 60
- U**
- Unit after linearization (Parameter) 135
- Use of the measuring device
 - see Designated use
- Use of the measuring devices
 - Borderline cases 10
 - Incorrect use 10
- V**
- Value 1 display (Parameter) 158
- Value current output 1 to 2 (Parameter) 183
- Value echo lost (Parameter) 141
- W**
- W@M Device Viewer 87
- Wizard
 - Deactivate SIL/WHG 145
 - Define access code 167
 - Mapping 122
 - SIL/WHG confirmation 144
- Workplace safety 11
- Write access 47
- Write protection
 - Via access code 47
 - Via write protection switch 48
- Write protection switch 48



www.addresses.endress.com
