

Operating Instructions

Liquiphant FTL33

Point level switch for liquids in the food sector

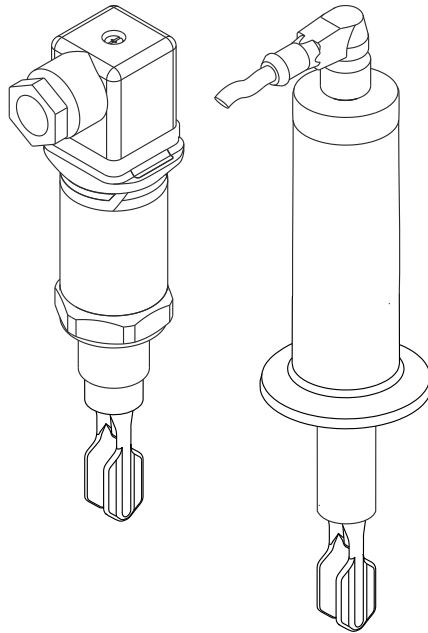

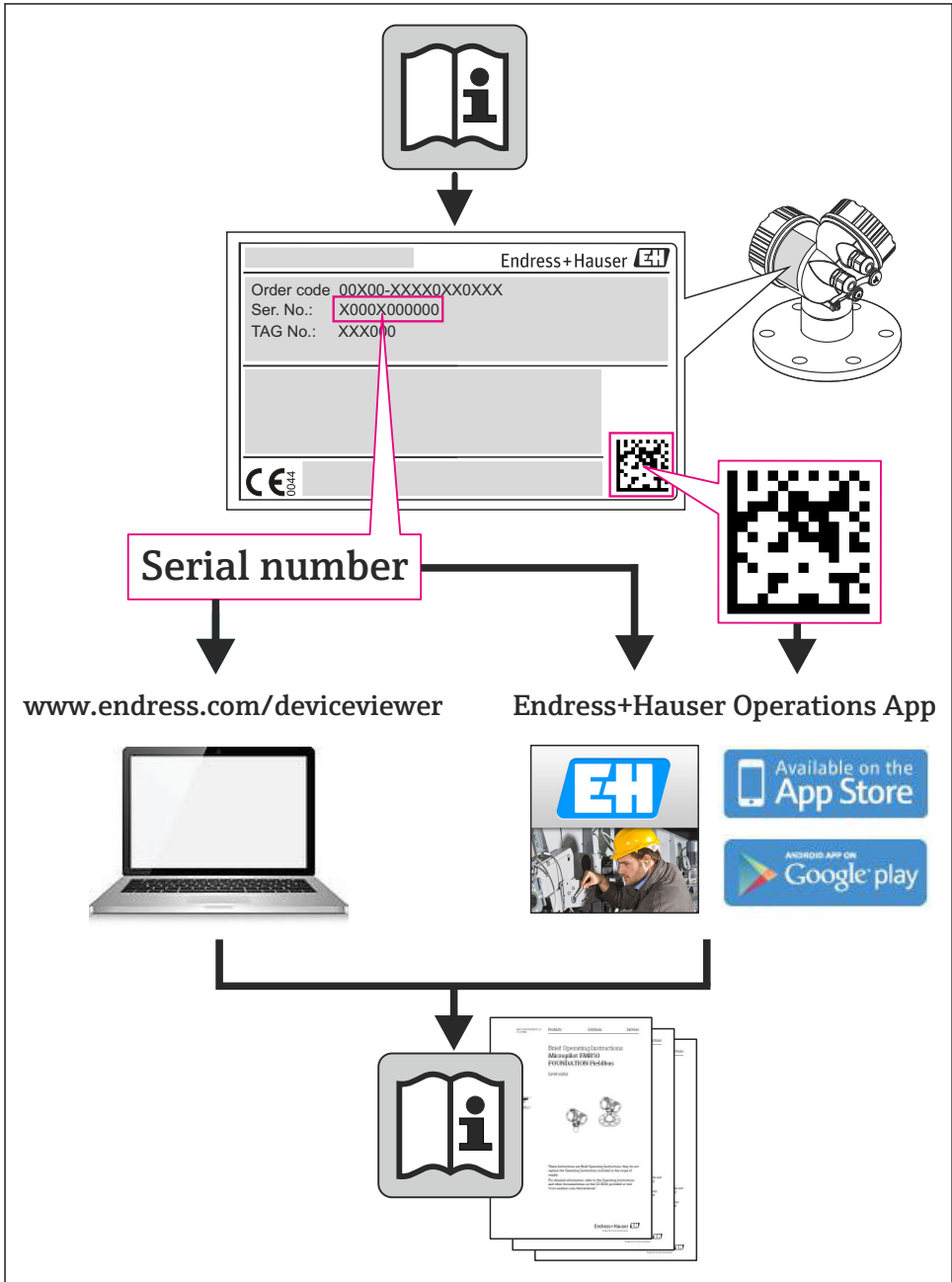

Liquiphant FTL33

Point level switch for liquids in the food sector

Betriebsanleitung	5
Operating Instructions	37

Inhaltsverzeichnis

1	Hinweise zum Dokument	6	10.2	Rücksendung	33
1.1	Dokumentfunktion	6	10.3	Entsorgung	33
1.2	Symbole	6			
1.3	Dokumentation	7	11	Zubehör	33
2	Grundlegende		12	Technische Daten	34
	Sicherheitshinweise	8	12.1	Energieversorgung	34
2.1	Anforderungen an das Personal	8	12.2	Umgebung	34
2.2	Bestimmungsgemäße Verwendung	8	12.3	Prozess	36
2.3	Arbeitssicherheit	8			
2.4	Betriebssicherheit	9			
2.5	Produktsicherheit	9			
3	Produktbeschreibung	10			
3.1	Produktaufbau	10			
4	Warenannahme und				
	Produktidentifizierung	11			
4.1	Warenannahme	11			
4.2	Produktidentifizierung	12			
4.3	Lagerung und Transport	12			
5	Montage	14			
5.1	Montagebedingungen	14			
5.2	Messgerät montieren	20			
5.3	Montagekontrolle	22			
6	Elektrischer Anschluss	23			
6.1	Gerät anschließen	23			
6.2	Anschlusskontrolle	28			
7	Inbetriebnahme	29			
7.1	Installations- und Funktionskontrolle ..	29			
7.2	LED-Anzeige	29			
7.3	Funktionstest mit Testmagnet	31			
8	Diagnose und				
	Störungsbehebung	32			
8.1	Diagnoseinformation via LED- Anzeige	32			
9	Wartung	32			
9.1	Reinigung	32			
10	Reparatur	33			
10.1	Ersatzteile	33			

1 Hinweise zum Dokument

1.1 Dokumentfunktion



Diese Anleitung liefert alle Informationen, die in den verschiedenen Phasen des Lebenszyklus des Geräts benötigt werden: Von der Produktidentifizierung, Warenannahme und Lagerung über Montage, Anschluss, Bedienungsgrundlagen und Inbetriebnahme bis hin zur Störungsbeseitigung, Wartung und Entsorgung.

1.2 Symbole





1.2.1 Sicherheitshinweise

Symbol	Bedeutung
 <small>A0011189-DE</small>	GEFAHR! Dieser Hinweis macht auf eine gefährliche Situation aufmerksam, die, wenn sie nicht vermieden wird, zu Tod oder schwerer Körperverletzung führen wird.
 <small>A0011190-DE</small>	WARNUNG! Dieser Hinweis macht auf eine gefährliche Situation aufmerksam, die, wenn sie nicht vermieden wird, zu Tod oder schwerer Körperverletzung führen kann.
 <small>A0011191-DE</small>	VORSICHT! Dieser Hinweis macht auf eine gefährliche Situation aufmerksam, die, wenn sie nicht vermieden wird, zu leichter oder mittelschwerer Körperverletzung führen kann.
 <small>A0011192-DE</small>	HINWEIS! Dieser Hinweis enthält Informationen zu Vorgehensweisen und weiterführenden Sachverhalten, die keine Körperverletzung nach sich ziehen.

1.2.2 Elektrische Symbole

Symbol	Bedeutung
 <small>A0011200</small>	Erdanschluss Eine geerdete Klemme, die vom Gesichtspunkt des Benutzers über ein Erdungssystem geerdet ist.
 <small>A0011199</small>	Schutzleiteranschluss Eine Klemme, die geerdet werden muss, bevor andere Anschlüsse hergestellt werden dürfen.

1.2.3 Symbole für Informationstypen

Symbol	Bedeutung
 A0011182	Erlaubt Kennzeichnet Abläufe, Prozesse oder Handlungen, die erlaubt sind.
 A0011184	Verboten Kennzeichnet Abläufe, Prozesse oder Handlungen, die verboten sind.
 A0011193	Tipp Kennzeichnet zusätzliche Informationen.
 A0011194	Verweis auf Dokumentation Verweist auf die entsprechende Dokumentation zum Gerät.
 A0011195	Verweis auf Seite Verweist auf die entsprechende Seitenzahl.

1.2.4 Symbole für Grafiken

Symbol	Bedeutung
1, 2, 3 ...	Positionsnummern
A, B, C, ...	Ansichten

1.2.5 Symbole für Werkzeuge

Symbol	Bedeutung
 A0011222	Gabelschlüssel

1.3 Dokumentation

Die aufgelisteten Dokumenttypen sind verfügbar im Download-Bereich der Endress+Hauser Internetseite: www.endress.com → [Download](#)

Dokument	Zweck und Inhalt des Dokuments
Technische Information TI01148F/00/DE	Das Dokument liefert alle technischen Daten zum Gerät und enthält einen Überblick, welches Zubehör bestellt werden kann.
Zusatzdokumentationen TI00426F/00/DE SD00352F/00/A6 SD00356F/00/EN BA00361F/00/A6	Einschweißadapter und Flansche (Übersicht) Einschweißadapter G 1", G ¾" (Montageanleitung) Ventilstecker (Montageanleitung) Einschweißadapter M24 (Montageanleitung)

2 Grundlegende Sicherheitshinweise

2.1 Anforderungen an das Personal

Das Personal für Installation, Inbetriebnahme, Diagnose und Wartung muss folgende Bedingungen erfüllen:

- Ausgebildetes Fachpersonal: Verfügt über Qualifikation, die dieser Funktion und Tätigkeit entspricht
- Vom Anlagenbetreiber autorisiert
- Mit den nationalen Vorschriften vertraut
- Vor Arbeitsbeginn: Anweisungen in Anleitung und Zusatzdokumentation sowie Zertifikate (je nach Anwendung) lesen und verstehen
- Anweisungen und Rahmenbedingungen befolgen

Das Bedienpersonal muss folgende Bedingungen erfüllen:

- Entsprechend den Aufgabenanforderungen vom Anlagenbetreiber eingewiesen und autorisiert
- Anweisungen in dieser Anleitung befolgen

2.2 Bestimmungsgemäße Verwendung

Das in dieser Anleitung beschriebene Messgerät darf nur als Füllstandgrenzschalter für Flüssigkeiten verwendet werden. Bei unsachgemäßem Einsatz können Gefahren von ihm ausgehen. Um den einwandfreien Zustand des Messgerätes für die Betriebszeit zu gewährleisten,

- dürfen Messgeräte nur für Messstoffe eingesetzt werden, gegen die die prozessberührenden Materialien hinreichend beständig sind.
- müssen Grenzwerte in "Technische Daten" eingehalten werden.

2.2.1 Fehlgebrauch

Der Hersteller haftet nicht für Schäden, die aus unsachgemäßer oder nicht bestimmungsgemäßer Verwendung entstehen.

Restrisiken

Das Elektronikgehäuse und die darin eingebauten Baugruppen können sich im Betrieb durch Wärmeeintrag aus dem Prozess bis zu 80 °C (176 °F) erwärmen.

Mögliche Verbrennungsgefahr bei Berührung von Oberflächen!

- ▶ Bei erhöhter Messstofftemperatur: Berührungsschutz sicherstellen, um Verbrennungen zu vermeiden.

2.3 Arbeitssicherheit

Bei Arbeiten am und mit dem Gerät:

- ▶ Erforderliche persönliche Schutzausrüstung gemäß nationaler Vorschriften tragen.
- ▶ Versorgungsspannung ausschalten, bevor Sie das Gerät anschließen.

2.4 Betriebssicherheit

Verletzungsgefahr!

- ▶ Das Gerät nur in technisch einwandfreiem und betriebssicherem Zustand betreiben.
- ▶ Der Betreiber ist für den störungsfreien Betrieb des Geräts verantwortlich.

2.5 Produktsicherheit

Dieses Messgerät ist nach dem Stand der Technik und guter Ingenieurspraxis betriebssicher gebaut und geprüft und hat das Werk in sicherheitstechnisch einwandfreiem Zustand verlassen. Es erfüllt die allgemeinen Sicherheitsanforderungen und gesetzlichen Anforderungen. Zudem ist es konform zu den EG-Richtlinien, die in der gerätespezifischen EG-Konformitätserklärung aufgelistet sind. Mit der Anbringung des CE-Zeichens bestätigt Endress+Hauser diesen Sachverhalt.

3 Produktbeschreibung

Der Liquiphant FTL33 ist ein Grenzschalter und universell in allen Flüssigkeiten einsetzbar. Er kommt vorzugsweise in Lagertanks, Rührwerksbehältern und Rohrleitungen zum Einsatz, bei denen innen und außen besonders hohe Anforderungen an die Hygiene gestellt werden.

3.1 Produktaufbau

Den Grenzschalter gibt es in verschiedenen Varianten, die anwenderspezifisch zusammengestellt werden können. Beispiele sehen Sie in der folgenden Abbildung:

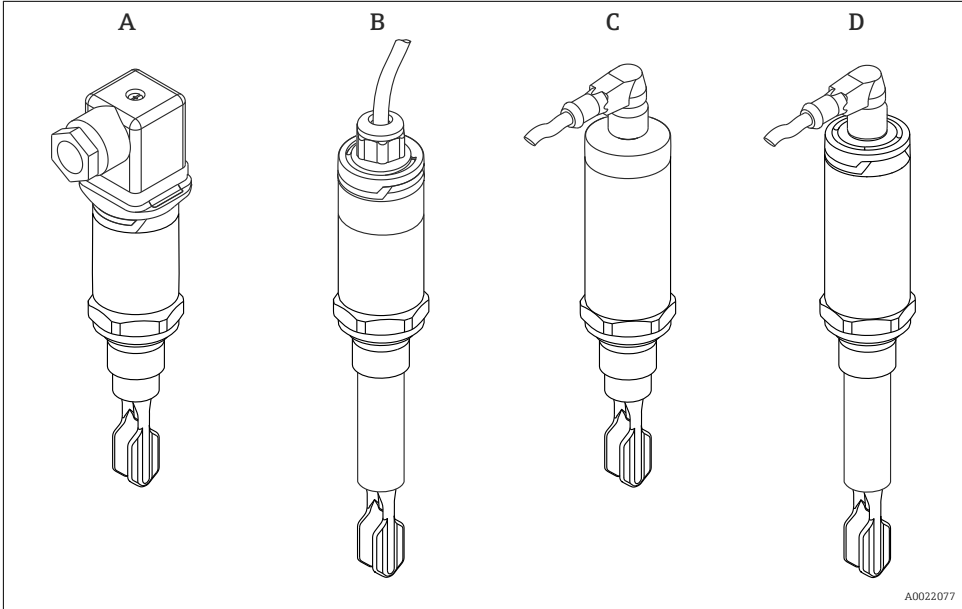

A0022077

Varianten	Beispiele			
	A	B	C	D
Elektrischer Anschluss	Ventilstecker	Kabel (nicht demontierbar)	Stecker M12 für Gehäusekappe IP66/68/69K	Stecker M12 für Gehäusekappe IP65/67
Gehäuse (Sensordesign) für Prozesstemperaturen bis:	100 °C (212 °F)	100 °C (212 °F)	150 °C (302 °F)	150 °C (302 °F)
Sensortyp	Kompaktversion	Kurzrohrversion	Kompaktversion	Kurzrohrversion

 Detaillierte Informationen zur Kurzrohrversion und zu den Prozessanschlüssen finden Sie in der Technischen Dokumentation TI01148F/00/DE.

4 Warenannahme und Produktidentifizierung

4.1 Warenannahme



A0015502

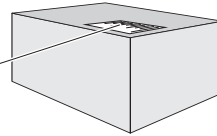

1 = 2

A0016051

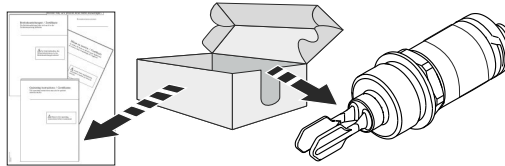

A0021096

Bestellcode auf Lieferschein (1) mit Bestellcode auf Produktaufkleber (2) identisch?



A0015502

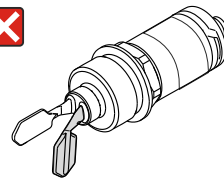
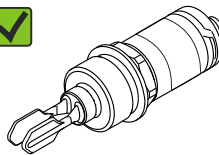

A0021097

Ware unbeschädigt?



A0015502

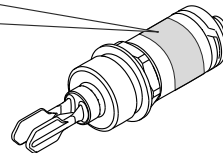

A0021098

Entsprechen die Daten auf den Typenschildern den Bestellangaben auf dem Lieferschein?



Wenn eine dieser Bedingungen nicht zutrifft, wenden Sie sich bitte an Ihre Endress+Hauser-Vertriebsstelle.

4.2 Produktidentifizierung

Folgende Möglichkeiten stehen zur Identifizierung des Messgerätes zur Verfügung:

- Typenschildangabe
- Bestellcode (Order code) mit Aufschlüsselung der Gerätemerkmale auf dem Lieferschein
- Seriennummer von Typenschildern in *W@M Device Viewer* eingeben
(www.endress.com/deviceviewer): Alle Angaben zum Messgerät werden angezeigt

Eine Übersicht zum Umfang der mitgelieferten Technischen Dokumentation erhalten Sie ebenfalls über die Seriennummer auf dem Typenschild in *W@M Device Viewer* (www.endress.com/deviceviewer)

4.2.1 Typenschild

The diagram shows a nameplate with the following fields and symbols:

- 1: Endress+Hauser logo
- 2: Blank field
- Order code: 3
- Ser. no.: 4
- Ext. ord. cd.: 6
- 5: Test magnet symbol (circle with crosshair)
- U: 7
- I max.: 8
- 9: Blank field
- 10: Blank field
- 11: Certification symbols (CE, S, N12895, A 74-06)
- 12: Blank field
- 13: Blank field
- TAG: 14
- 17: Warning symbol (triangle with exclamation mark)
- BAxxxxF
- Date: 15
- 16: QR code

A0021109

- 1: Gerätename
- 2: Herstelleradresse
- 3: Bestellcode
- 4: Seriennummer
- 5: Markierung für Testmagnet
- 6: Erweiterter Bestellcode
- 7: Betriebsspannung
- 8: Signalausgang
- 9: Prozess- und Umgebungstemperatur
- 10: Prozessdruck
- 11: Zertifikatssymbole (optional)
- 12: Schutzart: z.B. IP, NEMA
- 13: Zertifikats- und zulassungsspezifische Daten
- 14: Messstellenkennzeichnung (optional)
- 15: Herstellungsdatum (Jahr, Monat)
- 16: Data Matrix Code
- 17: Dokumentnummer der Betriebsanleitung

 Der Testmagnet ist als Zubehör bestellbar →  33.

4.3 Lagerung und Transport

4.3.1 Lagerungsbedingungen

- Zulässige Lagerungstemperatur: $-40...+85\text{ °C}$ ($-40...+185\text{ °F}$)
- Originalverpackung verwenden.

4.3.2 Handhabung des Gerätes

HINWEIS

Verletzungsgefahr! Gehäuse oder Schwinggabel kann beschädigt werden oder abreißen!

- ▶ Gerät in Originalverpackung oder am Gehäuse zur Messstelle transportieren.
- ▶ Das Gerät nicht an der Schwinggabel halten!
- ▶ Gerät nicht als Steighilfe verwenden!
- ▶ Schwinggabel nicht verbiegen!
- ▶ Schwinggabel nicht kürzen oder verlängern!

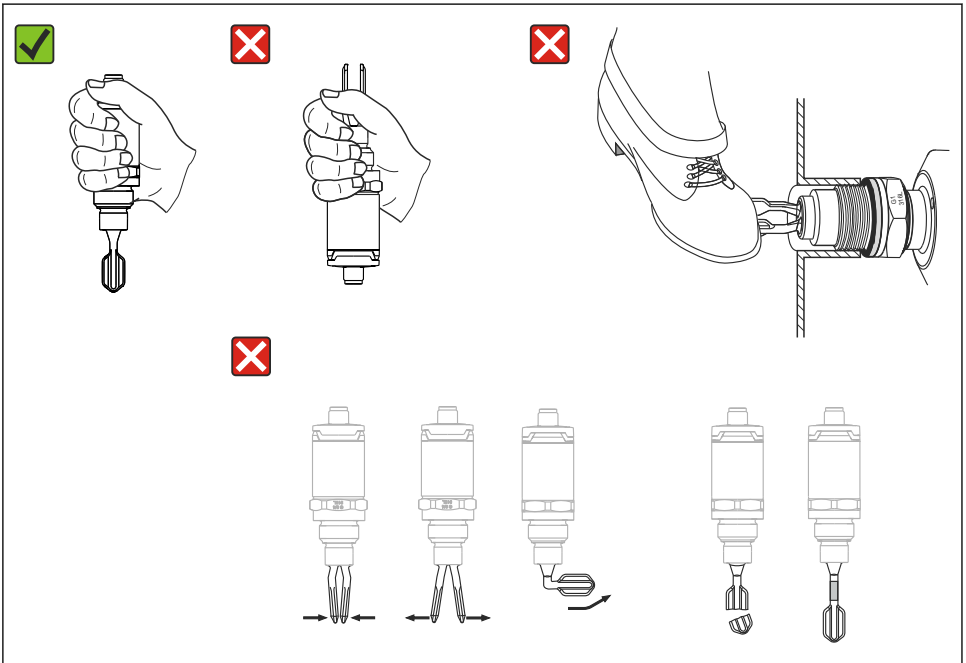

A0020845

1 Handhabung des Gerätes

5 Montage

5.1 Montagebedingungen

5.1.1 Einbaulage

Der Grenzschalter kann in jeder beliebigen Lage in einem Behälter, Rohr oder Tank eingebaut werden.

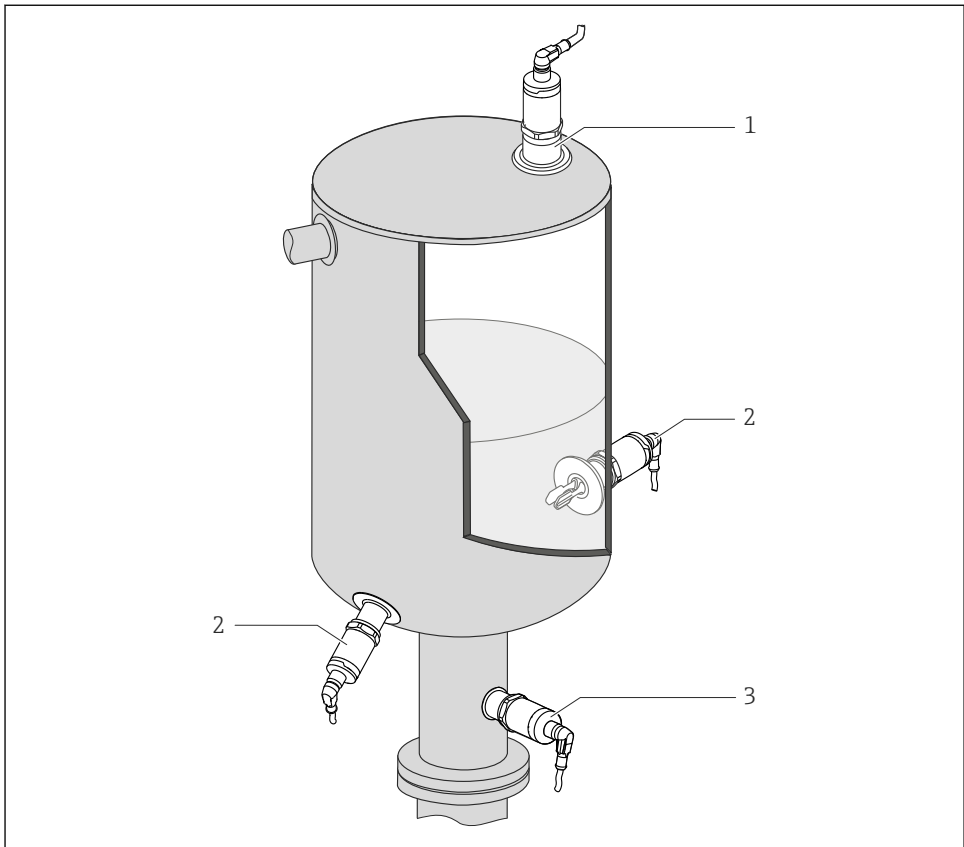

A0023118

2 Einbaumöglichkeiten

- 1 Überfüllsicherung oder obere Füllstanddetektion
- 2 Untere Füllstanddetektion
- 3 Trockenlaufschutz für Pumpe

5.1.2 Schaltpunkt

Der Schaltpunkt (A) am Sensor ist abhängig von der Einbaulage des Grenzschalters (Wasser +25 °C (+77 °F), 1 bar (14,5 psi)).

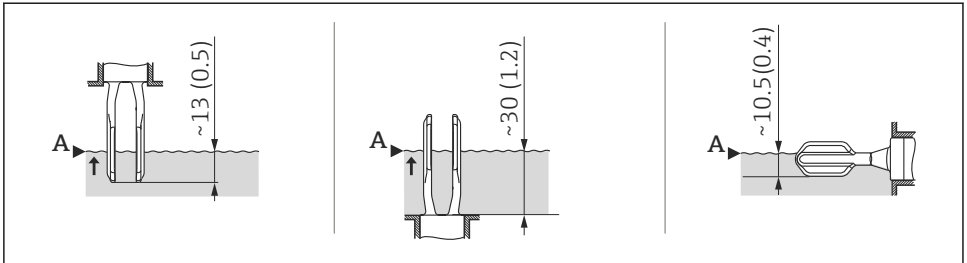

A0020734

3 Vertikale und horizontale Einbaulage, Maßangabe mm (in)

5.1.3 Viskosität

Bei Flüssigkeiten hoher Viskosität kann es zu Schaltverzögerungen kommen. Stellen Sie sicher, dass die Flüssigkeit gut von der Schwinggabel abfließen kann:

- Bei horizontalem Einbau in Behältern mit Flüssigkeiten hoher Viskosität (A), darf sich die Schwinggabel **nicht** im Einbaustutzen befinden!
- Bei horizontalem Einbau in Behältern mit Flüssigkeiten geringer Viskosität (B), darf sich die Schwinggabel im Einbaustutzen befinden.
- Der Einbaustutzen darf den Mindestdurchmesser von 50 mm (2,0 in) nicht unterschreiten.

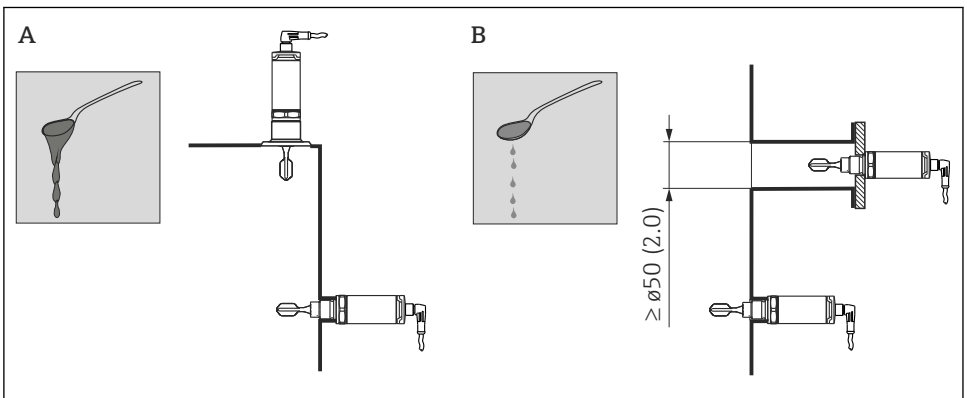

A0022054

4 Einbaumöglichkeiten unter Berücksichtigung der Viskosität, Maßangabe mm (in)

A Hohe Viskosität (< 10 000 mPa·s)

B Geringe Viskosität (< 2 000 mPa·s)

5.1.4 Ansatz

Achten Sie darauf, dass der Einbaustutzen eine bestimmte Länge nicht überschreitet, damit die Schwinggabel frei in den Behälter ragen kann.

Optimierungsmöglichkeiten:

- Eine vertikale Einbaulage des Grenzschalters hält Ablagerungen gering.
- Vorzugsweise frontbündiger Einbau an Behältern oder in Rohrleitungen.

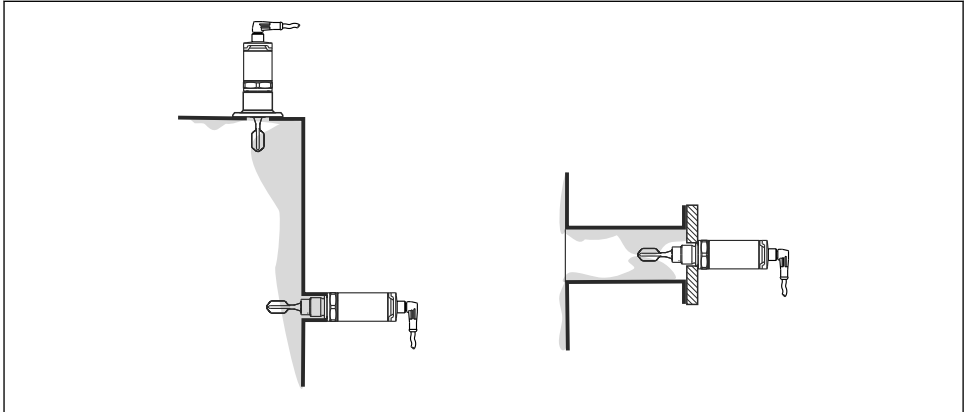

A0022057

5 Ansatz an Tank-, Rohrwand und Schwinggabel

5.1.5 Einschweißadapter mit Leckagebohrung

Achten Sie darauf, dass bei horizontalem Einbau die Leckagebohrung nach unten ausgerichtet ist, um eine Undichtigkeit schnellstmöglich zu erkennen.

5.1.6 Markierung

Die Markierung weist auf die Position der Schwinggabel hin. Bei horizontalem Einbau in Behältern zeigt die Markierung nach oben.

Die Markierung befindet sich entweder als Materialangabe (z.B. 316L) oder als Gewindebezeichnung (z.B. G 1/2")

- auf dem Sechskant des Prozessadapters
- auf dem Typenschild
- auf dem Einschweißadapter

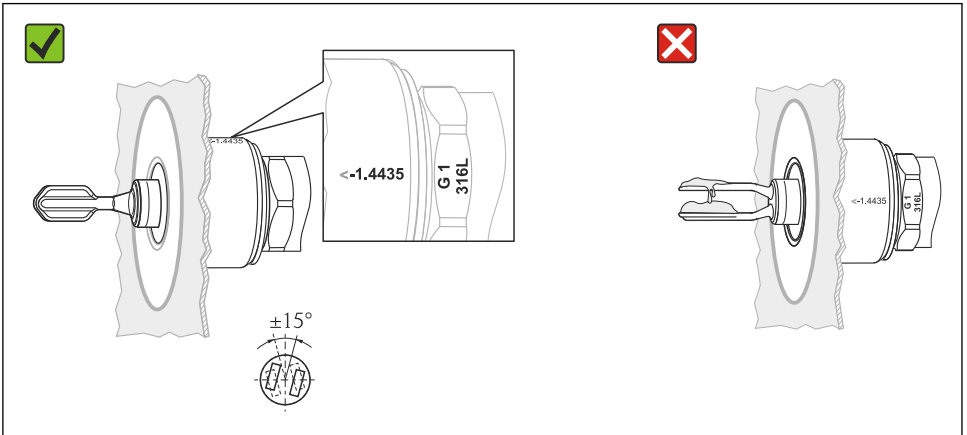

A0022641

6 Einbaulage im Behälter

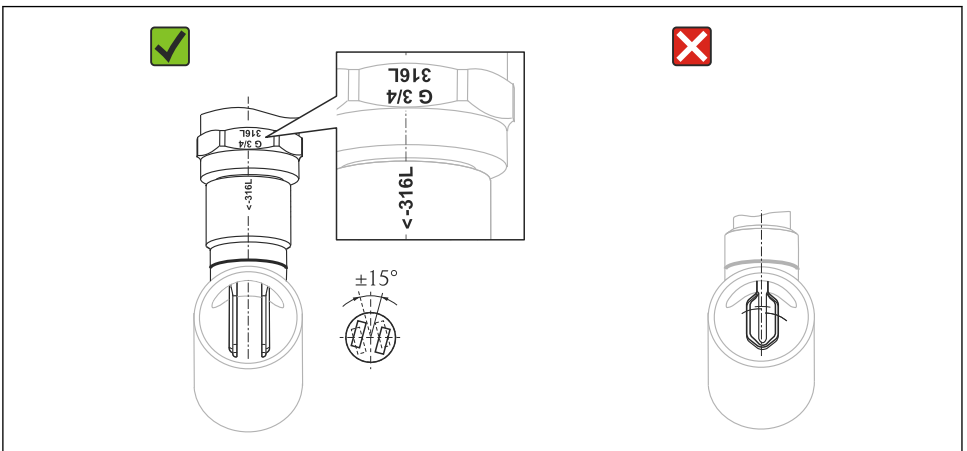

A0022804

7 Einbaulage im Rohrleitung

5.1.7 Einbau in Rohrleitungen

Achten Sie beim Einbau auf die Stellung der Schwinggabel, um Verwirbelungen in der Rohrleitung zu minimieren.

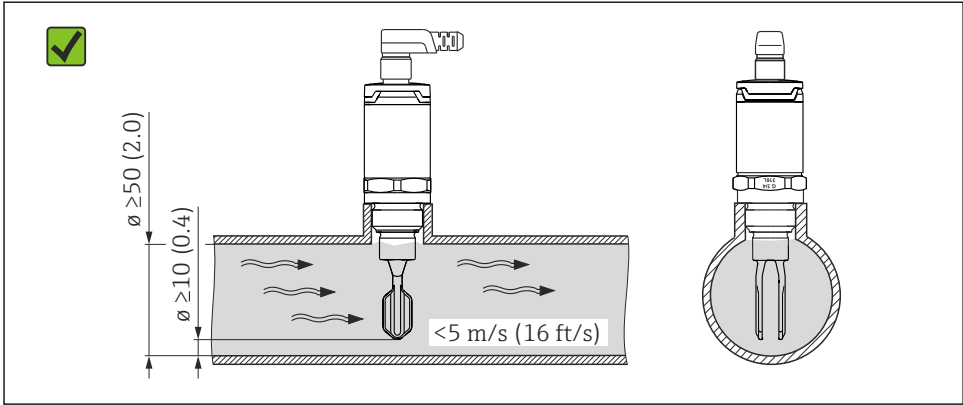

Maßangabe mm (in)

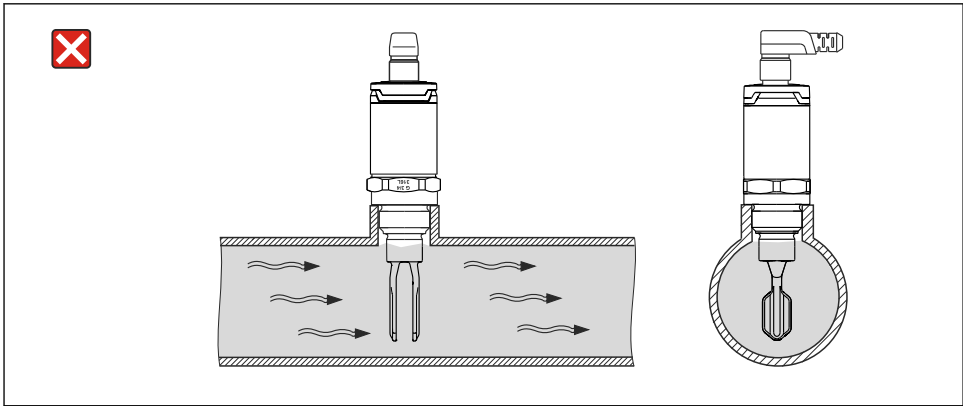

5.1.8 Einbau in Behälter

Achten Sie bei horizontalem Einbau auf die Stellung der Schwinggabel, damit die Flüssigkeit gut abtropfen kann.

Der elektrische Anschluss, z.B. Stecker M12, sollte mit dem Kabel nach unten ausgerichtet sein. Dadurch kann das Eindringen von Feuchtigkeit vermieden werden.

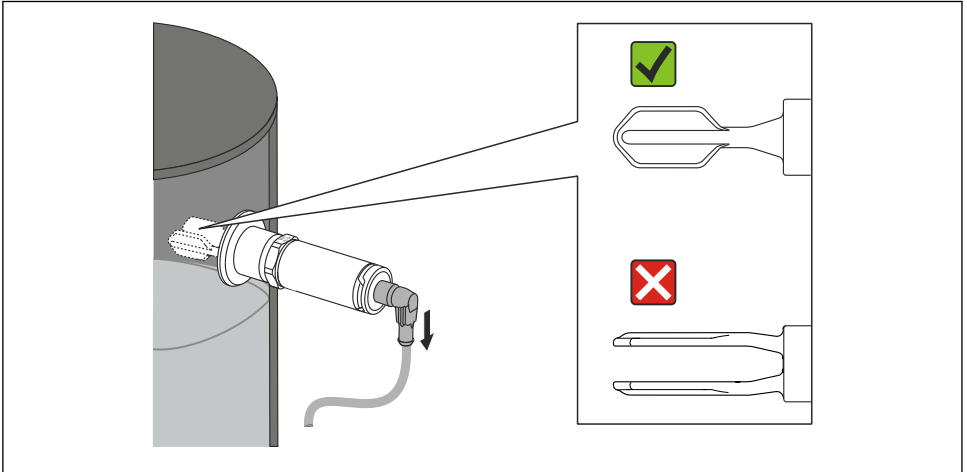

A0021034

8 Stellung der Schwinggabel bei horizontalem Einbau im Behälter

5.1.9 Abstand zur Wand

Achten Sie auf ausreichenden Abstand zwischen dem zu erwartendem Füllgutansatz an der Tankwand und der Schwinggabel. Empfohlener Wandabstand ≥ 10 mm (0,39 in).

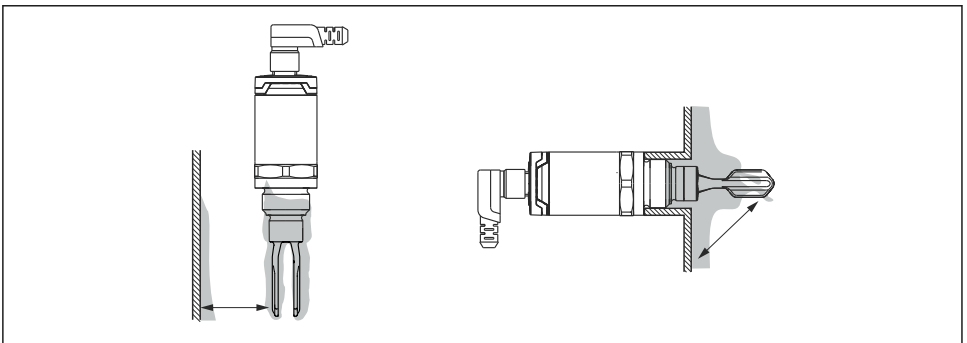

A0022272

5.2 Messgerät montieren





i Einsatz gemäß WHG: Beachten Sie vor der Montage des Gerätes die WHG-Zulassungsunterlagen. Die Unterlagen finden Sie im Download-Bereich der Endress+Hauser Internetseite: www.endress.com → [download](#)

5.2.1 Benötigtes Werkzeug

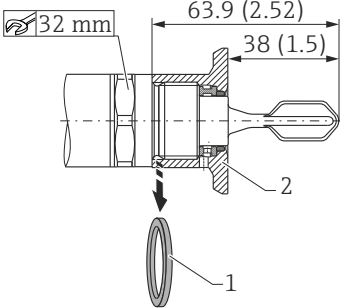
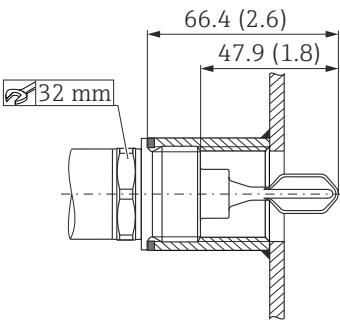
- Gabelschlüssel: Beim Einschrauben nur am Sechskant drehen.
Maximales Drehmoment: $\leq 30 \text{ Nm}$ (22 lbf ft).
- Steckschlüssel: Der Steckschlüssel SW32 ist als Zubehör erhältlich →  33.

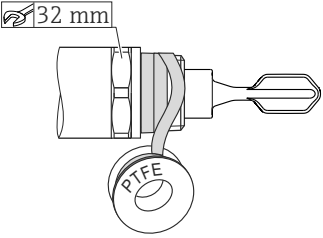
i Beachten Sie die Temperatur- und Druckangaben bei kundenseitig verwendeten Dichtungen und Klammern.

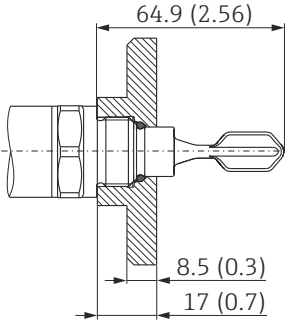
Ansicht, Maßangabe mm (in)	Beschreibung
 <p style="text-align: right;">A0022025</p> <p>1 Flachdichtung 2 Einschweißadapter</p>	<p>Gewinde Zubehör Einschweißadapter Beispiel G 3/4"</p> <p>Druck und Temperatur (maximal):</p> <ul style="list-style-type: none"> ■ +25 bar (+362 psi) bei +150 °C (+302 °F) ■ +40 bar (+580 psi) bei +100 °C (+212 °F) <p>i Bei Verwendung eines Einschweißadapters mit frontbündiger Dichtung muss die mitgelieferte Flachdichtung (1) vom Gewinde entfernt werden.</p>
 <p style="text-align: right;">A0022026</p>	<p>Gewinde metrisch in Kundenstutzen</p> <p>Druck und Temperatur (maximal): +40 bar (+580 psi) bei +150 °C (+302 °F)</p>

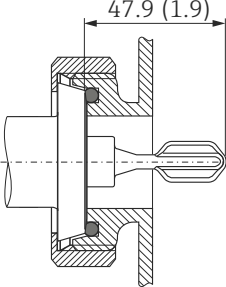
Ansicht, Maßangabe mm (in)	Beschreibung
 <p style="text-align: right;">A0022028</p>	<p>Gewinde NPT (ANSI B 1.20.1)</p> <p>Druck und Temperatur (maximal): +40 bar (+580 psi) bei +150 °C (+302 °F)</p> <p> Bei Bedarf mit Dichtungsmaterial umwickeln.</p>
 <p style="text-align: right;">A0022037</p>	<p>Gewinde M24x1,5 für frontbündigen Einbau in Adapter</p> <p>Zubehör: Prozessadapter Temperatur (maximal): +130 °C (+266 °F)</p> <p> Bitte beachten Sie die unterschiedlichen Druckstufen, siehe Technische Dokumentation TI01148F/00/DE</p> <p>Zubehör: Einschweißadapter Druck und Temperatur (maximal): +25 bar (+362 psi) bei +150 °C (+302 °F)</p>
 <p style="text-align: right;">A0022036</p>	<ul style="list-style-type: none"> ▪ DIN11851 DN25 PN40 (Milchrohr) ▪ DIN11851 DN32 PN40 (Milchrohr) ▪ DIN11851 DN40 PN40 (Milchrohr) <p>Druck und Temperatur (maximal): +25 bar (+362 psi) bei +150 °C (+302 °F) +40 bar (+580 psi) bei +100 °C (+212 °F)</p>

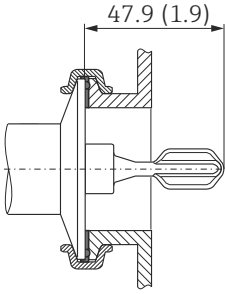
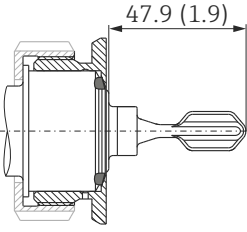
Ansicht, Maßangabe mm (in)	Beschreibung
 <p style="text-align: right; font-size: small;">A0022035</p>	<p>Tri-Clamp ISO2852 DN25-38 (1...1 1/2") DIN32676 DN25-40 Tri-Clamp ISO2852 DN40-51 (2") DIN32676 DN50</p> <p>Druck und Temperatur (maximal): +25 bar (+362 psi) bei +150 °C (+302 °F)</p> <p>HINWEIS</p> <ul style="list-style-type: none"> ▶ Beachten Sie die Temperatur- und Druckangaben für die kundenseitig verwendeten Dichtungen und Klammern.
 <p style="text-align: right; font-size: small;">A0022038</p>	<p>Frontbündiger Einbau in Einschweißadapter RD52, Schwinggabel ausrichtbar</p> <p>Mit Silikondichtung und Nutmutter</p> <p>Druck und Temperatur (maximal):</p> <ul style="list-style-type: none"> ■ +25 bar (+362 psi) bei +150 °C (+302 °F) ■ +40 bar (+580 psi) bei +100 °C (+212 °F)

5.3 Montagekontrolle

<input type="radio"/>	Ist das Gerät unbeschädigt (Sichtkontrolle)?
<input type="radio"/>	Erfüllt das Gerät die Messstellenspezifikationen? Zum Beispiel: <ul style="list-style-type: none"> ■ Prozesstemperatur ■ Prozessdruck ■ Umgebungstemperatur ■ Schaltpunkt
<input type="radio"/>	Sind Messstellenkennzeichnung und Beschriftung korrekt (Sichtkontrolle)?
<input type="radio"/>	Ist das Gerät gegen Nässe und direkte Sonneneinstrahlung ausreichend geschützt?
<input type="radio"/>	Ist das Gerät sachgerecht befestigt?

6 Elektrischer Anschluss

Das Gerät hat zwei Betriebsarten: Maximum-Sicherheit (MAX) und Minimum-Sicherheit (MIN). Mit der Wahl der entsprechenden Betriebsart wird sichergestellt, dass das Gerät auch im Störfall sicherheitsgerichtet schaltet, z.B. bei Unterbrechung der Versorgungsleitung.

■ Maximum-Sicherheit (MAX)

Das Gerät hält den elektronischen Schalter geschlossen, solange der Flüssigkeitsstand unterhalb der Schwinggabel liegt. Beispielanwendung: Überfüllsicherung

■ Minimum-Sicherheit (MIN)

Das Gerät hält den elektronischen Schalter geschlossen, solange die Schwinggabel von Flüssigkeit bedeckt ist. Beispielanwendung: Trockenlaufschutz für Pumpen

Bei Erreichen des Grenzstands, bei Störungen und bei Stromausfall öffnet der elektronische Schalter (Ruhestromprinzip).

6.1 Gerät anschließen



Gemäß IEC/EN61010 ist für das Gerät ein geeigneter Trennschalter vorzusehen.

6.1.1 Elektronikvariante 3-Leiter DC-PNP

Spannungsquelle: Berührungsungefährliche Spannung oder Class 2 circuit (Nordamerika)

Stecker M12

Je nach Auswertung der Schaltausgänge arbeitet das Gerät in der Betriebsart MAX oder MIN.

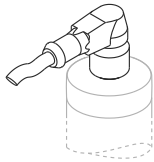
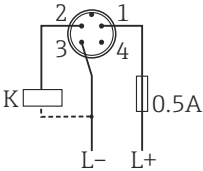
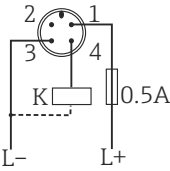
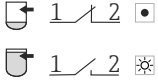
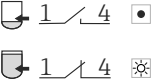
Elektrischer Anschluss	Betriebsart	
 <p>A0022901</p>	<p style="text-align: center;">MAX</p>  <p style="text-align: right;">A0022858</p>	<p style="text-align: center;">MIN</p>  <p style="text-align: right;">A0022859</p>
	 <p style="text-align: right;">A0021416</p>	 <p style="text-align: right;">A0021417</p>
<p> <input type="checkbox"/> LED gelb (ye) leuchtet nicht <input checked="" type="checkbox"/> LED gelb (ye) leuchtet K externe Last </p>		

Funktionsüberwachung mit Stecker M12



Mit einer zweikanaligen Auswertung kann neben der Füllstandsüberwachung auch eine Funktionsüberwachung des Sensors realisiert werden, z.B. per Relais-Schaltung, SPS, AS-i Bus I/O Modul, ...).

Bei der Beschaltung beider Ausgänge nehmen der MIN- und MAX-Ausgang im störungsfreien Betrieb gegenläufige Zustände (Antivalenz) ein. Im Störfall oder bei Leitungsbruch fallen beide Ausgänge ab.

Anschluss für Funktionsüberwachung durch Antivalenz		LED gelb (ye)	LED rot (rd)
<p>A0022917</p>	<p>Sensor bedeckt</p> <p>A0023016</p>	<p>☼</p> <p>•</p>	
	<p>Sensor frei</p> <p>A0023029</p>	<p>•</p> <p>•</p>	
	<p>Störung</p> <p>A0023030</p>	<p>•</p> <p>☼</p>	
<p>☼ LED leuchtet</p> <p>• LED leuchtet nicht</p> <p>⚡ Störung oder Warnung</p> <p>K1 / K2 externe Last</p>			

Ventilstecker, Kabel

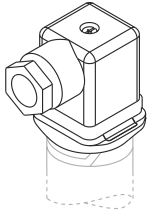
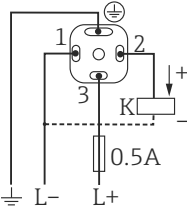
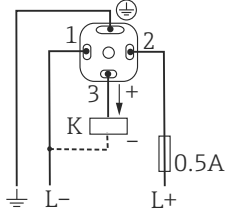
Abhängig von der Belegung des Anschlusssteckers oder der Verdrahtung des Kabels, arbeitet das Gerät entweder in der Betriebsart MAX oder MIN.

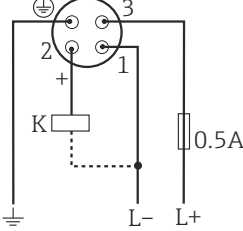
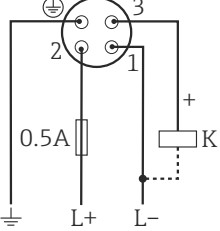
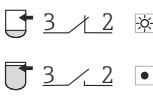
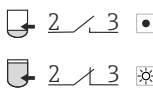
Elektrischer Anschluss	Betriebsart	
 <p>A0022900</p>	MAX	MIN
	 <p>A0021724</p>	 <p>A0021723</p>
 <p>A0022902</p> <p>Adernfarben: 1 = BK (schwarz) 2 = GR (grau) 3 = BN (braun) Erde = GNYE (grün-gelb)</p>	 <p>A0022226</p>	 <p>A0022227</p>
	 <p>A0021413</p>	 <p>A0021414</p>
<p> <input type="checkbox"/> LED gelb (ye) leuchtet nicht <input checked="" type="checkbox"/> LED gelb (ye) leuchtet K externe Last </p>		

6.1.2 Elektronikvariante 2-Leiter AC/DC

Nicht geeignet für den Anschluss an Niederspannungs-SPS-Eingänge!

Auswahlhilfe für Relais

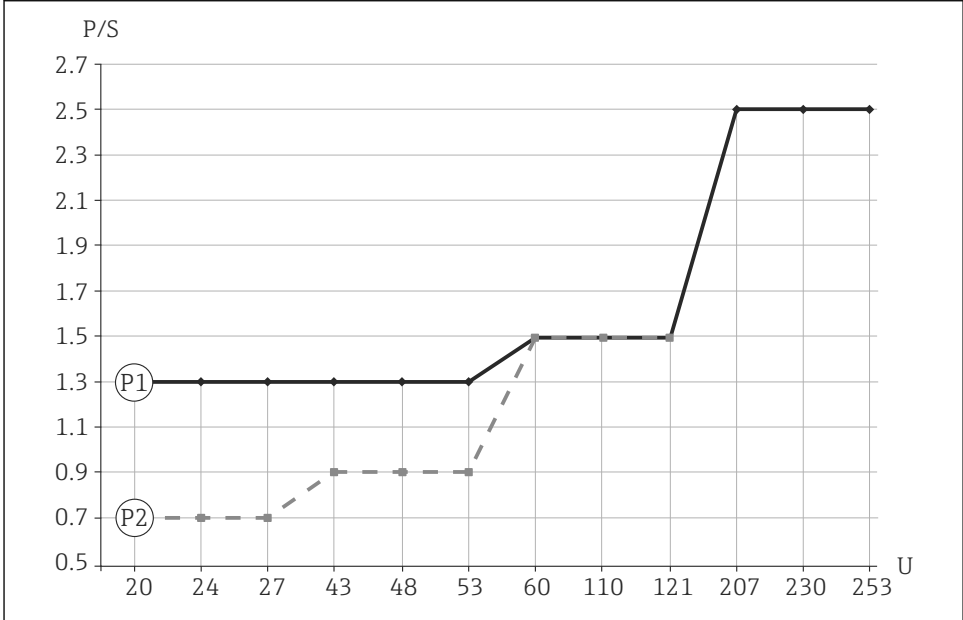

A0023486

9 Minimale Nennleistung der Last

P/S Nennleistung in [W] / [VA]

U Betriebsspannung in [V]



Position	Betriebsspannung	Nennleistung	
		min	max
P1 AC-Betrieb	24 V	> 1,3 VA	< 6 VA
	110 V	> 1,5 VA	< 27,5 VA
	230 V	> 2,5 VA	< 57,5 VA
P2 DC-Betrieb	24 V	> 0,7 W	< 6 W
	48 V	> 0,9 W	< 12 W
	60 V	> 1,5 W	< 15 W

Relais mit geringerer Nennleistung können über ein parallel geschaltetes RC-Glied betrieben werden (optional).

Ventilstecker, Kabel

Abhängig von der Belegung des Anschlusssteckers oder der Verdrahtung des Kabels, arbeitet das Gerät entweder in der Betriebsart MAX oder MIN.

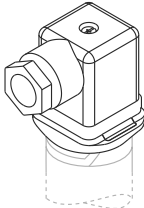
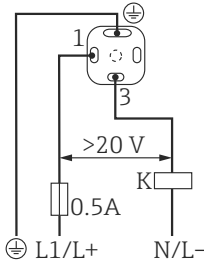
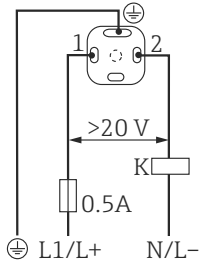
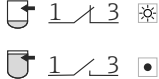
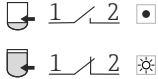
Bei der Verdrahtung des Kabels ist jeweils eine Ader des Kabels ohne Funktion (grau bei MAX, braun bei MIN). Das Kabel ohne Funktion muss gegen unbeabsichtigtes Kontaktieren gesichert werden.

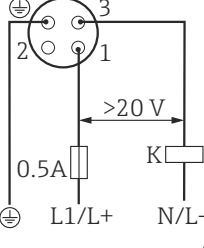
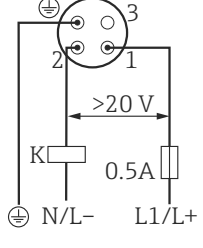
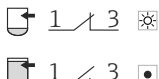
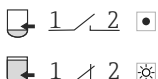
Elektrischer Anschluss	Betriebsart	
 <p>A0022900</p>	<p>MAX</p>  <p>A0021219</p>	<p>MIN</p>  <p>A0021220</p>
	 <p>A0021418</p>	 <p>A0021420</p>
 <p>A0022902</p> <p>Adernfarben: 1 = BK (schwarz) 2 = GR (grau) 3 = BN (braun) Erde = GNYE (grün-gelb)</p>	 <p>A0022161</p>	 <p>A0022225</p>
	 <p>A0021418</p>	 <p>A0021420</p>
<p> <input type="checkbox"/> LED gelb (ye) leuchtet nicht <input checked="" type="checkbox"/> LED gelb (ye) leuchtet K externe Last </p>		



6.2 Anschlusskontrolle

<input type="radio"/>	Sind Gerät oder Kabel unbeschädigt (Sichtkontrolle)?
<input type="radio"/>	Erfüllen die verwendeten Kabel die Anforderungen?
<input type="radio"/>	Sind die montierten Kabel von Zug entlastet?
<input type="radio"/>	Sind die Kabelverschraubungen montiert, fest angezogen?
<input type="radio"/>	Stimmt die Versorgungsspannung mit den Angaben auf dem Typenschild überein?
<input type="radio"/>	Ist die Verdrahtung korrekt?
<input type="radio"/>	3-Leiter DC-PNP: Falls erforderlich, ist die Funktionserde angeschlossen?
<input type="radio"/>	2-Leiter AC/DC: Ist die Schutzleiterverbindung hergestellt?
<input type="radio"/>	Wenn Versorgungsspannung vorhanden: Leuchtet die grüne LED?

7 Inbetriebnahme

7.1 Installations- und Funktionskontrolle

Vergewissern Sie sich, dass die Einbau- und Anschlusskontrolle durchgeführt wurde, bevor Sie Ihre Messstelle in Betrieb nehmen:

- Checkliste "Montagekontrolle" →  22
- Checkliste "Anschlusskontrolle" →  28



Die Funktion der Schwinggabel lässt sich leicht prüfen, in dem Sie die Schwinggabel in einen Behälter mit Wasser tauchen.

7.2 LED-Anzeige

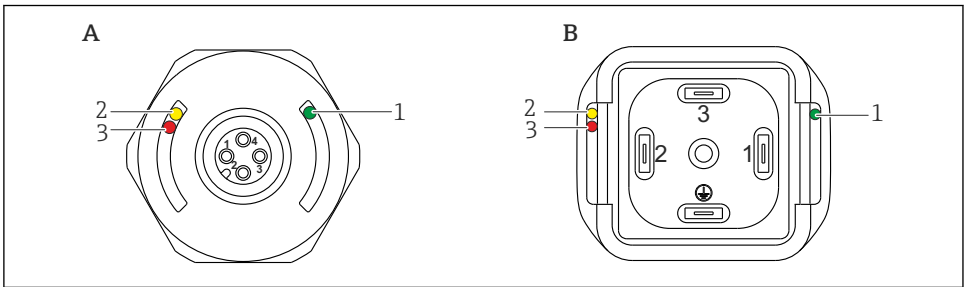

A0016856

A Stecker M12, (Kabel ohne Abbildung)

















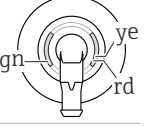





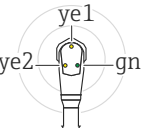





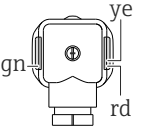

B Ventilstecker

Position	Funktion	Beschreibung
1	LED grün (gn) leuchtet	Gerät ist betriebsbereit
2	LED gelb (ye) leuchtet	Stecker M12 Anzeige des Sensorzustandes: Schwinggabel ist von Flüssigkeit bedeckt Ventilstecker / Kabel Anzeige des Schaltzustandes: <ul style="list-style-type: none"> ▪ Betriebsart MAX (Überfüllsicherung): Sensor ist nicht von Flüssigkeit bedeckt ▪ Betriebsart MIN (Trockenlaufschutz): Sensor ist von Flüssigkeit bedeckt
3	LED rot (rd) blinkt leuchtet	Warnung/Wartungsbedarf: Fehler behebbar, z.B. Fehlverdrahtung Störung/Geräteausfall: Fehler nicht behebbar, z.B. Elektronikfehler

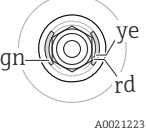

Bei der metallischen Gehäusekappe (IP69K) ist keine Signalisierung durch LEDs von außen vorhanden. Ein Anschlusskabel mit M12 Stecker und LED-Anzeige ist als Zubehör bestellbar

7.2.1 Funktion der LEDs

Anschluss	Betriebsarten							
	Maximum-Sicherheit (MAX)		Minimum-Sicherheit (MIN)		Warnung	Störung		
1 								
2 								
3 								
4 								
5 								
1: Füllstandanzeige 2: Stecker M12 3: Stecker M12 mit LEDs 4: Ventilstecker 5: Kabel	A0021225		A0021226		A0021227	A0021228	A0022920	A0021229
			● leuchtet nicht ☀ leuchtet ⚡ blinkt ⚡ Störung/Warnung					
LED-Farben: gn = green (grün), ye = yellow (gelb), rd = red (rot) Weitere Informationen zur LED-Anzeige → 29								

7.3 Funktionstest mit Testmagnet

⚠️ WARNUNG

Verletzungsgefahr!

- ▶ Stellen Sie sicher, dass keine gefährlichen Prozesse an der Anlage ausgelöst werden.

Um einen Funktionstest durchzuführen, halten Sie den Testmagnet an die Markierung auf dem Typenschild (mindestens 2 Sekunden). Dadurch invertiert der aktuelle Schaltzustand und die gelbe LED ändert ihren Zustand. Beim Entfernen des Magnets wird der dann gültige Schaltzustand angenommen.

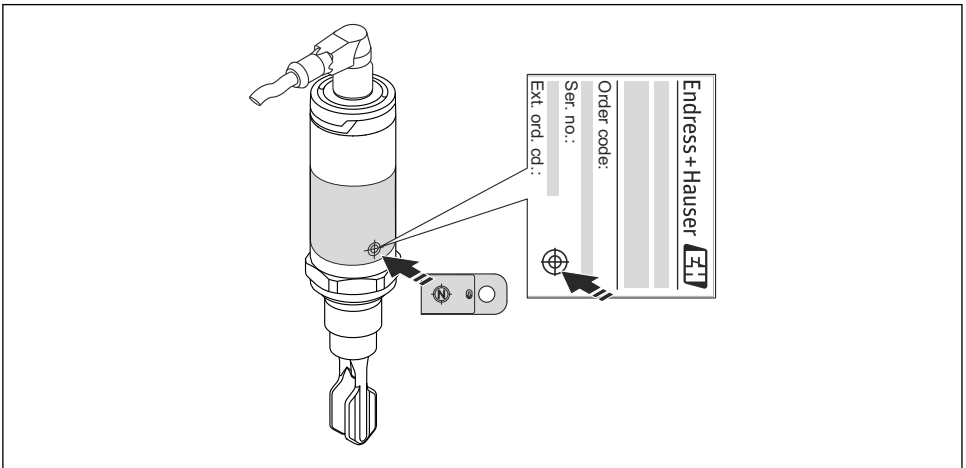

A0020960

10 Testmagnet und Markierung



Der Testmagnet ist nicht im Lieferumfang enthalten und kann optional als Zubehör bestellt werden. → 33

8 Diagnose und Störungsbehebung

8.1 Diagnoseinformation via LED-Anzeige

LED-Anzeige an der Gehäusekappe

Fehlfunktion	Mögliche Ursache	Maßnahme
LED grün leuchtet nicht	Keine Spannungsversorgung	Stecker, Kabel und Spannungsversorgung prüfen
LED rot blinkt	Überlast oder Kurzschluss im Laststromkreis	<ul style="list-style-type: none"> ▪ Kurzschluss beheben ▪ Maximalen Laststrom auf unter 250 mA reduzieren
LED rot leuchtet	Interner Sensorfehler oder Sensor korrodiert	Gerät austauschen

LED-Anzeige am Stecker M12 (als Zubehör bestellbar)

Fehlfunktion	Mögliche Ursache	Maßnahme
LED grün leuchtet nicht	Keine Spannungsversorgung	Stecker, Kabel und Spannungsversorgung prüfen
LED gelb leuchtet nicht	Interner Sensorfehler oder Sensor korrodiert	<ul style="list-style-type: none"> ▪ Kabel überprüfen ▪ Maximalen Laststrom auf unter 250 mA reduzieren ▪ Gerät austauschen
LED gelb beide leuchten		

Anschluss: 2-Leiter AC/DC an 20...253 V DC

Fehlfunktion	Mögliche Ursache	Maßnahme
Unerwartetes Verhalten der LED gelb	Falsche Belegung des Steckers oder falsche Verdrahtung des Kabels	<p>Polarität der Spannungsversorgung beachten!</p> <p>Korrektter Anschluss: Ventilstecker: L+ an PIN1, L- an PIN 3 Kabel: L+ BK (schwarz), L- BN (braun)</p> <p>Ergebnis</p> <ul style="list-style-type: none"> ▪ Schwinggabel bedeckt: LED gelb leuchtet. ▪ Schwinggabel frei: LED gelb leuchtet nicht.

9 Wartung

Es sind keine speziellen Wartungsarbeiten erforderlich.

9.1 Reinigung

Der Sensor ist bei Bedarf zu reinigen. Die Reinigung kann auch im eingebauten Zustand erfolgen (z.B. CIP Cleaning in Place / SIP Sterilization in Place). Es ist darauf zu achten, dass der Sensor dabei nicht beschädigt wird.

10 Reparatur

Für den Grenzscharter ist keine Reparatur vorgesehen.

10.1 Ersatzteile

Die Website zum W@M Device Viewer (www.endress.com/deviceviewer): Dort werden alle Ersatzteile zum Messgerät inklusive Bestellcode aufgelistet und lassen sich bestellen. Wenn vorhanden, steht auch die dazugehörige Einbauanleitung zum Download zur Verfügung.

10.2 Rücksendung

Im Fall einer Reparatur, Werkskalibrierung, falschen Lieferung oder Bestellung muss das Messgerät zurückgesendet werden. Als ISO-zertifiziertes Unternehmen und aufgrund gesetzlicher Bestimmungen ist Endress+Hauser verpflichtet, mit allen zurückgesendeten Produkten, die mediumsberührend sind, in einer bestimmten Art und Weise umzugehen.

Um eine sichere, fachgerechte und schnelle Rücksendung Ihres Geräts sicherzustellen: Informieren Sie sich über Vorgehensweise und Rahmenbedingungen auf der Endress+Hauser Internetseite www.services.endress.com/return-material

10.3 Entsorgung

Bei der Entsorgung ist auf eine stoffliche Trennung und Verwertung der Gerätekomponenten zu achten.

11 Zubehör



Detaillierte Informationen zum Zubehör finden Sie in der Technischen Dokumentation TI01148F.

Bezeichnung	Ergänzung
Einschweißadapter	Detaillierte Informationen finden Sie in der TI00426F/00/DE "Einschweißadapter und Flansche" sowie in den Zusatzdokumentationen → 7.
Dichtungen, O-Ringe	
Prozessadapter M24	Detaillierte Informationen finden Sie in der TI01148F/00/DE.
Nutmutter	
Steckerbuchse M12 mit Kabel 5 m (16 ft)	<ul style="list-style-type: none"> ■ IP69K, Überwurfmutter 316L <ul style="list-style-type: none"> - Gewinkelt 90° mit LED, Bestellnummer: 52018763 - Gewinkelt 90° ohne LED, Bestellnummer: 52024216 ■ IP67, Überwurfmutter (Cu Sn/Ni) <ul style="list-style-type: none"> - Gewinkelt 90°, Bestellnummer: 52010285 - Gerade, Bestellnummer: 52006263
Montagesteckschlüssel	Sechskant, SW32, Bestellnummer: 52010156
Testmagnet	Bestellnummer: 71267011

12 Technische Daten

 Weitere Angaben der technischen Daten finden Sie in der Technischen Dokumentation TI01148F/00/DE.

12.1 Energieversorgung

Elektronikvariante	Versorgungsspannung	Leistungsaufnahme	Stromaufnahme
3-Leiter DC-PNP	10...30 V DC	< 975 mW	< 15 mA
2-Leiter AC/DC	20...253 V	< 850 mW	< 3,8 mA

12.2 Umgebung

Umgebungstemperaturbereich	-40...+70 °C (-40...+158 °F), siehe Derating →  35
Lagerungstemperatur	-40...+85 °C (-40...+185 °F)
Klimaklasse	DIN EN 60068-2-38/IEC 68-2-38: Prüfung Z/AD
Einsatzhöhe	Bis 2 000 m (6 600 ft) über Normalnull
Stoßfestigkeit	a = 300 m/s ² = 30 g, 3 Achsen x 2 Richtungen x 3 Stöße x 18 ms, gem. Prüfung Ea, prEN 60068-2-27:2007
Schwingungsfestigkeit	a(RMS) = 50 m/s ² , ASD = 1,25 (m/s ²) ² /Hz, f = 5 ... 2000 Hz, t = 3 x 2 h, gem. Prüfung Fh, EN 60068-2-64:2008
Verpolungsschutz	<p>2-Leiter AC/DC</p> <ul style="list-style-type: none"> ▪ AC-Betrieb: Gerät ist verpolsicher. ▪ DC-Betrieb: Bei Verpolung wird immer die Betriebsart Maximum-Sicherheit erkannt. Überprüfen Sie vor der Inbetriebnahme die Verdrahtung und führen Sie einen Funktionstest durch. Das Gerät wird bei Verpolung nicht beschädigt. <p>3-Leiter DC-PNP</p> <p>Integriert. Bei Verpolung wird das Gerät automatisch deaktiviert.</p>
Kurzschlusschutz	<p>2-Leiter AC/DC</p> <p>Beim Schaltvorgang überprüft der Sensor, ob eine Last, z.B. Relais oder Schütz, vorhanden ist (Load- Check). Tritt ein Fehler auf, wird der Sensor nicht zerstört. Intelligente Überwachung: Nach Beheben des Fehlers erfolgt der Normalbetrieb.</p> <p>3-Leiter DC-PNP</p> <p>Überlastschutz/Kurzschlusschutz bei I > 250 mA; der Sensor wird nicht zerstört. Intelligente Überwachung: Überprüfung auf Überlast im Abstand von ca. 1,5 s; nach Beheben der Überlast/des Kurzschlusses erfolgt der Normalbetrieb.</p>
Schutzart	<ul style="list-style-type: none"> ▪ IP65/67 NEMA Type 4X Enclosure (Stecker M12) ▪ IP66/68/69K NEMA Type 4X/6P Enclosure (Stecker M12 für metallische Gehäusekappe) ▪ IP65 NEMA Type 4X Enclosure (Ventilstecker) ▪ IP66/68 NEMA Type 4X/6P Enclosure (Kabel)
Elektromagnetische Verträglichkeit	<p>Elektromagnetische Verträglichkeit gemäß allen relevanten Anforderungen der EN 61326-Serie und NAMUR- Empfehlung EMV (NE21). Details sind aus der EG-Konformitätserklärung ersichtlich.</p> <p>Verfügbar im Download-Bereich der Endress+Hauser Internetseite: www.endress.com.</p>

12.2.1 Derating

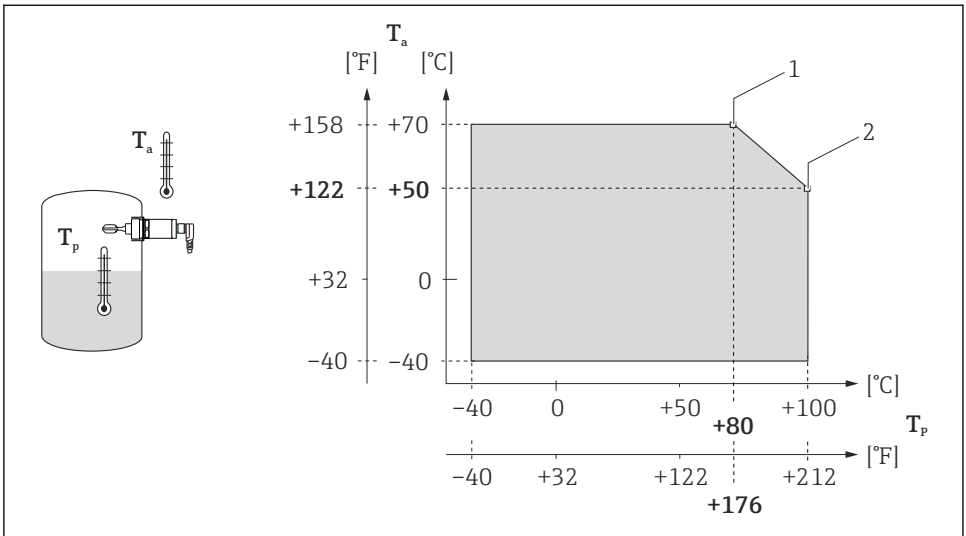

A0022002

11 Derating-Kurve: 100 °C (212 °F)

1 I_{max} : 200 mA (DC-PNP), 250 mA (AC/DC)

2 I_{max} : 150 mA (DC-PNP), 150 mA (AC/DC)

T_a Umgebungstemperatur

T_p Prozesstemperatur

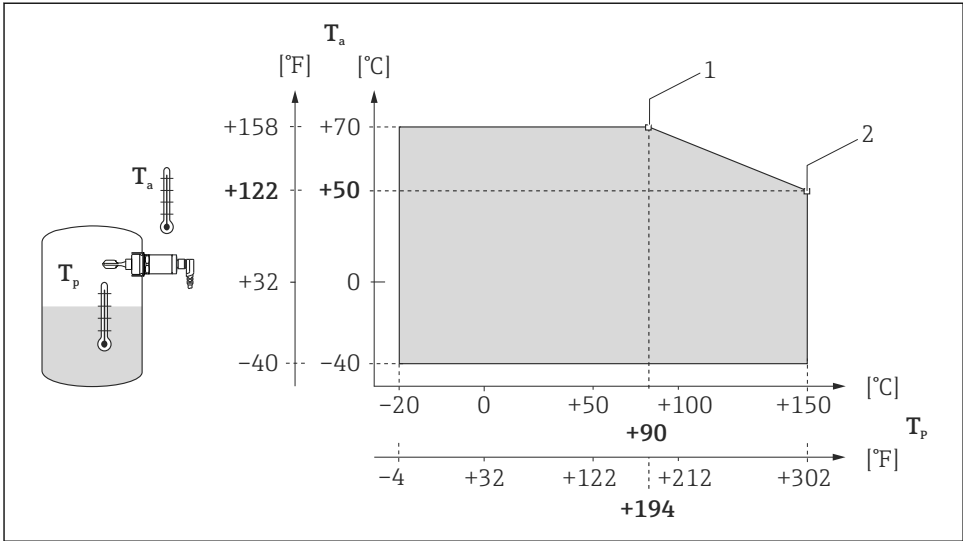

A0020869

12 Derating-Kurve: 150 °C (302 °F)

1 I_{max}: 200 mA (DC-PNP), 250 mA (AC/DC)

2 I_{max}: 150 mA (DC-PNP), 150 mA (AC/DC)

T_a Umgebungstemperatur

T_p Prozesstemperatur

12.3 Prozess

HINWEIS

► Beachten Sie das Druck- und Temperatur-Derating in Abhängigkeit des gewählten Prozessanschlusses.

Prozesstemperaturbereich	-40...+100 °C (-40...+212 °F) -40...+150 °C (-40...+302 °F)
Prozessdruckbereich	max. -1...+40 bar (-14,5...+580 psi)
Messstoffdichte	> 0,7 g/cm ³ (optional bestellbar: > 0,5 g/cm ³)
Aggregatzustand	flüssig
Viskosität	1...10 000 mPa · s dynamische Viskosität
Feststoffanteil	ø < 5 mm (0,2 in)
Seitliche Belastbarkeit	Seitliche Belastbarkeit der Schwinggabel: max. 200 N

Table of contents

1 Document information	38	10.3 Disposal	65
1.1 Document function	38	11 Accessories	65
1.2 Symbols	38	12 Technical data	66
1.3 Documentation	39	12.1 Power supply	66
2 Basic safety instructions	40	12.2 Environment	66
2.1 Requirements for the personnel	40	12.3 Process	68
2.2 Designated use	40		
2.3 Workplace safety	40		
2.4 Operational safety	41		
2.5 Product safety	41		
3 Product description	42		
3.1 Product design	42		
4 Incoming acceptance and product identification	43		
4.1 Incoming acceptance	43		
4.2 Product identification	44		
4.3 Storage and transport	44		
5 Installation	46		
5.1 Installation conditions	46		
5.2 Mounting the measuring device	52		
5.3 Post-installation check	54		
6 Electrical connection	55		
6.1 Connecting the device	55		
6.2 Post-connection check	60		
7 Commissioning	61		
7.1 Function check	61		
7.2 LED display	61		
7.3 Function test with test magnet	63		
8 Diagnostics and troubleshooting	64		
8.1 Diagnostic information via LED display	64		
9 Maintenance	64		
9.1 Cleaning	64		
10 Repair	65		
10.1 Spare parts	65		
10.2 Return	65		





1 Document information

1.1 Document function



These Operating Instructions contain all the information that is required in various phases of the life cycle of the device: from product identification, incoming acceptance and storage, to mounting, connection, operation and commissioning through to troubleshooting, maintenance and disposal.

1.2 Symbols



1.2.1 Safety instructions



Symbol	Meaning
 A0011189-EN	DANGER! This symbol alerts you to a dangerous situation. Failure to avoid this situation will result in serious or fatal injury.
 A0011190-EN	WARNING! This symbol alerts you to a dangerous situation. Failure to avoid this situation can result in serious or fatal injury.
 A0011191-EN	CAUTION! This symbol alerts you to a dangerous situation. Failure to avoid this situation can result in minor or medium injury.
 A0011192-EN	NOTE! This symbol contains information on procedures and other facts which do not result in personal injury.

1.2.2 Electrical symbols

Symbol	Meaning
 A0011200	Ground connection A grounded terminal which, as far as the operator is concerned, is grounded via a grounding system.
 A0011199	Protective ground connection A terminal which must be connected to ground prior to establishing any other connections.

1.2.3 Symbols for certain types of information

Symbol	Meaning
 A0011182	Permitted Indicates procedures, processes or actions that are permitted.
 A0011184	Forbidden Indicates procedures, processes or actions that are forbidden.

Symbol	Meaning
 A0011193	Tip Indicates additional information.
 A0011194	Reference to documentation Refers to the corresponding device documentation.
 A0011195	Reference to page Refers to the corresponding page number.

1.2.4 Symbols for graphics

Symbol	Meaning
1, 2, 3 ...	Item numbers
A, B, C, ...	Views

1.2.5 Symbols for tools

Symbol	Meaning
 A0011222	Open-ended wrench

1.3 Documentation

The document types listed are available in the Download Area of the Endress+Hauser website:
www.endress.com → [Download](#)

Document	Purpose and content of the document
Technical Information TI01148F/00/EN	This document contains all the technical data for the device and provides an overview of the accessories that can be ordered.
Additional documentation TI00426F/00/EN SD00352F/00/A6 SD00356F/00/EN BA00361F/00/A6	Weld-in adapter and flanges (overview) Weld-in adapter G 1", G ¾" (installation instructions) Valve plug (installation instructions) Weld-in adapter M24 (installation instructions)

2 Basic safety instructions

2.1 Requirements for the personnel

The personnel for installation, commissioning, diagnostics and maintenance must fulfill the following requirements:

- Trained, qualified specialists must have a relevant qualification for this specific function and task
- Are authorized by the plant owner/operator
- Are familiar with federal/national regulations
- Before beginning work, the specialist staff must have read and understood the instructions in the Operating Instructions and supplementary documentation as well as in the certificates (depending on the application)
- Following instructions and basic conditions

The operating personnel must fulfill the following requirements:

- Being instructed and authorized according to the requirements of the task by the facility's owner-operator
- Following the instructions in these Operating Instructions

2.2 Designated use

The measuring device described in these Operating Instructions may only be used as a level limit switch for liquids. Incorrect use may pose a hazard. To ensure that the measuring device remains in proper condition for the operation time:

- the measuring devices may only be used for media against which the process-wetted materials are adequately resistant.
- the limit values in "Technical Data" must be observed.

2.2.1 Incorrect use

The manufacturer is not liable for damage caused by improper or non-designated use.

Residual risks

Heat transfer from the process can heat up the electronics housing and the modules it contains to up to 80 °C (176 °F) during operation.

Danger of burns from contact with surfaces!

- ▶ For elevated fluid temperature, ensure protection against contact to prevent burns.

2.3 Workplace safety

For work on and with the device:

- ▶ Wear the required personal protective equipment according to federal/national regulations.
- ▶ Switch off the supply voltage before connecting the device.

2.4 Operational safety

Risk of injury!

- ▶ Operate the device in proper technical condition and fail-safe condition only.
- ▶ The operator is responsible for interference-free operation of the device.

2.5 Product safety

This measuring device is designed in accordance with good engineering practice to meet state-of-the-art safety requirements, has been tested, and left the factory in a condition in which it is safe to operate. It meets general safety standards and legal requirements. It also complies with the EC directives listed in the device-specific EC Declaration of Conformity. Endress +Hauser confirms this by affixing the CE mark to the device.

3 Product description

The Liquiphant FTL33 is a point level switch for universal use in all liquids. It is used preferably in storage tanks, mixing vessels and pipes, where the internal and external hygiene requirements are particularly stringent.

3.1 Product design

The point level switch is available in different versions which can be assembled in accordance with user specifications. Examples can be seen in the following diagram:

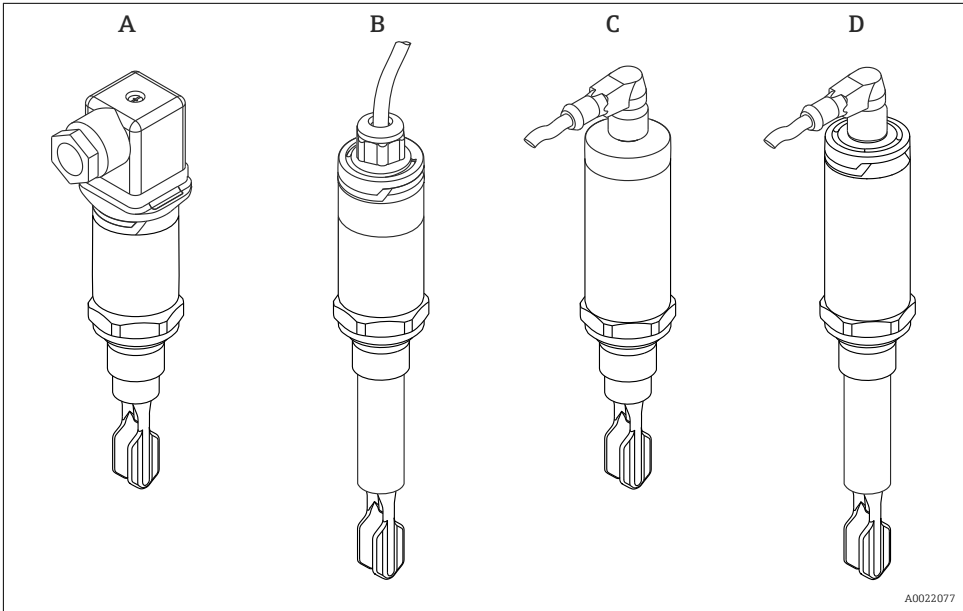

Versions	Examples			
	A	B	C	D
Electrical connection	Valve plug	Cable (cannot be dismantled)	M12 connector for housing cover IP66/68/69K	M12 connector for housing cover IP65/67
Housing (sensor design) for process temperatures up to:	100 °C (212 °F)	100 °C (212 °F)	150 °C (302 °F)	150 °C (302 °F)
Sensor type	Compact version	Short tube version	Compact version	Short tube version

i Detailed information on the short tube version and the process connections is available in Technical Documentation TI01148F/00/EN.

4 Incoming acceptance and product identification

4.1 Incoming acceptance



A0015502

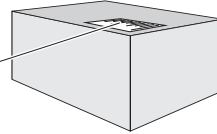

1 = 2

A0016051

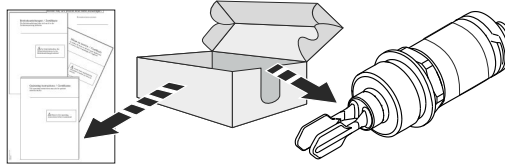

A0021096

Is the order code on the delivery note (1) identical to the order code on the product sticker (2)?



A0015502

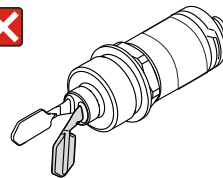
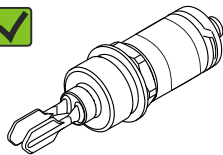

A0021097

Are the goods undamaged?



A0015502

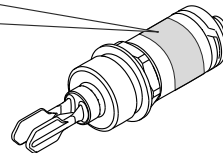
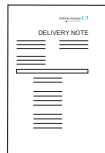

A0021098

Do the data on the nameplates correspond to the order specifications on the delivery note?



If one of these conditions is not met, please contact your Endress+Hauser sales office.

4.2 Product identification

The following options are available for identification of the measuring device:

- Nameplate data
- Order code with breakdown of the device features on the delivery note
- Enter serial number of nameplates in *W@M Device Viewer* (www.endress.com/deviceviewer): All information on the measuring device is displayed

An overview of the scope of the technical documentation supplied can be obtained by entering the serial number on the nameplate in *W@M Device Viewer* (www.endress.com/deviceviewer)



4.2.1 Nameplate

The diagram shows a nameplate with the following fields and symbols:

- 1: Endress+Hauser logo
- 2: Blank field
- 3: Order code
- 4: Ser. no.
- 5: Marking for test magnet (circle with crosshair)
- 6: Ext. ord. cd.
- 7: U: (with minus sign)
- 8: I max. (with plus sign)
- 9: Blank field
- 10: Blank field
- 11: Certificate symbols (CE, SF, N12895, 74-06)
- 12: Blank field
- 13: Blank field
- 14: TAG: (with blank field)
- 15: Date: (with blank field)
- 16: Data Matrix code (QR code)
- 17: BAxxxxF (with warning triangle and arrow)

A0021109

- 1: Device name
- 2: Manufacturer's address
- 3: Order code
- 4: Serial number
- 5: Marking for test magnet
- 6: Extended order code
- 7: Supply voltage
- 8: Signal output
- 9: Process and ambient temperature
- 10: Process pressure
- 11: Certificate symbols (optional)
- 12: Degree of protection: e.g. IP, NEMA
- 13: Certificate- and approval-specific data
- 14: Measuring point identification (optional)
- 15: Date of manufacture (year, month)
- 16: Data Matrix code
- 17: Document number of Operating Instructions

 The test magnet can be ordered as an accessory →  65.

4.3 Storage and transport

4.3.1 Storage conditions

- Permitted storage temperature: -40 to +85 °C (-40 to +185 °F)
- Use original packaging.

4.3.2 Handling of the device

NOTICE

Risk of injury! Housing or fork may become damaged or tear!

- ▶ Transport the device to the measuring point in its original packaging or by the housing.
- ▶ Do not hold the device by the fork!
- ▶ Do not use the device as a ladder or climbing aid!
- ▶ Do not bend the fork!
- ▶ Do not shorten or lengthen the fork!

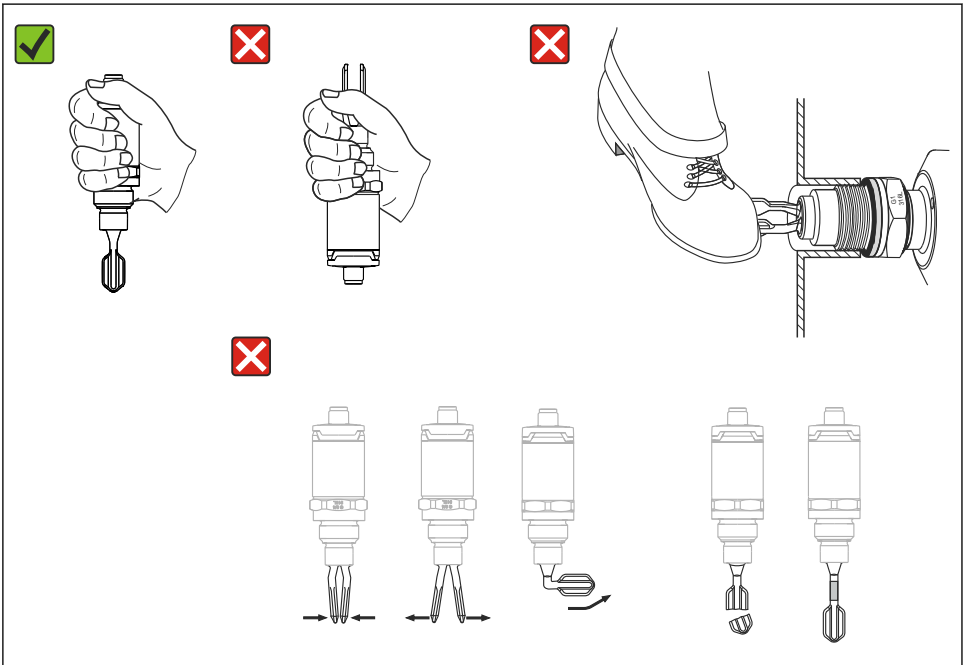

A0020845

13 Handling of the device

5 Installation

5.1 Installation conditions

5.1.1 Orientation

The point level switch can be installed in any position in a vessel, pipe or tank.

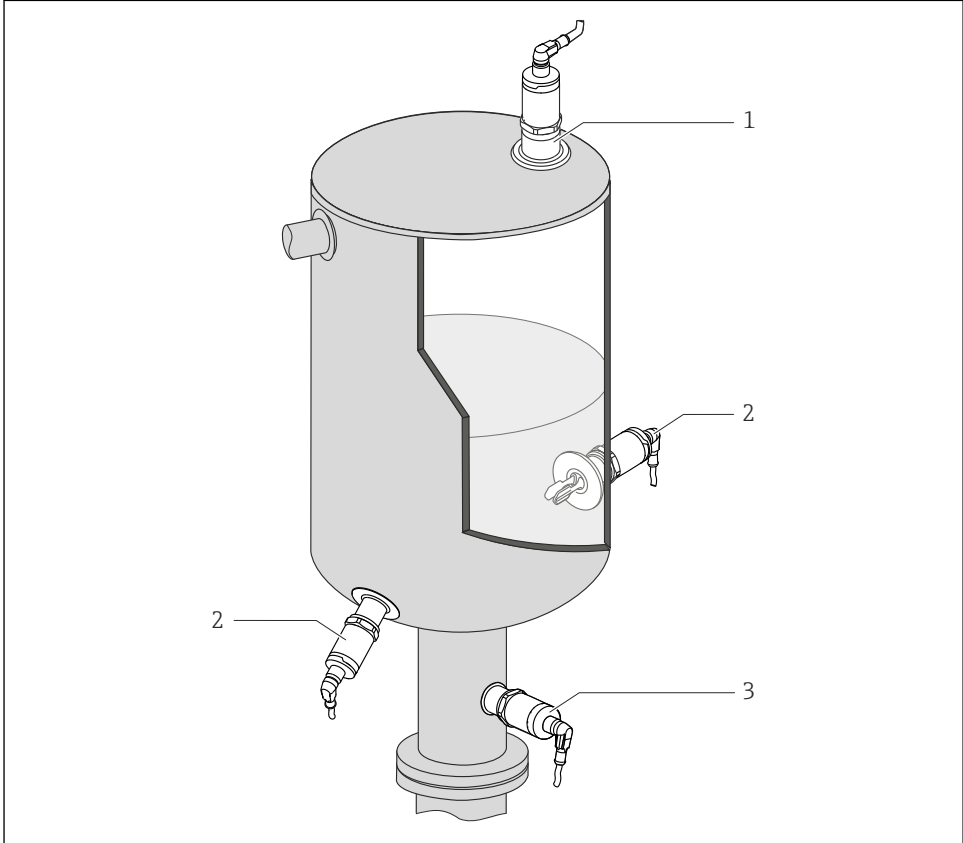

A0023118

14 Installation options

- 1 Overfill prevention or upper level detection
- 2 Lower level detection
- 3 Dry running protection for pump

5.1.2 Switch point

The switch point (A) on the sensor depends on the orientation of the point level switch (water +25 °C (+77 °F), 1 bar (14.5 psi)).

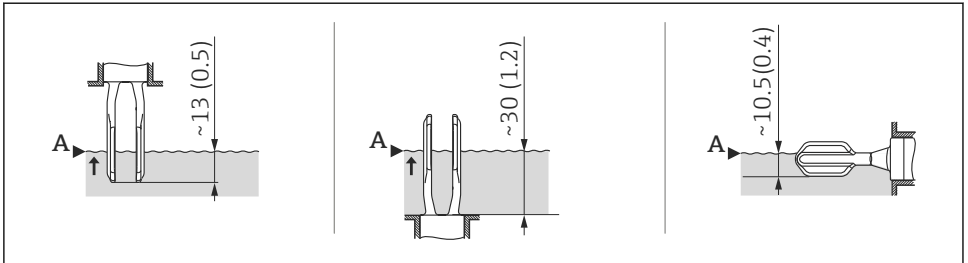

A0020734

15 Vertical and horizontal orientation, dimensions in mm (in)

5.1.3 Viscosity

Switching delays may occur in the case of highly viscous liquids. Ensure that the liquid can easily run off the tuning fork:

- If installing in vessels with high-viscosity liquids (A), the tuning fork may **not** be located in the installation socket!
- If installing in vessels with low-viscosity liquids (B), the tuning fork may be located in the installation socket!
- The installation nozzle must be no less than the minimum diameter of 50 mm (2.0 in).

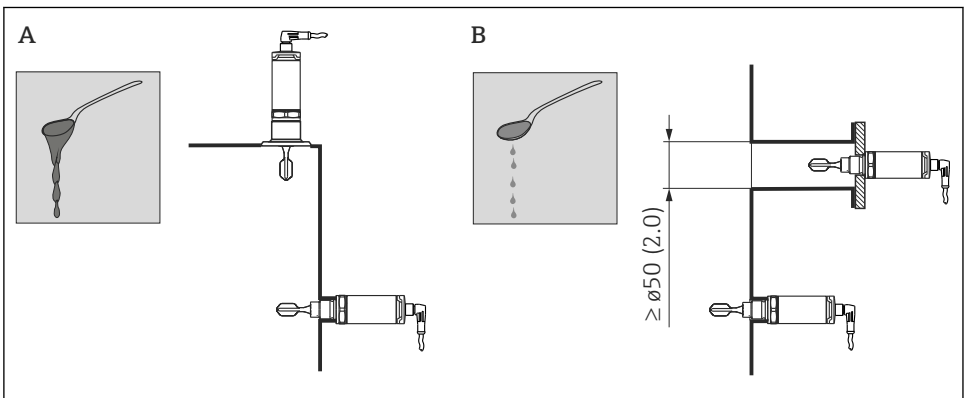

A0022054

16 Installation options with consideration given to the liquid viscosity, dimensions in mm (in)

A High viscosity (< 10 000 mPa·s)

B Low viscosity (< 2 000 mPa·s)

5.1.4 Buildup

Make sure that the installation socket does not exceed a certain length so that the tuning fork can project freely into the vessel.

Possibilities for optimization:

- A vertical orientation of the point level switch keeps buildup to a minimum.
- Preferably flush-mounted on vessels or in pipes.

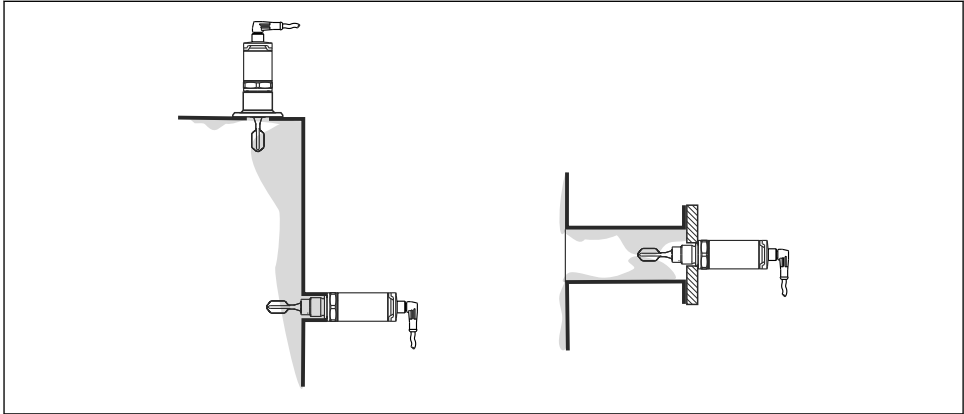

A0022057

17 *Buildup on tank wall, pipe wall and tuning fork*

5.1.5 Weld-in adapter with leakage hole

If installed horizontally, ensure that the leakage hole is pointing down. This allows leaks to be detected as quickly as possible.

5.1.6 Marking

The marking indicates the position of the tuning fork. If installed horizontally in vessels, the marking is face up.

The marking appears either as a material specification (e.g. 316L) or a thread designation (e.g. G 1/2") in the following locations:

- On the hexagonal bolt of the process adapter
- On the nameplate
- On the weld-in adapter

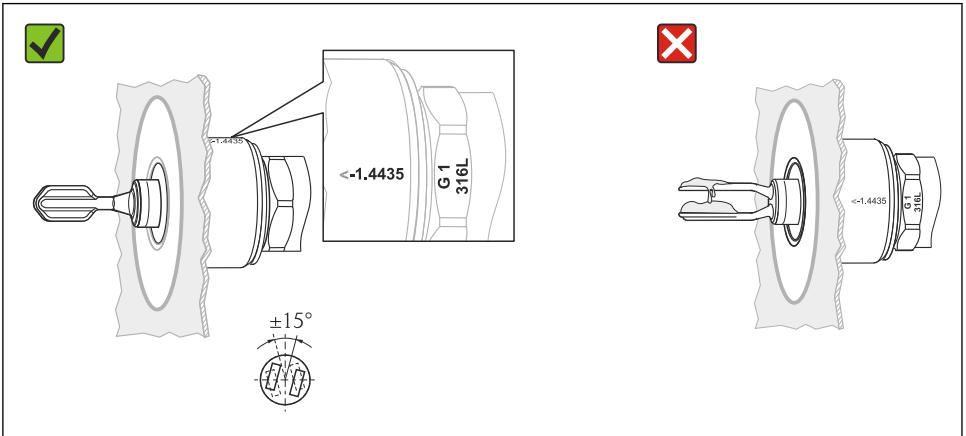

A0022641

18 Orientation in the vessel

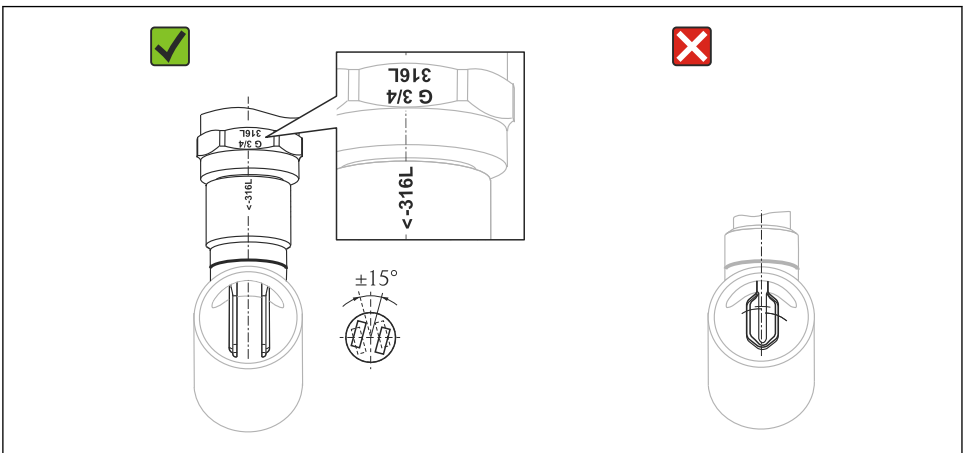

A0022804

19 Orientation in the pipe

5.1.7 Installation in pipes

During installation, pay attention to the position of the fork in order to minimize turbulence in the pipe.

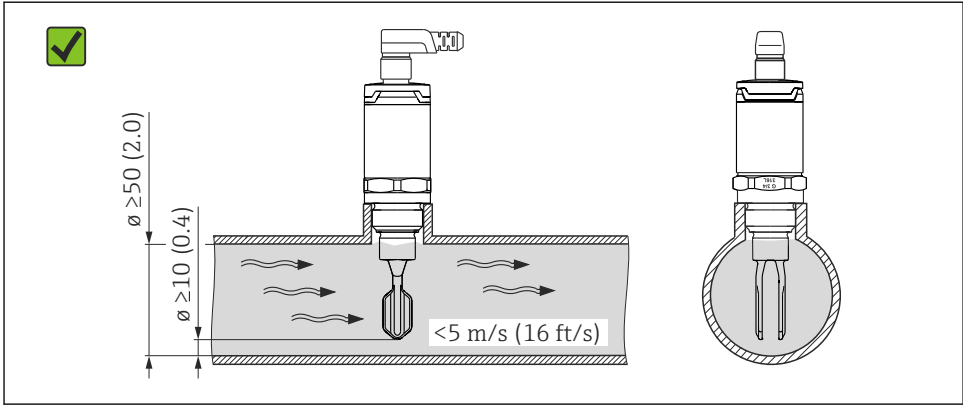

A0021357

Dimensions mm (in)

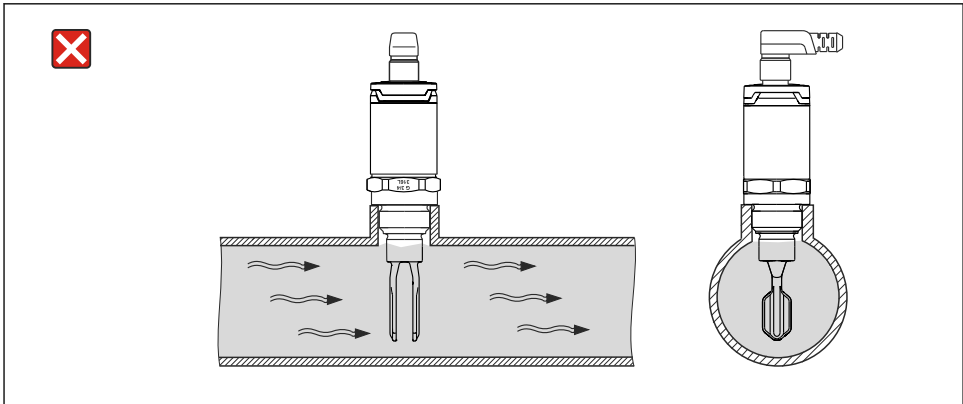

A0022268

5.1.8 Installation in vessels

If installed horizontally, pay attention to the position of the tuning fork to ensure that the liquid can drip off easily.

The electrical connection, e.g. M12 connector, should be pointing down with the cable. This can prevent moisture from penetrating.

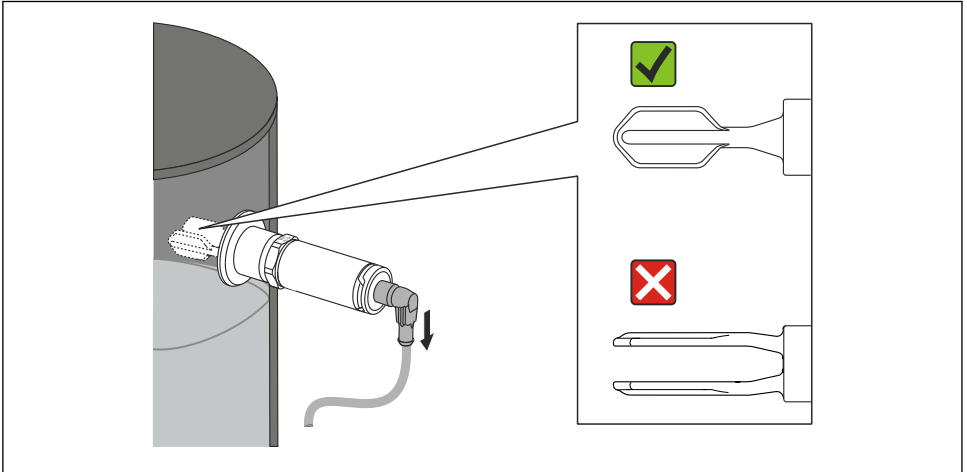

A0021034

20 Position of the fork in the case of horizontal installation in a vessel

5.1.9 Distance from wall

Ensure that there is sufficient distance between the expected buildup on the tank wall and the fork. Recommended distance from wall ≥ 10 mm (0.39 in).

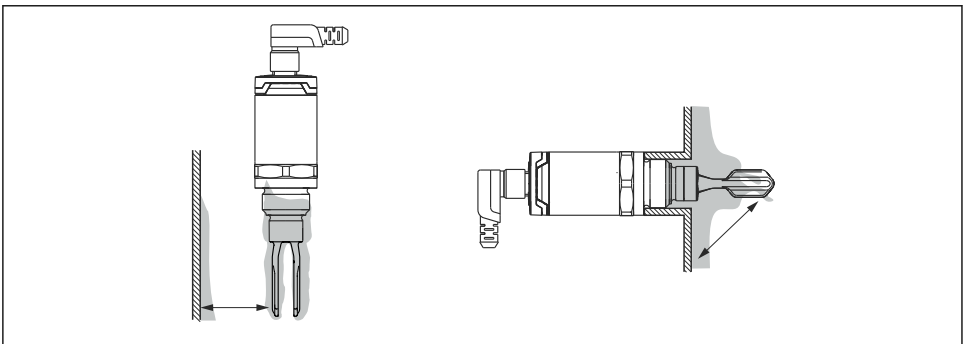

A0022272

5.2 Mounting the measuring device





i Service in accordance with WHG: Prior to mounting the device, pay attention to the WHG approval documents. The documents can be found in the Download Area of the Endress+Hauser website: www.endress.com → [Download](#)

5.2.1 Required tools

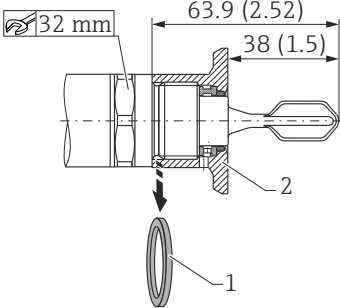
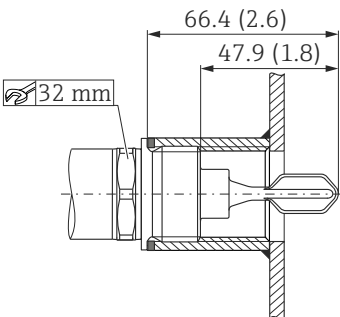
- Open-ended wrench: only turn by the hex bolt when screwing in.
Maximum torque: ≤ 30 Nm (22 lbf ft).
- Socket wrench: The socket wrench AF32 is available as an accessory → 65.

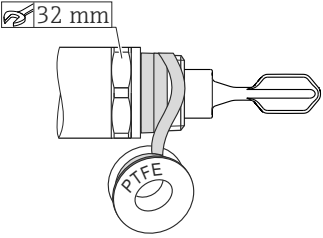
i Pay attention to the temperature and pressure specifications for seals and clips used at the customer site.

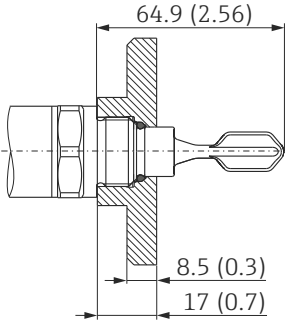
View, dimensions in mm (in)	Description
 <p style="text-align: right; font-size: small;">A0022025</p> <p>1 Flat seal 2 Weld-in adapter</p>	<p>Thread accessory weld-in adapter Example G 3/4"</p> <p>Pressure and temperature (maximum):</p> <ul style="list-style-type: none"> ▪ +25 bar (+362 psi) at +150 °C (+302 °F) ▪ +40 bar (+580 psi) at +100 °C (+212 °F) <p>i When using a weld-in adapter with flush-mounted seal, the flat seal (1) supplied must be removed from the thread.</p>
 <p style="text-align: right; font-size: small;">A0022026</p>	<p>Metric thread in customer nozzle</p> <p>Pressure and temperature (maximum): +40 bar (+580 psi) at +150 °C (+302 °F)</p>

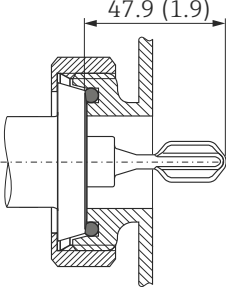
View, dimensions in mm (in)	Description
 <p style="text-align: right;">A0022028</p>	<p>NPT thread (ANSI B 1.20.1)</p> <p>Pressure and temperature (maximum): +40 bar (+580 psi) at +150 °C (+302 °F)</p> <p> Wrap in sealing material if necessary.</p>
 <p style="text-align: right;">A0022037</p>	<p>Thread M24x1.5 for flush-mounted installation in adapter</p> <p>Accessories: process adapter Temperature (maximum): +130 °C (+266 °F)</p> <p> Please pay attention to the different pressure ratings, see Technical Documentation TI01148F/00/EN</p> <p>Accessory: weld-in adapter Pressure and temperature (maximum): +25 bar (+362 psi) at +150 °C (+302 °F)</p>
 <p style="text-align: right;">A0022036</p>	<ul style="list-style-type: none"> ▪ DIN11851 DN25 PN40 (dairy pipe) ▪ DIN11851 DN32 PN40 (dairy pipe) ▪ DIN11851 DN40 PN40 (dairy pipe) <p>Pressure and temperature (maximum): +25 bar (+362 psi) at +150 °C (+302 °F) +40 bar (+580 psi) at +100 °C (+212 °F)</p>

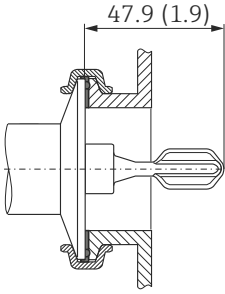
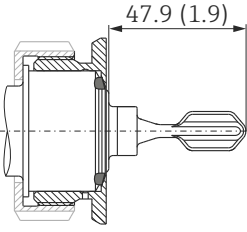
View, dimensions in mm (in)	Description
 <p style="text-align: right; font-size: small;">A0022035</p>	<p>Tri-Clamp ISO2852 DN25-38 (1 to 1 ½") DIN32676 DN25-40 Tri-Clamp ISO2852 DN40-51 (2") DIN32676 DN50</p> <p>Pressure and temperature (maximum): +25 bar (+362 psi) at +150 °C (+302 °F)</p> <p>NOTICE</p> <ul style="list-style-type: none"> ▶ Pay attention to the temperature and pressure specifications for the seals and clips used at the customer site.
 <p style="text-align: right; font-size: small;">A0022038</p>	<p>Flush-mounting in weld-in adapter RD52, tuning fork can be aligned</p> <p>With silicon seal and slotted nut</p> <p>Pressure and temperature (maximum):</p> <ul style="list-style-type: none"> ▪ +25 bar (+362 psi) at +150 °C (+302 °F) ▪ +40 bar (+580 psi) at +100 °C (+212 °F)

5.3 Post-installation check

○	Is the device undamaged (visual inspection)?
○	Does the device conform to the measuring point specifications? For example: <ul style="list-style-type: none"> ▪ Process temperature ▪ Process pressure ▪ Ambient temperature ▪ Switch point
○	Are the measuring point identification and labeling correct (visual inspection)?
○	Is the device adequately protected from precipitation and direct sunlight?
○	Is the device secured properly?

6 Electrical connection

The device has two operating modes: maximum safety (MAX) and minimum safety (MIN). By choosing the corresponding operating mode, the user ensures that the device also switches in a safety-oriented manner even in an alarm condition, e.g. if the power supply line is disconnected.

■ Maximum safety (MAX)

The device keeps the electronic switch closed as long as the liquid level is below the fork.
Sample application: overflow prevention

■ Minimum safety (MIN)

The device keeps the electronic switch closed as long as the fork is immersed in liquid.
Sample application: Dry running protection for pumps

The electronic switch opens if the limit is reached, if a fault occurs or the power fails (quiescent current principle).

6.1 Connecting the device





In accordance with IEC/EN61010 a separate circuit breaker must be provided for the device .

6.1.1 Electronic version 3-wire DC-PNP

Voltage source: non-hazardous contact voltage or Class 2 circuit (North America)

M12 connector

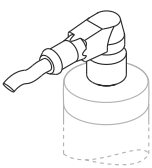
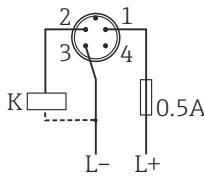
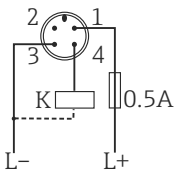
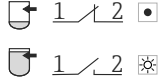
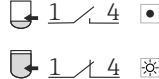
Depending on the analysis of the switch outputs, the device works in MAX oder MIN mode.

Electrical connection	Operating mode	
 <p>A0022901</p>	<p>MAX</p>  <p>A0022858</p>	<p>MIN</p>  <p>A0022859</p>
	 <p>A0021416</p>	 <p>A0021417</p>
<p>  Yellow LED (ye) not lit  Yellow LED (ye) lit K external load </p>		

Function monitoring with M12 connector

Using a two-channel analysis, function monitoring of the sensor can be implemented in addition to level monitoring, e.g. per relay switch, PLC, AS-i Bus I/O module, ...).

When both outputs are connected, the MIN and MAX outputs assume opposite states when the device is operating fault-free (XOR). In the event of an alarm condition or a line break, both outputs are deenergized.

Connection for function monitoring with antivalence		Yellow LED (ye)	Red LED (rd)
<p>A0022917</p>	<p>Sensor covered</p> <p>A0023016</p>	☀	•
	<p>Sensor exposed</p> <p>A0023029</p>	•	•
	<p>Fault</p> <p>A0023030</p>	•	☀
<p>☀ LED lit • LED not lit ⚡ Fault or warning K1 / K2 external load</p>			

Valve plug, cable

Depending on the assignment of the connector or the wiring of the cable, the device works in either the MAX or MIN operating mode.

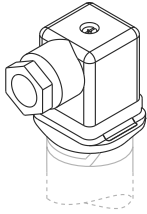
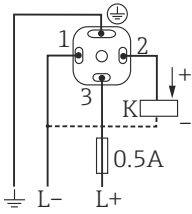
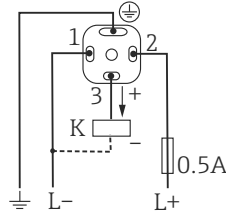
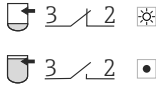
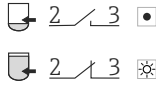
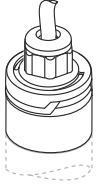
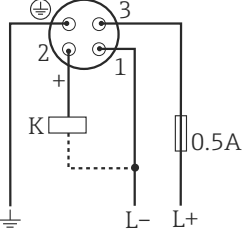
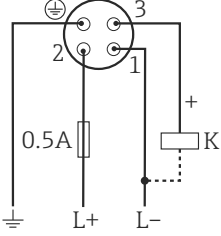
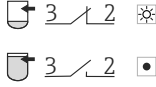
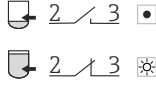
Electrical connection	Operating mode	
 <p>A0022900</p>	MAX	MIN
	 <p>A0021724</p>	 <p>A0021723</p>
	 <p>A0021413</p>	 <p>A0021414</p>
 <p>A0022902</p> <p>Core colors: 1 = BK (black) 2 = GR (gray) 3 = BN (brown) Ground = GNYE (green-yellow)</p>	MAX	MIN
	 <p>A0022226</p>	 <p>A0022227</p>
	 <p>A0021413</p>	 <p>A0021414</p>
<p> <input type="checkbox"/> Yellow LED (ye) not lit <input checked="" type="checkbox"/> Yellow LED (ye) lit K external load </p>		

6.1.2 Electronic version 2-wire AC/DC

Not suitable for connection to low-voltage PLC inputs!

Selection tool for relays

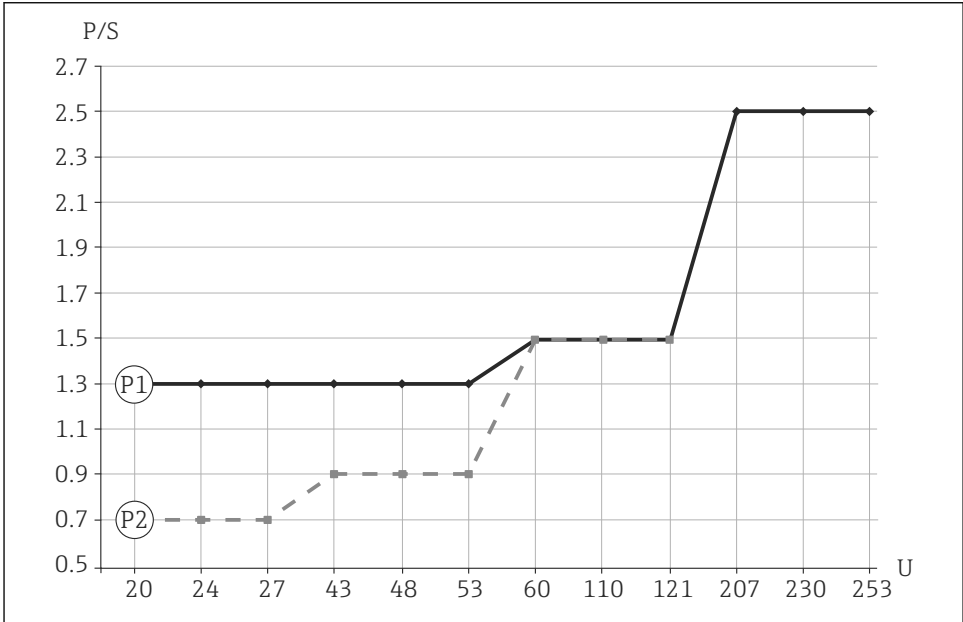

A0023486

21 Minimum rated power of the load

P/S Rated power in [W] / [VA]

U Operating voltage in [V]



Position	Supply voltage	Rated power	
		min	max
P1 AC mode	24 V	> 1.3 VA	< 6 VA
	110 V	> 1.5 VA	< 27.5 VA
	230 V	> 2.5 VA	< 57.5 VA
P2 DC mode	24 V	> 0.7 W	< 6 W
	48 V	> 0.9 W	< 12 W
	60 V	> 1.5 W	< 15 W

Relays with a lower rated power can be operated by means of an RC module connected in parallel (optional).

Valve plug, cable

Depending on the assignment of the connector or the wiring of the cable, the device works in either the MAX or MIN operating mode.

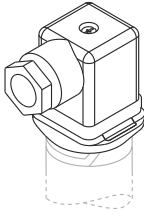
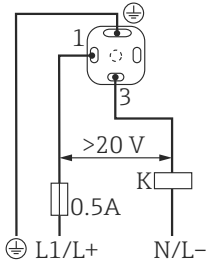
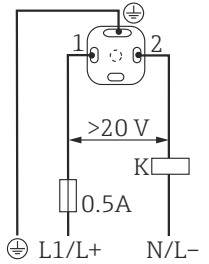
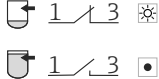
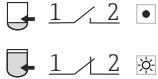
When the cable is wired, one wire of the cable does not have any function in each of the operating modes (gray in the case of MAX, and brown in the case of MIN). The cable with no function must be secured against inadvertent contact.

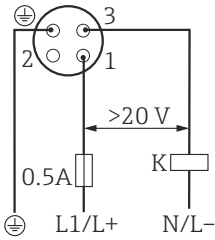
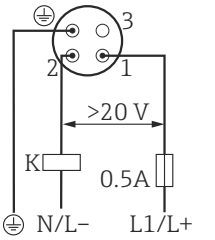
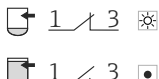
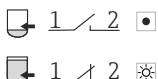
Electrical connection	Operating mode	
<p>Valve plug</p>  <p>A0022900</p>	<p>MAX</p>  <p>A0021219</p>	<p>MIN</p>  <p>A0021220</p>
	 <p>A0021418</p>	 <p>A0021420</p>
<p>Cable</p>  <p>A0022902</p>	 <p>A0022161</p>	 <p>A0022225</p>
<p>Core colors: 1 = BK (black) 2 = GR (gray) 3 = BN (brown) Ground = GNYE (green-yellow)</p>	 <p>A0021418</p>	 <p>A0021420</p>
<p> <input type="checkbox"/> Yellow LED (ye) not lit <input checked="" type="checkbox"/> Yellow LED (ye) lit K external load </p>		



6.2 Post-connection check

<input type="radio"/>	Is the device or cable undamaged (visual check)?
<input type="radio"/>	Do the cables comply with the requirements ?
<input type="radio"/>	Do the cables have adequate strain relief?
<input type="radio"/>	Are the cable glands mounted and firmly tightened?
<input type="radio"/>	Does the supply voltage match the specifications on the nameplate?
<input type="radio"/>	Is the wiring correct?
<input type="radio"/>	3-wire DC-PNP: If required, is the functional earth connected?
<input type="radio"/>	2-wire C/DC: Has the protective ground connection been established?
<input type="radio"/>	If supply voltage is present, is the green LED lit?

7 Commissioning

7.1 Function check

Before commissioning your measuring point, ensure that the post-installation and post-connection checks have been performed.

- "Post-installation check" checklist →  54
- "Post-connection check" checklist →  60



The function of the tuning fork can be easily tested by immersing the tuning fork in a vessel containing water.

7.2 LED display

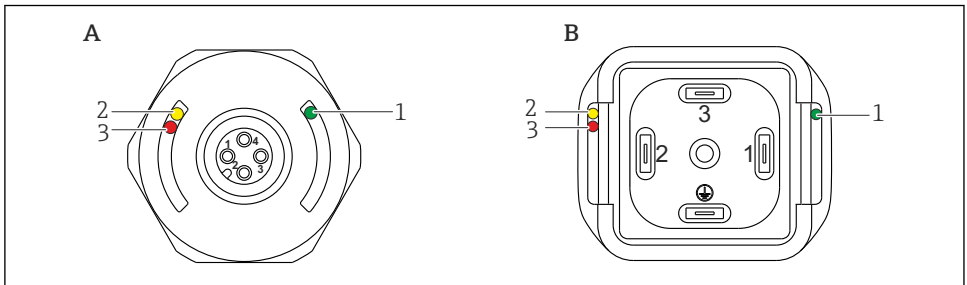

A0016856

A M12 connector, (cable without graphic)

























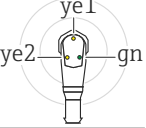





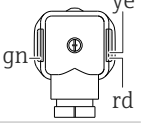



B Valve plug

Item	Function	Description
1	Green LED (gn) Lit	Device is operational
2	Yellow LED (ye) Lit	<p>M12 connector Indicates the sensor state: tuning fork is covered by liquid</p> <p>Valve plug / cable Indicates the switching state:</p> <ul style="list-style-type: none"> ▪ MAX operating mode (overflow prevention): sensor is not covered by liquid ▪ MIN operating mode (dry running protection): the sensor is covered by liquid
3	Red LED (rd) flashing Lit	Warning/maintenance required: error can be rectified, e.g. incorrect wiring Fault/device failure: error cannot be rectified, e.g. electronic error



For the metallic housing cover (IP69K), there is no external signaling via LEDs. A connecting cable with an M12 connector and LED display can be ordered as an accessory.

7.2.1 Function of LEDs

Connection	Operating modes					
	Maximum safety (MAX)		Minimum safety (MIN)		Warning	Fault
1 						
2 						
3 						
4 						
5 						
A0021223	A0021225	A0021226	A0021227	A0021228	A0022920	A0021229
1: Level display 2: M12 connector 3: M12 connector with LEDs 4: Valve plug 5: Cable			<ul style="list-style-type: none"> ● unlit ☀ lit ☀ flashing ⚡ fault/warning 			
LED colors: gn = green, ye = yellow, rd = red More information on LED display → 📖 61						

7.3 Function test with test magnet

⚠ WARNING

Risk of injury!

- Ensure that no dangerous processes are activated in the system.

To perform a function test, hold the test magnet against the marking on the nameplate (for at least 2 seconds). This inverts the current switching status and the yellow LED changes state. When the magnet is removed, the switching status valid at that time is adopted.

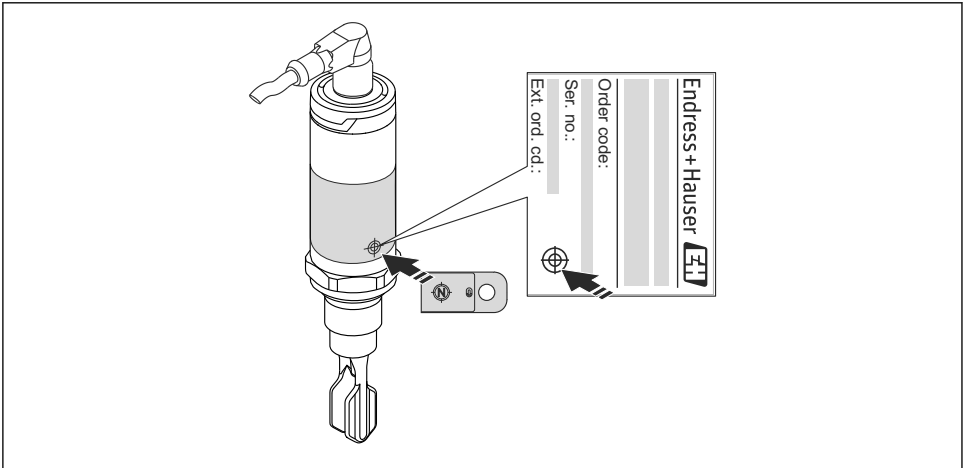

A0020960

 22 Test magnet and marking



The test magnet is not included in the delivery and can be ordered as an optional accessory. →  65

8 Diagnostics and troubleshooting

8.1 Diagnostic information via LED display

LED display on housing cover

Malfunction	Possible cause	Corrective action
Green LED Unlit	No power supply	Check connector, cable and power supply
Red LED flashing	Overload or short-circuit in load circuit	<ul style="list-style-type: none"> ▪ Rectify short-circuit ▪ Reduce maximum load current to below 250 mA
Red LED Lit	Internal sensor failure or sensor corroded	Replace device

LED display on M12 connector (available as an accessory)

Malfunction	Possible cause	Corrective action
Green LED Unlit	No power supply	Check connector, cable and power supply
Yellow LED Unlit	Internal sensor failure or sensor corroded	<ul style="list-style-type: none"> ▪ Check cable ▪ Reduce maximum load current to below 250 mA ▪ Replace device
Yellow LED both lit		

Connection: 2-wire AC/DC to 20 to 253 V DC

Malfunction	Possible cause	Corrective action
Unexpected behavior of yellow LED	Incorrect connector assignment or incorrect cable wiring	<p>Pay attention to the polarity of the power supply!</p> <p>Correct connection: Valve plug: L+ to PIN1, L- to PIN 3 Cable: L+ BK (black), L- BN (brown)</p> <p>Result</p> <ul style="list-style-type: none"> ▪ Tuning fork covered: yellow LED lit. ▪ Tuning fork not covered: yellow LED not lit.

9 Maintenance

No special maintenance work is required.

9.1 Cleaning

The sensor must be cleaned if necessary. It can also be cleaned while installed (e.g. CIP Cleaning in Place / SIP Sterilization in Place). Care must be taken to ensure that no damage occurs to the sensor in the process.

10 Repair

Repair is not envisaged for the point level switch.

10.1 Spare parts

The web site for the W@M Device Viewer (www.endress.com/deviceviewer): All spare parts for the measuring device are listed here together with the order code and can be ordered here. If available, users can also download the associated Installation Instructions.

10.2 Return

The measuring device must be returned if repairs or a factory calibration are required, or if the wrong measuring device has been ordered or delivered. According to legal regulations, Endress+Hauser, as an ISO-certified company, is required to follow certain procedures when handling returned products that are in contact with medium.

To ensure swift, safe and professional device returns, please read the return procedures and conditions on the Endress+Hauser website at www.services.endress.com/return-material

10.3 Disposal

When disposing, separate and recycle the device components based on the materials.

11 Accessories



Detailed information on accessories can be found in the technical documentation TI01148F.

Designation	Additional information
Weld-in adapter	Detailed information can be found in TI00426F/00/EN "Weld-in adapter and flanges" and in the supplementary documentation → 39.
Seals, o-rings	
Process adapter M24	Detailed information can be found in TI01148F/00/EN.
Slotted nut	
Plug-in jack M12 with cable 5 m (16 ft)	<ul style="list-style-type: none"> ■ IP69K, coupling nut 316L <ul style="list-style-type: none"> - Elbowed 90° with LED, order number: 52018763 - Elbowed 90° without LED, order number: 52024216 ■ IP67, coupling nut (Cu Sn/Ni) <ul style="list-style-type: none"> - Elbowed 90°, order number: 52010285 - Straight, order number: 52006263
Socket wrench for mounting	Hexagon bolt, AF32, order number: 52010156
Test magnet	Order number: 71267011

12 Technical data

 Further information on the technical data is provided in Technical Documentation TI01148F/00/EN.

12.1 Power supply

Electronic version	Supply voltage	Power consumption	Current consumption
3-wire DC-PNP	10 to 30 V DC	< 975 mW	< 15 mA
2-wire AC/DC	20 to 253 V	< 850 mW	< 3.8 mA

12.2 Environment

Ambient temperature range	-40 to +70 °C (-40 to +158 °F), see derating →  67
Storage temperature	-40 to +85 °C (-40 to +185 °F)
Climate class	DIN EN 60068-2-38/IEC 68-2-38: test Z/AD
Altitude	Up to 2 000 m (6 600 ft) above sea level
Shock resistance	a = 300 m/s ² = 30 g, 3 planes x 2 directions x 3 shocks x 18 ms, as per test Ea, prEN 60068-2-27:2007
Vibration resistance	a(RMS) = 50 m/s ² , ASD = 1.25 (m/s ²) ² /Hz, f = 5 to 2000 Hz, t = 3 x 2 h, as per test Fh, EN 60068-2-64:2008
Reverse polarity protection	<p>2-wire AC/DC</p> <ul style="list-style-type: none"> ▪ AC mode: the device has reverse polarity protection. ▪ DC mode: in the event of reverse polarity the maximum safety mode is always detected. Check the wiring and perform a function check before commissioning. The device is not damaged in the event of reverse polarity. <p>3-wire DC-PNP Integrated. In the event of reverse polarity, the device is deactivated automatically.</p>
Short-circuit protection	<p>2-wire AC/DC During switching the sensor checks whether a load, e.g. relay or contactor, is present (load check). If an error occurs, the sensor is not damaged. Smart monitoring: normal operation is resumed once the error is fixed.</p> <p>3-wire DC-PNP Overload protection/short-circuit protection at I > 250 mA; the sensor is not destroyed. Smart monitoring: check for overload in intervals of approx. 1.5 s; normal operation is resumed once the overload/short-circuit is fixed.</p>

Degree of protection	<ul style="list-style-type: none"> ■ IP65/67 NEMA Type 4X Enclosure (M12 connector) ■ IP66/68/69K NEMA Type 4X/6P Enclosure (M12 connector for metal housing cover) ■ IP65 NEMA Type 4X Enclosure (valve plug) ■ IP66/68 NEMA Type 4X/6P Enclosure (cable)
Electromagnetic compatibility	<p>Electromagnetic compatibility in accordance with all relevant requirements of the EN 61326 series and NAMUR recommendation EMC (NE21). For details, refer to the EC Declaration of Conformity.</p> <p>Available in the Download Area of the Endress+Hauser website: www.endress.com.</p>

12.2.1 Derating

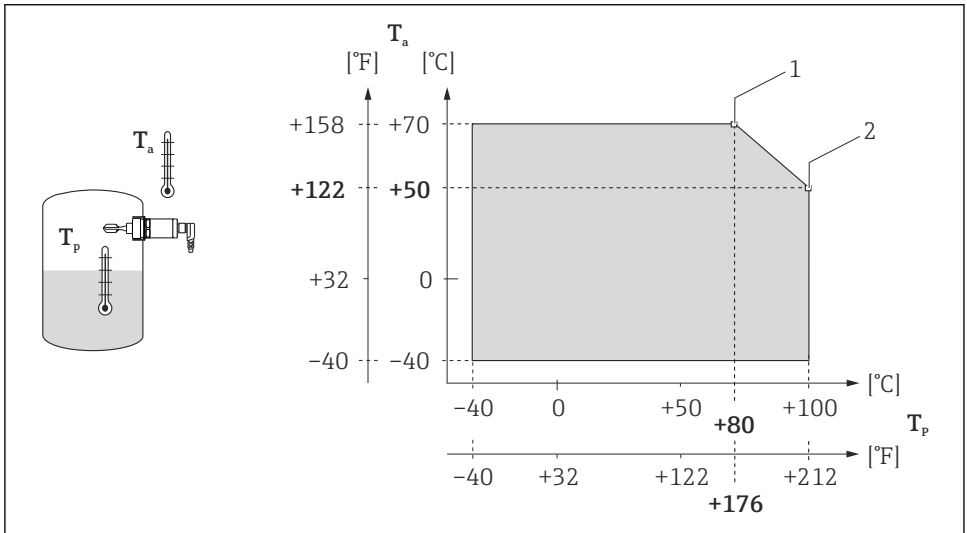

A0022002

23 Derating curve: 100 °C (212 °F)

1 I_{max} : 200 mA (DC-PNP), 250 mA (AC/DC)

2 I_{max} : 150 mA (DC-PNP), 150 mA (AC/DC)

T_a Ambient temperature

T_p Process temperature

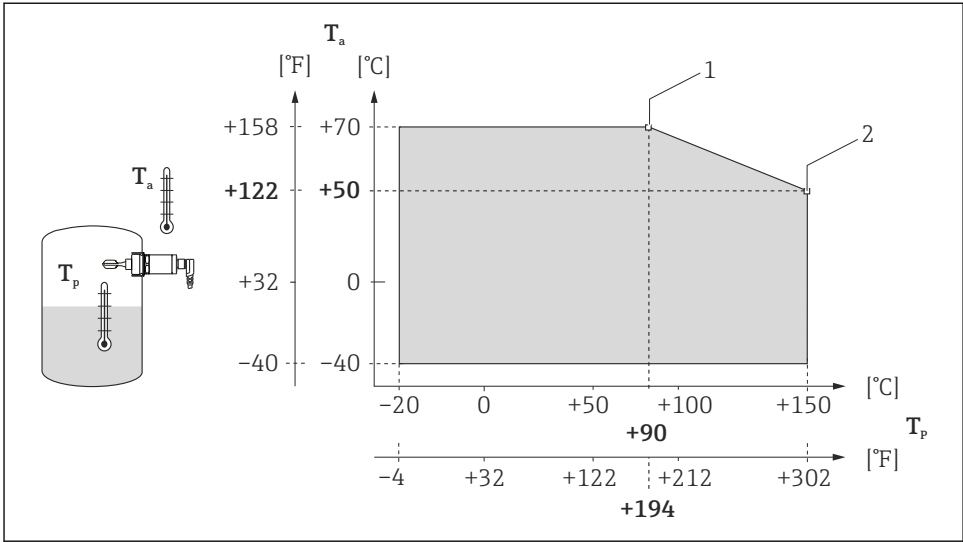

A0020869

24 Derating curve: 150 °C (302 °F)

1 I_{max} : 200 mA (DC-PNP), 250 mA (AC/DC)

2 I_{max} : 150 mA (DC-PNP), 150 mA (AC/DC)

Ta Ambient temperature

Tp Process temperature

12.3 Process

NOTICE

► Pay attention to the pressure and temperature derating depending on the selected process connection .

Process temperature range	-40 to +100 °C (-40 to +212 °F) -40 to +150 °C (-40 to +302 °F)
Process pressure range	Max. -1 to +40 bar (-14.5 to +580 psi)
Density	> 0.7 g/cm ³ (optionally available: > 0.5 g/cm ³)
State of aggregation	Liquid
Viscosity	1 to 10,000 mPa · s dynamic viscosity
Solids contents	ø < 5 mm (0.2 in)
Lateral loading capacity	Lateral loading capacity of the tuning fork: max. 200 N



71279309

www.addresses.endress.com
