

# Operating Instructions

## Proline Promass G 100

### EtherNet/IP

Coriolis flowmeter

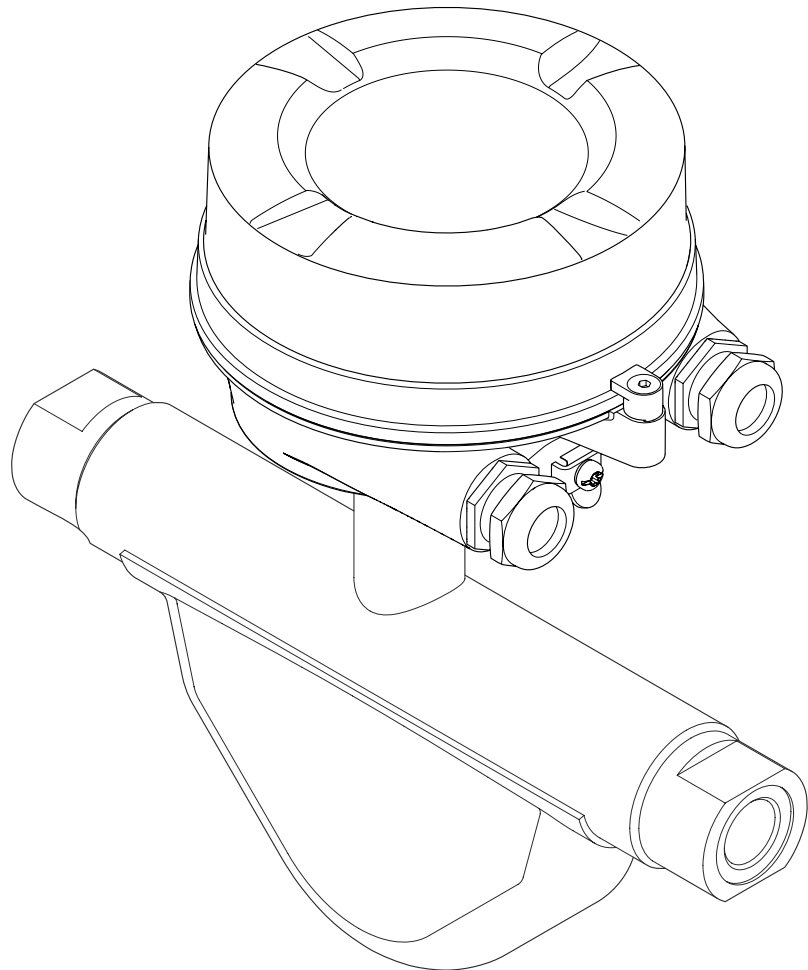

- Make sure the document is stored in a safe place such that it is always available when working on or with the device.
- To avoid danger to individuals or the facility, read the "Basic safety instructions" section carefully, as well as all other safety instructions in the document that are specific to working procedures.
- The manufacturer reserves the right to modify technical data without prior notice. Your Endress+Hauser Sales Center will supply you with current information and updates to these Instructions.

## Table of contents

<b>1</b>	<b>Document information</b> . . . . .	<b>5</b>	6.2	Mounting the measuring device . . . . .	21
1.1	Document function . . . . .	5	6.2.1	Required tools . . . . .	21
1.2	Symbols used . . . . .	5	6.2.2	Preparing the measuring device . . . . .	21
1.2.1	Safety symbols . . . . .	5	6.2.3	Mounting the measuring device . . . . .	22
1.2.2	Electrical symbols . . . . .	5	6.2.4	Turning the display module . . . . .	22
1.2.3	Tool symbols . . . . .	5	6.3	Post-installation check . . . . .	22
1.2.4	Symbols for certain types of information . . . . .	6	<b>7</b>	<b>Electrical connection</b> . . . . .	<b>24</b>
1.2.5	Symbols in graphics . . . . .	6	7.1	Connection conditions . . . . .	24
1.3	Documentation . . . . .	6	7.1.1	Required tools . . . . .	24
1.3.1	Standard documentation . . . . .	7	7.1.2	Requirements for connecting cable . . . . .	24
1.3.2	Supplementary device-dependent documentation . . . . .	7	7.1.3	Terminal assignment . . . . .	25
1.4	Registered trademarks . . . . .	7	7.1.4	Pin assignment, device plug . . . . .	26
<b>2</b>	<b>Basic safety instructions</b> . . . . .	<b>8</b>	7.1.5	Preparing the measuring device . . . . .	26
2.1	Requirements for the personnel . . . . .	8	7.2	Connecting the measuring device . . . . .	26
2.2	Designated use . . . . .	8	7.2.1	Connecting the transmitter . . . . .	27
2.3	Workplace safety . . . . .	9	7.3	Special connection instructions . . . . .	28
2.4	Operational safety . . . . .	9	7.3.1	Connection examples . . . . .	28
2.5	Product safety . . . . .	9	7.4	Hardware settings . . . . .	28
2.6	IT security . . . . .	9	7.4.1	Setting the device address . . . . .	28
<b>3</b>	<b>Product description</b> . . . . .	<b>11</b>	7.5	Ensuring the degree of protection . . . . .	29
3.1	Product design . . . . .	11	7.6	Post-connection check . . . . .	30
3.1.1	Device version with EtherNet/IP communication type . . . . .	11	<b>8</b>	<b>Operation options</b> . . . . .	<b>31</b>
<b>4</b>	<b>Incoming acceptance and product identification</b> . . . . .	<b>12</b>	8.1	Overview of operation options . . . . .	31
4.1	Incoming acceptance . . . . .	12	8.2	Structure and function of the operating menu . . . . .	32
4.2	Product identification . . . . .	12	8.2.1	Structure of the operating menu . . . . .	32
4.2.1	Transmitter nameplate . . . . .	13	8.2.2	Operating philosophy . . . . .	33
4.2.2	Sensor nameplate . . . . .	13	8.3	Access to the operating menu via the Web browser . . . . .	33
4.2.3	Symbols on measuring device . . . . .	14	8.3.1	Function range . . . . .	33
<b>5</b>	<b>Storage and transport</b> . . . . .	<b>15</b>	8.3.2	Prerequisites . . . . .	34
5.1	Storage conditions . . . . .	15	8.3.3	Establishing a connection . . . . .	34
5.2	Transporting the product . . . . .	15	8.3.4	Logging on . . . . .	35
5.2.1	Measuring devices without lifting lugs . . . . .	15	8.3.5	User interface . . . . .	36
5.2.2	Measuring devices with lifting lugs . . . . .	16	8.3.6	Disabling the Web server . . . . .	37
5.2.3	Transporting with a fork lift . . . . .	16	8.3.7	Logging out . . . . .	37
5.3	Packaging disposal . . . . .	16	8.4	Access to the operating menu via the operating tool . . . . .	38
<b>6</b>	<b>Installation</b> . . . . .	<b>17</b>	8.4.1	Connecting the operating tool . . . . .	38
6.1	Mounting requirements . . . . .	17	8.4.2	FieldCare . . . . .	39
6.1.1	Mounting position . . . . .	17	<b>9</b>	<b>System integration</b> . . . . .	<b>41</b>
6.1.2	Requirements from environment and process . . . . .	18	9.1	Overview of device description files . . . . .	41
6.1.3	Special mounting instructions . . . . .	20	9.1.1	Current version data for the device . . . . .	41
			9.1.2	Operating tools . . . . .	41
			9.2	Overview of system files . . . . .	41
			9.3	Integrating the measuring device in the system . . . . .	42
			9.4	Cyclic data transmission . . . . .	42
			9.4.1	Block model . . . . .	42
			9.4.2	Input and output groups . . . . .	42

<b>10</b>	<b>Commissioning</b> .....	<b>46</b>		
10.1	Function check .....	46		
10.2	Configuring the device address via software ..	46		
10.2.1	Ethernet network and Web server ...	46		
10.3	Configuring the measuring device .....	46		
10.3.1	Defining the tag name .....	47		
10.3.2	Setting the system units .....	47		
10.3.3	Selecting and setting the medium ...	49		
10.3.4	Configuring the communication interface .....	50		
10.3.5	Configuring the low flow cut off .....	51		
10.3.6	Configuring the partial filled pipe detection .....	52		
10.4	Advanced settings .....	53		
10.4.1	Calculated values .....	53		
10.4.2	Carrying out a sensor adjustment ...	54		
10.4.3	Configuring the totalizer .....	55		
10.4.4	Carrying out additional display configurations .....	56		
10.5	Simulation .....	58		
10.6	Protecting settings from unauthorized access .....	59		
10.6.1	Write protection via access code .....	59		
10.6.2	Write protection via write protection switch .....	60		
<b>11</b>	<b>Operation</b> .....	<b>62</b>		
11.1	Read out and modify current Ethernet settings .....	62		
11.2	Reading device locking status .....	62		
11.3	Reading measured values .....	63		
11.3.1	Process variables .....	63		
11.3.2	Totalizer .....	63		
11.3.3	Output values .....	64		
11.4	Adapting the measuring device to the process conditions .....	65		
11.5	Performing a totalizer reset .....	65		
<b>12</b>	<b>Diagnostics and troubleshooting</b> ...	<b>67</b>		
12.1	General troubleshooting .....	67		
12.2	Diagnostic information via light emitting diodes .....	68		
12.2.1	Transmitter .....	68		
12.3	Diagnostic information in the Web browser ..	69		
12.3.1	Diagnostic options .....	69		
12.3.2	Calling up remedy information .....	70		
12.4	Diagnostic information in FieldCare .....	70		
12.4.1	Diagnostic options .....	70		
12.4.2	Calling up remedy information .....	71		
12.5	Diagnostic information via communication interface .....	71		
12.5.1	Reading out diagnostic information ..	71		
12.6	Adapting the diagnostic information .....	72		
12.6.1	Adapting the diagnostic behavior ...	72		
12.7	Overview of diagnostic information .....	72		
12.8	Pending diagnostic events .....	74		
12.9	Diagnostic list .....	75		
12.10	Event logbook .....	75		
12.10.1	Event history .....	75		
12.10.2	Filtering the event logbook .....	76		
12.10.3	Overview of information events .....	76		
12.11	Resetting the measuring device .....	77		
12.12	Device information .....	77		
12.13	Firmware history .....	79		
<b>13</b>	<b>Maintenance</b> .....	<b>80</b>		
13.1	Maintenance tasks .....	80		
13.1.1	Exterior cleaning .....	80		
13.2	Measuring and test equipment .....	80		
13.3	Endress+Hauser services .....	80		
<b>14</b>	<b>Repair</b> .....	<b>81</b>		
14.1	General notes .....	81		
14.2	Spare parts .....	81		
14.3	Endress+Hauser services .....	81		
14.4	Return .....	81		
14.5	Disposal .....	81		
14.5.1	Removing the measuring device .....	81		
14.5.2	Disposing of the measuring device ...	82		
<b>15</b>	<b>Accessories</b> .....	<b>83</b>		
15.1	Service-specific accessories .....	83		
<b>16</b>	<b>Technical data</b> .....	<b>84</b>		
16.1	Application .....	84		
16.2	Function and system design .....	84		
16.3	Input .....	84		
16.4	Output .....	85		
16.5	Power supply .....	88		
16.6	Performance characteristics .....	89		
16.7	Installation .....	92		
16.8	Environment .....	92		
16.9	Process .....	93		
16.10	Mechanical construction .....	94		
16.11	Operability .....	96		
16.12	Certificates and approvals .....	98		
16.13	Application packages .....	99		
16.14	Accessories .....	99		
16.15	Documentation .....	99		
<b>17</b>	<b>Appendix</b> .....	<b>101</b>		
17.1	Overview of the operating menu .....	101		
17.1.1	"Operation" menu .....	101		
17.1.2	"Setup" menu .....	102		
17.1.3	"Diagnostics" menu .....	106		
17.1.4	"Expert" menu .....	110		
	<b>Index</b> .....	<b>127</b>		





# 1 Document information

## 1.1 Document function







These Operating Instructions contain all the information that is required in various phases of the life cycle of the device: from product identification, incoming acceptance and storage, to mounting, connection, operation and commissioning through to troubleshooting, maintenance and disposal.

## 1.2 Symbols used



### 1.2.1 Safety symbols

Symbol	Meaning
	<b>DANGER!</b> This symbol alerts you to a dangerous situation. Failure to avoid this situation will result in serious or fatal injury.
	<b>WARNING!</b> This symbol alerts you to a dangerous situation. Failure to avoid this situation can result in serious or fatal injury.
	<b>CAUTION!</b> This symbol alerts you to a dangerous situation. Failure to avoid this situation can result in minor or medium injury.
	<b>NOTE!</b> This symbol contains information on procedures and other facts which do not result in personal injury.











### 1.2.2 Electrical symbols

Symbol	Meaning	Symbol	Meaning
	Direct current		Alternating current
	Direct current and alternating current		<b>Ground connection</b> A grounded terminal which, as far as the operator is concerned, is grounded via a grounding system.
	<b>Protective ground connection</b> A terminal which must be connected to ground prior to establishing any other connections.		<b>Equipotential connection</b> A connection that has to be connected to the plant grounding system: This may be a potential equalization line or a star grounding system depending on national or company codes of practice.





### 1.2.3 Tool symbols

Symbol	Meaning
	Allen key
	Open-ended wrench



### 1.2.4 Symbols for certain types of information

Symbol	Meaning
	<b>Permitted</b> Procedures, processes or actions that are permitted.
	<b>Preferred</b> Procedures, processes or actions that are preferred.
	<b>Forbidden</b> Procedures, processes or actions that are forbidden.
	<b>Tip</b> Indicates additional information.
	Reference to documentation
	Reference to page
	Reference to graphic
	Series of steps
	Result of a sequence of actions
	Help in the event of a problem
	Visual inspection

### 1.2.5 Symbols in graphics

Symbol	Meaning	Symbol	Meaning
1, 2, 3,...	Item numbers		Series of steps
A, B, C, ...	Views		Sections
	Hazardous area		Safe area (non-hazardous area)
	Flow direction		

## 1.3 Documentation

-  For an overview of the scope of the associated Technical Documentation, refer to the following:
- The CD-ROM provided for the device (depending on the device version, the CD-ROM might not be part of the delivery!)
  - The *W@M Device Viewer* : Enter the serial number from the nameplate ([www.endress.com/deviceviewer](http://www.endress.com/deviceviewer))
  - The *Endress+Hauser Operations App*: Enter the serial number from the nameplate or scan the 2-D matrix code (QR code) on the nameplate.
-  For a detailed list of the individual documents along with the documentation code

### 1.3.1 Standard documentation

Document type	Purpose and content of the document
Technical Information	<b>Planning aid for your device</b> The document contains all the technical data on the device and provides an overview of the accessories and other products that can be ordered for the device.
Brief Operating Instructions	<b>Guide that takes you quickly to the 1st measured value</b> The Brief Operating Instructions contain all the essential information from incoming acceptance to initial commissioning.

### 1.3.2 Supplementary device-dependent documentation

Additional documents are supplied depending on the device version ordered: Always comply strictly with the instructions in the supplementary documentation. The supplementary documentation is an integral part of the device documentation.

## 1.4 Registered trademarks

#### **EtherNet/IP™**

Trademark of ODVA, Inc.

#### **Microsoft®**

Registered trademark of the Microsoft Corporation, Redmond, Washington, USA

#### **Applicator®, FieldCare®, Field Xpert™, HistoROM®, Heartbeat Technology™**

Registered or registration-pending trademarks of the Endress+Hauser Group

## 2 Basic safety instructions

### 2.1 Requirements for the personnel

The personnel for installation, commissioning, diagnostics and maintenance must fulfill the following requirements:

- ▶ Trained, qualified specialists must have a relevant qualification for this specific function and task
- ▶ Are authorized by the plant owner/operator
- ▶ Are familiar with federal/national regulations
- ▶ Before beginning work, the specialist staff must have read and understood the instructions in the Operating Instructions and supplementary documentation as well as in the certificates (depending on the application)
- ▶ Following instructions and basic conditions

The operating personnel must fulfill the following requirements:

- ▶ Being instructed and authorized according to the requirements of the task by the facility's owner-operator
- ▶ Following the instructions in these Operating Instructions

### 2.2 Designated use

#### Application and media

The measuring device described in these Instructions is intended only for flow measurement of liquids and gases.

Depending on the version ordered, the measuring device can also measure potentially explosive, flammable, poisonous and oxidizing media.

Measuring devices for use in hazardous areas, in hygienic applications or in applications where there is an increased risk due to process pressure, are labeled accordingly on the nameplate.

To ensure that the measuring device remains in proper condition for the operation time:

- ▶ Only use the measuring device in full compliance with the data on the nameplate and the general conditions listed in the Operating Instructions and supplementary documentation.
- ▶ Based on the nameplate, check whether the ordered device is permitted for the intended use in the hazardous area (e.g. explosion protection, pressure vessel safety).
- ▶ Use the measuring device only for media against which the process-wetted materials are adequately resistant.
- ▶ If the measuring device is not operated at atmospheric temperature, compliance with the relevant basic conditions specified in the associated device documentation is absolutely essential: "Documentation" section (→  6).

#### Incorrect use

Non-designated use can compromise safety. The manufacturer is not liable for damage caused by improper or non-designated use.

#### **WARNING**

#### **Danger of breakage of the measuring tube due to corrosive or abrasive fluids.**

Housing breakage due to mechanical overload possible!

- ▶ Verify the compatibility of the process fluid with the measuring tube material.
- ▶ Ensure the resistance of all fluid-wetted materials in the process.
- ▶ Observe the specified pressure and temperature range.

Verification for borderline cases:

- ▶ For special fluids and fluids for cleaning, Endress+Hauser is glad to provide assistance in verifying the corrosion resistance of fluid-wetted materials, but does not accept any



warranty or liability as minute changes in the temperature, concentration or level of contamination in the process can alter the corrosion resistance properties.

#### **Residual risks**

The external surface temperature of the housing can increase by max. 20 K due to the power consumption of the electronic components. Hot process fluids passing through the measuring device will further increase the surface temperature of the housing. The surface of the sensor, in particular, can reach temperatures which are close to the fluid temperature.

Possible burn hazard due to fluid temperatures!

- ▶ For elevated fluid temperature, ensure protection against contact to prevent burns.

## **2.3 Workplace safety**

For work on and with the device:

- ▶ Wear the required personal protective equipment according to federal/national regulations.

For welding work on the piping:

- ▶ Do not ground the welding unit via the measuring device.

If working on and with the device with wet hands:

- ▶ It is recommended to wear gloves on account of the higher risk of electric shock.

## **2.4 Operational safety**

Risk of injury.

- ▶ Operate the device in proper technical condition and fail-safe condition only.
- ▶ The operator is responsible for interference-free operation of the device.

#### **Conversions to the device**

Unauthorized modifications to the device are not permitted and can lead to unforeseeable dangers.

- ▶ If, despite this, modifications are required, consult with Endress+Hauser.

#### **Repair**

To ensure continued operational safety and reliability,

- ▶ Carry out repairs on the device only if they are expressly permitted.
- ▶ Observe federal/national regulations pertaining to repair of an electrical device.
- ▶ Use original spare parts and accessories from Endress+Hauser only.

## **2.5 Product safety**

This measuring device is designed in accordance with good engineering practice to meet state-of-the-art safety requirements, has been tested, and left the factory in a condition in which it is safe to operate.

It meets general safety standards and legal requirements. It also complies with the EC directives listed in the device-specific EC Declaration of Conformity. Endress+Hauser confirms this by affixing the CE mark to the device.

## **2.6 IT security**

We only provide a warranty if the device is installed and used as described in the Operating Instructions. The device is equipped with security mechanisms to protect it against any inadvertent changes to the device settings.

IT security measures in line with operators' security standards and designed to provide additional protection for the device and device data transfer must be implemented by the operators themselves.

### 3 Product description

The device consists of a transmitter and a sensor.

One device version is available: compact version - transmitter and sensor form a mechanical unit.

#### 3.1 Product design

##### 3.1.1 Device version with EtherNet/IP communication type

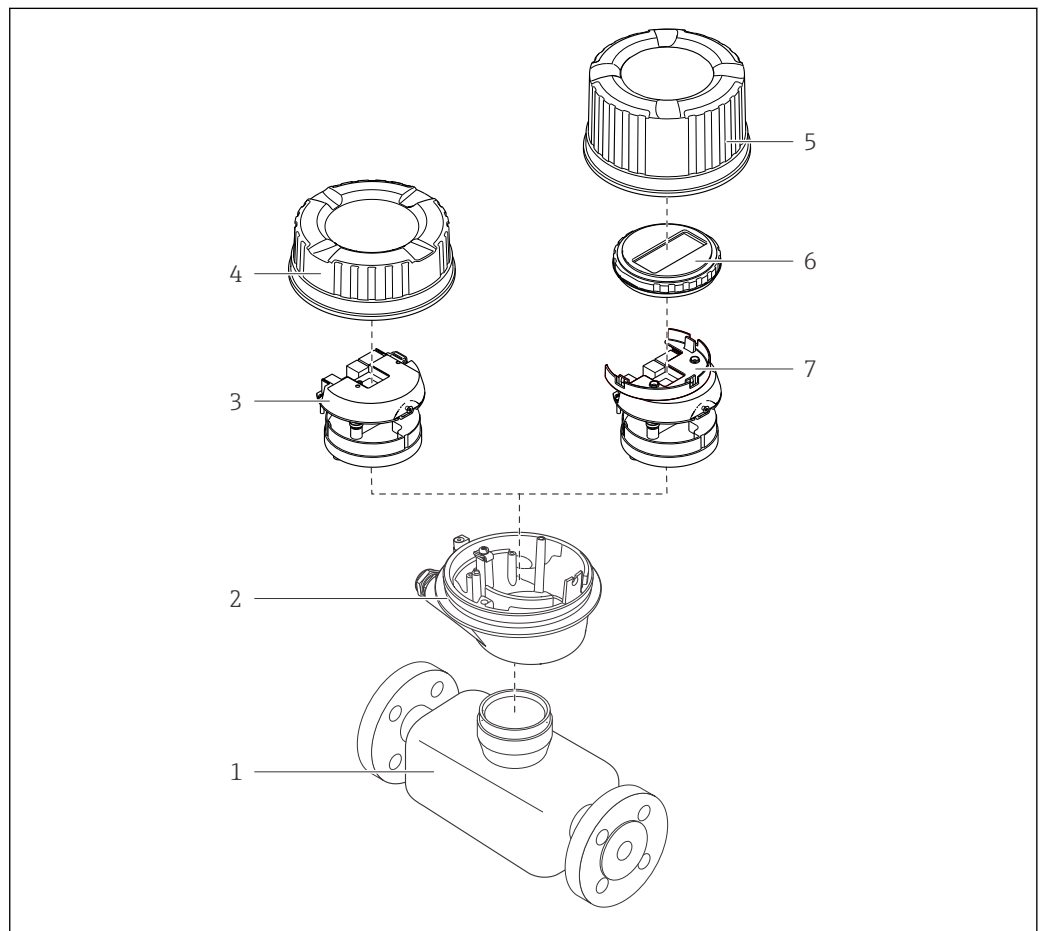













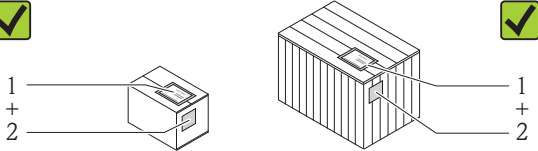

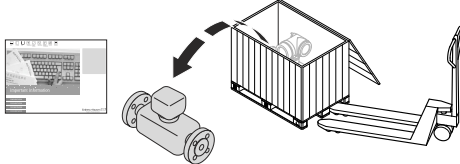
A0023153

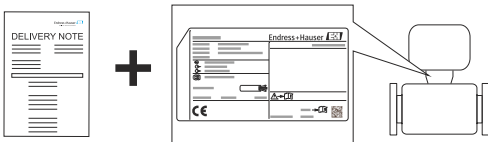

1 Important components of a measuring device

- 1 Sensor
- 2 Transmitter housing
- 3 Main electronics module
- 4 Transmitter housing cover
- 5 Transmitter housing cover (version for optional onsite display)
- 6 Onsite display (optional)
- 7 Main electronics module (with bracket for optional onsite display)

## 4 Incoming acceptance and product identification

### 4.1 Incoming acceptance

				<p>Are the order codes on the delivery note (1) and the product sticker (2) identical?</p>
				
				<p>Are the goods undamaged?</p>
				<p>Do the nameplate data match the ordering information on the delivery note?</p>
				<p>Is the CD-ROM with the Technical Documentation (depends on device version) and documents present?</p>



-  If one of the conditions is not satisfied, contact your Endress+Hauser Sales Center.
- Depending on the device version, the CD-ROM might not be part of the delivery! The Technical Documentation is available via the Internet or via the *Endress+Hauser Operations App*, see the "Product identification" section (→  13).

### 4.2 Product identification

The following options are available for identification of the measuring device:

- Nameplate specifications
- Order code with breakdown of the device features on the delivery note
- Enter serial numbers from nameplates in *W@M Device Viewer* ([www.endress.com/deviceviewer](http://www.endress.com/deviceviewer)): All information about the measuring device is displayed.
- Enter the serial number from the nameplates into the *Endress+Hauser Operations App* or scan the 2-D matrix code (QR code) on the nameplate with the *Endress+Hauser Operations App*: all the information for the measuring device is displayed.

For an overview of the scope of the associated Technical Documentation, refer to the following:

- The chapters "Additional standard documentation on the device" (→  7) and "Supplementary device-dependent documentation" (→  7)
- The *W@M Device Viewer*: Enter the serial number from the nameplate ([www.endress.com/deviceviewer](http://www.endress.com/deviceviewer))
- The *Endress+Hauser Operations App*: Enter the serial number from the nameplate or scan the 2-D matrix code (QR code) on the nameplate.

### 4.2.1 Transmitter nameplate

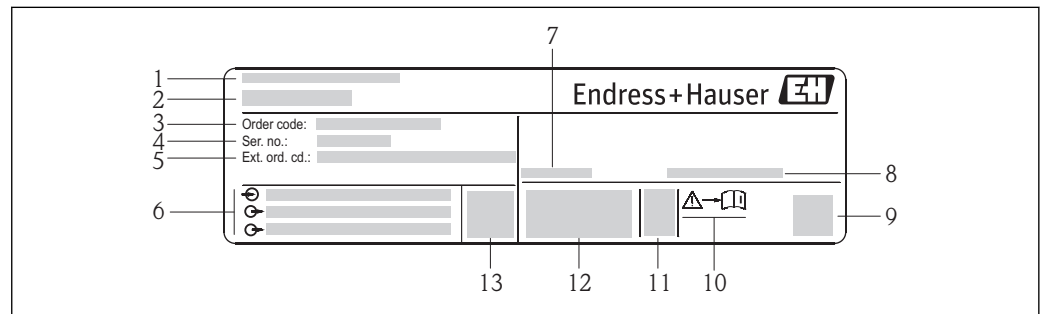

A0017520

 2 Example of a transmitter nameplate

- 1 Manufacturing location
- 2 Name of the transmitter
- 3 Order code
- 4 Serial number (Ser. no.)
- 5 Extended order code (Ext. ord. cd.)
- 6 Electrical connection data, e.g. available inputs and outputs, supply voltage
- 7 Permitted ambient temperature ( $T_a$ )
- 8 Degree of protection
- 9 2-D matrix code
- 10 Document number of safety-related supplementary documentation
- 11 Manufacturing date: year-month
- 12 CE mark, C-Tick
- 13 Firmware version (FW)

### 4.2.2 Sensor nameplate





#### Order code

The measuring device is reordered using the order code.

#### Extended order code

- The device type (product root) and basic specifications (mandatory features) are always listed.
- Of the optional specifications (optional features), only the safety and approval-related specifications are listed (e.g. LA). If other optional specifications are also ordered, these are indicated collectively using the # placeholder symbol (e.g. #LA#).
- If the ordered optional specifications do not include any safety and approval-related specifications, they are indicated by the + placeholder symbol (e.g. XXXXXX-ABCDE+).

### 4.2.3 Symbols on measuring device

Symbol	Meaning
	<b>WARNING!</b> This symbol alerts you to a dangerous situation. Failure to avoid this situation can result in serious or fatal injury.
	<b>Reference to documentation</b> Refers to the corresponding device documentation.
	<b>Protective ground connection</b> A terminal which must be connected to ground prior to establishing any other connections.

## 5 Storage and transport

### 5.1 Storage conditions

Observe the following notes for storage:

- Store in the original packaging to ensure protection from shock.
- Do not remove protective covers or protective caps installed on process connections. They prevent mechanical damage to the sealing surfaces and contamination in the measuring tube.
- Protect from direct sunlight to avoid unacceptably high surface temperatures.
- Storage temperature:  $-40$  to  $+80$  °C ( $-40$  to  $+176$  °F),  
Order Code "Test, Certificate", Option JM:  $-50$  to  $+60$  °C ( $-58$  to  $+140$  °F), preferably at  $+20$  °C ( $+68$  °F)
- Store in a dry and dust-free place.
- Do not store outdoors.

### 5.2 Transporting the product

Transport the measuring device to the measuring point in the original packaging.

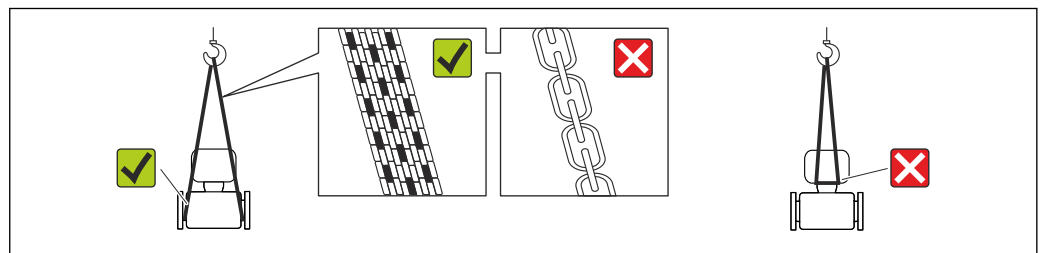

A0015604

- i** Do not remove protective covers or caps installed on process connections. They prevent mechanical damage to the sealing surfaces and contamination in the measuring tube.

#### 5.2.1 Measuring devices without lifting lugs

##### **⚠ WARNING**

**Center of gravity of the measuring device is higher than the suspension points of the webbing slings.**

Risk of injury if the measuring device slips.

- ▶ Secure the measuring device against slipping or turning.
- ▶ Observe the weight specified on the packaging (stick-on label).

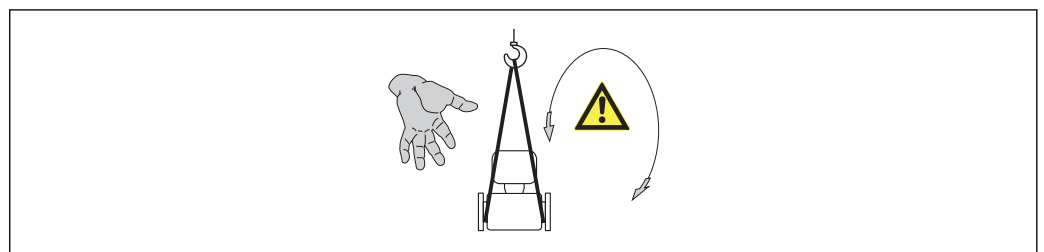

A0015606

## 5.2.2 Measuring devices with lifting lugs

### CAUTION

#### Special transportation instructions for devices with lifting lugs

- ▶ Only use the lifting lugs fitted on the device or flanges to transport the device.
- ▶ The device must always be secured at two lifting lugs at least.

## 5.2.3 Transporting with a fork lift

If transporting in wood crates, the floor structure enables the crates to be lifted lengthwise or at both sides using a forklift.

## 5.3 Packaging disposal

All packaging materials are environmentally friendly and 100% recyclable:

- Measuring device secondary packaging: polymer stretch film that conforms to EC Directive 2002/95/EC (RoHS).
- Packaging:
  - Wood crate, treated in accordance with ISPM 15 standard, which is confirmed by the affixed IPPC logo.
  - or
  - Carton in accordance with European Packaging Directive 94/62EC; recyclability is confirmed by the affixed RESY symbol.
- Seaworthy packaging (optional): Wood crate, treated in accordance with ISPM 15 standard, which is confirmed by the affixed IPPC logo.
- Carrying and mounting hardware:
  - Disposable plastic pallet
  - Plastic straps
  - Plastic adhesive strips
- Dunnage: Paper cushion



## 6 Installation

### 6.1 Mounting requirements

No special measures such as supports are necessary. External forces are absorbed by the construction of the device.

#### 6.1.1 Mounting position

##### Mounting location





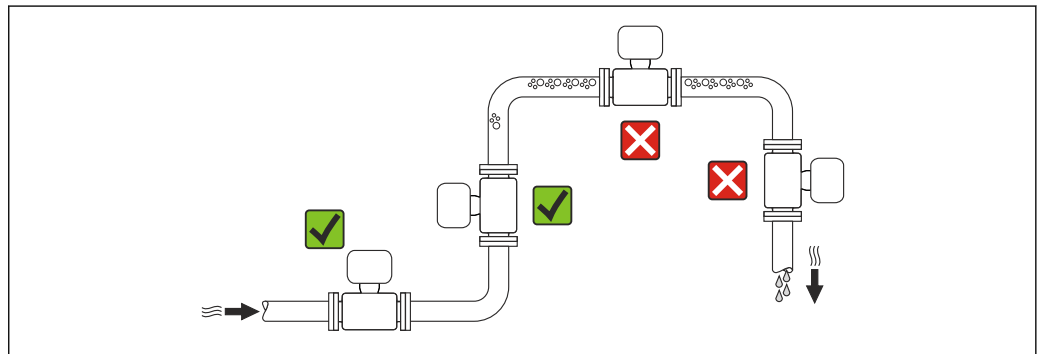

To prevent measuring errors arising from accumulation of gas bubbles in the measuring tube, avoid the following mounting locations in the pipe:

- Highest point of a pipeline.
- Directly upstream of a free pipe outlet in a down pipe.

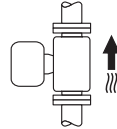
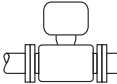

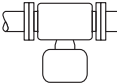
##### Orientation

The direction of the arrow on the sensor nameplate helps you to install the sensor according to the flow direction (direction of medium flow through the piping).

Orientation		Recommendation
A	Vertical orientation	 A0015591 ✓✓
B	Horizontal orientation, transmitter head up	 A0015589 ✓✓ <sup>1)</sup> Exception: (→  ,  )
C	Horizontal orientation, transmitter head down	 A0015590 ✓✓ <sup>2)</sup> Exception: (→  ,  )
D	Horizontal orientation, transmitter head at side	 A0015592 ✗

- 1) Applications with low process temperatures may reduce the ambient temperature. To maintain the minimum ambient temperature for the transmitter, this orientation is recommended.
- 2) Applications with high process temperatures may increase the ambient temperature. To maintain the maximum ambient temperature for the transmitter, this orientation is recommended.

If a sensor is installed horizontally with a curved measuring tube, match the position of the sensor to the fluid properties.

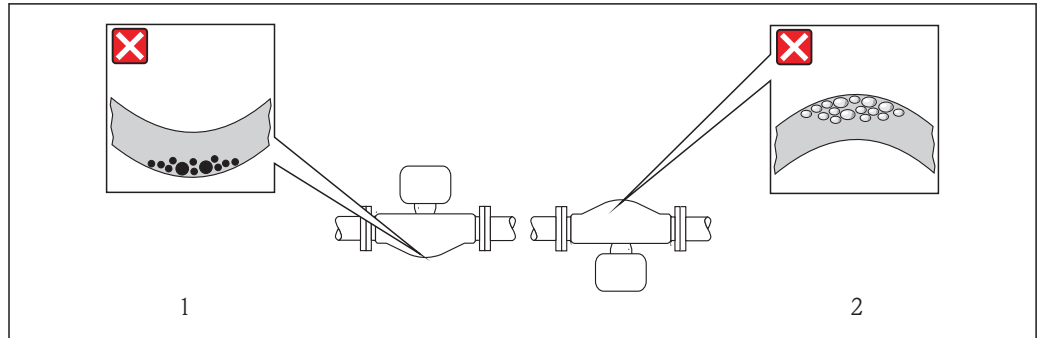

3 Orientation of sensor with curved measuring tube

- 1 Avoid this orientation for fluids with entrained solids: Risk of solids accumulating.
- 2 Avoid this orientation for outgassing fluids: Risk of gas accumulating.

**Inlet and outlet runs**

No special precautions need to be taken for fittings which create turbulence, such as valves, elbows or T-pieces, as long as no cavitation occurs (→ 18).

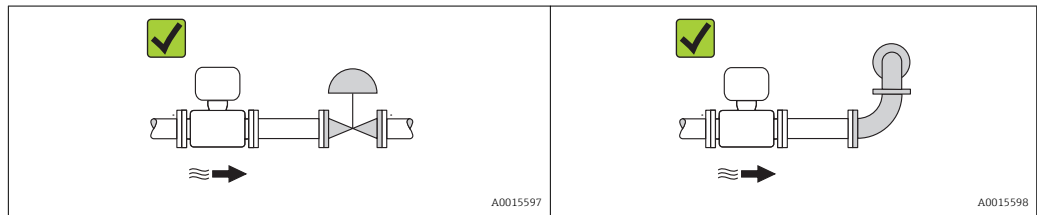

*Installation dimensions*

For the dimensions and installation lengths of the device, see the "Technical Information" document, "Mechanical construction" section

**6.1.2 Requirements from environment and process**

**Ambient temperature range**

<b>Measuring device</b>	Non-Ex	-40 to +60 °C (-40 to +140 °F)
	Ex na, NI version	-40 to +60 °C (-40 to +140 °F)
	Ex ia, IS version	<ul style="list-style-type: none"> <li>■ -40 to +60 °C (-40 to +140 °F)</li> <li>■ -50 to +60 °C (-58 to +140 °F) (Order code for "Test, certificate", option JM)</li> </ul>
<b>Local display</b>		-20 to +60 °C (-4 to +140 °F) The readability of the display may be impaired at temperatures outside the temperature range.

- ▶ If operating outdoors:  
Avoid direct sunlight, particularly in warm climatic regions.

**System pressure**

It is important that cavitation does not occur, or that gases entrained in the liquids do not outgas.

Cavitation is caused if the pressure drops below the vapor pressure:

- In liquids that have a low boiling point (e.g. hydrocarbons, solvents, liquefied gases)
- In suction lines

- ▶ Ensure the system pressure is sufficiently high to prevent cavitation and outgassing.

For this reason, the following mounting locations are recommended:

- At the lowest point in a vertical pipe
- Downstream from pumps (no danger of vacuum)

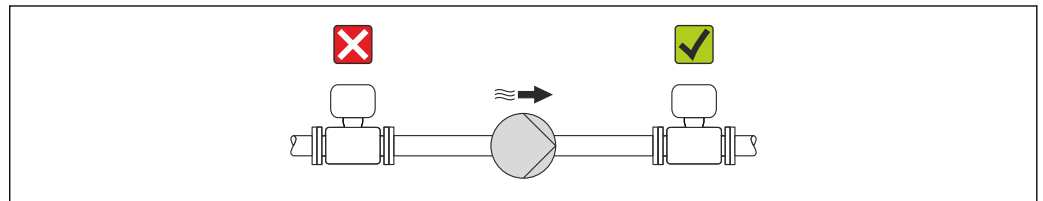

A0015594

### Thermal insulation

In the case of some fluids, it is important that the heat radiated from the sensor to the transmitter is kept to a minimum. A wide range of materials can be used for the required insulation.

#### NOTICE

#### Electronics overheating on account of thermal insulation!

- ▶ Observe maximum permitted insulation height of the transmitter neck so that the transmitter head is completely free.

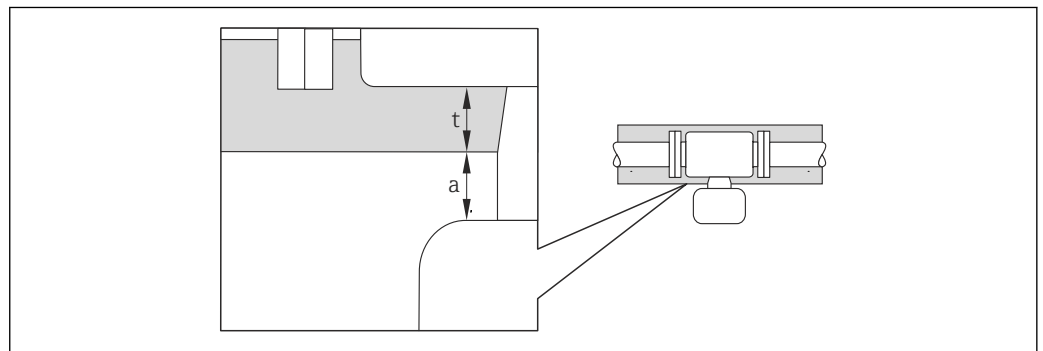

A0019919

- a* Minimum distance to insulation  
*t* maximum Insulation thickness

The minimum distance between the transmitter housing and the insulation is 10 mm (0.39 in) so that the transmitter head remains completely exposed.

#### NOTICE

#### Danger of overheating with insulation

- ▶ Ensure that the temperature at the lower end of the transmitter housing does not exceed 80 °C (176 °F)

#### NOTICE

**The insulation can also be thicker than the maximum recommended insulation thickness.**

Prerequisite:

- ▶ Ensure that convection takes place on a sufficiently large scale at the transmitter neck.
- ▶ Ensure that a sufficiently large area of the housing support remains exposed. The uncovered part serves as a radiator and protects the electronics from overheating and excessive cooling.

## Heating

### NOTICE

#### Electronics can overheat due to elevated ambient temperature!

- ▶ Observe maximum permitted ambient temperature for the transmitter (→  18).
- ▶ Depending on the fluid temperature, take the device orientation requirements into account.

### NOTICE

#### Danger of overheating when heating

- ▶ Ensure that the temperature at the lower end of the transmitter housing does not exceed 80 °C (176 °F)
- ▶ Ensure that convection takes place on a sufficiently large scale at the transmitter neck.
- ▶ Ensure that a sufficiently large area of the housing support remains exposed. The uncovered part serves as a radiator and protects the electronics from overheating and excessive cooling.

### Heating options

If a fluid requires that no heat loss should occur at the sensor, users can avail of the following heating options:

- Electrical heating, e.g. with electric band heaters
- Via pipes carrying hot water or steam
- Via heating jackets

### Using an electrical trace heating system

If heating is regulated via phase angle control or pulse packages, magnetic fields can affect the measured values (= for values that are greater than the values approved by the EN standard (sine 30 A/m)).

For this reason, the sensor must be magnetically shielded: the housing can be shielded with tin plates or electric sheets without a privileged direction (e.g. V330-35A).

The sheet must have the following properties:

- Relative magnetic permeability  $\mu_r \geq 300$
- Plate thickness  $d \geq 0.35$  mm ( $d \geq 0.014$  in)

## Vibrations

The high oscillation frequency of the measuring tubes ensures that the correct operation of the measuring system is not influenced by plant vibrations.

### 6.1.3 Special mounting instructions

#### Rupture disk

Make sure that the function and operation of the rupture disk are not impeded when installing the device. The position of the rupture disk is indicated on a sticker applied over it. If the rupture disk is triggered, the sticker is destroyed. The disk can therefore be visually monitored. For additional information that is relevant to the process (→  93).

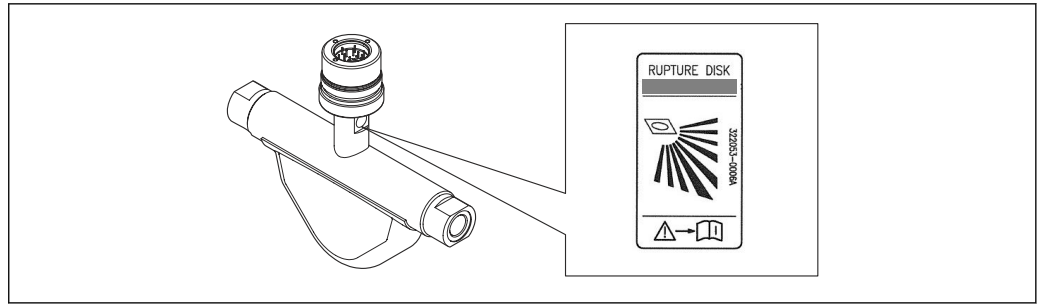

A0024599

 4 Rupture disk label

### **WARNING**

#### **Limited functional reliability of the rupture disk.**

Danger to persons from escaping fluids!

- ▶ Do not remove the rupture disk.
- ▶ When using a rupture disk, do not use a heating jacket.
- ▶ Make sure that the function and operation of the rupture disk is not impeded through the installation of the device.
- ▶ Take precautions to prevent damage and danger to persons if the rupture disk is actuated.
- ▶ Observe information on the rupture disk sticker.

#### **Zero point adjustment**

All measuring devices are calibrated in accordance with state-of-the-art technology. Calibration takes place under reference conditions (→  89). Therefore, a zero point adjustment in the field is generally not required.

Experience shows that zero point adjustment is advisable only in special cases:

- To achieve maximum measuring accuracy even with low flow rates
- Under extreme process or operating conditions (e.g. very high process temperatures or very high-viscosity fluids).

 Zero point adjustment is performed via the **Zero point adjustment control** parameter (→  55).

## **6.2 Mounting the measuring device**

### **6.2.1 Required tools**

#### **For sensor**

For flanges and other process connections: Corresponding mounting tools

### **6.2.2 Preparing the measuring device**

1. Remove all remaining transport packaging.
2. Remove any protective covers or protective caps present from the sensor.
3. Remove stick-on label on the electronics compartment cover.

### 6.2.3 Mounting the measuring device

**⚠ WARNING**

**Danger due to improper process sealing!**

- ▶ Ensure that the inside diameters of the gaskets are greater than or equal to that of the process connections and piping.
- ▶ Ensure that the gaskets are clean and undamaged.
- ▶ Install the gaskets correctly.

1. Ensure that the direction of the arrow on the nameplate of the sensor matches the flow direction of the fluid.
2. Install the measuring device or turn the transmitter housing so that the cable entries do not point upwards.

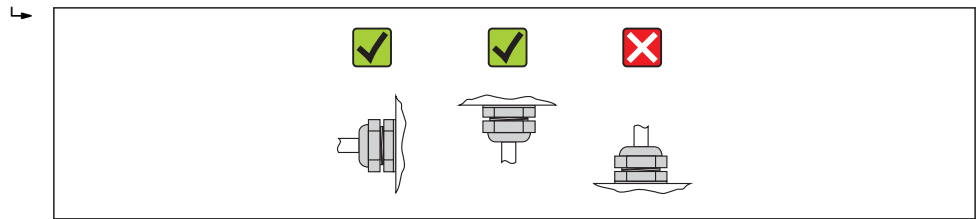

A0013964

### 6.2.4 Turning the display module

The display module can be turned to optimize display readability.

**Aluminum housing version, AlSi10Mg, coated**

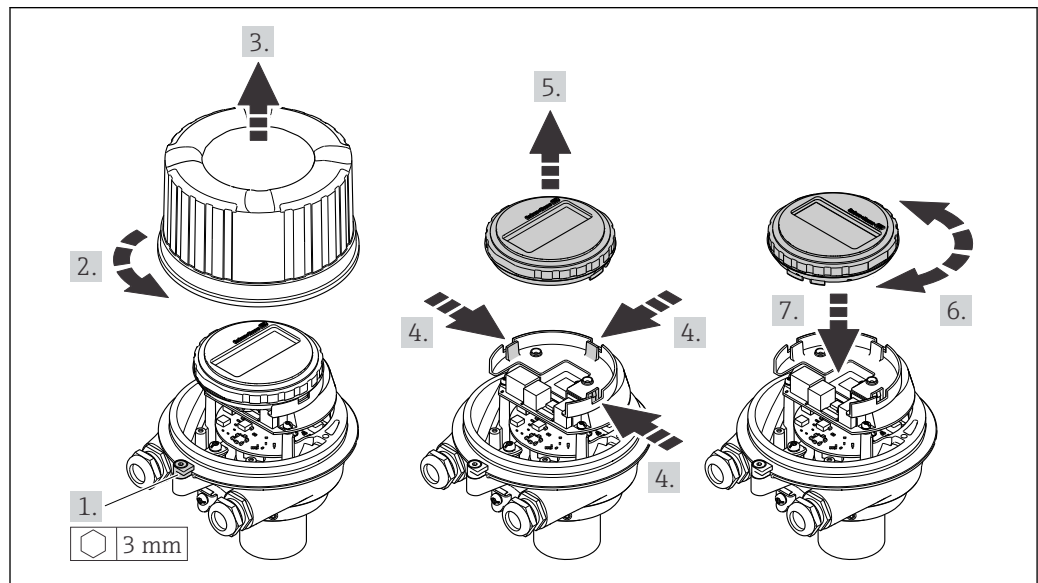

A0023192

### 6.3 Post-installation check

Is the device undamaged (visual inspection)?	<input type="checkbox"/>
Does the measuring device conform to the measuring point specifications? For example: <ul style="list-style-type: none"> <li>▪ Process temperature (→ 93)</li> <li>▪ Process pressure (refer to the chapter on "Pressure-temperature ratings" of the "Technical Information" document)</li> <li>▪ Ambient temperature (→ 18)</li> <li>▪ Measuring range (→ 84)</li> </ul>	<input type="checkbox"/>

Has the correct orientation for the sensor been selected ? <ul style="list-style-type: none"><li>▪ According to sensor type</li><li>▪ According to medium temperature</li><li>▪ According to medium properties (outgassing, with entrained solids)</li></ul>	<input type="checkbox"/>
Does the arrow on the sensor nameplate match the direction of flow of the fluid through the piping (->  17)?	<input type="checkbox"/>
Are the measuring point identification and labeling correct (visual inspection)?	<input type="checkbox"/>
Is the device adequately protected from precipitation and direct sunlight?	<input type="checkbox"/>
Are the securing screw and securing clamp tightened securely?	<input type="checkbox"/>

## 7 Electrical connection

 The measuring device does not have an internal circuit breaker. For this reason, assign the measuring device a switch or power-circuit breaker so that the power supply line can be easily disconnected from the mains.

### 7.1 Connection conditions

#### 7.1.1 Required tools

- For cable entries: Use corresponding tools
- For securing clamp (on aluminum housing): Allen screw 3 mm
- For securing screw (for stainless steel housing): open-ended wrench 8 mm
- Wire stripper
- When using stranded cables: crimping tool for ferrule

#### 7.1.2 Requirements for connecting cable

The connecting cables provided by the customer must fulfill the following requirements.

##### Electrical safety

In accordance with applicable federal/national regulations.

##### Permitted temperature range

- $-40\text{ °C}$  ( $-40\text{ °F}$ ) to  $+80\text{ °C}$  ( $+176\text{ °F}$ )
- Minimum requirement: cable temperature range  $\geq$  ambient temperature  $+20\text{ K}$

##### Power supply cable

Standard installation cable is sufficient.

##### Signal cable

###### *EtherNet/IP*

The standard ANSI/TIA/EIA-568-B.2 Annex specifies CAT 5 as the minimum category for a cable used for EtherNet/IP. CAT 5e and CAT 6 are recommended.

 For more information on planning and installing EtherNet/IP networks, please refer to the "Media Planning and Installation Manual. EtherNet/IP" of the ODVA Organization.

##### Cable diameter

- Cable glands supplied:  
M20  $\times$  1.5 with cable  $\phi$ 6 to 12 mm (0.24 to 0.47 in)
- Spring terminals:  
Wire cross-sections 0.5 to 2.5 mm<sup>2</sup> (20 to 14 AWG)



### 7.1.3 Terminal assignment

#### Transmitter

*EtherNet/IP connection version*

Order code for "Output", option **N**

Depending on the housing version, the transmitters can be ordered with clamps or device plugs.

Order Code "Housing"	Connection methods available		Possible options for order code "Electrical connection"
	Output	Power supply	
Options <b>A, B</b>	Device plugs (→ 26)	Terminals	<ul style="list-style-type: none"> <li>▪ Option <b>L</b>: plug M12x1 + thread NPT 1/2"</li> <li>▪ Option <b>N</b> "Plug M12x1 + coupling M20"</li> <li>▪ Option <b>P</b> "Plug M12x1 + thread G 1/2"</li> <li>▪ Option <b>U</b> "Plug M12x1 + thread M20"</li> </ul>
Options <b>A, B, C</b>	Device plugs (→ 26)	Device plugs (→ 26)	Option <b>Q</b> "2 x plug M12x1"
Order code for "Housing": <ul style="list-style-type: none"> <li>▪ Option <b>A</b>: compact, coated aluminum</li> <li>▪ Option <b>B</b>: compact, stainless</li> <li>▪ Option <b>C</b> "Ultra compact, stainless"</li> </ul>			

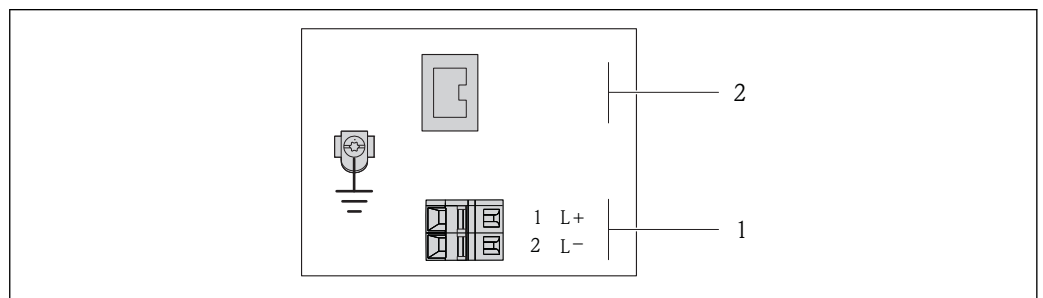

A0017054

5 EtherNet/IP terminal assignment

- 1 Power supply: DC 24 V
- 2 EtherNet/IP

Order Code "Output"	Terminal number		Output Device plug M12x1
	2 (L-)	1 (L+)	
Option <b>N</b>	DC 24 V		EtherNet/IP
Order code for "Output": Option <b>N</b> : EtherNet/IP			

### 7.1.4 Pin assignment, device plug

#### EtherNet/IP

*Device plug for supply voltage (device side)*

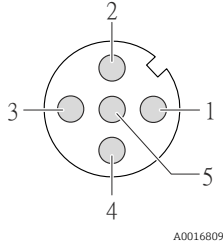
	Pin		Assignment	
	1	L+	DC 24 V	
	2			
	3			
	4	L-	DC 24 V	
	5		Grounding/shielding	
Coding		Plug/socket		
A		Plug		

*Device plug for signal transmission (device side)*

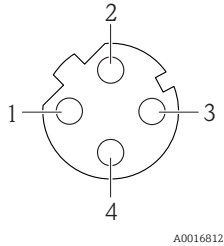
	Pin		Assignment	
	1	+	Tx	
	2	+	Rx	
	3	-	Tx	
	4	-	Rx	
	Coding		Plug/socket	
D		Socket		

### 7.1.5 Preparing the measuring device

1. Remove dummy plug if present.
2. **NOTICE!** Insufficient sealing of the housing! Operational reliability of the measuring device could be compromised. Use suitable cable glands corresponding to the degree of protection.  
If measuring device is delivered without cable glands:  
Provide suitable cable gland for corresponding connecting cable (→ 24).
3. If measuring device is delivered with cable glands:  
Observe cable specification (→ 24).

## 7.2 Connecting the measuring device

### NOTICE

#### Limitation of electrical safety due to incorrect connection!

- ▶ Have electrical connection work carried out by correspondingly trained specialists only.
- ▶ Observe applicable federal/national installation codes and regulations.
- ▶ Comply with local workplace safety regulations.
- ▶ For use in potentially explosive atmospheres, observe the information in the device-specific Ex documentation.

### 7.2.1 Connecting the transmitter

The connection of the transmitter depends on the following order codes:

- Housing version: compact or ultra-compact
- Connection version: device plug or terminals

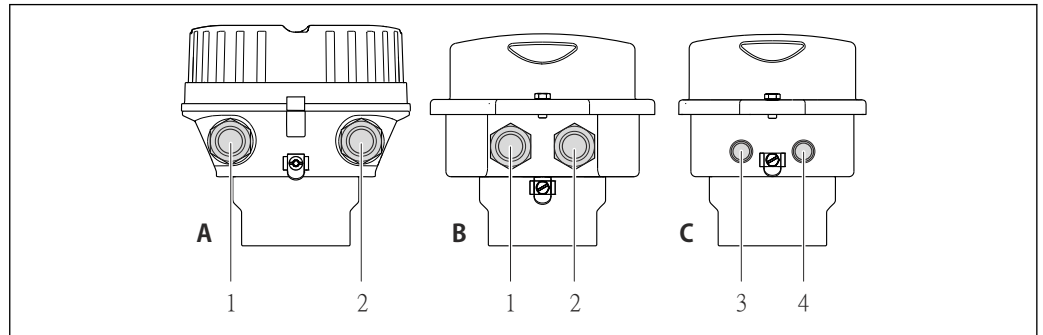

A0016924

6 Device versions and connection versions

- A Housing version: compact, aluminum coated
- B Housing version: compact, stainless
- 1 Cable entry or device plug for signal transmission
- 2 Cable entry or device plug for supply voltage
- C Housing version: ultra-compact, stainless:
- 3 Device plug for signal transmission
- 4 Device plug for supply voltage

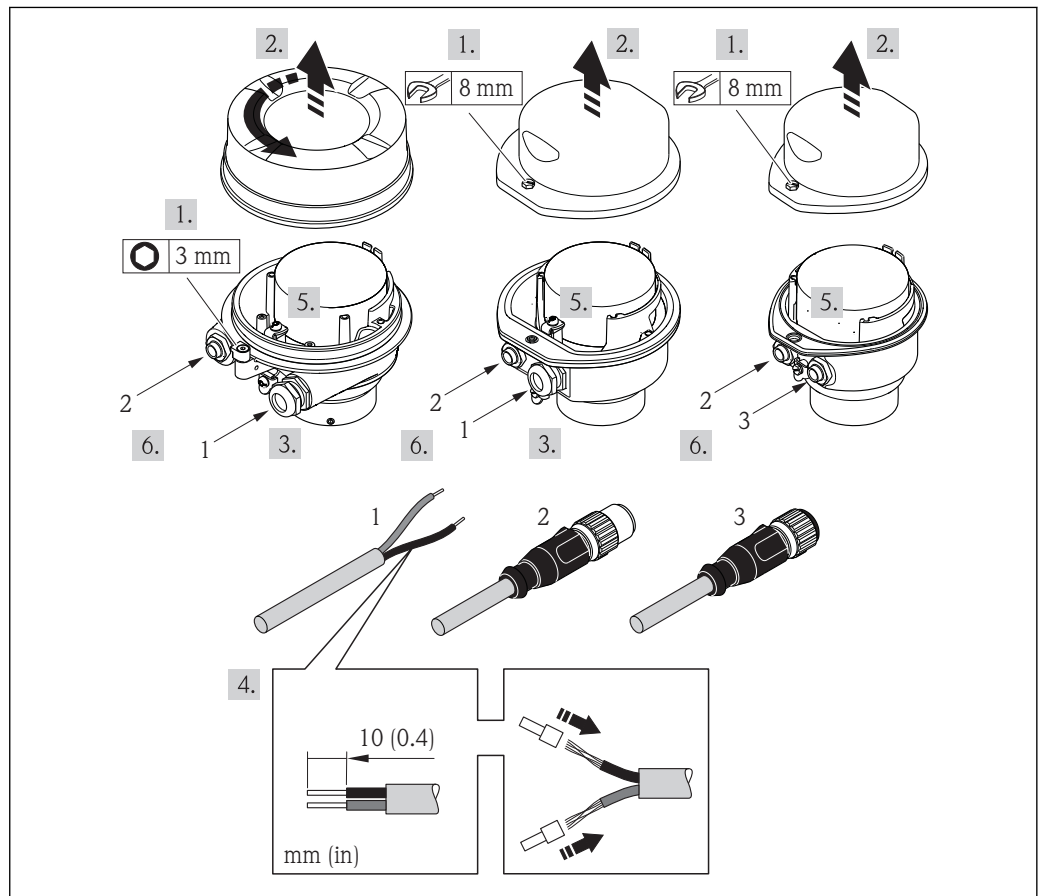

A0017844

7 Device versions with connection examples

- 1 Cable
- 2 Device plug for signal transmission
- 3 Device plug for supply voltage

For device version with device plug: follow step 6 only.

1. Depending on the housing version, loosen the securing clamp or fixing screw of the housing cover.
2. Depending on the housing version, unscrew or open the housing cover and disconnect the local display from the main electronics module where necessary (→ 96).
3. Push the cable through the cable entry . To ensure tight sealing, do not remove the sealing ring from the cable entry.
4. Strip the cable and cable ends. In the case of stranded cables, also fit wire end ferrules.
5. Connect the cable in accordance with the terminal assignment or the device plug pin assignment .
6. Depending on the device version, tighten the cable glands or plug in the device plug and tighten.
7. **WARNING!** Housing degree of protection may be voided due to insufficient sealing of the housing. Screw in the screw without using any lubricant. The threads on the cover are coated with a dry lubricant.

Reverse the removal procedure to reassemble the transmitter.

## 7.3 Special connection instructions

### 7.3.1 Connection examples

#### EtherNet/IP

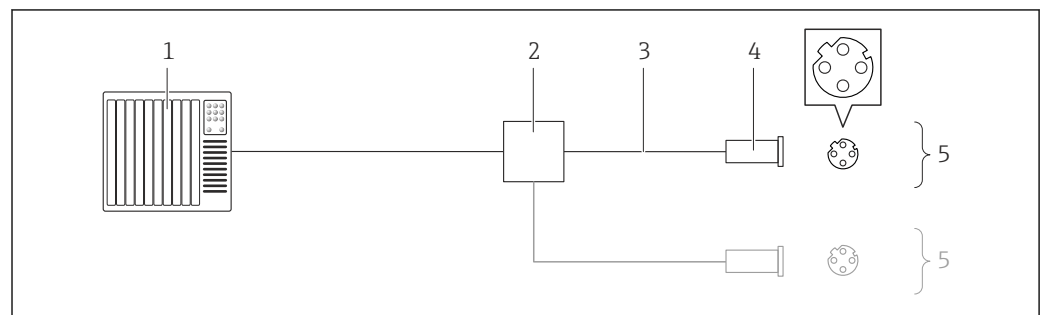

8 Connection example for EtherNet/IP

- 1 Control system (e.g. PLC)
- 2 Ethernet switch
- 3 Observe cable specifications (→ 24)
- 4 Device plugs
- 5 Transmitter

## 7.4 Hardware settings

### 7.4.1 Setting the device address



#### EtherNet/IP

The IP address of the measuring device can be configured for the network via DIP switches.

### Addressing data

IP address and configuration options			
1st octet	2nd octet	3rd octet	4th octet
192.	168.	1.	XXX
↓ Can only be configured via software addressing			↓ Can be configured via software addressing and hardware addressing

<b>IP address range</b>	1 to 254 (4th octet)
<b>IP address broadcast</b>	255
<b>Addressing mode ex works</b>	Software addressing; all DIP switches for hardware addressing are set to OFF.
<b>IP address ex works</b>	DHCP server active

 For device addressing via software (→  46)

### Setting the address

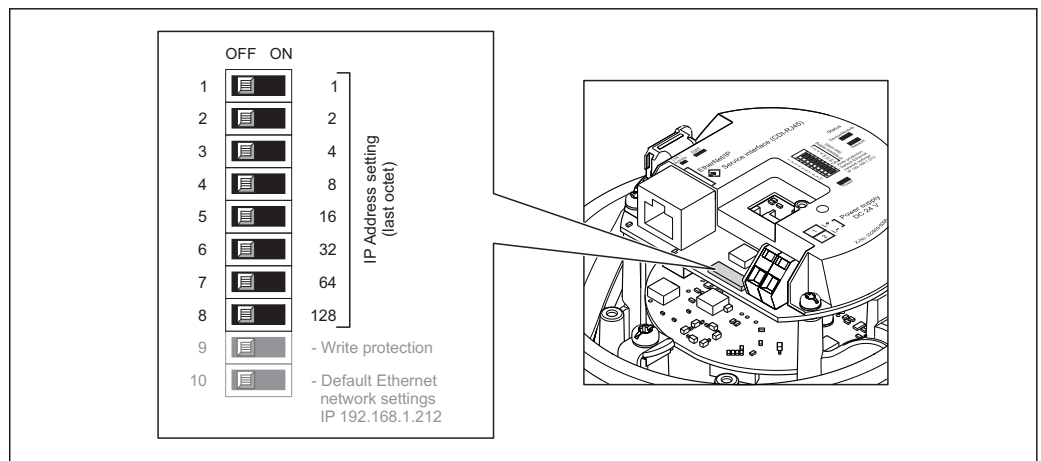

A0017913

1. Depending on the housing version, loosen the securing clamp or fixing screw of the housing cover.
2. Depending on the housing version, unscrew or open the housing cover and disconnect the local display from the main electronics module where necessary (→  96).
3. Set the desired IP address using the corresponding DIP switches on the I/O electronics module.
  - ↳ Hardware addressing with the configured IP address is enabled after 10 s.
4. Reverse the removal procedure to reassemble the transmitter.

## 7.5 Ensuring the degree of protection

The measuring device fulfills all the requirements for the IP66/67 degree of protection, Type 4X enclosure.

To guarantee IP66/67 degree of protection, Type 4X enclosure, carry out the following steps after the electrical connection:

1. Check that the housing seals are clean and fitted correctly. Dry, clean or replace the seals if necessary.
2. Tighten all housing screws and screw covers.
3. Firmly tighten the cable glands.
4. To ensure that moisture does not enter the cable entry, route the cable so that it loops down before the cable entry ("water trap").

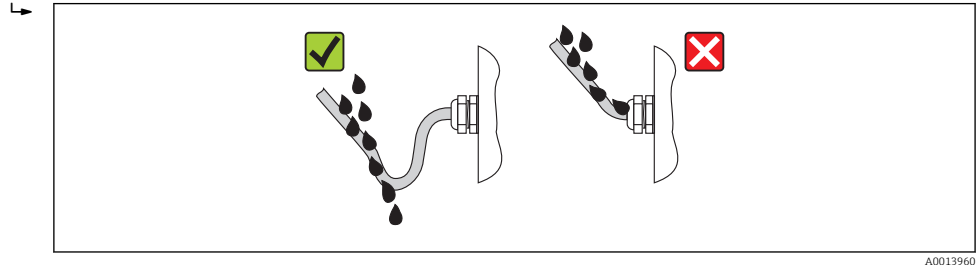

5. Insert dummy plugs into unused cable entries.

## 7.6 Post-connection check

Are cables or the device undamaged (visual inspection)?	<input type="checkbox"/>
Do the cables comply with the requirements (→ 24)?	<input type="checkbox"/>
Do the cables have adequate strain relief?	<input type="checkbox"/>
Are all the cable glands installed, firmly tightened and leak-tight? Cable run with "water trap" (→ 29)?	<input type="checkbox"/>
Does the supply voltage match the specifications on the transmitter nameplate?	<input type="checkbox"/>
If supply voltage is present, is the power LED on the electronics module of the transmitter lit green (→ 11)?	<input type="checkbox"/>
Depending on the device version, is the securing clamp or fixing screw firmly tightened?	<input type="checkbox"/>

## 8 Operation options

### 8.1 Overview of operation options

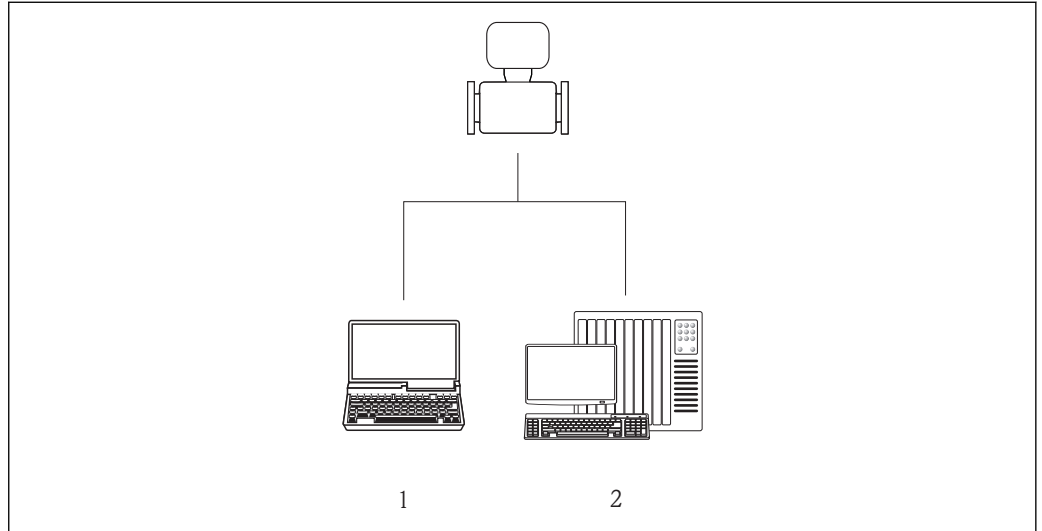

A0017760

- 1 Computer with Web browser (e.g. Internet Explorer) or with "FieldCare" operating tool
- 2 Automation system, e.g. "RSLogix" (Rockwell Automation) and work station for measuring device operation with Add-on Profile Level 3 for "RSLogix 5000" software (Rockwell Automation)

## 8.2 Structure and function of the operating menu

### 8.2.1 Structure of the operating menu

**i** For an overview of the operating menu with menus and parameters

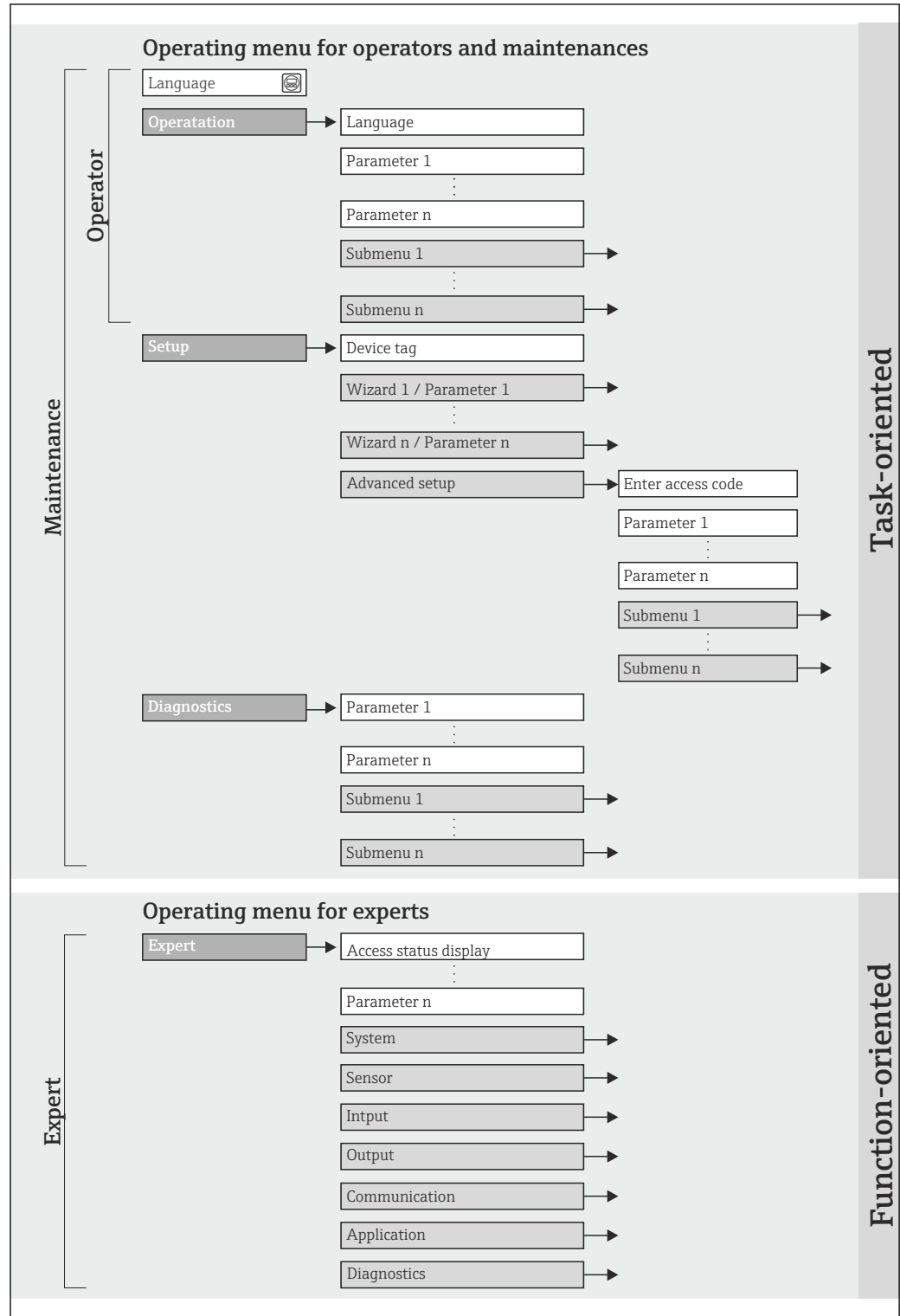

A0018237-EN

9 Schematic structure of the operating menu



## 8.2.2 Operating philosophy

The individual parts of the operating menu are assigned to certain user roles (operator, maintenance etc.). Each user role contains typical tasks within the device lifecycle.

Menu		User role and tasks	Content/meaning
Operation	task-oriented	<b>Role "Operator", "Maintenance"</b> Tasks during operation: Reading measured values	<ul style="list-style-type: none"> <li>▪ Defining the Web server operating language</li> <li>▪ Resetting and controlling totalizers</li> </ul>
Setup		<b>"Maintenance" role</b> Commissioning: <ul style="list-style-type: none"> <li>▪ Configuration of the measurement</li> <li>▪ Configuration of the communication interface</li> </ul>	Submenus for fast commissioning: <ul style="list-style-type: none"> <li>▪ Setting the individual system units</li> <li>▪ Defining the medium</li> <li>▪ Configuration of the digital communication interface</li> <li>▪ Configuring the low flow cut off</li> <li>▪ Configuring partial and empty pipe detection</li> </ul> <b>"Advanced setup" submenu:</b> <ul style="list-style-type: none"> <li>▪ For more customized configuration of the measurement (adaptation to special measuring conditions)</li> <li>▪ Configuration of totalizers</li> </ul> <b>"Device reset" submenu</b> Resets the device configuration to certain settings
Diagnostics		<b>"Maintenance" role</b> Fault elimination: <ul style="list-style-type: none"> <li>▪ Diagnostics and elimination of process and device errors</li> <li>▪ Measured value simulation</li> </ul>	Contains all parameters for error detection and analyzing process and device errors: <ul style="list-style-type: none"> <li>▪ <b>"Diagnostic list" submenu</b> Contains up to 5 currently pending diagnostic messages.</li> <li>▪ <b>"Event logbook" submenu</b> Contains 20 event messages that have occurred.</li> <li>▪ <b>"Device information" submenu</b> Contains information for identifying the device.</li> <li>▪ <b>"Measured values" submenu</b> Contains all current measured values.</li> <li>▪ <b>"Simulation" submenu</b> Is used to simulate measured values or output values.</li> </ul>
Expert	function-oriented	Tasks that require detailed knowledge of the function of the device: <ul style="list-style-type: none"> <li>▪ Commissioning measurements under difficult conditions</li> <li>▪ Optimal adaptation of the measurement to difficult conditions</li> <li>▪ Detailed configuration of the communication interface</li> <li>▪ Error diagnostics in difficult cases</li> </ul>	Contains all the parameters of the device and makes it possible to access these parameters directly using an access code. The structure of this menu is based on the function blocks of the device: <ul style="list-style-type: none"> <li>▪ <b>"System" submenu</b> Contains all higher-order device parameters that do not pertain either to measurement or the measured value communication.</li> <li>▪ <b>"Sensor" submenu</b> Configuration of the measurement.</li> <li>▪ <b>"Communication" submenu</b> Configuration of the digital communication interface and the Web server.</li> <li>▪ <b>"Application" submenu</b> Configuration of the functions that go beyond the actual measurement (e.g. totalizer).</li> <li>▪ <b>"Diagnostics" submenu</b> Error detection and analysis of process and device errors and for device simulation and Heartbeat Technology.</li> </ul>



## 8.3 Access to the operating menu via the Web browser

### 8.3.1 Function range

Thanks to the integrated Web server the device can be operated and configured via a Web browser. In addition to the measured values, status information on the device is also displayed and allows the user to monitor the status of the device. Furthermore the device data can be managed and the network parameters can be configured.

### 8.3.2 Prerequisites

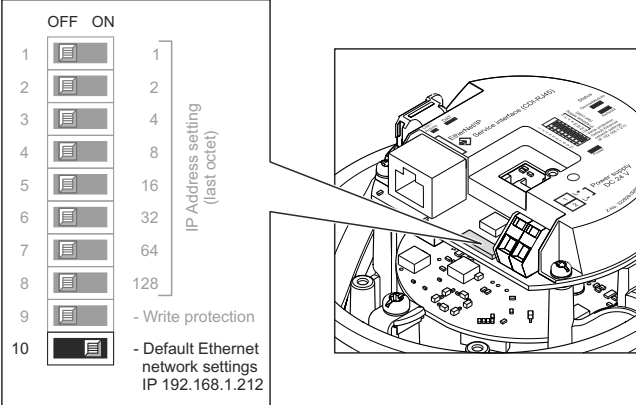
#### Hardware

Connecting cable	Standard Ethernet cable with RJ45 connector
Computer	RJ45 interface
Measuring device:	Web server must be enabled; factory setting: ON  For information on enabling the Web server (→ 37)
IP address	<p>If the IP address of the device is not known, communication with the Web server can be established via the standard IP address 192.168.1.212. The DHCP function is enabled in the device at the factory, i.e. the device expects an IP address to be assigned by the network. This function can be disabled and the device can be set to the standard IP address 192.168.1.212: set switch DIP switch No. 10 from OFF → ON.</p>  <p style="text-align: right; font-size: small;">A0017965</p> <p> <ul style="list-style-type: none"> <li>▪ Once the DIP switch has been activated, the device must be restarted before the device uses the standard IP address.</li> <li>▪ If the standard IP address (DIP switch No. 10 = ON) is used, there is no connection to the EtherNet/IP network.</li> </ul> </p>

#### Software of the computer

Web browsers supported	<ul style="list-style-type: none"> <li>▪ Microsoft Internet Explorer (min. 8.x)</li> <li>▪ Mozilla Firefox</li> <li>▪ Google chrome</li> </ul>
Recommended operating systems	<ul style="list-style-type: none"> <li>▪ Windows XP</li> <li>▪ Windows 7</li> </ul>
User rights for TCP/IP settings	User rights required for TCP/IP settings (e.g. for changes to IP address, subnet mask)
Computer configuration	<ul style="list-style-type: none"> <li>▪ JavaScript is enabled</li> <li>▪ If JavaScript cannot be enabled, enter <code>http://XXX.XXX.X.XXX/basic.html</code> in the address line of the Web browser, e.g. <code>http://192.168.1.212/basic.html</code>. A fully functional but simplified version of the operating menu structure starts in the Web browser.</li> </ul>

 When installing a new firmware version:  
 To enable correct data display, clear the temporary memory (cache) of the Web browser under **Internet options**.

### 8.3.3 Establishing a connection

#### Configuring the Internet protocol of the computer

The following information refers to the default Ethernet settings of the device.

IP address of the device: 192.168.1.212 (factory setting)

<b>IP address</b>	192.168.1.XXX; for XXX all numerical values except: 0, 212 and 255 → e.g. 192.168.1.213
<b>Subnet mask</b>	255.255.255.0
<b>Default gateway</b>	192.168.1.212 or leave cells empty

1. Switch on the measuring device and connect to the computer via the cable (→  38).
2. If a 2nd network card is not used: all the applications on the notebook should be closed, or all the applications that require the Internet or network, such as e-mail, SAP applications, Internet or Windows Explorer, i.e. close all open Internet browsers.
3. Configure the properties of the Internet protocol (TCP/IP) as defined in the table above.



### Starting the Web browser

1. Start the Web browser on the computer.
2. If the IP address of the measuring device is known, enter the defined device address in the address line of the Web browser. If it is unknown, set DIP switch No. 10 to ON, restart the device and enter the standard IP address: 192.168.1.212 (→  34).

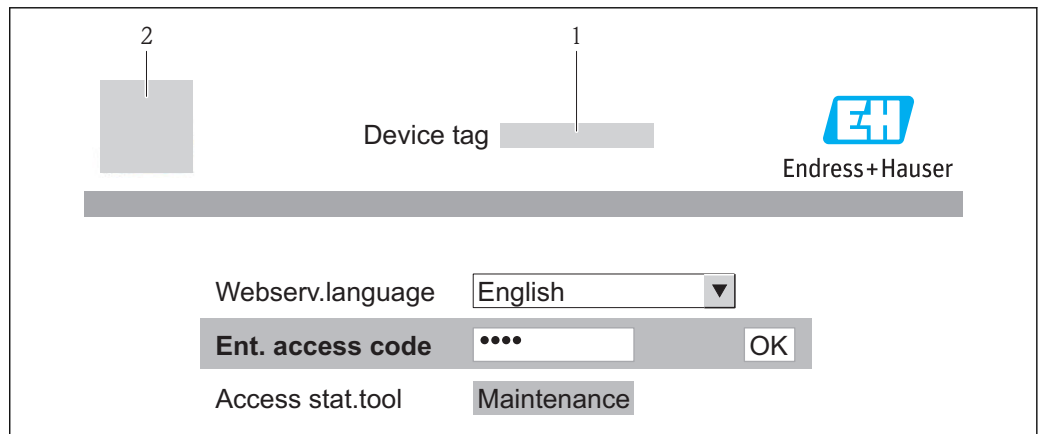
The login page appears.





- 1 Device tag (→  47)  
 2 Picture of device

 If a login page does not appear, or if the page is incomplete (→  67)

### 8.3.4 Logging on

1. Select the preferred operating language for the Web browser.
2. Enter the access code.
3. Press **OK** to confirm your entry.

<b>Access code</b>	0000 (factory setting); can be changed by customer (→  59)
--------------------	-------------------------------------------------------------------------------------------------------------------------------------------------

 If no action is performed for 10 minutes, the Web browser automatically returns to the login page.

### 8.3.5 User interface

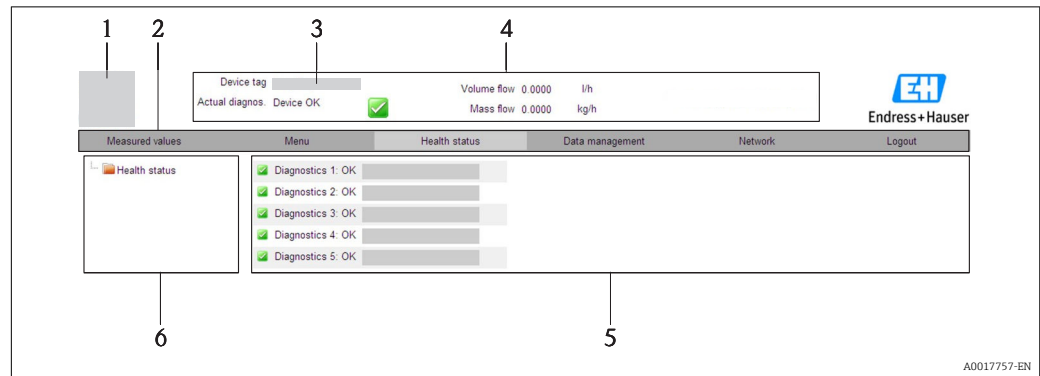

- 1 Picture of device
- 2 Function row with 6 functions
- 3 Device tag
- 4 Header
- 5 Working area
- 6 Navigation area

#### Header

The following information appears in the header:

- Device tag (→ 47)
- Device status with status signal (→ 69)
- Current measured values

#### Function row

Functions	Meaning
Measured values	The measured values of the device are displayed
Menu	Access to the operating menu structure of the device, same as for the operating tool
Device status	Displays the diagnostic messages currently pending, listed in order of priority
Data management	<ul style="list-style-type: none"> <li>■ Data exchange between PC and measuring device:                             <ul style="list-style-type: none"> <li>- Upload the configuration from the device (XML format, create configuration back-up)</li> <li>- Save the configuration to the device (XML format, restore configuration)</li> <li>- Export the event list (.csv file)</li> <li>- Export parameter settings (.csv file, create documentation of the measuring point configuration)</li> <li>- Export the Heartbeat verification log (PDF file, only available with the "Heartbeat Verification" application package)</li> </ul> </li> <li>■ Upload the device driver for system integration from the device</li> </ul>
Network configuration	Configuration and checking of all the parameters required for establishing the connection to the device: <ul style="list-style-type: none"> <li>■ Network settings (e.g. IP address, MAC address)</li> <li>■ Device information (e.g. serial number, firmware version)</li> </ul>
Logout	End the operation and call up the login page

#### Navigation area

If a function is selected in the function bar, the submenus of the function open in the navigation area. The user can now navigate through the menu structure.

### Working area

Depending on the selected function and the related submenus, various actions can be performed in this area:

- Configuring parameters
- Reading measured values
- Calling up help text
- Starting an upload/download

### 8.3.6 Disabling the Web server

The Web server for the measuring device can be enabled and disabled as required via the **Web server functionality** parameter.

#### Navigation

"Expert" menu → Communication → Web server

#### Parameter overview with brief description

Parameter	Description	Selection	Factory setting
Web server functionality	Switch the Web server on and off.	<ul style="list-style-type: none"> <li>■ Off</li> <li>■ On</li> </ul>	On

#### Enabling the Web server

If the Web server is disabled it can only be re-enabled with the **Web server functionality** parameter via the following operating options:

Via "FieldCare" operating tool

### 8.3.7 Logging out

 Before logging out, perform a data backup via the **Data management** function (upload configuration from device) if necessary.

1. Select the **Logout** entry in the function row.  
↳ The home page with the Login box appears.
2. Close the Web browser.
3. Reset the modified properties of the Internet protocol (TCP/IP) if they are no longer needed (→  34).

 If communication with the Web server was established via the standard IP address 192.168.1.212, DIP switch No. 10 must be reset (from ON → OFF) and the IP address of the device is active again for network communication.

## 8.4 Access to the operating menu via the operating tool

### 8.4.1 Connecting the operating tool

#### Via Ethernet-based fieldbus

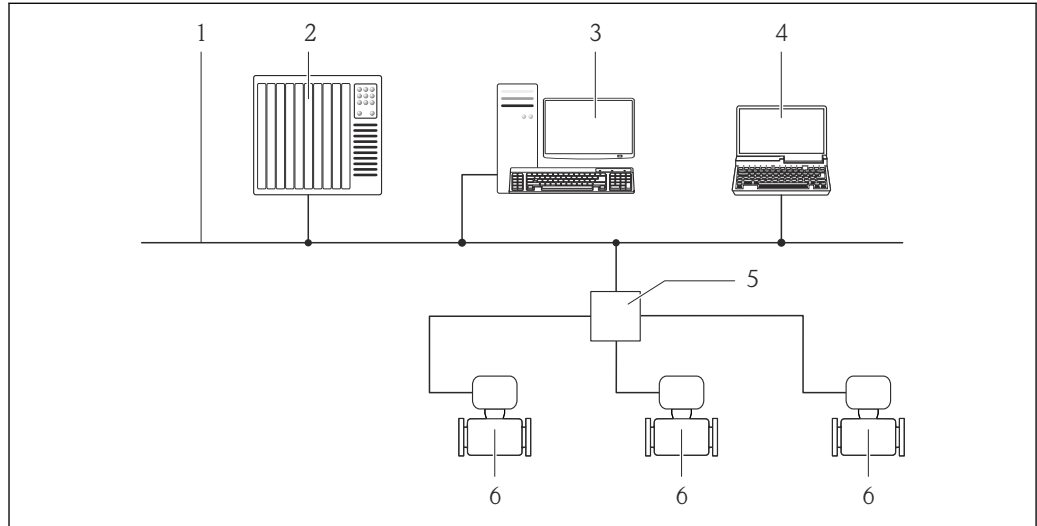

A0016961

- 1 Ethernet network
- 2 Automation system, e.g. "RSLogix" (Rockwell Automation)
- 3 Workstation for measuring device operation: with Add-on Profile Level 3 for "RSLogix 5000" (Rockwell Automation) or with Electronic Data Sheet (EDS)
- 4 Computer with Web browser (e.g. Internet Explorer) for accessing the integrated device Web server or with "FieldCare" operating tool with COM DTM "CDI Communication TCP/IP"
- 5 Ethernet switch
- 6 Measuring device

#### Via service interface (CDI-RJ45)

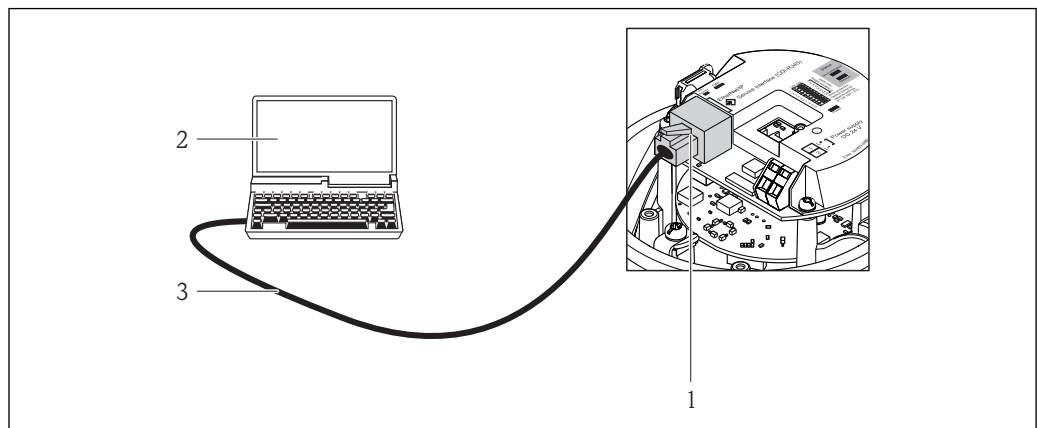

A0016940

 10 Connection for order code for "Output", option N: EtherNet/IP

- 1 Service interface (CDI -RJ45) and EtherNet/IP interface of the measuring device with access to the integrated Web server
- 2 Computer with Web browser (e.g. Internet Explorer) for accessing the integrated device Web server or with "FieldCare" operating tool with COM DTM "CDI Communication TCP/IP"
- 3 Standard Ethernet connecting cable with RJ45 plug

## 8.4.2 FieldCare

### Function scope

FDT-based plant asset management tool from Endress+Hauser. It can configure all smart field devices in a system and helps you manage them. By using the status information, it is also a simple but effective way of checking their status and condition.

Access takes place via:

Service interface CDI-RJ45 (→  38)

Typical functions:

- Configuring parameters of transmitters
- Loading and saving device data (upload/download)
- Documentation of the measuring point
- Visualization of the measured value memory (line recorder) and event logbook

 For details, see Operating Instructions BA00027S and BA00059S

### Source for device description files

See data (→  41)

### Establishing a connection

Via service interface (CDI-RJ45)

1. Start FieldCare and launch the project.
2. In the network: Add a device.
  - ↳ The **Add device** window opens.
3. Select the **CDI Communication TCP/IP** option from the list and press **OK** to confirm.
4. Right-click **CDI Communication TCP/IP** and select the **Add device** option in the context menu that opens.
5. Select the desired device from the list and press **OK** to confirm.
  - ↳ The **CDI Communication TCP/IP (Configuration)** window opens.
6. Enter the device address in the **IP address** field and press **Enter** to confirm: 192.168.1.212 (factory setting); if the IP address is not known (→  62).
7. Establish the online connection to the device.

 For details, see Operating Instructions BA00027S and BA00059S

User interface

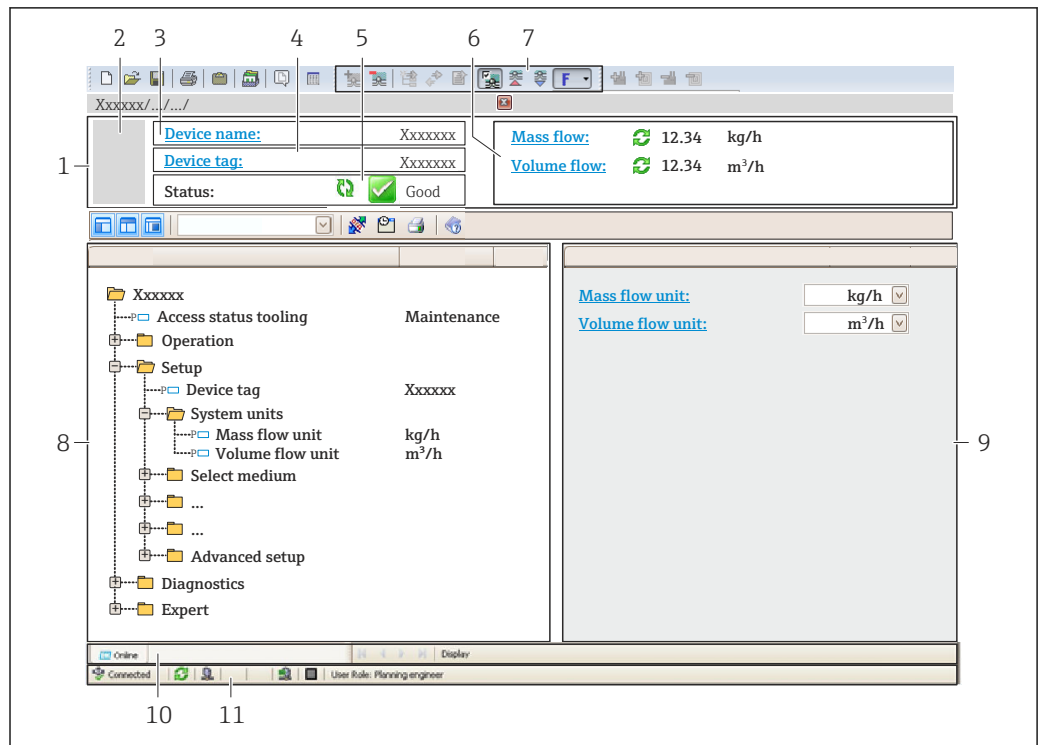

A0021051-EN

- 1 Header
- 2 Picture of device
- 3 Device name
- 4 Device tag (→ 47)
- 5 Status area with status signal (→ 69)
- 6 Display area for current measured values (→ 63)
- 7 Event list with additional functions such as save/load, events list and document creation
- 8 Navigation area with operating menu structure
- 9 Operating range
- 10 Range of action
- 11 Status area



## 9 System integration

### 9.1 Overview of device description files

#### 9.1.1 Current version data for the device

Firmware version	01.02.zz	<ul style="list-style-type: none"> <li>On the title page of the Operating instructions</li> <li>On transmitter nameplate (→ 13)</li> <li>Parameter <b>firmware version</b> Diagnostics → Device info → Firmware version</li> </ul>
Release date of firmware version	10.2014	---
Manufacturer ID	0x49E	<b>Manufacturer ID</b> parameter Diagnostics → Device info → Manufacturer ID
Device type ID	0x104A	<b>Device type</b> parameter Diagnostics → Device info → Device type
Device revision	<ul style="list-style-type: none"> <li>Major revision 2</li> <li>Minor revision 1</li> </ul>	<ul style="list-style-type: none"> <li>On transmitter nameplate (→ 13)</li> <li><b>Device revision</b> parameter Diagnostics → Device info → Device revision</li> </ul>
Device profile	Generic device (product type: 0x2B)	

#### 9.1.2 Operating tools

The suitable device description file for the individual operating tools is listed in the table below, along with information on where the file can be acquired.

The suitable device description file for the operating tool is listed in the table below, along with information on where the file can be acquired.

Operating tool via service interface (CDI)	Sources for obtaining device descriptions
FieldCare	<ul style="list-style-type: none"> <li><a href="http://www.endress.com">www.endress.com</a> → Download Area</li> <li>CD-ROM (contact Endress+Hauser)</li> <li>DVD (contact Endress+Hauser)</li> </ul>

### 9.2 Overview of system files

System files	Version	Description	How to acquire
Electronic Data Sheet (EDS system file)	2.1	Certified in accordance with the following ODVA guidelines: <ul style="list-style-type: none"> <li>Conformance test</li> <li>Performance test</li> <li>PlugFest</li> </ul> Embedded EDS Support (File Object 0x37)	<ul style="list-style-type: none"> <li><a href="http://www.endress.com">www.endress.com</a> → Download Area</li> <li>EDS system file integrated in the device: can be downloaded via the Web browser (→ 36)</li> </ul>
Add-on Profile Level 3	<ul style="list-style-type: none"> <li>Major revision 2</li> <li>Minor revision 1</li> </ul>	System file for "RSLogix 5000" software (Rockwell Automation)	<a href="http://www.endress.com">www.endress.com</a> → Download Area

## 9.3 Integrating the measuring device in the system

 A detailed description of how to integrate the device into an automation system (e.g. from Rockwell Automation) is available as a separate document: [www.endress.com](http://www.endress.com) → Select country → Automation → Digital Communication → Feldbus device integration → EtherNet/IP



 For information on the protocol-specific data of EtherNet/IP

## 9.4 Cyclic data transmission

Cyclic data transmission when using the device master file (GSD).

### 9.4.1 Block model

The block model shows which input and output data the measuring device makes available for implicit messaging. Cyclical data exchange is performed using an EtherNet/IP scanner, e.g. a distributed control system etc.

Measuring device				Control system
Transducer Block	Input Assembly Fix (Assem100) 44 Byte	(→  43)	Permanently assigned input group	→
	Output Assembly Fix (Assem102) 64 Byte	(→  44)	Permanently assigned output group	←
	Input Assembly Fix (Assem101) 88 Byte	(→  44)	Configurable input group	→
				EtherNet/IP

### 9.4.2 Input and output groups

#### Possible configurations

##### Configuration 1: Exclusive Owner Multicast

Input Assembly Fix		Instance	Size [byte]	min. RPI (ms)
Input Assembly Configurable	Configuration	0 x 64	398	–
Output Assembly Fix	O → T Configuration	0 x 66	64	5
Input Assembly Fix	T → O Configuration	0 x 64	44	5

##### Configuration 2: Input Only Multicast

Input Assembly Fix		Instance	Size [byte]	min. RPI (ms)
Input Assembly Configurable	Configuration	0 x 68	398	–
Output Assembly Fix	O → T Configuration	0 x C7	–	–
Input Assembly Fix	T → O Configuration	0 x 64	44	5

##### Configuration 3: Exclusive Owner Multicast

Input Assembly Configurable		Instance	Size [byte]	min. RPI (ms)
Input Assembly Configurable	Configuration	0 x 68	398	–
Output Assembly Fix	O → T Configuration	0 x 66	64	5
Input Assembly Fix	T → O Configuration	0 x 65	88	5

*Configuration 4: Input Only Multicast*

Input Assembly Configurable		Instance	Size [byte]	min. RPI (ms)
Input Assembly Configurable	Configuration	0 x 68	398	–
Output Assembly Fix	O → T Configuration	0 x C7	–	–
Input Assembly Fix	T → O Configuration	0 x 64	88	5

*Configuration 5: Exclusive Owner Multicast*

Input Assembly Fix		Instance	Size [byte]	min. RPI (ms)
Input Assembly Configurable	Configuration	0 x 69	–	–
Output Assembly Fix	O → T Configuration	0 x 66	64	5
Input Assembly Fix	T → O Configuration	0 x 64	44	5

*Configuration 6: Input Only Multicast*

Input Assembly Fix		Instance	Size [byte]	min. RPI (ms)
Input Assembly Configurable	Configuration	0 x 69	–	–
Output Assembly Fix	O → T Configuration	0 x C7	–	–
Input Assembly Fix	T → O Configuration	0 x 65	44	5

*Configuration 7: Exclusive Owner Multicast*

Input Assembly Configurable		Instance	Size [byte]	min. RPI (ms)
Input Assembly Configurable	Configuration	0 x 69	–	–
Output Assembly Fix	O → T Configuration	0 x 66	64	5
Input Assembly Fix	T → O Configuration	0 x 64	88	5

*Configuration 8: Input Only Multicast*

Input Assembly Configurable		Instance	Size [byte]	min. RPI (ms)
Input Assembly Configurable	Configuration	0 x 69	–	–
Output Assembly Fix	O → T Configuration	0 x C7	–	–
Input Assembly Fix	T → O Configuration	0 x 65	88	5



**Permanently assigned input group**

Input Assembly Fix (Assem100) 44 Byte

Name	Description	Byte
Input Assembly Fix	1. File header (not visible)	1 to 4
	2. Current diagnosis <sup>1)</sup>	5 to 8
	3. Mass flow	9 to 12
	4. Volume flow	13 to 16
	5. Corrected volume flow	17 to 20
	6. Temperature	21 to 24
	7. Density	25 to 28
	8. Reference density	29 to 32
	9. Totalizer 1	33 to 36

Name	Description	Byte
	10. Totalizer 2	37 to 40
	11. Totalizer 3	41 to 44

1) Structure: Code, number, description (e.g.: 16777265 F882 input signal)

-  Detailed description
- Diagnostic information (→  72)
  - Information events (→  76)

### Configurable input group

Input Assembly Configurable (Assem101) 88 byte

Name	Description	Format
Input Assembly Configurable	1. - 10. Input values 1 to 10	Real
	11. - 20. Input values 11 to 20	Double integer

#### Possible input values

Possible input values 1 to 10:		
<ul style="list-style-type: none"> <li>▪ Off</li> <li>▪ Mass flow</li> <li>▪ Volume flow</li> <li>▪ Corrected volume flow</li> <li>▪ Target mass flow</li> <li>▪ Carrier mass flow</li> <li>▪ Density</li> <li>▪ Reference density</li> <li>▪ Concentration</li> </ul>	<ul style="list-style-type: none"> <li>▪ Temperature</li> <li>▪ Carrier pipe temperature</li> <li>▪ Electronics temperature</li> <li>▪ Oscillation frequency 0</li> <li>▪ Oscillation frequency 1</li> <li>▪ Oscillation amplitude 0</li> <li>▪ Oscillation amplitude 1</li> <li>▪ Oscillation frequency 0</li> <li>▪ Oscillation frequency 1</li> <li>▪ Oscillation damping 0</li> <li>▪ Oscillation damping 1</li> <li>▪ Signal shift</li> </ul>	<ul style="list-style-type: none"> <li>▪ Tube damping fluctuation 0</li> <li>▪ Tube damping fluctuation 1</li> <li>▪ Exciter current 0</li> <li>▪ Exciter current 1</li> <li>▪ Monitoring of exciter current 0</li> <li>▪ Monitoring of exciter current 1</li> <li>▪ Totalizer 1</li> <li>▪ Totalizer 2</li> <li>▪ Totalizer 3</li> <li>▪ Sensor integrity</li> </ul>

Possible input values 11 to 20:		
<ul style="list-style-type: none"> <li>▪ Off</li> <li>▪ Current diagnosis</li> <li>▪ Previous diagnosis</li> <li>▪ Mass flow unit</li> <li>▪ Volume flow unit</li> <li>▪ Corrected volume flow unit</li> </ul>	<ul style="list-style-type: none"> <li>▪ Temperature unit</li> <li>▪ Density unit</li> <li>▪ Reference density unit</li> <li>▪ Concentration unit</li> <li>▪ Current unit</li> <li>▪ Status verification</li> </ul>	<ul style="list-style-type: none"> <li>▪ Totalizer 1 unit</li> <li>▪ Totalizer 2 unit</li> <li>▪ Totalizer 3 unit</li> <li>▪ Verification result</li> </ul>

### Permanently assigned output group

Output Assembly Fix (Assem102) 64 byte



Name	Description (format)	Byte	Bit	Value
Output Assembly Fix	1. Totalizer 1	1	1	<ul style="list-style-type: none"> <li>▪ 0: Enable</li> <li>▪ 1: Disable</li> </ul>
	2. Totalizer 2		2	
	3. Totalizer 3		3	
	4. Pressure compensation		4	
	5. Reference density compensation		5	
	6. Temperature compensation		6	
	7. Verification		7	

Name	Description (format)	Byte	Bit	Value
	8. Not used		8	–
	9. Not used	2 to 4	0 to 8	–
	10. Control totalizer 1 (integer)	5 to 6	0 to 8	<ul style="list-style-type: none"> <li>■ 32226: Add</li> <li>■ 32490: Reset and stop</li> <li>■ 32228: Default value and stop</li> <li>■ 198: Reset and add</li> <li>■ 199: Default value and add</li> </ul>
	11. Not used	7 to 8	0 to 8	–
	12. Control totalizer 2 (integer)	9...10	0 to 8	See totalizer 1
	13. Not used	11 to 12	0 to 8	–
	14. Control totalizer 3 (integer)	13 to 14	0 to 8	See totalizer 1
	15. Not used	15 to 16	0 to 8	–
	16. External pressure (real)	17 to 20	0 to 8	Data format: Byte 1 to 4: External pressure Floating-point number (IEEE754)
	17. External pressure unit (integer)	21 to 22	0 to 8	<ul style="list-style-type: none"> <li>■ 2165: Pa a</li> <li>■ 2116: kPa a</li> <li>■ 2137: MPa a</li> <li>■ 4871: bar a</li> <li>■ 2166: Pa g</li> <li>■ 2117: kPa a</li> <li>■ 2138: MPa a</li> <li>■ 2053: bar g</li> <li>■ 2182: Psi a</li> <li>■ 2183: Psi g</li> <li>■ 2244: Customer-specific</li> </ul>
	18. Not used	23 to 24	0 to 8	–
	19. External reference density (real)	25 to 28	0 to 8	Data format: Byte 1 to 4: External ref. density Floating-point number (IEEE754)
	20. External reference density unit (integer)	29 to 30	0 to 8	<ul style="list-style-type: none"> <li>■ 2112: kg/Nm<sup>3</sup></li> <li>■ 2113: kg/Nl</li> <li>■ 2092: g/Scm<sup>3</sup></li> <li>■ 2114: kg/Scm<sup>3</sup></li> <li>■ 2181: lb/Sft<sup>3</sup></li> </ul>
	21. Not used	31 to 32	0 to 8	–
	22. External temperature (real)	33 to 36	0 to 8	Data format: Byte 1 to 4: External temperature Floating-point number (IEEE754)
	23. External temperature unit (integer)	37 to 38	0 to 8	<ul style="list-style-type: none"> <li>■ 4608: °C</li> <li>■ 4609: °F</li> <li>■ 4610: K</li> <li>■ 4611: °R</li> </ul>
	24. Not used	39 to 40	0 to 8	–
	25. Start verification (integer)	41 to 42	0 to 8	<ul style="list-style-type: none"> <li>■ 32378: Start</li> <li>■ 32713: Cancel</li> </ul>
	26. Not used	43 to 64	0 to 8	–

## 10 Commissioning

### 10.1 Function check

Before commissioning the device, make sure that the post-installation and post-connection checks have been performed.

- "Post-installation check" checklist (→  22)
- "Post-connection check" checklist (→  30)

### 10.2 Configuring the device address via software

In the **"Communication"** submenu the device address can be set.



#### Navigation

"Setup" menu → Communication → Device address

#### 10.2.1 Ethernet network and Web server

When delivered, the measuring device has the following factory settings:

IP address	192.168.1.212
Subnet mask	255.255.255.0
Default gateway	192.168.1.212

-  ▪ If hardware addressing is active, software addressing is disabled.
- If a switch is made to hardware addressing, the address configured via software addressing is retained for the first 9 places (the first three octets).
- If the IP address of the device is not known, the device address currently configured can be read out (→  62).

### 10.3 Configuring the measuring device

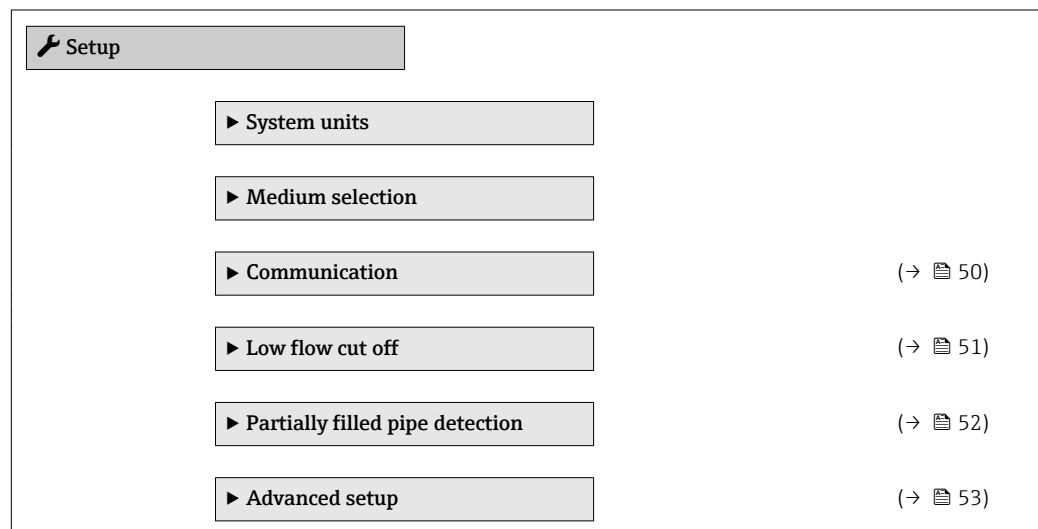

The **Setup** menu with its submenus contains all the parameters needed for standard operation.



### 10.3.1 Defining the tag name

To enable fast identification of the measuring point within the system, you can enter a unique designation using the **Device tag** parameter and thus change the factory setting.

 The number of characters displayed depends on the characters used.

 For information on the tag name in the "FieldCare" operating tool (→  40)

#### Navigation

"Setup" menu → Device tag

#### Parameter overview with brief description

Parameter	Description	User entry	Factory setting
Device tag	Enter the name for the measuring point.	Max. 32 characters, such as letters, numbers or special characters (e.g. @, %, /).	Promag 400

### 10.3.2 Setting the system units

In the **System units** submenu the units of all the measured values can be set.

*Structure of the submenu*

System units

→

Mass flow unit

Mass unit

Volume flow unit

Volume unit

Corrected volume flow unit

Corrected volume unit

Density unit

Reference density unit

Temperature unit

Pressure unit

## Parameter overview with brief description

Parameter	Description	Selection	Factory setting
Mass flow unit	Select mass flow unit. <i>Result</i> The selected unit applies for: <ul style="list-style-type: none"> <li>▪ Output</li> <li>▪ Low flow cut off</li> <li>▪ Simulation process variable</li> </ul>	Unit choose list	Country-specific: <ul style="list-style-type: none"> <li>▪ kg/h</li> <li>▪ lb/min</li> </ul>
Mass unit	Select mass unit. <i>Result</i> The selected unit is taken from: <b>Mass flow unit</b> parameter	Unit choose list	Country-specific: <ul style="list-style-type: none"> <li>▪ kg</li> <li>▪ lb</li> </ul>
Volume flow unit	Select volume flow unit. <i>Result</i> The selected unit applies for: <ul style="list-style-type: none"> <li>▪ Output</li> <li>▪ Low flow cut off</li> <li>▪ Simulation process variable</li> </ul>	Unit choose list	Country-specific: <ul style="list-style-type: none"> <li>▪ l/h</li> <li>▪ gal/min (us)</li> </ul>
Volume unit	Select volume unit. <b>Result</b> The selected unit is taken from: <b>Volume flow unit</b> parameter	Unit choose list	Country-specific: <ul style="list-style-type: none"> <li>▪ l</li> <li>▪ gal (us)</li> </ul>
Corrected volume flow unit	Select corrected volume flow unit. <i>Result</i> The selected unit applies for: <ul style="list-style-type: none"> <li>▪ Output</li> <li>▪ Low flow cut off</li> <li>▪ Simulation process variable</li> </ul>	Unit choose list	Country-specific: <ul style="list-style-type: none"> <li>▪ NI/h</li> <li>▪ Sft<sup>3</sup>/h</li> </ul>
Corrected volume unit	Select corrected volume unit. <i>Result</i> The selected unit is taken from: <b>Corrected volume flow unit</b> parameter	Unit choose list	Country-specific: <ul style="list-style-type: none"> <li>▪ NI</li> <li>▪ Sft<sup>3</sup></li> </ul>
Density unit	Select density unit. <i>Result</i> The selected unit applies for: <ul style="list-style-type: none"> <li>▪ Output</li> <li>▪ Simulation process variable</li> </ul>	Unit choose list	Country-specific: <ul style="list-style-type: none"> <li>▪ kg/l</li> <li>▪ lb/ft<sup>3</sup></li> </ul>
Reference density unit	Select reference density unit.	Unit choose list	kg/NI
Temperature unit	Select temperature unit. <i>Result</i> The selected unit applies for: <ul style="list-style-type: none"> <li>▪ Output</li> <li>▪ Reference temperature</li> <li>▪ Simulation process variable</li> </ul>	Unit choose list	Country-specific: <ul style="list-style-type: none"> <li>▪ °C (Celsius)</li> <li>▪ °F (Fahrenheit)</li> </ul>
Pressure unit	Select process pressure unit.	Unit choose list	Country-specific: <ul style="list-style-type: none"> <li>▪ bar</li> <li>▪ psi</li> </ul>



### 10.3.3 Selecting and setting the medium

The **Medium selection** submenu contains parameters that have to be configured for selecting and setting the medium.

#### Navigation

"Setup" menu → Select medium

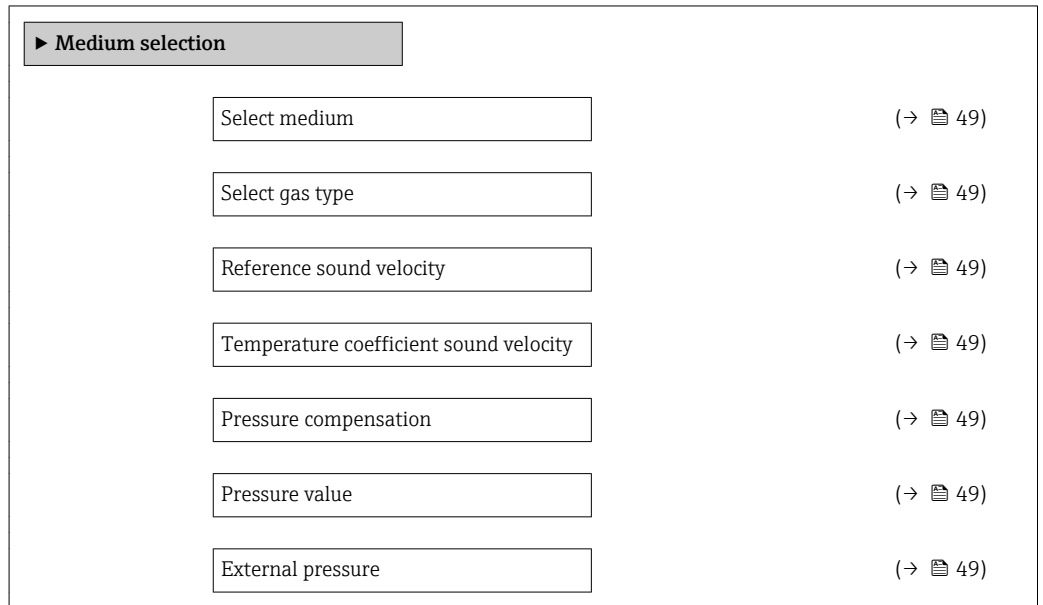

#### Parameter overview with brief description

Parameter	Prerequisite	Description	Selection / User entry	Factory setting
Select medium	–	Select medium type.	Gas	Liquid
Select gas type	The following option is selected in the <b>Medium selection</b> parameter: Gas	Select measured gas type.	Gas type choose list	Methane CH <sub>4</sub>
Reference sound velocity	The following option is selected in the <b>Select gas type</b> parameter: Others	Enter sound velocity of gas at 0 °C (32 °F).	1 to 99 999.9999 m/s	0 m/s
Temperature coefficient sound velocity	The following option is selected in the <b>Select gas type</b> parameter: Others	Enter temperature coefficient for the gas sound velocity.	Positive floating-point number	0 (m/s)/K
Pressure compensation	The following option is selected in the <b>Medium selection</b> parameter: Gas	Select pressure compensation type.	<ul style="list-style-type: none"> <li>■ Off</li> <li>■ Fixed value</li> <li>■ External value</li> </ul>	Off
Pressure value	The following option is selected in the <b>Pressure compensation</b> parameter: Fixed value	Enter process pressure to be used for pressure correction.	Positive floating-point number	0 bar
External pressure	The following option is selected in the <b>Pressure compensation</b> parameter: External value		Positive floating-point number	0 bar

### 10.3.4 Configuring the communication interface



The "**Communication**" submenu guides you systematically through all the parameters that have to be configured for selecting and setting the communication interface.

#### Navigation

"Setup" menu → Communication

▶ Communication

#### Parameter overview with brief description

Parameter	Description	User interface / Selection / User entry	Factory setting
MAC address	Displays the MAC address of the measuring device.  MAC = Media Access Control	Unique 12-digit character string comprising letters and numbers, e.g.: 00:07:05:10:01:5F	Each measuring device is given an individual address.
Default network settings	Select whether to restore network settings.	<ul style="list-style-type: none"> <li>▪ Off</li> <li>▪ On</li> </ul>	Off
DHCP client	Select to activate/deactivate DHCP client functionality. <b>Result</b> If the web server's DHCP client functionality is activated, the IP address, subnet mask and default gateway are automatically set.  Identification is via the MAC address of the measuring device.	<ul style="list-style-type: none"> <li>▪ Off</li> <li>▪ On</li> </ul>	On
IP address	Displays the IP address of the Web server of the measuring device.	4 octet: 0 to 255 (in the particular octet)	192.168.1.212
Subnet mask	Displays the subnet mask.	4 octet: 0 to 255 (in the particular octet)	255.255.255.0
Default gateway	Displays the default gateway.	4 octet: 0 to 255 (in the particular octet)	0.0.0.0

### 10.3.5 Configuring the low flow cut off

The **Low flow cut off** submenu contains parameters that must be configured for the configuration of low flow cut off.

#### Navigation

"Setup" menu → Low flow cut off

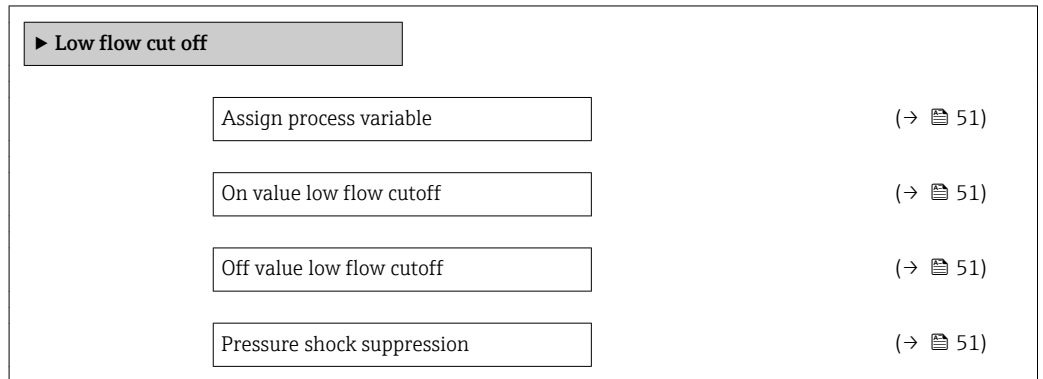

#### Parameter overview with brief description

Parameter	Prerequisite	Description	Selection / User entry	Factory setting
Assign process variable	–	Select process variable for low flow cut off.	<ul style="list-style-type: none"> <li>▪ Off</li> <li>▪ Mass flow</li> <li>▪ Volume flow</li> <li>▪ Corrected volume flow</li> </ul>	Mass flow
On value low flow cutoff	In the <b>Assign process variable</b> parameter, one of the following options is selected: <ul style="list-style-type: none"> <li>▪ Mass flow</li> <li>▪ Volume flow</li> <li>▪ Corrected volume flow</li> </ul>	Enter on value for low flow cut off.	Positive floating-point number	For liquids: depends on country and nominal diameter
Off value low flow cutoff	In the <b>Assign process variable</b> parameter, one of the following options is selected: <ul style="list-style-type: none"> <li>▪ Mass flow</li> <li>▪ Volume flow</li> <li>▪ Corrected volume flow</li> </ul>	Enter off value for low flow cut off.	0 to 100.0 %	50 %
Pressure shock suppression	In the <b>Assign process variable</b> parameter, one of the following options is selected: <ul style="list-style-type: none"> <li>▪ Mass flow</li> <li>▪ Volume flow</li> <li>▪ Corrected volume flow</li> </ul>	Enter time frame for signal suppression (= active pressure shock suppression).	0 to 100 s	0 s

### 10.3.6 Configuring the partial filled pipe detection

The **Partially filled pipe detection** submenu contains parameters that have to be set for configuring empty pipe detection.

#### Navigation

"Setup" menu → Partially filled pipe detection

▶ Partially filled pipe detection	
Assign process variable	(→ ⓘ 52)
Low value partial filled pipe detection	(→ ⓘ 52)
High value partial filled pipe detection	(→ ⓘ 52)
Response time part. filled pipe detect.	(→ ⓘ 52)

#### Parameter overview with brief description

Parameter	Prerequisite	Description	Selection / User entry	Factory setting
Assign process variable	–	Select process variable for partially filled pipe detection.	<ul style="list-style-type: none"> <li>▪ Off</li> <li>▪ Density</li> <li>▪ Reference density</li> </ul>	Off
Low value partial filled pipe detection	One of the following options is selected in the <b>Assign process variable</b> parameter: <ul style="list-style-type: none"> <li>▪ Density</li> <li>▪ Reference density</li> </ul>	Enter lower limit value for deactivating partially filled pipe detection.	Signed floating-point number	Country-dependent: <ul style="list-style-type: none"> <li>▪ 0.2 kg/l</li> <li>▪ 12.5 lb/ft<sup>3</sup></li> </ul>
High value partial filled pipe detection	One of the following options is selected in the <b>Assign process variable</b> parameter: <ul style="list-style-type: none"> <li>▪ Density</li> <li>▪ Reference density</li> </ul>	Enter upper limit value for deactivating partially filled pipe detection.	Signed floating-point number	Country-dependent: <ul style="list-style-type: none"> <li>▪ 6 kg/l</li> <li>▪ 374.6 lb/ft<sup>3</sup></li> </ul>
Response time part. filled pipe detect.	One of the following options is selected in the <b>Assign process variable</b> parameter: <ul style="list-style-type: none"> <li>▪ Density</li> <li>▪ Reference density</li> </ul>	Enter time before diagnostic message is displayed for partially filled pipe detection.	0 to 100 s	1 s

## 10.4 Advanced settings

The **Advanced setup** submenu with its submenus contains parameters for specific settings.

The number of submenus can vary depending on the device version, e.g. viscosity is available only with the Promass I.

### Navigation

"Setup" menu → Advanced setup

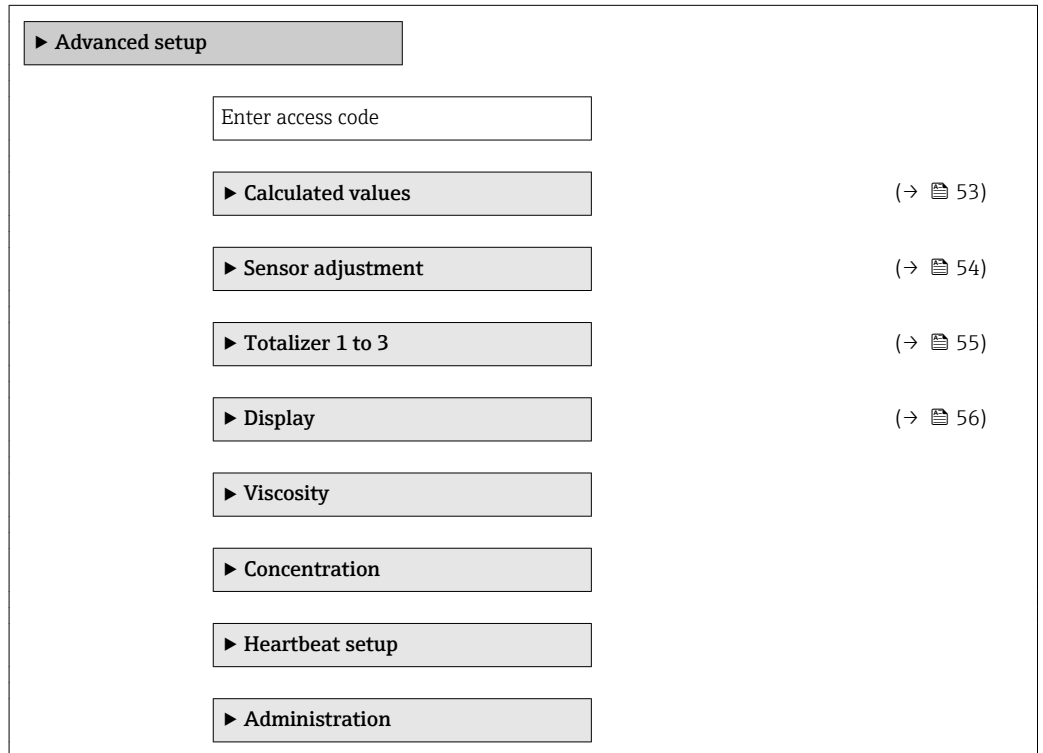

### 10.4.1 Calculated values

The **Calculated values** submenu contains parameters for calculating the corrected volume flow.

### Navigation

"Setup" menu → Advanced setup → Calculated values

*Structure of the submenu*

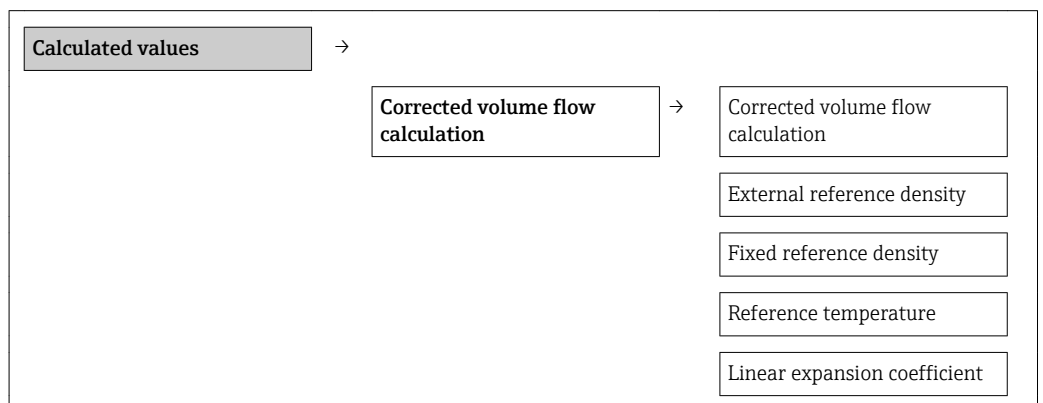

	Square expansion coefficient
--	------------------------------

### Parameter overview with brief description

Parameter	Prerequisite	Description	Selection / User entry	Factory setting
Corrected volume flow calculation	–	Select reference density for calculating the corrected volume flow.	<ul style="list-style-type: none"> <li>■ Fixed reference density</li> <li>■ Calculated reference density</li> <li>■ Reference density by API table 53</li> <li>■ External reference density</li> </ul>	Calculated reference density
External reference density	–	Shows external reference density.	Floating point number with sign	0 kg/Nl
Fixed reference density	The following option is selected in the <b>Corrected volume flow calculation</b> parameter: Fixed reference density	Enter fixed value for reference density.	Positive floating-point number	1 kg/Nl
Reference temperature	The following option is selected in the <b>Corrected volume flow calculation</b> parameter: Calculated reference density	Enter reference temperature for calculating the reference density.	–273.15 to 99 999 °C	20 °C
Linear expansion coefficient	The following option is selected in the <b>Corrected volume flow calculation</b> parameter: Calculated reference density	Enter linear, medium-specific expansion coefficient for calculating the reference density.	Signed floating-point number	0.0
Square expansion coefficient	–	For media with a non-linear expansion pattern: enter the quadratic, medium-specific expansion coefficient for calculating the reference density.	Signed floating-point number	0.0

## 10.4.2 Carrying out a sensor adjustment

The **Sensor adjustment** submenu contains parameters that pertain to the functionality of the sensor.

### Navigation

"Setup" menu → Advanced setup → Sensor adjustment

### Structure of the submenu

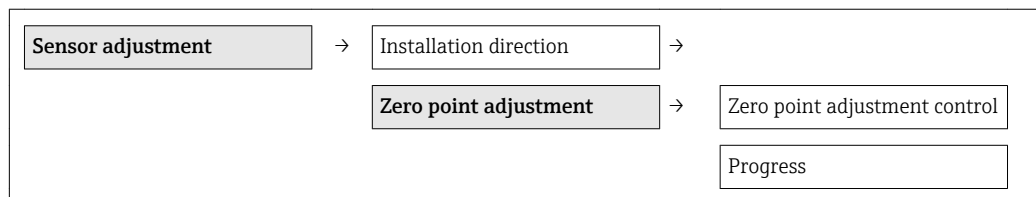

**Parameter overview with brief description**

Parameter	Description	Selection / User interface	Factory setting
Installation direction	Set sign of flow direction to match the direction of the arrow on the sensor.	<ul style="list-style-type: none"> <li>■ Flow in arrow direction</li> <li>■ Flow against arrow direction</li> </ul>	Flow in arrow direction
Zero point adjustment control	Start zero point adjustment.	<ul style="list-style-type: none"> <li>■ Cancel</li> <li>■ Busy</li> <li>■ Zero point adjust failure</li> <li>■ Start</li> </ul>	Cancel
Progress	Shows the progress of the process.	0 to 100 %	0 %

**10.4.3 Configuring the totalizer**

In the "Totalizer 1 to 3" submenu the individual totalizers can be configured.

**Navigation**

"Setup" menu → Advanced setup → Totalizer 1 to 3

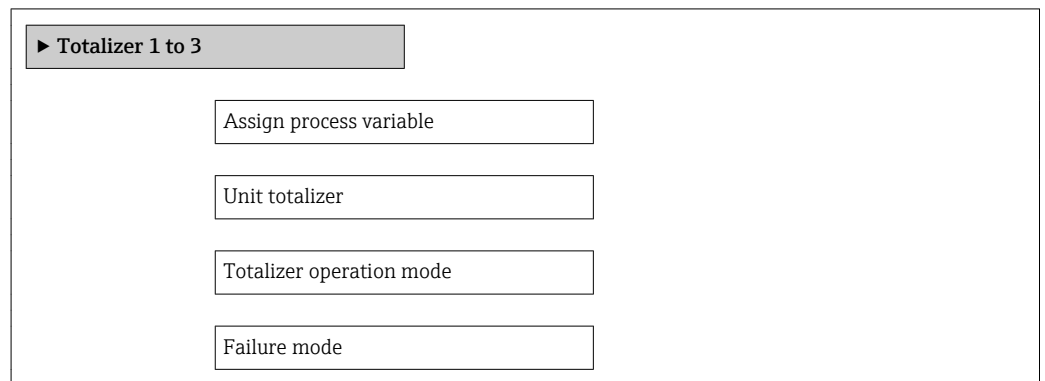

**Parameter overview with brief description**

Parameter	Description	Selection	Factory setting
Assign process variable	Select process variable for totalizer.	<ul style="list-style-type: none"> <li>■ Off</li> <li>■ Volume flow</li> <li>■ Mass flow</li> <li>■ Corrected volume flow</li> <li>■ Target mass flow</li> <li>■ Carrier mass flow</li> </ul>	Mass flow
Unit totalizer	Select process variable totalizer unit.	Unit choose list	kg
Totalizer operation mode	Select totalizer calculation mode.	<ul style="list-style-type: none"> <li>■ Net flow total</li> <li>■ Forward flow total</li> <li>■ Reverse flow total</li> </ul>	Net flow total
Failure mode	Define totalizer behavior in alarm condition.	<ul style="list-style-type: none"> <li>■ Stop</li> <li>■ Actual value</li> <li>■ Last valid value</li> </ul>	Stop

### 10.4.4 Carrying out additional display configurations

In the **"Display"** submenu you can set all the parameters involved in the configuration of the local display.

#### Navigation

"Setup" menu → Advanced setup → Display

► Display

- Format display
- Value 1 display
- 0% bargraph value 1
- 100% bargraph value 1
- Decimal places 1
- Value 2 display
- Decimal places 2
- Value 3 display
- 0% bargraph value 3
- 100% bargraph value 3
- Decimal places 3
- Value 4 display
- Decimal places 4
- Display language
- Display interval
- Display damping
- Header
- Header text
- Separator
- Backlight



## Parameter overview with brief description

Parameter	Description	Selection / User entry	Factory setting
Format display	Select how measured values are shown on the display.	<ul style="list-style-type: none"> <li>■ 1 value, max. size</li> <li>■ 1 bargraph + 1 value</li> <li>■ 2 values</li> <li>■ 1 value large + 2 values</li> <li>■ 4 values</li> </ul>	1 value, max. size
Value 1 display	Select the measured value that is shown on the local display.  Depending on the device version, not all options are available in this parameter. The selection can vary depending on the sensor, e.g. viscosity is available only with the Promass I.	<ul style="list-style-type: none"> <li>■ Mass flow</li> <li>■ Volume flow</li> <li>■ Corrected volume flow</li> <li>■ Target mass flow</li> <li>■ Carrier mass flow</li> <li>■ Density</li> <li>■ Reference density</li> <li>■ Concentration</li> <li>■ Dynamic viscosity</li> <li>■ Kinematic viscosity</li> <li>■ Temp. compensated dynamic viscosity</li> <li>■ Temp. compensated kinematic viscosity</li> <li>■ Temperature</li> <li>■ Carrier pipe temperature</li> <li>■ Electronic temperature</li> <li>■ Oscillation frequency 0</li> <li>■ Oscillation frequency 1</li> <li>■ Oscillation amplitude 0</li> <li>■ Oscillation amplitude 1</li> <li>■ Frequency fluctuation 0</li> <li>■ Frequency fluctuation 1</li> <li>■ Oscillation damping 0</li> <li>■ Oscillation damping 1</li> <li>■ Tube damping fluctuation 0</li> <li>■ Tube damping fluctuation 1</li> <li>■ Signal asymmetry</li> <li>■ Exciter current 0</li> <li>■ Exciter current 1</li> <li>■ Sensor integrity</li> <li>■ None</li> <li>■ Totalizer 1</li> <li>■ Totalizer 2</li> <li>■ Totalizer 3</li> </ul>	Mass flow
0% bargraph value 1	Enter 0% value for bar graph display.	Signed floating-point number	0 kg/h
100% bargraph value 1	Enter 100% value for bar graph display.	Signed floating-point number	2.5 kg/h
Decimal places 1	Select the number of decimal places for the display value.	<ul style="list-style-type: none"> <li>■ x</li> <li>■ x.x</li> <li>■ x.xx</li> <li>■ x.xxx</li> <li>■ x.xxxx</li> </ul>	x.xx
Value 2 display	Select the measured value that is shown on the local display.	Picklist (see 1st display value)	None
Decimal places 2	Select the number of decimal places for the display value.	<ul style="list-style-type: none"> <li>■ x</li> <li>■ x.x</li> <li>■ x.xx</li> <li>■ x.xxx</li> <li>■ x.xxxx</li> </ul>	x.xx
Value 3 display	Select the measured value that is shown on the local display.	Picklist (see 1st display value)	None
0% bargraph value 3	Enter 0% value for bar graph display.	Signed floating-point number	0
100% bargraph value 3	Enter 100% value for bar graph display.	Signed floating-point number	0

Parameter	Description	Selection / User entry	Factory setting
Decimal places 3	Select the number of decimal places for the display value.	<ul style="list-style-type: none"> <li>▪ x</li> <li>▪ x.x</li> <li>▪ x.xx</li> <li>▪ x.xxx</li> <li>▪ x.xxxx</li> </ul>	x.xx
Value 4 display	Select the measured value that is shown on the local display.	Picklist (see 1st display value)	None
Decimal places 4	Select the number of decimal places for the display value.	<ul style="list-style-type: none"> <li>▪ x</li> <li>▪ x.x</li> <li>▪ x.xx</li> <li>▪ x.xxx</li> <li>▪ x.xxxx</li> </ul>	x.xx
Display language	Set display language.	<ul style="list-style-type: none"> <li>▪ English</li> <li>▪ Deutsch</li> <li>▪ Français</li> <li>▪ Español</li> <li>▪ Italiano</li> <li>▪ Nederlands</li> <li>▪ Portuguesa</li> <li>▪ Polski</li> <li>▪ русский язык (Russian)</li> <li>▪ Svenska</li> <li>▪ Türkçe</li> <li>▪ 中文 (Chinese)</li> <li>▪ 日本語 (Japanese)</li> <li>▪ 한국어 (Korean)</li> <li>▪ العربية (Arabic)</li> <li>▪ Bahasa Indonesia</li> <li>▪ ภาษาไทย (Thai)</li> <li>▪ tiếng Việt (Vietnamese)</li> <li>▪ čeština (Czech)</li> </ul>	English (alternatively, the ordered language is preset in the device)
Display interval	Set time measured values are shown on display if display alternates between values.	1 to 10 s	5 s
Display damping	Set display reaction time to fluctuations in the measured value.	0.0 to 999.9 s	0.0 s
Header	Select header contents on local display.	<ul style="list-style-type: none"> <li>▪ Device tag</li> <li>▪ Free text</li> </ul>	Device tag
Header text	Enter display header text.		-----
Separator	Select decimal separator for displaying numerical values.	<ul style="list-style-type: none"> <li>▪ .</li> <li>▪ ,</li> </ul>	.
Backlight	Switch the local display backlight on and off.  Only for device version with onsite display SD03 (touch control)	<ul style="list-style-type: none"> <li>▪ Disable</li> <li>▪ Enable</li> </ul>	Enable

## 10.5 Simulation

The "**Simulation**" submenu enables you to simulate, without a real flow situation, various process variables in the process and the device alarm mode and to verify downstream signal chains (switching valves or closed-control loops).

### Navigation

"Diagnostics" menu → Simulation

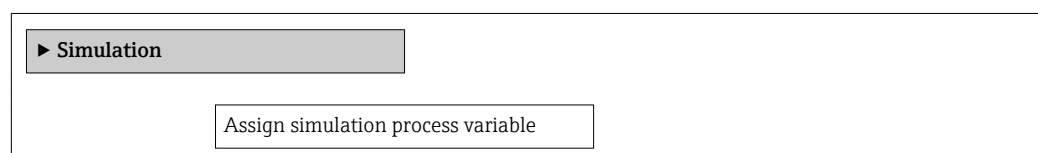

Value process variable
Simulation device alarm
Simulation diagnostic event
Diagnostic event category
Simulation diagnostic event

**Parameter overview with brief description**

Parameter	Prerequisite	Description	Selection / User entry	Factory setting
Assign simulation process variable	-	Select a process variable for the simulation process that is activated.  Depending on the device version, not all options are available in this parameter. The selection can vary depending on the sensor, e.g. viscosity is available only with the Promass I.	<ul style="list-style-type: none"> <li>▪ Off</li> <li>▪ Mass flow</li> <li>▪ Volume flow</li> <li>▪ Corrected volume flow</li> <li>▪ Density</li> <li>▪ Reference density</li> <li>▪ Temperature</li> <li>▪ Dynamic viscosity</li> <li>▪ Kinematic viscosity</li> <li>▪ Temp. compensated dynamic viscosity</li> <li>▪ Temp. compensated kinematic viscosity</li> <li>▪ Concentration</li> <li>▪ Target mass flow</li> <li>▪ Carrier mass flow</li> </ul>	Off
Value process variable	A process variable is selected in the <b>Assign simulation process variable</b> parameter.	Enter the simulation value for the selected process variable.	Signed floating-point number	0
Simulation device alarm	-	Switch the device alarm on and off.	<ul style="list-style-type: none"> <li>▪ Off</li> <li>▪ On</li> </ul>	Off

**10.6 Protecting settings from unauthorized access**

The following options exist for protecting the configuration of the measuring device from unintentional modification after commissioning:

- Write protection via access code for Web browser (→ 59)
- Write protection via write protection switch (→ 60)

**10.6.1 Write protection via access code**

With the customer-specific access code, access to the measuring device via the Web browser is protected, as are the parameters for the measuring device configuration.

**Navigation**

"Setup" menu → Advanced setup → Administration → Define access code

## Structure of the submenu

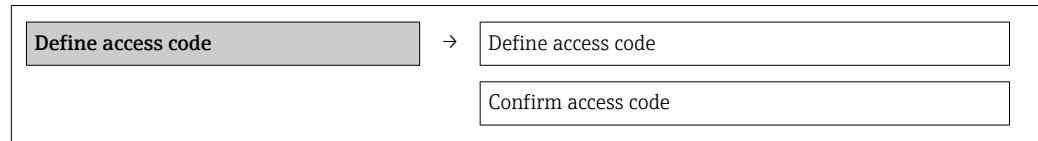

## Defining the access code via the Web browser

1. Navigate to the **Enter access code** parameter.
2. Define a max. 4-digit numeric code as an access code.
3. Enter the access code again to confirm the code.
  - ↳ The Web browser switches to the login page.

**i** If no action is performed for 10 minutes, the Web browser automatically returns to the login page.

**i** The user role with which the user is currently logged on via the Web browser is indicated by the **Access status tooling** parameter. Navigation path: Operation → Access status tooling

## 10.6.2 Write protection via write protection switch

The write protection switch makes it possible to block write access to the entire operating menu with the exception of the following parameters:

- External pressure
- External temperature
- Reference density
- All parameters for configuring the totalizer

The parameter values are now read only and cannot be edited any more:

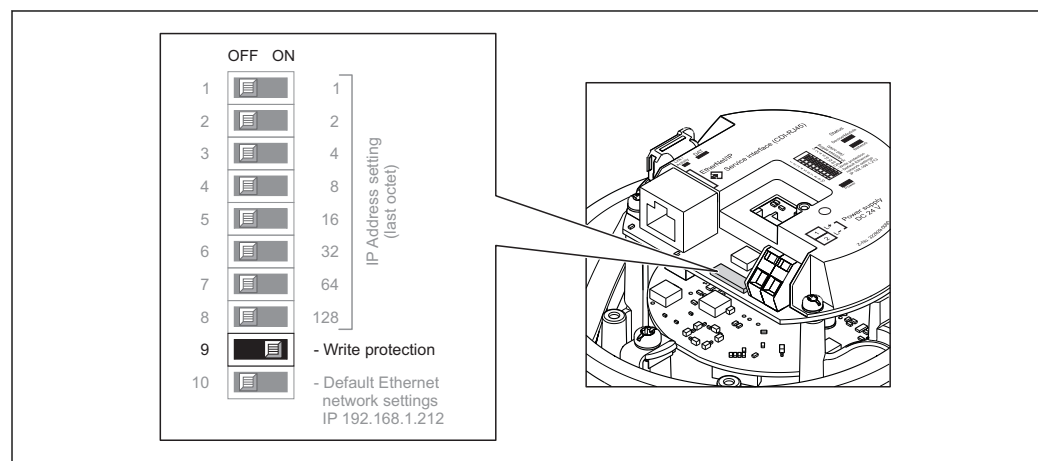

- Via service interface (CDI-RJ45)
- Via Ethernet network
- Via PROFIBUS DP



A0017915

1. Depending on the housing version, loosen the securing clamp or fixing screw of the housing cover.
2. Depending on the housing version, unscrew or open the housing cover and disconnect the local display from the main electronics module where necessary (→ 96).
3. Setting the write protection switch on the I/O electronics module to the ON position enables the hardware write protection. Setting the write protection switch on the I/O

electronics module to the OFF position (factory setting) disables the hardware write protection.

- ↳ If hardware write protection is enabled, the **Hardware locked** option is displayed in the **Locking status** parameter (→  62); if disabled, no option is displayed in the **Locking status** parameter (→  62)

4. Reverse the removal procedure to reassemble the transmitter.

## 11 Operation

### 11.1 Read out and modify current Ethernet settings

If the Ethernet settings such as the IP address of the measuring device are unknown, they can be read out and modified as explained in the following example for an IP address.

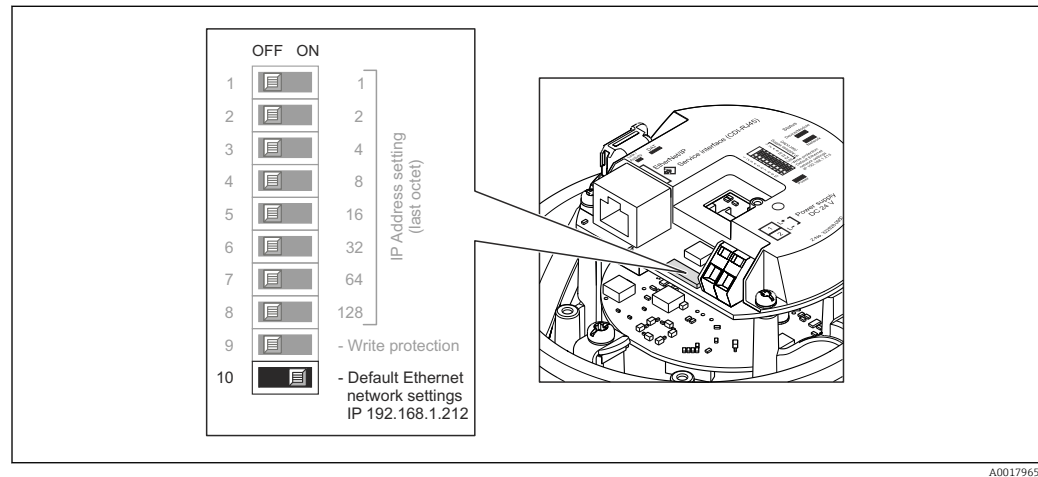

A0017965

#### Prerequisite

- Software addressing is enabled: All the DIP switches for hardware addressing are set to OFF. (→ 28)
- Measuring device is switched on.

1. Set the DIP switch for "Default Ethernet network settings, IP 192.168.1.212" from OFF → ON.
2. Restart the device.
  - ↳ The device's Ethernet settings are reset to their factory settings:  
IP address: 192.168.1.212; Subnet mask: 255.255.255.0; Default gateway: 192.168.1.212
3. Enter the default setting for the IP address in the address line of the Web browser.
4. In the operating menu navigate to the **IP address** parameter: "Setup" menu → Communication → IP address
  - ↳ The parameter displays the configured IP address.
5. Change the IP address of the device if necessary.
6. Set the DIP switch for "Default Ethernet network settings, IP 192.168.1.212" from ON → OFF.
7. Restart the device.
  - ↳ The modified IP address of the device is now enabled.

### 11.2 Reading device locking status

The write protection types that are currently active can be determined using the **Locking status** parameter.

#### Navigation

"Operation" menu → Locking status

*Function scope of "Locking status" parameter*

Options	Description
Hardware locked	The write protection switch (DIP switch) for hardware locking is activated on the I/O electronic module. This prevents write access to the parameters (→ 60).
Temporarily locked	Due to internal processing in the device (e.g. up-/downloading of data, reset), write access to the parameters is blocked for a short time. Once the internal processing has been completed, the parameters can be changed once again.

## 11.3 Reading measured values

Using the **Measured values** submenu, it is possible to read all the measured values.

"Diagnostics" menu → Measured values

### 11.3.1 Process variables

The **Process variables** submenu contains all the parameters needed to display the current measured values for every process variable.

#### Navigation

"Diagnostics" menu → Measured values → Process variables

Process variables	
	Mass flow
	Volume flow
	Corrected volume flow
	Density
	Reference density
	Temperature
	Pressure value

#### Parameter overview with brief description

Parameter	Description	User interface
Mass flow	Displays the mass flow currently measured.	Signed floating-point number
Volume flow	Displays the calculated volume flow.	Signed floating-point number
Corrected volume flow	Displays the corrected volume flow currently calculated.	Signed floating-point number
Density	Displays the density currently measured.	Signed floating-point number
Reference density	Displays the reference density currently calculated.	Signed floating-point number
Temperature	Displays the temperature currently measured.	Signed floating-point number
Pressure value	Displays either a fixed or external pressure value.	Signed floating-point number

### 11.3.2 Totalizer

The **"Totalizer" submenu** contains all the parameters needed to display the current measured values for every totalizer.

**Navigation**

"Diagnostics" menu → Measured values → Totalizer

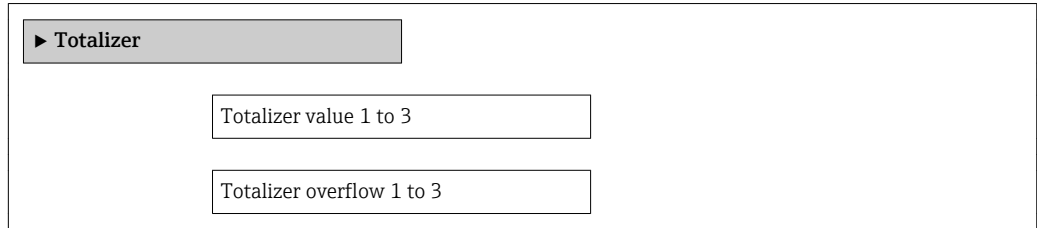

**Parameter overview with brief description**

Parameter	Prerequisite	Description	User interface	Factory setting
Totalizer value 1 to 3	In the <b>Assign process variable</b> parameter of <b>Totalizer 1 to 3</b> submenu one of the following options is selected: <ul style="list-style-type: none"> <li>▪ Volume flow</li> <li>▪ Mass flow</li> <li>▪ Corrected volume flow</li> </ul>	Displays the current totalizer counter value.	Signed floating-point number	0 kg
Totalizer overflow 1 to 3	In the <b>Assign process variable</b> parameter of <b>Totalizer 1 to 3</b> submenu one of the following options is selected: <ul style="list-style-type: none"> <li>▪ Volume flow</li> <li>▪ Mass flow</li> <li>▪ Corrected volume flow</li> </ul>	Displays the current totalizer overflow.	-32 000.0 to 32 000.0	0

**11.3.3 Output values**

The "**Output values**" submenu contains all the parameters needed to display the current measured values for every output.

**Navigation**

"Diagnostics" menu → Measured values → Output values

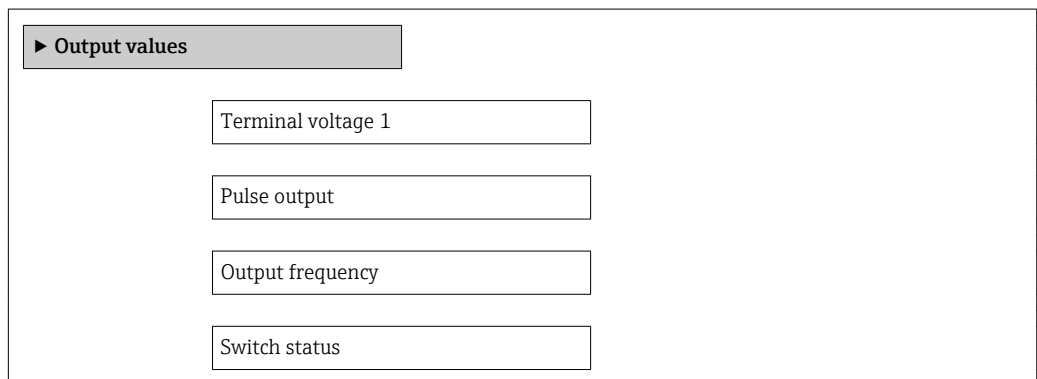



**Parameter overview with brief description**

Parameter	Description	User interface	Factory setting
Pulse output	Displays the value currently measured for the pulse output.	Positive floating-point number	0 Hz
Output frequency	Displays the value currently measured for the frequency output.	0.0 to 1250.0 Hz	0.0 Hz
Switch status	Displays the current switch output status.	<ul style="list-style-type: none"> <li>▪ Open</li> <li>▪ Closed</li> </ul>	Open

**11.4 Adapting the measuring device to the process conditions**

The following are available for this purpose:

- Basic settings using the **Setup** menu(→ 46)
- Advanced settings using the **Advanced setup** submenu(→ 53)

**11.5 Performing a totalizer reset**

*Function scope of "Control Totalizer " parameter*

Options	Description
Totalize	The totalizer is started.
Stop	Totalizing is stopped.
Reset + hold	The totaling process is stopped and the totalizer is reset to 0.
Preset + hold	The totaling process is stopped and the totalizer is set to its defined start value from the <b>Preset value</b> parameter.
Reset + totalize	The totalizer is reset to 0 and the totaling process is restarted.
Preset + totalize	The totalizer is set to the defined start value in <b>Preset value</b> parameter and the totaling process is restarted.

*Function scope of "Reset all totalizers" parameter*

Options	Description
Reset + totalize	Resets all totalizers to 0 and restarts the totaling process. This deletes all the flow values previously totalized.

**Navigation**

"Operation" menu → Operation

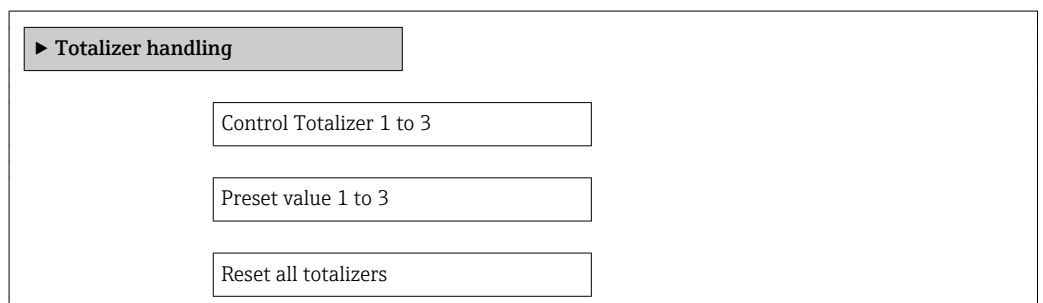

**Parameter overview with brief description**

Parameter	Description	Selection / User entry	Factory setting
Control Totalizer 1 to 3	Control totalizer value.	<ul style="list-style-type: none"><li>■ Totalize</li><li>■ Reset + hold</li><li>■ Preset + hold</li><li>■ Reset + totalize</li><li>■ Preset + totalize</li></ul>	Totalize
Preset value 1 to 3	Specify start value for totalizer.	Signed floating-point number	0 kg
Reset all totalizers	Reset all totalizers to 0 and start.	<ul style="list-style-type: none"><li>■ Cancel</li><li>■ Reset + totalize</li></ul>	Cancel





## 12 Diagnostics and troubleshooting

### 12.1 General troubleshooting

*For output signals*

Problem	Possible causes	Remedy
Green power LED on the main electronics module of the transmitter is dark	Supply voltage does not match that specified on the nameplate.	Apply the correct supply voltage (→  27).
Device measures incorrectly.	Configuration error or device is operated outside the application.	1. Check and correct parameter configuration. 2. Observe limit values specified in the "Technical Data".

*For access*

Problem	Possible causes	Remedy
No write access to parameters	Hardware write protection enabled	Set the write protection switch on the main electronics module to the OFF position (→  60).
Not connecting to Web server	<ul style="list-style-type: none"> <li>▪ Incorrect IP address</li> <li>▪ IP address is not known</li> </ul>	1. If addressing via hardware: open the transmitter and check the IP address configured (last octet). 2. Check the IP address of the measuring device with the network manager. 3. If the IP address is not known, set DIP switch No. 10 on the I/O electronics module to ON, restart the device and enter the default setting for the IP address 192.168.1.212.  EtherNet/IP communication is interrupted by enabling the DIP switch.
Not connecting to Web server	Incorrect setting for the Ethernet interface of the computer	1. Check the properties of the Internet protocol (TCP/IP) (→  34). 2. Check the network settings with the IT manager.
Not connecting to Web server	Web server disabled	Via the "FieldCare" operating tool check whether the Web server of the measuring device is enabled and enable it if necessary (→  37).
Not connecting to Web server	The use of the proxy server is not disabled in the Web browser settings of the computer.	Disable the use of the proxy server in the Web browser settings of the computer. Using the example of MS Internet Explorer: 1. Under <i>Control Panel</i> open <i>Internet options</i> . 2. Select the <i>Connections</i> tab and then double-click <i>LAN settings</i> . 3. In the <i>LAN settings</i> disable the use of the proxy server and select <i>OK</i> to confirm.

Problem	Possible causes	Remedy
Not connecting to Web server	Other network connections or programs are still active on the computer.	<ul style="list-style-type: none"> <li>▪ Make sure that no other network connections are established by the computer (also no WLAN) and close other programs with network access to the computer.</li> <li>▪ If using a docking station for notebooks make sure that a network connection to another network is not active.</li> </ul>
No or incomplete display of contents in the Web browser	<ul style="list-style-type: none"> <li>▪ JavaScript not enabled</li> <li>▪ JavaScript cannot be enabled</li> </ul>	<ol style="list-style-type: none"> <li>1. Enable JavaScript.</li> <li>2. Enter http://XXX.XXX.X.XXX/basic.html as the IP address.</li> </ol>
Web browser frozen and operation no longer possible	Data transfer active	Wait until data transfer or current action is finished.
Web browser frozen and operation no longer possible	Connection lost	<ol style="list-style-type: none"> <li>1. Check cable connection and power supply.</li> <li>2. Refresh the Web browser and restart if necessary.</li> </ol>
Content of Web browser incomplete or difficult to read	Not using optimum version of Web server.	<ol style="list-style-type: none"> <li>1. Use the correct Web browser version (→ 34).</li> <li>2. Clear the Web browser cache and restart the Web browser.</li> </ol>
Content of Web browser incomplete or difficult to read	Unsuitable view settings.	Change the font size/display ratio of the Web browser.

## 12.2 Diagnostic information via light emitting diodes

### 12.2.1 Transmitter

Various light emitting diodes (LEDs) on the main electronics module of the transmitter provide information on device status.

LED	Color	Meaning
Power	Off	Supply voltage is off or too low
	Green	Supply voltage is ok
Device status	Green	Device status is ok
	Flashing red	A device error of diagnostic behavior "Warning" has occurred
	Red	A device error of diagnostic behavior "Alarm" has occurred
	Alternately flashing red/green	Boot loader is active
Network status	Off	Device has no EtherNet/IP address
	Green	Device's EtherNet/IP connection is active
	Flashing green	Device has EtherNet/IP address but no EtherNet/IP connection
	Red	EtherNet/IP address of the device has been assigned twice
	Flashing red	Device's EtherNet/IP connection is in timeout mode
Link/Activity	Orange	Link available but no activity
	Flashing orange	Activity present
Communication	Flashing white	

## 12.3 Diagnostic information in the Web browser

### 12.3.1 Diagnostic options

Any faults detected by the measuring device are displayed in the Web browser on the home page once the user has logged on.

1 Status area with status signal  
 2 Diagnostic information  
 3 Remedial measures with Service ID

**i** Furthermore, diagnostic events that have occurred can be viewed in the **Diagnostics** menu:

- Via parameters (→ 74)
- Via submenus (→ 75)

### Status signals

The status signals provide information on the state and reliability of the device by categorizing the cause of the diagnostic information (diagnostic event).

Symbol	Meaning
 A0017271	<b>Failure</b> A device error has occurred. The measured value is no longer valid.
 A0017278	<b>Function check</b> The device is in service mode (e.g. during a simulation).
 A0017277	<b>Out of specification</b> The device is operated: Outside its technical specification limits (e.g. outside the process temperature range)
 A0017276	<b>Maintenance required</b> Maintenance is required. The measured value is still valid.

**i** The status signals are categorized in accordance with VDI/VDE 2650 and NAMUR Recommendation NE 107.

### Diagnostic information

The fault can be identified using the diagnostic information. The short text helps you by providing information about the fault.

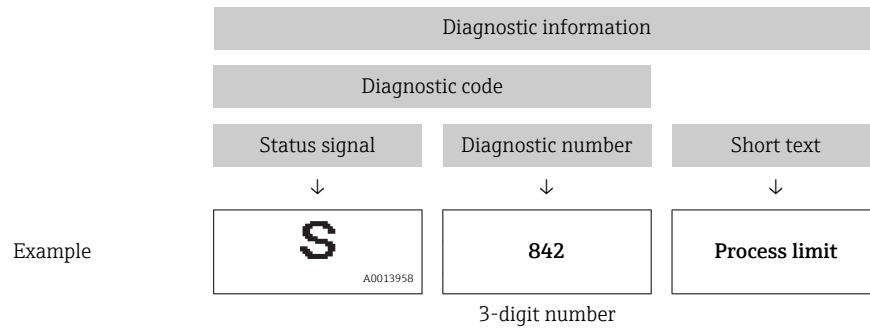

### 12.3.2 Calling up remedy information

Remedy information is provided for every diagnostic event to ensure that problems can be rectified quickly. These measures are displayed in red along with the diagnostic event and the related diagnostic information.

## 12.4 Diagnostic information in FieldCare

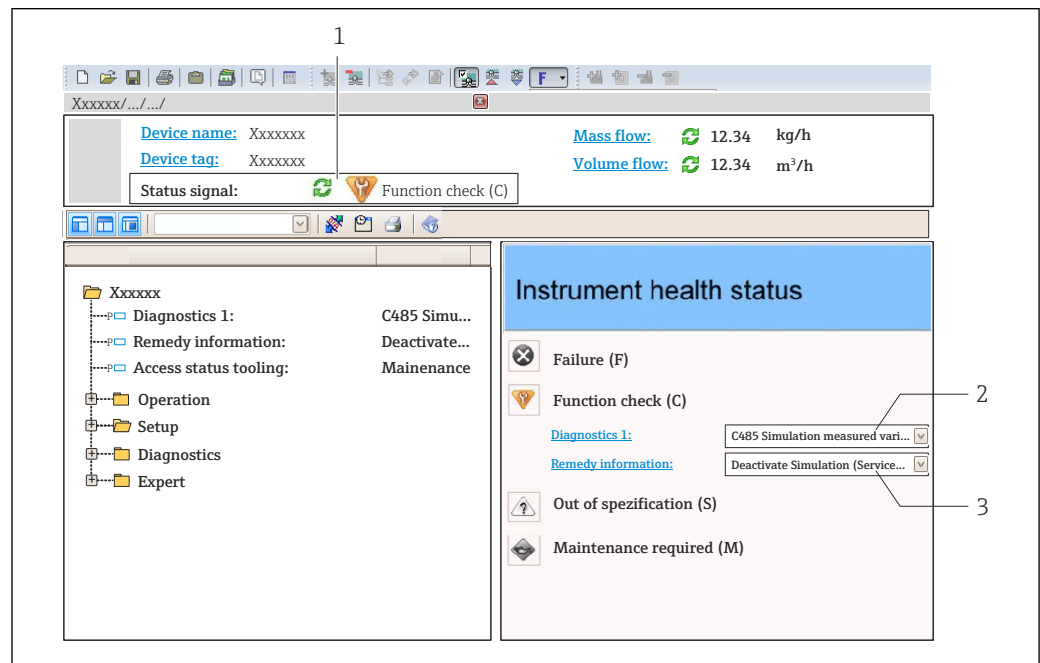

### 12.4.1 Diagnostic options

Any faults detected by the measuring device are displayed on the home page of the operating tool once the connection has been established.



A0021799-EN

- 1 Status area with status signal
- 2 Diagnostic information (→ 70)
- 3 Remedial measures with Service ID

-  Furthermore, diagnostic events that have occurred can be viewed in the **Diagnostics** menu:
  - Via parameters (→  74)
  - Via submenu (→  75)

### Diagnostic information

The fault can be identified using the diagnostic information. The short text helps you by providing information about the fault.

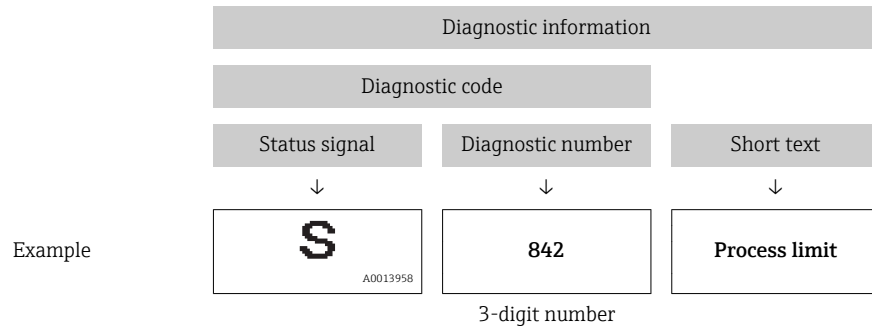

### 12.4.2 Calling up remedy information

Remedy information is provided for every diagnostic event to ensure that problems can be rectified quickly:

- On the home page  
Remedy information is displayed in a separate field below the diagnostics information.
- In the **Diagnostics** menu  
Remedy information can be called up in the working area of the user interface.

The user is in the **Diagnostics** menu.

1. Call up the desired parameter.
2. On the right in the working area, mouse over the parameter.  
↳ A tool tip with remedy information for the diagnostic event appears.

## 12.5 Diagnostic information via communication interface

### 12.5.1 Reading out diagnostic information

The current diagnostic event and associated diagnostic information can be read out via the input assembly (fix assembly):

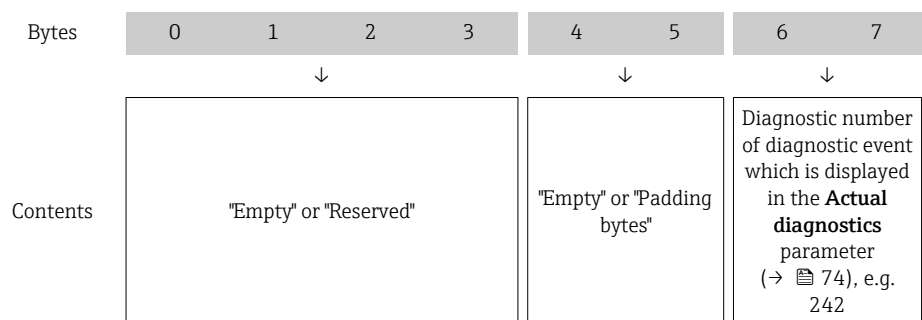

-  For content of bytes 8 to 16

## 12.6 Adapting the diagnostic information

### 12.6.1 Adapting the diagnostic behavior

Each item of diagnostic information is assigned a specific diagnostic behavior at the factory. The user can change this assignment for certain diagnostic information in the **Diagnostic behavior** submenu .

"Expert" menu → System → Diagnostic handling → Diagnostic behavior

You can assign the following options to the diagnostic number as the diagnostic behavior:

Options	Description
Alarm	Measurement is interrupted. The totalizers assume the defined alarm condition. A diagnostic message is generated.
Warning	Measurement is resumed. The totalizers are not affected. A diagnostics message is generated.
Logbook entry only	The device continues to measure. The diagnostic message is entered in the Event logbook (events list) submenu only and is not displayed in alternation with the measured value display.
Off	The diagnostic event is ignored, and no diagnostic message is generated or entered.

## 12.7 Overview of diagnostic information

 In the case of some items of diagnostic information, the status signal and the diagnostic behavior can be changed. Adapt the diagnostic information (→  72)

Diagnostic number	Short text	Remedy instructions	Status signal [from the factory]	Diagnostic behavior [from the factory]
<b>Diagnostic of sensor</b>				
022	Sensor temperature	1.Change main electronic module 2.Change sensor	F	Alarm
046	Sensor limit exceeded	1. Inspect sensor 2. Check process condition	S	Alarm
062	Sensor connection	1.Change main electronic module 2.Change sensor	F	Alarm
082	Data storage	1. Check module connections 2. Contact service	F	Alarm
083	Memory content	1. Restart device 2. Contact service	F	Alarm
140	Sensor signal	1.Check or change main electronics 2.Change sensor	S	Alarm
144	Measuring error too high	1. Check or change sensor 2. Check process conditions	F	Alarm
190	Special event 1	Contact service	F	Alarm
191	Special event 5	Contact service	F	Alarm
192	Special event 9	Contact service	F	Alarm <sup>1)</sup>
<b>Diagnostic of electronic</b>				
201	Device failure	1. Restart device 2. Contact service	F	Alarm







Diagnostic number	Short text	Remedy instructions	Status signal [from the factory]	Diagnostic behavior [from the factory]
242	Software incompatible	1. Check software 2. Flash or change main electronics module	F	Alarm
252	Modules incompatible	1. Check electronic modules 2. Change electronic modules	F	Alarm
262	Module connection	1. Check module connections 2. Change main electronics	F	Alarm
270	Main electronic failure	Change main electronic module	F	Alarm
271	Main electronic failure	1. Restart device 2. Change main electronic module	F	Alarm
272	Main electronic failure	1. Restart device 2. Contact service	F	Alarm
273	Main electronic failure	Change electronic	F	Alarm
274	Main electronic failure	Change electronic	S	Warning
283	Memory content	1. Reset device 2. Contact service	F	Alarm
311	Electronic failure	1. Reset device 2. Contact service	F	Alarm
311	Electronic failure	1. Do not reset device 2. Contact service	M	Warning
382	Data storage	1. Insert DAT module 2. Change DAT module	F	Alarm
383	Memory content	1. Restart device 2. Check or change DAT module 3. Contact service	F	Alarm
390	Special event 2	Contact service	F	Alarm
391	Special event 6	Contact service	F	Alarm
392	Special event 10	Contact service	F	Alarm <sup>1)</sup>
<b>Diagnostic of configuration</b>				
410	Data transfer	1. Check connection 2. Retry data transfer	F	Alarm
411	Up-/download active	Up-/download active, please wait	C	Warning
437	Configuration incompatible	1. Restart device 2. Contact service	F	Alarm
438	Dataset	1. Check data set file 2. Check device configuration 3. Up- and download new configuration	M	Warning
453	Flow override	Deactivate flow override	C	Warning
484	Simulation failure mode	Deactivate simulation	C	Alarm
485	Simulation measured variable	Deactivate simulation	C	Warning
495	Simulation diagnostic event	Deactivate simulation	C	Warning
537	Configuration	1. Check IP addresses in network 2. Change IP address	F	Warning
590	Special event 3	Contact service	F	Alarm
591	Special event 7	Contact service	F	Alarm
592	Special event 11	Contact service	F	Alarm <sup>1)</sup>

Diagnostic number	Short text	Remedy instructions	Status signal [from the factory]	Diagnostic behavior [from the factory]
<b>Diagnostic of process</b>				
825	Operating temperature	1. Check ambient temperature 2. Check process temperature	S	Warning
825	Operating temperature	1. Check ambient temperature 2. Check process temperature	F	Alarm
830	Sensor temperature too high	Reduce ambient temp. around the sensor housing	S	Warning
831	Sensor temperature too low	Increase ambient temp. around the sensor housing	S	Warning
832	Electronic temperature too high	Reduce ambient temperature	S	Warning <sup>1)</sup>
833	Electronic temperature too low	Increase ambient temperature	S	Warning <sup>1)</sup>
834	Process temperature too high	Reduce process temperature	S	Warning <sup>1)</sup>
835	Process temperature too low	Increase process temperature	S	Warning <sup>1)</sup>
842	Process limit	Low flow cut off active! 1. Check low flow cut off configuration	S	Warning
843	Process limit	Check process conditions	S	Warning
862	Partly filled pipe	1. Check for gas in process 2. Adjust detection limits	S	Warning
882	Input signal	1. Check input configuration 2. Check external device or process conditions	F	Alarm
910	Tubes not oscillating	1. Check electronic 2. Inspect sensor	F	Alarm
912	Medium inhomogeneous	1. Check process cond. 2. Increase system pressure	S	Warning
912	Inhomogeneous	1. Check process cond. 2. Increase system pressure	S	Warning
913	Medium unsuitable	1. Check process conditions 2. Check electronic modules or sensor	S	Alarm
944	Monitoring failed	Check process conditions for Heartbeat Monitoring	S	Warning
948	Tube damping too high	Check process conditions	S	Warning
990	Special event 4	Contact service	F	Alarm
991	Special event 8	Contact service	F	Alarm
992	Special event 12	Contact service	F	Alarm <sup>1)</sup>

1) Diagnostic status is changeable.

## 12.8 Pending diagnostic events

The **Diagnostics** menu allows the user to view the current diagnostic event and the previous diagnostic event separately.

-  To call up the measures to rectify a diagnostic event:
  - Via Web browser (→  70)
  - Via "FieldCare" operating tool (→  71)
-  Other pending diagnostic events can be displayed in the **Diagnostic list** submenu(→  75)

**Navigation**  
 "Diagnostics" menu

**Structure of the submenu**

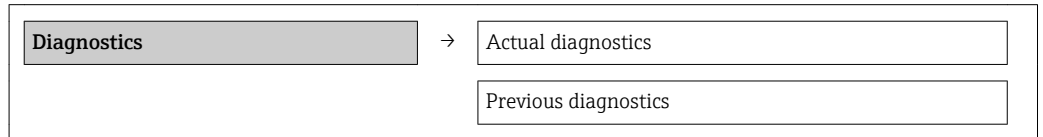



**Parameter overview with brief description**

Parameter	Prerequisite	Description	User interface	Factory setting
Actual diagnostics	1 diagnostic event has occurred.	Displays the current diagnostic event along with the diagnostic information.  If two or more messages occur simultaneously, the message with the highest priority is shown on the display.	Symbol for diagnostic behavior, diagnostic code and short message.	-
Previous diagnostics	2 diagnostic events have already occurred.	Displays the diagnostic event that occurred prior to the current diagnostic event along with the diagnostic information.	Symbol for diagnostic behavior, diagnostic code and short message.	-

**12.9 Diagnostic list**

In the **Diagnostic list** submenu, up to 5 currently pending diagnostic events can be displayed along with the related diagnostic information. If more than 5 diagnostic events are pending, the events with the highest priority are shown on the display.

**Navigation path**  
**Diagnostics** menu → **Diagnostic list** submenu

-  To call up the measures to rectify a diagnostic event:
  - Via Web browser (→  70)
  - Via "FieldCare" operating tool (→  71)

**12.10 Event logbook**



**12.10.1 Event history**

A chronological overview of the event messages that have occurred is provided in the **Events list** submenu.



**Navigation path**  
 "Diagnostics" menu → Event logbook → Events list

A maximum of 20 event messages can be displayed in chronological order.



The event history includes entries for:

- Diagnostic events (→  72)
- Information events (→  76)

In addition to the operation time of its occurrence, each event is also assigned a symbol that indicates whether the event has occurred or is ended:

- Diagnostic event
  - : Event has occurred
  - : Event has ended
- Information event
  - : Event has occurred

 To call up the measures to rectify a diagnostic event:

- Via Web browser (→  70)
- Via "FieldCare" operating tool (→  71)

 For filtering the displayed event messages (→  76)

### 12.10.2 Filtering the event logbook

Using the **Filter options** parameter, you can define which category of event messages is displayed in the **Events list** submenu.

#### Navigation path

"Diagnostics" menu → Event logbook → Filter options

#### Filter categories

- All
- Failure (F)
- Function check (C)
- Out of specification (S)
- Maintenance required (M)
- Information (I)

### 12.10.3 Overview of information events

Unlike a diagnostic event, an information event is displayed in the event logbook only and not in the diagnostic list.

Info number	Info name
I1000	----- (Device ok)
I1089	Power on
I1090	Configuration reset
I1091	Configuration changed
I1110	Write protection switch changed
I1111	Density adjust failure
I1137	Electronic changed
I1151	History reset
I1155	Reset electronic temperature
I1157	Memory error event list
I1185	Display backup done
I1186	Restore via display done
I1187	Settings downloaded with display
I1188	Display data cleared
I1189	Backup compared

Info number	Info name
I1209	Density adjustment ok
I1221	Zero point adjust failure
I1222	Zero point adjustment ok
I1256	Display: access status changed
I1264	Safety sequence aborted
I1335	Firmware changed
I1361	Wrong web server login
I1397	Fieldbus: access status changed
I1398	CDI: access status changed
I1444	Device verification passed
I1445	Device verification failed
I1446	Device verification active
I1447	Record application reference data
I1448	Application reference data recorded
I1449	Recording application ref. data failed
I1450	Monitoring off
I1451	Monitoring on
I1457	Failed:Measured error verification
I1459	Failed: I/O module verification
I1460	Failed: Sensor integrity verification
I1461	Failed: Sensor verification
I1462	Failed:Sensor electronic module verific.

## 12.11 Resetting the measuring device

Using the **Device reset** parameter it is possible to reset the entire device configuration or some of the configuration to a defined state.

"Setup" menu → Advanced setup → Administration

*Function scope of "Device reset" parameter*

Options	Description
Cancel	No action is executed and the user exits the parameter.
To delivery settings	Every parameter for which a customer-specific default setting was ordered is reset to this customer-specific value. All other parameters are reset to the factory setting.  This option is not visible if no customer-specific settings have been ordered.
Restart device	The restart resets every parameter whose data are in the volatile memory (RAM) to the factory setting (e.g. measured value data). The device configuration remains unchanged.
History reset	Every parameter is reset to its factory setting.

## 12.12 Device information

The **Device information** submenu contains all the parameters that display different information for identifying the device.

**Navigation**

"Diagnostics" menu → Device information

▶ **Device information**

Device tag

Serial number

Firmware version

Device name

Order code

Extended order code 1

Extended order code 2

Extended order code 3

ENP version

IP address

Subnet mask

Default gateway

**Parameter overview with brief description**

Parameter	Description	User entry	Factory setting
IP address	Displays the IP address of the Web server of the measuring device.	4 octet: 0 to 255 (in the particular octet)	192.168.1.212
Subnet mask	Displays the subnet mask.	4 octet: 0 to 255 (in the particular octet)	255.255.255.0
Default gateway	Displays the default gateway.	4 octet: 0 to 255 (in the particular octet)	0.0.0.0

## 12.13 Firmware history

Release date	Firmware version	Order code for "Firmware version"	Firmware changes	Documentation type	Documentation
06.2012	01.00.00		Original firmware	Operating Instructions	–
04.2013	01.01.zz	Option 73	<ul style="list-style-type: none"> <li>▪ Fieldbus access level was changed from service to maintenance</li> <li>▪ Improved calculation:               <ul style="list-style-type: none"> <li>– Target mass flow</li> <li>– Carrier mass flow</li> </ul> </li> <li>▪ Option to access application packages:               <ul style="list-style-type: none"> <li>– Heartbeat Technology</li> <li>– Concentration</li> </ul> </li> </ul>	Operating Instructions	–
10.2014	01.02.zz	Option 71	<ul style="list-style-type: none"> <li>▪ Integration of optional local display</li> <li>▪ Heartbeat functionality for Rockwell AOP</li> <li>▪ New unit "Beer Barrel (BBL)"</li> <li>▪ Monitoring of measuring tube damping</li> <li>▪ Simulation of diagnostic events</li> </ul>	Operating Instructions	BA01347D/06/EN/01.14

 Flashing the firmware to the current version or to the previous version is possible via the service interface (CDI) .

 For the compatibility of the firmware version with the previous version, the installed device description files and operating tools, observe the information about the device in the "Manufacturer's information" document.

 The manufacturer's information is available:

- In the Download Area of the Endress+Hauser Internet site: [www.endress.com](http://www.endress.com) → Download
- Specify the following details:
  - Product root, e.g. 8E1B
  - Text search: Manufacturer's information
  - Search range: documentation

## 13 Maintenance

### 13.1 Maintenance tasks

No special maintenance work is required.

#### 13.1.1 Exterior cleaning

When cleaning the exterior of measuring devices, always use cleaning agents that do not attack the surface of the housing or the seals.

### 13.2 Measuring and test equipment

Endress+Hauser offers a wide variety of measuring and test equipment, such as W@M or device tests.

 Your Endress+Hauser Sales Center can provide detailed information on the services.

 For a list of some of the measuring and test equipment, refer to the "Accessories" chapter of the "Technical Information" document for the device.

### 13.3 Endress+Hauser services

Endress+Hauser offers a wide variety of services for maintenance such as recalibration, maintenance service or device tests.

 Your Endress+Hauser Sales Center can provide detailed information on the services.



## 14 Repair

### 14.1 General notes

#### Repair and conversion concept

The Endress+Hauser repair and conversion concept provides for the following:

- The measuring devices have a modular design.
- Spare parts are grouped into logical kits with the associated Installation Instructions.
- Repairs are carried out by Endress+Hauser Service or by correspondingly trained customers.
- Certified devices can be converted into other certified devices by Endress+Hauser Service or at the factory only.

#### Notes for repair and conversion

For repair and modification of a measuring device, observe the following notes:

- Use only original Endress+Hauser spare parts.
- Carry out the repair according to the Installation Instructions.
- Observe the applicable standards, federal/national regulations, Ex documentation (XA) and certificates.
- Document every repair and each conversion and enter them into the *W@M* life cycle management database.

### 14.2 Spare parts



Measuring device serial number:

- Is located on the nameplate of the device.
- Can be read out via the **Serial number** parameter in the **Device information** submenu (→ 77).

### 14.3 Endress+Hauser services



Contact your Endress+Hauser Sales Center for information on services and spare parts.

### 14.4 Return

The measuring device must be returned if it is need of repair or a factory calibration, or if the wrong measuring device has been delivered or ordered. Legal specifications require Endress+Hauser, as an ISO-certified company, to follow certain procedures when handling products that are in contact with the medium.

To ensure safe, swift and professional device returns, please refer to the procedure and conditions for returning devices provided on the Endress+Hauser website at <http://www.endress.com/support/return-material>

### 14.5 Disposal

#### 14.5.1 Removing the measuring device

1. Switch off the device.
2. **WARNING!** Danger to persons from process conditions. Beware of hazardous process conditions such as pressure in the measuring device, high temperatures or aggressive fluids.

Carry out the mounting and connection steps from the chapters "Mounting the measuring device" and "Connecting the measuring device" in the logically reverse sequence. Observe the safety instructions.

### 14.5.2 Disposing of the measuring device

**⚠ WARNING**

**Danger to personnel and environment from fluids that are hazardous to health.**

- ▶ Ensure that the measuring device and all cavities are free of fluid residues that are hazardous to health or the environment, e.g. substances that have permeated into crevices or diffused through plastic.

Observe the following notes during disposal:

- Observe valid federal/national regulations.
- Ensure proper separation and reuse of the device components.

## 15 Accessories

Various accessories, which can be ordered with the device or subsequently from Endress+Hauser, are available for the device. Detailed information on the order code in question is available from your local Endress+Hauser sales center or on the product page of the Endress+Hauser website: [www.endress.com](http://www.endress.com).

### 15.1 Service-specific accessories

Accessories	Description
Applicator	<p>Software for selecting and sizing Endress+Hauser measuring devices:</p> <ul style="list-style-type: none"> <li>▪ Calculation of all the necessary data for identifying the optimum flowmeter: e.g. nominal diameter, pressure loss, accuracy or process connections.</li> <li>▪ Graphic illustration of the calculation results</li> </ul> <p>Administration, documentation and access to all project-related data and parameters throughout the entire life cycle of a project.</p> <p>Applicator is available:</p> <ul style="list-style-type: none"> <li>▪ Via the Internet: <a href="https://wapps.endress.com/applicator">https://wapps.endress.com/applicator</a></li> <li>▪ On CD-ROM for local PC installation.</li> </ul>
W@M	<p>Life cycle management for your plant</p> <p>W@M supports you with a wide range of software applications over the entire process: from planning and procurement, to the installation, commissioning and operation of the measuring devices. All the relevant device information, such as the device status, spare parts and device-specific documentation, is available for every device over the entire life cycle.</p> <p>The application already contains the data of your Endress+Hauser device. Endress+Hauser also takes care of maintaining and updating the data records.</p> <p>W@M is available:</p> <ul style="list-style-type: none"> <li>▪ Via the Internet: <a href="http://www.endress.com/lifecyclemanagement">www.endress.com/lifecyclemanagement</a></li> <li>▪ On CD-ROM for local PC installation.</li> </ul>
FieldCare	<p>FDT-based plant asset management tool from Endress+Hauser.</p> <p>It can configure all smart field units in your system and helps you manage them. By using the status information, it is also a simple but effective way of checking their status and condition.</p> <p> For details, see Operating Instructions BA00027S and BA00059S</p>

## 16 Technical data

### 16.1 Application

The measuring device is suitable for flow measurement of liquids and gases only.

Depending on the version ordered, the measuring device can also measure potentially explosive, flammable, poisonous and oxidizing media.

To ensure that the device remains in proper operating condition for its service life, use the measuring device only for media against which the process-wetted materials are adequately resistant.

### 16.2 Function and system design

Measuring principle      Mass flow measurement based on the Coriolis measuring principle

Measuring system      The device consists of a transmitter and a sensor.  
 One device version is available: compact version - transmitter and sensor form a mechanical unit.  
 For information on the structure of the device (→  11)

### 16.3 Input

Measured variable      **Direct measured variables**

- Mass flow
- Density
- Temperature

**Calculated measured variables**

- Volume flow
- Corrected volume flow
- Reference density

Measuring range      **Measuring ranges for liquids**

DN		Measuring range full scale values $\dot{m}_{\min(F)}$ to $\dot{m}_{\max(F)}$	
[mm]	[in]	[kg/h]	[lb/min]
8	$\frac{3}{8}$	0 to 2 000	0 to 73.50
15	$\frac{1}{2}$	0 to 6 500	0 to 238.9
25	1	0 to 18 000	0 to 661.5

#### Measuring ranges for gases

The full scale values depend on the density of the gas and can be calculated with the formula below:

$$\dot{m}_{\max(G)} = \dot{m}_{\max(F)} \cdot \rho_G : X$$

$\dot{m}_{\max(G)}$	Maximum full scale value for gas [kg/h]
$\dot{m}_{\max(F)}$	Maximum full scale value for liquid [kg/h]
$\dot{m}_{\max(G)} < \dot{m}_{\max(F)}$	$\dot{m}_{\max(G)}$ can never be greater than $\dot{m}_{\max(F)}$
$\rho_G$	Gas density in [kg/m <sup>3</sup> ] at operating conditions

	DN		x [kg/m <sup>3</sup> ]
	[mm]	[in]	
	8	$\frac{3}{8}$	85
	15	$\frac{1}{2}$	110
	25	1	125

### Recommended measuring range

"Flow limit" section (→  93)

Operable flow range	Over 1000 : 1. Flow rates above the preset full scale value are not overridden by the electronics unit, with the result that the totalizer values are registered correctly.
---------------------	--------------------------------------------------------------------------------------------------------------------------------------------------------------------------------

## 16.4 Output

Output signal	<b>EtherNet/IP</b>		
	<table border="1"> <tr> <td>Standards</td> <td>In accordance with IEEE 802.3</td> </tr> </table>	Standards	In accordance with IEEE 802.3
Standards	In accordance with IEEE 802.3		

Signal on alarm	Depending on the interface, failure information is displayed as follows:		
	<b>EtherNet/IP</b> <table border="1"> <tr> <td>Device diagnostics</td> <td>Device condition can be read out in Input Assembly</td> </tr> </table>	Device diagnostics	Device condition can be read out in Input Assembly
Device diagnostics	Device condition can be read out in Input Assembly		

### Local display

Plain text display	With information on cause and remedial measures
Backlight	Red backlighting indicates a device error.

 Status signal as per NAMUR recommendation NE 107

### Operating tool

- Via digital communication:  
EtherNet/IP
- Via service interface

Plain text display	With information on cause and remedial measures
--------------------	-------------------------------------------------

**Web browser**

<b>Plain text display</b>	With information on cause and remedial measures
---------------------------	-------------------------------------------------

**Light emitting diodes (LED)**

<b>Status information</b>	<p>Status indicated by various light emitting diodes</p> <p>The following information is displayed depending on the device version:</p> <ul style="list-style-type: none"> <li>▪ Supply voltage active</li> <li>▪ Data transmission active</li> <li>▪ Device alarm/error has occurred</li> <li>▪ EtherNet/IP network available</li> <li>▪ EtherNet/IP connection established</li> </ul>
---------------------------	-----------------------------------------------------------------------------------------------------------------------------------------------------------------------------------------------------------------------------------------------------------------------------------------------------------------------------------------------------------------------------------------

Low flow cut off                      The switch points for low flow cut off are user-selectable.

Galvanic isolation                      The following connections are galvanically isolated from each other:

- Outputs
- Power supply

Protocol-specific data                      **EtherNet/IP**

Protocol	<ul style="list-style-type: none"> <li>▪ The CIP Networks Library Volume 1: Common Industrial Protocol</li> <li>▪ The CIP Networks Library Volume 2: EtherNet/IP Adaptation of CIP</li> </ul>
Communication type	<ul style="list-style-type: none"> <li>▪ 10Base-T</li> <li>▪ 100Base-TX</li> </ul>
Device profile	Generic device (product type: 0x2B)
Manufacturer ID	0x49E
Device type ID	0x104A
Baud rates	Automatic <sup>19</sup> / <sub>100</sub> Mbit with half-duplex and full-duplex detection
Polarity	Auto-polarity for automatic correction of crossed TxD and RxD pairs
Supported CIP connections	Max. 3 connections
Explicit connections	Max. 6 connections
I/O connections	Max. 6 connections (scanner)
Configuration options for measuring device	<ul style="list-style-type: none"> <li>▪ DIP switches on the electronics module for IP addressing</li> <li>▪ Manufacturer-specific software (FieldCare)</li> <li>▪ Add-on Profile Level 3 for Rockwell Automation control systems</li> <li>▪ Web browser</li> <li>▪ Electronic Data Sheet (EDS) integrated in the measuring device</li> </ul>
Configuration of the EtherNet interface	<ul style="list-style-type: none"> <li>▪ Speed: 10 MBit, 100 MBit, auto (factory setting)</li> <li>▪ Duplex: half-duplex, full-duplex, auto (factory setting)</li> </ul>
Configuration of the device address	<ul style="list-style-type: none"> <li>▪ DIP switches on the electronics module for IP addressing (last octet)</li> <li>▪ DHCP</li> <li>▪ Manufacturer-specific software (FieldCare)</li> <li>▪ Add-on Profile Level 3 for Rockwell Automation control systems</li> <li>▪ Web browser</li> <li>▪ EtherNet/IP tools, e.g. RSLinx (Rockwell Automation)</li> </ul>
Device Level Ring (DLR)	No

Fix Input			
RPI	5 ms to 10 s (factory setting: 20 ms)		
Exclusive Owner Multicast		Instance	Size [byte]
	Instance configuration:	0x68	398
	O → T configuration:	0x66	64
	T → O configuration:	0x64	44
Exclusive Owner Multicast		Instance	Size [byte]
	Instance configuration:	0x69	-
	O → T configuration:	0x66	64
	T → O configuration:	0x64	44
Input only Multicast		Instance	Size [byte]
	Instance configuration:	0x68	398
	O → T configuration:	0xC7	-
	T → O configuration:	0x64	44
Input only Multicast		Instance	Size [byte]
	Instance configuration:	0x69	-
	O → T configuration:	0xC7	-
	T → O configuration:	0x64	44
Input Assembly	<ul style="list-style-type: none"> <li>■ Current device diagnostics</li> <li>■ Mass flow</li> <li>■ Volume flow</li> <li>■ Corrected volume flow</li> <li>■ Density</li> <li>■ Reference density</li> <li>■ Temperature</li> <li>■ Totalizer 1</li> <li>■ Totalizer 2</li> <li>■ Totalizer 3</li> </ul>		
Configurable Input			
RPI	5 ms to 10 s (factory setting: 20 ms)		
Exclusive Owner Multicast		Instance	Size [byte]
	Instance configuration:	0x68	398
	O → T configuration:	0x66	64
	T → O configuration:	0x65	88
Exclusive Owner Multicast		Instance	Size [byte]
	Instance configuration:	0x69	-
	O → T configuration:	0x66	64
	T → O configuration:	0x65	88
Input only Multicast		Instance	Size [byte]
	Instance configuration:	0x68	398
	O → T configuration:	0xC7	-
	T → O configuration:	0x65	88
Input only Multicast		Instance	Size [byte]
	Instance configuration:	0x69	-
	O → T configuration:	0xC7	-
	T → O configuration:	0x65	88

Configurable Input Assembly	<ul style="list-style-type: none"> <li>▪ Current device diagnostics</li> <li>▪ Mass flow</li> <li>▪ Volume flow</li> <li>▪ Corrected volume flow</li> <li>▪ Density</li> <li>▪ Reference density</li> <li>▪ Temperature</li> <li>▪ Totalizer 1</li> <li>▪ Totalizer 2</li> <li>▪ Totalizer 3</li> </ul> <p> The range of options increases if the measuring device has one or more application packages.</p>
Fix Output	
Output Assembly	<ul style="list-style-type: none"> <li>▪ Activation of reset totalizers 1-3</li> <li>▪ Activation of pressure compensation</li> <li>▪ Activation of reference density compensation</li> <li>▪ Activation of temperature compensation</li> <li>▪ Reset totalizers 1-3</li> <li>▪ External pressure value</li> <li>▪ Pressure unit</li> <li>▪ External reference density</li> <li>▪ Reference density unit</li> <li>▪ External temperature</li> <li>▪ Temperature unit</li> </ul>
Configuration	
Configuration Assembly	<p>Only the most common configurations are listed below.</p> <ul style="list-style-type: none"> <li>▪ Software write protection</li> <li>▪ Mass flow unit</li> <li>▪ Mass unit</li> <li>▪ Volume flow unit</li> <li>▪ Volume unit</li> <li>▪ Corrected volume flow unit</li> <li>▪ Corrected volume unit</li> <li>▪ Density unit</li> <li>▪ Reference density unit</li> <li>▪ Temperature unit</li> <li>▪ Pressure unit</li> <li>▪ Length</li> <li>▪ Totalizer 1-3:                             <ul style="list-style-type: none"> <li>- Assignment</li> <li>- Unit</li> <li>- Mode of operation</li> <li>- Failsafe mode</li> </ul> </li> <li>▪ Alarm delay</li> </ul>

## 16.5 Power supply

Terminal assignment (→  25)

Pin assignment, device plug (→  26)

Supply voltage

### Transmitter

For device version with all communication types except Modbus RS485 intrinsically safe: DC 20 to 30 V

The power unit must be tested to ensure it meets safety requirements (e.g. PELV, SELV).



## Power consumption

**Transmitter**

Order code for "Output"	Maximum power consumption
Option N: EtherNet/IP	3.5 W

## Current consumption

**Transmitter**

Order Code "Output"	Maximum Current consumption	Maximum switch-on current
Option N: EtherNet/IP	145 mA	18 A (<0.125 ms)

## Power supply failure

- Totalizers stop at the last value measured.
- Depending on the device version, the configuration is retained in the device memory or in the plug-in memory (HistoROM DAT).
- Error messages (incl. total operated hours) are stored.

## Electrical connection

(→  26)

## Potential equalization

No special measures for potential equalization are required.

## Terminals

**Transmitter**

Spring terminals for wire cross-sections 0.5 to 2.5 mm<sup>2</sup> (20 to 14 AWG)

## Cable entries

- Cable gland: M20 × 1.5 with cable  $\phi$ 6 to 12 mm (0.24 to 0.47 in)
- Thread for cable entry:
  - NPT ½"
  - G ½"
  - M20



## Cable specification

(→  24)

## 16.6 Performance characteristics

## Reference operating conditions

- Error limits based on ISO 11631
- Water with +15 to +45 °C (+59 to +113 °F) at 2 to 6 bar (29 to 87 psi)
- Specifications as per calibration protocol
- Accuracy based on accredited calibration rigs that are traced to ISO 17025.

 To obtain measured errors, use the *Applicator* sizing tool (→  99)

## Maximum measured error



o.r. = of reading; 1 g/cm<sup>3</sup> = 1 kg/l; T = medium temperature

**Base accuracy****Mass flow and volume flow (liquids)**

±0.15 % o.r.

**Mass flow (gases)**

±0.75 % o.r.

 Design fundamentals (→  91)

**Density (liquids)**

- Reference conditions: ±0.0005 g/cm<sup>3</sup>
- Standard density calibration: ±0.02 g/cm<sup>3</sup>  
(valid over the entire temperature range and density range )

**Temperature**

±0.5 °C ± 0.005 · T °C (±0.9 °F ± 0.003 · (T – 32) °F)

**Zero point stability**

DN		Zero point stability	
[mm]	[in]	[kg/h]	[lb/min]
8	<sup>3</sup> / <sub>8</sub>	0.20	0.007
15	<sup>1</sup> / <sub>2</sub>	0.65	0.024
25	1	1.80	0.066

**Flow values**

Flow values as turndown parameter depending on nominal diameter.

*SI units*

DN	1:1	1:10	1:20	1:50	1:100	1:500
[mm]	[kg/h]	[kg/h]	[kg/h]	[kg/h]	[kg/h]	[kg/h]
8	2000	200	100	40	20	4
15	6500	650	325	130	65	13
25	18000	1800	900	360	180	36

*US units*

DN	1:1	1:10	1:20	1:50	1:100	1:500
[inch]	[lb/min]	[lb/min]	[lb/min]	[lb/min]	[lb/min]	[lb/min]
<sup>3</sup> / <sub>8</sub>	73.50	7.350	3.675	1.470	0.735	0.147
<sup>1</sup> / <sub>2</sub>	238.9	23.89	11.95	4.778	2.389	0.478
1	661.5	66.15	33.08	13.23	6.615	1.323

Repeatability

o.r. = of reading; 1 g/cm<sup>3</sup> = 1 kg/l; T = medium temperature

**Base repeatability**

**Mass flow and volume flow (liquids)**

±0.075 % o.r.

**Mass flow (gases)**

±0.35 % o.r.

 Design fundamentals (→  91)

**Density (liquids)**

±0.00025 g/cm<sup>3</sup>

**Temperature**

$$\pm 0.25 \text{ }^\circ\text{C} \pm 0.0025 \cdot T \text{ }^\circ\text{C} (\pm 0.45 \text{ }^\circ\text{F} \pm 0.0015 \cdot (T-32) \text{ }^\circ\text{F})$$

Response time

The response time depends on the configuration (damping).

Influence of medium temperature

**Mass flow**

When there is a difference between the temperature for zero point adjustment and the process temperature, the typical measured error of the sensor is  $\pm 0.0003 \%$  of the full scale value/ $^\circ\text{C}$  ( $\pm 0.00015 \%$  of the full scale value/ $^\circ\text{F}$ ).

**Density**

When there is a difference between the density calibration temperature and the process temperature, the typical measured error of the sensor is  $\pm 0.0001 \text{ g/cm}^3 \text{ }^\circ\text{C}$  ( $\pm 0.00005 \text{ g/cm}^3 \text{ }^\circ\text{F}$ ). Field density calibration is possible.

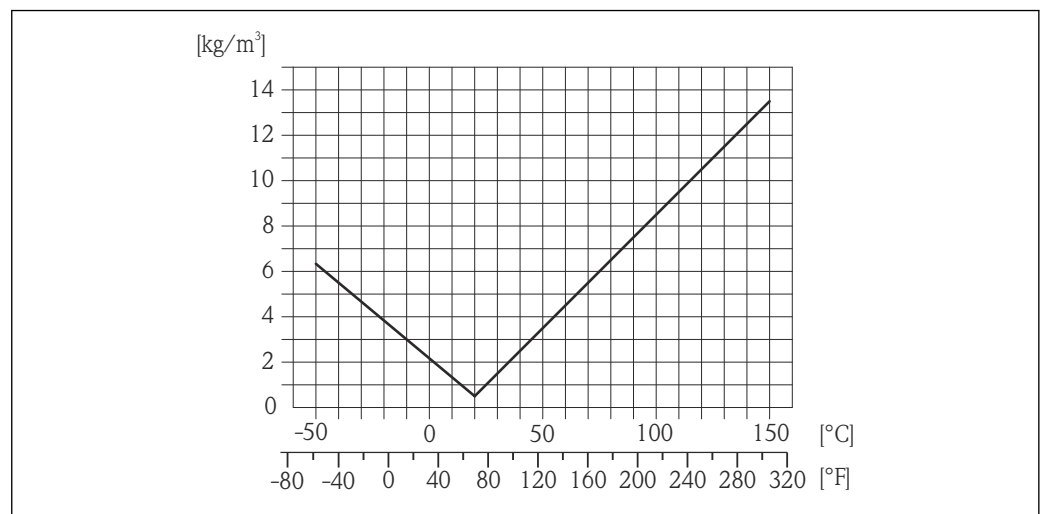

11 Field density calibration, for example at +20 °C (+68 °F)

**Temperature**

$$\pm 0.005 \cdot T \text{ }^\circ\text{C} (\pm 0.005 \cdot (T - 32) \text{ }^\circ\text{F})$$

Influence of medium pressure

A difference between the calibration pressure and process pressure does not affect accuracy.

Design fundamentals

o.r. = of reading, o.f.s. = of full scale value

BaseAccu = base accuracy in % o.r., BaseRepeat = base repeatability in % o.r.

MeasValue = measured value; ZeroPoint = zero point stability

Calculation of the maximum measured error as a function of the flow rate

Flow rate	Maximum measured error in % o.r.
$\geq \frac{\text{ZeroPoint}}{\text{BaseAccu}} \cdot 100$ <small>A0021332</small>	$\pm \text{BaseAccu}$ <small>A0021339</small>
$< \frac{\text{ZeroPoint}}{\text{BaseAccu}} \cdot 100$ <small>A0021333</small>	$\pm \frac{\text{ZeroPoint}}{\text{MeasValue}} \cdot 100$ <small>A0021334</small>

Calculation of the maximum repeatability as a function of the flow rate

Flow rate	Maximum repeatability in % o.r.
$\geq \frac{1}{2} \cdot \frac{\text{ZeroPoint}}{\text{BaseRepeat}} \cdot 100$ <small>A0021335</small>	$\pm \text{BaseRepeat}$ <small>A0021340</small>
$< \frac{1}{2} \cdot \frac{\text{ZeroPoint}}{\text{BaseRepeat}} \cdot 100$ <small>A0021336</small>	$\pm \frac{1}{2} \cdot \frac{\text{ZeroPoint}}{\text{MeasValue}} \cdot 100$ <small>A0021337</small>

Example for max. measured error

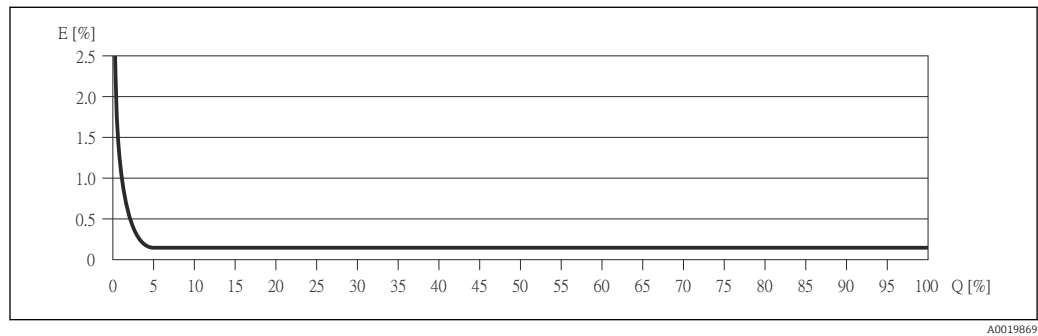

E Error: Maximum measured error as % o.r. (example)  
 Q Flow rate as %

Design fundamentals (→ 91)

## 16.7 Installation

"Mounting requirements" (→ 17)

## 16.8 Environment

Ambient temperature range (→ 18)

### Temperature tables

Observe the interdependencies between the permitted ambient and fluid temperatures when operating the device in hazardous areas.

For detailed information on the temperature tables, see the separate document entitled "Safety Instructions" (XA) for the device.

Storage temperature

- -40 to +80 °C (-40 to +176 °F), preferably at +20 °C (+68 °F) (standard version)
- -50 to +80 °C (-58 to +176 °F) (Order code for "Test, certificate", option JM)

Climate class DIN EN 60068-2-38 (test Z/AD)







Degree of protection

**Transmitter and sensor**

- As standard: IP66/67, type 4X enclosure
- When housing is open: IP20, type 1 enclosure
- Display module: IP20, type 1 enclosure

Shock resistance	As per IEC/EN 60068-2-31
Vibration resistance	Acceleration up to 1 g, 10 to 150 Hz, based on IEC/EN 60068-2-6
Electromagnetic compatibility (EMC)	<ul style="list-style-type: none"> <li>■ As per IEC/EN 61326 and NAMUR Recommendation 21 (NE 21)</li> <li>■ Complies with emission limits for industry as per EN 55011 (Class A)</li> </ul>  For details refer to the Declaration of Conformity.

## 16.9 Process

Medium temperature range	<p><b>Sensor</b> -50 to +150 °C (-58 to +302 °F)</p> <p><b>Seals</b> No internal seals</p>
Density	0 to 5 000 kg/m <sup>3</sup> (0 to 312 lb/cf)
Pressure-temperature ratings	 An overview of the pressure-temperature ratings for the process connections is provided in the "Technical Information" document
Rupture disk	<p>Trigger pressure in housing: 10 to 15 bar (145 to 218 psi)</p> <p>Special mounting instructions: (→  20)</p>
Flow limit	<p>Select the nominal diameter by optimizing between the required flow range and permissible pressure loss.</p> <p> For an overview of the measuring range full scale values, see the "Measuring range" section (→  84)</p> <ul style="list-style-type: none"> <li>■ The minimum recommended full scale value is approx. 1/20 of the maximum full scale value</li> <li>■ In most applications, 20 to 50 % of the maximum full scale value can be considered ideal</li> <li>■ A low full scale value must be selected for abrasive media (such as liquids with entrained solids): flow velocity &lt; 1 m/s (&lt; 3 ft/s).</li> <li>■ For gas measurement the following rules apply:             <ul style="list-style-type: none"> <li>- The flow velocity in the measuring tubes should not exceed half the sonic velocity (0.5 Mach).</li> <li>- The maximum mass flow depends on the density of the gas: formula (→  84)</li> </ul> </li> </ul>
Pressure loss	 To calculate the pressure loss, use the <i>Applicator</i> sizing tool (→  99)

## 16.10 Mechanical construction

Design, dimensions

 For the dimensions and installation lengths of the device, see the "Technical Information" document, "Mechanical construction" section

Weight

### Compact version

*Weight in SI units*

DN [mm]	Weight [kg]
8	3.8
15	4.4
25	5.1

*Weight in US units*

DN [in]	Weight [lbs]
$\frac{3}{8}$	8.4
$\frac{1}{2}$	9.7
1	11.3

Materials

### Transmitter housing

- Order code for "Housing", option **A** "Compact, aluminum coated":  
Aluminum, AlSi10Mg, coated
- Order code for "Housing", option **B** "Compact, stainless":  
Stainless steel 1.4301 (304)
- Order code for "Housing", option **C** "Ultra-compact, stainless":  
Stainless steel 1.4301 (304)

### Cable entries/cable glands

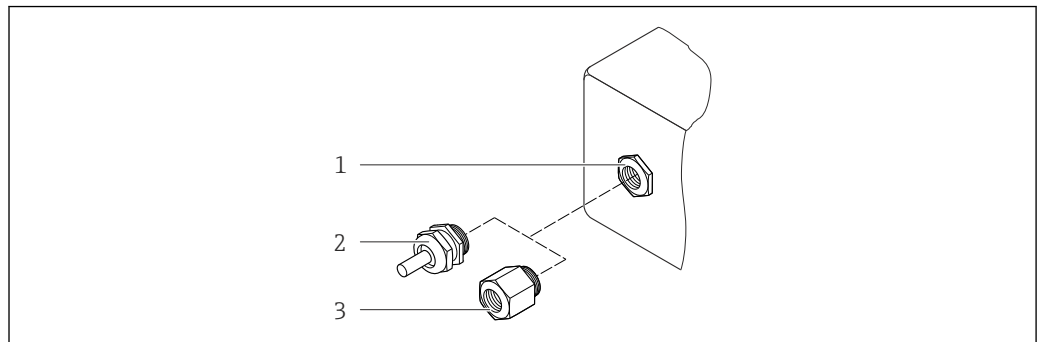

A0020640

 12 Possible cable entries/cable glands

- 1 Cable entry in transmitter housing, wall-mount housing or connection housing with internal thread M20 x 1.5
- 2 Cable gland M20 x 1.5
- 3 Adapter for cable entry with internal thread G  $\frac{1}{2}$ " or NPT  $\frac{1}{2}$ "

*Order Code for "Housing", Option A "Compact, coated aluminum"*

The various cable entries are suitable for hazardous and non-hazardous areas.

Cable entry/cable gland	Material
Cable gland M20 × 1.5	Nickel-plated brass
Adapter for cable entry with internal thread G ½"	
Adapter for cable entry with internal thread NPT ½"	

*Order code for "Housing", option B "Compact, stainless"*

The various cable entries are suitable for hazardous and non-hazardous areas.

Cable entry/cable gland	Material
Cable gland M20 × 1.5	Stainless steel, 1.4404 (316L)
Adapter for cable entry with internal thread G ½"	
Adapter for cable entry with internal thread NPT ½"	

**Device plug**

Electrical connection	Material
Plug M12x1	<ul style="list-style-type: none"> <li>▪ Socket: Stainless steel, 1.4404 (316L)</li> <li>▪ Contact housing: Polyamide</li> <li>▪ Contacts: Gold-plated brass</li> </ul>

**Sensor housing**

- Acid and alkali-resistant outer surface
- Stainless steel 1.4301 (304)

**Measuring tubes**

Stainless steel, 1.4435 (316L)

**Process connections/manifolds**

For all process connections/manifolds  
Stainless steel, 1.4404 (316/316L)

 List of all available process connections (→  96)

**Surface quality (parts in contact with medium)**

All data relate to parts in contact with fluid.  
Not polished

**Seals**

Welded process connections without internal seals

**Safety Barrier Promass 100**



Housing: Polyamide

## Process connections

## Internal thread

Cylindrical internal thread BSPP (G) in accordance with ISO 228-1 with sealing surfaces in accordance with DIN 3852-2/ISO 1179-1

 Sealed with profile seal (not included in scope of delivery) in accordance with DIN 3869 or copper disk or steel gasket with plastic lip.

 For information on the materials of the process connections (→  95)

## 16.11 Operability

## Local display

The local display is only available with the following device version:

Order code for "Display; Operation", option **B**: 4-line; lit, via communication

### Display element

- 4-line liquid crystal display with 16 characters per line.
- White background lighting; switches to red in event of device errors.
- Format for displaying measured variables and status variables can be individually configured.
- Permitted ambient temperature for the display: -20 to +60 °C (-4 to +140 °F). The readability of the display may be impaired at temperatures outside the temperature range.

### Disconnecting the local display from the main electronics module

 In the case of the "Compact, aluminum coated" housing version, the local display must only be disconnected manually from the main electronics module. In the case of the "Compact, hygienic, stainless" and "Ultra-compact, hygienic, stainless" housing versions, the local display is integrated in the housing cover and is disconnected from the main electronics module when the housing cover is opened.

#### *"Compact, aluminum coated" housing version*

The local display is plugged onto the main electronics module. The electronic connection between the local display and main electronics module is established via a connecting cable.

For some work performed on the measuring device (e.g. electrical connection), it is advisable to disconnect the local display from the main electronics module:

1. Press in the side latches of the local display.
2. Remove the local display from the main electronics module. Pay attention to the length of the connecting cable when doing so.

Once the work is completed, plug the local display back on.



Remote operation

Via Ethernet-based fieldbus

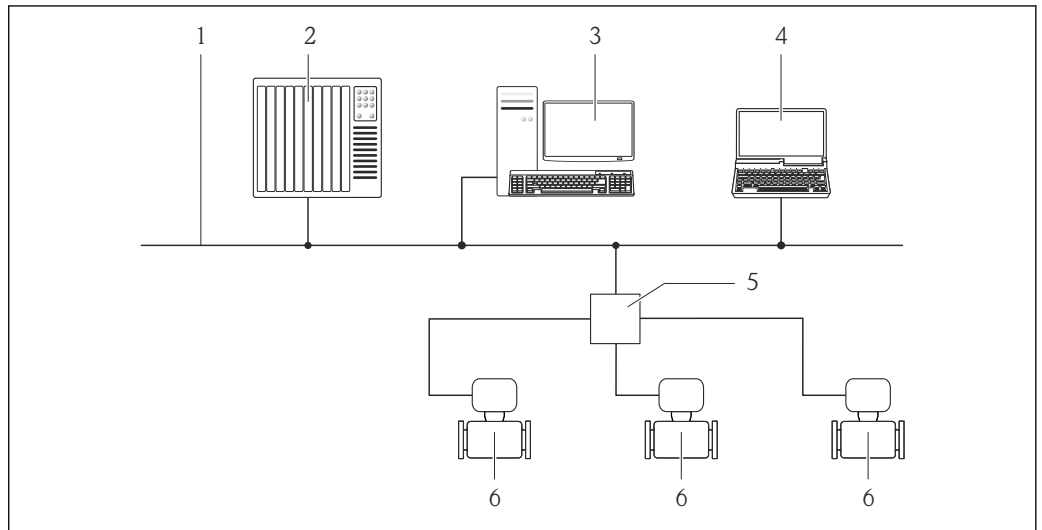

A0016961

- 1 Ethernet network
- 2 Automation system, e.g. "RSLogix" (Rockwell Automation)
- 3 Workstation for measuring device operation: with Add-on Profile Level 3 for "RSLogix 5000" (Rockwell Automation) or with Electronic Data Sheet (EDS)
- 4 Computer with Web browser (e.g. Internet Explorer) for accessing the integrated device Web server or with "FieldCare" operating tool with COM DTM "CDI Communication TCP/IP"
- 5 Ethernet switch
- 6 Measuring device

Service interface

Service interface (CDI-RJ45)

EtherNet/IP

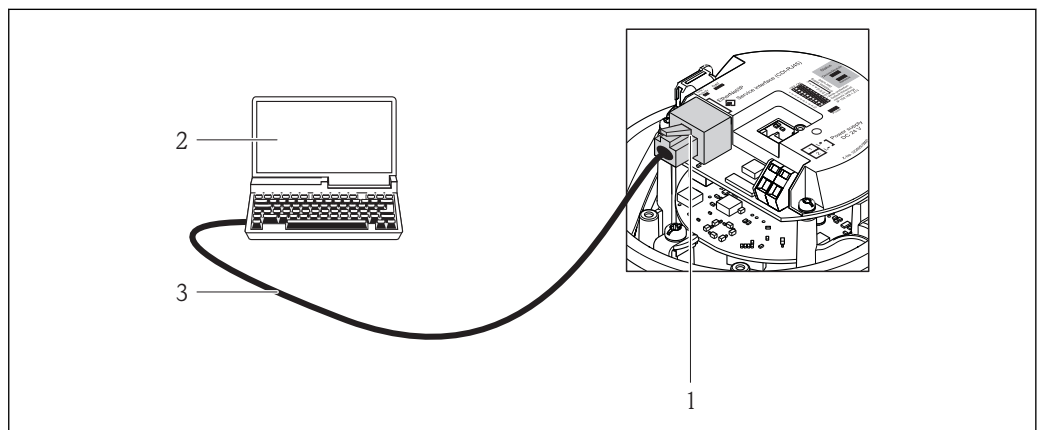

A0016940

13 Connection for order code for "Output", option N: EtherNet/IP

- 1 Service interface (CDI -RJ45) and EtherNet/IP interface of the measuring device with access to the integrated Web server
- 2 Computer with Web browser (e.g. Internet Explorer) for accessing the integrated device Web server or with "FieldCare" operating tool with COM DTM "CDI Communication TCP/IP"
- 3 Standard Ethernet connecting cable with RJ45 plug

---

Languages	<p>Can be operated in the following languages:</p> <ul style="list-style-type: none"> <li>■ Via "FieldCare" operating tool: <ul style="list-style-type: none"> <li>English, German, French, Spanish, Italian, Chinese, Japanese</li> </ul> </li> <li>■ Via Web browser <ul style="list-style-type: none"> <li>English, German, French, Spanish, Italian, Dutch, Portuguese, Polish, Russian, Turkish, Chinese, Japanese, Bahasa (Indonesian), Vietnamese, Czech</li> </ul> </li> </ul>
-----------	----------------------------------------------------------------------------------------------------------------------------------------------------------------------------------------------------------------------------------------------------------------------------------------------------------------------------------------------------------------------------------------------------------------------------------------------------------------------------------------

## 16.12 Certificates and approvals

---

CE mark	<p>The measuring system is in conformity with the statutory requirements of the applicable EC Directives. These are listed in the corresponding EC Declaration of Conformity along with the standards applied.</p> <p>Endress+Hauser confirms successful testing of the device by affixing to it the CE mark.</p>
C-Tick symbol	<p>The measuring system meets the EMC requirements of the "Australian Communications and Media Authority (ACMA)".</p>
Ex approval	<p>The devices are certified for use in hazardous areas and the relevant safety instructions are provided in the separate "Safety Instructions" (XA) document. Reference is made to this document on the nameplate.</p>
EtherNet/IP certification	<p>The measuring device is certified and registered by the ODVA (Open Device Vendor Association). The measuring system meets all the requirements of the following specifications:</p> <ul style="list-style-type: none"> <li>■ Certified in accordance with the ODVA Conformance Test</li> <li>■ EtherNet/IP Performance Test</li> <li>■ EtherNet/IP PlugFest compliance</li> <li>■ The device can also be operated with certified devices of other manufacturers (interoperability)</li> </ul>
Other standards and guidelines	<ul style="list-style-type: none"> <li>■ EN 60529 <ul style="list-style-type: none"> <li>Degrees of protection provided by enclosures (IP code)</li> </ul> </li> <li>■ IEC/EN 60068-2-6 <ul style="list-style-type: none"> <li>Environmental influences: Test procedure - Test Fc: vibrate (sinusoidal).</li> </ul> </li> <li>■ IEC/EN 60068-2-31 <ul style="list-style-type: none"> <li>Environmental influences: Test procedure - Test Ec: shocks due to rough handling, primarily for devices.</li> </ul> </li> <li>■ EN 61010-1 <ul style="list-style-type: none"> <li>Safety requirements for electrical equipment for measurement, control and laboratory use</li> </ul> </li> <li>■ IEC/EN 61326 <ul style="list-style-type: none"> <li>Emission in accordance with Class A requirements. Electromagnetic compatibility (EMC requirements).</li> </ul> </li> <li>■ NAMUR NE 21 <ul style="list-style-type: none"> <li>Electromagnetic compatibility (EMC) of industrial process and laboratory control equipment</li> </ul> </li> <li>■ NAMUR NE 32 <ul style="list-style-type: none"> <li>Data retention in the event of a power failure in field and control instruments with microprocessors</li> </ul> </li> <li>■ NAMUR NE 43 <ul style="list-style-type: none"> <li>Standardization of the signal level for the breakdown information of digital transmitters with analog output signal.</li> </ul> </li> </ul>

- NAMUR NE 53  
Software of field devices and signal-processing devices with digital electronics
- NAMUR NE 105  
Specifications for integrating fieldbus devices in engineering tools for field devices
- NAMUR NE 107  
Self-monitoring and diagnosis of field devices
- NAMUR NE 131  
Requirements for field devices for standard applications
- NAMUR NE 132  
Coriolis mass meter



## 16.13 Application packages

Many different application packages are available to enhance the functionality of the device. Such packages might be needed to address safety aspects or specific application requirements.

The application packages can be ordered from Endress+Hauser either directly with the device or subsequently. Detailed information on the order code in question is available from your local Endress+Hauser sales center or on the product page of the Endress+Hauser website: [www.endress.com](http://www.endress.com).

 Detailed information on the application packages:  
Special Documentation on the device

## 16.14 Accessories

 Overview of accessories available for order (→  83)

## 16.15 Documentation

-  For an overview of the scope of the associated Technical Documentation, refer to the following:
- The CD-ROM provided for the device (depending on the device version, the CD-ROM might not be part of the delivery!)
  - The *W@M Device Viewer* : Enter the serial number from the nameplate ([www.endress.com/deviceviewer](http://www.endress.com/deviceviewer))
  - The *Endress+Hauser Operations App*: Enter the serial number from the nameplate or scan the 2-D matrix code (QR code) on the nameplate.

Standard documentation

### Brief Operating Instructions

Measuring device	Documentation code
Promass G 100	KA01180D

### Technical Information

Measuring device	Documentation code
Promass G 100	TI01189D

Supplementary device-dependent documentation



**Safety Instructions**

Contents	Documentation code
ATEX/IECEX Ex i	XA00159D
ATEX/IECEX Ex nA	XA01029D
cCSAus IS	XA00160D
INMETRO Ex i	XA01219D
INMETRO Ex nA	XA01220D

**Special Documentation**

Contents	Documentation code
Concentration Measurement	SD01152D
Heartbeat Technology	SD01153D

**Installation instructions**

Contents	Documentation code
Installation Instructions for spare part sets	<p>Specified for each individual accessory                      (→  83)</p> <p> Overview of accessories available for order (→  83)</p>

## 17 Appendix

### 17.1 Overview of the operating menu

The following graphic provides an overview of the entire operating menu structure with its menus, submenus and parameters. The page reference indicates where a description of the parameter can be found in the manual.

Depending on the device version, not all submenus and parameters are available in every device. The selection can vary depending on the order code.

For the Order Code "Application Package", the associated parameters are described in the Special Documentation.

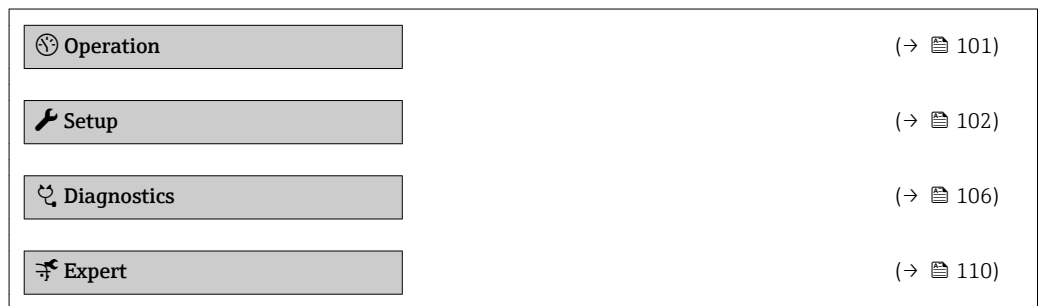

#### 17.1.1 "Operation" menu

Navigation Operation

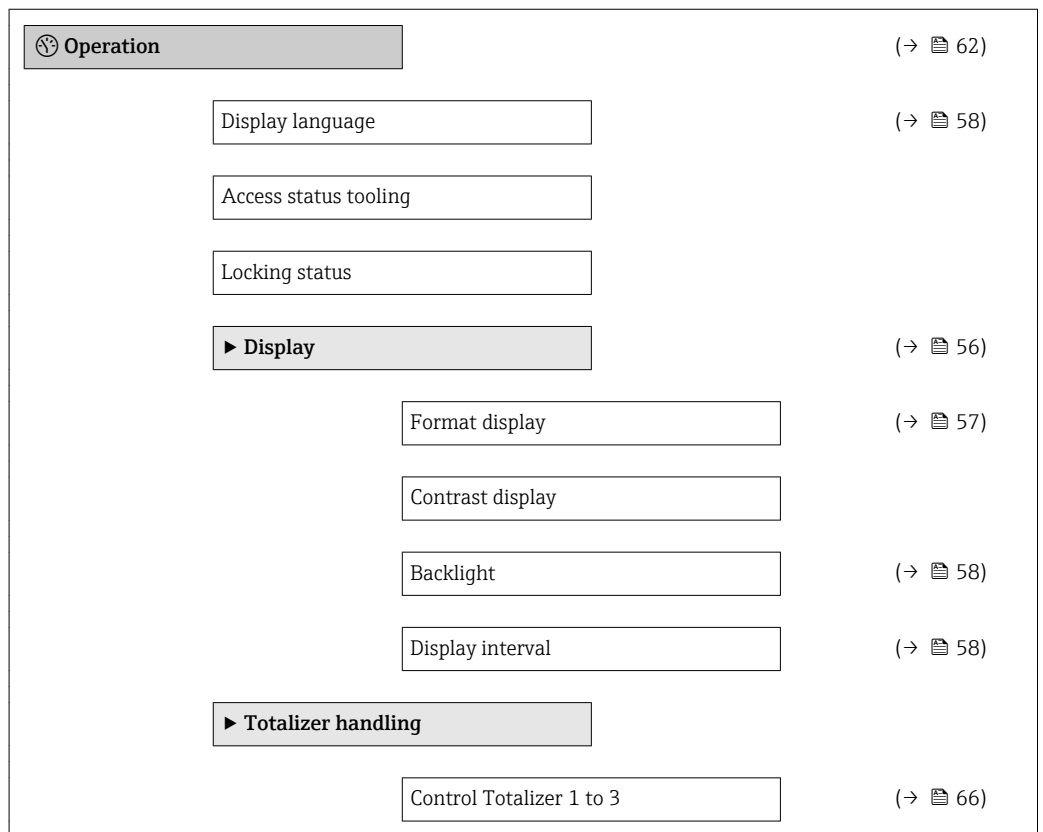

Preset value 1 to 3	(→ 📖 66)
Reset all totalizers	(→ 📖 66)

## 17.1.2 "Setup" menu

Navigation  Setup

<b>Setup</b>	(→ 📖 46)
<b>System units</b>	
Mass flow unit	(→ 📖 48)
Mass unit	(→ 📖 48)
Volume flow unit	(→ 📖 48)
Volume unit	(→ 📖 48)
Corrected volume flow unit	(→ 📖 48)
Corrected volume unit	(→ 📖 48)
Density unit	(→ 📖 48)
Reference density unit	(→ 📖 48)
Temperature unit	(→ 📖 48)
Pressure unit	(→ 📖 48)
<b>Medium selection</b>	
Select medium	(→ 📖 49)
Select gas type	(→ 📖 49)
Reference sound velocity	(→ 📖 49)
Temperature coefficient sound velocity	(→ 📖 49)
Pressure compensation	(→ 📖 49)
Pressure value	(→ 📖 49)
External pressure	(→ 📖 49)

<ul style="list-style-type: none"> <li>▶ <b>Communication</b></li> <li> <ul style="list-style-type: none"> <li>MAC address</li> <li>Default network settings</li> <li>DHCP client</li> <li>IP address</li> <li>Subnet mask</li> <li>Default gateway</li> </ul> </li> <li>▶ <b>Low flow cut off</b></li> <li> <ul style="list-style-type: none"> <li>Assign process variable</li> <li>On value low flow cutoff</li> <li>Off value low flow cutoff</li> <li>Pressure shock suppression</li> </ul> </li> <li>▶ <b>Partially filled pipe detection</b></li> <li> <ul style="list-style-type: none"> <li>Assign process variable</li> <li>Low value partial filled pipe detection</li> <li>High value partial filled pipe detection</li> <li>Response time part. filled pipe detect.</li> </ul> </li> <li>▶ <b>Advanced setup</b></li> <li> <ul style="list-style-type: none"> <li>Enter access code</li> <li>▶ <b>Calculated values</b></li> <li> <ul style="list-style-type: none"> <li>▶ <b>Corrected volume flow calculation</b></li> <li> <ul style="list-style-type: none"> <li>Corrected volume flow calculation</li> <li>External reference density</li> <li>Fixed reference density</li> <li>Reference temperature</li> </ul> </li> </ul> </li> </ul> </li> </ul>	<ul style="list-style-type: none"> <li>(→ ⓘ 50)</li> <li>(→ ⓘ 50)</li> <li>(→ ⓘ 50)</li> <li>(→ ⓘ 50)</li> <li>(→ ⓘ 50)</li> <li>(→ ⓘ 50)</li> <li>(→ ⓘ 51)</li> <li>(→ ⓘ 51)</li> <li>(→ ⓘ 51)</li> <li>(→ ⓘ 51)</li> <li>(→ ⓘ 52)</li> <li>(→ ⓘ 52)</li> <li>(→ ⓘ 52)</li> <li>(→ ⓘ 52)</li> <li>(→ ⓘ 53)</li> <li>(→ ⓘ 53)</li> <li>(→ ⓘ 54)</li> <li>(→ ⓘ 54)</li> <li>(→ ⓘ 54)</li> <li>(→ ⓘ 54)</li> </ul>
-----------------------------------------------------------------------------------------------------------------------------------------------------------------------------------------------------------------------------------------------------------------------------------------------------------------------------------------------------------------------------------------------------------------------------------------------------------------------------------------------------------------------------------------------------------------------------------------------------------------------------------------------------------------------------------------------------------------------------------------------------------------------------------------------------------------------------------------------------------------------------------------------------------------------------------------------------------------------------------------------------------------------------------------------------------------------------------------------------------------------------------------------------------------------------------------------------------------------------------------------------------------------	------------------------------------------------------------------------------------------------------------------------------------------------------------------------------------------------------------------------------------------------------------------------------------------------------------------------------------------------------------------------------------------------------------------

Linear expansion coefficient	(→ 54)
Square expansion coefficient	(→ 54)
► Sensor adjustment	(→ 54)
Installation direction	(→ 55)
► Zero point adjustment	
Zero point adjustment control	(→ 55)
Progress	(→ 55)
► Totalizer 1 to 3	(→ 55)
Assign process variable	(→ 55)
Unit totalizer	(→ 55)
Totalizer operation mode	(→ 55)
Failure mode	(→ 55)
► Display	(→ 56)
Format display	(→ 57)
Value 1 display	(→ 57)
0% bargraph value 1	(→ 57)
100% bargraph value 1	(→ 57)
Decimal places 1	(→ 57)
Value 2 display	(→ 57)
Decimal places 2	(→ 57)
Value 3 display	(→ 57)
0% bargraph value 3	(→ 57)
100% bargraph value 3	(→ 57)
Decimal places 3	(→ 58)
Value 4 display	(→ 58)



Decimal places 4	(→ 58)
Display language	(→ 58)
Display interval	(→ 58)
Display damping	(→ 58)
Header	(→ 58)
Header text	(→ 58)
Separator	(→ 58)
Backlight	(→ 58)
<b>► Viscosity</b>	
<b>► Temperature compensation</b>	
Calculation model	
Reference temperature	
Compensation coefficient X 1	
Compensation coefficient X 2	
<b>► Dynamic viscosity</b>	
Dynamic viscosity unit	
User dynamic viscosity text	
User dynamic viscosity factor	
User dynamic viscosity offset	
<b>► Kinematic viscosity</b>	
Kinematic viscosity unit	
User kinematic viscosity text	
User kinematic viscosity factor	
User kinematic viscosity offset	

▶ Concentration

▶ Heartbeat setup

▶ Heartbeat Monitoring

▶ Administration

### 17.1.3 "Diagnostics" menu

Navigation Diagnostics

Diagnostics (→ 74)

(→ 75)

Previous diagnostics	(→ 📄 75)
Timestamp	
Operating time from restart	
Operating time	
<b>▶ Diagnostic list</b>	
Diagnostics 1	
Timestamp	
Diagnostics 2	
Timestamp	
Diagnostics 3	
Timestamp	
Diagnostics 4	
Timestamp	
Diagnostics 5	
Timestamp	
<b>▶ Event logbook</b>	
Filter options	
<b>▶ Device information</b>	(→ 📄 77)
Device tag	
Serial number	
Firmware version	
Device name	
Order code	
Extended order code 1	
Extended order code 2	

Extended order code 3	
ENP version	
IP address	(→ 78)
Subnet mask	(→ 78)
Default gateway	(→ 78)
<b>► Measured values</b>	
<b>► Process variables</b>	(→ 63)
Mass flow	(→ 63)
Volume flow	(→ 63)
Corrected volume flow	(→ 63)
Density	(→ 63)
Reference density	(→ 63)
Temperature	(→ 63)
Pressure value	(→ 63)
Dynamic viscosity	
Kinematic viscosity	
Temp. compensated dynamic viscosity	
Temp. compensated kinematic viscosity	
Concentration	
Target mass flow	
Carrier mass flow	
<b>► Totalizer</b>	(→ 55)
Totalizer value 1 to 3	(→ 64)
Totalizer overflow 1 to 3	(→ 64)

► Heartbeat

► Performing verification

Year

Month

Day

Hour

AM/PM

Minute

Start verification

Progress (→ ⓘ 55)

Status

Overall result

► Verification results

Date/time

Verification ID

Operating time

Overall result

Sensor

Sensor integrity

Sensor electronic module



I/O module

► Monitoring results

Sensor integrity

► Simulation (→ ⓘ 58)

Assign simulation process variable (→ ⓘ 59)

Value process variable	(→  59)
Simulation device alarm	(→  59)
Simulation diagnostic event	

### 17.1.4 "Expert" menu













The following tables provide an overview of the **Expert** menu with its submenus and parameters. The direct access code to the parameter is given in brackets. The page reference indicates where a description of the parameter can be found in the manual.

Navigation  Expert

 Expert
------------------------------------------------------------------------------------------

#### "System" submenu

Navigation   Expert → System

▶ System	
▶ Display	(→  56)
Display language	(→  58)
Format display	(→  57)
Value 1 display	(→  57)
0% bargraph value 1	(→  57)
100% bargraph value 1	(→  57)
Decimal places 1	(→  57)
Value 2 display	(→  57)
Decimal places 2	(→  57)
Value 3 display	(→  57)
0% bargraph value 3	(→  57)
100% bargraph value 3	(→  57)
Decimal places 3	(→  58)









Value 4 display	(→ 58)
Decimal places 4	(→ 58)
Display interval	(→ 58)
Display damping	(→ 58)
Header	(→ 58)
Header text	(→ 58)
Separator	(→ 58)
Contrast display	
Backlight	(→ 58)
Access status display	
<b>► Diagnostic handling</b>	
Alarm delay	
<b>► Diagnostic behavior</b>	
Assign behavior of diagnostic no. 140	
Assign behavior of diagnostic no. 046	
Assign behavior of diagnostic no. 144	
Assign behavior of diagnostic no. 832	
Assign behavior of diagnostic no. 833	
Assign behavior of diagnostic no. 834	
Assign behavior of diagnostic no. 835	
Assign behavior of diagnostic no. 912	
Assign behavior of diagnostic no. 913	
Assign behavior of diagnostic no. 944	
Assign behavior of diagnostic no. 948	
Assign behavior of diagnostic no. 192	

	Assign behavior of diagnostic no. 274
	Assign behavior of diagnostic no. 392
	Assign behavior of diagnostic no. 592
	Assign behavior of diagnostic no. 992
<b>► Administration</b>	
	Define access code
	Device reset
	Activate SW option
	Software option overview

### "Sensor" submenu

Navigation

  Expert → Sensor

<b>► Sensor</b>	
	<b>► Measured values</b>
	<b>► Process variables</b> (→  63)
	Mass flow (→  63)
	Volume flow (→  63)
	Corrected volume flow (→  63)
	Density (→  63)
	Reference density (→  63)
	Temperature (→  63)
	Pressure value (→  63)
	Dynamic viscosity
	Kinematic viscosity
	Temp. compensated dynamic viscosity



Temp. compensated kinematic viscosity	
Concentration	
Target mass flow	
Carrier mass flow	
<b>► Totalizer</b>	(→ 55)
Totalizer value 1 to 3	(→ 64)
Totalizer overflow 1 to 3	(→ 64)
<b>► System units</b>	
Mass flow unit	(→ 48)
Mass unit	(→ 48)
Volume flow unit	(→ 48)
Volume unit	(→ 48)
Corrected volume flow unit	(→ 48)
Corrected volume unit	(→ 48)
Density unit	(→ 48)
Reference density unit	(→ 48)
Temperature unit	(→ 48)
Pressure unit	(→ 48)
Date/time format	
<b>► User-specific units</b>	
User mass text	
User mass offset	
User mass factor	
User volume text	
User volume offset	

User volume factor	
User corrected volume text	
User corrected volume offset	
User corrected volume factor	
User density text	
User density offset	
User density factor	
User pressure text	
User pressure offset	
User pressure factor	
<b>► Process parameters</b>	
Flow damping	
Density damping	
Temperature damping	
Flow override	
<b>► Low flow cut off</b>	(→ ⓘ 51)
Assign process variable	(→ ⓘ 51)
On value low flow cutoff	(→ ⓘ 51)
Off value low flow cutoff	(→ ⓘ 51)
Pressure shock suppression	(→ ⓘ 51)
<b>► Partially filled pipe detection</b>	(→ ⓘ 52)
Assign process variable	(→ ⓘ 52)
Low value partial filled pipe detection	(→ ⓘ 52)
High value partial filled pipe detection	(→ ⓘ 52)

Response time part. filled pipe detect.	(→ 52)
Maximum damping partial filled pipe det.	
<b>► Measurement mode</b>	
Select medium	(→ 49)
Select gas type	(→ 49)
Reference sound velocity	(→ 49)
Temperature coefficient sound velocity	(→ 49)
<b>► External compensation</b>	
Pressure compensation	(→ 49)
Pressure value	(→ 49)
External pressure	(→ 49)
Temperature mode	
External temperature	
<b>► Calculated values</b>	(→ 53)
<b>► Corrected volume flow calculation</b>	
Corrected volume flow calculation	(→ 54)
External reference density	(→ 54)
Fixed reference density	(→ 54)
Reference temperature	(→ 54)
Linear expansion coefficient	(→ 54)
Square expansion coefficient	(→ 54)
<b>► Sensor adjustment</b>	(→ 54)
Installation direction	(→ 55)

**► Zero point adjustment**

Zero point adjustment control

(→ ⓘ 55)

Progress

(→ ⓘ 55)

**► Process variable adjustment**

Mass flow offset

Mass flow factor

Volume flow offset

Volume flow factor

Density offset

Density factor

Corrected volume flow offset

Corrected volume flow factor

Reference density offset

Reference density factor

Temperature offset

Temperature factor

**► Calibration**

Calibration factor

Zero point

Nominal diameter

C

C

C

C

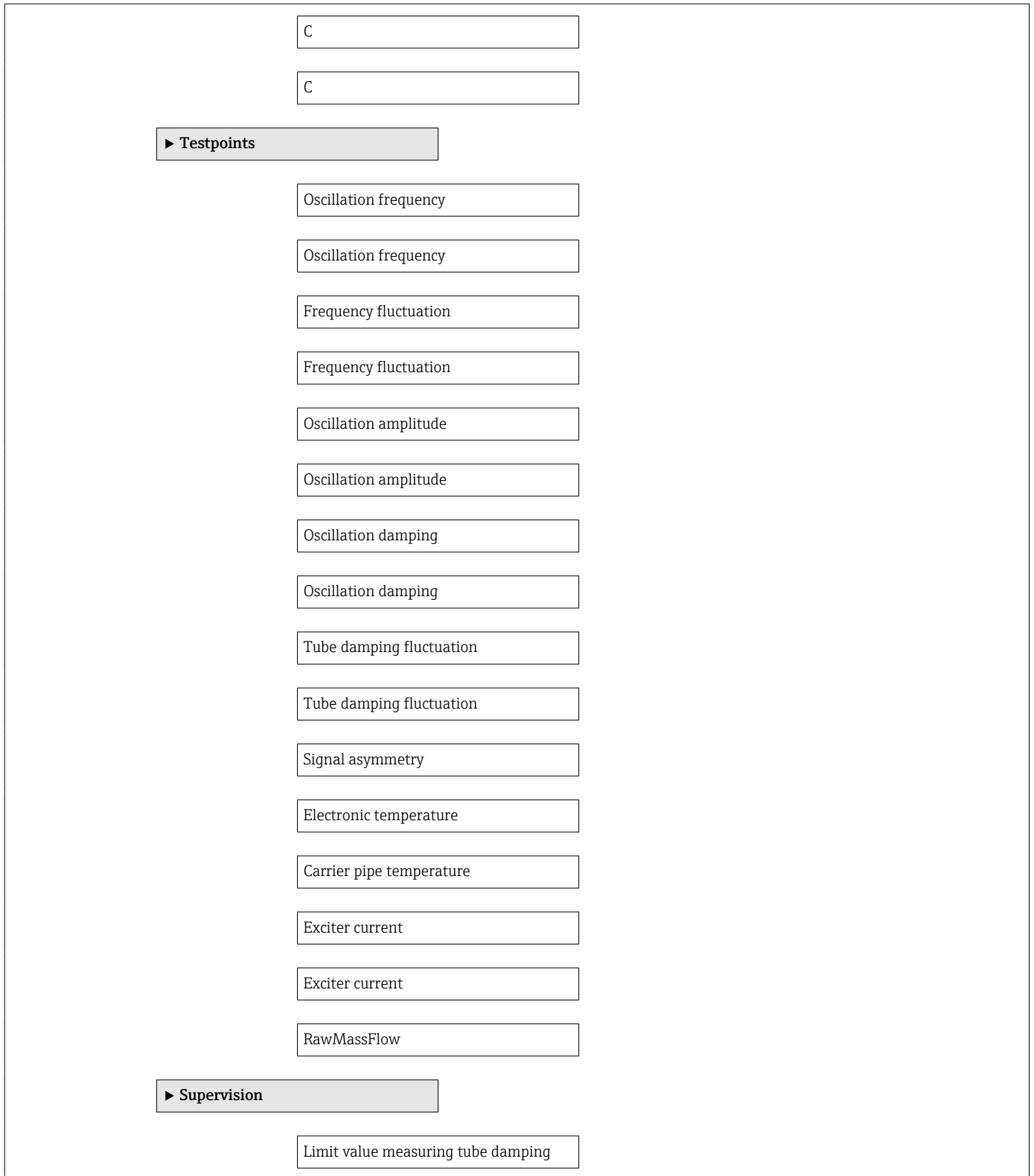

**"Current input" submenu**

Navigation   Expert → Input → Current input

▶ Input

▶ Status input

▶ Output

▶ Pulse/frequency/switch output 1 to 2

(→  65)

Damping output	
Failure mode	
Failure frequency	
Output frequency	(→ ⓘ 65)
Switch output function	
Assign diagnostic behavior	
Assign limit	
Switch-on value	
Switch-off value	
Assign flow direction check	
Assign status	
Failure mode	
Switch status	(→ ⓘ 65)
Invert output signal	

<b>► Communication</b>	(→ ⓘ 46)
<b>► Configuration</b>	
Web server language	
MAC address	(→ ⓘ 50)
Default network settings	(→ ⓘ 50)
DHCP client	(→ ⓘ 50)
IP address	(→ ⓘ 50)
Subnet mask	(→ ⓘ 50)
Default gateway	(→ ⓘ 50)

Web server functionality (→ 📄 37)

▶ **Configurable input assembly**

Input assembly position 1

Input assembly position 2

Input assembly position 3

Input assembly position 4

Input assembly position 5

Input assembly position 6

Input assembly position 7

Input assembly position 8

Input assembly position 9

Input assembly position 10

Input assembly position 11

Input assembly position 12

Input assembly position 13

Input assembly position 14

Input assembly position 15

Input assembly position 16

Input assembly position 17

Input assembly position 18

Input assembly position 19

Input assembly position 20

▶ **Application**

Reset all totalizers (→ 📄 66)



▶ Totalizer 1 to 3	(→ ⓘ 55)
Assign process variable	(→ ⓘ 55)
Unit totalizer	(→ ⓘ 55)
Totalizer operation mode	(→ ⓘ 55)
Control Totalizer 1 to 3	(→ ⓘ 66)
Preset value 1 to 3	(→ ⓘ 66)
Failure mode	(→ ⓘ 55)
▶ Viscosity	
Viscosity damping	
▶ Temperature compensation	
Calculation model	
Reference temperature	
Compensation coefficient X 1	
Compensation coefficient X 2	
▶ Dynamic viscosity	
Dynamic viscosity unit	
User dynamic viscosity text	
User dynamic viscosity factor	
User dynamic viscosity offset	
▶ Kinematic viscosity	
Kinematic viscosity unit	
User kinematic viscosity text	

	User kinematic viscosity factor	
	User kinematic viscosity offset	
<b>► Concentration</b>		
	Concentration damping	
	Concentration unit	
	User concentration text	
	User concentration factor	
	User concentration offset	
	A 0	
	A 1	
	A 2	
	A 3	
	A 4	
	B 1	
	B 2	
	B 3	

<b>► Diagnostics</b>		(→ ⓘ 74)
Actual diagnostics		(→ ⓘ 75)
Timestamp		
Previous diagnostics		(→ ⓘ 75)
Timestamp		
Operating time from restart		
Operating time		

► Diagnostic list

Diagnostics 1

Timestamp

Diagnostics 2

Timestamp

Diagnostics 3

Timestamp

Diagnostics 4

Timestamp

Diagnostics 5

Timestamp

► Event logbook

Filter options

► Device information

(→  77)

Device tag

Serial number

Firmware version

Device name

Order code

Extended order code 1

Extended order code 2

Extended order code 3

Configuration counter

ENP version

**▶ Min/max values**

Reset min/max values

**▶ Electronic temperature**

Minimum value

Maximum value

**▶ Medium temperature**

Minimum value

Maximum value

**▶ Carrier pipe temperature**

Minimum value

Maximum value

**▶ Oscillation frequency**

Minimum value

Maximum value

**▶ Torsion oscillation frequency**

Minimum value

Maximum value

**▶ Oscillation amplitude**

Minimum value

Maximum value

**▶ Torsion oscillation amplitude**

Minimum value

Maximum value

<b>► Oscillation damping</b>	
	Minimum value
	Maximum value
<b>► Torsion oscillation damping</b>	
	Minimum value
	Maximum value
<b>► Signal asymmetry</b>	
	Minimum value
	Maximum value
<b>► Heartbeat</b>	
<b>► Performing verification</b>	
	Year
	Month
	Day
	Hour
	AM/PM
	Minute
	Start verification
	Progress
	Status
	Overall result
<b>► Verification results</b>	
	Date/time
	Verification ID
	Operating time

(→ ⓘ 55)

Overall result	
Sensor	
Sensor integrity	
Sensor electronic module	
I/O module	
▶ Heartbeat Monitoring	
Activate monitoring	
▶ Monitoring results	
Sensor integrity	
▶ Simulation	(→ 58)
Assign simulation process variable	(→ 59)
Value process variable	(→ 59)
Simulation device alarm	(→ 59)
Simulation diagnostic event	

# Index

## A

Accuracy	89
Adapting the diagnostic behavior	72
Ambient temperature range	18
Application	8, 84
Application packages	99
Applicator	84
Approvals	98

## C

C-Tick symbol	98
Cable entries	
Technical data	89
Cable entry	
Degree of protection	29
CE mark	9, 98
Certificates	98
Check	
Installation	22
Checklist	
Post-connection check	30
Post-installation check	22
Cleaning	
Exterior cleaning	80
Climate class	92
Commissioning	46
Advanced settings	53
Configuring the measuring device	46
Connecting cable	24
Connecting the measuring device	26
Connection	
see Electrical connection	
Connection preparations	26
Connection tools	24
Current consumption	89
Current input (Submenu)	118
Cyclic data transmission	42

## D

Declaration of Conformity	9
Define access code	60
Degree of protection	29, 92
Density	93
Design	
Measuring device	11
Design fundamentals	
Maximum measured error	91
Repeatability	91
Designated use	8
Device components	11
Device description files	41
Device documentation	
Supplementary documentation	7
Device locking, status	62
Device name	
Sensor	13

Transmitter	13
Device repair	81
Device revision	41
Device type ID	41
Diagnostic information	
Communication interface	71
Design, description	70, 71
FieldCare	70
Light emitting diodes	68
Overview	72
Remedial measures	72
Web browser	69
Diagnostic list	75
Diagnostics (Menu)	106
DIP switch	
see Write protection switch	
Disabling write protection	59
Display	
Current diagnostic event	74
Previous diagnostic event	74
Display values	
For locking status	62
Disposal	81
Document	
Function	5
Symbols used	5
Document function	5

## E

Electrical connection	
Degree of protection	29
Measuring device	24
Operating tools	
Via Ethernet network	38, 97
Via service interface (CDI-RJ45)	38
RSLogix 5000	38, 97
Web server	38
Electromagnetic compatibility	93
Enabling write protection	59
Endress+Hauser services	
Maintenance	80
Repair	81
Error messages	
see Diagnostic messages	
EtherNet/IP	
Diagnostic information	71
EtherNet/IP certification	98
Event history	75
Events list	75
Ex approval	98
Expert (Menu)	110
Extended order code	
Sensor	13
Transmitter	13
Exterior cleaning	80

**F**

Field of application	
Residual risks	9
FieldCare	39
Device description file	41
Establishing a connection	39
Function	39
User interface	40
Filtering the event logbook	76
Firmware	
Release date	41
Version	41
Firmware history	79
Fix assembly	71
Flow direction	17, 22
Flow limit	93
Function check	46
Functions	
see Parameter	

**G**

Galvanic isolation	86
--------------------	----

**H**

Hardware write protection	60
---------------------------	----

**I**

I/O electronics module	11, 27
Identifying the measuring device	12
Incoming acceptance	12
Influence	
Medium pressure	91
Medium temperature	91
Information on the document	5
Inlet runs	18
Input	84
Inspection	
Received goods	12
Inspection check	
Connection	30
Installation	17
Installation conditions	
System pressure	18
Vibrations	20
Installation dimensions	18

**L**

Languages, operation options	98
Low flow cut off	86

**M**

Main electronics module	11
Maintenance tasks	80
Manufacturer ID	41
Manufacturing date	13
Materials	94
Maximum measured error	89
Measured variables	
see Process variables	

Measuring and test equipment	80
Measuring device	
Configuring	46
Conversion	81
Design	11
Disposal	82
Integrating via HART protocol	41
Mounting the sensor	22
Preparing for electrical connection	26
Preparing for mounting	21
Removing	81
Repair	81
Measuring principle	84
Measuring range	
For gases	84
For liquids	84
Measuring range, recommended	93
Measuring system	84
Media	8
Medium pressure	
Influence	91
Medium temperature	
Influence	91
Menu	
Diagnostics	74, 106
Expert	110
Operation	62, 101
Setup	47, 102
Menus	
For measuring device configuration	46
For specific settings	53
Mounting dimensions	
see Installation dimensions	
Mounting location	17
Mounting preparations	21
Mounting requirements	
Inlet and outlet runs	18
Installation dimensions	18
Mounting location	17
Orientation	17
Rupture disk	20
Sensor heating	20
Thermal insulation	19
Mounting tools	21

**N**

Nameplate	
Sensor	13
Transmitter	13

**O**

Operable flow range	85
Operating menu	
Menus, submenus	32
Overview of menus with parameters	101
Structure	32
Submenus and user roles	33
Operating philosophy	33
Operation	62



- Operation (Menu) . . . . . 101
- Operation options . . . . . 31
- Operational safety . . . . . 9
- Order code . . . . . 13
- Orientation (vertical, horizontal) . . . . . 17
- Outlet runs . . . . . 18
- Output . . . . . 85
- Output signal . . . . . 85
- Overview
  - Operating menu . . . . . 101
- P**
- Packaging disposal . . . . . 16
- Parameter settings
  - Calculated values (Submenu) . . . . . 53
  - Communication (Submenu) . . . . . 50
  - Device information (Submenu) . . . . . 77
  - Diagnostics (Menu) . . . . . 74
  - Display (Submenu) . . . . . 56
  - Low flow cut off (Wizard) . . . . . 51
  - Operation (Submenu) . . . . . 65
  - Output values (Submenu) . . . . . 64
  - Partially filled pipe detection (Wizard) . . . . . 52
  - Process variables (Submenu) . . . . . 63
  - Select medium (Submenu) . . . . . 49
  - Sensor adjustment (Submenu) . . . . . 54
  - Setup (Menu) . . . . . 47
  - Simulation (Submenu) . . . . . 58
  - Totalizer (Submenu) . . . . . 63
  - Totalizer 1 to 3 (Submenu) . . . . . 55
  - Web server (Submenu) . . . . . 37
- Performance characteristics . . . . . 89
- Post-connection check (checklist) . . . . . 30
- Post-installation check . . . . . 46
- Post-installation check (checklist) . . . . . 22
- Potential equalization . . . . . 89
- Power consumption . . . . . 89
- Power supply failure . . . . . 89
- Pressure loss . . . . . 93
- Pressure-temperature ratings . . . . . 93
- Process connections . . . . . 96
- Process variables
  - Calculated . . . . . 84
  - Measured . . . . . 84
- Product safety . . . . . 9
- Protecting parameter settings . . . . . 59
- R**
- Reading measured values . . . . . 63
- Reading out diagnostic information, EtherNet/IP . . . . . 71
- Recalibration . . . . . 80
- Reference operating conditions . . . . . 89
- Registered trademarks . . . . . 7
- Remote operation . . . . . 97
- Repair . . . . . 81
  - Notes . . . . . 81
- Repair of a device . . . . . 81
- Repeatability . . . . . 90
- Replacement
  - Device components . . . . . 81
  - Requirements for personnel . . . . . 8
  - Response time . . . . . 91
  - Return . . . . . 81
  - Rupture disk
    - Safety instructions . . . . . 20
    - Triggering pressure . . . . . 93
- S**
- Safety . . . . . 8
- Seals
  - Fluid temperature range . . . . . 93
- Sensor
  - Fluid temperature range . . . . . 93
  - Mounting . . . . . 22
- Sensor (Submenu) . . . . . 112
- Sensor heating . . . . . 20
- Serial number . . . . . 13
- Service interface (CDI-RJ45) . . . . . 97
- Settings
  - Adapting the measuring device to the process conditions . . . . . 65
  - Advanced display configurations . . . . . 56
  - Communication interface . . . . . 50
  - Device reset . . . . . 77
  - Device tag . . . . . 47
  - Low flow cut off . . . . . 51
  - Medium . . . . . 49
  - Partial filled pipe detection . . . . . 52
  - Resetting the totalizer . . . . . 65
  - Sensor adjustment . . . . . 54
  - Simulation . . . . . 58
  - System units . . . . . 47
  - Totalizer . . . . . 55
  - Totalizer reset . . . . . 65
- Setup (Menu) . . . . . 102
- Shock resistance . . . . . 93
- Signal on alarm . . . . . 85
- Software release . . . . . 41
- Spare part . . . . . 81
- Spare parts . . . . . 81
- Special connection instructions . . . . . 28
- Standards and guidelines . . . . . 98
- Status signals . . . . . 69
- Storage conditions . . . . . 15
- Storage temperature . . . . . 15
- Structure
  - Operating menu . . . . . 32
- Submenu
  - Advanced setup . . . . . 53
  - Calculated values . . . . . 53
  - Communication . . . . . 46, 50
  - Current input . . . . . 118
  - Define access code . . . . . 60
  - Device information . . . . . 77
  - Display . . . . . 56
  - Events list . . . . . 75
  - Operation . . . . . 65
  - Output values . . . . . 64

Overview	33	US units	94
Process variables	53, 63	Wizard	
Select medium	49	Define access code	59
Sensor	112	Low flow cut off	51
Sensor adjustment	54	Partially filled pipe detection	52
Simulation	58	Workplace safety	9
System	110	Write protection	
Totalizer	63	Via access code	59
Totalizer 1 to 3	55	Via write protection switch	60
Web server	37	Write protection switch	60
Supply voltage	88		
System (Submenu)	110		
System design			
Measuring system	84		
see Measuring device design			
System file			
Release date	41		
Source	41		
Version	41		
System integration	41		
System pressure	18		
<b>T</b>			
Technical data, overview	84		
Temperature range			
Medium temperature	93		
Storage temperature	15		
Terminal assignment	25, 27		
Terminals	89		
Thermal insulation	19		
Tools			
Electrical connection	24		
Installation	21		
Transport	15		
Transmitter			
Connecting the signal cables	27		
Turning the display module	22		
Transporting the measuring device	15		
Troubleshooting			
General	67		
Turning the display module	22		
<b>U</b>			
Use of the measuring device			
Borderline cases	8		
Incorrect use	8		
see Designated use			
User roles	33		
<b>V</b>			
Version data for the device	41		
Vibration resistance	93		
Vibrations	20		
<b>W</b>			
W@M	80, 81		
W@M Device Viewer	12, 81		
Weight			
SI units	94		
Transport (notes)	15		



[www.addresses.endress.com](http://www.addresses.endress.com)

---