

Operating Instructions

Proline Promag D 400

EtherNet/IP

Electromagnetic flowmeter

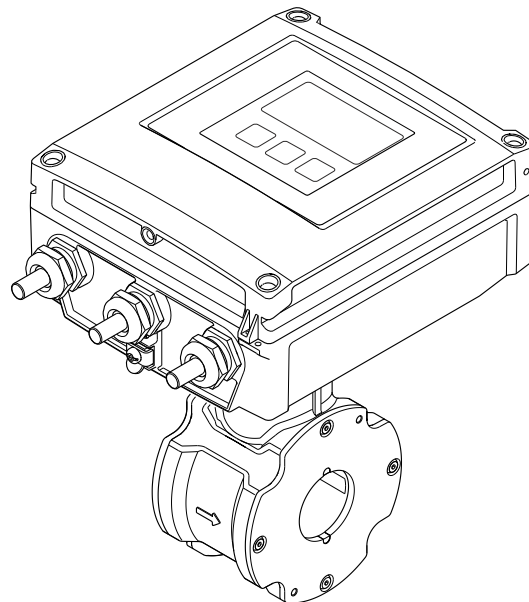

- Make sure the document is stored in a safe place such that it is always available when working on or with the device.
- To avoid danger to individuals or the facility, read the "Basic safety instructions" section carefully, as well as all other safety instructions in the document that are specific to working procedures.
- The manufacturer reserves the right to modify technical data without prior notice. Your Endress+Hauser Sales Center will supply you with current information and updates to these Instructions.

Table of contents

1	Document information	6		
1.1	Document function	6		
1.2	Symbols used	6		
1.2.1	Safety symbols	6		
1.2.2	Electrical symbols	6		
1.2.3	Tool symbols	7		
1.2.4	Symbols for certain types of information	7		
1.2.5	Symbols in graphics	7		
1.3	Documentation	8		
1.3.1	Standard documentation	8		
1.3.2	Supplementary device-dependent documentation	8		
1.4	Registered trademarks	8		
2	Basic safety instructions	9		
2.1	Requirements for the personnel	9		
2.2	Designated use	9		
2.3	Workplace safety	10		
2.4	Operational safety	10		
2.5	Product safety	10		
2.6	IT security	11		
3	Product description	12		
3.1	Product design	12		
4	Incoming acceptance and product identification	13		
4.1	Incoming acceptance	13		
4.2	Product identification	13		
4.2.1	Transmitter nameplate	14		
4.2.2	Sensor nameplate	15		
4.2.3	Symbols on measuring device	15		
5	Storage and transport	16		
5.1	Storage conditions	16		
5.2	Transporting the product	16		
5.3	Packaging disposal	17		
6	Mounting	17		
6.1	Installation conditions	17		
6.1.1	Mounting position	17		
6.1.2	Requirements from environment and process	19		
6.1.3	Special mounting instructions	21		
6.2	Mounting the measuring device	21		
6.2.1	Required tools	21		
6.2.2	Preparing the measuring device	21		
6.2.3	Mounting the sensor	22		
6.2.4	Mounting the transmitter of the remote version	25		
6.2.5	Turning the transmitter housing	26		
6.2.6	Turning the display module	28		
6.3	Post-installation check	29		
7	Electrical connection	30		
7.1	Connection conditions	30		
7.1.1	Required tools	30		
7.1.2	Requirements for connecting cable	30		
7.1.3	Terminal assignment	32		
7.1.4	Pin assignment, device plug	33		
7.1.5	Preparing the measuring device	33		
7.1.6	Preparing the connecting cable for the remote version	34		
7.2	Connecting the measuring device	35		
7.2.1	Connecting the transmitter	36		
7.2.2	Connecting the remote version	36		
7.2.3	Ensuring potential equalization	38		
7.3	Special connection instructions	40		
7.3.1	Connection examples	40		
7.4	Hardware settings	40		
7.4.1	Setting the device address	40		
7.5	Ensuring the degree of protection	41		
7.5.1	Degree of protection IP66/67, Type 4X enclosure	41		
7.6	Post-connection check	41		
8	Operation options	43		
8.1	Overview of operation options	43		
8.2	Structure and function of the operating menu	44		
8.2.1	Structure of the operating menu	44		
8.2.2	Operating philosophy	45		
8.3	Access to the operating menu via the local display	46		
8.3.1	Operational display	46		
8.3.2	Navigation view	48		
8.3.3	Editing view	50		
8.3.4	Operating elements	51		
8.3.5	Opening the context menu	52		
8.3.6	Navigating and selecting from list	54		
8.3.7	Calling the parameter directly	54		
8.3.8	Calling up help text	55		
8.3.9	Changing the parameters	56		
8.3.10	User roles and related access authorization	57		
8.3.11	Disabling write protection via access code	57		
8.3.12	Enabling and disabling the keypad lock	57		
8.4	Access to the operating menu via the Web browser	58		
8.4.1	Function range	58		
8.4.2	Prerequisites	58		
8.4.3	Establishing a connection	59		

8.4.4	Logging on	60	12	Diagnostics and troubleshooting ...	88
8.4.5	User interface	61	12.1	General troubleshooting	88
8.4.6	Disabling the Web server	62	12.2	Diagnostic information via light emitting diodes	90
8.4.7	Logging out	62	12.2.1	Transmitter	90
8.5	Access to the operating menu via the operating tool	62	12.3	Diagnostic information on local display	91
8.5.1	Connecting the operating tool	63	12.3.1	Diagnostic message	91
8.5.2	FieldCare	63	12.3.2	Calling up remedial measures	93
9	System integration	65	12.4	Diagnostic information in the Web browser ..	94
9.1	Overview of device description files	65	12.4.1	Diagnostic options	94
9.1.1	Current version data for the device ...	65	12.4.2	Calling up remedy information	94
9.1.2	Operating tools	65	12.5	Diagnostic information in FieldCare	95
9.2	Overview of system files	65	12.5.1	Diagnostic options	95
9.3	Integrating the measuring device in the system	65	12.5.2	Calling up remedy information	96
10	Commissioning	67	12.6	Diagnostic information via communication interface	96
10.1	Function check	67	12.6.1	Reading out diagnostic information ..	96
10.2	Switching on the measuring device	67	12.7	Adapting the diagnostic information	96
10.3	Configuring the device address via software ..	67	12.7.1	Adapting the diagnostic behavior ...	96
10.3.1	Ethernet network and Web server ...	67	12.8	Overview of diagnostic information	97
10.4	Setting the operating language	67	12.9	Pending diagnostic events	99
10.5	Configuring the measuring device	68	12.10	Diagnostic list	100
10.5.1	Defining the tag name	68	12.11	Event logbook	100
10.5.2	Setting the system units	69	12.11.1	Event history	100
10.5.3	Configuring the local display	70	12.11.2	Filtering the event logbook	101
10.5.4	Configuring the communication interface	72	12.11.3	Overview of information events ...	101
10.5.5	Configuring the low flow cut off	73	12.12	Resetting the measuring device	102
10.5.6	Configuring empty pipe detection ...	74	12.13	Device information	102
10.6	Advanced settings	75	12.14	Firmware history	104
10.6.1	Carrying out a sensor adjustment ...	76	13	Maintenance	105
10.6.2	Configuring the totalizer	76	13.1	Maintenance tasks	105
10.6.3	Carrying out additional display configurations	77	13.1.1	Exterior cleaning	105
10.7	Simulation	79	13.1.2	Interior cleaning	105
10.8	Protecting settings from unauthorized access	80	13.1.3	Replacing seals	105
10.8.1	Write protection via access code	80	13.2	Measuring and test equipment	105
10.8.2	Write protection via write protection switch	81	13.3	Endress+Hauser services	105
11	Operation	83	14	Repair	106
11.1	Read out and modify current Ethernet settings	83	14.1	General notes	106
11.2	Reading device locking status	83	14.2	Spare parts	106
11.3	Adjusting the operating language	84	14.3	Endress+Hauser services	106
11.4	Configuring the display	84	14.4	Return	106
11.5	Reading measured values	84	14.5	Disposal	106
11.5.1	Process variables	84	14.5.1	Removing the measuring device ...	106
11.5.2	Totalizer	85	14.5.2	Disposing of the measuring device ..	107
11.6	Adapting the measuring device to the process conditions	85	15	Accessories	108
11.7	Performing a totalizer reset	85	15.1	Device-specific accessories	108
11.8	Showing data logging	86	15.1.1	For the transmitter	108
			15.1.2	For the sensor	108
			15.2	Communication-specific accessories	108
			15.3	Service-specific accessories	108
			15.4	System components	109

16	Technical data	110
16.1	Application	110
16.2	Function and system design	110
16.3	Input	110
16.4	Output	111
16.5	Power supply	114
16.6	Performance characteristics	115
16.7	Installation	116
16.8	Environment	116
16.9	Process	117
16.10	Mechanical construction	118
16.11	Operability	123
16.12	Certificates and approvals	125
16.13	Application packages	126
16.14	Accessories	126
16.15	Supplementary documentation	127
17	Appendix	128
17.1	Overview of the operating menu	128
17.1.1	Main menu	128
17.1.2	"Operation" menu	128
17.1.3	"Setup" menu	129
17.1.4	"Diagnostics" menu	131
17.1.5	"Expert" menu	133
	Index	142





1 Document information

1.1 Document function







These Operating Instructions contain all the information that is required in various phases of the life cycle of the device: from product identification, incoming acceptance and storage, to mounting, connection, operation and commissioning through to troubleshooting, maintenance and disposal.

1.2 Symbols used



1.2.1 Safety symbols

Symbol	Meaning
	DANGER! This symbol alerts you to a dangerous situation. Failure to avoid this situation will result in serious or fatal injury.
	WARNING! This symbol alerts you to a dangerous situation. Failure to avoid this situation can result in serious or fatal injury.
	CAUTION! This symbol alerts you to a dangerous situation. Failure to avoid this situation can result in minor or medium injury.
	NOTE! This symbol contains information on procedures and other facts which do not result in personal injury.











1.2.2 Electrical symbols

Symbol	Meaning
	Direct current A terminal to which DC voltage is applied or through which direct current flows.
	Alternating current A terminal to which alternating voltage is applied or through which alternating current flows.
	Direct current and alternating current <ul style="list-style-type: none"> ▪ A terminal to which alternating voltage or DC voltage is applied. ▪ A terminal through which alternating current or direct current flows.
	Ground connection A grounded terminal which, as far as the operator is concerned, is grounded via a grounding system.
	Protective ground connection A terminal which must be connected to ground prior to establishing any other connections.
	Equipotential connection A connection that has to be connected to the plant grounding system: This may be a potential equalization line or a star grounding system depending on national or company codes of practice.







1.2.3 Tool symbols

Symbol	Meaning
	Torx screwdriver
	Phillips head screwdriver
	Open-ended wrench

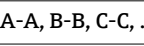

1.2.4 Symbols for certain types of information

Symbol	Meaning
	Permitted Indicates procedures, processes or actions that are permitted.
	Preferred Indicates procedures, processes or actions that are preferred.
	Forbidden Indicates procedures, processes or actions that are forbidden.
	Tip Indicates additional information.
	Reference to documentation Refers to the corresponding device documentation.
	Reference to page Refers to the corresponding page number.
	Reference to graphic Refers to the corresponding graphic number and page number.
	Series of steps
	Result of a sequence of actions
	Help in the event of a problem
	Visual inspection

1.2.5 Symbols in graphics

Symbol	Meaning
	Item numbers
	Series of steps
	Views
	Sections
	Flow direction
	Hazardous area Indicates a hazardous area.
	Safe area (non-hazardous area) Indicates the non-hazardous area.

1.3 Documentation

-  For an overview of the scope of the associated Technical Documentation, refer to the following:
- The CD-ROM provided for the device (depending on the device version, the CD-ROM might not be part of the delivery!)
 - The *W@M Device Viewer* : Enter the serial number from the nameplate (www.endress.com/deviceviewer)
 - The *Endress+Hauser Operations App*: Enter the serial number from the nameplate or scan the 2-D matrix code (QR code) on the nameplate.
-  For a detailed list of the individual documents along with the documentation code

1.3.1 Standard documentation

Document type	Purpose and content of the document
Technical Information	Planning aid for your device The document contains all the technical data on the device and provides an overview of the accessories and other products that can be ordered for the device.
Brief Operating Instructions	Guide that takes you quickly to the 1st measured value The Brief Operating Instructions contain all the essential information from incoming acceptance to initial commissioning.

1.3.2 Supplementary device-dependent documentation

Additional documents are supplied depending on the device version ordered: Always comply strictly with the instructions in the supplementary documentation. The supplementary documentation is an integral part of the device documentation.

1.4 Registered trademarks

EtherNet/IP™

Trademark of ODVA, Inc.

Microsoft®

Registered trademark of the Microsoft Corporation, Redmond, Washington, USA

Applicator®, FieldCare®, Field Xpert™, HistoROM®, Heartbeat Technology™

Registered or registration-pending trademarks of the Endress+Hauser Group

2 Basic safety instructions

2.1 Requirements for the personnel

The personnel for installation, commissioning, diagnostics and maintenance must fulfill the following requirements:

- ▶ Trained, qualified specialists must have a relevant qualification for this specific function and task
- ▶ Are authorized by the plant owner/operator
- ▶ Are familiar with federal/national regulations
- ▶ Before beginning work, the specialist staff must have read and understood the instructions in the Operating Instructions and supplementary documentation as well as in the certificates (depending on the application)
- ▶ Following instructions and basic conditions

The operating personnel must fulfill the following requirements:

- ▶ Being instructed and authorized according to the requirements of the task by the facility's owner-operator
- ▶ Following the instructions in these Operating Instructions

2.2 Designated use

Application and media

The measuring device described in these Instructions is intended only for flow measurement of liquids with a minimum conductivity of 5 $\mu\text{S}/\text{cm}$.

Depending on the version ordered, the measuring device can also measure potentially explosive, flammable, poisonous and oxidizing media.

Measuring devices for use in hazardous areas, in hygienic applications or in applications where there is an increased risk due to process pressure, are labeled accordingly on the nameplate.

To ensure that the measuring device remains in proper condition for the operation time:

- ▶ Only use the measuring device in full compliance with the data on the nameplate and the general conditions listed in the Operating Instructions and supplementary documentation.
- ▶ Based on the nameplate, check whether the ordered device is permitted for the intended use in the hazardous area (e.g. explosion protection, pressure vessel safety).
- ▶ Use the measuring device only for media against which the process-wetted materials are adequately resistant.
- ▶ If the measuring device is not operated at atmospheric temperature, compliance with the relevant basic conditions specified in the associated device documentation is absolutely essential: "Documentation" section (\rightarrow  8).

Incorrect use

Non-designated use can compromise safety. The manufacturer is not liable for damage caused by improper or non-designated use.

WARNING

Danger of breakage of the sensor due to corrosive or abrasive fluids!

- ▶ Verify the compatibility of the process fluid with the sensor material.
- ▶ Ensure the resistance of all fluid-wetted materials in the process.
- ▶ Observe the specified pressure and temperature range.

Verification for borderline cases:

- ▶ For special fluids and fluids for cleaning, Endress+Hauser is glad to provide assistance in verifying the corrosion resistance of fluid-wetted materials, but does not accept any

warranty or liability as minute changes in the temperature, concentration or level of contamination in the process can alter the corrosion resistance properties.

Residual risks

The external surface temperature of the housing can increase by max. 10 K due to the power consumption of the electronic components. Hot process fluids passing through the measuring device will further increase the surface temperature of the housing. The surface of the sensor, in particular, can reach temperatures which are close to the fluid temperature.

Possible burn hazard due to fluid temperatures!

- ▶ For elevated fluid temperature, ensure protection against contact to prevent burns.

2.3 Workplace safety

For work on and with the device:

- ▶ Wear the required personal protective equipment according to federal/national regulations.

For welding work on the piping:

- ▶ Do not ground the welding unit via the measuring device.

If working on and with the device with wet hands:

- ▶ It is recommended to wear gloves on account of the higher risk of electric shock.

2.4 Operational safety

Risk of injury.

- ▶ Operate the device in proper technical condition and fail-safe condition only.
- ▶ The operator is responsible for interference-free operation of the device.

Conversions to the device

Unauthorized modifications to the device are not permitted and can lead to unforeseeable dangers.

- ▶ If, despite this, modifications are required, consult with Endress+Hauser.

Repair

To ensure continued operational safety and reliability,

- ▶ Carry out repairs on the device only if they are expressly permitted.
- ▶ Observe federal/national regulations pertaining to repair of an electrical device.
- ▶ Use original spare parts and accessories from Endress+Hauser only.

Environmental requirements

If a plastic transmitter housing is permanently exposed to certain steam and air mixtures, this can damage the housing.

- ▶ If you are unsure, please contact your Endress+Hauser Sales Center for clarification.
- ▶ If used in an approval-related area, observe the information on the nameplate.

2.5 Product safety

This measuring device is designed in accordance with good engineering practice to meet state-of-the-art safety requirements, has been tested, and left the factory in a condition in which it is safe to operate.

It meets general safety standards and legal requirements. It also complies with the EC directives listed in the device-specific EC Declaration of Conformity. Endress+Hauser confirms this by affixing the CE mark to the device.

2.6 IT security

We only provide a warranty if the device is installed and used as described in the Operating Instructions. The device is equipped with security mechanisms to protect it against any inadvertent changes to the device settings.

IT security measures in line with operators' security standards and designed to provide additional protection for the device and device data transfer must be implemented by the operators themselves.

3 Product description

3.1 Product design

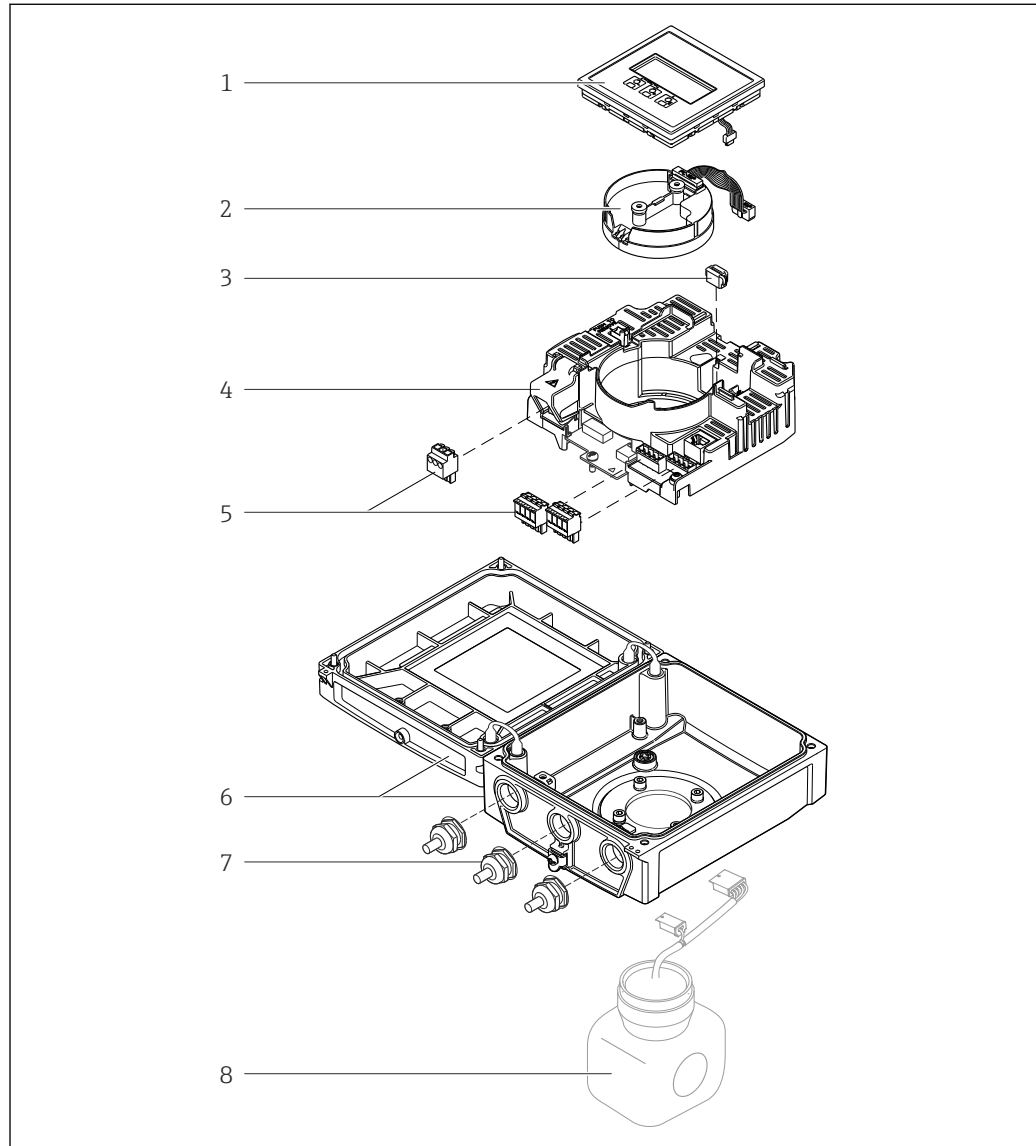

A0021563

1 Important components of the compact version

- 1 Display module
- 2 Smart sensor electronics module
- 3 HistoROM DAT (plug-in memory)
- 4 Main electronics module
- 5 Terminals (screw terminals, some available as plug-in terminals)
- 6 Transmitter housing, compact version
- 7 Cable glands
- 8 Sensor, compact version

4 Incoming acceptance and product identification

4.1 Incoming acceptance

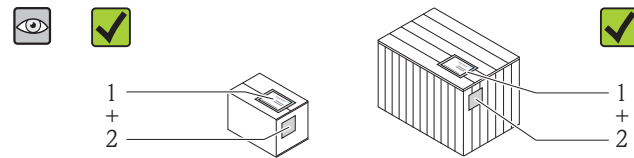

Are the order codes on the delivery note (1) and the product sticker (2) identical?

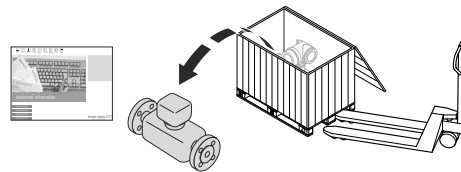



Are the goods undamaged?

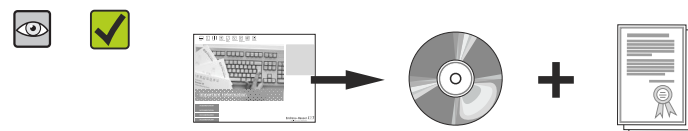

Do the nameplate data match the ordering information on the delivery note?



Is the CD-ROM with the Technical Documentation (depends on device version) and documents present?



-  If one of the conditions is not satisfied, contact your Endress+Hauser Sales Center.
- Depending on the device version, the CD-ROM might not be part of the delivery! In such cases, the technical documentation is available via the Internet or via the *Endress+Hauser Operations App*, see the "Product identification" section (→  14).

4.2 Product identification

The following options are available for identification of the measuring device:

- Nameplate specifications
- Order code with breakdown of the device features on the delivery note
- Enter serial numbers from nameplates in *W@M Device Viewer* (www.endress.com/deviceviewer): All information about the measuring device is displayed.
- Enter the serial number from the nameplates into the *Endress+Hauser Operations App* or scan the 2-D matrix code (QR code) on the nameplate with the *Endress+Hauser Operations App*: all the information for the measuring device is displayed.

For an overview of the scope of the associated Technical Documentation, refer to the following:

- The chapters "Additional standard documentation on the device" (→ ) 8) and "Supplementary device-dependent documentation" (→ )
- The *W@M Device Viewer*: Enter the serial number from the nameplate (www.endress.com/deviceviewer)
- The *Endress+Hauser Operations App*: Enter the serial number from the nameplate or scan the 2-D matrix code (QR code) on the nameplate.

4.2.1 Transmitter nameplate

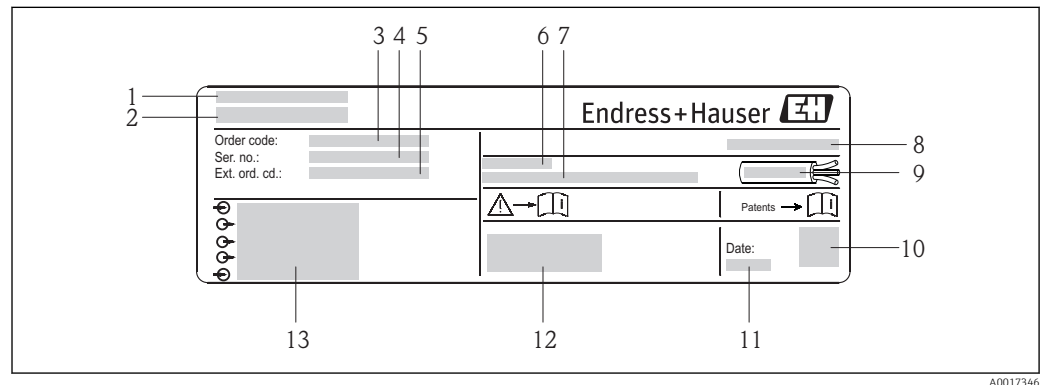

 2 Example of a transmitter nameplate

- 1 Manufacturing location
- 2 Name of the transmitter
- 3 Order code
- 4 Serial number
- 5 Extended order code
- 6 Permitted ambient temperature range (T_a)
- 7 Firmware version (FW) and device revision (Dev.Rev.) from the factory
- 8 Degree of protection
- 9 Permitted temperature range for cable
- 10 2-D matrix code
- 11 Manufacturing date: year-month
- 12 CE mark, C-Tick
- 13 Electrical connection data, e.g. available inputs and outputs, supply voltage

4.2.2 Sensor nameplate

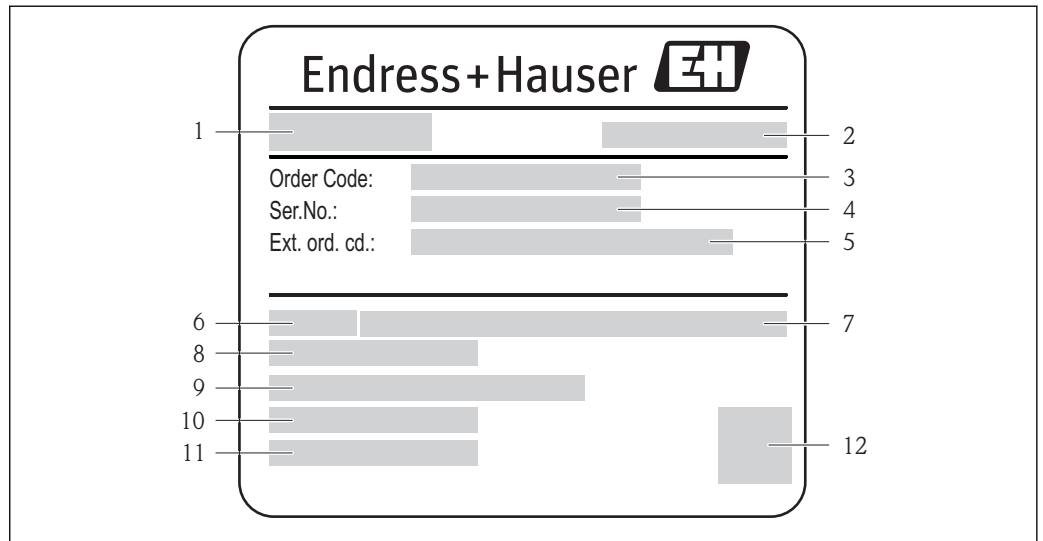

A0017224

3 Example of sensor nameplate

- 1 Name of the sensor
- 2 Manufacturing location
- 3 Order code
- 4 Serial number (Ser. no.)
- 5 Extended order code (Ext. ord. cd.)
- 6 Nominal diameter of sensor
- 7 Nominal pressure
- 8 Medium temperature range
- 9 Material of lining and electrodes
- 10 Permitted ambient temperature range
- 11 Degree of protection
- 12 2-D matrix code

Order code

The measuring device is reordered using the order code.

Extended order code

- The device type (product root) and basic specifications (mandatory features) are always listed.
- Of the optional specifications (optional features), only the safety and approval-related specifications are listed (e.g. LA). If other optional specifications are also ordered, these are indicated collectively using the # placeholder symbol (e.g. #LA#).
- If the ordered optional specifications do not include any safety and approval-related specifications, they are indicated by the + placeholder symbol (e.g. XXXXXX-ABCDE+).

4.2.3 Symbols on measuring device

Symbol	Meaning
⚠	WARNING! This symbol alerts you to a dangerous situation. Failure to avoid this situation can result in serious or fatal injury.
 <small>A0011194</small>	Reference to documentation Refers to the corresponding device documentation.
 <small>A0011199</small>	Protective ground connection A terminal which must be connected to ground prior to establishing any other connections.

5 Storage and transport

5.1 Storage conditions

Observe the following notes for storage:

- Store in the original packaging to ensure protection from shock.
- Do not remove protective covers or protective caps installed on process connections. They prevent mechanical damage to the sealing surfaces and contamination in the measuring tube.
- Protect from direct sunlight to avoid unacceptably high surface temperatures.
- Select a storage location where moisture cannot collect in the measuring device as fungus and bacteria infestation can damage the lining.
- Store in a dry and dust-free place.
- Do not store outdoors.
- Storage temperature(→ 📄 116)

5.2 Transporting the product

⚠ WARNING

Center of gravity of the measuring device is higher than the suspension points of the webbing slings.

Risk of injury if the measuring device slips.

- ▶ Secure the measuring device from rotating or slipping.
- ▶ Observe the weight specified on the packaging (stick-on label).
- ▶ Observe the transport instructions on the stick-on label on the electronics compartment cover.

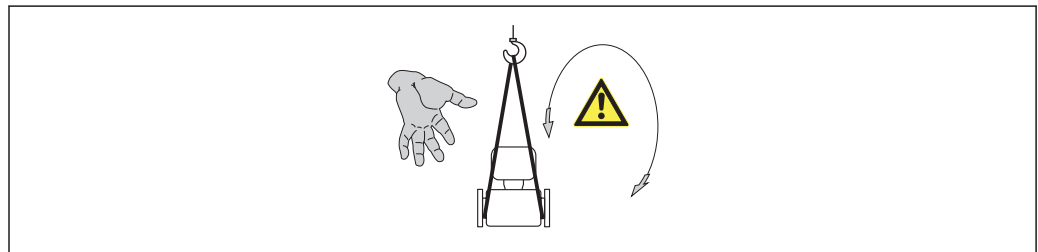

A0015606

- i** ▪ Transport the measuring device to the measuring point in the original packaging.
- Lifting gear
 - Webbing slings: Do not use chains, as they could damage the housing.
 - For wood crates, the floor structure enables these to be loaded lengthwise or broadside using a forklift.
- Use the webbing slings to lift the measuring device at the process connections; do not lift by the transmitter housing or by the connection housing of the remote version.
- Do not remove protective covers or protective caps installed on process connections. They prevent mechanical damage to the sealing surfaces and contamination in the measuring tube.

5.3 Packaging disposal

All packaging materials are environmentally friendly and 100% recyclable:

- Measuring device secondary packaging: polymer stretch film that conforms to EC Directive 2002/95/EC (RoHS).
- Packaging:
 - Wood crate, treated in accordance with ISPM 15 standard, which is confirmed by the affixed IPPC logo.
 - or
 - Carton in accordance with European Packaging Directive 94/62EC; recyclability is confirmed by the affixed RESY symbol.
- Seaworthy packaging (optional): Wood crate, treated in accordance with ISPM 15 standard, which is confirmed by the affixed IPPC logo.
- Carrying and mounting hardware:
 - Disposable plastic pallet
 - Plastic straps
 - Plastic adhesive strips
- Dunnage: Paper cushion

6 Mounting

6.1 Installation conditions

6.1.1 Mounting position

Mounting location

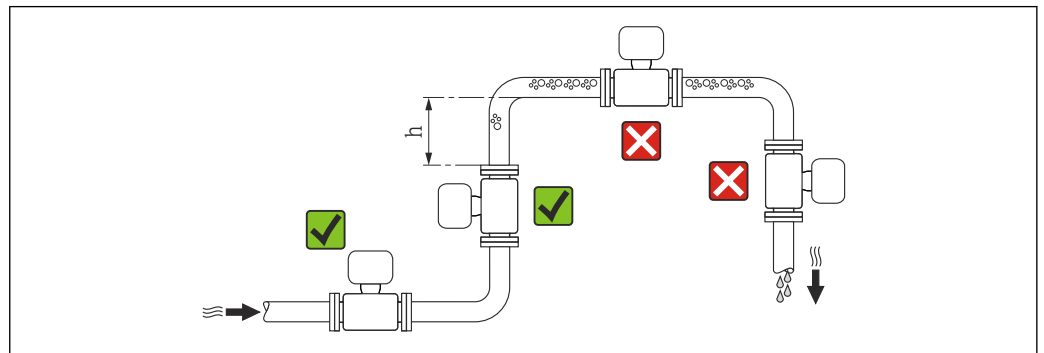

A0023343

Preferably install the sensor in an ascending pipe, and ensure a sufficient distance to the next pipe elbow: $h \geq 2 \times DN$

To prevent measuring errors arising from accumulation of gas bubbles in the measuring tube, avoid the following mounting locations in the pipe:

- Highest point of a pipeline.
- Directly upstream of a free pipe outlet in a down pipe.

Installation in down pipes

Install a siphon with a vent valve downstream of the sensor in down pipes whose length $h \geq 5 \text{ m}$ (16.4 ft). This precaution is to avoid low pressure and the consequent risk of damage to the measuring tube. This measure also prevents the system losing prime.

 For information on the liner's resistance to partial vacuum (\rightarrow  117)

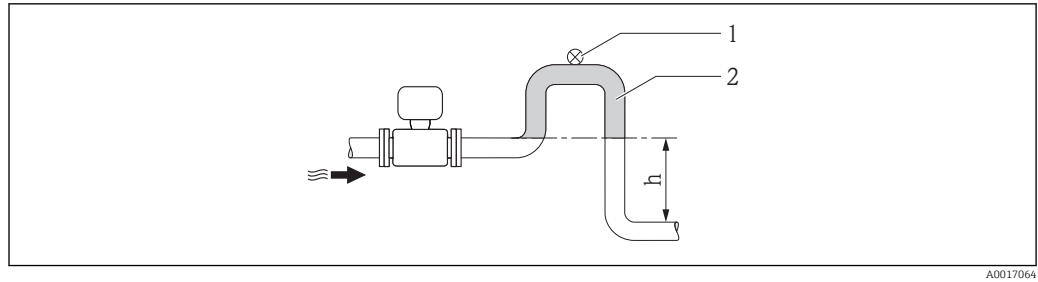

4 Installation in a down pipe

- 1 Vent valve
- 2 Pipe siphon
- h Length of down pipe

Installation in partially filled pipes

A partially filled pipe with a gradient necessitates a drain-type configuration. The empty pipe detection (EPD) function offers additional protection by detecting empty or partially filled pipes.

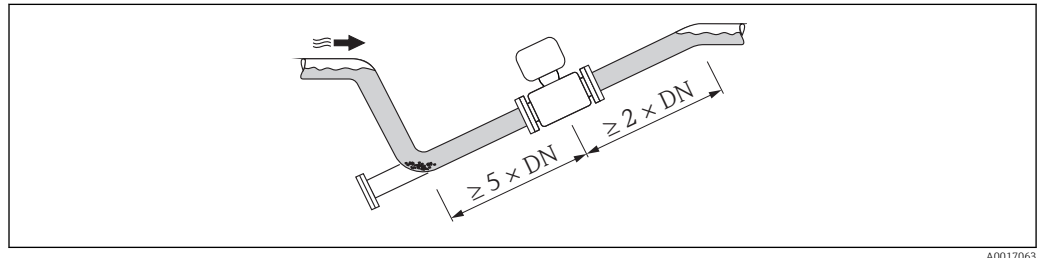

Orientation

The direction of the arrow on the sensor nameplate helps you to install the sensor according to the flow direction (direction of medium flow through the piping).

An optimum orientation position helps avoid gas and air accumulations and deposits in the measuring tube.

Vertical

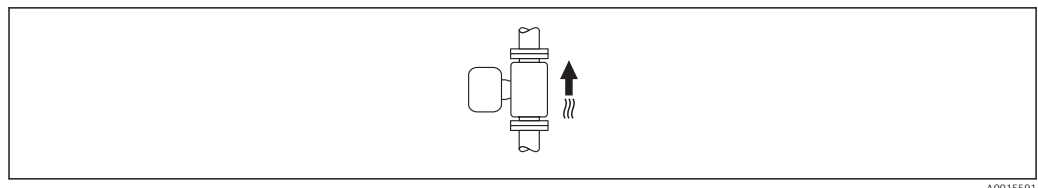

This is the optimum for self-emptying piping systems.

Horizontal

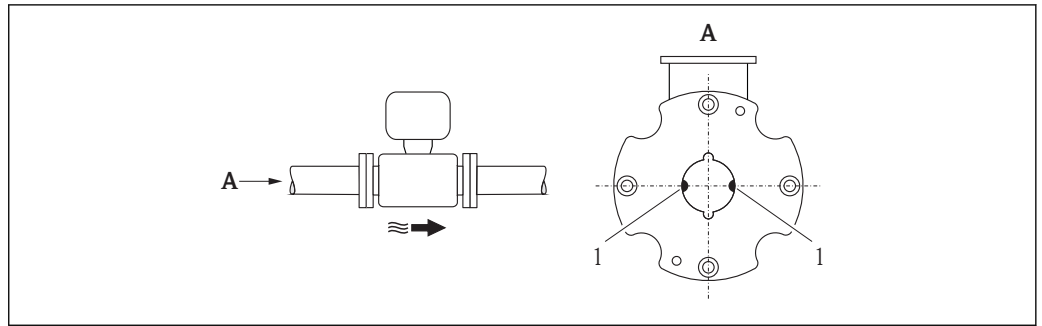

1 Measuring electrodes for signal detection

i The measuring electrode plane must be horizontal. This prevents brief insulation of the two measuring electrodes by entrained air bubbles.

Inlet and outlet runs

If possible, install the sensor upstream from fittings such as valves, T-pieces or elbows. Observe the following inlet and outlet runs to comply with accuracy specifications:

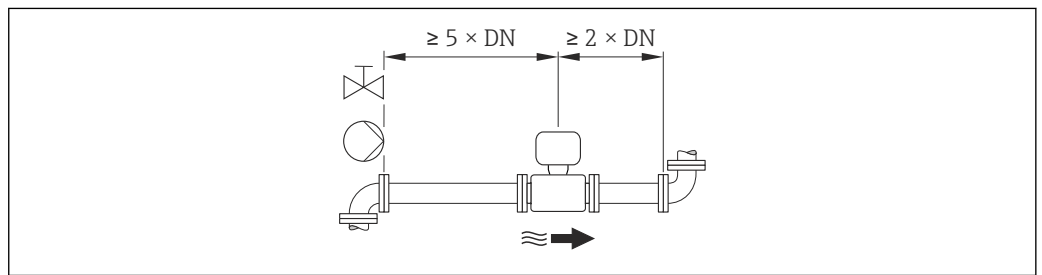

Installation dimensions

i For the dimensions and installation lengths of the device, see the "Technical Information" document, "Mechanical construction" section

6.1.2 Requirements from environment and process

Ambient temperature range

Transmitter	-40 to +60 °C (-40 to +140 °F)
Local display	-20 to +60 °C (-4 to +140 °F), the readability of the display may be impaired at temperatures outside the temperature range.
Sensor	-20 to +60 °C (-4 to +140 °F)
Liner	Do not exceed or fall below the permitted temperature range of the liner (→ 117).

If operating outdoors:

- Install the measuring device in a shady location.
- Avoid direct sunlight, particularly in warm climatic regions.
- Avoid direct exposure to weather conditions.
- Protect the display against impact.
- Protect the display from abrasion by sand in desert areas.

i A display protector can be ordered from Endress+Hauser: "Accessories" section
(→  108)

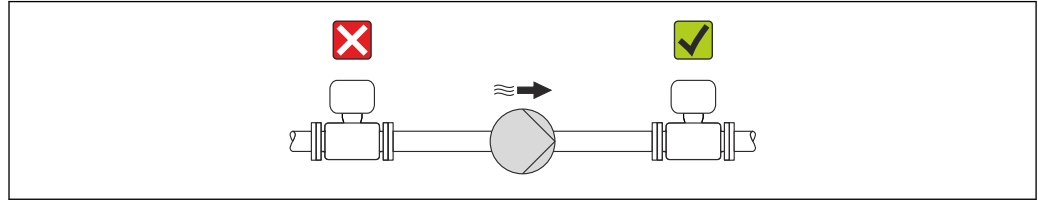

System pressure



A0015594

Never install the sensor on the pump suction side in order to avoid the risk of low pressure, and thus damage to the liner.

i Furthermore, install pulse dampers if reciprocating, diaphragm or peristaltic pumps are used.

- i**
 - For information on the liner's resistance to partial vacuum (→  117)
 - Information on the shock resistance of the measuring system (→  117)
 - Information on the vibration resistance of the measuring system (→  117)

Vibrations

In the event of very strong vibrations, the pipe and sensor must be supported and fixed.

It is also advisable to mount the sensor and transmitter separately.

i Information on the shock resistance of the measuring system (→  117)

Information on the vibration resistance of the measuring system (→  117)

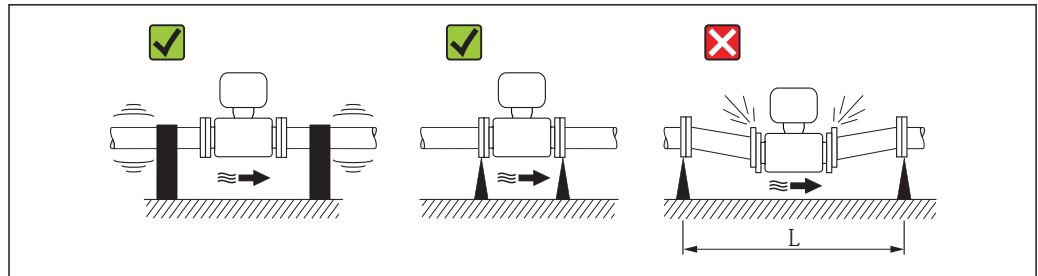

A0016266

 5 Measures to avoid device vibrations ($L > 10\text{ m (33 ft)}$)

Adapters

Suitable adapters to DIN EN 545 (double-flange reducers) can be used to install the sensor in larger-diameter pipes. The resultant increase in the rate of flow improves measuring accuracy with very slow-moving fluids. The nomogram shown here can be used to calculate the pressure loss caused by reducers and expanders.

i The nomogram only applies to liquids with a viscosity similar to that of water.

1. Calculate the ratio of the diameters d/D .
2. From the nomogram read off the pressure loss as a function of flow velocity (downstream from the reduction) and the d/D ratio.

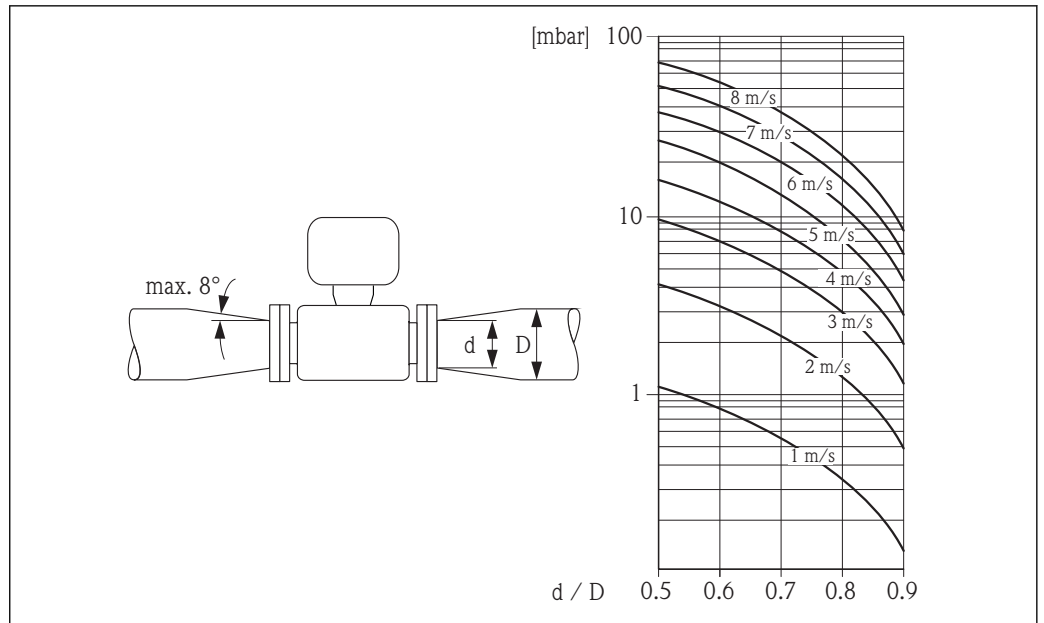

A0016359

6.1.3 Special mounting instructions

Display protection

- ▶ To ensure that the optional display protection can be easily opened, maintain the following minimum head clearance: 350 mm (13.8 in)

6.2 Mounting the measuring device

6.2.1 Required tools

For transmitter

- Torque wrench
- For wall mounting:
 - Open-ended wrench for hexagonal screw max. M5
- For pipe mounting:
 - Open-ended wrench AF 8
 - Phillips head screwdriver PH 2
- For turning the transmitter housing (compact version):
 - Phillips head screwdriver PH 2
 - Torx screwdriver TX 20
 - Open-ended wrench AF 7

For sensor

For flanges and other process connections:

- Screws, nuts, seals etc. are not included in the scope of supply and must be provided by the customer.
- Appropriate mounting tools

6.2.2 Preparing the measuring device

1. Remove all remaining transport packaging.
2. Remove any protective covers or protective caps present from the sensor.

3. Remove stick-on label on the electronics compartment cover.

6.2.3 Mounting the sensor

Mounting kit

The sensor is installed between the pipe flanges using a mounting kit. The device is centered using the recesses on the sensor. Centering sleeves are also provided depending on the flange standard or the diameter of the pitch circle.

i A mounting kit – consisting of mounting bolts, seals, nuts and washers – can be ordered separately (see "Accessories" section (→ 108)).

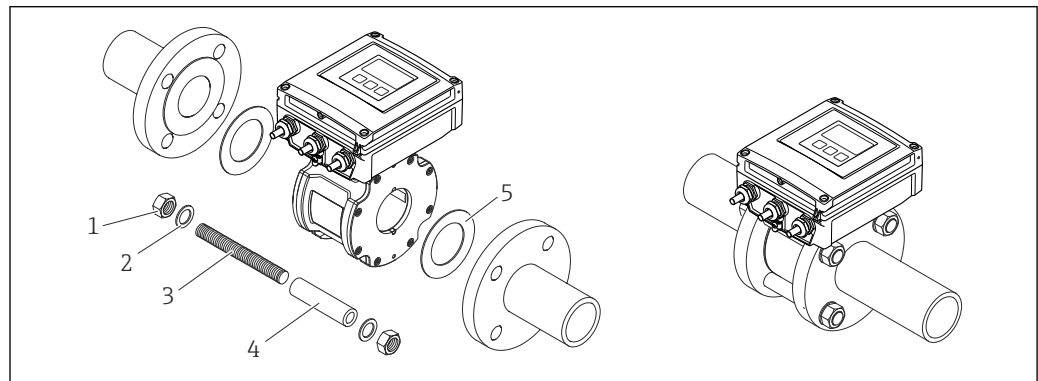

A0018060

6 *Mounting the sensor*

- 1 Nut
- 2 Washer
- 3 Mounting bolts
- 4 Centering sleeve
- 5 Seal

Arranging the mounting bolts and centering sleeves

The device is centered using recesses on the sensor. The arrangement of the mounting bolts and the use of the centering sleeves supplied depend on the nominal diameter, the flange standard and the diameter of the pitch circle.

Nominal diameter		Process connection		
[mm]	[in]5	EN 1092-1 (DIN 2501)	ASME B16.5	JIS B2220
25...40	1...1 ½	<p>A0010896</p>	<p>A0010824</p>	<p>A0010896</p>
50	2	<p>A0010897</p>	<p>A0010825</p>	<p>A0010825</p>

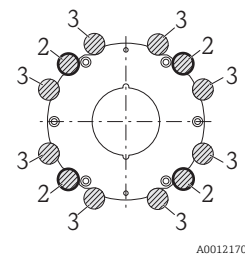
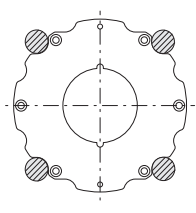
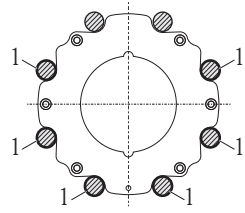
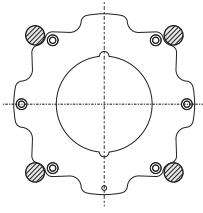
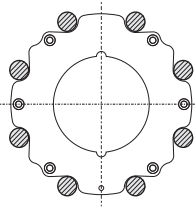
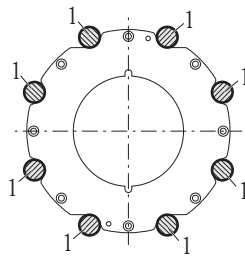
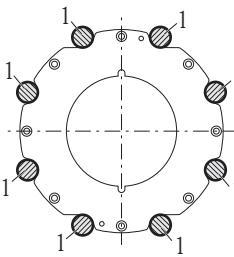
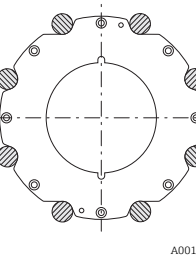
Nominal diameter		Process connection		
[mm]	[in]5	EN 1092-1 (DIN 2501)	ASME B16.5	JIS B2220
65	2 ½	 A0012170	—	 A0012171
80	3	 A0010898	 A0010827	 A0010826
100	4	 A0012168	 A0012168	 A0012169
1 = Mounting bolts with centering sleeves 2 = EN (DIN) flange: 4-hole → with centering sleeves 3 = EN (DIN) flange: 8-hole → without centering sleeves				

Mounting the seals



An electrically conductive layer could form on the inside of the measuring tube!
 Risk of measuring signal short circuit.

- ▶ Do not use electrically conductive sealing compounds such as graphite.

Comply with the following instructions when installing seals:

- Make sure that the seals do not protrude into the piping cross-section.
- For DIN flanges: only use seals according to DIN EN 1514-1.
- Use seals with a hardness rating of 70° Shore.

Mounting the ground cable/ground disks

Comply with the information on potential equalization and detailed mounting instructions for the use of ground cables/ground disks (→ 38).

Screw tightening torques

Please note the following:

- The screw tightening torques listed below apply only to lubricated threads and to pipes not subjected to tensile stress.
- Tighten the screws uniformly and in diagonally opposite sequence.
- Overtightening the screws will deform the sealing faces or damage the seals.

The tightening torques apply to situations where an EPDM soft material flat seal (e.g. 70° Shore) is used.

Screw tightening torques, mounting bolts and centering sleeves for EN 1092-1 (DIN 2501), PN 16

Nominal diameter [mm]	Mounting bolts [mm]	Length Centering sleeve [mm]	Max. screw tightening torque [Nm] for a process flange with ...	
			smooth seal face	Raised face
25	4 × M12 × 145	54	19	19
40	4 × M16 × 170	68	33	33
50	4 × M16 × 185	82	41	41
65 ¹⁾	4 × M16 × 200	92	44	44
65 ²⁾	8 × M16 × 200	– ³⁾	29	29
80	8 × M16 × 225	116	36	36
100	8 × M16 × 260	147	40	40

- 1) EN (DIN) flange: 4-hole → with centering sleeves
- 2) EN (DIN) flange: 8-hole → without centering sleeves
- 3) A centering sleeve is not required. The device is centered directly via the sensor housing.

Screw tightening torques, mounting bolts and centering sleeves for ASME B16.5, Class 150

Nominal diameter		Mounting bolts [in]	Length Centering sleeve [in]	Max. screw tightening torque [Nm] ([lbf · ft]) for a process flange with ...	
[mm]	[in]			smooth seal face	Raised face
25	1	4 × UNC ½" × 5.70	– ¹⁾	19 (14)	10 (7)
40	1 ½	4 × UNC ½" × 6.50	– ¹⁾	29 (21)	19 (14)
50	2	4 × UNC 5/8" × 7.50	– ¹⁾	41 (30)	37 (27)
80	3	4 × UNC 5/8" × 9.25	– ¹⁾	43 (31)	43 (31)
100	4	8 × UNC 5/8" × 10.4	5.79	38 (28)	38 (28)

- 1) A centering sleeve is not required. The device is centered directly via the sensor housing.

Screw tightening torques, mounting bolts and centering sleeves for JIS B2220, 10K

Nominal diameter [mm]	Mounting bolts [mm]	Length Centering sleeve [mm]	Max. screw tightening torque [Nm] for a process flange with ...	
			smooth seal face	Raised face
25	4 × M16 × 170	54	24	24
40	4 × M16 × 170	68	32	25
50	4 × M16 × 185	– ¹⁾	38	30
65	4 × M16 × 200	– ¹⁾	42	42
80	8 × M16 × 225	– ¹⁾	36	28
100	8 × M16 × 260	– ¹⁾	39	37

- 1) A centering sleeve is not required. The device is centered directly via the sensor housing.

6.2.4 Mounting the transmitter of the remote version

⚠ CAUTION

Ambient temperature too high!

Danger of electronics overheating and housing deformation.

- ▶ Do not exceed the permitted maximum ambient temperature (→ 19).
- ▶ If operating outdoors: Avoid direct sunlight and exposure to weathering, particularly in warm climatic regions.

⚠ CAUTION

Excessive force can damage the housing!

- ▶ Avoid excessive mechanical stress.

The transmitter of the remote version can be mounted in the following ways:

- Wall mounting
- Pipe mounting

Wall mounting

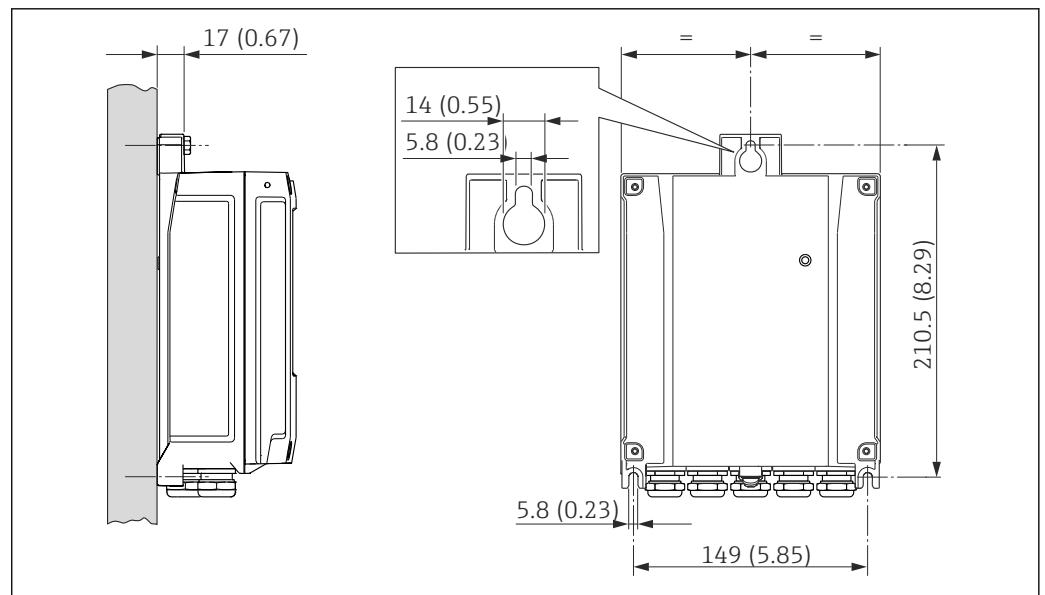

7 Engineering unit mm (in)

1. Drill the holes.
2. Insert wall plugs into the drilled holes.
3. Screw in the securing screws slightly at first.
4. Fit the transmitter housing over the securing screws and mount in place.
5. Tighten the securing screws.

Post mounting

⚠ WARNING

Excessive tightening torque applied to the fixing screws on plastic housing!

Risk of damaging the plastic transmitter.

- ▶ Tighten the fixing screws as per the tightening torque: 2 Nm (1.5 lbf ft)

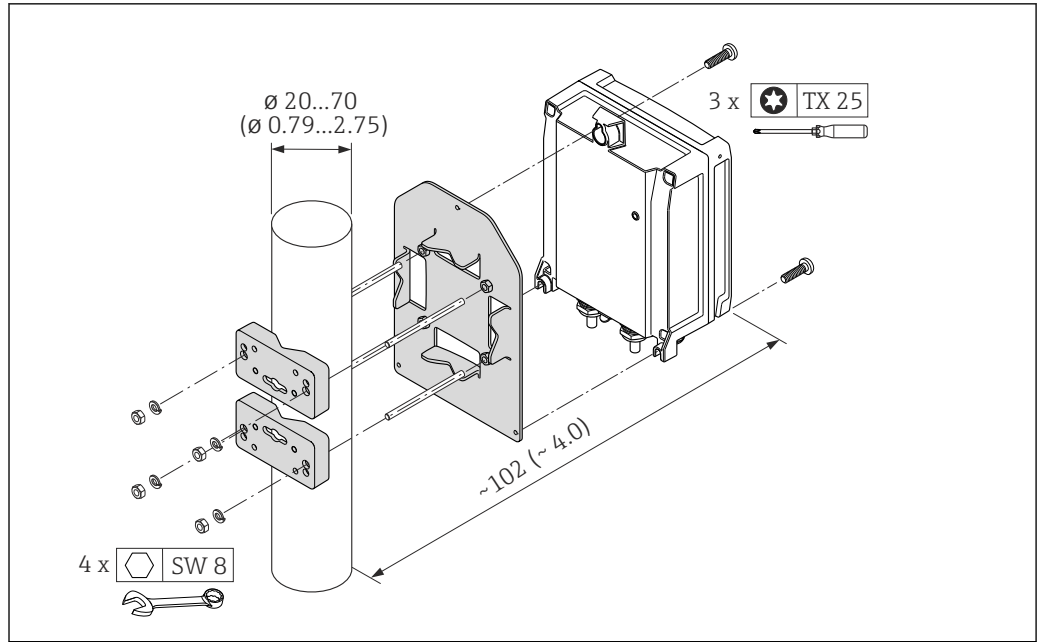

A0020705

8 Engineering unit mm (in)

6.2.5 Turning the transmitter housing

To provide easier access to the connection compartment or display module, the transmitter housing can be turned.

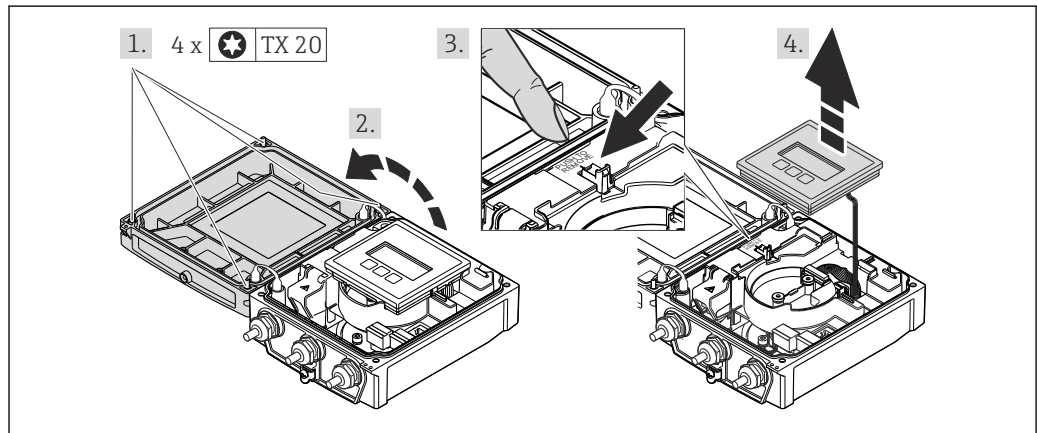

A0021602

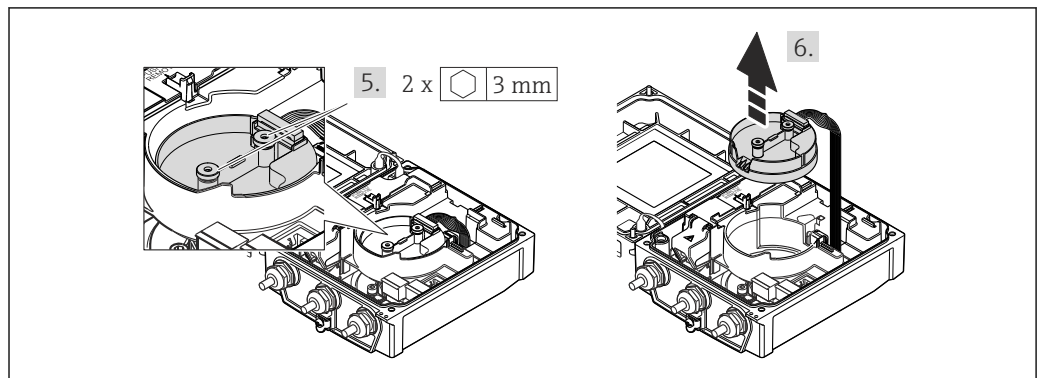

A0021603

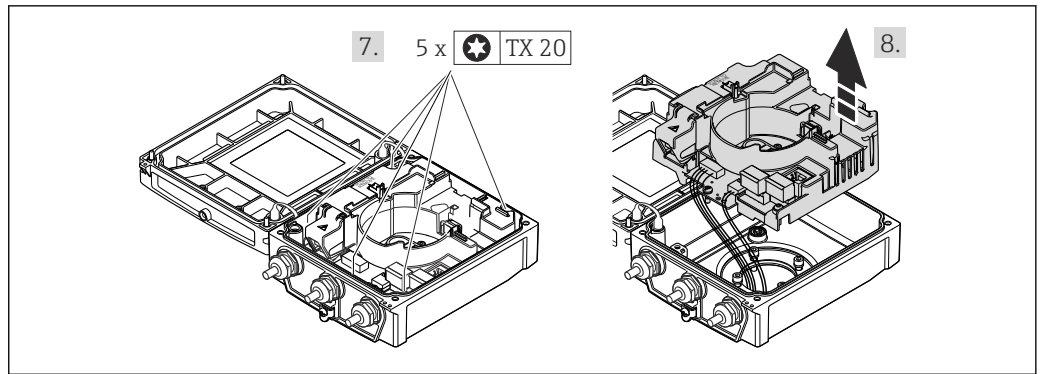

A0021830

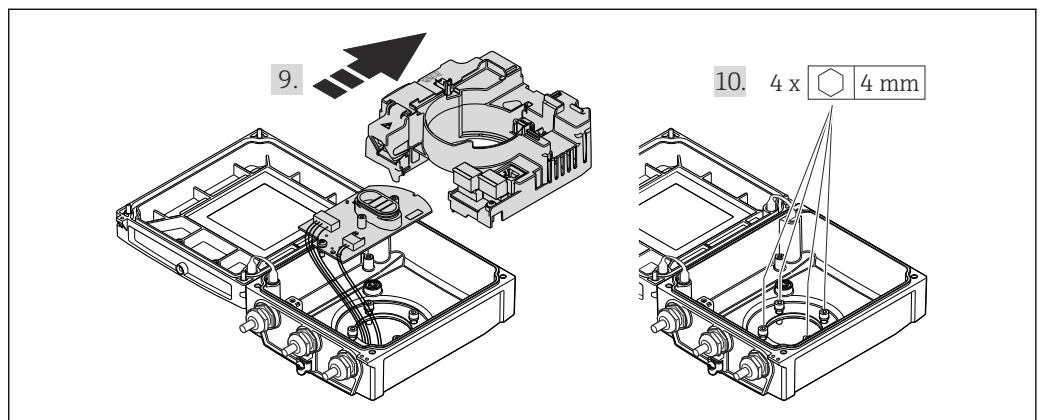

A0021831

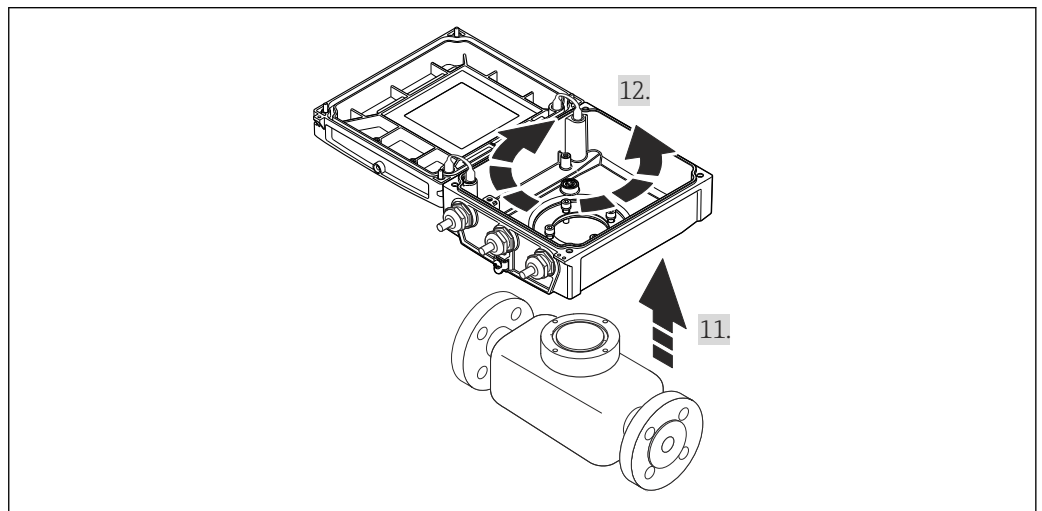

A0021832

1. Loosen the fixing screws of the housing cover (when reassembling, pay attention to the tightening torque (→ 28)).
2. Open the housing cover.
3. Unlock the display module.
4. Remove the display module.
5. Loosen the fixing screws of the smart sensor electronics module (when reassembling, pay attention to the tightening torque (→ 28)).
6. Remove the smart sensor electronics module (when reassembling, pay attention to the coding of the plug (→ 0)).
7. Loosen the fixing screws of the main electronics module (when reassembling, pay attention to the tightening torque (→ 28)).
8. Remove the main electronics module.

9. Remove the electronics module from the main electronics module.
10. Loosen the fixing screws of the transmitter housing (when reassembling, pay attention to the tightening torque (→ 28)).
11. Lift the transmitter housing.
12. Turn the housing to the desired position in increments of 90°.

Reassembling the transmitter housing

⚠ WARNING

Excessive tightening torque applied to the fixing screws!

Damage to the transmitter.

- ▶ When reassembling, tighten the fixing screws as per the tightening torque:

Step	Fixing screw	Tightening torques for housing made of:	
		Aluminum	Plastic
1	Housing cover	2.5 Nm (1.8 lbf ft)	1 Nm (0.7 lbf ft)
5	Smart sensor electronics module	0.6 Nm (0.4 lbf ft)	
7	Main electronics module	1.5 Nm (1.1 lbf ft)	
10	Transmitter housing	5.5 Nm (4.1 lbf ft)	

NOTICE

Plug of the smart sensor electronics module connected incorrectly!

No measuring signal is output.

- ▶ Plug in the plug of the smart sensor electronics module as per the coding.

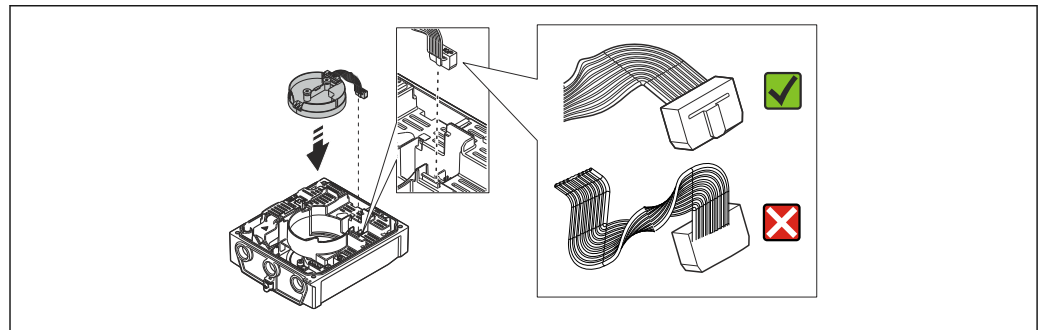

A0021585

NOTICE

Incorrect routing of the connecting cables between the sensor and transmitter in the transmitter housing!

This can interfere with the measuring signal.

- ▶ Route the connecting cables directly at the level of the plugs.
- ▶ Reverse the procedure to reassemble the measuring device.

6.2.6 Turning the display module

The display module can be turned to optimize display readability and operability.

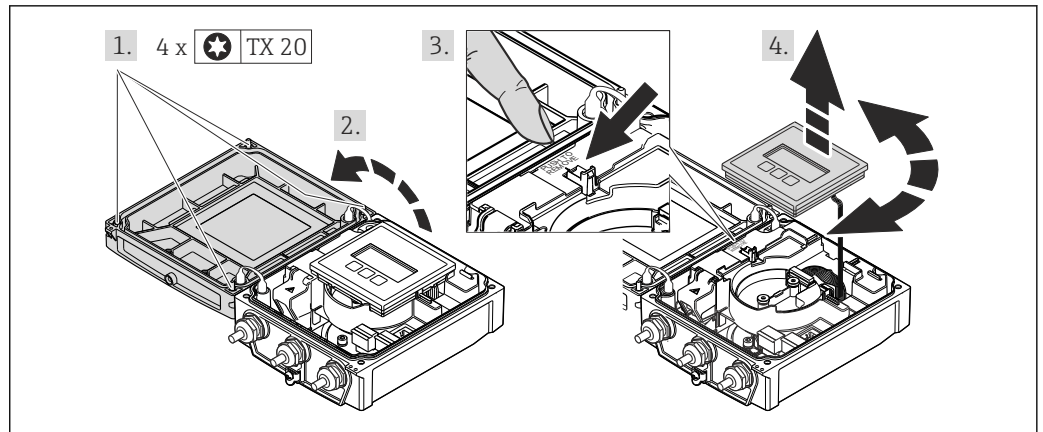

A0021617

1. Loosen the fixing screws of the housing cover (when reassembling, pay attention to the tightening torque (→ 29)).
2. Open the housing cover.
3. Unlock the display module.
4. Pull out the display module and turn it to the desired position in increments of 90°.

Reassembling the transmitter housing

⚠ WARNING

Excessive tightening torque applied to the fixing screws!

Damage to the transmitter.

► When reassembling, tighten the fixing screws as per the tightening torque:

Step	Fixing screw	Tightening torque for housing made of:	
		Aluminum	Plastic
1	Housing cover	2.5 Nm (1.8 lbf ft)	1 Nm (0.7 lbf ft)

► Reverse the procedure to reassemble the measuring device.

6.3 Post-installation check

Is the device undamaged (visual inspection)?	<input type="checkbox"/>
Does the measuring device conform to the measuring point specifications? For example: <ul style="list-style-type: none"> ▪ Process temperature ▪ Process pressure (refer to the section on "Pressure-temperature ratings" in the "Technical Information" document) ▪ Ambient temperature ▪ Measuring range 	<input type="checkbox"/>
Has the correct orientation for the sensor been selected ? <ul style="list-style-type: none"> ▪ According to sensor type ▪ According to medium temperature ▪ According to medium properties (outgassing, with entrained solids) 	<input type="checkbox"/>
Does the arrow on the sensor nameplate match the direction of flow of the fluid through the piping ?	<input type="checkbox"/>
Are the measuring point identification and labeling correct (visual inspection)?	<input type="checkbox"/>
Is the device adequately protected from precipitation and direct sunlight?	<input type="checkbox"/>
Have the fixing screws been tightened with the correct tightening torque?	<input type="checkbox"/>

7 Electrical connection

 The measuring device does not have an internal circuit breaker. For this reason, assign the measuring device a switch or power-circuit breaker so that the power supply line can be easily disconnected from the mains.

7.1 Connection conditions

7.1.1 Required tools

- Torque wrench
- For cable entries: Use corresponding tools
- For housing cover: Torx screwdriver or flat-blade screwdriver
- Wire stripper
- When using stranded cables: crimping tool for ferrule

7.1.2 Requirements for connecting cable

The connecting cables provided by the customer must fulfill the following requirements.

Electrical safety

In accordance with applicable federal/national regulations.

Permitted temperature range

- -40 °C (-40 °F) to $+80\text{ °C}$ ($+176\text{ °F}$)
- Minimum requirement: cable temperature range \geq ambient temperature $+20\text{ K}$

Power supply cable

Standard installation cable is sufficient.

Signal cable

EtherNet/IP

The standard ANSI/TIA/EIA-568-B.2 Annex specifies CAT 5 as the minimum category for a cable used for EtherNet/IP. CAT 5e and CAT 6 are recommended.

 For more information on planning and installing EtherNet/IP networks, please refer to the "Media Planning and Installation Manual. EtherNet/IP" of the ODVA Organization.

Connecting cable for remote version

Electrode cable

Standard cable	3 × 0.38 mm ² (20 AWG) with common, braided copper shield ($\phi \sim 7\text{ mm}$ (0.28")) and individually shielded cores
Conductor resistance	$\leq 50\ \Omega/\text{km}$ (0.015 Ω/ft)
Capacitance: core/shield	$\leq 420\ \text{pF/m}$ (128 pF/ft)
Operating temperature	$-20\text{ to }+80\text{ °C}$ ($-68\text{ to }+176\text{ °F}$)

Coil current cable

Standard cable	2 × 0.75 mm ² (18 AWG) with common, braided copper shield (ϕ ~ 7 mm (0.28")) and individually shielded cores
Conductor resistance	≤ 37 Ω/km (0.011 Ω/ft)
Capacitance: core/core, shield grounded	≤ 120 pF/m (37 pF/ft)
Operating temperature	-20 to +80 °C (-68 to +176 °F)
Test voltage for cable insulation	≤ AC 1433 V r.m.s. 50/60 Hz or ≥ DC 2026 V

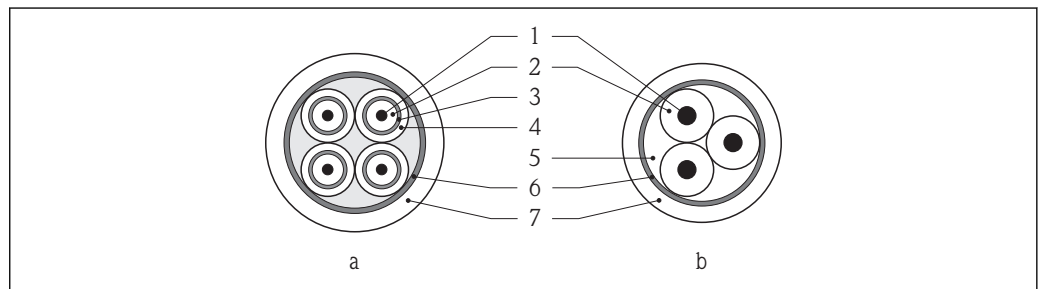

A0003194

9 Cable cross-section

- a* Electrode cable
b Coil current cable
 1 Core
 2 Core insulation
 3 Core shield
 4 Core jacket
 5 Core reinforcement
 6 Cable shield
 7 Outer jacket

Operation in zones of severe electrical interference

The measuring system meets the general safety requirements (→ 125) and EMC specifications (→ 117).

Grounding is by means of the ground terminal provided for the purpose inside the connection housing. The stripped and twisted lengths of cable shield to the ground terminal must be as short as possible.

Cable diameter

- Cable glands supplied:
 - For standard cable: M20 × 1.5 with cable ϕ6 to 12 mm (0.24 to 0.47 in)
 - For reinforced cable: M20 × 1.5 with cable ϕ9.5 to 16 mm (0.37 to 0.63 in)
- (Plug-in) spring terminals for wire cross-sections 0.5 to 2.5 mm² (20 to 14 AWG)

7.1.3 Terminal assignment

Transmitter

EtherNet/IP connection version

The sensor can be ordered with terminals or a device plug.

Connection methods available		Possible options for order code "Electrical connection"
Outputs	Power supply	
Terminals	Terminals	<ul style="list-style-type: none"> ▪ Option A: coupling M20x1 ▪ Option B: thread M20x1 ▪ Option C: thread G ½" ▪ Option D: thread NPT ½"
Device plug	Terminals	<ul style="list-style-type: none"> ▪ Option L: plug M12x1 + thread NPT ½" ▪ Option N: plug M12x1 + coupling M20 ▪ Option P: plug M12x1 + thread G ½" ▪ Option U: plug M12x1 + thread M20

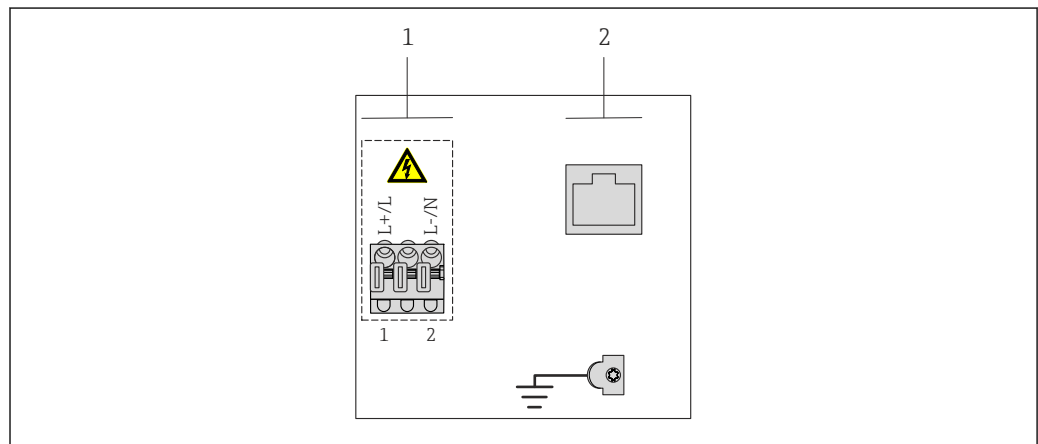

A0020428

- 1 Supply voltage (wide range power unit)
- 2 EtherNet/IP

Supply voltage

Order code for "Power supply"	Terminal numbers	
	1 (L+/L)	2 (L-/N)
Option L (wide range power unit)	AC100 to 240 V	
	AC/DC24 V	

EtherNet/IP signal transmission

Order code for "Output"	Connection via
Option N	EtherNet/IP connector

Remote version

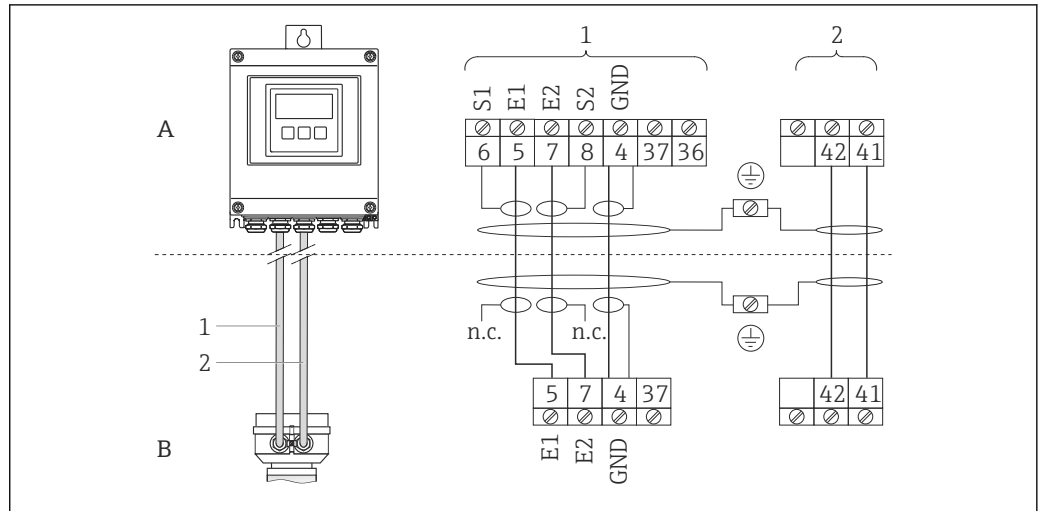

10 Remote version terminal assignment

- A Transmitter wall-mount housing
- B Sensor connection housing
- 1 Electrode cable
- 2 Coil current cable
- n.c. Not connected, insulated cable shields

Terminal No. and cable colors: 6/5 = brown; 7/8 = white; 4 = green

7.1.4 Pin assignment, device plug

- i** Order codes for the M12x1 connectors, see the "Order code for electrical connection" column:
EtherNet/IP (→ 32)

EtherNet/IP

Device plug for signal transmission (device side)

Pin	Assignment		Coding	Plug/socket
	+	-		
1	+	Tx	D	Socket
2	+	Rx		
3	-	Tx		
4	-	Rx		

7.1.5 Preparing the measuring device

1. Remove dummy plug if present.
2. If measuring device is delivered with cable glands:
Observe cable specification (→ 30).

7.1.6 Preparing the connecting cable for the remote version

When terminating the connecting cable, pay attention to the following points:

- In the case of electrode cables, make sure that the ferrules do not touch the core shields on the sensor side. Minimum distance = 1 mm (exception: green "GND" cable)
- In the case of coil current cables, insulate one core of the three-core wire at the level of the core reinforcement. You only require two cores for the connection.
- Fit the fine-wire cores with ferrules.

Transmitter

Electrode cable	Coil current cable
<p style="text-align: center;">A</p> <p style="text-align: center;">B</p> <p>■ 11 Engineering unit mm (in) A0021324</p>	<p style="text-align: center;">A</p> <p style="text-align: center;">B</p> <p>■ 12 Engineering unit mm (in) A0021325</p>
<p>A = Termination of the cables B = Termination of the fine-wire cores with ferrules 1 = Red ferrules, $\phi 1.0$ mm (0.04 in) 2 = White ferrules, $\phi 0.5$ mm (0.02 in) * = Stripping only for reinforced cables</p>	

Sensor

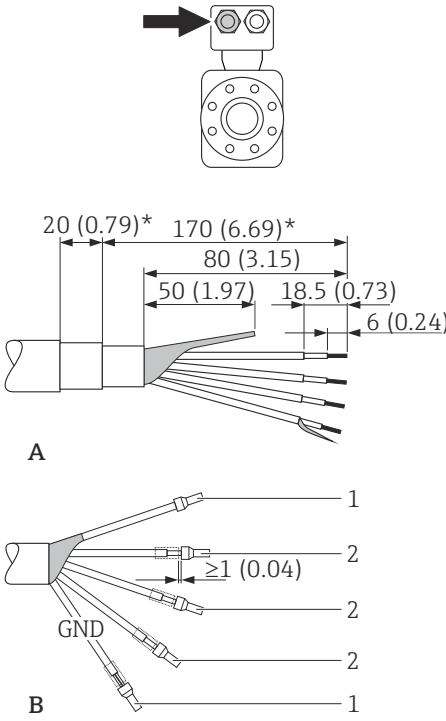
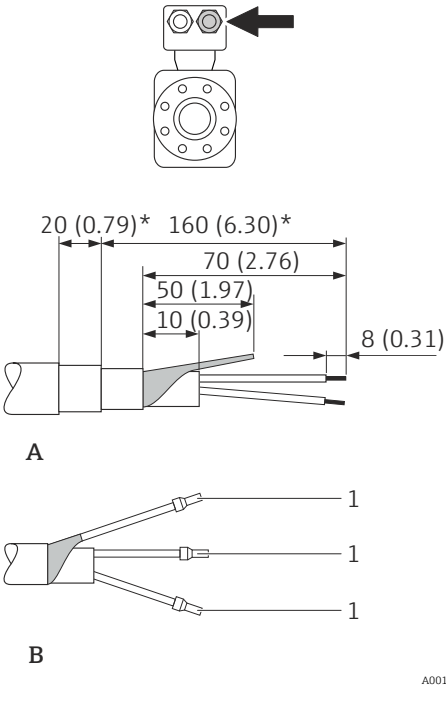
Electrode cable	Coil current cable
 <p> 20 (0.79)* 170 (6.69)* 80 (3.15) 50 (1.97) 18.5 (0.73) 6 (0.24) A 1 2 2 2 1 GND B ≥1 (0.04) A0016488 </p>	 <p> 20 (0.79)* 160 (6.30)* 70 (2.76) 50 (1.97) 10 (0.39) 8 (0.31) A 1 1 1 B A0016489 </p>
<p> A = Termination of the cables B = Termination of the fine-wire cores with ferrules 1 = Red ferrules, ϕ1.0 mm (0.04 in) 2 = White ferrules, ϕ0.5 mm (0.02 in) * = Stripping only for reinforced cables </p>	

7.2 Connecting the measuring device

⚠ WARNING

Risk of electric shock! Components carry dangerous voltages!

- ▶ Have electrical connection work carried out by correspondingly trained specialists only.
- ▶ Observe applicable federal/national installation codes and regulations.
- ▶ Comply with local workplace safety regulations.
- ▶ Observe grounding concept of the plant.
- ▶ Never mount or wire the measuring device while it is connected to the supply voltage.
- ▶ Before the supply voltage is applied, connect the protective ground to the measuring device.

Tightening torques for plastic housing

Housing cover fixing screw	1.3 Nm
Cable entry	4.5 to 5 Nm
Ground terminal	2.5 Nm

7.2.1 Connecting the transmitter

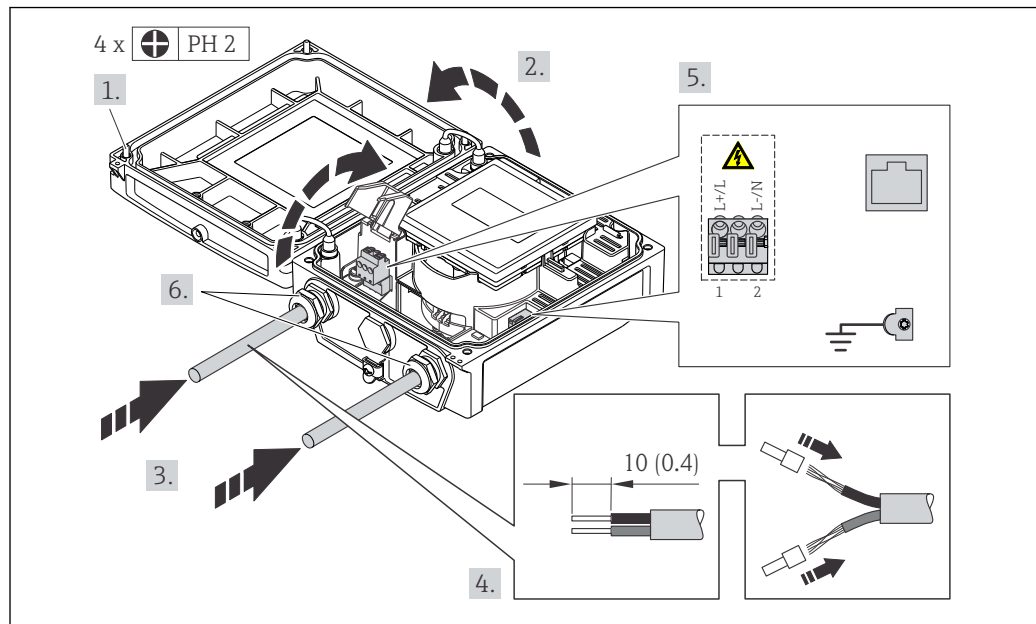

A0021356

13 Connecting the supply voltage and EtherNet/IP

1. Loosen the 4 fixing screws on the housing cover.
2. Open the housing cover.
3. Push the cable through the cable entry. To ensure tight sealing, do not remove the sealing ring from the cable entry.
4. Strip the cable and cable ends. In the case of stranded cables, also fit ferrules.
5. Connect the cable in accordance with the terminal assignment (→ 32). For supply voltage: open the shock protection cover.
6. Firmly tighten the cable glands.
7. **WARNING!** Housing degree of protection may be voided due to insufficient sealing of the housing. Screw in the screw without using any lubricant. Reverse the removal procedure to reassemble the transmitter.

7.2.2 Connecting the remote version

WARNING

Risk of damaging the electronic components!

- ▶ Ground the remote version and in doing so connect the sensor and transmitter to the same potential equalization.
- ▶ Only connect the sensor to a transmitter with the same serial number.
- ▶ Ground the connection housing of the sensor via the external screw terminal.

The following procedure (in the action sequence given) is recommended for the remote version:

1. Mount the transmitter and sensor.
2. Connect the connecting cable.
3. Connect the transmitter.

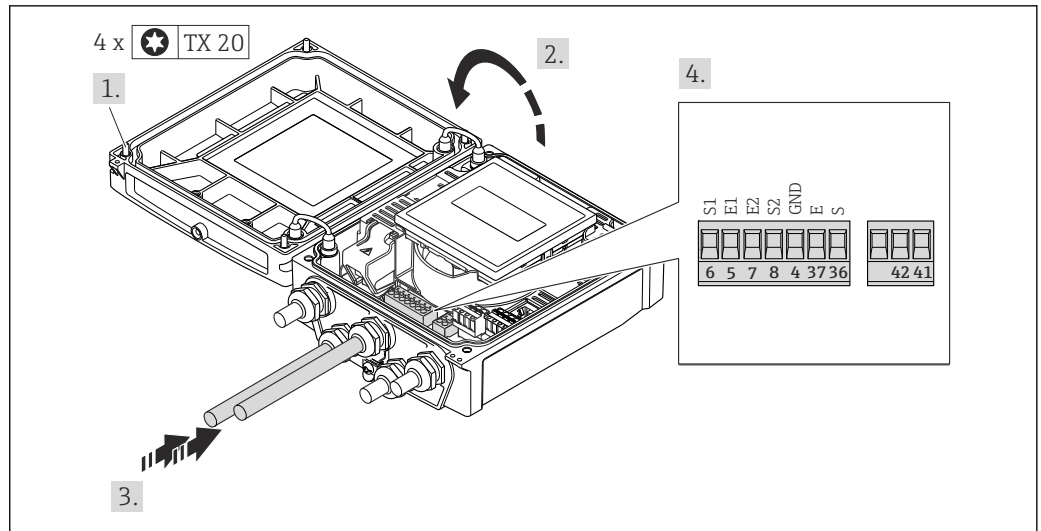

A0017445

14 Transmitter: main electronics module with terminals

1. Loosen the 4 fixing screws on the housing cover.
2. Open the housing cover.
3. Push the cable through the cable entry . To ensure tight sealing, do not remove the sealing ring from the cable entry.
4. Strip the cable and cable ends. In the case of stranded cables, also fit ferrules (→ 34).
5. Connect the cable in accordance with the terminal assignment (→ 33).
6. Firmly tighten the cable glands.
7. **WARNING!** Housing degree of protection may be voided due to insufficient sealing of the housing. Screw in the screw without using any lubricant. Reverse the removal procedure to reassemble the transmitter.

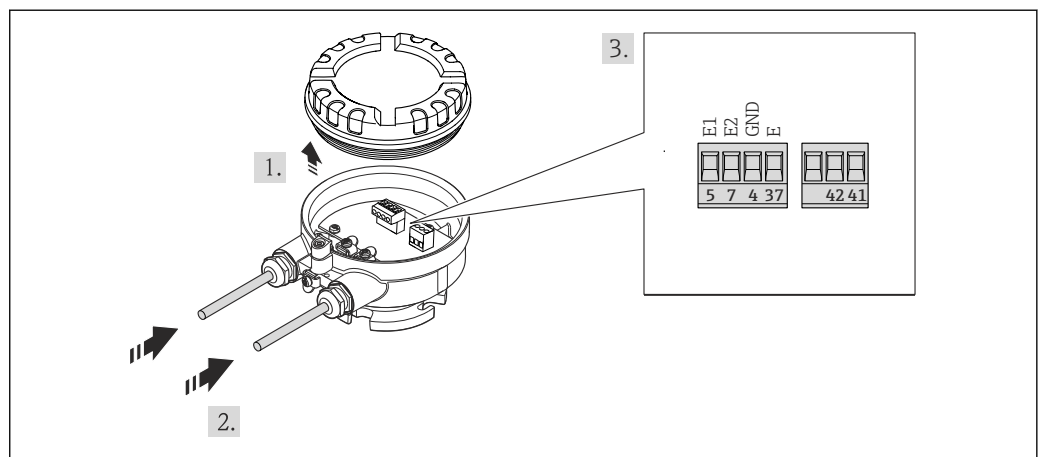

A0017446

15 Sensor: connection module

1. Loosen the securing clamp of the housing cover.
2. Unscrew and lift off the housing cover.
3. Push the cable through the cable entry . To ensure tight sealing, do not remove the sealing ring from the cable entry.
4. Strip the cable and cable ends. In the case of stranded cables, also fit ferrules (→ 34).
5. Connect the cable in accordance with the terminal assignment (→ 33).

6. Firmly tighten the cable glands.
7. **WARNING!** Housing degree of protection may be voided due to insufficient sealing of the housing. Screw in the screw without using any lubricant. The threads on the cover are coated with a dry lubricant.
Reverse the procedure to reassemble the sensor.

7.2.3 Ensuring potential equalization

⚠ CAUTION

Electrode damage can result in the complete failure of the device!

- ▶ Make sure that the fluid and sensor have the same electrical potential.
- ▶ Pay attention to internal grounding concepts in the company.
- ▶ Pay attention to the pipe material or grounding.

Connection examples for standard situations

Metal, grounded pipe

This connection method also applies:

- For plastic pipes
- For pipes with insulating liner

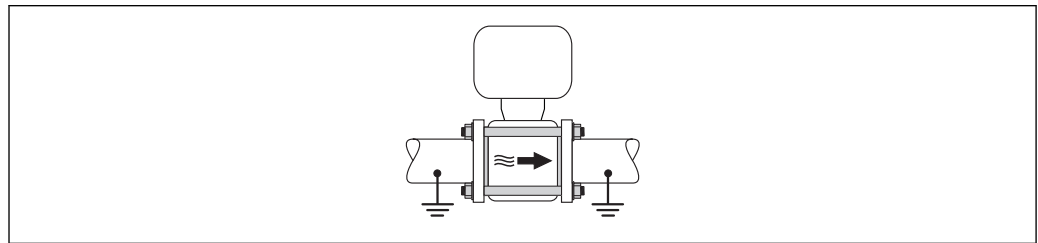

A0017516

Connection example in special situations

Unlined and ungrounded metal pipe

This connection method also applies in situations where:

- The customary potential equalization is not used
- Equalizing currents are present

Ground cable	Copper wire, at least 6 mm^2 (0.0093 in^2)
--------------	--

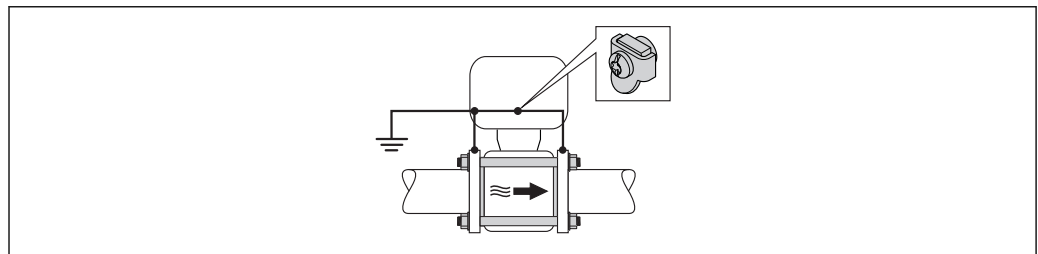

A0017517

1. Connect both pipe flanges to one another via a ground cable and ground them.
2. Mount the ground cable directly on the conductive flange coating of the pipe with the flange screws.

3. Connect the connection housing of the transmitter or sensor to ground potential by means of the ground terminal provided for the purpose.

i For remote device versions, the ground terminal in the example always refers to the sensor and **not** to the transmitter.

Pipe with a cathodic protection unit

This connection method is only used if the following two conditions are met:

- Metal pipe without liner or pipe with electrically conductive liner
- Cathodic protection is integrated in the personal protection equipment

Ground cable	Copper wire, at least 6 mm^2 (0.0093 in^2)
---------------------	--

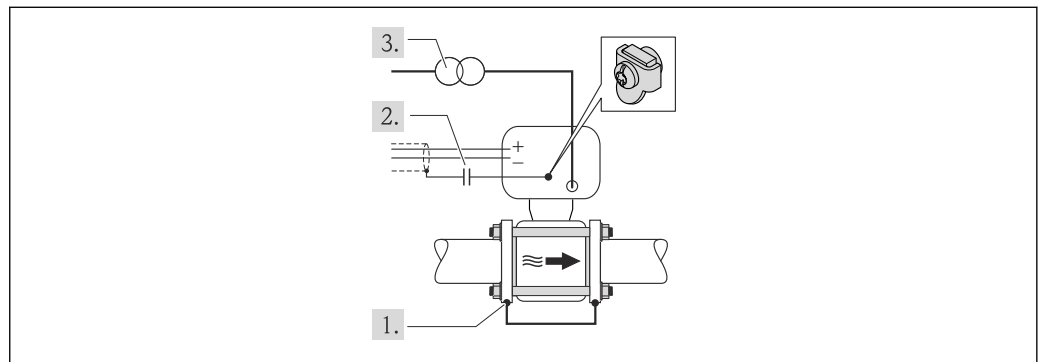

A0017518

Prerequisite: The sensor is installed in the pipe in a way that provides electrical insulation.

1. Connect the two flanges of the pipe to one another via a ground cable.
2. Guide the shield of the signal lines through a capacitor.
3. Connect the measuring device to the power supply such that it is floating in relation to the protective ground (isolation transformer).

i For remote device versions, the ground terminal in the example always refers to the sensor and **not** to the transmitter.

7.3 Special connection instructions

7.3.1 Connection examples

EtherNet/IP

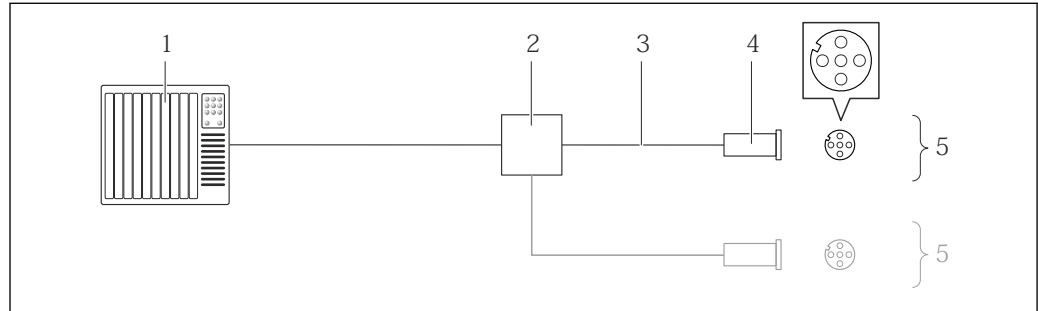

16 Connection example for EtherNet/IP

- 1 Control system (e.g. PLC)
- 2 Ethernet switch
- 3 Observe cable specifications (→ 30)
- 4 Connector
- 5 Transmitter

7.4 Hardware settings

7.4.1 Setting the device address

EtherNet/IP

The IP address of the measuring device can be configured for the network via DIP switches.

Addressing data

IP address and configuration options			
1st octet	2nd octet	3rd octet	4th octet
192.	168.	1.	XXX
	↓		↓
	Can only be configured via software addressing		Can be configured via software addressing and hardware addressing

IP address range	1 to 254 (4th octet)
IP address broadcast	255
Addressing mode ex works	Software addressing; all DIP switches for hardware addressing are set to OFF.
IP address ex works	DHCP server active

For device addressing via software (→ 67)

Setting the address

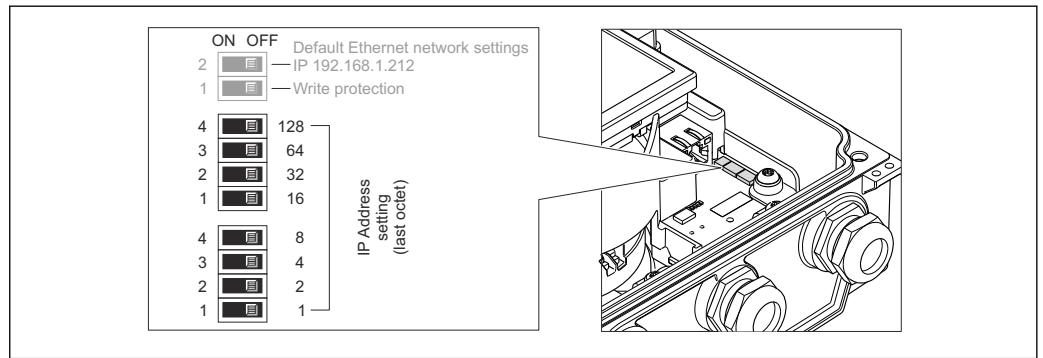

A0021322

1. Loosen the 4 fixing screws on the housing cover.
2. Open the housing cover.
3. Set the desired IP address using the corresponding DIP switches on the I/O electronics module.
 - ↳ Hardware addressing with the configured IP address is enabled after 10 s.
4. Reverse the removal procedure to reassemble the transmitter.

7.5 Ensuring the degree of protection

7.5.1 Degree of protection IP66/67, Type 4X enclosure

The measuring device fulfills all the requirements for the IP66/67 degree of protection, Type 4X enclosure.

To guarantee IP66/67 degree of protection, Type 4X enclosure, carry out the following steps after the electrical connection:

1. Check that the housing seals are clean and fitted correctly. Dry, clean or replace the seals if necessary.
2. Tighten all housing screws and screw covers.
3. Firmly tighten the cable glands.
4. To ensure that moisture does not enter the cable entry, route the cable so that it loops down before the cable entry ("water trap").

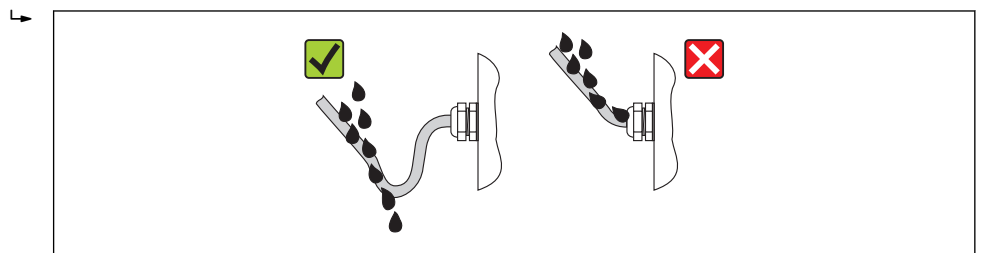



A0013960

5. Insert dummy plugs into unused cable entries.

7.6 Post-connection check

Are cables or the device undamaged (visual inspection)?	<input type="checkbox"/>
Do the cables comply with the requirements (→ 30)?	<input type="checkbox"/>
Do the cables have adequate strain relief?	<input type="checkbox"/>

Are all the cable glands installed, firmly tightened and leak-tight? Cable run with "water trap" (→  41) ?	<input type="checkbox"/>
Only for remote version: is the sensor connected to the right transmitter? Check the serial number on the nameplate of the sensor and transmitter.	<input type="checkbox"/>
Does the supply voltage match the specifications on the transmitter nameplate (→  114)?	<input type="checkbox"/>
Is the terminal assignment correct ?	<input type="checkbox"/>
If supply voltage is present, do values appear on the display module?	<input type="checkbox"/>
Is the potential equalization established correctly (→  38)?	<input type="checkbox"/>
Are all housing covers installed and the screws tightened with the correct tightening torque?	<input type="checkbox"/>

8 Operation options

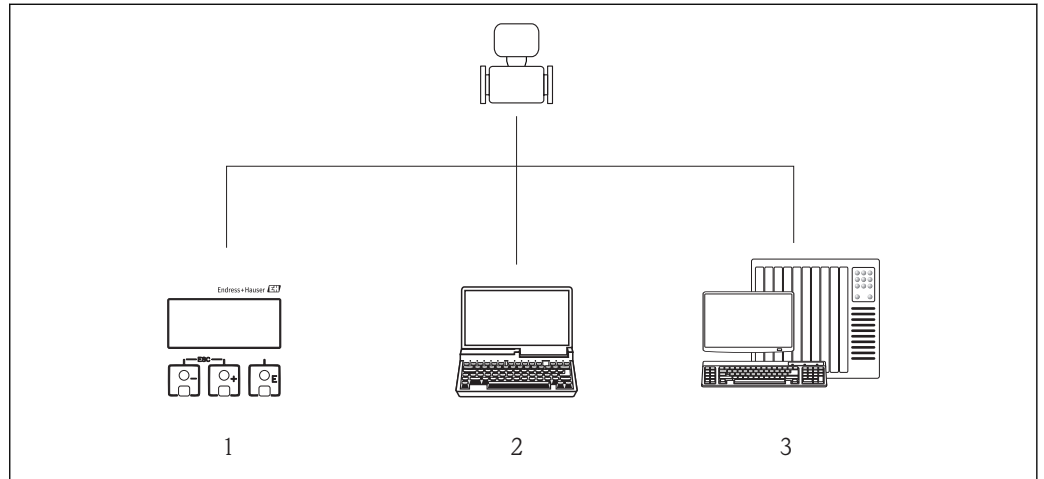

8.1 Overview of operation options





- 1 Local operation via display module
- 2 Computer with Web browser (e.g. Internet Explorer) or with operating tool (e.g. FieldCare, AMS Device Manager, SIMATIC PDM)
- 3 Control system (e.g. PLC)

8.2 Structure and function of the operating menu

8.2.1 Structure of the operating menu

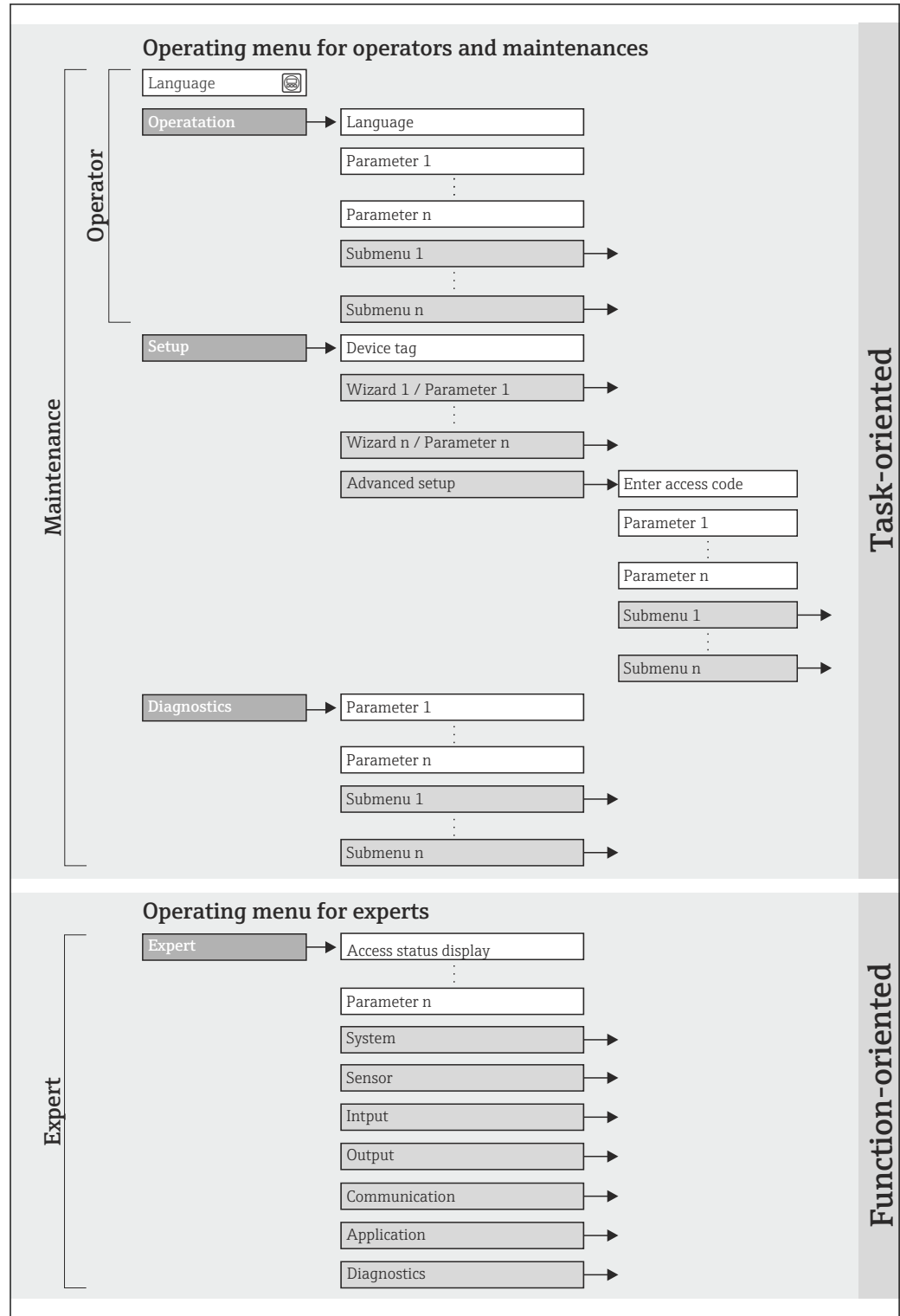
 For an overview of the operating menu with menus and parameters (→  128)



 17 Schematic structure of the operating menu

A0018237-EN

8.2.2 Operating philosophy

The individual parts of the operating menu are assigned to certain user roles. Each user role corresponds to typical tasks within the device lifecycle.

Menu		User role and tasks	Content/meaning
Operation	task-oriented	Role "Operator", "Maintenance" Tasks during operation: Reading measured values	<ul style="list-style-type: none"> ▪ Defining the Web server operating language ▪ Resetting and controlling totalizers
Setup		"Maintenance" role Commissioning: <ul style="list-style-type: none"> ▪ Configuration of the measurement ▪ Configuration of the communication interface 	Submenus for fast commissioning: <ul style="list-style-type: none"> ▪ Setting the individual system units ▪ Defining the medium ▪ Configuration of the digital communication interface ▪ Configuring the low flow cut off "Advanced setup" submenu: <ul style="list-style-type: none"> ▪ For more customized configuration of the measurement (adaptation to special measuring conditions) ▪ Configuration of totalizers ▪ "Device reset" submenu Resets the device configuration to certain settings
Diagnostics		"Maintenance" role Fault elimination: <ul style="list-style-type: none"> ▪ Diagnostics and elimination of process and device errors ▪ Measured value simulation 	Contains all parameters for error detection and analyzing process and device errors: <ul style="list-style-type: none"> ▪ "Diagnostic list" submenu Contains up to 5 currently pending diagnostic messages. ▪ "Event logbook" submenu Contains 20 event messages that have occurred. ▪ "Device information" submenu Contains information for identifying the device. ▪ "Measured values" submenu Contains all current measured values. ▪ "Simulation" submenu Is used to simulate measured values or output values.
Expert	function-oriented	Tasks that require detailed knowledge of the function of the device: <ul style="list-style-type: none"> ▪ Commissioning measurements under difficult conditions ▪ Optimal adaptation of the measurement to difficult conditions ▪ Detailed configuration of the communication interface ▪ Error diagnostics in difficult cases 	Contains all the parameters of the device and makes it possible to access these parameters directly using an access code. The structure of this menu is based on the function blocks of the device: <ul style="list-style-type: none"> ▪ "System" submenu Contains all higher-order device parameters that do not pertain either to measurement or the measured value communication. ▪ "Sensor" submenu Configuration of the measurement. ▪ "Communication" submenu Configuration of the digital communication interface and the Web server. ▪ "Application" submenu Configuration of the functions that go beyond the actual measurement (e.g. totalizer). ▪ "Diagnostics" submenu Error detection and analysis of process and device errors and for device simulation and Heartbeat Technology.

8.3 Access to the operating menu via the local display

8.3.1 Operational display

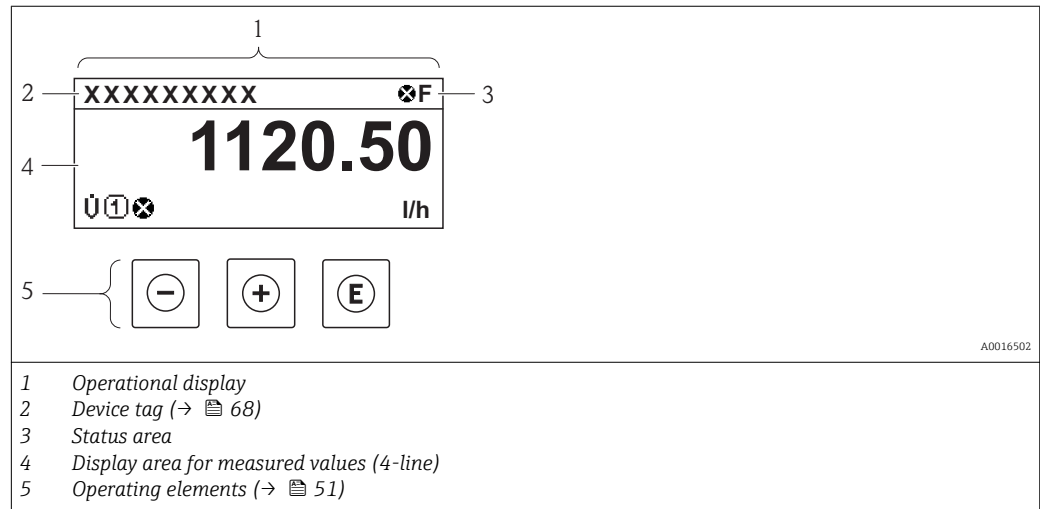

Status area

The following symbols appear in the status area of the operational display at the top right:

- Status signals(→ 91)
- Diagnostic behavior(→ 92)
- Locking
- Communication

Locking

Symbol	Meaning
	Device locked The measuring device is hardware locked (→ 81).

Communication





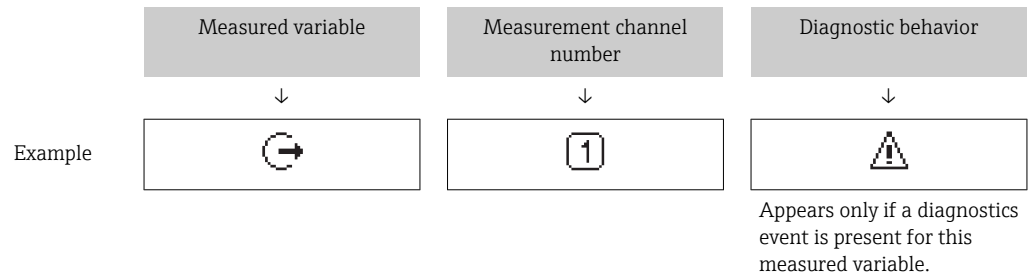

Symbol	Meaning
	Communication via remote operation is active.

Display area

In the display area, each measured value is prefaced by certain symbol types for further description:



Measured variables



Symbol	Meaning
	Volume flow
	Mass flow
	Totalizer  The measurement channel number indicates which of the three totalizers is displayed.
	Output  The measurement channel number indicates which of the outputs is displayed.
	Status input

Measurement channel numbers

Symbol	Meaning
	Measurement channel 1 to 4
The measurement channel number is displayed only if more than one channel is present for the same measured variable type (e.g. Totalizer 1 to 3).	

Diagnostic behavior

The diagnostic behavior pertains to a diagnostic event that is relevant to the displayed measured variable. For information on the symbols (→  92)

 The number and display format of the measured values can be configured via the **"Format display" parameter**(→  70). "Operation" menu → Display → Format display

8.3.2 Navigation view

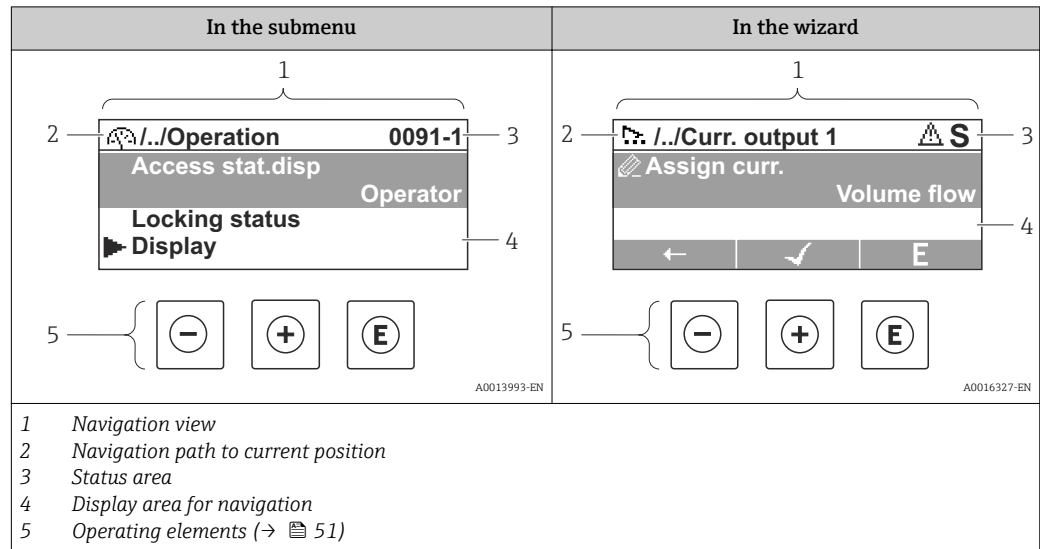

Navigation path

The navigation path - displayed at the top left in the navigation view - consists of the following elements:

	<ul style="list-style-type: none"> In the submenu: Display symbol for menu In the wizard: Display symbol for wizard 	Omission symbol for operating menu levels in between	Name of current <ul style="list-style-type: none"> Submenu Wizard Parameter
	↓	↓	↓
Examples		/ .. /	Display
		/ .. /	Display

i For more information about the menu icons, refer to the "Display area" section (→ 49)

Status area





The following appears in the status area of the navigation view in the top right corner:

- Of the submenu
 - The direct access code for the parameter you are navigating to (e.g. 0022-1)
 - If a diagnostic event is present, the diagnostic behavior and status signal
- In the wizard
 - If a diagnostic event is present, the diagnostic behavior and status signal





- i** For information on the diagnostic behavior and status signal (→ 91)
- For information on the function and entry of the direct access code (→ 54)

Display area

Menus

Symbol	Meaning
	<p>Operation Appears:</p> <ul style="list-style-type: none"> ▪ In the menu next to the "Operation" selection ▪ At the left in the navigation path in the "Operation" menu
	<p>Setup Appears:</p> <ul style="list-style-type: none"> ▪ In the menu next to the "Setup" selection ▪ At the left in the navigation path in the "Setup" menu
	<p>Diagnostics Appears:</p> <ul style="list-style-type: none"> ▪ In the menu next to the "Diagnostics" selection ▪ At the left in the navigation path in the "Diagnostics" menu
	<p>Expert Appears:</p> <ul style="list-style-type: none"> ▪ In the menu next to the "Expert" selection ▪ At the left in the navigation path in the "Expert" menu



Submenus, wizards, parameters

Symbol	Meaning
	Submenu
	Wizard
	Parameters within a wizard
	No display symbol exists for parameters in submenus.

Locking

Symbol	Meaning
	<p>Parameter locked When displayed in front of a parameter name, indicates that the parameter is locked.</p> <ul style="list-style-type: none"> ▪ By a user-specific access code (→ ⓘ 80) ▪ By the hardware write protection switch (→ ⓘ 81)

Wizard operation

Symbol	Meaning
	Switches to the previous parameter.
	Confirms the parameter value and switches to the next parameter.
	Opens the editing view of the parameter.

8.3.3 Editing view

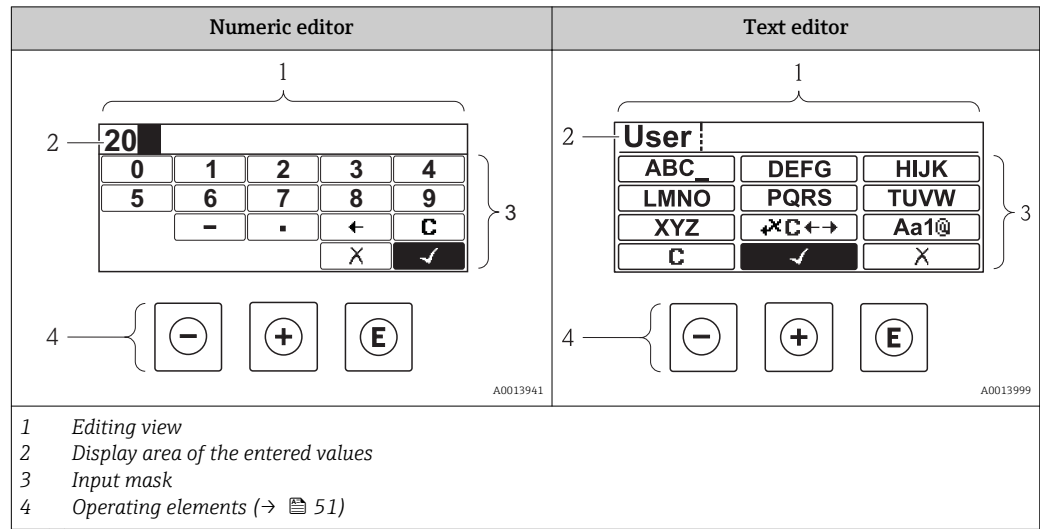

Input mask









The following input symbols are available in the input mask of the numeric and text editor:

Numeric editor





Symbol	Meaning
	Selection of numbers from 0 to 9.
	Inserts decimal separator at the input position.
	Inserts minus sign at the input position.
	Confirms selection.
	Moves the input position one position to the left.
	Exits the input without applying the changes.
	Clears all entered characters.

Text editor



Symbol	Meaning
	Toggle <ul style="list-style-type: none"> Between upper-case and lower-case letters For entering numbers For entering special characters
	Selection of letters from A to Z.

 ... 	Selection of letters from a to z.
 ... 	Selection of special characters.
	Confirms selection.
	Switches to the selection of the correction tools.
	Exits the input without applying the changes.
	Clears all entered characters.

Correction symbols under 

Symbol	Meaning
	Clears all entered characters.
	Moves the input position one position to the right.
	Moves the input position one position to the left.
	Deletes one character immediately to the left of the input position.

8.3.4 Operating elements

Key	Meaning
	<p>Minus key</p> <p><i>In a menu, submenu</i> Moves the selection bar upwards in a choose list.</p> <p><i>With a Wizard</i> Confirms the parameter value and goes to the previous parameter.</p> <p><i>With a text and numeric editor</i> In the input mask, moves the selection bar to the left (backwards).</p>
	<p>Plus key</p> <p><i>In a menu, submenu</i> Moves the selection bar downwards in a choose list.</p> <p><i>With a Wizard</i> Confirms the parameter value and goes to the next parameter.</p> <p><i>With a text and numeric editor</i> Moves the selection bar to the right (forwards) in an input screen.</p>

Key	Meaning
ⓔ	<p>Enter key</p> <p><i>For operational display</i></p> <ul style="list-style-type: none"> Pressing the key briefly opens the operating menu. Pressing the key for 2 s opens the context menu. <p><i>In a menu, submenu</i></p> <ul style="list-style-type: none"> Pressing the key briefly: <ul style="list-style-type: none"> Opens the selected menu, submenu or parameter. Starts the wizard. If help text is open, closes the help text of the parameter. Pressing the key for 2 s for parameter: <ul style="list-style-type: none"> If present, opens the help text for the function of the parameter. <p><i>With a Wizard</i></p> <p>Opens the editing view of the parameter.</p> <p><i>With a text and numeric editor</i></p> <ul style="list-style-type: none"> Pressing the key briefly: <ul style="list-style-type: none"> Opens the selected group. Carries out the selected action. Pressing the key for 2 s confirms the edited parameter value.
Ⓜ + Ⓟ	<p>Escape key combination (press keys simultaneously)</p> <p><i>In a menu, submenu</i></p> <ul style="list-style-type: none"> Pressing the key briefly: <ul style="list-style-type: none"> Exits the current menu level and takes you to the next higher level. If help text is open, closes the help text of the parameter. Pressing the key for 2 s returns you to the operational display ("home position"). <p><i>With a Wizard</i></p> <p>Exits the wizard and takes you to the next higher level.</p> <p><i>With a text and numeric editor</i></p> <p>Closes the text or numeric editor without applying changes.</p>
Ⓜ + ⓔ	<p>Minus/Enter key combination (press the keys simultaneously)</p> <p>Reduces the contrast (brighter setting).</p>
Ⓟ + ⓔ	<p>Plus/Enter key combination (press and hold down the keys simultaneously)</p> <p>Increases the contrast (darker setting).</p>
Ⓜ + Ⓟ + ⓔ	<p>Minus/Plus/Enter key combination (press the keys simultaneously)</p> <p><i>For operational display</i></p> <p>Enables or disables the keypad lock (only SD02 display module).</p>

8.3.5 Opening the context menu

Using the context menu, the user can call up the following menus quickly and directly from the operational display:

- Setup
- Simulation

Calling up and closing the context menu

The user is in the operational display.

- Press ⓔ for 2 s.
 - The context menu opens.

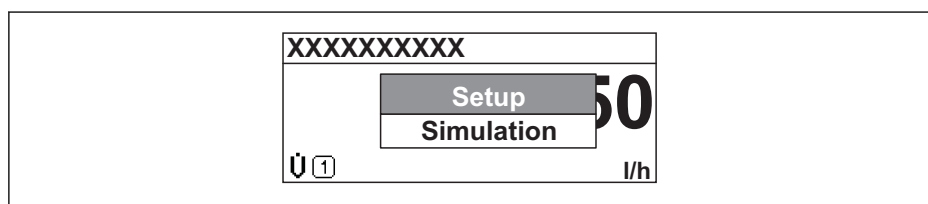



- Press Ⓜ + Ⓟ simultaneously.

A0017421-EN

↳ The context menu is closed and the operational display appears.

Calling up the menu via the context menu

1. Open the context menu.
2. Press  to navigate to the desired menu.
3. Press  to confirm the selection.
 - ↳ The selected menu opens.

8.3.6 Navigating and selecting from list

Different operating elements are used to navigate through the operating menu. The navigation path is displayed on the left in the header. Icons are displayed in front of the individual menus. These icons are also shown in the header during navigation.

i For an explanation of the navigation view with symbols and operating elements (→ 48)

Example: Setting the number of displayed measured values to "2 values"

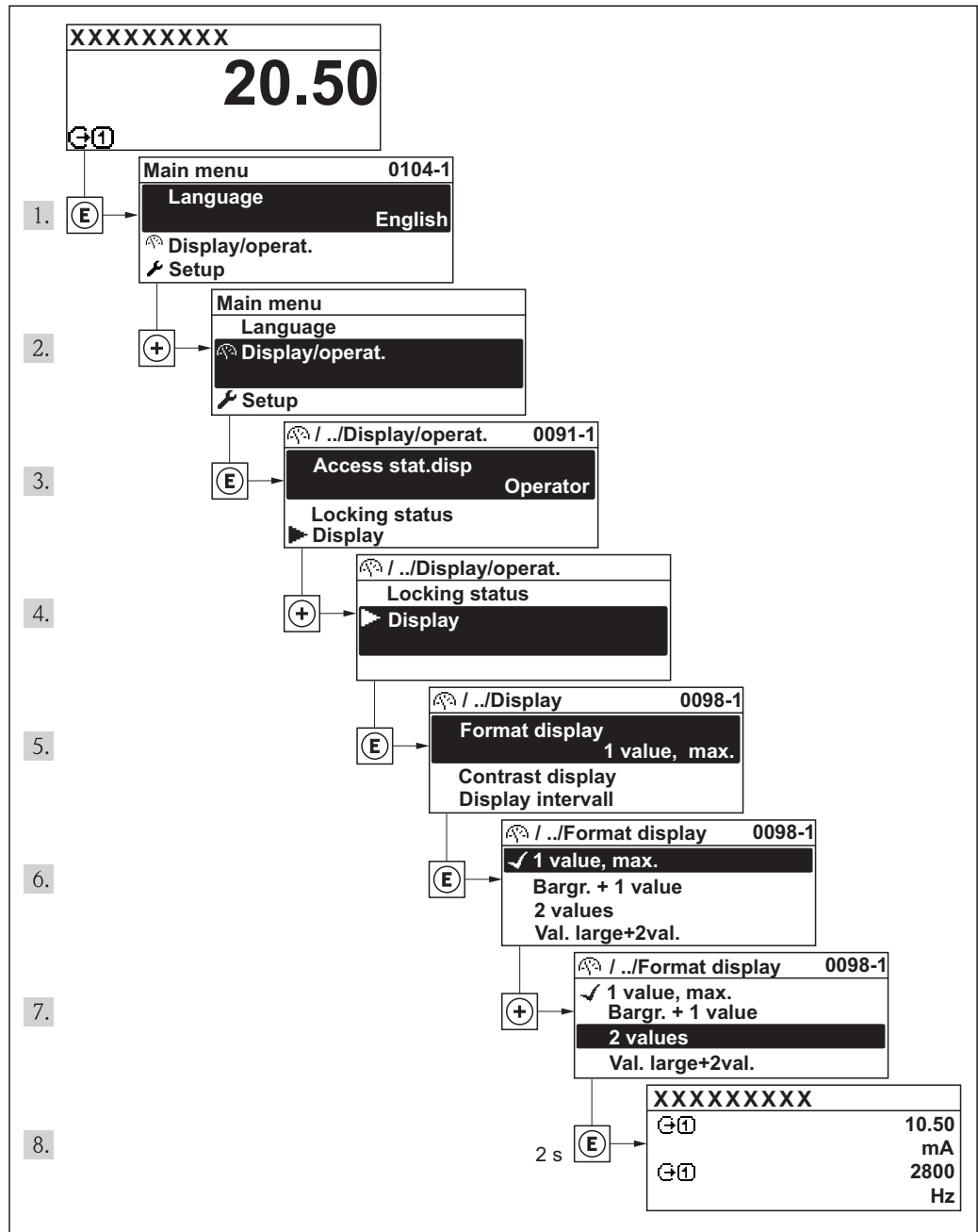

A0017448-EN

8.3.7 Calling the parameter directly

A parameter number is assigned to every parameter to be able to access a parameter directly via the onsite display. Entering this access code in the **Direct access** parameter calls up the desired parameter directly.

Navigation path

"Expert" menu → Direct access

The direct access code consists of a 4-digit number and the channel number, which identifies the channel of a process variable: e.g. 0914-1. In the navigation view, this appears on the right-hand side in the header of the selected parameter.

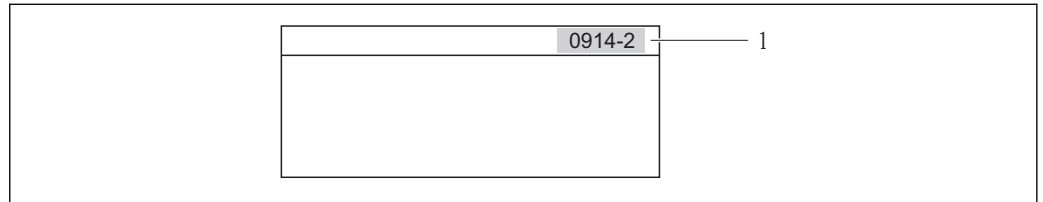

A0017223

1 Direct access code

Note the following when entering the direct access code:

- The leading zeros in the direct access code do not have to be entered.
Example: Input of "914" instead of "0914"
- If no channel number is entered, channel 1 is jumped to automatically.
Example: Input of "0914" → Parameter **Totalizer 1**
- If a different channel is jumped to: Enter the direct access code with the corresponding channel number.
Example: Input of "0914-2" → Parameter **Totalizer 2**



For the direct access codes of the individual parameters

8.3.8 Calling up help text

For some parameters, help texts exist, which the user can call up from the navigation view. These briefly describe the function of the parameter and thus support fast and reliable commissioning.

Calling up and closing the help text

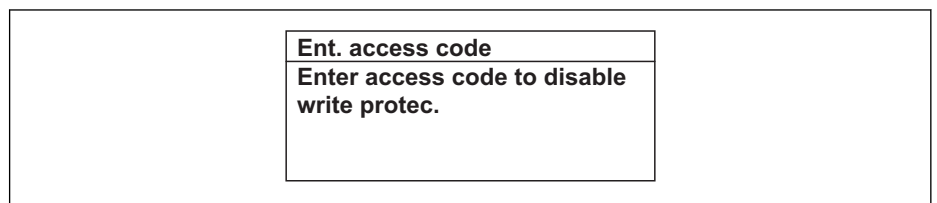

The user is in the navigation view and the selection bar is on a parameter.

1. Press  for 2 s.
 - ↳ The help text for the selected parameter opens.



A0014002-EN

 18 Example: Help text for parameter "Enter access code"

2. Press  +  simultaneously.
 - ↳ The help text is closed.

8.3.9 Changing the parameters

i For a description of the editing display - consisting of text editor and numeric editor - with symbols (→ 50), for a description of the operating elements (→ 51)

Example: Changing the tag name in the "Tag description" parameter from 001-FT-101 to 001-FT-102

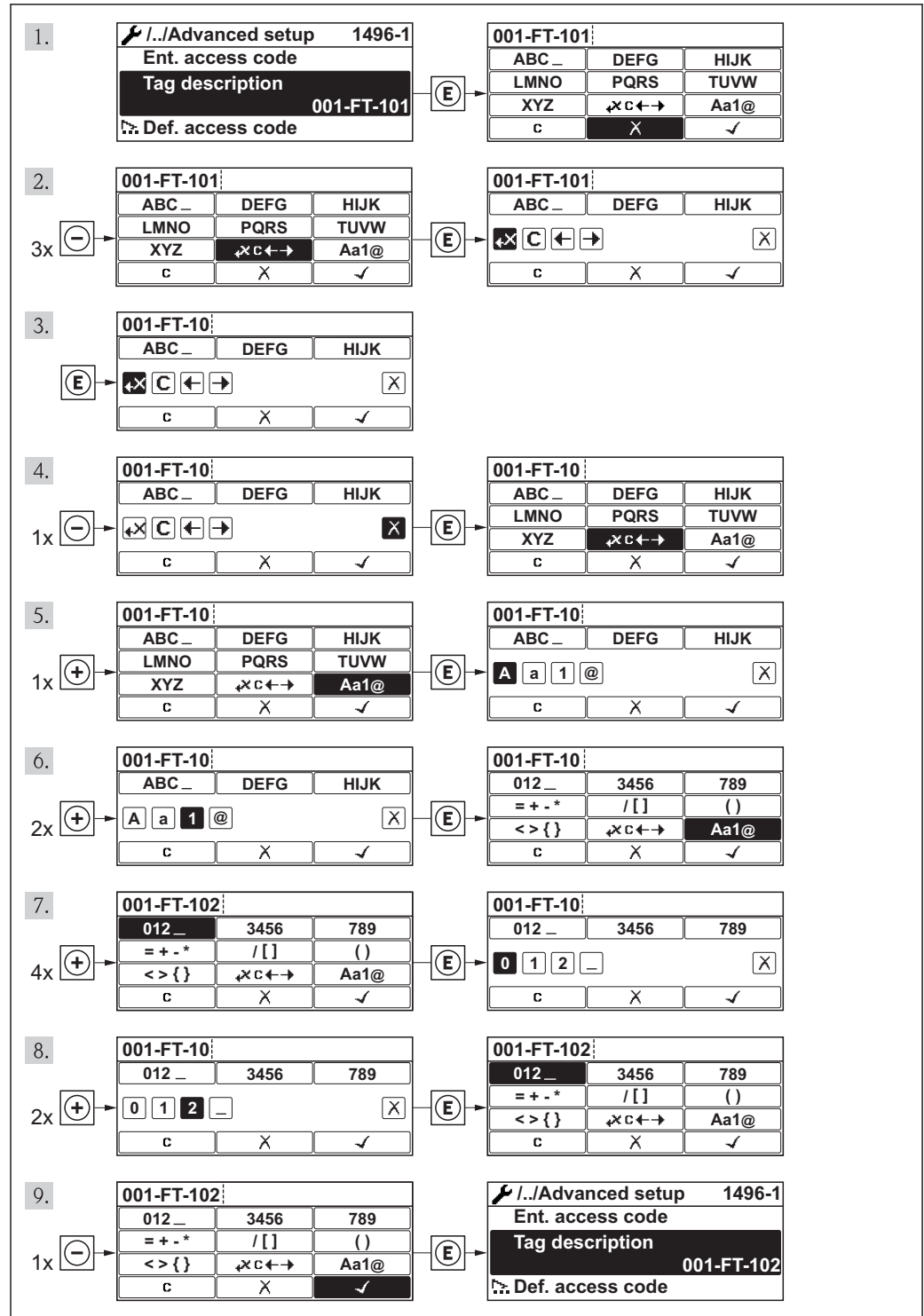

A0014020-EN

A message is displayed if the value entered is outside the permitted value range.

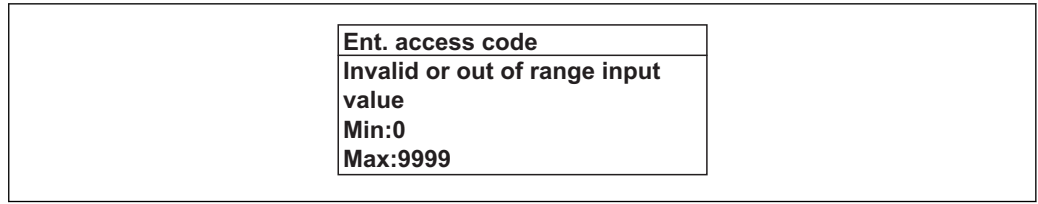

A0014049-EN

8.3.10 User roles and related access authorization

The two user roles "Operator" and "Maintenance" have different write access to the parameters if the customer defines a user-specific access code. This protects the device configuration via the local display from unauthorized access (→ 80).

Access authorization to parameters

User role	Read access		Write access	
	Without access code (from the factory)	With access code	Without access code (from the factory)	With access code
Operator	✓	✓	✓	-- 1)
Maintenance	✓	✓	✓	✓

- 1) Despite the defined access code, certain parameters can always be modified and thus are excepted from the write protection, as they do not affect the measurement. Refer to the "Write protection via access code" section

If an incorrect access code is entered, the user obtains the access rights of the "Operator" role.

The user role with which the user is currently logged on is indicated by the **Access status display** parameter. Navigation path: Operation → Access status display

8.3.11 Disabling write protection via access code

If the -symbol appears on the local display in front of a parameter, the parameter is write-protected by a user-specific access code and its value cannot be changed at the moment using the local display (→ 80).

The locking of the write access via local operation can be disabled by entering the customer-defined access code via the respective access option.

1. After you press , the input prompt for the access code appears.
2. Enter the access code.
 - ↳ The -symbol in front of the parameters disappears; all previously write-protected parameters are now re-enabled.

8.3.12 Enabling and disabling the keypad lock

The keypad lock makes it possible to block access to the entire operating menu via local operation. As a result, it is no longer possible to navigate through the operating menu or change the values of individual parameters. Users can only read the measured values on the operational display.

Local operation with touch control

The keypad lock is switched on and off via the context menu.

Switching on the keypad lock

The keypad lock is switched on automatically:

- Each time the device is restarted.
- If the device has not been operated for longer than one minute in the measured value display.

1. The device is in the measured value display.
Press the  key for longer than 2 seconds.
↳ A context menu appears.
2. In the context menu, select the **Keylock on** option.
↳ The keypad lock is switched on.

 If the user attempts to access the operating menu while the keypad lock is active, the message **Keylock on** appears.

Switching off the keypad lock

1. The keypad lock is switched on.
Press the  key for longer than 2 seconds.
↳ A context menu appears.
2. In the context menu, select the **Keylock off** option.
↳ The keypad lock is switched off.



8.4 Access to the operating menu via the Web browser

8.4.1 Function range

Thanks to the integrated Web server the device can be operated and configured via a Web browser. The operating menu structure is the same as in the local display. In addition to the measured values, status information on the device is also displayed and allows the user to monitor the status of the device. Furthermore the device data can be managed and the network parameters can be configured.

8.4.2 Prerequisites

Hardware

Connecting cable	Standard Ethernet cable with RJ45 connector
Computer	RJ45 interface
Measuring device:	Web server must be enabled; factory setting: ON  For information on enabling the Web server (→  62)
IP address	If the IP address of the device is not known: <ul style="list-style-type: none"> ▪ The IP address can be read out via local operation: "Diagnostics" menu → Device information → IP address ▪ Communication with the Web server can be established via the standard IP address 192.168.1.212. The DHCP function is enabled in the device at the factory, i.e. the device expects an IP address to be assigned by the network. This function can be disabled and the device can be set to the standard IP address 192.168.1.212: set top DIP switch No. 2 from OFF → ON.

ON OFF Default Ethernet network settings
 2 - IP 192.168.1.212
 1 - Write protection

4 128
 3 64
 2 32
 1 16
 4 8
 3 4
 2 2
 1 1

IP Address setting (last octet)

A0023353

i Once the DIP switch has been activated, the device must be restarted before the device uses the standard IP address.
 If the standard IP address (top DIP switch No. 2 = ON) is used, there is no connection to the EtherNet/IP network.

Software of the computer

Web browsers supported	<ul style="list-style-type: none"> Microsoft Internet Explorer (min. 8.x) Mozilla Firefox Google chrome
Recommended operating systems	<ul style="list-style-type: none"> Windows XP Windows 7
User rights for TCP/IP settings	User rights required for TCP/IP settings (e.g. for changes to IP address, subnet mask)
Computer configuration	<ul style="list-style-type: none"> JavaScript is enabled If JavaScript cannot be enabled, enter <code>http://192.168.1.212/basic.html</code> in the address line of the Web browser. A fully functional but simplified version of the operating menu structure starts in the Web browser.

i When installing a new firmware version:
 To enable correct data display, clear the temporary memory (cache) of the Web browser under **Internet options**.

8.4.3 Establishing a connection

Configuring the Internet protocol of the computer

IP address	192.168.1.XXX; for XXX all numerical values except: 0, 212 and 255 → e.g. 192.168.1.213
Subnet mask	255.255.255.0
Default gateway	192.168.1.212 or leave cells empty

1. Switch on the measuring device and connect to the computer via the cable (→ 63).
2. If a 2nd network card is not used: all the applications on the notebook should be closed, or all the applications that require the Internet or network, such as e-mail, SAP applications, Internet or Windows Explorer, i.e. close all open Internet browsers.
3. Configure the properties of the Internet protocol (TCP/IP) as defined in the table above.

Starting the Web browser

1. Start the Web browser on the computer.

2. If the IP address of the measuring device is known, enter the defined device address in the address line of the Web browser. If it is unknown, read the IP address via local operation ("Diagnostics" menu → Device information → IP address) or set the upper DIP switch No. 2 to ON, restart the device and enter the standard IP address 192.168.1.212 (→ 58).

The login page appears.

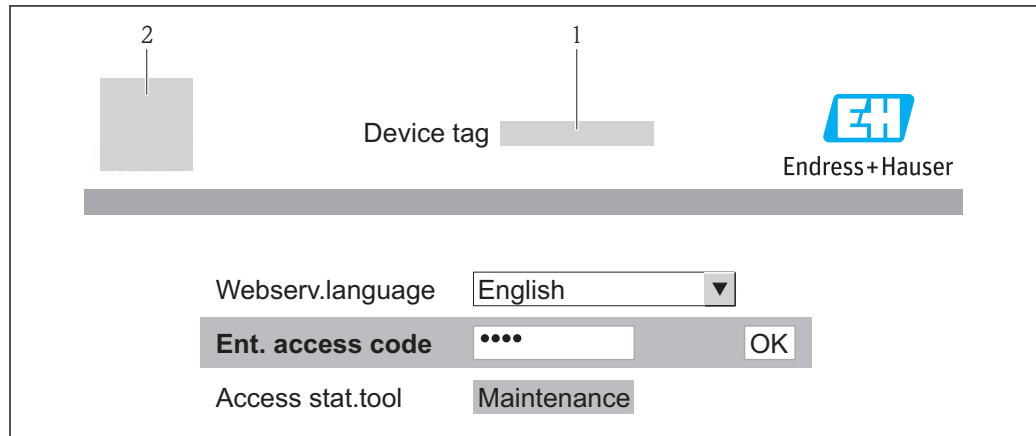

A0017362

- 1 Device tag (→ 68)
- 2 Picture of device

i If a login page does not appear, or if the page is incomplete (→ 89)

8.4.4 Logging on

1. Select the preferred operating language for the Web browser.
2. Enter the access code.
3. Press **OK** to confirm your entry.

Access code	0000 (factory setting); can be changed by customer (→ 80)
--------------------	---

i If no action is performed for 10 minutes, the Web browser automatically returns to the login page.

8.4.5 User interface

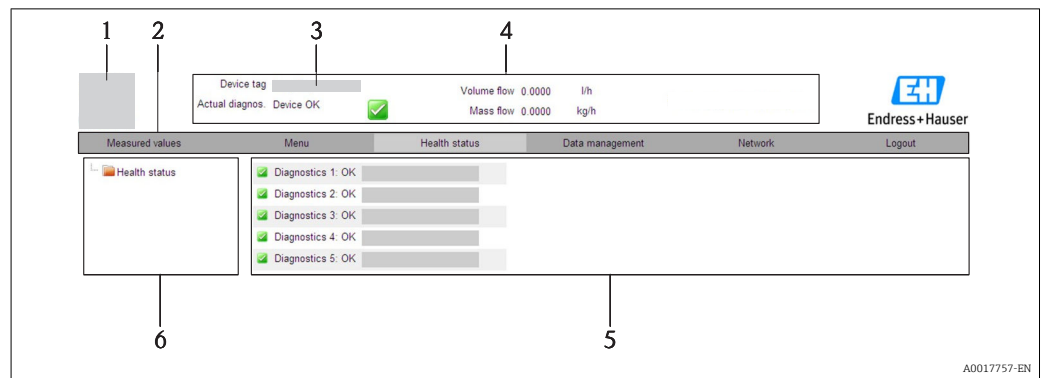

- 1 Picture of device
- 2 Function row with 6 functions
- 3 Device tag
- 4 Header
- 5 Working area
- 6 Navigation area

Header

The following information appears in the header:

- Device tag (→ 68)
- Device status with status signal (→ 94)
- Current measured values (→ 84)

Function row

Functions	Meaning
Measured values	The measured values of the device are displayed
Menu	Access to the operating menu structure of the device, same as for the local display and operating tool
Device status	Displays the diagnostic messages currently pending, listed in order of priority
Data management	<ul style="list-style-type: none"> ■ Data exchange between PC and measuring device: <ul style="list-style-type: none"> - Upload the configuration from the device (XML format, create configuration back-up) - Save the configuration to the device (XML format, restore configuration) - Export the event list (.csv file) - Export parameter settings (.csv file, create documentation of the measuring point configuration) - Export the Heartbeat verification log (PDF file, only available with the "Heartbeat Verification" application package) ■ Upload the device driver for system integration from the device
Network configuration	Configuration and checking of all the parameters required for establishing the connection to the device: <ul style="list-style-type: none"> ■ Network settings (e.g. IP address, MAC address) ■ Device information (e.g. serial number, firmware version)
Logout	End the operation and call up the login page

Navigation area

If a function is selected in the function bar, the submenus of the function open in the navigation area. The user can now navigate through the menu structure.

Working area

Depending on the selected function and the related submenus, various actions can be performed in this area:

- Configuring parameters
- Reading measured values
- Calling up help text
- Starting an upload/download

8.4.6 Disabling the Web server

The Web server for the measuring device can be enabled and disabled as required via the **Web server functionality** parameter.

Navigation

"Expert" menu → Communication → Web server

Parameter overview with brief description

Parameter	Description	Selection	Factory setting
Web server functionality	Switch the Web server on and off.	<ul style="list-style-type: none"> ▪ Off ▪ On 	On

Enabling the Web server

If the Web server is disabled it can only be re-enabled with the **Web server functionality** parameter via the following operating options:

- Via local display
- Via "FieldCare" operating tool

8.4.7 Logging out

 Before logging out, perform a data backup via the **Data management** function (upload configuration from device) if necessary.

1. Select the **Logout** entry in the function row.
 - ↳ The home page with the Login box appears.
2. Close the Web browser.
3. Reset the modified properties of the Internet protocol (TCP/IP) if they are no longer needed (→  59).

 If communication with the Web server was established via the standard IP address 192.168.1.212, DIP switch No. 10 must be reset (from ON → OFF) and the IP address of the device is active again for network communication.

8.5 Access to the operating menu via the operating tool

The structure of the operating menu in the operating tools is the same as for operation via the local display.

8.5.1 Connecting the operating tool

Via service interface (CDI-RJ45)

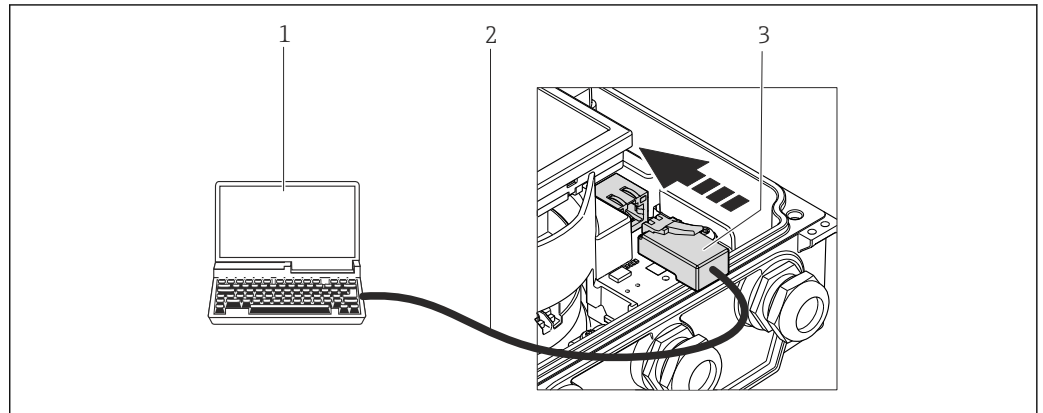

- 1 Computer with Web browser (e.g. Internet Explorer) for accessing the integrated device Web server or with "FieldCare" operating tool with COM DTM "CDI Communication TCP/IP"
- 2 Standard Ethernet connecting cable with RJ45 plug
- 3 Service interface (CDI -RJ45) of the measuring device with access to the integrated Web server

8.5.2 FieldCare

Function scope

FDT-based plant asset management tool from Endress+Hauser. It can configure all smart field devices in a system and helps you manage them. By using the status information, it is also a simple but effective way of checking their status and condition.

Access takes place via:

Service interface CDI-RJ45 (→  63)

Typical functions:

- Configuring parameters of transmitters
- Loading and saving device data (upload/download)
- Documentation of the measuring point
- Visualization of the measured value memory (line recorder) and event logbook

 For details, see Operating Instructions BA00027S and BA00059S

Source for device description files

See data (→  65)

Establishing a connection

Via service interface (CDI-RJ45)

1. Start FieldCare and launch the project.
2. In the network: Add a device.
 - ↳ The **Add device** window opens.
3. Select the **CDI Communication TCP/IP** option from the list and press **OK** to confirm.
4. Right-click **CDI Communication TCP/IP** and select the **Add device** option in the context menu that opens.
5. Select the desired device from the list and press **OK** to confirm.
 - ↳ The **CDI Communication TCP/IP (Configuration)** window opens.



6. Enter the device address in the **IP address** field: 192.168.1.212 and press **Enter** to confirm.
7. Establish the online connection to the device.

 For details, see Operating Instructions BA00027S and BA00059S

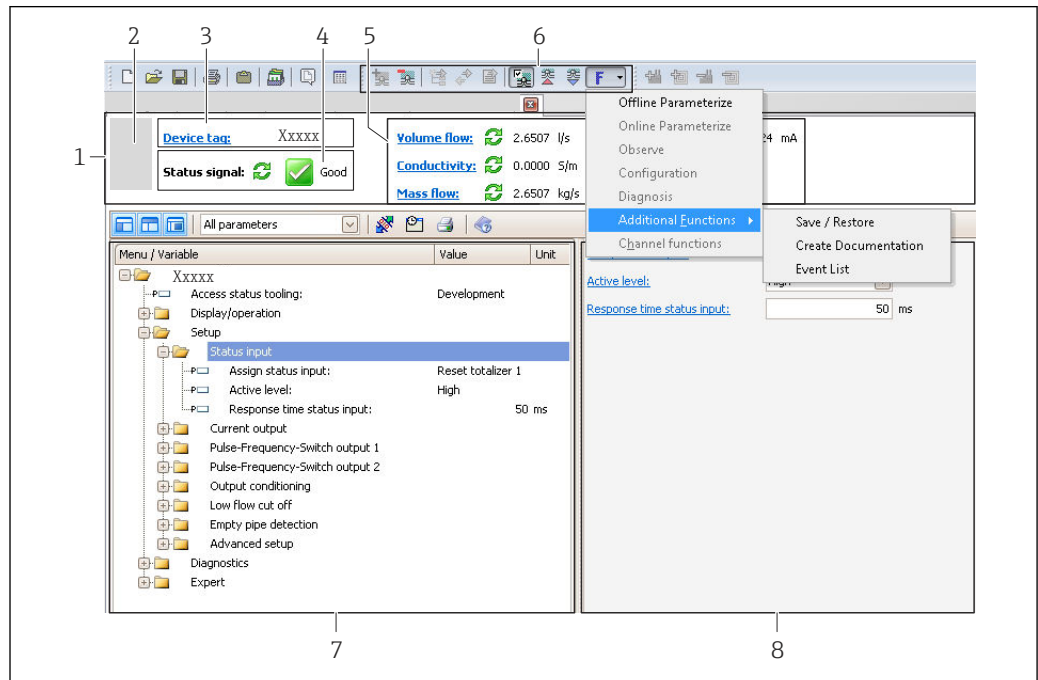
User interface



A0021053-EN

- 1 Header
- 2 Picture of device
- 3 Device tag (→  68)
- 4 Status area with status signal (→  94)
- 6 Display area for current measured values (→  84)
- 5 Event list with additional functions such as save/load, events list and document creation
- 7 Navigation area with operating menu structure
- 8 Operating range

9 System integration

9.1 Overview of device description files

9.1.1 Current version data for the device

Firmware version	01.01.zz	<ul style="list-style-type: none"> On the title page of the Operating instructions On transmitter nameplate(→ 13) Parameter firmware version Diagnostics → Device info → Firmware version
Release date of firmware version	05.2014	---
Manufacturer ID	0x49E	Manufacturer ID parameter Diagnostics → Device info → Manufacturer ID
Device type ID	0x1047	Device type parameter Diagnostics → Device info → Device type
Device revision	<ul style="list-style-type: none"> Major revision 2 Minor revision 1 	<ul style="list-style-type: none"> On transmitter nameplate(→ 13) Device revision parameter Diagnostics → Device info → Device revision
Device profile	Generic device (product type: 0x2B)	

9.1.2 Operating tools

The suitable device description file for the operating tool is listed in the table below, along with information on where the file can be acquired.



Operating tool via service interface (CDI)	Sources for obtaining device descriptions
FieldCare	<ul style="list-style-type: none"> www.endress.com → Download Area CD-ROM (contact Endress+Hauser) DVD (contact Endress+Hauser)

9.2 Overview of system files

System files	Version	Description	How to acquire
Electronic Data Sheet (EDS system file)	2.1	Certified in accordance with the following ODVA guidelines: <ul style="list-style-type: none"> Conformance test Performance test PlugFest Embedded EDS Support (File Object 0x37)	<ul style="list-style-type: none"> www.endress.com → Download Area EDS system file integrated in the device: can be downloaded via the Web browser (→ 61)
Add-on Profile Level 3	<ul style="list-style-type: none"> Major revision 2 Minor revision 1 	System file for "RSLogix 5000" software (Rockwell Automation)	www.endress.com → Download Area

9.3 Integrating the measuring device in the system



 A detailed description of how to integrate the device into an automation system (e.g. from Rockwell Automation) is available as a separate document: www.endress.com → Select country → Automation → Digital Communication → Fieldbus device integration → EtherNet/IP

 For information on the protocol-specific data of EtherNet/IP (→  112)

10 Commissioning

10.1 Function check



Before commissioning the device, make sure that the post-installation and post-connection checks have been performed.

- "Post-installation check" checklist (→  29)
- "Post-connection check" checklist (→  41)

10.2 Switching on the measuring device

After a successful function check, switch on the measuring device.

After a successful startup, the local display switches automatically from the startup display to the operational display.

 If nothing appears on the local display or a diagnostic message is displayed, refer to the section on "Diagnostics and troubleshooting" (→  88).

10.3 Configuring the device address via software

In the "**Communication**" submenu the device address can be set.



Navigation

"Setup" menu → Communication → Device address

10.3.1 Ethernet network and Web server

When delivered, the measuring device has the following factory settings:

IP address	192.168.1.212
Subnet mask	255.255.255.0
Default gateway	192.168.1.212

-  ▪ If hardware addressing is active, software addressing is disabled.
- If a switch is made to hardware addressing, the address configured via software addressing is retained for the first 9 places (the first three octets).
- If the IP address of the device is not known, the device address currently configured can be read out (→  83).

10.4 Setting the operating language

Factory setting: English or ordered local language

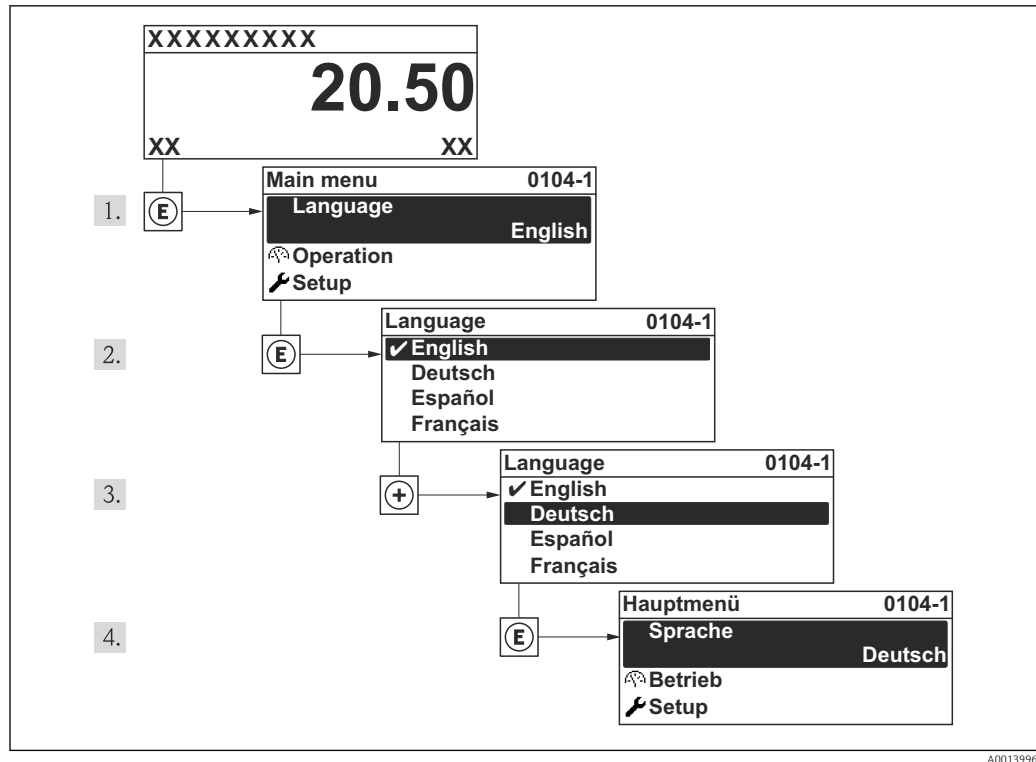

19 Using the example of the local display

A0013996

10.5 Configuring the measuring device

The **Setup** menu with its guided wizards contains all the parameters needed for standard operation.

Navigation to the **Setup** menu

Overview of the wizards in the "Setup" menu

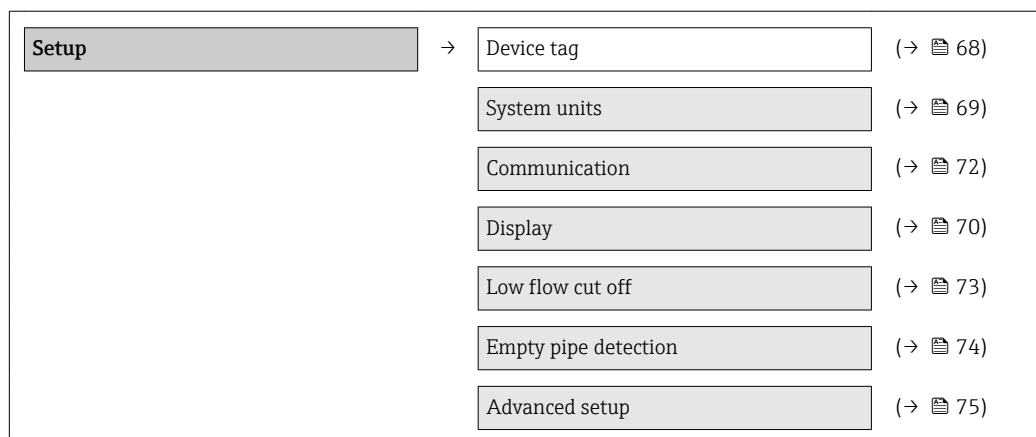

10.5.1 Defining the tag name

To enable fast identification of the measuring point within the system, you can enter a unique designation using the **Device tag** parameter and thus change the factory setting.

i The number of characters displayed depends on the characters used.

i For information on the tag name in the "FieldCare" operating tool (→ 64)

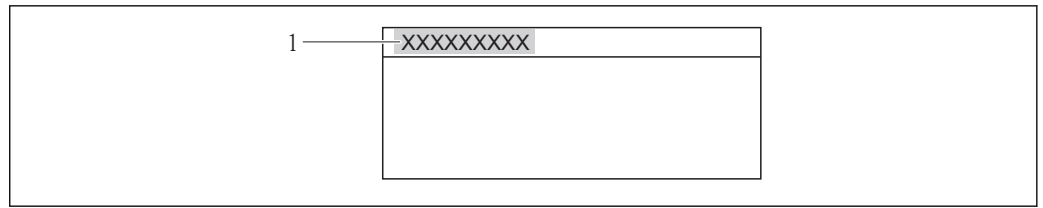

A0013375

20 Header of the operational display with tag name

1 Device tag

Navigation

"Setup" menu → Device tag

Parameter overview with brief description

Parameter	Description	User entry	Factory setting
Device tag	Enter tag for measuring point.	Max. 32 characters, such as letters, numbers or special characters (e.g. @, %, /).	Promag 400

10.5.2 Setting the system units

In the **System units** submenu the units of all the measured values can be set.

Navigation

"Setup" menu → System units

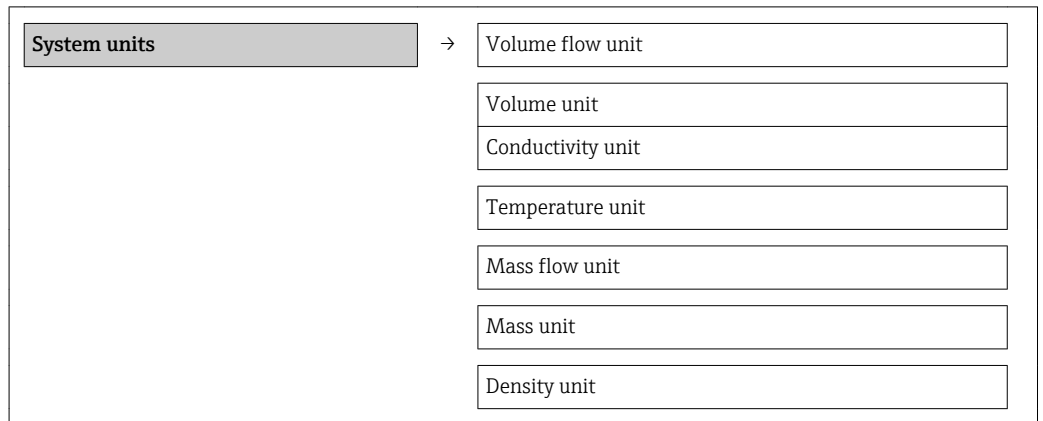

Parameter overview with brief description

Parameter	Description	Selection	Factory setting
Volume flow unit	Select volume flow unit. <i>Result</i> The selected unit applies for: <ul style="list-style-type: none"> ■ Output ■ Low flow cut off ■ Simulation process variable 	Unit choose list	Country-specific: <ul style="list-style-type: none"> ■ l/h ■ gal/min (us)
Volume unit	Select volume unit. Result The selected unit is taken from: Volume flow unit parameter	Unit choose list	Country-specific: <ul style="list-style-type: none"> ■ l ■ gal (us)

Parameter	Description	Selection	Factory setting
Temperature unit	Select temperature unit. <i>Result</i> The selected unit applies for: <ul style="list-style-type: none"> ▪ Output ▪ Reference temperature ▪ Simulation process variable 	Unit choose list	Country-specific: <ul style="list-style-type: none"> ▪ °C (Celsius) ▪ °F (Fahrenheit)
Mass flow unit	Select mass flow unit. <i>Result</i> The selected unit applies for: <ul style="list-style-type: none"> ▪ Output ▪ Low flow cut off ▪ Simulation process variable 	Unit choose list	Country-specific: <ul style="list-style-type: none"> ▪ kg/h ▪ lb/min
Mass unit	Select mass unit. <i>Result</i> The selected unit is taken from: Mass flow unit parameter	Unit choose list	Country-specific: <ul style="list-style-type: none"> ▪ kg ▪ lb
Density unit	Select density unit. <i>Result</i> The selected unit applies for: <ul style="list-style-type: none"> ▪ Output ▪ Simulation process variable ▪ Density adjustment (in Expert menu) 	Unit choose list	Country-specific: <ul style="list-style-type: none"> ▪ kg/l ▪ lb/ft³

10.5.3 Configuring the local display

The **Display** wizard guides you systematically through all the parameters that can be configured for configuring the local display.

Navigation

"Setup" menu → Display

Structure of the wizard

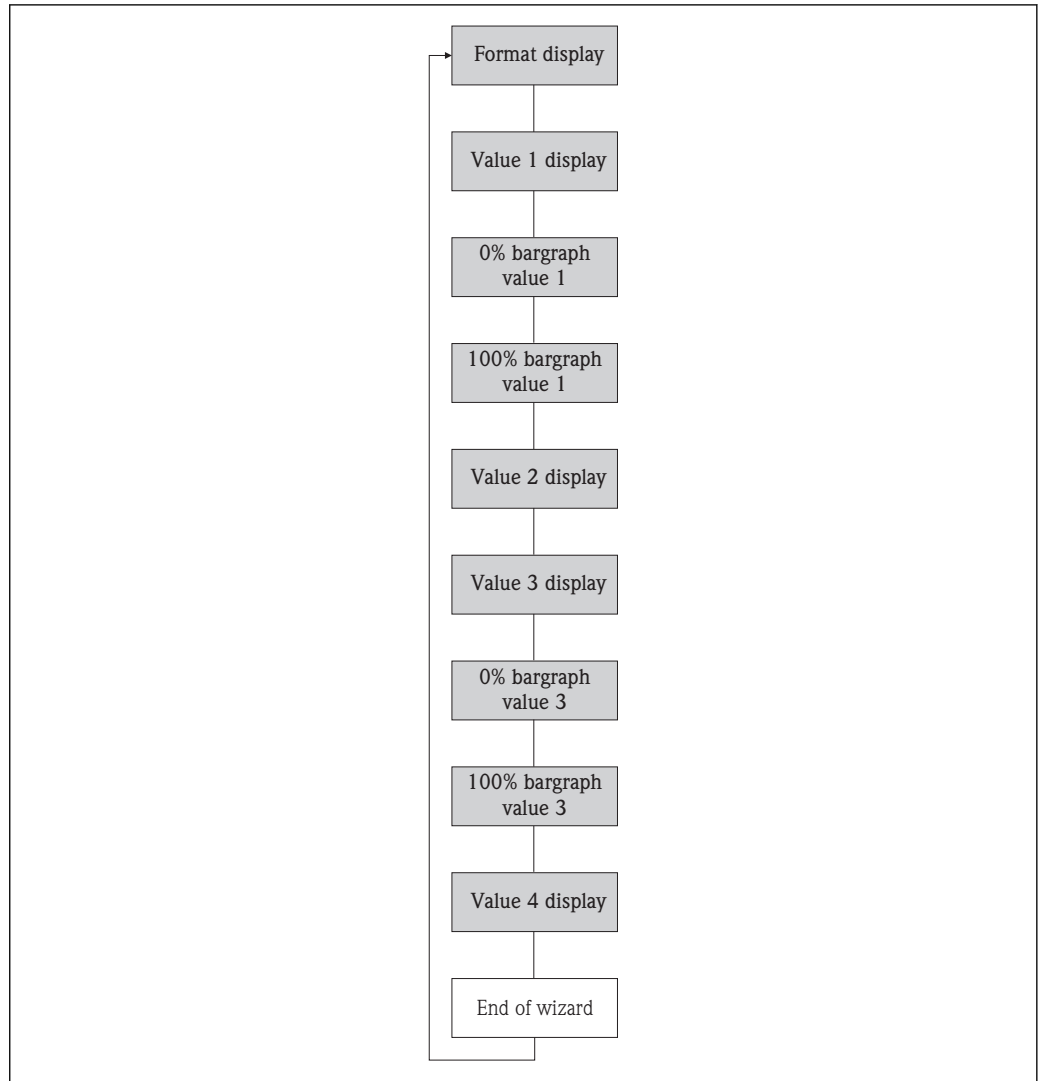

A0013797-EN

21 "Display" wizard in the "Setup" menu

Parameter overview with brief description

Parameter	Description	Selection / User entry	Factory setting
Format display	Select how measured values are shown on the display.	<ul style="list-style-type: none"> ■ 1 value, max. size ■ 1 bargraph + 1 value ■ 2 values ■ 1 value large + 2 values ■ 4 values 	1 value, max. size
Value 1 display	Select the measured value that is shown on the local display.	<ul style="list-style-type: none"> ■ Volume flow ■ Mass flow ■ Totalizer 1 ■ Totalizer 2 ■ Totalizer 3 ■ Current output 1 	Volume flow
0% bargraph value 1	Enter 0% value for bar graph display.	Signed floating-point number	0 l/h
100% bargraph value 1	Enter 100% value for bar graph display.	Signed floating-point number	0.025 l/h
Value 2 display	Select the measured value that is shown on the local display.	Picklist (see 1st display value)	None

Parameter	Description	Selection / User entry	Factory setting
Value 3 display	Select the measured value that is shown on the local display.	Picklist (see 1st display value)	None
0% bargraph value 3	Enter 0% value for bar graph display.	Signed floating-point number	0
100% bargraph value 3	Enter 100% value for bar graph display.	Signed floating-point number	0
Value 4 display	Select the measured value that is shown on the local display.	Picklist (see 1st display value)	None

10.5.4 Configuring the communication interface

The "**Communication**" submenu guides you systematically through all the parameters that have to be configured for selecting and setting the communication interface.



Navigation

"Setup" menu → Communication

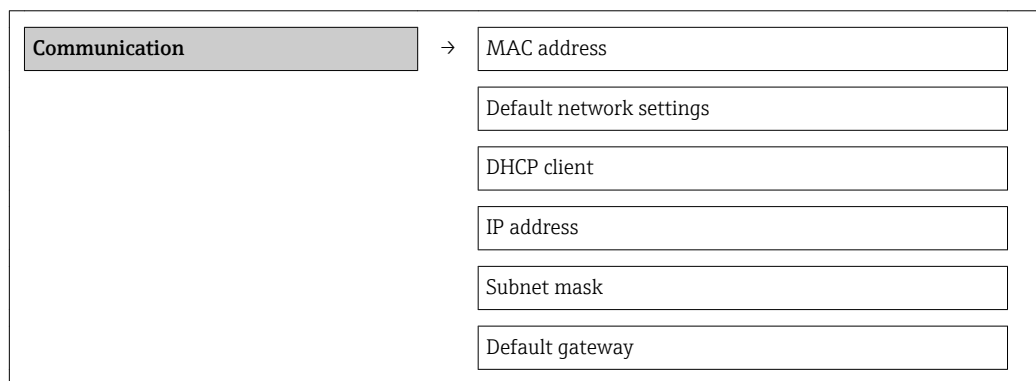
Structure of the submenu



Parameter overview with brief description

Parameter	Description	User interface / Selection / User entry	Factory setting
MAC address	Displays the MAC address of the measuring device.  MAC = Media Access Control	Unique 12-digit character string comprising letters and numbers, e.g.: 00:07:05:10:01:5F	Each measuring device is given an individual address.
Default network settings	Select whether to restore network settings.	<ul style="list-style-type: none"> ■ Off ■ On 	Off
DHCP client	Select to activate/deactivate DHCP client functionality. Result If the web server's DHCP client functionality is activated, the IP address, subnet mask and default gateway are automatically set.  Identification is via the MAC address of the measuring device.	<ul style="list-style-type: none"> ■ Off ■ On 	On
IP address	Displays the IP address of the Web server of the measuring device.	4 octet: 0 to 255 (in the particular octet)	192.168.1.212
Subnet mask	Displays the subnet mask.	4 octet: 0 to 255 (in the particular octet)	255.255.255.0
Default gateway	Displays the default gateway.	4 octet: 0 to 255 (in the particular octet)	0.0.0.0

10.5.5 Configuring the low flow cut off

The **Low flow cut off** wizard guides you systematically through all the parameters that have to be set for configuring the low flow cut off.

Navigation

"Setup" menu → Low flow cut off

Structure of the wizard

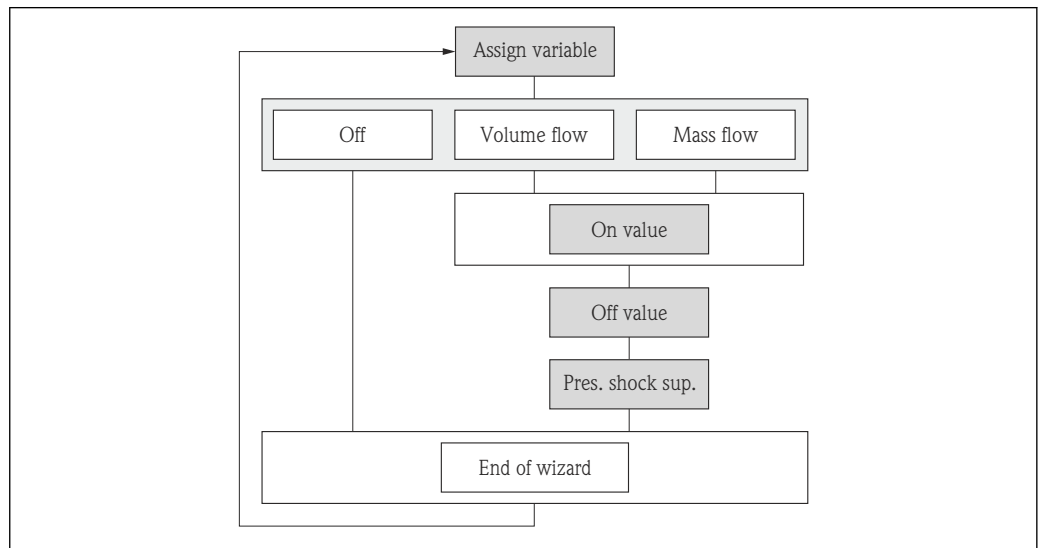

22 "Low flow cut off" wizard in the "Setup" menu

Parameter overview with brief description

Parameter	Description	Selection / User entry	Factory setting
Assign process variable	Select process variable for low flow cut off.	<ul style="list-style-type: none"> ■ Off ■ Volume flow ■ Mass flow 	Volume flow
On value low flow cutoff	Enter on value for low flow cut off.	Signed floating-point number	0 l/h
Off value low flow cutoff	Enter off value for low flow cut off.	0 to 100.0 %	50 %
Pressure shock suppression	Enter time frame for signal suppression (= active pressure shock suppression).	0 to 100 s	0 s

10.5.6 Configuring empty pipe detection

The **Empty pipe detection** wizard guides you systematically through all the parameters that have to be set for configuring the low flow cut off.

Navigation

"Setup" menu → Empty pipe detection

Structure of the wizard

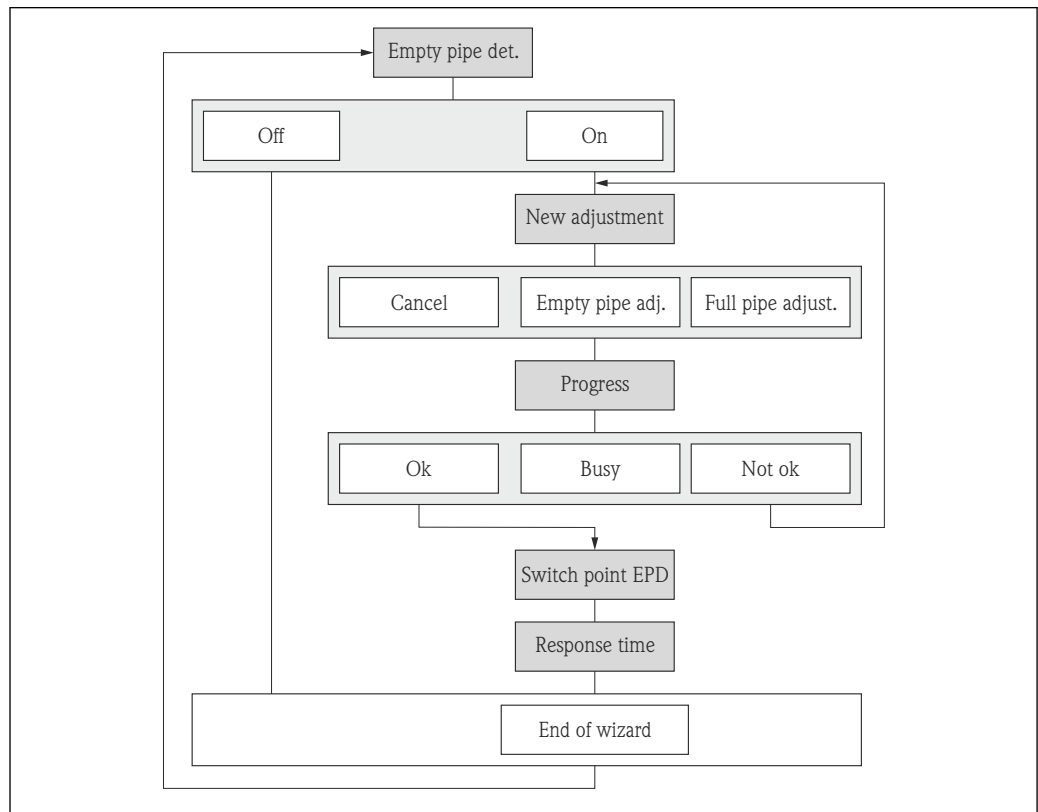

A0017210-EN

23 "Empty pipe detection" wizard in the "Setup" menu

Parameter overview with brief description

Parameter	Description	Selection / User interface / User entry	Factory setting
Empty pipe detection	Switch empty pipe detection on and off.	<ul style="list-style-type: none"> ▪ Off ▪ On 	Off
New adjustment	Select type of adjustment.	<ul style="list-style-type: none"> ▪ Cancel ▪ Empty pipe adjust ▪ Full pipe adjust 	Cancel
Progress		<ul style="list-style-type: none"> ▪ Ok ▪ Busy ▪ Not ok 	
Switch point empty pipe detection	Enter hysteresis in %, below this value the measuring tube will detected as empty.	0 to 100 %	50 %
Response time empty pipe detection	Enter the time before diagnostic message S862 "Pipe empty" is displayed for empty pipe detection.	0 to 100 s	1 s

10.6 Advanced settings

The **Advanced setup** submenu with its submenus contains parameters for specific settings.

Navigation to the "Advanced setup" submenu

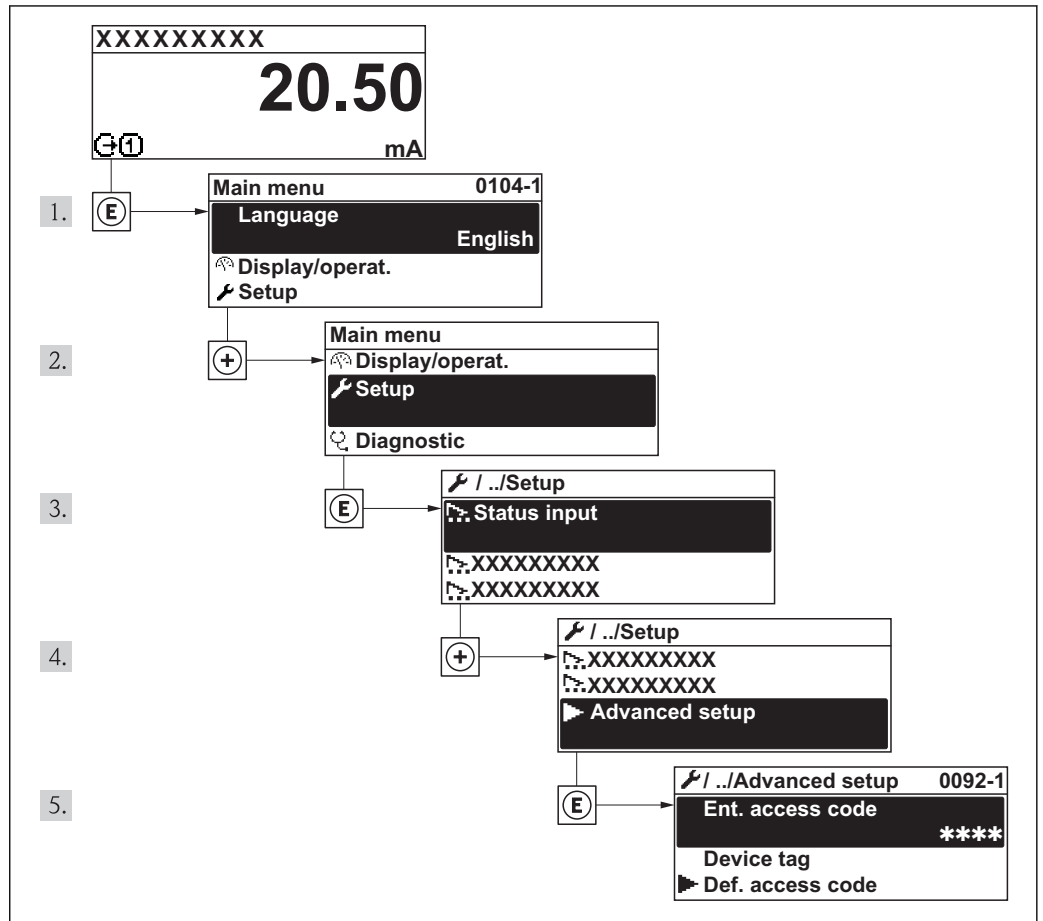

24 Using the example of the local display

Navigation

"Setup" menu → Advanced setup

Overview of the parameters and submenus in the "Advanced setup" submenu

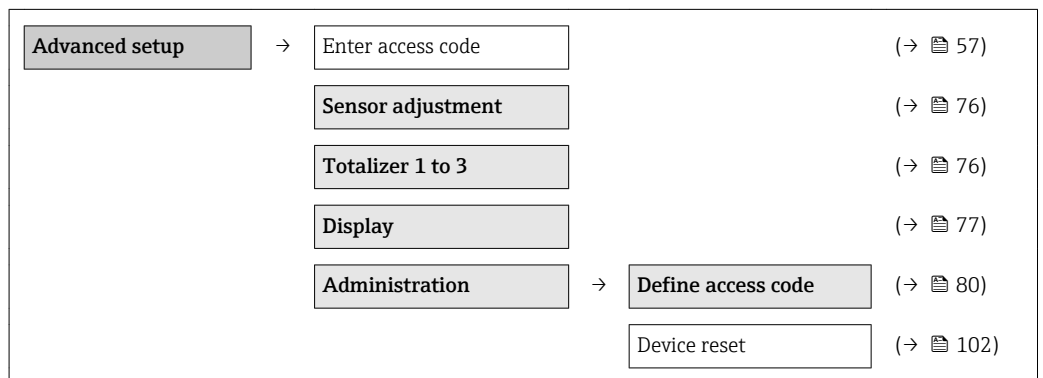

10.6.1 Carrying out a sensor adjustment

The **Sensor adjustment** submenu contains parameters that pertain to the functionality of the sensor.

Navigation

"Setup" menu → Advanced setup → Sensor adjustment

Structure of the submenu



Parameter overview with brief description

Parameter	Description	Selection	Factory setting
Installation direction	Set sign of flow direction to match the direction of the arrow on the sensor.	<ul style="list-style-type: none"> ▪ Flow in arrow direction ▪ Flow against arrow direction 	Flow in arrow direction

10.6.2 Configuring the totalizer

In the **"Totalizer 1 to 3"** submenu the individual totalizers can be configured.

Navigation

"Setup" menu → Advanced setup → Totalizer 1 to 3

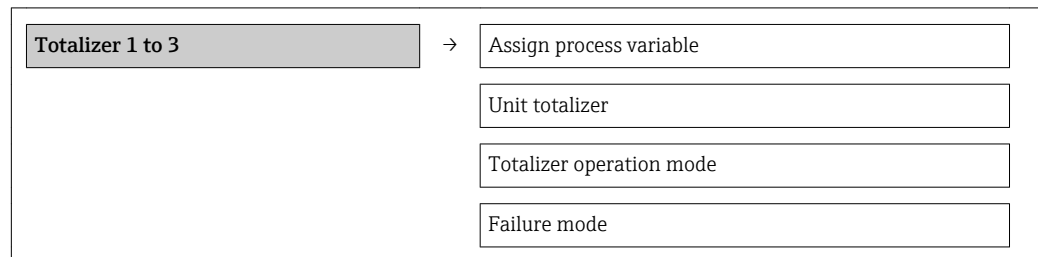

Parameter overview with brief description

Parameter	Description	Selection	Factory setting
Assign process variable	Select process variable for totalizer.	<ul style="list-style-type: none"> ▪ Off ▪ Volume flow ▪ Mass flow 	Volume flow
Unit totalizer	Select process variable totalizer unit.	Unit choose list	1
Totalizer operation mode	Select totalizer calculation mode.	<ul style="list-style-type: none"> ▪ Net flow total ▪ Forward flow total ▪ Reverse flow total 	Net flow total
Failure mode	Define totalizer behavior in alarm condition.	<ul style="list-style-type: none"> ▪ Stop ▪ Actual value ▪ Last valid value 	Stop

10.6.3 Carrying out additional display configurations

In the **"Display"** submenu you can set all the parameters involved in the configuration of the local display.

Navigation

"Setup" menu → Advanced setup → Display

Structure of the submenu

Display	→	Format display
		Value 1 display
		0% bargraph value 1
		100% bargraph value 1
		Decimal places 1
		Value 2 display
		Decimal places 2
		Value 3 display
		0% bargraph value 3
		100% bargraph value 3
		Decimal places 3
		Value 4 display
		Decimal places 4
		Display language
		Display interval
		Display damping
		Header
		Header text
		Separator
		Backlight

Parameter overview with brief description

Parameter	Description	Selection / User entry	Factory setting
Format display	Select how measured values are shown on the display.	<ul style="list-style-type: none"> ▪ 1 value, max. size ▪ 1 bargraph + 1 value ▪ 2 values ▪ 1 value large + 2 values ▪ 4 values 	1 value, max. size
Value 1 display	Select the measured value that is shown on the local display.	<ul style="list-style-type: none"> ▪ Volume flow ▪ Mass flow ▪ Totalizer 1 ▪ Totalizer 2 ▪ Totalizer 3 ▪ Current output 1 	Volume flow
0% bargraph value 1	Enter 0% value for bar graph display.	Signed floating-point number	0 l/h
100% bargraph value 1	Enter 100% value for bar graph display.	Signed floating-point number	0.025 l/h
Decimal places 1	Select the number of decimal places for the display value.	<ul style="list-style-type: none"> ▪ x ▪ x.x ▪ x.xx ▪ x.xxx ▪ x.xxxx 	x.xx
Value 2 display	Select the measured value that is shown on the local display.	Picklist (see 1st display value)	None
Decimal places 2	Select the number of decimal places for the display value.	<ul style="list-style-type: none"> ▪ x ▪ x.x ▪ x.xx ▪ x.xxx ▪ x.xxxx 	x.xx
Value 3 display	Select the measured value that is shown on the local display.	Picklist (see 1st display value)	None
0% bargraph value 3	Enter 0% value for bar graph display.	Signed floating-point number	0
100% bargraph value 3	Enter 100% value for bar graph display.	Signed floating-point number	0
Decimal places 3	Select the number of decimal places for the display value.	<ul style="list-style-type: none"> ▪ x ▪ x.x ▪ x.xx ▪ x.xxx ▪ x.xxxx 	x.xx
Value 4 display	Select the measured value that is shown on the local display.	Picklist (see 1st display value)	None
Decimal places 4	Select the number of decimal places for the display value.	<ul style="list-style-type: none"> ▪ x ▪ x.x ▪ x.xx ▪ x.xxx ▪ x.xxxx 	x.xx

Parameter	Description	Selection / User entry	Factory setting
Display language	Set display language.	<ul style="list-style-type: none"> ▪ English ▪ Deutsch ▪ Français ▪ Español ▪ Italiano ▪ Nederlands ▪ Portuguesa ▪ Polski ▪ русский язык (Russian) ▪ Svenska ▪ Türkçe ▪ 中文 (Chinese) ▪ 日本語 (Japanese) ▪ 한국어 (Korean) ▪ العربية (Arabic) ▪ Bahasa Indonesia ▪ ภาษาไทย (Thai) ▪ tiếng Việt (Vietnamese) ▪ čeština (Czech) 	English (alternatively, the ordered language is preset in the device)
Display interval	Set time measured values are shown on display if display alternates between values.	1 to 10 s	5 s
Display damping	Set display reaction time to fluctuations in the measured value.	0.0 to 999.9 s	0.0 s
Header	Select header contents on local display.	<ul style="list-style-type: none"> ▪ Device tag ▪ Free text 	Device tag
Header text	Enter display header text.		-----
Separator	Select decimal separator for displaying numerical values.	<ul style="list-style-type: none"> ▪ . ▪ , 	.
Backlight	Switch the local display backlight on and off.	<ul style="list-style-type: none"> ▪ Disable ▪ Enable 	Enable

10.7 Simulation

The **"Simulation" submenu** enables you to simulate, without a real flow situation, various process variables in the process and the device alarm mode and to verify downstream signal chains (switching valves or closed-control loops).

-  The parameters displayed depend on:
- The selected device order
 - The set operating mode of the pulse/frequency/switch outputs

Navigation

"Diagnostics" menu → Simulation

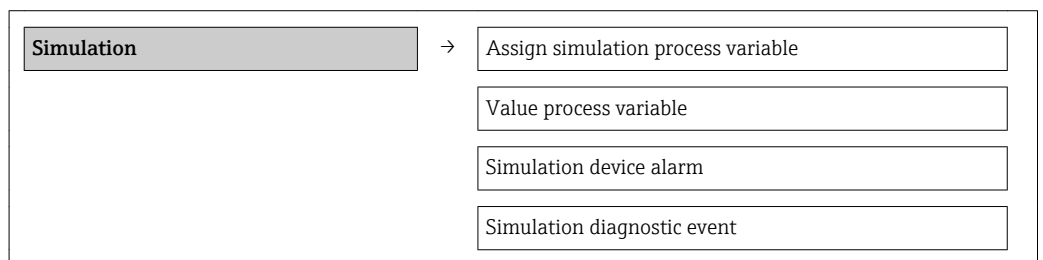



Parameter overview with brief description

Parameter	Prerequisite	Description	Selection / User entry	Factory setting
Assign simulation process variable	–	Select a process variable for the simulation process that is activated.	<ul style="list-style-type: none"> ▪ Off ▪ Volume flow ▪ Mass flow 	Off
Value process variable	A process variable is selected in the Assign simulation process variable parameter.	Enter the simulation value for the selected process variable.	Signed floating-point number	0
Simulation device alarm	–	Switch the device alarm on and off.	<ul style="list-style-type: none"> ▪ Off ▪ On 	Off
Diagnostic event category	–	Select the category of the diagnostic event.	<ul style="list-style-type: none"> ▪ Sensor ▪ Electronics ▪ Configuration ▪ Process 	Sensor
Simulation diagnostic event	–	Switch simulation of the diagnostic event on and off. For the simulation, you can choose from the diagnostic events of the category selected in the Diagnostic event category parameter.	<ul style="list-style-type: none"> ▪ Off ▪ Picklist Diagnostic events (depends on the selected category) 	Off

10.8 Protecting settings from unauthorized access

The following options exist for protecting the configuration of the measuring device from unintentional modification after commissioning:

- Write protection via access code for the local display and Web browser (→  80)
- Write protection via write protection switch (→  81)
- Write protection via keypad lock (→  57)

10.8.1 Write protection via access code

The effects of the customer-specific access code are as follows:

- Via local operation, the parameters for the measuring device configuration are write-protected and their values can no longer be changed.
- Device access via the Web browser is protected, as are the parameters for the measuring device configuration.

Navigation

"Setup" menu → Advanced setup → Administration → Define access code

Structure of the submenu

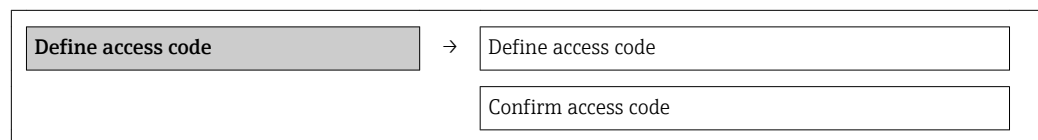

Defining the access code via local display

1. Navigate to the **Enter access code** parameter.
2. Define a max. 4-digit numeric code as an access code.
3. Enter the access code again to confirm the code.
 - ↳ The -symbol appears in front of all write-protected parameters.

The device automatically locks the write-protected parameters again if a key is not pressed for 10 minutes in the navigation and editing view. The device locks the write-protected parameters automatically after 60 s if the user skips back to the operational display mode from the navigation and editing view.

- i
 - If write access is activated via access code, it can be also be deactivated only via the access code (→  57).
 - The user role with which the user is currently logged on via the local display is indicated by the **Access status display** parameter. Navigation path: "Operation" menu → Access status display.

Parameters which can always be modified via the local display

Certain parameters that do not affect the measurement are excepted from write protection via the local display. Despite the defined access code, these parameters can always be modified even if the other parameters are locked.

Defining the access code via the Web browser

1. Navigate to the **Enter access code** parameter.
2. Define a max. 4-digit numeric code as an access code.
3. Enter the access code again to confirm the code.
 - ↳ The Web browser switches to the login page.

i If no action is performed for 10 minutes, the Web browser automatically returns to the login page.

i The user role with which the user is currently logged on via the Web browser is indicated by the **Access status tooling** parameter. Navigation path: Operation → Access status tooling

10.8.2 Write protection via write protection switch

Unlike write protection via user-specific access code, this allows write access to the entire operating menu - other than the **"Contrast display" parameter** - to be locked.

The parameter values are now read only and cannot be edited any more (exception **"Contrast display" parameter**):

Via local display

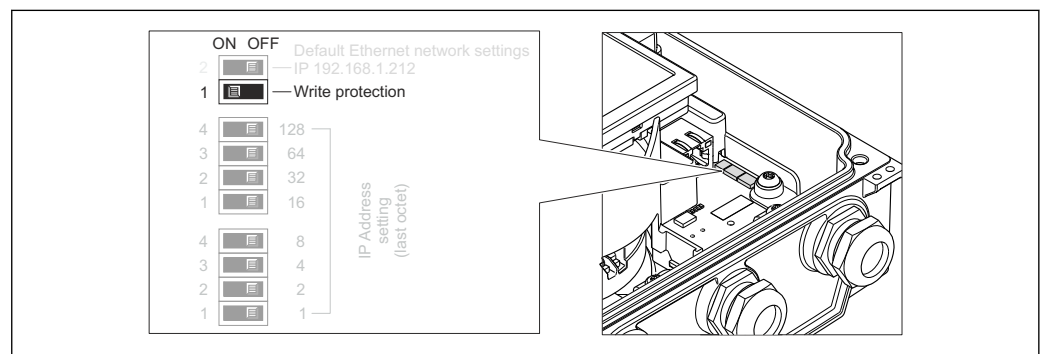

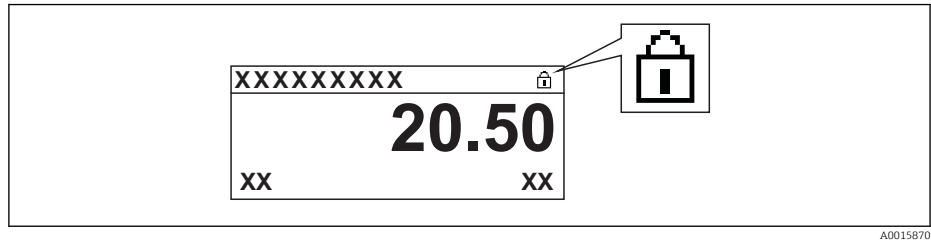

1. Loosen the 4 fixing screws on the housing cover and open the housing cover.
2. Setting the write protection switch (WP) on the main electronics module to the ON position enables the hardware write protection. Setting the write protection switch (WP) on the main electronics module to the OFF position (factory setting) disables the hardware write protection.
 - ↳ If hardware write protection is enabled, the **Hardware locked** option is displayed in the **Locking status** parameter (→  83). In addition, on the local display

the -symbol appears in front of the parameters in the header of the operational display and in the navigation view.



A0015870

If hardware write protection is disabled, no option is displayed in the **Locking status** parameter (→  83). On the local display, the -symbol disappears from in front of the parameters in the header of the operational display and in the navigation view.

3. **WARNING!** Excessive tightening torque applied to the fixing screws! Risk of damaging the plastic transmitter. Tighten the fixing screws as per the tightening torque (→  26).

Reverse the removal procedure to reassemble the transmitter.

11 Operation

11.1 Read out and modify current Ethernet settings

If the Ethernet settings such as the IP address of the measuring device are unknown, they can be read out and modified as explained in the following example for an IP address.

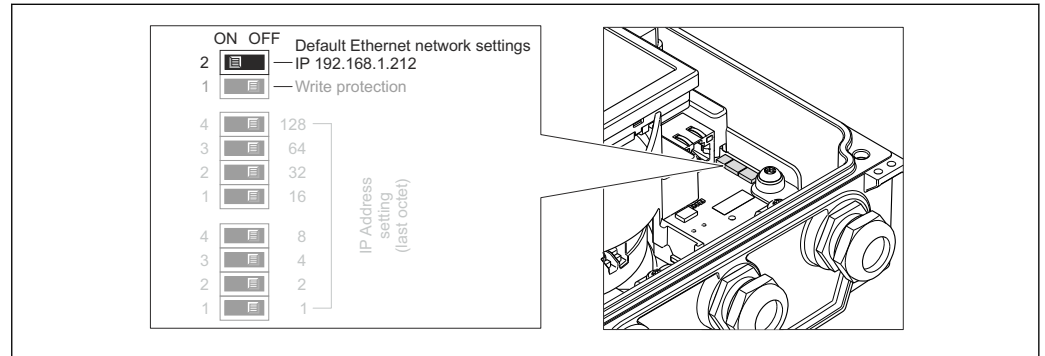

A0023058

Prerequisite

- Software addressing is enabled: All the DIP switches for hardware addressing are set to OFF. (→ 40)
- Measuring device is switched on.

1. Set the DIP switch for "Default Ethernet network settings, IP 192.168.1.212" from OFF → ON.
2. Restart the device.
 - ↳ The device's Ethernet settings are reset to their factory settings:
IP address: 192.168.1.212; Subnet mask: 255.255.255.0; Default gateway: 192.168.1.212
3. Enter the default setting for the IP address in the address line of the Web browser.
4. In the operating menu navigate to the **IP address** parameter: "Setup" menu → Communication → IP address
 - ↳ The parameter displays the configured IP address.
5. Change the IP address of the device if necessary.
6. Set the DIP switch for "Default Ethernet network settings, IP 192.168.1.212" from ON → OFF.
7. Restart the device.
 - ↳ The modified IP address of the device is now enabled.

11.2 Reading device locking status

The write protection types that are currently active can be determined using the **Locking status** parameter.

Navigation

"Operation" menu → Locking status

Function scope of "Locking status" parameter

Options	Description
None	The access status displayed in " Access status display " parameter applies (→ 57). Only appears on local display.
Hardware locked	The DIP switch for hardware locking is activated on the main electronics module. This prevents write access to the parameters (→ 81).
Temporarily locked	Due to internal processing in the device (e.g. up-/downloading of data, reset), write access to the parameters is blocked for a short time. Once the internal processing has been completed, the parameters can be changed once again.

11.3 Adjusting the operating language

Information (→ 67)

 For information on the operating languages supported by the measuring device (→ 124)

11.4 Configuring the display

- Basic settings for local display (→ 70)
- Advanced settings for local display (→ 77)

11.5 Reading measured values

Using the **Measured values** submenu, it is possible to read all the measured values.

"Diagnostics" menu → Measured values

11.5.1 Process variables

The **Process variables** submenu contains all the parameters needed to display the current measured values for every process variable.

Navigation

"Diagnostics" menu → Measured values → Process variables

Structure of the submenu

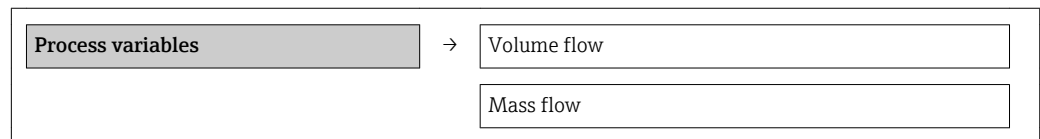

Structure of the submenu

Parameter overview with brief description

Parameter	Description	User interface
Volume flow	Displays the volume flow currently measured.	Signed floating-point number
Mass flow	Displays the mass flow currently calculated.	Signed floating-point number

11.5.2 Totalizer

The **"Totalizer" submenu** contains all the parameters needed to display the current measured values for every totalizer.

Navigation

"Diagnostics" menu → Measured values → Totalizer

Structure of the submenu

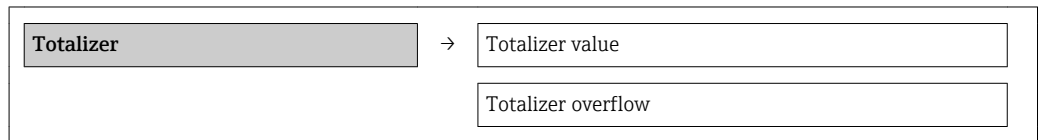

Parameter overview with brief description

Parameter	Description	User interface	Factory setting
Totalizer value 1	Displays the current totalizer counter value.	Signed floating-point number	0 1
Totalizer overflow 1	Displays the current totalizer overflow.	-32 000.0 to 32 000.0	0

11.6 Adapting the measuring device to the process conditions

The following are available for this purpose:

- Basic settings using the **Setup** menu(→ 68)
- Advanced settings using the **Advanced setup** submenu(→ 75)

11.7 Performing a totalizer reset

Function scope of "Control Totalizer " parameter

Options	Description
Totalize	The totalizer is started.
Stop	Totalizing is stopped.
Reset + hold	The totaling process is stopped and the totalizer is reset to 0.
Preset + hold	The totaling process is stopped and the totalizer is set to its defined start value from the Preset value parameter.
Reset + totalize	The totalizer is reset to 0 and the totaling process is restarted.
Preset + totalize	The totalizer is set to the defined start value in Preset value parameter and the totaling process is restarted.

Function scope of "Reset all totalizers" parameter

Options	Description
Reset + totalize	Resets all totalizers to 0 and restarts the totaling process. This deletes all the flow values previously totalized.

Navigation

"Operation" menu → Operation

Structure of the submenu

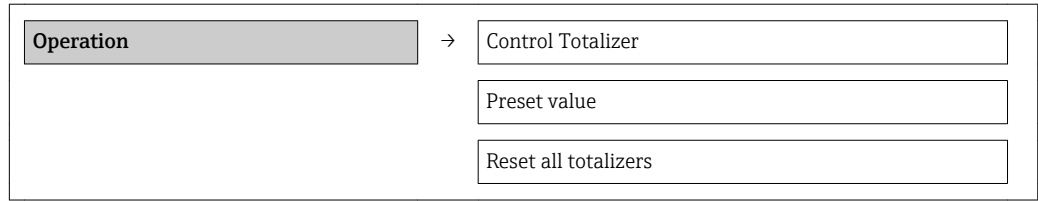

Parameter overview with brief description

Parameter	Description	Selection / User entry	Factory setting
Control Totalizer #	Control totalizer value.	<ul style="list-style-type: none"> ■ Totalize ■ Reset + hold ■ Preset + hold ■ Reset + totalize ■ Preset + totalize 	Totalize
Preset value #	Specify start value for totalizer.	Signed floating-point number	0 l
Reset all totalizers	Reset all totalizers to 0 and start.	<ul style="list-style-type: none"> ■ Cancel ■ Reset + totalize 	Cancel

11.8 Showing data logging

In the device, the extended function of the HistoROM must be enabled (order option) so that the **"Data logging" submenu** appears. This contains all the parameters for the measured value history.

Function scope

- A total of 1000 measured values can be stored
- 4 logging channels
- Adjustable logging interval for data logging
- Display of the measured value trend for each logging channel in the form of a chart

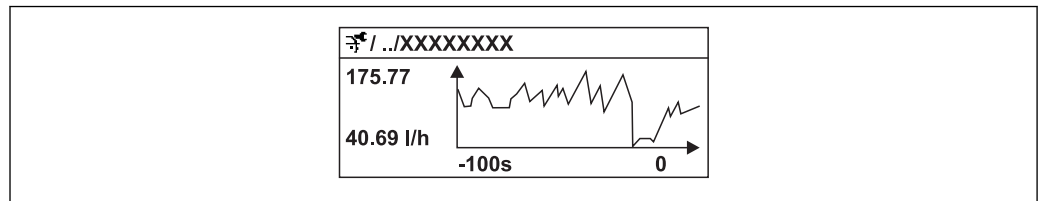

25 Chart of a measured value trend

- x-axis: depending on the number of channels selected displays 250 to 1000 measured values of a process variable.
- y-axis: displays the approximate measured value span and constantly adapts this to the ongoing measurement.

i If the length of the logging interval or the assignment of the process variables to the channels is changed, the content of the data logging is deleted.

Navigation

"Diagnostics" menu → Data logging

"Data logging" submenu

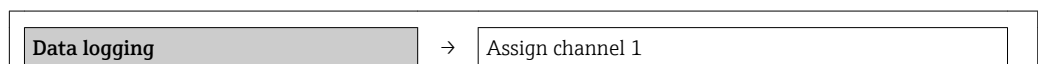

Assign channel 2
Assign channel 3
Assign channel 4
Logging interval
Clear logging data

Parameter overview with brief description

Parameter	Description	Selection / User entry	Factory setting
Assign channel 1	Assign process variable to logging channel.	<ul style="list-style-type: none"> ▪ Off ▪ Volume flow ▪ Mass flow ▪ Flow velocity ▪ Electronic temperature ▪ Current output 1 	Off
Assign channel 2	Assign process variable to logging channel.	Picklist (see Assign channel 1 parameter)	Off
Assign channel 3	Assign process variable to logging channel.	Picklist (see Assign channel 1 parameter)	Off
Assign channel 4	Assign process variable to logging channel.	Picklist (see Assign channel 1 parameter)	Off
Logging interval	Define the logging interval for data logging. This value defines the time interval between the individual data points in the memory.	1.0 to 3 600.0 s	10.0 s
Clear logging data	Clear the entire logging data.	<ul style="list-style-type: none"> ▪ Cancel ▪ Clear data 	Cancel

12 Diagnostics and troubleshooting

12.1 General troubleshooting

For local display

Problem	Possible causes	Remedy
Local display dark and no output signals	Supply voltage does not match that specified on the nameplate.	Apply the correct supply voltage .
Local display dark and no output signals	No contact between connecting cables and terminals.	Check the connection of the cables and correct if necessary.
Local display dark and no output signals	Terminals are not plugged into the main electronics module correctly.	Check terminals.
Local display dark and no output signals	Main electronics module is defective.	Order spare part (→ ☰ 106).
Local display dark and no output signals	The connector between the main electronics module and display module is not plugged in correctly.	Check the connection and correct if necessary.
Local display dark and no output signals	The connecting cable is not plugged in correctly.	1. Check the connection of the electrode cable and correct if necessary. 2. Check the connection of the coil current cable and correct if necessary.
Local display is dark, but signal output is within the valid range	Display is set too bright or too dark.	<ul style="list-style-type: none"> ▪ Set the display brighter by simultaneously pressing + . ▪ Set the display darker by simultaneously pressing + .
Local display is dark, but signal output is within the valid range	Display module is defective.	Order spare part (→ ☰ 106).
Backlighting of local display is red	Diagnostic event with "Alarm" diagnostic behavior has occurred.	Take remedial measures (→ ☰ 97)
Text on local display appears in a foreign language and cannot be understood.	Incorrect operating language is configured.	1. Press + for 2 s ("home position"). 2. Press .3. Set the desired language in the Language parameter.
Message on local display: "Communication Error" "Check Electronics"	Communication between the display module and the electronics is interrupted.	<ul style="list-style-type: none"> ▪ Check the cable and the connector between the main electronics module and display module. ▪ Order spare part (→ ☰ 106).

For output signals

Problem	Possible causes	Remedy
Signal output outside the valid range	Main electronics module is defective.	Order spare part (→ ☰ 106).
Device shows correct value on local display, but signal output is incorrect, though in the valid range.	Configuration error	Check and correct parameter configuration.
Device measures incorrectly.	Configuration error or device is operated outside the application.	1. Check and correct parameter configuration. 2. Observe limit values specified in the "Technical Data".

For access

Problem	Possible causes	Remedy
No write access to parameters	Hardware write protection enabled	Set the write protection switch on the main electronics module to the OFF position (→ 81).
No write access to parameters	Current user role has limited access authorization	1. Check user role (→ 57). 2. Enter correct customer-specific access code (→ 57).
No connection via EtherNet/IP	Device plug connected incorrectly	Check the pin assignment of the device plug .
Not connecting to Web server	Incorrect setting for the Ethernet interface of the computer	1. Check the properties of the Internet protocol (TCP/IP) (→ 59). 2. Check the network settings with the IT manager.
Not connecting to Web server	Web server disabled	Via the "FieldCare" operating tool check whether the Web server of the measuring device is enabled and enable it if necessary (→ 62).
Not connecting to Web server	The use of the proxy server is not disabled in the Web browser settings of the computer.	Disable the use of the proxy server in the Web browser settings of the computer. Using the example of MS Internet Explorer: 1. Under <i>Control Panel</i> open <i>Internet options</i> . 2. Select the <i>Connections</i> tab and then double-click <i>LAN settings</i> . 3. In the <i>LAN settings</i> disable the use of the proxy server and select <i>OK</i> to confirm.
Not connecting to Web server	Other network connections or programs are still active on the computer.	<ul style="list-style-type: none"> ▪ Make sure that no other network connections are established by the computer (also no WLAN) and close other programs with network access to the computer. ▪ If using a docking station for notebooks make sure that a network connection to another network is not active.
No or incomplete display of contents in the Web browser	<ul style="list-style-type: none"> ▪ JavaScript not enabled ▪ JavaScript cannot be enabled 	1. Enable JavaScript. 2. Enter <code>http://192.168.1.212/basic.html</code> as the IP address.
Web browser frozen and operation no longer possible	Data transfer active	Wait until data transfer or current action is finished.
Web browser frozen and operation no longer possible	Connection lost	1. Check cable connection and power supply. 2. Refresh the Web browser and restart if necessary.
Content of Web browser incomplete or difficult to read	Not using optimum version of Web server.	1. Use the correct Web browser version (→ 59). 2. Clear the Web browser cache and restart the Web browser.
Content of Web browser incomplete or difficult to read	Unsuitable view settings.	Change the font size/display ratio of the Web browser.

12.2 Diagnostic information via light emitting diodes

12.2.1 Transmitter

Various light emitting diodes (LEDs) on the main electronics module of the transmitter provide information on device status.

LED	Color	Meaning
Power	Off	Supply voltage is off or too low
	Green	Supply voltage is ok
Device status	Green	Device status is ok
	Flashing red	A device error of diagnostic behavior "Warning" has occurred
	Red	A device error of diagnostic behavior "Alarm" has occurred
	Alternately flashing red/ green	Boot loader is active
Network status	Off	Device has no EtherNet/IP address
	Green	Device's EtherNet/IP connection is active
	Flashing green	Device has EtherNet/IP address but no EtherNet/IP connection
	Red	EtherNet/IP address of the device has been assigned twice
	Flashing red	Device's EtherNet/IP connection is in timeout mode
Link/Activity	Orange	Link available but no activity
	Flashing orange	Activity present
Communication	Flashing white	
Alarm	Green	Measuring device is ok
	Flashing green	Measuring device not configured
	Off	Firmware error
	Red	Main error
	Flashing red	Error
	Flashing red/green	Start measuring device

12.3 Diagnostic information on local display

12.3.1 Diagnostic message

Faults detected by the self-monitoring system of the measuring device are displayed as a diagnostic message in alternation with the operational display.

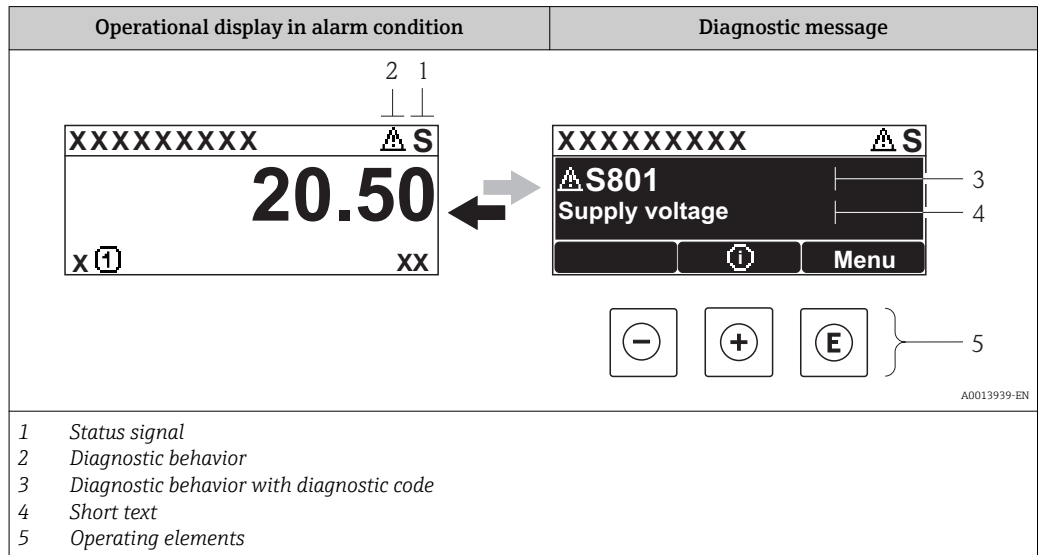

If two or more diagnostic events are pending simultaneously, only the message of the diagnostic event with the highest priority is shown.

- i** Other diagnostic events that have occurred can be called up in the **Diagnostics** menu:
 - Via parameters (→ 99)
 - Via submenus (→ 100)



Status signals

The status signals provide information on the state and reliability of the device by categorizing the cause of the diagnostic information (diagnostic event).

- i** The status signals are categorized according to VDI/VDE 2650 and NAMUR Recommendation NE 107: F = Failure, C = Function Check, S = Out of Specification, M = Maintenance Required

Symbol	Meaning
F <small>A0013956</small>	Failure A device error has occurred. The measured value is no longer valid.
C <small>A0013959</small>	Function check The device is in service mode (e.g. during a simulation).
S <small>A0013958</small>	Out of specification The device is operated: Outside its technical specification limits (e.g. outside the process temperature range)
M <small>A0013957</small>	Maintenance required Maintenance is required. The measured value remains valid.

Diagnostic behavior



Symbol	Meaning
 <small>A0013961</small>	Alarm <ul style="list-style-type: none"> ▪ Measurement is interrupted. ▪ Signal outputs and totalizers assume the defined alarm condition. ▪ A diagnostic message is generated. ▪ The background lighting changes to red.
 <small>A0013962</small>	Warning Measurement is resumed. The signal outputs and totalizers are not affected. A diagnostic message is generated.

Diagnostic information

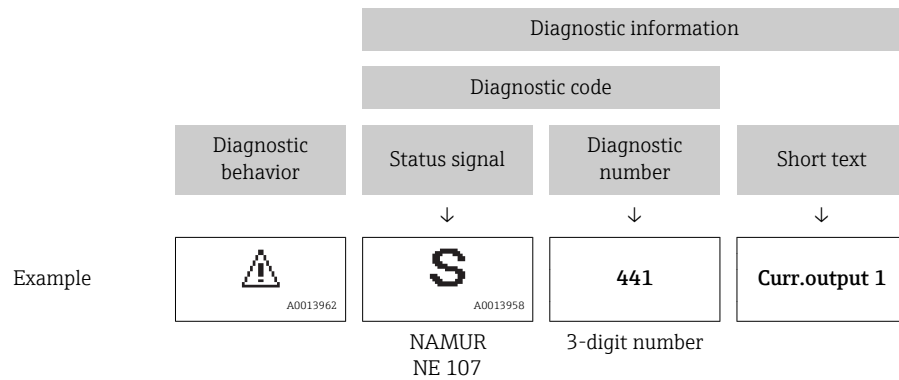
The fault can be identified using the diagnostic information. The short text helps you by providing information about the fault. In addition, the corresponding symbol for the diagnostic behavior is displayed in front of the diagnostic information on the local display.



Operating elements

Key	Meaning
 <small>A0013970</small>	Plus key <i>In a menu, submenu</i> Opens the message about the remedial measures.
 <small>A0013952</small>	Enter key <i>In a menu, submenu</i> Opens the operating menu.

12.3.2 Calling up remedial measures

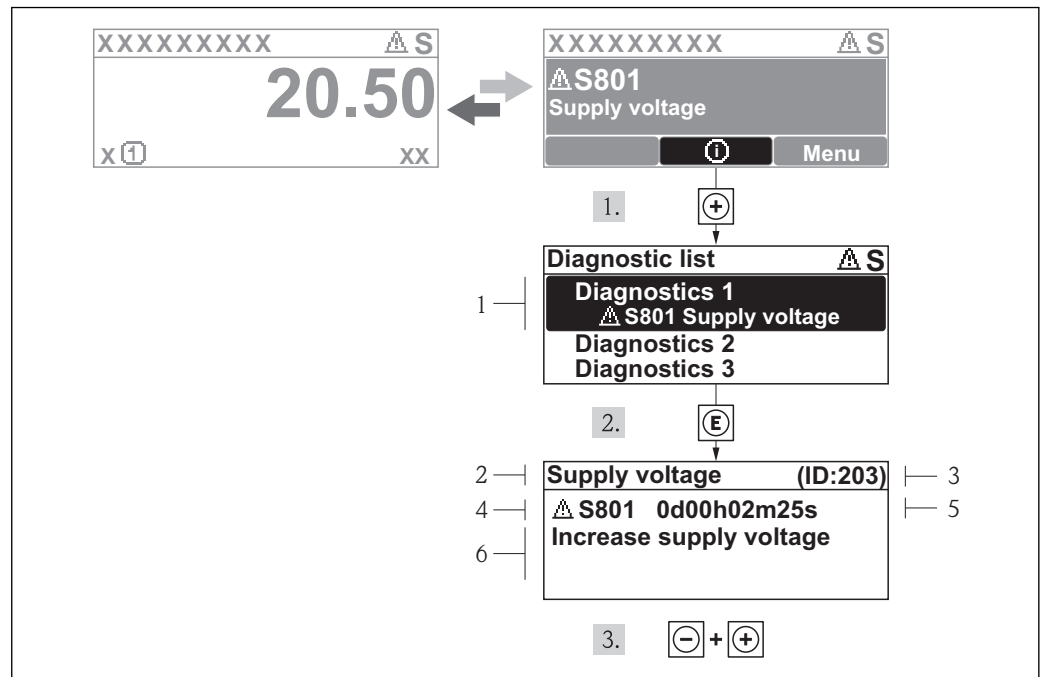

26 Message for remedial measures

- 1 Diagnostic information
- 2 Short text
- 3 Service ID
- 4 Diagnostic behavior with diagnostic code
- 5 Operation time of occurrence
- 6 Remedial measures

The user is in the diagnostic message.

1. Press \oplus (ⓘ symbol).
 - ↳ The **Diagnostic list** submenu opens.
2. Select the desired diagnostic event with \oplus or \ominus and press ⏎ .
 - ↳ The message for the remedial measures for the selected diagnostic event opens.
3. Press $\ominus + \oplus$ simultaneously.
 - ↳ The message for the remedial measures closes.

The user is in the **Diagnostics** menu at an entry for a diagnostics event, e.g. in the **Diagnostic list** submenu or the **Previous diagnostics** parameter.

1. Press ⏎ .
 - ↳ The message for the remedial measures for the selected diagnostic event opens.
2. Press $\ominus + \oplus$ simultaneously.
 - ↳ The message for the remedial measures closes.

12.4 Diagnostic information in the Web browser

12.4.1 Diagnostic options

Any faults detected by the measuring device are displayed in the Web browser on the home page once the user has logged on.

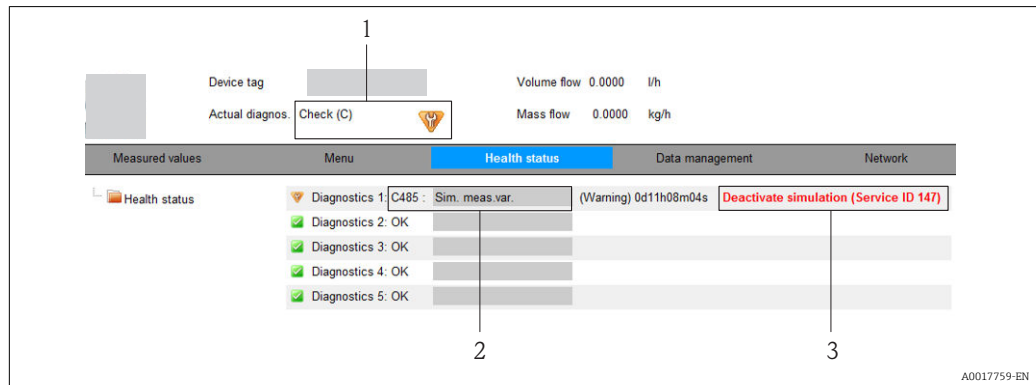





1 Status area with status signal
 2 Diagnostic information (→ 92)
 3 Remedial measures with Service ID

i Furthermore, diagnostic events that have occurred can be viewed in the **Diagnostics** menu:

- Via parameters (→ 99)
- Via submenus (→ 100)

Status signals

The status signals provide information on the state and reliability of the device by categorizing the cause of the diagnostic information (diagnostic event).

Symbol	Meaning
 A0017271	Failure A device error has occurred. The measured value is no longer valid.
 A0017278	Function check The device is in service mode (e.g. during a simulation).
 A0017277	Out of specification The device is operated: Outside its technical specification limits (e.g. outside the process temperature range)
 A0017276	Maintenance required Maintenance is required. The measured value is still valid.

i The status signals are categorized in accordance with VDI/VDE 2650 and NAMUR Recommendation NE 107.

12.4.2 Calling up remedy information

Remedy information is provided for every diagnostic event to ensure that problems can be rectified quickly. These measures are displayed in red along with the diagnostic event and the related diagnostic information.

12.5 Diagnostic information in FieldCare

12.5.1 Diagnostic options

Any faults detected by the measuring device are displayed on the home page of the operating tool once the connection has been established.

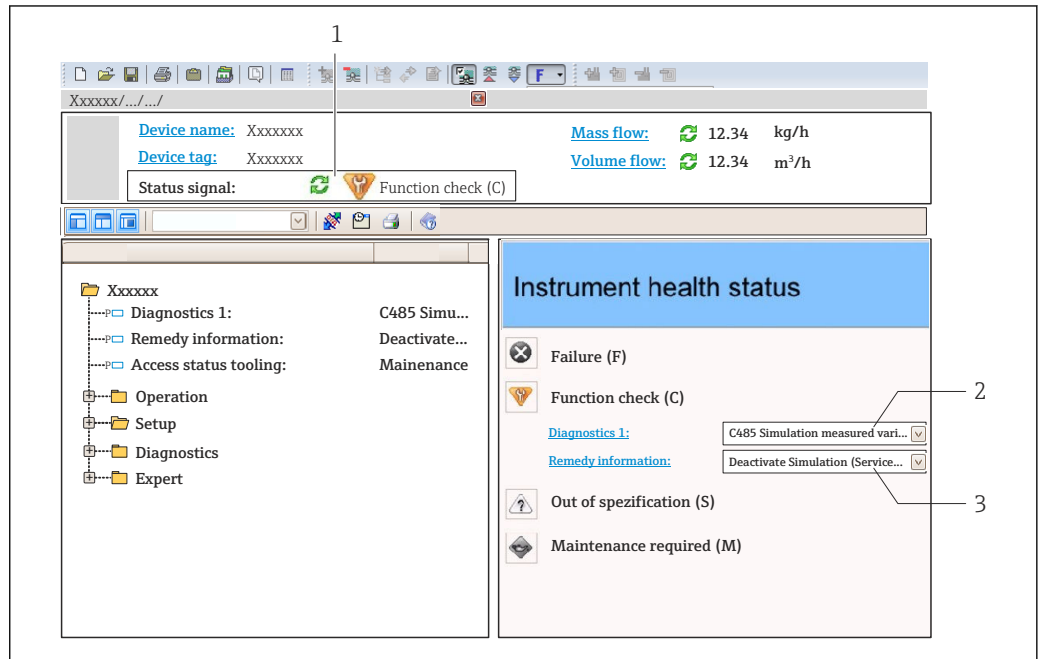

- 1 Status area with status signal (→ 91)
- 2 Diagnostic information (→ 92)
- 3 Remedial measures with Service ID

- i** Furthermore, diagnostic events that have occurred can be viewed in the **Diagnostics** menu:
 - Via parameters (→ 99)
 - Via submenu (→ 100)

Diagnostic information

The fault can be identified using the diagnostic information. The short text helps you by providing information about the fault. In addition, the corresponding symbol for the diagnostic behavior is displayed in front of the diagnostic information on the local display.

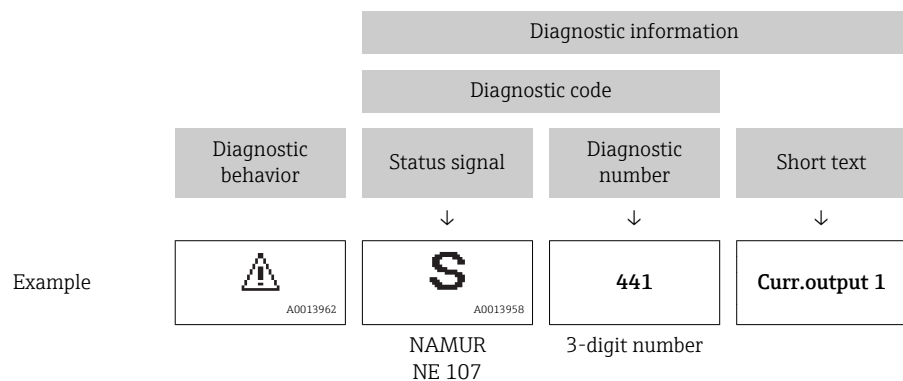

12.5.2 Calling up remedy information

Remedy information is provided for every diagnostic event to ensure that problems can be rectified quickly:

- On the home page
Remedy information is displayed in a separate field below the diagnostics information.
- In the **Diagnostics** menu
Remedy information can be called up in the working area of the user interface.

The user is in the **Diagnostics** menu.

1. Call up the desired parameter.
2. On the right in the working area, mouse over the parameter.
 - ↳ A tool tip with remedy information for the diagnostic event appears.

12.6 Diagnostic information via communication interface

12.6.1 Reading out diagnostic information

The current diagnostic event and associated diagnostic information can be read out via the input assembly (fix assembly):

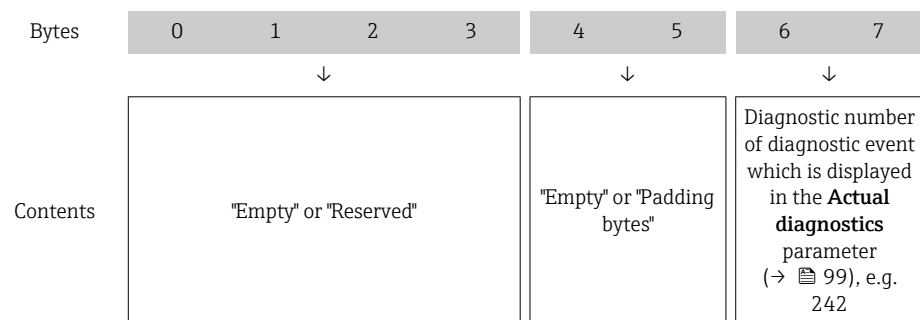

 For content of bytes 8 to 16 (→ ⓘ 112)

12.7 Adapting the diagnostic information

12.7.1 Adapting the diagnostic behavior

Each item of diagnostic information is assigned a specific diagnostic behavior at the factory. The user can change this assignment for certain diagnostics information in the **Diagnostic behavior** submenu .

"Expert" menu → System → Diagnostic handling → Diagnostic behavior



You can assign the following options to the diagnostic number as the diagnostic behavior:

Options	Description
Alarm	Measurement is interrupted. The totalizers assume the defined alarm condition. A diagnostic message is generated. The background lighting changes to red.
Warning	Measurement is resumed. The totalizers are not affected. A diagnostic message is generated.

Options	Description
Logbook entry only	The device continues to measure. The diagnostic message is entered in the Event logbook (events list) submenu only and is not displayed in alternation with the measured value display.
Off	The diagnostic event is ignored, and no diagnostic message is generated or entered.

12.8 Overview of diagnostic information

 The amount of diagnostic information and the number of measured variables affected increase if the measuring device has one or more application packages.

 In the case of some items of diagnostic information, the status signal and the diagnostic behavior can be changed. Adapt the diagnostic information (→  96)

Diagnostic number	Short text	Remedy instructions	Status signal [from the factory]	Diagnostic behavior [from the factory]
Diagnostic of sensor				
004	Sensor	1. Change sensor 2. Contact service	S	Alarm
022	Sensor temperature	1. Change main electronic module 2. Change sensor	F	Alarm
043	Sensor short circuit	1. Check sensor and cable 2. Change sensor or cable	S	Warning
062	Sensor connection	1. Check sensor connections 2. Contact service	F	Alarm
082	Data storage	1. Check module connections 2. Contact service	F	Alarm
083	Memory content	1. Restart device 2. Contact service	F	Alarm
190	Special event 1	Contact service	F	Alarm
Diagnostic of electronic				
201	Device failure	1. Restart device 2. Contact service	F	Alarm
222	Electronic drift	Change main electronic module	F	Alarm
242	Software incompatible	1. Check software 2. Flash or change main electronics module	F	Alarm
252	Modules incompatible	1. Check electronic modules 2. Change electronic modules	F	Alarm
262	Module connection	1. Check module connections 2. Change main electronics	F	Alarm
270	Main electronic failure	Change main electronic module	F	Alarm
271	Main electronic failure	1. Restart device 2. Change main electronic module	F	Alarm
272	Main electronic failure	1. Restart device 2. Contact service	F	Alarm
273	Main electronic failure	Change electronic	F	Alarm
281	Electronic initialization	Firmware update active, please wait!	F	Alarm
283	Memory content	1. Reset device 2. Contact service	F	Alarm

Diagnostic number	Short text	Remedy instructions	Status signal [from the factory]	Diagnostic behavior [from the factory]
302	Device verification active	Device verification active, please wait.	C	Warning
311	Electronic failure	1. Reset device 2. Contact service	F	Alarm
311	Electronic failure	1. Do not reset device 2. Contact service	M	Warning
322	Electronic drift	1. Perform verification manually 2. Change electronic	S	Warning
382	Data storage	1. Insert DAT module 2. Change DAT module	F	Alarm
383	Memory content	1. Restart device 2. Check or change DAT module 3. Contact service	F	Alarm
390	Special event 2	Contact service	F	Alarm
Diagnostic of configuration				
410	Data transfer	1. Check connection 2. Retry data transfer	F	Alarm
411	Up-/download active	Up-/download active, please wait	C	Warning
437	Configuration incompatible	1. Restart device 2. Contact service	F	Alarm
438	Dataset	1. Check data set file 2. Check device configuration 3. Up- and download new configuration	M	Warning
453	Flow override	Deactivate flow override	C	Warning
484	Simulation failure mode	Deactivate simulation	C	Alarm
485	Simulation measured variable	Deactivate simulation	C	Warning
495	Simulation diagnostic event	Deactivate simulation	C	Warning
500	Electrode 1 potential exceeded	1. Check process cond. 2. Increase system pressure	F	Alarm
500	Electrode difference voltage too high	1. Check process cond. 2. Increase system pressure	F	Alarm
530	Electrode cleaning is running	1. Check process cond. 2. Increase system pressure	C	Warning
531	Empty pipe detection	Execute EPD adjustment	S	Warning
537	Configuration	1. Check IP addresses in network 2. Change IP address	F	Warning
590	Special event 3	Contact service	F	Alarm
Diagnostic of process				
832	Electronic temperature too high	Reduce ambient temperature	S	Warning ¹⁾
833	Electronic temperature too low	Increase ambient temperature	S	Warning ¹⁾
834	Process temperature too high	Reduce process temperature	S	Warning ¹⁾
835	Process temperature too low	Increase process temperature	S	Warning ¹⁾



Diagnostic number	Short text	Remedy instructions	Status signal [from the factory]	Diagnostic behavior [from the factory]
842	Process limit	Low flow cut off active! 1. Check low flow cut off configuration	S	Warning
862	Empty pipe	1. Check for gas in process 2. Adjust empty pipe detection	S	Warning
882	Input signal	1. Check input configuration 2. Check external device or process conditions	F	Alarm
937	EMC interference	Change main electronic module	S	Warning ¹⁾
938	EMC interference	1. Check ambient conditions regarding EMC influence 2. Change main electronic module	F	Alarm
990	Special event 4	Contact service	F	Alarm

1) Diagnostic status is changeable.

12.9 Pending diagnostic events

The **Diagnostics** menu allows the user to view the current diagnostic event and the previous diagnostic event separately.

 To call up the measures to rectify a diagnostic event:

- Via local display (→  93)
- Via Web browser (→  94)
- Via "FieldCare" operating tool (→  96)

 Other pending diagnostic events can be displayed in the **Diagnostic list** submenu (→  100)

Navigation

"Diagnostics" menu

Structure of the submenu

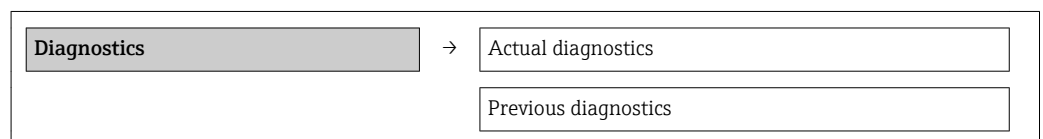

Parameter overview with brief description

Parameter	Prerequisite	Description	User interface	Factory setting
Actual diagnostics	1 diagnostic event has occurred.	Displays the current diagnostic event along with the diagnostic information.  If two or more messages occur simultaneously, the message with the highest priority is shown on the display.	Symbol for diagnostic behavior, diagnostic code and short message.	–
Previous diagnostics	2 diagnostic events have already occurred.	Displays the diagnostic event that occurred prior to the current diagnostic event along with the diagnostic information.	Symbol for diagnostic behavior, diagnostic code and short message.	–

12.10 Diagnostic list

In the **Diagnostic list** submenu, up to 5 currently pending diagnostic events can be displayed along with the related diagnostic information. If more than 5 diagnostic events are pending, the events with the highest priority are shown on the display.

Navigation path

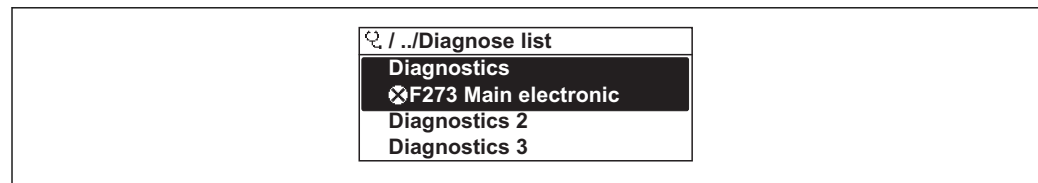

Diagnostics menu → **Diagnostic list** submenu



A0014006-EN

 27 Illustrated using the example of the local display

 To call up the measures to rectify a diagnostic event:

- Via local display (→  93)
- Via Web browser (→  94)
- Via "FieldCare" operating tool (→  96)

12.11 Event logbook

12.11.1 Event history

A chronological overview of the event messages that have occurred is provided in the **Events list** submenu.

Navigation path

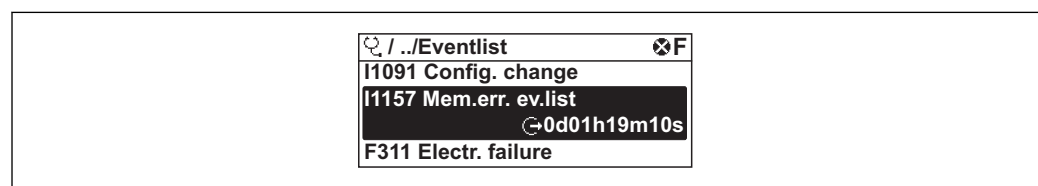

"Diagnostics" menu → Event logbook → Events list





A0014006-EN

 28 Illustrated using the example of the local display



The event history includes entries for:

- Diagnostic events (→  97)
- Information events (→  101)

In addition to the operation time of its occurrence, each event is also assigned a symbol that indicates whether the event has occurred or is ended:

- Diagnostic event
 - : Event has occurred
 - : Event has ended
- Information event
 - : Event has occurred

 To call up the measures to rectify a diagnostic event:

- Via local display (→  93)
- Via Web browser (→  94)
- Via "FieldCare" operating tool (→  96)

 For filtering the displayed event messages (→  101)

12.11.2 Filtering the event logbook

Using the **Filter options** parameter, you can define which category of event messages is displayed in the **Events list** submenu.

Navigation path

"Diagnostics" menu → Event logbook → Filter options

Filter categories

- All
- Failure (F)
- Function check (C)
- Out of specification (S)
- Maintenance required (M)
- Information (I)

12.11.3 Overview of information events

Unlike a diagnostic event, an information event is displayed in the event logbook only and not in the diagnostic list.

Info number	Info name
I1000	----- (Device ok)
I1089	Power on
I1090	Configuration reset
I1091	Configuration changed
I1092	Trend data deleted
I1110	Write protection switch changed
I1137	Electronic changed
I1151	History reset
I1155	Reset electronic temperature
I1156	Memory error trend
I1157	Memory error event list
I1185	Display backup done
I1186	Restore via display done
I1187	Settings downloaded with display
I1188	Display data cleared

Info number	Info name
I1189	Backup compared
I1256	Display: access status changed
I1264	Safety sequence aborted
I1335	Firmware changed
I1351	Empty pipe detection adjustment failure
I1353	Empty pipe detection adjustment ok
I1361	Wrong web server login
I1397	Fieldbus: access status changed
I1398	CDI: access status changed
I1444	Device verification passed
I1445	Device verification failed
I1457	Failed: Measured error verification
I1459	Failed: I/O module verification
I1461	Failed: Sensor verification
I1462	Failed: Sensor electronic module verific.

12.12 Resetting the measuring device

Using the **Device reset** parameter it is possible to reset the entire device configuration or some of the configuration to a defined state.

"Setup" menu → Advanced setup → Administration

Function scope of "Device reset" parameter

Options	Description
Cancel	No action is executed and the user exits the parameter.
To delivery settings	Every parameter for which a customer-specific default setting was ordered is reset to this customer-specific value. All other parameters are reset to the factory setting.  This option is not visible if no customer-specific settings have been ordered.
Restart device	The restart resets every parameter whose data are in the volatile memory (RAM) to the factory setting (e.g. measured value data). The device configuration remains unchanged.
History reset	Every parameter is reset to its factory setting.

12.13 Device information

The **Device information** submenu contains all the parameters that display different information for identifying the device.

Navigation

"Diagnostics" menu → Device information

Device information	→	Device tag
		Serial number
		Firmware version



Device name
Order code
Extended order code 1
Extended order code 2
Extended order code 3
ENP version
IP address
Subnet mask
Default gateway

Parameter overview with brief description

Parameter	Description	User interface / User entry	Factory setting
Device tag	Enter tag for measuring point.	Max. 32 characters, such as letters, numbers or special characters (e.g. @, %, /)	Promag 400
Serial number	Displays the serial number of the measuring device.	Max. 11-digit character string comprising letters and numbers.	79AFF16000
Firmware version	Displays the device firmware version installed.	Character string with the following format: xx.yy.zz	01.01
Device name	Displays the name of the transmitter.	Character string composed of letters, numbers and certain punctuation marks.	Promag 400
Order code	Displays the device order code.	Character string composed of letters, numbers and certain punctuation marks	-
Extended order code 1	Displays the 1st part of the extended order code.	Character string	-
Extended order code 2	Displays the 2nd part of the extended order code.	Character string	-
Extended order code 3	Displays the 3rd part of the extended order code.	Character string	-
ENP version	Displays the version of the electronic nameplate.	Character string in the format xx.yy.zz	2.02.00
IP address	Displays the IP address of the Web server of the measuring device.	4 octet: 0 to 255 (in the particular octet)	192.168.1.212
Subnet mask	Displays the subnet mask.	4 octet: 0 to 255 (in the particular octet)	255.255.255.0
Default gateway	Displays the default gateway.	4 octet: 0 to 255 (in the particular octet)	0.0.0.0

12.14 Firmware history

Release date	Firmware version	Order code for "Firmware version"	Firmware changes	Documentation type	Documentation
10.2013	01.00.00	Option 77	Original firmware	Operating Instructions	BA01212D/06/EN/01.13
05.2014	01.01.zz	Option 74	Update	Operating Instructions	BA01212D/06/EN/02.14

 Flashing the firmware to the current version or to the previous version is possible via the service interface (CDI) (→  123).

 For the compatibility of the firmware version with the previous version, the installed device description files and operating tools, observe the information about the device in the "Manufacturer's information" document.

 The manufacturer's information is available:

- In the Download Area of the Endress+Hauser Internet site: www.endress.com → Download
- Specify the following details:
 - Text search: Manufacturer's information
 - Search range: documentation

13 Maintenance

13.1 Maintenance tasks

No special maintenance work is required.

13.1.1 Exterior cleaning

When cleaning the exterior of measuring devices, always use cleaning agents that do not attack the surface of the housing or the seals.

WARNING

Cleaning agents can damage the plastic transmitter housing!

- ▶ Do not use high-pressure steam.
- ▶ Only use the permitted cleaning agents specified.

Permitted cleaning agents for the plastic transmitter housing

- Commercially available household cleaners
- Methyl alcohol or isopropyl alcohol
- Mild soap solutions

13.1.2 Interior cleaning

No interior cleaning is planned for the device.

13.1.3 Replacing seals

The sensor's seals (particularly aseptic molded seals) must be replaced periodically.

The interval between changes depends on the frequency of the cleaning cycles, the cleaning temperature and the medium temperature.

Replacement seals (accessory) (→  126)

13.2 Measuring and test equipment

Endress+Hauser offers a wide variety of measuring and test equipment, such as W@M or device tests.

 Your Endress+Hauser Sales Center can provide detailed information on the services.

 For a list of some of the measuring and test equipment, refer to the "Accessories" chapter of the "Technical Information" document for the device.

13.3 Endress+Hauser services

Endress+Hauser offers a wide variety of services for maintenance such as recalibration, maintenance service or device tests.

 Your Endress+Hauser Sales Center can provide detailed information on the services.

14 Repair

14.1 General notes

Repair and conversion concept

The Endress+Hauser repair and conversion concept provides for the following:

- The measuring devices have a modular design.
- Spare parts are grouped into logical kits with the associated Installation Instructions.
- Repairs are carried out by Endress+Hauser Service or by correspondingly trained customers.
- Certified devices can be converted into other certified devices by Endress+Hauser Service or at the factory only.

Notes for repair and conversion

For repair and modification of a measuring device, observe the following notes:

- Use only original Endress+Hauser spare parts.
- Carry out the repair according to the Installation Instructions.
- Observe the applicable standards, federal/national regulations, Ex documentation (XA) and certificates.
- Document every repair and each conversion and enter them into the *W@M* life cycle management database.

14.2 Spare parts

 Measuring device serial number:

- Is located on the nameplate of the device.
- Can be read out via the **Serial number** parameter in the **Device information** submenu (→  102).

14.3 Endress+Hauser services

 Contact your Endress+Hauser Sales Center for information on services and spare parts.

14.4 Return

The measuring device must be returned if repairs or a factory calibration are required, or if the wrong measuring device has been ordered or delivered. According to legal regulations, Endress+Hauser, as an ISO-certified company, is required to follow certain procedures when handling returned products that are in contact with medium.

To ensure swift, safe and professional device returns, please read the return procedures and conditions on the Endress+Hauser website at

www.services.endress.com/return-material

14.5 Disposal

14.5.1 Removing the measuring device

1. Switch off the device.
2. **WARNING!** Danger to persons from process conditions. Beware of hazardous process conditions such as pressure in the measuring device, high temperatures or aggressive fluids.

Carry out the mounting and connection steps from the chapters "Mounting the measuring device" and "Connecting the measuring device" in the logically reverse sequence. Observe the safety instructions.

14.5.2 Disposing of the measuring device

⚠ WARNING

Danger to personnel and environment from fluids that are hazardous to health.

- ▶ Ensure that the measuring device and all cavities are free of fluid residues that are hazardous to health or the environment, e.g. substances that have permeated into crevices or diffused through plastic.

Observe the following notes during disposal:

- Observe valid federal/national regulations.
- Ensure proper separation and reuse of the device components.

15 Accessories

Various accessories, which can be ordered with the device or subsequently from Endress+Hauser, are available for the device. Detailed information on the order code in question is available from your local Endress+Hauser sales center or on the product page of the Endress+Hauser website: www.endress.com.

15.1 Device-specific accessories

15.1.1 For the transmitter

Accessories	Description
Display protection	Is used to protect the display against impact or scoring from sand in desert areas.  For details, see Special Documentation SD00333F
Connecting cable for remote version	Coil current and electrode cables, various lengths, reinforced cables available on request.
Post mounting kit	Post mounting kit for transmitter.
Compact → remote conversion kit	For converting a compact device version to a remote device version.

15.1.2 For the sensor

Accessories	Description
Mounting kit	Consists of: <ul style="list-style-type: none"> ▪ 2 process connections ▪ Threaded fasteners ▪ Seals

15.2 Communication-specific accessories

Accessories	Description
-------------	-------------

15.3 Service-specific accessories

Accessories	Description
Applicator	Software for selecting and sizing Endress+Hauser measuring devices: <ul style="list-style-type: none"> ▪ Calculation of all the necessary data for identifying the optimum flowmeter: e.g. nominal diameter, pressure loss, accuracy or process connections. ▪ Graphic illustration of the calculation results Administration, documentation and access to all project-related data and parameters over the entire life cycle of a project. Applicator is available: <ul style="list-style-type: none"> ▪ Via the Internet: https://wapps.endress.com/applicator ▪ On CD-ROM for local PC installation.

W@M	<p>Life cycle management for your plant</p> <p>W@M supports you with a wide range of software applications over the entire process: from planning and procurement, to the installation, commissioning and operation of the measuring devices. All the relevant device information, such as the device status, spare parts and device-specific documentation, is available for every device over the entire life cycle.</p> <p>The application already contains the data of your Endress+Hauser device. Endress+Hauser also takes care of maintaining and updating the data records.</p> <p>W@M is available:</p> <ul style="list-style-type: none"> ▪ Via the Internet: www.endress.com/lifecyclemanagement ▪ On CD-ROM for local PC installation.
FieldCare	<p>FDT-based plant asset management tool from Endress+Hauser.</p> <p>It can configure all smart field units in your system and helps you manage them. By using the status information, it is also a simple but effective way of checking their status and condition.</p> <p> For details, see Operating Instructions BA00027S and BA00059S</p>

15.4 System components

Accessories	Description
Memograph M graphic display recorder	<p>The Memograph M graphic display recorder provides information on all relevant measured variables. Measured values are recorded correctly, limit values are monitored and measuring points analyzed. The data are stored in the 256 MB internal memory and also on a SD card or USB stick.</p> <p> For details, see "Technical Information" TI00133R and Operating Instructions BA00247R</p>

16 Technical data

16.1 Application

The measuring device described in these Instructions is intended only for flow measurement of liquids with a minimum conductivity of 5 µS/cm.

Depending on the version ordered, the measuring device can also measure potentially explosive, flammable, poisonous and oxidizing media.

To ensure that the device remains in proper operating condition for its service life, use the measuring device only for media against which the process-wetted materials are adequately resistant.

16.2 Function and system design

Measuring principle Electromagnetic flow measurement on the basis of *Faraday's law of magnetic induction*.

Measuring system The device consists of a transmitter and a sensor.
 Two device versions are available:
 ■ Compact version - the transmitter and sensor form a mechanical unit.
 ■ Remote version – the transmitter and sensor are mounted separately from one another.
 For information on the structure of the device (→  12)

16.3 Input

Measured variable **Direct measured variables**
 Volume flow (proportional to induced voltage)

Calculated measured variables
 Mass flow

Measuring range Typically $v = 0.01$ to 10 m/s (0.03 to 33 ft/s) with the specified accuracy
 Electrical conductivity: 5 to 10 000 µS/cm/cm

Flow characteristic values in SI units

Nominal diameter		Recommended flow min./max. full scale value ($v \sim 0.3/10$ m/s) [dm ³ /min]	Factory settings		
[mm]	[in]		Full scale value current output ($v \sim 2.5$ m/s) [dm ³ /min]	Pulse value (~ 2 pulse/s) [dm ³]	Low flow cut off ($v \sim 0.04$ m/s) [dm ³ /min]
25	1	9 to 300	75	0.5	1
40	1 ½	25 to 700	200	1.5	3
50	2	35 to 1 100	300	2.5	5
65	–	60 to 2 000	500	5	8
80	3	90 to 3 000	750	5	12
100	4	145 to 4 700	1 200	10	20

Flow characteristic values in US units

Nominal diameter		Recommended flow min./max. full scale value (v ~ 0.3/10 m/s)	Factory settings		
[in]	[mm]		Full scale value current output (v ~ 2.5 m/s)	Pulse value (~ 2 pulse/s)	Low flow cut off (v ~ 0.04 m/s)
		[gal/min]	[gal/min]	[gal]	[gal/min]
1	25	2.5 to 80	18	0.2	0.25
1 ½	40	7 to 190	50	0.5	0.75
2	50	10 to 300	75	0.5	1.25
-	65	16 to 500	130	1	2
3	80	24 to 800	200	2	2.5
4	100	40 to 1250	300	2	4

Recommended measuring range

"Flow limit" section (→  117)

Operable flow range Over 1000 : 1

Input signal

External measured values

 Various pressure transmitters and temperature measuring devices can be ordered from Endress+Hauser: see "Accessories" section (→  109)

It is recommended to read in external measured values to calculate the following measured variables:

Corrected volume flow

Fieldbus

The measured values are written from the automation system to the measuring device via EtherNet/IP.

16.4 Output

Output signal

EtherNet/IP

Standards	In accordance with IEEE 802.3
-----------	-------------------------------

Signal on alarm

Depending on the interface, failure information is displayed as follows:

EtherNet/IP

Device diagnostics	Device condition can be read out in Input Assembly
--------------------	--

Local display

Plain text display	With information on cause and remedial measures
Backlight	Red backlighting indicates a device error.

 Status signal as per NAMUR recommendation NE 107

Operating tool

- Via digital communication:
EtherNet/IP
- Via service interface

Plain text display	With information on cause and remedial measures
---------------------------	---

Web browser

Plain text display	With information on cause and remedial measures
---------------------------	---

Light emitting diodes (LED)

Status information	Status indicated by various light emitting diodes The following information is displayed depending on the device version: <ul style="list-style-type: none"> ■ Supply voltage active ■ Data transmission active ■ Device alarm/error has occurred ■ EtherNet/IP network available ■ EtherNet/IP connection established
---------------------------	--

Low flow cut off The switch points for low flow cut off are user-selectable.

Galvanic isolation The following connections are galvanically isolated from each other:

- Outputs
- Power supply

Protocol-specific data **EtherNet/IP**

Protocol	<ul style="list-style-type: none"> ■ The CIP Networks Library Volume 1: Common Industrial Protocol ■ The CIP Networks Library Volume 2: EtherNet/IP Adaptation of CIP
Communication type	<ul style="list-style-type: none"> ■ 10Base-T ■ 100Base-TX
Device profile	Generic device (product type: 0x2B)
Manufacturer ID	0x49E
Device type ID	0x1067
Baud rates	Automatic ¹⁰ / ₁₀₀ Mbit with half-duplex and full-duplex detection
Polarity	Auto-polarity for automatic correction of crossed TxD and RxD pairs
Supported CIP connections	Max. 3 connections
Explicit connections	Max. 6 connections
I/O connections	Max. 6 connections (scanner)
Configuration options for measuring device	<ul style="list-style-type: none"> ■ DIP switches on the electronics module for IP addressing ■ Manufacturer-specific software (FieldCare) ■ Add-on Profile Level 3 for Rockwell Automation control systems ■ Web browser ■ Electronic Data Sheet (EDS) integrated in the measuring device
Configuration of the EtherNet interface	<ul style="list-style-type: none"> ■ Speed: 10 MBit, 100 MBit, auto (factory setting) ■ Duplex: half-duplex, full-duplex, auto (factory setting)

Configuration of the device address	<ul style="list-style-type: none"> ■ DIP switches on the electronics module for IP addressing (last octet) ■ DHCP ■ Manufacturer-specific software (FieldCare) ■ Add-on Profile Level 3 for Rockwell Automation control systems ■ Web browser ■ EtherNet/IP tools, e.g. RSLinx (Rockwell Automation) 		
Device Level Ring (DLR)	No		
Fix Input			
RPI	5 ms to 10 s (factory setting: 20 ms)		
Exclusive Owner Multicast		Instance	Size [byte]
	Instance configuration:	0x68	398
	O → T configuration:	0x66	56
	T → O configuration:	0x64	32
Exclusive Owner Multicast		Instance	Size [byte]
	Instance configuration:	0x69	-
	O → T configuration:	0x66	56
	T → O configuration:	0x64	32
Input only Multicast		Instance	Size [byte]
	Instance configuration:	0x68	398
	O → T configuration:	0xC7	-
	T → O configuration:	0x64	32
Input only Multicast		Instance	Size [byte]
	Instance configuration:	0x69	-
	O → T configuration:	0xC7	-
	T → O configuration:	0x64	32
Input Assembly	<ul style="list-style-type: none"> ■ Current device diagnostics ■ Volume flow ■ Mass flow ■ Totalizer 1 ■ Totalizer 2 ■ Totalizer 3 		
Configurable Input			
RPI	5 ms to 10 s (factory setting: 20 ms)		
Exclusive Owner Multicast		Instance	Size [byte]
	Instance configuration:	0x68	398
	O → T configuration:	0x66	56
	T → O configuration:	0x65	88
Exclusive Owner Multicast		Instance	Size [byte]
	Instance configuration:	0x69	-
	O → T configuration:	0x66	56
	T → O configuration:	0x65	88
Input only Multicast		Instance	Size [byte]
	Instance configuration:	0x68	398
	O → T configuration:	0xC7	-
	T → O configuration:	0x65	88
Input only Multicast		Instance	Size [byte]
	Instance configuration:	0x69	-

	O → T configuration:	0xC7	-
	T → O configuration:	0x65	88
Configurable Input Assembly	<ul style="list-style-type: none"> ▪ Volume flow ▪ Mass flow ▪ Electronic temperature ▪ Totalizer 1 to 3 ▪ Flow velocity ▪ Volume flow unit ▪ Mass flow unit ▪ Temperature unit ▪ Unit totalizer 1-3 ▪ Flow velocity unit ▪ Verification result ▪ Verification status <p> The range of options increases if the measuring device has one or more application packages.</p>		
Fix Output			
Output Assembly	<ul style="list-style-type: none"> ▪ Activation of reset totalizers 1-3 ▪ Activation of reference density compensation ▪ Reset totalizers 1-3 ▪ External density ▪ Density unit ▪ Activation verification ▪ Start verification 		
Configuration			
Configuration Assembly	<p>Only the most common configurations are listed below.</p> <ul style="list-style-type: none"> ▪ Software write protection ▪ Mass flow unit ▪ Mass unit ▪ Volume flow unit ▪ Volume unit ▪ Density unit ▪ Temperature unit ▪ Totalizer 1-3: <ul style="list-style-type: none"> - Assignment - Unit - Measuring mode - Failure mode ▪ Alarm delay 		

16.5 Power supply

Terminal assignment (→  32)

Pin assignment, device plug (→  33)

Supply voltage

Transmitter

Order code for "Power supply"	Terminal voltage	Frequency range
Option L	AC100 to 240 V	50/ 60 Hz, ±4 Hz
	AC/DC24 V	50/ 60 Hz, ±4 Hz

Power consumption	Order code for "Output"	Maximum Power consumption
	Option N	30 VA/8 W

Current consumption	Transmitter		
	Order code for "Power supply"	Maximum Current consumption	Maximum switch-on current
	Option L: AC 100 to 240 V	145 mA	25 A (< 5 ms)
	Option L: AC/DC 24 V	350 mA	27 A (< 5 ms)

Power supply failure	<ul style="list-style-type: none"> ■ Totalizers stop at the last value measured. ■ Configuration is retained in the plug-in memory (HistoROM DAT). ■ Error messages (incl. total operated hours) are stored.
----------------------	---

Electrical connection	(→  35)
-----------------------	--

Potential equalization	(→  38)
------------------------	--

Terminals	Transmitter
	<ul style="list-style-type: none"> ■ Supply voltage cable: plug-in spring terminals for wire cross-sections 0.5 to 2.5 mm² (20 to 14 AWG) ■ Signal cable: plug-in spring terminals for wire cross-sections 0.5 to 2.5 mm² (20 to 14 AWG) ■ Electrode cable: spring terminals for wire cross-sections 0.5 to 2.5 mm² (20 to 14 AWG) ■ Coil current cable: spring terminals for wire cross-sections 0.5 to 2.5 mm² (20 to 14 AWG)
	Sensor connection housing
	Spring terminals for wire cross-sections 0.5 to 2.5 mm ² (20 to 14 AWG)

Cable entries	Cable entry thread
	<ul style="list-style-type: none"> ■ M20 x 1.5 ■ Via adapter: <ul style="list-style-type: none"> – NPT ½" – G ½"
	Cable gland
	<ul style="list-style-type: none"> ■ For standard cable: M20 × 1.5 with cable ϕ6 to 12 mm (0.24 to 0.47 in) ■ For reinforced cable: M20 × 1.5 with cable ϕ9.5 to 16 mm (0.37 to 0.63 in)
	 If metal cable entries are used, use a grounding plate.

Cable specification	(→  30)
---------------------	--

16.6 Performance characteristics

Reference operating conditions	In accordance with DIN EN 29104
	<ul style="list-style-type: none"> ■ Fluid temperature: +28±2 °C (+82±4 °F) ■ Ambient temperature range: +22±2 °C (+72±4 °F) ■ Warm-up period: 30 min

Installation

- Inlet run > 10 × DN
- Outlet run > 5 × DN
- Sensor and transmitter grounded.
- The sensor is centered in the pipe.

Maximum measured error

Error limits under reference operating conditions

o.r. = of reading

Volume flow

±0.5 % o.r. ± 1 mm/s (0.04 in/s)

 Fluctuations in the supply voltage do not have any effect within the specified range.

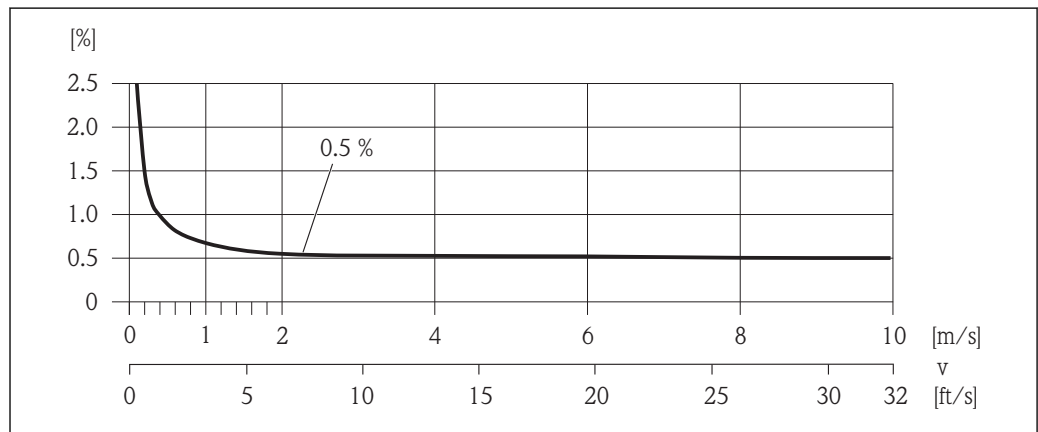

 29 Maximum measured error in % o.r.

Repeatability

o.r. = of reading

Volume flow

Max. ±0.1 % o.r. ± 0.5 mm/s (0.02 in/s)

16.7 Installation

"Mounting requirements" (→  17)

16.8 Environment

Ambient temperature range

(→  19)







Storage temperature

The storage temperature corresponds to the operating temperature range of the measuring transmitter and the appropriate measuring sensors.

- Protect the measuring device against direct sunlight during storage in order to avoid unacceptably high surface temperatures.
- Select a storage location where moisture cannot collect in the measuring device as fungus or bacteria infestation can damage the liner.
- If protection caps or protective covers are mounted these should never be removed before installing the measuring device.

Degree of protection	<p>Transmitter</p> <ul style="list-style-type: none"> ■ As standard: IP66/67, type 4X enclosure ■ When housing is open: IP20, type 1 enclosure <p>Sensor</p> <p>As standard: IP66/67, type 4X enclosure</p>
Shock resistance	Acceleration up to 2 g following IEC 60068-2-6
Vibration resistance	Acceleration up to 2 g following IEC 60068-2-6
Mechanical load	<ul style="list-style-type: none"> ■ Protect the transmitter housing against mechanical effects, such as shock or impact; the use of the remote version is sometimes preferable. ■ Never use the transmitter housing as a ladder or climbing aid.
Electromagnetic compatibility (EMC)	<ul style="list-style-type: none"> ■ As per IEC/EN 61326 and NAMUR Recommendation 21 (NE 21) ■ Complies with emission limits for industry as per EN 55011 (Class A) <p> For details refer to the Declaration of Conformity.</p>

16.9 Process

Medium temperature range	0 to +60 °C (+32 to +140 °F) for polyamide
Pressure-temperature ratings	<p> An overview of the pressure-temperature ratings for the process connections is provided in the "Technical Information" document</p>
Pressure tightness	Measuring tube: 0 mbar abs. (0 psi abs.) at a medium temperature of ≤ +60 °C (+140 °F)
Flow limit	<p>The diameter of the pipe and the flow rate determine the nominal diameter of the sensor. The optimum velocity of flow is between 2 to 3 m/s (6.56 to 9.84 ft/s). Also match the velocity of flow (v) to the physical properties of the fluid:</p> <ul style="list-style-type: none"> ■ $v < 2$ m/s (6.56 ft/s): for abrasive fluids (e.g. potter's clay, lime milk, ore slurry) ■ $v > 2$ m/s (6.56 ft/s): for fluids producing buildup (e.g. wastewater sludges) <p> A necessary increase in the flow velocity can be achieved by reducing the sensor nominal diameter.</p> <p> For an overview of the measuring range full scale values, see the "Measuring range" section (→  110)</p>
Pressure loss	<ul style="list-style-type: none"> ■ No pressure loss occurs if the sensor is installed in a pipe with the same nominal diameter. ■ Pressure losses for configurations incorporating adapters according to DIN EN 545 (→  20)
System pressure	(→  20)
Vibrations	(→  20)

16.10 Mechanical construction

Design, dimensions



For the dimensions and installation lengths of the device, see the "Technical Information" document, "Mechanical construction" section

Weight

Compact version

Weight data:

- Including the transmitter
 - Order code for "Housing", option M, Q: 1.3 kg (2.9 lbs)
 - Order code for "Housing", option A, R: 2.0 kg (4.4 lbs)
- Excluding packaging material

Weight in SI units

EN 1092-1 (DIN 2501), JIS B2220		
DN [mm]	Weight [kg]	
	Order code for "Housing", option M, Q: Polycarbonate plastic	Order code for "Housing", option A, R: Aluminum, AlSi10Mg, coated
25	2.50	3.20
40	3.10	3.80
50	3.90	4.60
65	4.70	5.40
80	5.70	6.40
100	8.40	9.10

Weight in US units

ASME B16.5		
DN [in]	Weight [lbs]	
	Order code for "Housing", option M, Q: Polycarbonate plastic	Order code for "Housing", option A, R: Aluminum, AlSi10Mg, coated
1	5.51	7.06
1½	6.84	8.40
2	8.60	10.1
3	12.6	14.1
4	18.5	20.1

Transmitter remote version

Wall-mount housing

Depends on the material of the wall-mount housing:

- Polycarbonate plastic: 1.3 kg (2.9 lb)
- Aluminum, AlSi10Mg, coated: 2.0 kg (4.4 lb)

Sensor remote version

Weight data:

- Including sensor connection housing
- Excluding the connecting cable
- Excluding packaging material

Weight in SI units

EN 1092-1 (DIN 2501), JIS B2220	
DN [mm]	Weight [kg]
25	2.5
40	3.1
50	3.9
65	4.7
80	5.7
100	8.4

Weight in US units

ASME B16.5	
DN [in]	Weight [lbs]
1	5.5
1½	6.8
2	8.6
3	12.6
4	18.5

Measuring tube
specification**Pressure rating EN (DIN)**

Pressure rating PN 16									
DN		Mounting bolts			Length		internal diameter		
[mm]	[in]		[mm]	[in]	Centering sleeves		Measuring tube		
					[mm]	[in]	[mm]	[in]	
25	1	4 × M12 ×	145	5.71	54	2.13	24	0.94	
40	1½	4 × M16 ×	170	6.69	68	2.68	38	1.50	
50	2	4 × M16 ×	185	7.28	82	3.23	50	1.97	
65 ¹⁾	–	4 × M16 ×	200	7.87	92	3.62	60	2.36	
65 ²⁾	–	8 × M16 ×	200	7.87	– ³⁾	–	60	2.36	
80	3	8 × M16 ×	225	8.86	116	4.57	76	2.99	
100	4	8 × M16 ×	260	10.24	147	5.79	97	3.82	

1) EN (DIN) flange: 4-hole → with centering sleeves

2) EN (DIN) flange: 8-hole → without centering sleeves

3) A centering sleeve is not required. The device is centered directly via the sensor housing.

ASME pressure rating

Pressure rating Class 150								
DN		Mounting bolts			Length		internal diameter	
[mm]	[in]		[mm]	[in]	Centering sleeves		Measuring tube	
					[mm]	[in]	[mm]	[in]
25	1	4 × UNC ½" ×	145	5.70	- ¹⁾	-	24	0.94
40	1 ½	4 × UNC ½" ×	165	6.50	-	-	38	1.50
50	2	4 × UNC 5/8" ×	190.5	7.50	-	-	50	1.97
80	3	8 × UNC 5/8" ×	235	9.25	-	-	76	2.99
100	4	8 × UNC 5/8" ×	264	10.4	147	5.79	97	3.82

1) A centering sleeve is not required. The device is centered directly via the sensor housing.

Pressure rating JIS

Pressure rating 10K								
DN		Mounting bolts			Length		internal diameter	
[mm]	[in]		[mm]	[in]	Centering sleeves		Measuring tube	
					[mm]	[in]	[mm]	[in]
25	1	4 × M16 ×	170	6.69	54	2.13	24	0.94
40	1 ½	4 × M16 ×	170	6.69	68	2.68	38	1.50
50	2	4 × M16 ×	185	7.28	- ¹⁾	-	50	1.97
65	-	4 × M16 ×	200	7.87	-	-	60	2.36
80	3	8 × M16 ×	225	8.86	-	-	76	2.99
100	4	8 × M16 ×	260	10.24	-	-	97	3.82

1) A centering sleeve is not required. The device is centered directly via the sensor housing.

Materials

Transmitter housing

Order code for "Housing"

- Compact version, standard:
 - Option **A**: aluminum, AlSi10Mg, coated
 - Option **M**: polycarbonate plastic
- Compact version, inclined:
 - Option **Q**: polycarbonate plastic
 - Option **R**: aluminum, AlSi10Mg, coated
- Remote version (wall-mount housing):
 - Option **N**: polycarbonate plastic
 - Option **P**: aluminum, AlSi10Mg, coated

Window material

Transmitter housing material	Window material
Polycarbonate plastic	Plastic
Aluminum, AlSi10Mg, coated	Glass

Cable entries/cable glands

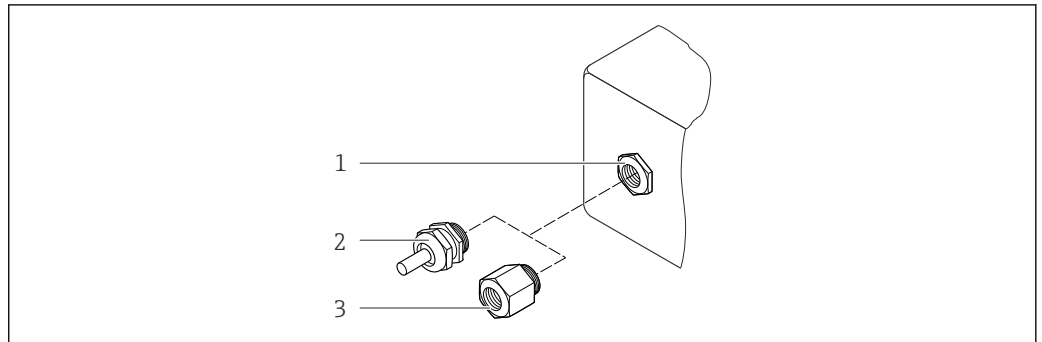

A0020640

30 Possible cable entries/cable glands

- 1 Cable entry in transmitter housing, wall-mount housing or connection housing with internal thread M20 x 1.5
- 2 Cable gland M20 x 1.5
- 3 Adapter for cable entry with internal thread G 1/2" or NPT 1/2"

Compact and remote versions and sensor connection housing

Cable entry/cable gland	Material
Cable gland M20 x 1.5	Plastic
Remote version: cable gland M20 x 1.5 Option of reinforced connecting cable	<ul style="list-style-type: none"> ■ Sensor connection housing: Nickel-plated brass ■ Transmitter wall-mount housing: Plastic
Adapter for cable entry with internal thread G 1/2" or NPT 1/2"	Nickel-plated brass

Device plug

Electrical connection	Material
Plug M12x1	<ul style="list-style-type: none"> ■ Socket: Stainless steel, 1.4404 (316L) ■ Contact housing: Polyamide ■ Contacts: Gold-plated brass

Connecting cable for remote version

Electrode and coil current cable

- Standard cable: PVC cable with copper shield
- Reinforced cable: PVC cable with copper shield and additional steel wire braided jacket

Sensor housing

Aluminum, AlSi10Mg, coated

Sensor connection housing

Aluminum, AlSi10Mg, coated

Sensor cable entries

Order code for "Housing", option N "Remote, polycarbonate" or option P "Remote, coated aluminum"

The various cable entries are suitable for hazardous and non-hazardous areas.

Electrical connection	Material
Cable gland M20 × 1.5	Nickel-plated brass
Thread G ½" via adapter	Nickel-plated brass
Thread NPT ½" via adapter	Nickel-plated brass

Liner

Polyamide

Electrodes

Stainless steel, 1.4435/F316L

Process connections

- EN 1092-1 (DIN 2501)
- ASME B16.5
- JIS B2220

 List of all available process connections

Seals

O-rings made from EPDM

Accessories

Display protection

Stainless steel, 1.4301 (304L)

Ground disks

Stainless steel ,1.4301/304

Mounting bolts

Tensile strength



- Galvanized steel mounting bolts: strength category 5.6 or 5.8
- Stainless steel mounting bolts: strength category A2-70

Fitted electrodes

2 measuring electrodes made of 1.4435 (316L)

Process connections

- EN 1092-1 (DIN 2501)
- ASME B16.5
- JIS B2220

 For information on the materials of the process connections (→  122)

16.11 Operability

Local operation

Via display module

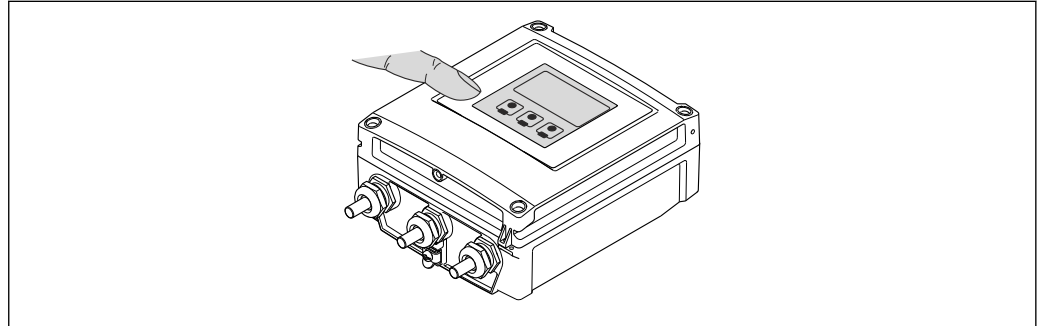

A0020538

Display elements

- 4-line display
- White background lighting; switches to red in event of device errors
- Format for displaying measured variables and status variables can be individually configured
- Permitted ambient temperature for the display: -20 to $+50$ °C (-4 to $+122$ °F)
The readability of the display may be impaired at temperatures outside the temperature range.

Operating elements

External operation via touch control; 3 optical keys: , , 

Additional functionality

- Data backup function
The device configuration can be saved in the display module.
- Data comparison function
The device configuration saved in the display module can be compared to the current device configuration.
- Data transfer function
The transmitter configuration can be transmitted to another device using the display module.

Remote operation

Via Ethernet-based fieldbus

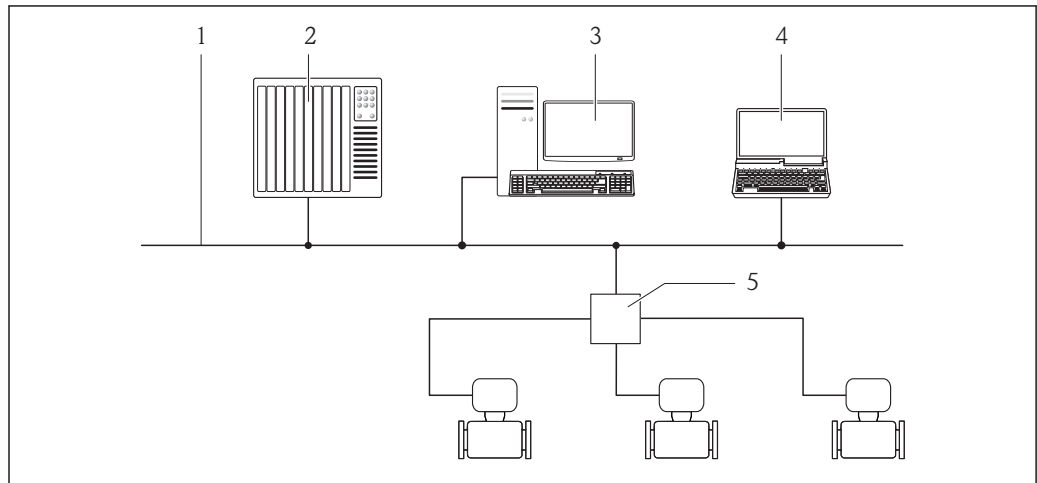

A0016961

- 1 Ethernet network
- 2 Automation system, e.g. "RSLogix" (Rockwell Automation)
- 3 Workstation for measuring device operation: with Add-on Profile Level 3 for "RSLogix 5000" (Rockwell Automation) or with Electronic Data Sheet (EDS)
- 4 Computer with Web browser (e.g. Internet Explorer) for accessing the integrated device Web server or with "FieldCare" operating tool with COM DTM "CDI Communication TCP/IP"
- 5 Ethernet switch

Service interface

Service interface (CDI-RJ45)

EtherNet/IP

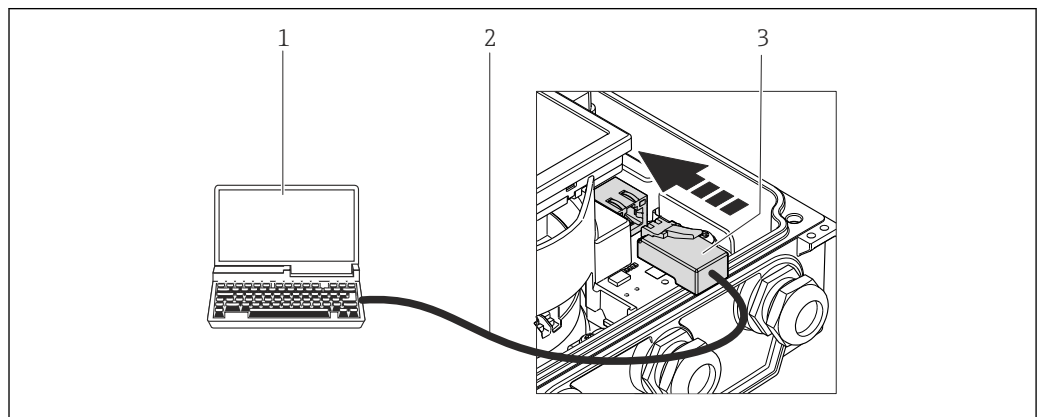

A0023113

- 1 Computer with Web browser (e.g. Internet Explorer) for accessing the integrated device Web server or with "FieldCare" operating tool with COM DTM "CDI Communication TCP/IP"
- 2 Standard Ethernet connecting cable with RJ45 plug
- 3 Service interface (CDI -RJ45) of the measuring device with access to the integrated Web server

Languages

Can be operated in the following languages:

- Via local display:
 - English, German, French, Spanish, Italian, Dutch, Portuguese, Polish, Russian, Turkish, Chinese, Japanese, Bahasa (Indonesian), Vietnamese, Czech
- Via "FieldCare" operating tool:
 - English, German, French, Spanish, Italian, Chinese, Japanese
- Via Web browser
 - English, German, French, Spanish, Italian, Dutch, Portuguese, Polish, Russian, Turkish, Chinese, Japanese, Bahasa (Indonesian), Vietnamese, Czech

16.12 Certificates and approvals

CE mark	<p>The measuring system is in conformity with the statutory requirements of the applicable EC Directives. These are listed in the corresponding EC Declaration of Conformity along with the standards applied.</p> <p>Endress+Hauser confirms successful testing of the device by affixing to it the CE mark.</p>
C-Tick symbol	<p>The measuring system meets the EMC requirements of the "Australian Communications and Media Authority (ACMA)".</p>
Ex approval	<p>The devices are certified for use in hazardous areas and the relevant safety instructions are provided in the separate "Control Drawing" document. Reference is made to this document on the nameplate.</p>
Drinking water approval	<ul style="list-style-type: none"> ■ ACS ■ KTW/W270 ■ NSF 61 ■ WRAS BS 6920
EtherNet/IP certification	<p>The measuring device is certified and registered by the ODVA (Open Device Vendor Association). The measuring system meets all the requirements of the following specifications:</p> <ul style="list-style-type: none"> ■ Certified in accordance with the ODVA Conformance Test ■ EtherNet/IP Performance Test ■ EtherNet/IP PlugFest compliance ■ The device can also be operated with certified devices of other manufacturers (interoperability)
Other standards and guidelines	<ul style="list-style-type: none"> ■ EN 60529 Degrees of protection provided by enclosures (IP code) ■ EN 61010-1 Safety requirements for electrical equipment for measurement, control and laboratory use ■ IEC/EN 61326 Emission in accordance with Class A requirements. Electromagnetic compatibility (EMC requirements). ■ ANSI/ISA-61010-1 (82.02.01): 2004 Safety Requirements for Electrical Equipment for Measurement, Control and Laboratory Use - Part 1 General Requirements ■ CAN/CSA-C22.2 No. 61010-1-04 Safety Requirements for Electrical Equipment for Measurement, Control and Laboratory Use - Part 1 General Requirements ■ NAMUR NE 21 Electromagnetic compatibility (EMC) of industrial process and laboratory control equipment ■ NAMUR NE 32 Data retention in the event of a power failure in field and control instruments with microprocessors ■ NAMUR NE 43 Standardization of the signal level for the breakdown information of digital transmitters with analog output signal. ■ NAMUR NE 53 Software of field devices and signal-processing devices with digital electronics

- NAMUR NE 105
Specifications for integrating fieldbus devices in engineering tools for field devices
- NAMUR NE 107
Self-monitoring and diagnosis of field devices
- NAMUR NE 131
Requirements for field devices for standard applications

16.13 Application packages



Many different application packages are available to enhance the functionality of the device. Such packages might be needed to address safety aspects or specific application requirements.

The application packages can be ordered from Endress+Hauser either directly with the device or subsequently. Detailed information on the order code in question is available from your local Endress+Hauser sales center or on the product page of the Endress+Hauser website: www.endress.com.

Diagnostics functions	Package	Description
	HistoROM extended function	<p>Comprises extended functions concerning the event log and the activation of the measured value memory.</p> <p>Event log: Memory volume is extended from 20 message entries (basic version) to up to 100 entries.</p> <p>Data logging (line recorder):</p> <ul style="list-style-type: none"> ■ Memory capacity for up to 1000 measured values is activated. ■ 250 measured values can be output via each of the 4 memory channels. The recording interval can be defined and configured by the user. ■ Data logging is visualized via the local display or FieldCare.

Heartbeat Technology	Package	Description
	Heartbeat Verification +Monitoring	<p>Heartbeat Monitoring: Continuously supplies monitoring data, which are characteristic of the measuring principle, for an external condition monitoring system. This makes it possible to:</p> <ul style="list-style-type: none"> ■ Draw conclusions - using these data and other information - about the impact the measuring application has on the measuring performance over time. ■ Schedule servicing in time. ■ Monitor the product quality, e.g. gas pockets. <p>Heartbeat Verification: Makes it possible to check the device functionality on demand when the device is installed, without having to interrupt the process.</p> <ul style="list-style-type: none"> ■ Access via onsite operation or other operating interfaces, such as FieldCare for instance. ■ End-to-end, traceable documentation of the verification results, including report. ■ Makes it possible to extend calibration intervals in accordance with operator's risk assessment.

16.14 Accessories

 Overview of accessories available for order (→  108)

16.15 Supplementary documentation

-  For an overview of the scope of the associated Technical Documentation, refer to the following:
- The CD-ROM provided for the device (depending on the device version, the CD-ROM might not be part of the delivery!)
 - The *W@M Device Viewer* : Enter the serial number from the nameplate (www.endress.com/deviceviewer)
 - The *Endress+Hauser Operations App*: Enter the serial number from the nameplate or scan the 2-D matrix code (QR code) on the nameplate.

Standard documentation

Brief Operating Instructions

Measuring device	Documentation code
Promag D 400	KA01112D

Technical Information

Measuring device	Documentation code
Promag D 400	TI01044D

Supplementary device-dependent documentation



Safety Instructions

Contents	Documentation code

Special Documentation

Contents	Documentation code
Heartbeat Technology	SD01183D

Installation Instructions

Contents	Documentation code
Installation Instructions for spare part sets	 Overview of accessories available for order (→  108)

17 Appendix

17.1 Overview of the operating menu

The following tables provide an overview of the entire operating menu structure with menus and parameters. The page reference indicates where a description of the parameter can be found in the manual.































17.1.1 Main menu































Main menu	→	Display language	(→ 67)
		Operation	(→ 128)
		Setup	(→ 129)
		Diagnostics	(→ 131)
		Expert	(→ 133)

17.1.2 "Operation" menu

Operation	→		
Display language			(→ 67)
Web server language			
Access status display			(→ 57)
Access status tooling			
Locking status			(→ 80)
		Display	→ (→ 70)
		Format display	(→ 71)
		Contrast display	(→ 52)
		Backlight	(→ 79)
		Display interval	(→ 79)
		Totalizer handling	→ (→ 85)
		Control Totalizer 1 to 3	(→ 86)
		Preset value 1 to 3	(→ 86)
		Reset all totalizers	(→ 85)

17.1.3 "Setup" menu















Setup →	(→  68)
Device tag	(→  69)
System units →	(→  69)
Volume flow unit	(→  69)
Volume unit	(→  69)
Temperature unit	(→  70)
Mass flow unit	(→  70)
Mass unit	(→  70)
Density unit	(→  70)
Communication →	(→  72)
MAC address	(→  72)
Default network settings	(→  72)
DHCP client	(→  72)
IP address	(→  72)
Subnet mask	(→  72)
Default gateway	(→  72)
Display →	(→  70)
Format display	(→  71)
Value 1 display	(→  71)
0% bargraph value 1	(→  71)
100% bargraph value 1	(→  71)
Value 2 display	(→  71)
Value 3 display	(→  72)
0% bargraph value 3	(→  72)
100% bargraph value 3	(→  72)
Value 4 display	(→  72)
Low flow cut off →	(→  73)
Assign process variable	(→  73)
On value low flow cutoff	(→  73)
Off value low flow cutoff	(→  73)

Pressure shock suppression		(→  73)
Empty pipe detection	→	(→  74)
Empty pipe detection		(→  74)
New adjustment		(→  74)
Progress		(→  74)
Switch point empty pipe detection		(→  74)
Response time part. filled pipe detect.		(→  74)
Advanced setup	→	(→  75)
Enter access code		(→  80)
	Sensor adjustment	→ (→  76)
	Installation direction	(→  76)
	Totalizer 1 to 3	→ (→  76)
	Assign process variable	(→  76)
	Unit totalizer	(→  76)
	Totalizer operation mode	(→  76)
	Failure mode	(→  76)
	Display	→ (→  77)
	Format display	(→  71)
	Value 1 display	(→  71)
	0% bargraph value 1	(→  71)
	100% bargraph value 1	(→  71)
	Decimal places 1	(→  78)
	Value 2 display	(→  71)
	Decimal places 2	(→  78)
	Value 3 display	(→  72)
	0% bargraph value 3	(→  72)
	100% bargraph value 3	(→  72)
	Decimal places 3	(→  78)
	Value 4 display	(→  72)
	Decimal places 4	(→  78)

Display language	(→ 79)
Display interval	(→ 79)
Display damping	(→ 79)
Header	(→ 79)
Header text	(→ 79)
Separator	(→ 79)
Backlight	(→ 79)
Administration →	
Define access code →	(→ 80)
Define access code	(→ 80)
Confirm access code	(→ 80)
Device reset	(→ 102)

17.1.4 "Diagnostics" menu

Diagnostics →	(→ 88)
Actual diagnostics	(→ 100)
Previous diagnostics	(→ 100)
Operating time from restart	(→ 100)
Operating time	(→ 0)
Diagnostic list →	(→ 100)
Diagnostics 1 to 5	(→ 100)
Event logbook →	(→ 100)
Filter options	(→ 101)
Device information →	(→ 102)
Device tag	(→ 103)
Serial number	(→ 103)
Firmware version	(→ 103)
Device name	(→ 103)
Order code	(→ 103)
Extended order code 1 to 3	(→ 103)
ENP version	(→ 103)

IP address		(→  72)
Subnet mask		(→  72)
Default gateway		(→  72)
Measured values	→	
	Process variables	→ (→  84)
	Volume flow	(→  84)
	Mass flow	(→  84)
	Totalizer 1 to 3	→ (→  85)
	Totalizer value 1 to 3	(→  85)
	Totalizer overflow 1 to 3	(→  85)
	Data logging ¹⁾	→ (→  86)
	Assign channel 1 to 4	(→  87)
	Logging interval	(→  87)
	Clear logging data	(→  87)
	Heartbeat ²⁾	→ (→  127)
	Performing verification	→
	Year	
	Month	
	Day	
	Hour	
	AM/PM	
	Minute	
	Verification mode	
	External device information	
	External reference voltage 1	
	External reference voltage 2	
	Start verification	
	Progress	
	Status	
	Overall result	

	Verification results →	
	Date/time	
	Verification ID	
	Operating time	
	Overall result	
	Sensor	
	Sensor electronic module	
	I/O module	
	Monitoring results →	
	Noise	
	Coil current shot time	
	Reference electrode potential against PE	
Simulation →		(→ 79)
	Assign simulation process variable	(→ 80)
	Value process variable	(→ 80)
	Simulation device alarm	(→ 80)
	Diagnostic event category	(→ 80)
	Simulation diagnostic event	(→ 80)

- 1) Order code for "Application package", option EA "Extended HistoROM", see Technical Information for device, "Application packages" section
- 2) Order code for "Application package", option EB "Heartbeat Verification + Monitoring", see the Special Documentation for the device

17.1.5 "Expert" menu

The following tables provide an overview of the **Expert** menu (→ 133) with its submenus and parameters. The direct access code to the parameter is given in brackets. The page reference indicates where a description of the parameter can be found in the manual.

Overview "Expert" menu

Expert →	(→ 45)
Direct access (0106)	(→ 54)
Locking status (0004)	(→ 83)
Access status display (0091)	(→ 57)
Access status tooling (0005)	(→ 81)

Enter access code (0092)	
System	(→ ⓘ 134)
Sensor	(→ ⓘ 135)
Communication	(→ ⓘ 138)
Application	(→ ⓘ 138)
Diagnostics	(→ ⓘ 139)





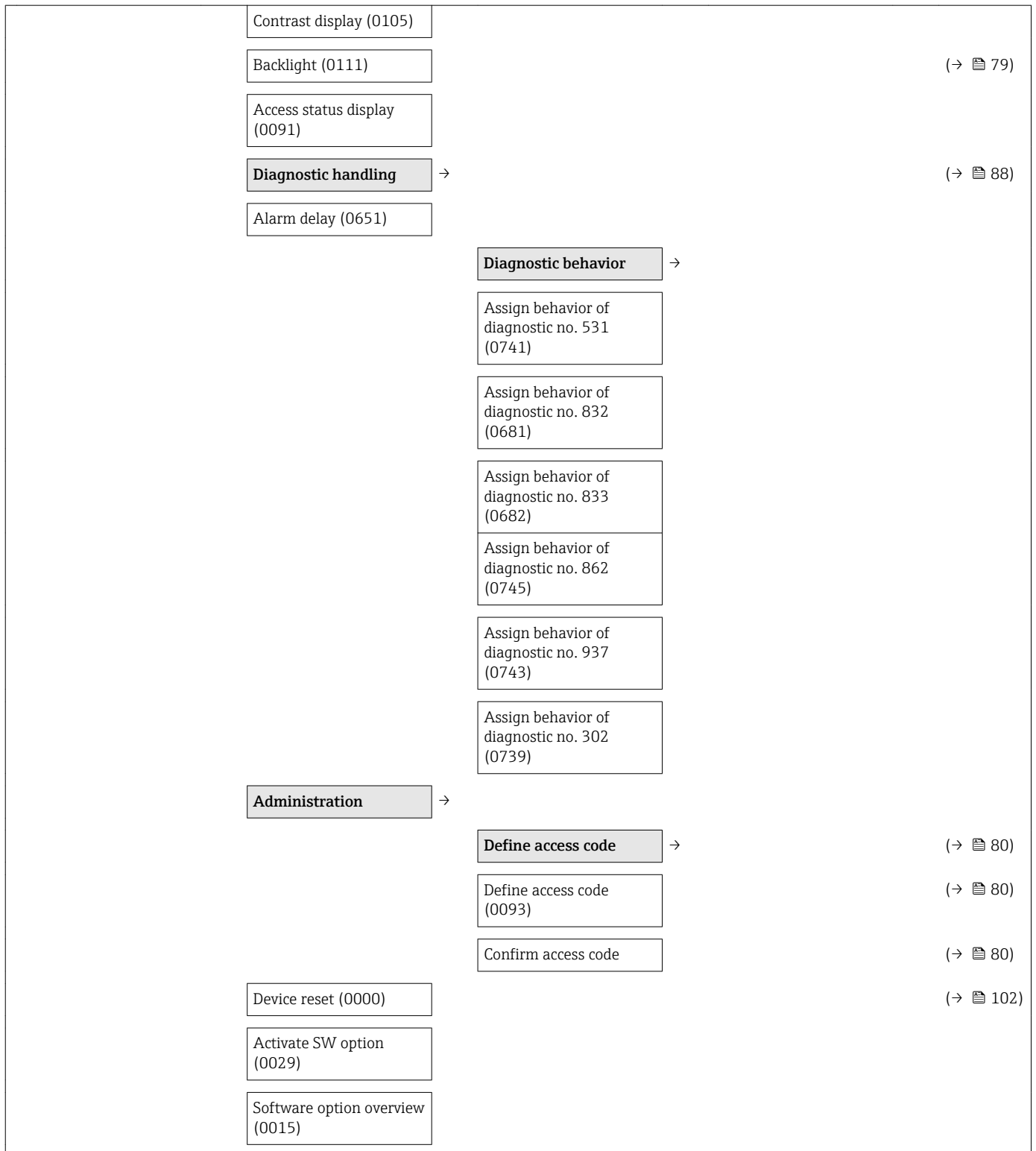



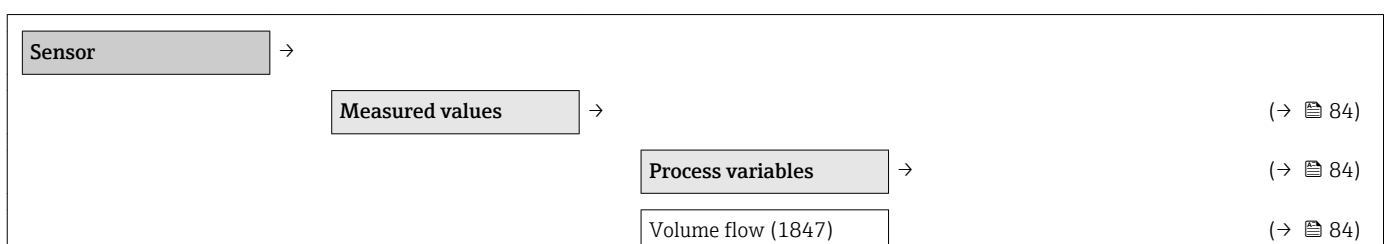







"System" submenu

System	→	
Display	→	(→ ⓘ 77)
Display language (0104)		(→ ⓘ 79)
Format display (0098)		(→ ⓘ 71)
Value 1 display (0107)		(→ ⓘ 71)
0% bargraph value 1 (0123)		(→ ⓘ 71)
100% bargraph value 1 (0125)		(→ ⓘ 71)
Decimal places 1 (0095)		(→ ⓘ 78)
Value 2 display (0108)		(→ ⓘ 71)
Decimal places 2 (0117)		(→ ⓘ 78)
Value 3 display (0110)		(→ ⓘ 72)
0% bargraph value 3 (0124)		(→ ⓘ 72)
100% bargraph value 3 (0126)		(→ ⓘ 72)
Decimal places 3 (0118)		(→ ⓘ 78)
Value 4 display (0109)		(→ ⓘ 72)
Decimal places 4 (0119)		(→ ⓘ 78)
Display interval (0096)		(→ ⓘ 79)
Display damping (0094)		(→ ⓘ 79)
Header (0097)		(→ ⓘ 79)
Header text (0112)		(→ ⓘ 79)
Separator (0101)		(→ ⓘ 79)



"Sensor" submenu



	Mass flow (1838)	(→  84)
	Totalizer 1 to 3 →	(→  85)
	Totalizer value 1 to 3 (0911-1 to 3)	(→  85)
	Totalizer overflow 1 to 3 (0910-1 to 3)	(→  85)
	System units →	(→  69)
	Volume flow unit (0553)	(→  69)
	Volume unit (0563)	(→  69)
	Temperature unit (0557)	(→  70)
	Mass flow unit (0554)	(→  70)
	Mass unit (0574)	(→  70)
	Density unit (0555)	(→  70)
	Date/time format (2812)	
	User-specific units →	
	User volume text (0567)	
	User volume offset (0569)	
	User volume factor	
	User mass text	
	User mass offset (0562)	
	User mass factor (0561)	
	Process parameters →	(→  68)
	Filter options (6710)	
	Flow damping (6661)	
	Flow override (1839)	
	Low flow cut off →	
	Assign process variable (1837)	(→  73)
	On value low flow cutoff (1805)	(→  73)
	Off value low flow cutoff (1804)	(→  73)
	Pressure shock suppression (1806)	(→  73)

	Empty pipe detection →	
	Empty pipe detection (1860)	(→ 74)
	Switch point empty pipe detection (6562)	(→ 74)
	Response time part. filled pipe detect. (1859)	(→ 74)
	Empty pipe adjust value (6527)	
	Full pipe adjust value (6548)	
	Measured value EPD (6559)	
	Empty pipe adjust →	
		New adjustment (6560) (→ 74)
		Progress (6571) (→ 74)
	External compensation →	
	Density source (6615)	
	External density (6630)	
	Fixed density (6623)	
	Sensor adjustment →	
	Installation direction (1809)	(→ 76)
	Integration time (6533)	
	Measuring period (6536)	
	Process variable adjustment →	
	Volume flow offset (1841)	
	Volume flow factor (1846)	
	Mass flow offset (1831)	
	Mass flow factor (1832)	
	Calibration →	
	Nominal diameter (2807)	
	Calibration factor (6025)	

	Zero point (6195)	
--	-------------------	--

"Communication" submenu

Communication →		
	Configuration →	(→ ⓘ 72)
	Web server language (7221)	
	MAC address (7214)	(→ ⓘ 72)
	Default network settings (7401)	(→ ⓘ 72)
	DHCP client (7212)	(→ ⓘ 72)
	IP address (7209)	(→ ⓘ 72)
	Subnet mask (7211)	(→ ⓘ 72)
	Default gateway (7210)	(→ ⓘ 72)
	Web server functionality	
	Configurable input assembly →	
	Input assembly position 1 to 20 (7402-1 to 20)	

"Application" submenu

Application →		
	Reset all totalizers (2806)	(→ ⓘ 86)
	Totalizer 1 to 3 →	(→ ⓘ 76)
	Assign process variable (0914)	(→ ⓘ 76)
	Unit totalizer (0915)	(→ ⓘ 76)
	Totalizer operation mode	(→ ⓘ 76)
	Control Totalizer 1 to 3 (0912-1 to 3)	(→ ⓘ 86)
	Preset value 1 to 3 (0913-1 to 3)	(→ ⓘ 86)
	Failure mode (0901)	(→ ⓘ 76)
	Concentration →	
	Concentration unit	

User concentration text
User concentration factor
User concentration offset
A 0
A 1 to 4
B 1 to 3

"Diagnostics" submenu

Diagnostics →	(→ 📄 88)
Actual diagnostics (0691)	(→ 📄 100)
Previous diagnostics (0690)	(→ 📄 100)
Operating time from restart (0653)	(→ 📄 100)
Operating time (0652)	(→ 📄 100)
Diagnostic list →	(→ 📄 100)
Diagnostics 1 to 5 (0692-1 to 5)	(→ 📄 100)
Event logbook →	(→ 📄 100)
Filter options (0705)	(→ 📄 101)
Device information →	(→ 📄 102)
Device tag (0011)	(→ 📄 103)
Serial number (0009)	(→ 📄 103)
Firmware version (0010)	(→ 📄 103)
Device name (0013)	(→ 📄 103)
Order code (0008)	(→ 📄 103)
Extended order code 1 to 3 (0023-1 to 3)	(→ 📄 103)
Configuration counter (0233)	
ENP version (0012)	(→ 📄 103)
IP address (7209)	(→ 📄 72)
Subnet mask (7211)	(→ 📄 72)
Default gateway (7210)	(→ 📄 72)

Data logging ¹⁾	→		(→ 📖 86)
Assign channel 1 to 4 (0851-1 to 4)			(→ 📖 87)
Logging interval (0856)			(→ 📖 87)
Clear logging data (0855)			(→ 📖 87)
Min/max values	→		
Reset min/max values (6151)			
		Main electronic temperature	→
		Minimum value (6547)	
		Maximum value (6545)	
Heartbeat ²⁾	→		(→ 📖 127)
		Heartbeat base settings	→
		Plant operator (2754)	
		Location (2751)	
		Performing verification	→
		Year (2846)	
		Month (2845)	
		Day (2842)	
		Hour (2843)	
		AM/PM (2813)	
		Minute (2844)	
		Verification mode (12105)	
		External device information (12101)	
		External reference voltage 1 (12106)	
		External reference voltage 2 (12107)	
		Start verification (12127)	
		Progress (2808)	
		Status (12153)	

	Overall result (12149)	
	Verification results	→
	Date/time (12142)	
	Verification ID (12141)	
	Operating time (12126)	
	Overall result (12149)	
	Sensor (12152)	
	Sensor electronic module (12151)	
	I/O module (12145)	
	Monitoring results	→
	Noise (12158)	
	Coil current shot time (12150)	
	Reference electrode potential against PE (12155)	
Simulation		→
	Assign simulation process variable (1810)	(→ ⓘ 80)
	Value process variable (1811)	(→ ⓘ 80)
	Simulation device alarm (0654)	(→ ⓘ 80)
	Diagnostic event category (0738)	(→ ⓘ 80)
	Simulation diagnostic event (0737)	(→ ⓘ 80)

- 1) Order code for "Application package", option EA "Extended HistoROM", see Technical Information for device, "Application packages" section
- 2) Order code for "Application package", option EB "Heartbeat Verification + Monitoring", see the Special Documentation for the device

Index

A

Access authorization to parameters	
Read access	57
Write access	57
Access code	57
Incorrect input	57
Adapters	20
Adapting the diagnostic behavior	96
Ambient temperature range	19
Application	9, 110
Applicator	110
Approvals	125

C

C-Tick symbol	125
Cable entries	
Technical data	115
Cable entry	
Degree of protection	41
CE mark	10, 125
Certificates	125
Checklist	
Post-connection check	41
Post-installation check	29
Cleaning	
Exterior cleaning	105
Interior cleaning	105
Commissioning	67
Advanced settings	75
Configuring the measuring device	68
Connecting cable	30
Connecting the measuring device	35
Connection	
see Electrical connection	
Connection examples, potential equalization	38
Connection preparations	33
Connection tools	30
Context menu	
Closing	52
Explanation	52
Opening	52
Current consumption	115

D

Declaration of Conformity	10
Define access code	80, 81
Degree of protection	41, 117
Design	
Measuring device	12
Designated use	9
Device components	12
Device description files	65
Device documentation	
Supplementary documentation	8
Device locking, status	83
Device name	

Sensor	15
Transmitter	14
Device repair	106
Device revision	65
Device type ID	65
Diagnostic behavior	
Explanation	92
Symbols	92
Diagnostic information	
Communication interface	96
Design, description	92, 95
FieldCare	95
Light emitting diodes	90
Local display	91
Overview	97
Remedial measures	97
Web browser	94
Diagnostic list	100
Diagnostic message	91
Diagnostics	
Symbols	91
DIP switch	
see Write protection switch	
Direct access	54
Direct access code	48
Disabling write protection	80
Display	
Current diagnostic event	99
Previous diagnostic event	99
see Local display	
Display area	
For operational display	47
In the navigation view	49
Display values	
For locking status	83
Disposal	106
Document	
Function	6
Symbols used	6
Document function	6
Down pipe	17
Drinking water approval	125

E

Electrical connection	
Degree of protection	41
Measuring device	30
Operating tools	
Via Ethernet network	124
Via service interface (CDI-RJ45)	63
RSLogix 5000	124
Web server	63
Electromagnetic compatibility	117
Enabling write protection	80
Endress+Hauser services	
Maintenance	105

- Repair 106
- Environment
 - Ambient temperature range 19
 - Mechanical load 117
 - Shock resistance 117
 - Storage temperature 116
 - Vibration resistance 117
- Error messages
 - see Diagnostic messages
- EtherNet/IP
 - Diagnostic information 96
- EtherNet/IP certification 125
- Event history 100
- Events list 100
- Ex approval 125
- Extended order code
 - Sensor 15
 - Transmitter 14
- Exterior cleaning 105
- F**
- Field of application
 - Residual risks 10
- FieldCare 63
 - Device description file 65
 - Establishing a connection 63
 - Function 63
 - User interface 64
- Filtering the event logbook 101
- Firmware
 - Release date 65
 - Version 65
- Firmware history 104
- Fitted electrodes 122
- Fix assembly 96
- Flow direction 18
- Flow limit 117
- Function check 67
- Functions
 - see Parameter
- G**
- Galvanic isolation 112
- H**
- Hardware write protection 81
- Help text
 - Calling up 55
 - Close 55
 - Explanation 55
- I**
- I/O electronics module 12, 36
- Identifying the measuring device 13
- Incoming acceptance 13
- Information on the document 6
- Inlet runs 19
- Input 110
- Input mask 50
- Inspection
 - Installation 29
 - Received goods 13
- Inspection check
 - Connection 41
- Installation conditions
 - Adapters 20
 - Down pipe 17
 - Inlet and outlet runs 19
 - Mounting kit 22
 - Mounting location 17
 - Orientation 18
 - Partially filled pipe 18
 - System pressure 20
 - Vibrations 20
- Installation dimensions 19
- Interior cleaning 105
- K**
- Keypad lock
 - Disabling 57
 - Enabling 57
- L**
- Languages, operation options 124
- Line recorder 86
- Local display 123
 - Editing view 50
 - Navigation view 48
 - see Diagnostic message
 - see In alarm condition
 - see Operational display
- Low flow cut off 112
- M**
- Main electronics module 12
- Maintenance tasks 105
 - Replacing seals 105
- Manufacturer ID 65
- Manufacturing date 14, 15
- Materials 120
- Maximum measured error 116
- Measured variables
 - Calculated 110
 - Measured 110
 - see Process variables
- Measuring and test equipment 105
- Measuring device
 - Configuration 68
 - Conversion 106
 - Design 12
 - Disposal 107
 - Integrating via HART protocol 65
 - Mounting the sensor 22
 - Arranging the mounting bolts and centering sleeves 22
 - Mounting the ground cable/ground disks 23
 - Mounting the seals 23
 - Screw tightening torques 23
 - Preparing for electrical connection 33

- Preparing for mounting 21
- Removing 106
- Repair 106
- Switch-on 67
- Measuring principle 110
- Measuring range 110
- Measuring system 110
- Measuring tube specification 119
- Mechanical load 117
- Media 9
- Medium temperature range 117
- menu
 - Diagnostics 99
 - Operation 83
 - Setup 68
- Menus
 - For measuring device configuration 68
 - For specific settings 75
- Mounting 17
- Mounting bolts 122
- Mounting dimensions
 - see Installation dimensions
- Mounting kit 22
- Mounting location 17
- Mounting preparations 21
- Mounting requirements
 - Installation dimensions 19
- Mounting tools 21
- N**
- Nameplate
 - Sensor 15
 - Transmitter 14
- Navigation path (navigation view) 48
- Navigation view
 - In the submenu 48
 - In the wizard 48
- Numeric editor 50
- O**
- Operable flow range 111
- Operating elements 51, 92
- Operating keys
 - see Operating elements
- Operating menu
 - Menus, submenus 44
 - Overview of menus with parameters 128
 - Structure 44
 - Submenus and user roles 45
- Operating philosophy 45
- Operation 83
- Operation options 43
- Operational display 46
- Operational safety 10
- Order code 14, 15
- Orientation (vertical, horizontal) 18
- Outlet runs 19
- Output 111
- Output signal 111
- Overview
 - Operating menu 128
- P**
- Packaging disposal 17
- Parameter
 - Changing 56
 - Enter a value 56
- Parameter settings
 - Communication (submenu) 72
 - Data logging (submenu) 86
 - Device information (submenu) 102
 - Diagnostics (menu) 99
 - Display (submenu) 77
 - Display (wizard) 70
 - Empty pipe detection (wizard) 74
 - Low flow cut off (wizard) 73
 - Operation (submenu) 85
 - Process variables (submenu) 84
 - Sensor adjustment (submenu) 76
 - Setup (menu) 68
 - Simulation (submenu) 79
 - System units (submenu) 69
 - Totalizer (submenu) 85
 - Totalizer 1 to 3 (submenu) 76
 - Web server (submenu) 62
- Partially filled pipe 18
- Performance characteristics 115
- Post-connection check (checklist) 41
- Post-installation check 67
- Post-installation check (checklist) 29
- Potential equalization 38, 115
- Power consumption 115
- Power supply failure 115
- Pressure loss 117
- Pressure tightness 117
- Pressure-temperature ratings 117
- Process conditions
 - Flow limit 117
 - Medium temperature 117
 - Pressure loss 117
 - Pressure tightness 117
- Process connections 122
- Product safety 10
- Protecting parameter settings 80
- R**
- Read access 57
- Reading measured values 84
- Reading out diagnostic information, EtherNet/IP 96
- Recalibration 105
- Reference operating conditions 115
- Registered trademarks 8
- Remedial measures
 - Calling up 93
 - Closing 93
- Remote operation 124
- Remote version
 - Connecting the signal cables 36

- Repair 106
 - Notes 106
- Repair of a device 106
- Repeatability 116
- Replacement
 - Device components 106
- Replacing seals 105
- Requirements for personnel 9
- Returning devices 106
- S**
- Safety 9
- Screw tightening torques 23
- Sensor
 - Mounting 22
- Serial number 14, 15
- Service interface (CDI-RJ45) 124
- Setting the operating language 67
- Settings
 - Adapting the measuring device to the process conditions 85
 - Advanced display configurations 77
 - Communication interface 72
 - Device reset 102
 - Device tag 68
 - Empty pipe detection (EPD) 74
 - Local display 70
 - Low flow cut off 73
 - Operating language 67
 - Resetting the totalizer 85
 - Sensor adjustment 76
 - Simulation 79
 - System units 69
 - Totalizer 76
 - Totalizer reset 85
- Shock resistance 117
- Showing data logging 86
- Signal on alarm 111
- Software release 65
- Spare part 106
- Spare parts 106
- Special connection instructions 40
- Standards and guidelines 125
- Status area
 - For operational display 46
 - In the navigation view 48
- Status signals 91, 94
- Storage conditions 16
- Storage temperature 16
- Storage temperature range 116
- Structure
 - Operating menu 44
- submenu
 - Advanced setup 75
 - Communication 67, 72
 - Data logging 86
 - Device information 102
 - Display 77
 - Operation 85
 - Process variables 84
 - Sensor adjustment 76
 - Simulation 79
 - System units 69
 - Totalizer 85
 - Totalizer 1 to 3 76
 - Web server 62
- Submenu
 - Define access code 80
 - Events list 100
 - Overview 45
 - Process variables 84
- Supplementary documentation 127
- Supply voltage 114
- Symbols
 - For communication 46
 - For correction 50
 - For diagnostic behavior 46
 - For locking 46
 - For measured variable 47
 - For measurement channel number 47
 - For menus 49
 - For parameters 49
 - For status signal 46
 - For submenu 49
 - For wizard 49
 - In the status area of the local display 46
 - In the text and numeric editor 50
- System design
 - Measuring system 110
 - see Measuring device design
- System file
 - Release date 65
 - Source 65
 - Version 65
- System integration 65
- System pressure 20
- T**
- Technical data, overview 110
- Temperature range
 - Ambient temperature range for display 123
 - Storage temperature 16
- Terminal assignment 32, 36
- Terminals 115
- Text editor 50
- Tool tip
 - see Help text
- Tools
 - Electrical connection 30
 - For mounting 21
 - Transport 16
- Transmitter
 - Connecting the signal cables 36
 - Turning the display module 28
 - Turning the housing 26
- Transporting the measuring device 16
- Troubleshooting
 - General 88

Turning the display module	28
Turning the electronics housing see Turning the transmitter housing	
Turning the transmitter housing	26
U	
Use of the measuring device	
Borderline cases	9
Incorrect use	9
see Designated use	
User roles	45
V	
Version data for the device	65
Vibration resistance	117
Vibrations	20
W	
W@M	105, 106
W@M Device Viewer	13, 106
Weight	
Compact version	118
Sensor remote version	119
Transport (notes)	16
wizard	
Define access code	80
Display	70
Empty pipe detection	74
Low flow cut off	73
Workplace safety	10
Write access	57
Write protection	
Via access code	80
Via write protection switch	81
Write protection switch	81

www.addresses.endress.com
