

# Operating Instructions

## Proline Prowirl O 200

### HART

Vortex flowmeter

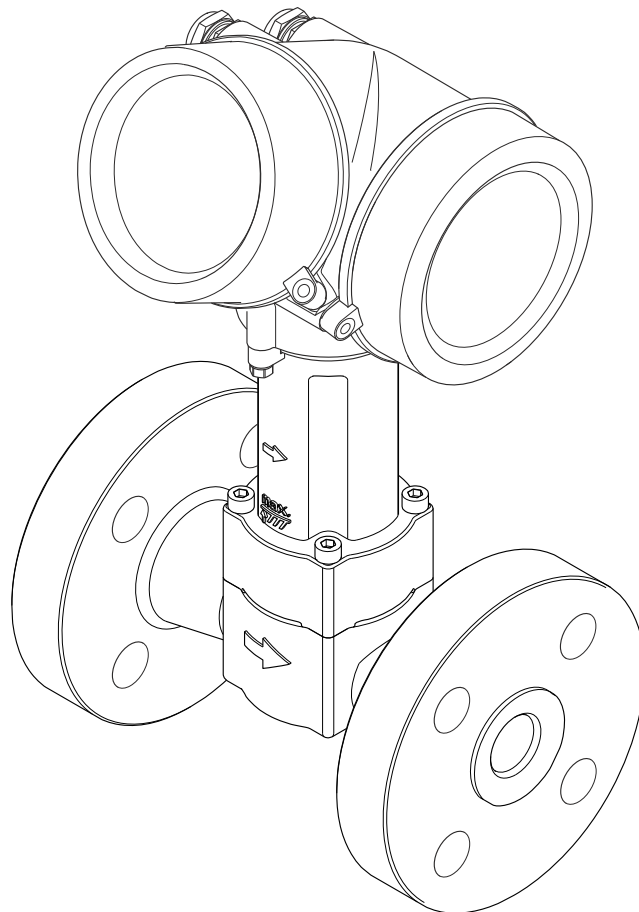

- Make sure the document is stored in a safe place such that it is always available when working on or with the device.
- To avoid danger to individuals or the facility, read the "Basic safety instructions" section carefully, as well as all other safety instructions in the document that are specific to working procedures.
- The manufacturer reserves the right to modify technical data without prior notice. Your Endress+Hauser Sales Center will supply you with current information and updates to these instructions.

## Table of contents

<b>1</b>	<b>Document information</b>	<b>6</b>		
1.1	Document function	6		
1.2	Symbols used	6		
1.2.1	Safety symbols	6		
1.2.2	Electrical symbols	6		
1.2.3	Tool symbols	6		
1.2.4	Symbols for certain types of information	7		
1.2.5	Symbols in graphics	7		
1.3	Documentation	7		
1.3.1	Standard documentation	8		
1.3.2	Supplementary device-dependent documentation	8		
1.4	Registered trademarks	8		
<b>2</b>	<b>Basic safety instructions</b>	<b>9</b>		
2.1	Requirements for the personnel	9		
2.2	Designated use	9		
2.3	Workplace safety	10		
2.4	Operational safety	10		
2.5	Product safety	10		
2.6	IT security	10		
<b>3</b>	<b>Product description</b>	<b>11</b>		
3.1	Product design	11		
<b>4</b>	<b>Incoming acceptance and product identification</b>	<b>12</b>		
4.1	Incoming acceptance	12		
4.2	Product identification	12		
4.2.1	Transmitter nameplate	13		
4.2.2	Sensor nameplate	14		
4.2.3	Symbols on measuring device	16		
<b>5</b>	<b>Storage and transport</b>	<b>17</b>		
5.1	Storage conditions	17		
5.2	Transporting the product	17		
5.2.1	Measuring devices without lifting lugs	17		
5.2.2	Measuring devices with lifting lugs	18		
5.2.3	Transporting with a fork lift	18		
5.3	Packaging disposal	18		
<b>6</b>	<b>Installation</b>	<b>19</b>		
6.1	Installation conditions	19		
6.1.1	Mounting position	19		
6.1.2	Requirements from environment and process	23		
6.1.3	Special mounting instructions	24		
6.2	Mounting the measuring device	25		
6.2.1	Required tools	25		
6.2.2	Preparing the measuring device	25		
6.2.3	Mounting the sensor	25		
6.2.4	Mounting the transmitter of the remote version	26		
6.2.5	Turning the transmitter housing	27		
6.2.6	Turning the display module	27		
6.3	Post-installation check	28		
<b>7</b>	<b>Electrical connection</b>	<b>29</b>		
7.1	Connection conditions	29		
7.1.1	Required tools	29		
7.1.2	Connecting cable requirements	29		
7.1.3	Terminal assignment	31		
7.1.4	Requirements for the supply unit	32		
7.1.5	Preparing the measuring device	34		
7.2	Connecting the measuring device	34		
7.2.1	Connecting the remote version	34		
7.2.2	Connecting the transmitter	38		
7.2.3	Ensuring potential equalization	40		
7.3	Special connection instructions	40		
7.3.1	Connection examples	40		
7.4	Ensuring the degree of protection	42		
7.5	Post-connection check	43		
<b>8</b>	<b>Operation options</b>	<b>44</b>		
8.1	Overview of operating options	44		
8.2	Structure and function of the operating menu	45		
8.2.1	Structure of the operating menu	45		
8.2.2	Operating philosophy	46		
8.3	Access to the operating menu via the local display	47		
8.3.1	Operational display	47		
8.3.2	Navigation view	48		
8.3.3	Editing view	50		
8.3.4	Operating elements	52		
8.3.5	Opening the context menu	52		
8.3.6	Navigating and selecting from list	54		
8.3.7	Calling the parameter directly	54		
8.3.8	Calling up help text	55		
8.3.9	Changing the parameters	56		
8.3.10	User roles and related access authorization	57		
8.3.11	Disabling write protection via access code	57		
8.3.12	Enabling and disabling the keypad lock	57		
8.4	Access to the operating menu via the operating tool	58		
8.4.1	Connecting the operating tool	59		
8.4.2	Field Xpert SFX350, SFX370	59		
8.4.3	FieldCare	59		
8.4.4	AMS Device Manager	61		
8.4.5	SIMATIC PDM	61		

8.4.6	Field Communicator 475 .....	61	11.7	Showing data logging .....	133
<b>9</b>	<b>System integration .....</b>	<b>62</b>	<b>12</b>	<b>Diagnostics and troubleshooting ..</b>	<b>136</b>
9.1	Overview of device description files .....	62	12.1	General troubleshooting .....	136
9.1.1	Current version data for the device ...	62	12.2	Diagnostic information on local display .....	138
9.1.2	Operating tools .....	62	12.2.1	Diagnostic message .....	138
9.2	Measured variables via HART protocol .....	62	12.2.2	Calling up remedial measures .....	140
9.3	Other settings .....	64	12.3	Diagnostic information in FieldCare .....	140
9.3.1	Burst mode functionality in accordance with HART 7 Specification .....	64	12.3.1	Diagnostic options .....	140
<b>10</b>	<b>Commissioning .....</b>	<b>67</b>	12.3.2	Calling up remedy information .....	141
10.1	Function check .....	67	12.4	Adapting the diagnostic information .....	142
10.2	Switching on the measuring device .....	67	12.4.1	Adapting the diagnostic behavior ...	142
10.3	Setting the operating language .....	67	12.4.2	Adapting the status signal .....	142
10.4	Configuring the measuring device .....	68	12.5	Overview of diagnostic information .....	143
10.4.1	Defining the tag name .....	68	12.6	Pending diagnostic events .....	146
10.4.2	Selecting and setting the medium ...	70	12.7	Diagnostic list .....	147
10.4.3	Configuring the current input .....	72	12.8	Event logbook .....	148
10.4.4	Configuring the current output .....	75	12.8.1	Event history .....	148
10.4.5	Configuring the pulse/frequency/ switch output .....	78	12.8.2	Filtering the event logbook .....	148
10.4.6	Configuring the local display .....	89	12.8.3	Overview of information events .....	148
10.4.7	Configuring the output conditioning .....	91	12.9	Resetting the measuring device .....	149
10.4.8	Configuring the low flow cut off .....	92	12.9.1	Function scope of the "Device reset" parameter .....	150
10.5	Advanced settings .....	94	12.10	Device information .....	150
10.5.1	Setting the system units .....	95	12.11	Firmware history .....	153
10.5.2	Setting the medium properties .....	98	<b>13</b>	<b>Maintenance .....</b>	<b>154</b>
10.5.3	Performing external compensation .	112	13.1	Maintenance tasks .....	154
10.5.4	Carrying out a sensor adjustment ...	114	13.1.1	Exterior cleaning .....	154
10.5.5	Configuring the totalizer .....	115	13.1.2	Interior cleaning .....	154
10.5.6	Carrying out additional display configurations .....	117	13.1.3	Replacing seals .....	154
10.6	Configuration management .....	119	13.2	Measuring and test equipment .....	154
10.6.1	Function scope of the "Configuration management" parameter .....	120	13.3	Endress+Hauser services .....	154
10.7	Simulation .....	121	<b>14</b>	<b>Repair .....</b>	<b>155</b>
10.8	Protecting settings from unauthorized access .....	123	14.1	General notes .....	155
10.8.1	Write protection via access code ...	123	14.2	Spare parts .....	155
10.8.2	Write protection via write protection switch .....	124	14.3	Endress+Hauser services .....	156
<b>11</b>	<b>Operation .....</b>	<b>127</b>	14.4	Return .....	156
11.1	Reading the device locking status .....	127	14.5	Disposal .....	156
11.2	Adjusting the operating language .....	127	14.5.1	Removing the measuring device ...	156
11.3	Configuring the display .....	127	14.5.2	Disposing of the measuring device ..	157
11.4	Reading measured values .....	127	<b>15</b>	<b>Accessories .....</b>	<b>158</b>
11.4.1	Process variables .....	127	15.1	Device-specific accessories .....	158
11.4.2	Totalizer .....	130	15.1.1	For the transmitter .....	158
11.4.3	Input values .....	130	15.1.2	For the sensor .....	159
11.4.4	Output values .....	131	15.2	Communication-specific accessories .....	159
11.5	Adapting the measuring device to the process conditions .....	132	15.3	Service-specific accessories .....	160
11.6	Performing a totalizer reset .....	132	15.4	System components .....	160
			<b>16</b>	<b>Technical data .....</b>	<b>162</b>
			16.1	Application .....	162
			16.2	Function and system design .....	162
			16.3	Input .....	162
			16.4	Output .....	168

16.5	Power supply . . . . .	171
16.6	Performance characteristics . . . . .	173
16.7	Installation . . . . .	176
16.8	Environment . . . . .	176
16.9	Process . . . . .	177
16.10	Mechanical construction . . . . .	177
16.11	Operability . . . . .	183
16.12	Certificates and approvals . . . . .	185
16.13	Application packages . . . . .	186
16.14	Accessories . . . . .	187
16.15	Supplementary documentation . . . . .	187
<b>Index</b>	. . . . .	<b>189</b>





# 1 Document information

## 1.1 Document function







These Operating Instructions contain all the information that is required in various phases of the life cycle of the device: from product identification, incoming acceptance and storage, to mounting, connection, operation and commissioning through to troubleshooting, maintenance and disposal.

## 1.2 Symbols used



### 1.2.1 Safety symbols

Symbol	Meaning
	<b>DANGER!</b> This symbol alerts you to a dangerous situation. Failure to avoid this situation will result in serious or fatal injury.
	<b>WARNING!</b> This symbol alerts you to a dangerous situation. Failure to avoid this situation can result in serious or fatal injury.
	<b>CAUTION!</b> This symbol alerts you to a dangerous situation. Failure to avoid this situation can result in minor or medium injury.
	<b>NOTE!</b> This symbol contains information on procedures and other facts which do not result in personal injury.





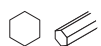





### 1.2.2 Electrical symbols

Symbol	Meaning	Symbol	Meaning
	Direct current		Alternating current
	Direct current and alternating current		<b>Ground connection</b> A grounded terminal which, as far as the operator is concerned, is grounded via a grounding system.
	<b>Protective ground connection</b> A terminal which must be connected to ground prior to establishing any other connections.		<b>Equipotential connection</b> A connection that has to be connected to the plant grounding system: This may be a potential equalization line or a star grounding system depending on national or company codes of practice.





### 1.2.3 Tool symbols

Symbol	Meaning
	Flat blade screwdriver
	Allen key
	Open-ended wrench

### 1.2.4 Symbols for certain types of information

Symbol	Meaning
	<b>Permitted</b> Procedures, processes or actions that are permitted.
	<b>Preferred</b> Procedures, processes or actions that are preferred.
	<b>Forbidden</b> Procedures, processes or actions that are forbidden.
	<b>Tip</b> Indicates additional information.
	Reference to documentation
	Reference to page
	Reference to graphic
	Series of steps
	Result of a step
	Help in the event of a problem
	Visual inspection

### 1.2.5 Symbols in graphics

Symbol	Meaning	Symbol	Meaning
1, 2, 3,...	Item numbers		Series of steps
A, B, C, ...	Views	A-A, B-B, C-C, ...	Sections
	Hazardous area		Safe area (non-hazardous area)
	Flow direction		

## 1.3 Documentation

 For an overview of the scope of the associated Technical Documentation, refer to the following:

- The *W@M Device Viewer* : Enter the serial number from the nameplate ([www.endress.com/deviceviewer](http://www.endress.com/deviceviewer))
- The *Endress+Hauser Operations App*: Enter the serial number from the nameplate or scan the 2-D matrix code (QR code) on the nameplate.

 For a detailed list of the individual documents along with the documentation code

### 1.3.1 Standard documentation

Document type	Purpose and content of the document
Technical Information	<b>Planning aid for your device</b> The document contains all the technical data on the device and provides an overview of the accessories and other products that can be ordered for the device.
Brief Operating Instructions	<b>Guide that takes you quickly to the 1st measured value</b> The Brief Operating Instructions contain all the essential information from incoming acceptance to initial commissioning.

### 1.3.2 Supplementary device-dependent documentation

Additional documents are supplied depending on the device version ordered: Always comply strictly with the instructions in the supplementary documentation. The supplementary documentation is an integral part of the device documentation.

## 1.4 Registered trademarks

### HART®

Registered trademark of the HART Communication Foundation, Austin, USA

### KALREZ®, VITON®

Registered trademarks of DuPont Performance Elastomers L.L.C., Wilmington, DE USA

### GYLON®

Registered trademark of Garlock Sealing Technologies, Palmyra, NY, USA

### Applicator®, FieldCare®, DeviceCare®, Field Xpert™, HistoROM®, Heartbeat Technology™

Registered or registration-pending trademarks of the Endress+Hauser Group



## 2 Basic safety instructions

### 2.1 Requirements for the personnel

The personnel for installation, commissioning, diagnostics and maintenance must fulfill the following requirements:

- ▶ Trained, qualified specialists must have a relevant qualification for this specific function and task
- ▶ Are authorized by the plant owner/operator
- ▶ Are familiar with federal/national regulations
- ▶ Before beginning work, the specialist staff must have read and understood the instructions in the Operating Instructions and supplementary documentation as well as in the certificates (depending on the application)
- ▶ Following instructions and basic conditions

The operating personnel must fulfill the following requirements:

- ▶ Being instructed and authorized according to the requirements of the task by the facility's owner-operator
- ▶ Following the instructions in these Operating Instructions

### 2.2 Designated use

#### Application and media

Depending on the version ordered, the measuring device can also measure potentially explosive, flammable, poisonous and oxidizing media.

Measuring devices for use in hazardous areas, in hygienic applications or in applications where there is an increased risk due to process pressure, are labeled accordingly on the nameplate.

To ensure that the measuring device remains in proper condition for the operation time:

- ▶ Only use the measuring device in full compliance with the data on the nameplate and the general conditions listed in the Operating Instructions and supplementary documentation.
- ▶ Check the nameplate to verify if the device ordered can be put to its intended use in the approval-related area (e.g. explosion protection, pressure vessel safety).
- ▶ Use the measuring device only for media against which the process-wetted materials are adequately resistant.
- ▶ If the measuring device is not operated at atmospheric temperature, compliance with the relevant basic conditions specified in the associated device documentation is absolutely essential: "Documentation" section →  7.
- ▶ Protect the measuring device permanently against corrosion from environmental influences.

#### Incorrect use

Non-designated use can compromise safety. The manufacturer is not liable for damage caused by improper or non-designated use.

#### **WARNING**

#### **Danger of breakage of the sensor due to corrosive or abrasive fluids or from environmental conditions!**

- ▶ Verify the compatibility of the process fluid with the sensor material.
- ▶ Ensure the resistance of all fluid-wetted materials in the process.
- ▶ Keep within the specified pressure and temperature range.

Verification for borderline cases:

- ▶ For special fluids and fluids for cleaning, Endress+Hauser is glad to provide assistance in verifying the corrosion resistance of fluid-wetted materials, but does not accept any

warranty or liability as minute changes in the temperature, concentration or level of contamination in the process can alter the corrosion resistance properties.

### **Residual risks**

Possible burn hazard due to fluid temperatures!

- ▶ For elevated fluid temperature, ensure protection against contact to prevent burns.

## **2.3 Workplace safety**

For work on and with the device:

- ▶ Wear the required personal protective equipment according to federal/national regulations.

For welding work on the piping:

- ▶ Do not ground the welding unit via the measuring device.

If working on and with the device with wet hands:

- ▶ It is recommended to wear gloves on account of the higher risk of electric shock.

## **2.4 Operational safety**

Risk of injury.

- ▶ Operate the device in proper technical condition and fail-safe condition only.
- ▶ The operator is responsible for interference-free operation of the device.

### **Conversions to the device**

Unauthorized modifications to the device are not permitted and can lead to unforeseeable dangers.

- ▶ If, despite this, modifications are required, consult with Endress+Hauser.

### **Repair**

To ensure continued operational safety and reliability,

- ▶ Carry out repairs on the device only if they are expressly permitted.
- ▶ Observe federal/national regulations pertaining to repair of an electrical device.
- ▶ Use original spare parts and accessories from Endress+Hauser only.

## **2.5 Product safety**

This measuring device is designed in accordance with good engineering practice to meet state-of-the-art safety requirements, has been tested, and left the factory in a condition in which it is safe to operate.

It meets general safety standards and legal requirements. It also complies with the EC directives listed in the device-specific EC Declaration of Conformity. Endress+Hauser confirms this by affixing the CE mark to the device.

## **2.6 IT security**

We only provide a warranty if the device is installed and used as described in the Operating Instructions. The device is equipped with security mechanisms to protect it against any inadvertent changes to the device settings.

IT security measures in line with operators' security standards and designed to provide additional protection for the device and device data transfer must be implemented by the operators themselves.

### 3 Product description

The device consists of a transmitter and a sensor.

Two device versions are available:

- Compact version – transmitter and sensor form a mechanical unit.
- Remote version - transmitter and sensor are mounted in separate locations.

#### 3.1 Product design

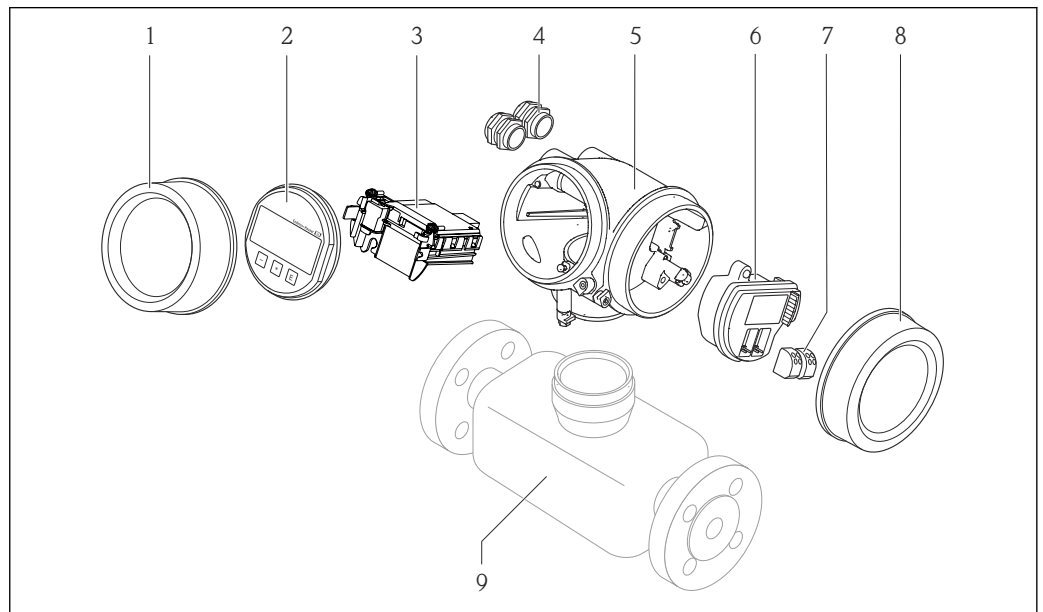













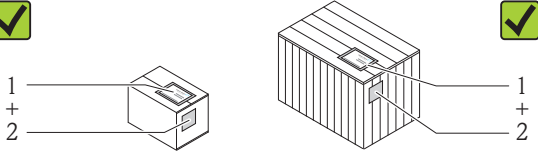

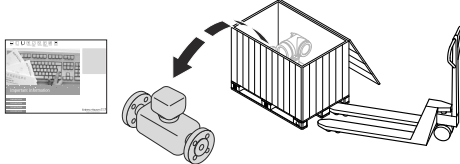
A0020649

#### 1 Important components of a measuring device

- 1 Electronics compartment cover
- 2 Display module
- 3 Main electronics module
- 4 Cable glands
- 5 Transmitter housing (incl. HistoROM)
- 6 I/O electronics module
- 7 Terminals (pluggable spring terminals)
- 8 Connection compartment cover
- 9 Sensor

## 4 Incoming acceptance and product identification

### 4.1 Incoming acceptance

				<p>Are the order codes on the delivery note (1) and the product sticker (2) identical?</p>
				
				<p>Are the goods undamaged?</p>
				<p>Do the nameplate data match the ordering information on the delivery note?</p>
				<p>Is the CD-ROM with the Technical Documentation (depends on device version) and documents present?</p>



-  If one of the conditions is not satisfied, contact your Endress+Hauser Sales Center.
- Depending on the device version, the CD-ROM might not be part of the delivery! The Technical Documentation is available via the Internet or via the *Endress+Hauser Operations App*, see the "Product identification" section → 13.

### 4.2 Product identification

The following options are available for identification of the measuring device:

- Nameplate specifications
- Order code with breakdown of the device features on the delivery note
- Enter serial numbers from nameplates in *W@M Device Viewer* ([www.endress.com/deviceviewer](http://www.endress.com/deviceviewer)): All information about the measuring device is displayed.
- Enter the serial number from the nameplates into the *Endress+Hauser Operations App* or scan the 2-D matrix code (QR code) on the nameplate with the *Endress+Hauser Operations App*: all the information for the measuring device is displayed.

For an overview of the scope of the associated Technical Documentation, refer to the following:

- The chapters "Additional standard documentation on the device" →  8 and "Supplementary device-dependent documentation" →  8
- The *W@M Device Viewer*: Enter the serial number from the nameplate ([www.endress.com/deviceviewer](http://www.endress.com/deviceviewer))
- The *Endress+Hauser Operations App*: Enter the serial number from the nameplate or scan the 2-D matrix code (QR code) on the nameplate.

### 4.2.1 Transmitter nameplate

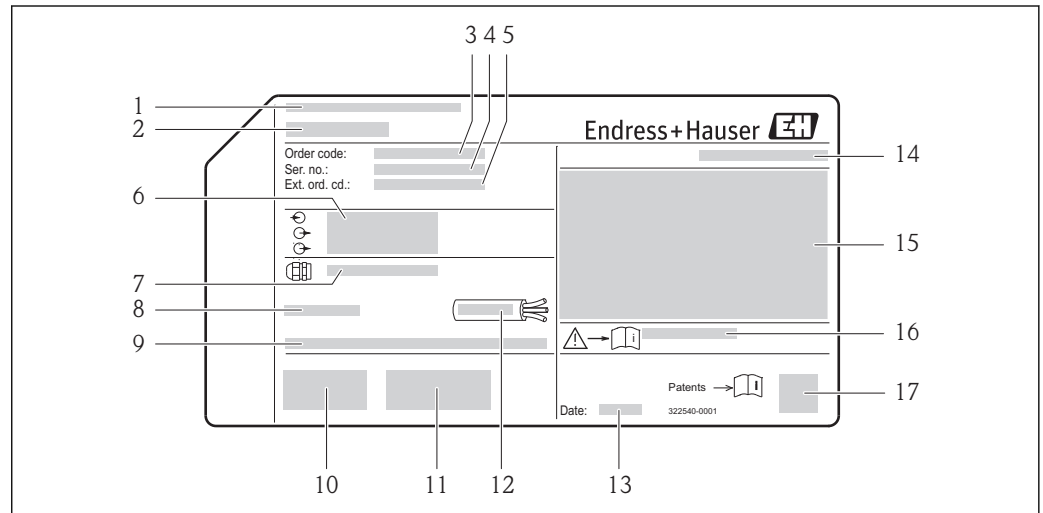

 2 Example of a transmitter nameplate

- 1 Manufacturing location
- 2 Name of the transmitter
- 3 Order code
- 4 Serial number (Ser. no.)
- 5 Extended order code (Ext. ord. cd.)
- 6 Electrical connection data, e.g. available inputs and outputs, supply voltage
- 7 Type of cable glands
- 8 Permitted ambient temperature ( $T_a$ )
- 9 Firmware version (FW) and device revision (Dev.Rev.) from the factory
- 10 CE mark, C-Tick
- 11 Additional information on version: certificates, approvals
- 12 Permitted temperature range for cable
- 13 Manufacturing date: year-month
- 14 Degree of protection
- 15 Approval information for explosion protection
- 16 Document number of safety-related supplementary documentation
- 17 2-D matrix code

### 4.2.2 Sensor nameplate

Order code for "Housing" option B "GT18 two-chamber, 316L" and option K "GT18 two-chamber, remote, 316L"

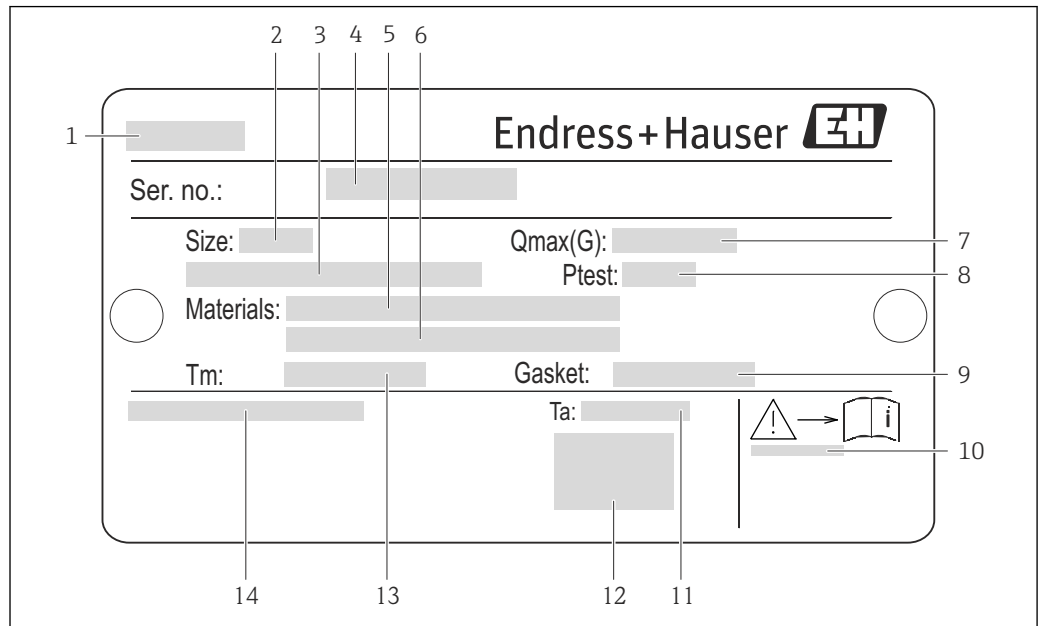

A0020760

3 Example of a sensor nameplate

- 1 Name of the sensor
- 2 Nominal diameter of the sensor
- 3 Flange nominal diameter/nominal pressure
- 4 Serial number (Ser. no.)
- 5 Measuring tube material
- 6 Measuring tube material
- 7 Maximal permitted volume flow (gas/steam)
- 8 Test pressure of the sensor
- 9 Seal material
- 10 Document number of safety-related supplementary documentation → 187
- 11 Ambient temperature range
- 12 CE mark
- 13 Medium temperature range
- 14 Degree of protection

## Order code for "Housing" option C "GT20 two-chamber, aluminum coated"

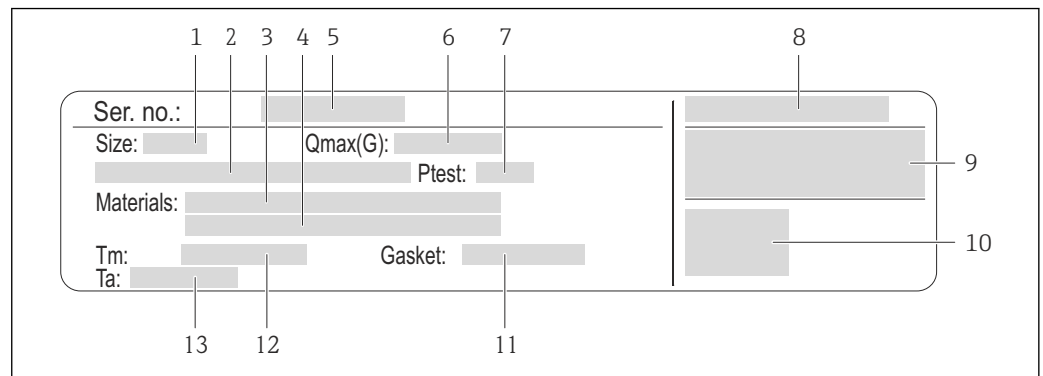

A0020758

4 Example of a sensor nameplate

- 1 Nominal diameter of the sensor
- 2 Flange nominal diameter/nominal pressure
- 3 Measuring tube material
- 4 Measuring tube material
- 5 Serial number (Ser. no.)
- 6 Maximal permitted volume flow (gas/steam)
- 7 Test pressure of the sensor
- 8 Degree of protection
- 9 Approval information for explosion protection and Pressure Equipment Directive
- 10 CE mark
- 11 Seal material
- 12 Medium temperature range
- 13 Ambient temperature range

Order code for "Housing" option J "GT20 two-chamber, remote, aluminum coated"

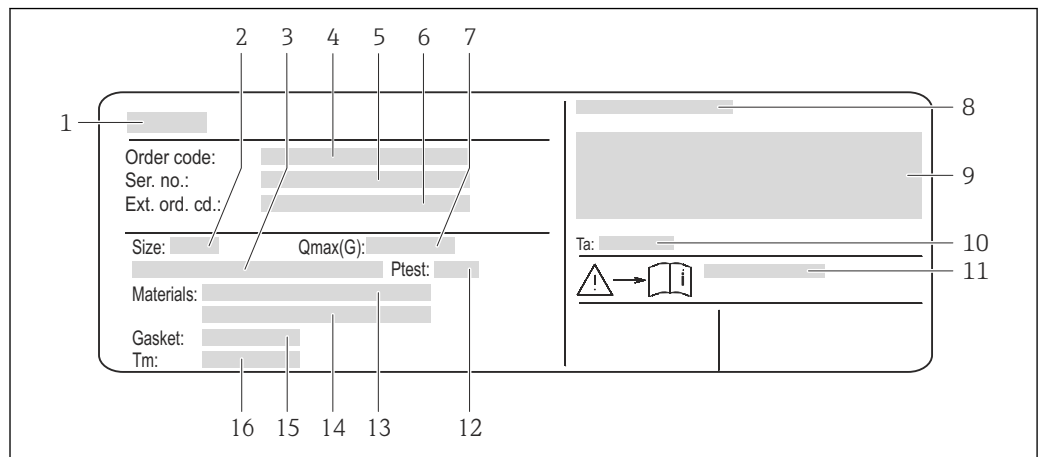

A0020759

5 Example of a sensor nameplate

- 1 Name of the sensor
- 2 Nominal diameter of the sensor
- 3 Flange nominal diameter/nominal pressure
- 4 Order code
- 5 Serial number (Ser. no.)
- 6 Extended order code (Ext. ord. cd.)
- 7 Maximal permitted volume flow (gas/steam)
- 8 Degree of protection
- 9 Approval information for explosion protection and Pressure Equipment Directive
- 10 Ambient temperature range
- 11 Document number of safety-related supplementary documentation → 187
- 12 Test pressure of the sensor
- 13 Measuring tube material
- 14 Measuring tube material
- 15 Seal material
- 16 Medium temperature range

**i** Order code

The measuring device is reordered using the order code.

**Extended order code**

- The device type (product root) and basic specifications (mandatory features) are always listed.
- Of the optional specifications (optional features), only the safety and approval-related specifications are listed (e.g. LA). If other optional specifications are also ordered, these are indicated collectively using the # placeholder symbol (e.g. #LA#).
- If the ordered optional specifications do not include any safety and approval-related specifications, they are indicated by the + placeholder symbol (e.g. XXXXXX-ABCDE +).

4.2.3 Symbols on measuring device

Symbol	Meaning
	<b>WARNING!</b> This symbol alerts you to a dangerous situation. Failure to avoid this situation can result in serious or fatal injury.
	<b>Reference to documentation</b> Refers to the corresponding device documentation.
	<b>Protective ground connection</b> A terminal which must be connected to ground prior to establishing any other connections.



## 5 Storage and transport

### 5.1 Storage conditions

Observe the following notes for storage:

- Store in the original packaging to ensure protection from shock.
- Do not remove protective covers or protective caps installed on process connections. They prevent mechanical damage to the sealing surfaces and contamination in the measuring tube.
- Protect from direct sunlight to avoid unacceptably high surface temperatures.
- Store in a dry and dust-free place.
- Do not store outdoors.

Storage temperature:

- All components apart from the display modules:  $-50$  to  $+80$  °C ( $-58$  to  $+176$  °F)
- Display modules:  $-40$  to  $+80$  °C ( $-40$  to  $+176$  °F)

### 5.2 Transporting the product

Transport the measuring device to the measuring point in the original packaging.

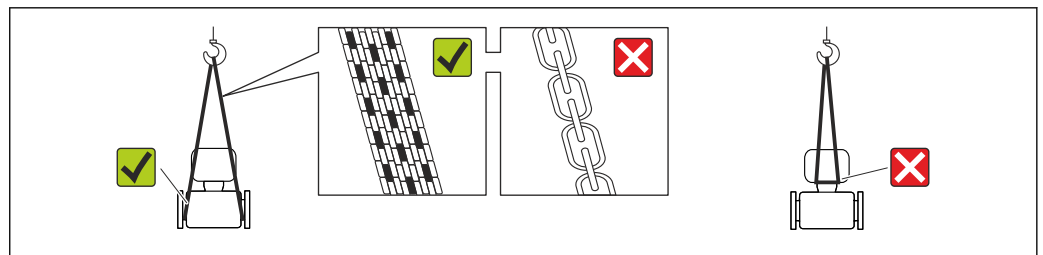

A0015604

- i** Do not remove protective covers or caps installed on process connections. They prevent mechanical damage to the sealing surfaces and contamination in the measuring tube.

#### 5.2.1 Measuring devices without lifting lugs

##### **⚠ WARNING**

**Center of gravity of the measuring device is higher than the suspension points of the webbing slings.**

Risk of injury if the measuring device slips.

- ▶ Secure the measuring device against slipping or turning.
- ▶ Observe the weight specified on the packaging (stick-on label).

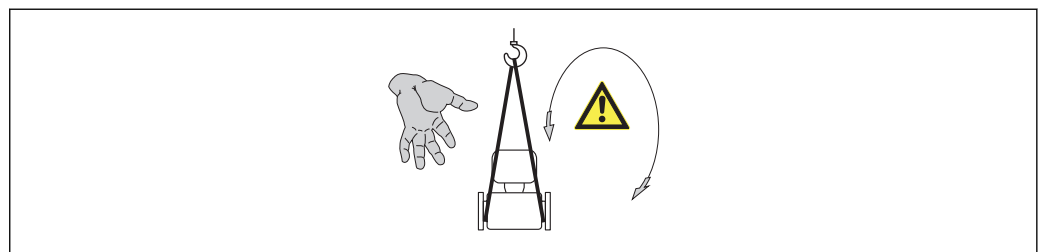

A0015606

## 5.2.2 Measuring devices with lifting lugs

### CAUTION

#### Special transportation instructions for devices with lifting lugs

- ▶ Only use the lifting lugs fitted on the device or flanges to transport the device.
- ▶ The device must always be secured at two lifting lugs at least.

## 5.2.3 Transporting with a fork lift

If transporting in wood crates, the floor structure enables the crates to be lifted lengthwise or at both sides using a forklift.

## 5.3 Packaging disposal

All packaging materials are environmentally friendly and 100% recyclable:

- Measuring device secondary packaging: polymer stretch film that conforms to EC Directive 2002/95/EC (RoHS).
- Packaging:
  - Wood crate, treated in accordance with ISPM 15 standard, which is confirmed by the affixed IPPC logo.
  - or
  - Carton in accordance with European Packaging Directive 94/62EC; recyclability is confirmed by the affixed RESY symbol.
- Seaworthy packaging (optional): Wood crate, treated in accordance with ISPM 15 standard, which is confirmed by the affixed IPPC logo.
- Carrying and mounting hardware:
  - Disposable plastic pallet
  - Plastic straps
  - Plastic adhesive strips
- Dunnage: Paper cushion

## 6 Installation

### 6.1 Installation conditions

#### 6.1.1 Mounting position

##### Mounting location

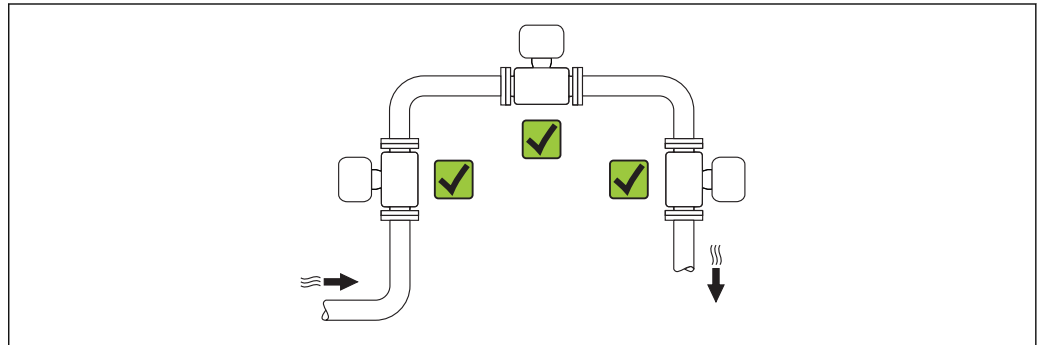

A0015543

##### Orientation

The direction of the arrow on the sensor nameplate helps you to install the sensor according to the flow direction (direction of medium flow through the piping).

Vortex meters require a fully developed flow profile as a prerequisite for correct volume flow measurement. Therefore, please note the following:

Orientation		Compact version	Remote version
<b>A</b>	Vertical orientation	✓✓ <sup>1)</sup>	✓✓
<b>B</b>	Horizontal orientation, transmitter head up	✓✓ <sup>2) 3)</sup>	✓✓
<b>C</b>	Horizontal orientation, transmitter head down	✓✓ <sup>4) 5)</sup>	✓✓
<b>D</b>	Horizontal orientation, transmitter head at side	✓✓ <sup>4)</sup>	✓✓

- 1) In the case of liquids, there should be upward flow in vertical pipes to avoid partial pipe filling (Fig. A). Disruption in flow measurement! In the case of vertical orientation and downward flowing liquid, the pipe always needs to be completely filled to ensure correct liquid flow measurement.
- 2) Danger of electronics overheating! If the fluid temperature is  $\geq 200\text{ °C}$  ( $392\text{ °F}$ ) orientation B is not permitted for the wafer version (Prowirl D) with nominal diameters DN 100 (4") and DN 150 (6").
- 3) In the case of hot media (e.g. steam or fluid temperature (TM)  $\geq 200\text{ °C}$  ( $392\text{ °F}$ ): orientation C or D
- 4) In the case of very cold media (e.g. liquid nitrogen): orientation B or D
- 5) For "wet steam detection/measurement" option: orientation C

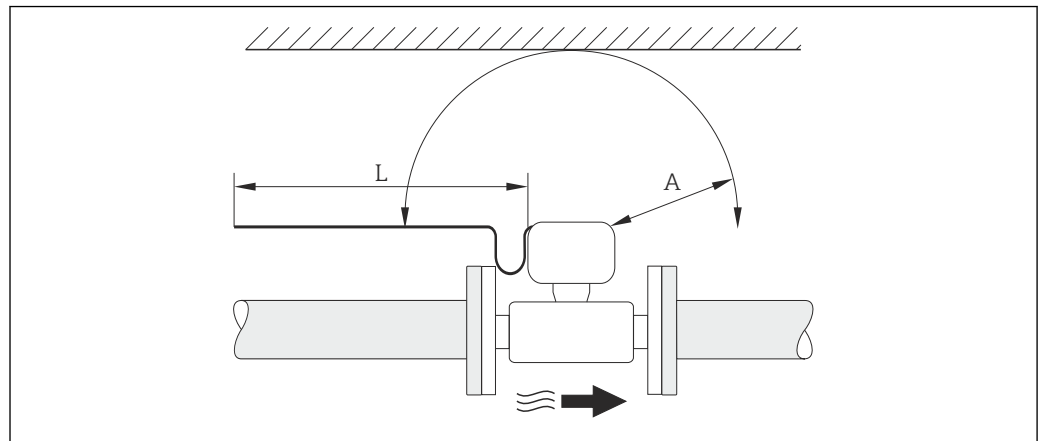
*Minimum spacing and cable length*

A0019211

- A* Minimum spacing in all directions  
*L* Required cable length

The following dimensions must be observed to guarantee problem-free access to the device for service purposes:

- $A = 100 \text{ mm}$  (3.94 in)
- $L = L + 150 \text{ mm}$  (5.91 in)

*Rotating the electronics housing and the display*

The electronics housing can be rotated continuously by  $360^\circ$  on the housing support. The display unit can be rotated in  $45^\circ$  stages. This means you can read the display comfortably from all directions.

**Inlet and outlet runs**

To attain the specified level of accuracy of the measuring device, the inlet and outlet runs mentioned below must be maintained at the very minimum.

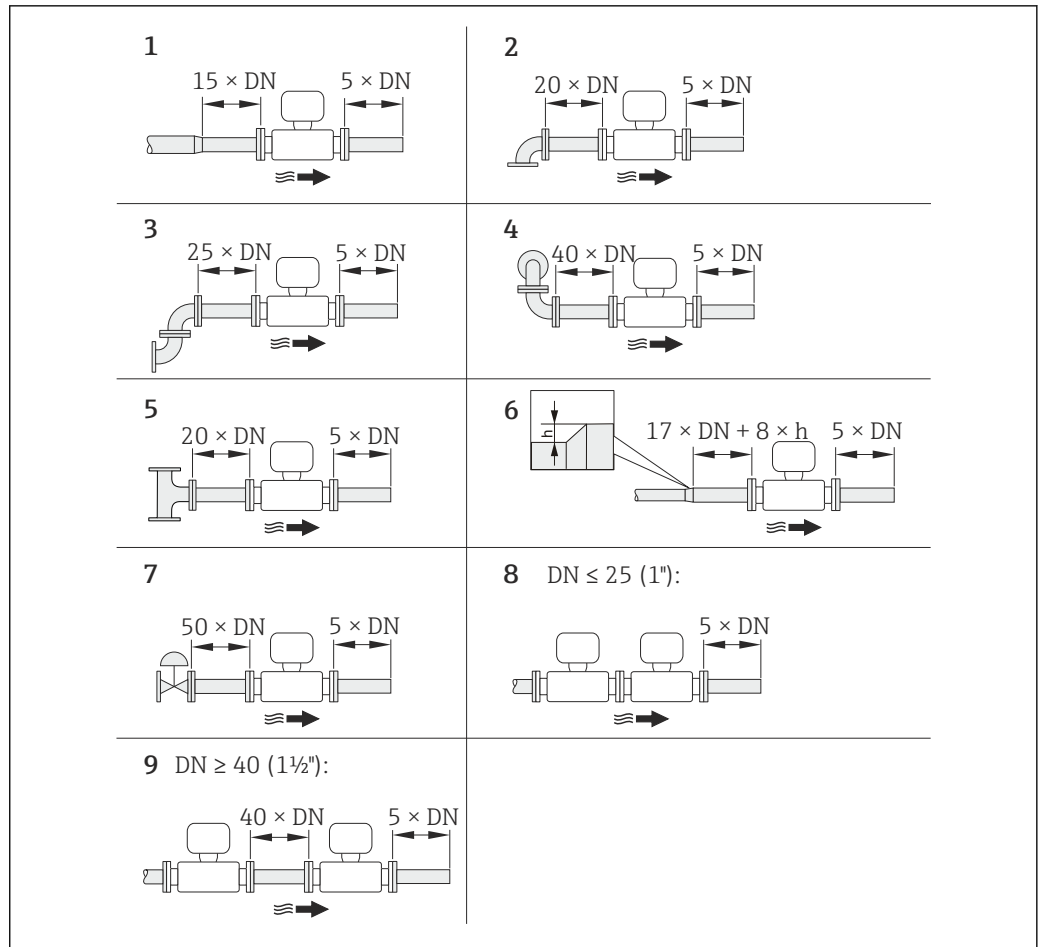

A0019189

6 Minimum inlet and outlet runs with various flow obstructions

*h* Difference in expansion

1 Reduction by one nominal diameter size

2 Single elbow (90° elbow)

3 Double elbow (2 × 90° elbows, opposite)

4 Double elbow 3D (2 × 90° elbows, opposite, not on one plane)

5 T-piece

6 Expansion

7 Control valve

8 Two measuring devices in a row where  $DN \leq 25$  (1"): directly flange on flange

9 Two measuring devices in a row where  $DN \geq 40$  (1½"): for spacing, see graphic

**i** ■ If there are several flow disturbances present, the longest specified inlet run must be maintained.

■ If the required inlet runs cannot be observed, it is possible to install a specially designed flow conditioner → 24.

#### Flow conditioner

If the required inlet runs cannot be observed, it is possible to install a specially designed flow conditioner which can be ordered from Endress+Hauser. The flow conditioner is fitted between two pipe flanges and centered by the mounting bolts. Generally this reduces the inlet run needed to  $10 \times DN$  with full accuracy.

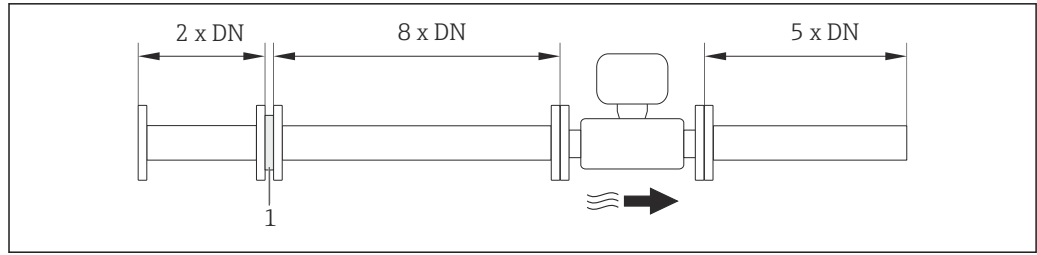

1 Flow conditioner

The pressure loss for flow conditioners is calculated as follows:  $\Delta p \text{ [mbar]} = 0.0085 \cdot \rho \text{ [kg/m}^3\text{]} \cdot v^2 \text{ [m/s]}$

Example for steam

$p = 10 \text{ bar abs.}$

$t = 240 \text{ }^\circ\text{C} \rightarrow \rho = 4.39 \text{ kg/m}^3$

$v = 40 \text{ m/s}$

$\Delta p = 0.0085 \cdot 4.39 \cdot 40^2 = 59.7 \text{ mbar}$

Example for H<sub>2</sub>O condensate (80 °C)

$\rho = 965 \text{ kg/m}^3$

$v = 2.5 \text{ m/s}$

$\Delta p = 0.0085 \cdot 965 \cdot 2.5^2 = 51.3 \text{ mbar}$

$\rho$  : density of the process medium

$v$ : average flow velocity

abs. = absolute

 For the dimensions of the flow conditioner, see the "Technical Information" document, "Mechanical construction" section

*Outlet runs when installing external devices*

If installing an external device, observe the specified distance.

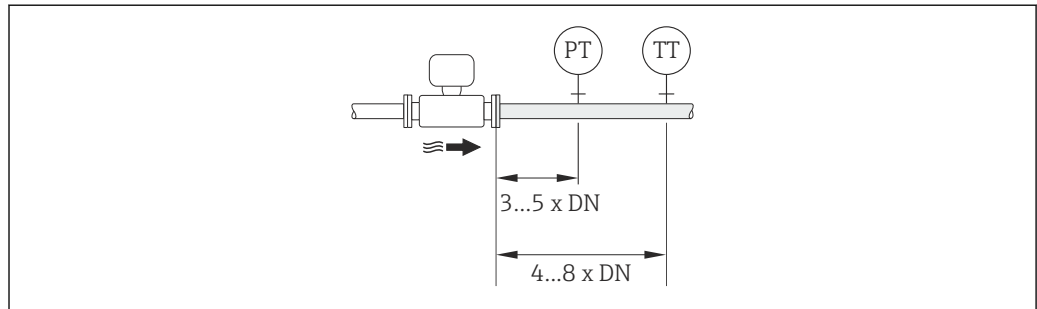

PT Pressure transmitter

TT Temperature transmitter

*Installation dimensions*

 For the dimensions and installation lengths of the device, see the "Technical Information" document, "Mechanical construction" section

## 6.1.2 Requirements from environment and process

### Ambient temperature range

#### Compact version

<b>Measuring device</b>	Non-Ex:	-40 to +80 °C (-40 to +176 °F) <sup>1)</sup>
	Ex i:	-40 to +70 °C (-40 to +158 °F) <sup>1)</sup>
	EEx d/XP version:	-40 to +60 °C (-40 to +140 °F) <sup>1)</sup>
	ATEX II1/2G Ex d, Ex ia:	-40 to +60 °C (-40 to +140 °F) <sup>1)</sup>
<b>Local display</b>		-20 to +70 °C (-4 to +158 °F) <sup>1)</sup>

1) Additionally available as order code for "Test, certificate", option JN "Transmitter ambient temperature -50 °C (-58 °F)".

#### Remote version

<b>Transmitter</b>	Non-Ex:	-40 to +80 °C (-40 to +176 °F) <sup>1)</sup>
	Ex i:	-40 to +80 °C (-40 to +176 °F) <sup>1)</sup>
	Ex d:	-40 to +60 °C (-40 to +140 °F) <sup>1)</sup>
	ATEX II1/2G Ex d, Ex ia:	-40 to +60 °C (-40 to +140 °F) <sup>1)</sup>
<b>Sensor</b>	Non-Ex:	-40 to +85 °C (-40 to +185 °F) <sup>1)</sup>
	Ex i:	-40 to +85 °C (-40 to +185 °F) <sup>1)</sup>
	Ex d:	-40 to +85 °C (-40 to +185 °F) <sup>1)</sup>
	ATEX II1/2G Ex d, Ex ia:	-40 to +85 °C (-40 to +185 °F) <sup>1)</sup>
<b>Local display</b>		-20 to +70 °C (-4 to +158 °F) <sup>1)</sup>

1) Additionally available as order code for "Test, certificate", option JN "Transmitter ambient temperature -50 °C (-58 °F)".

- ▶ If operating outdoors:  
Avoid direct sunlight, particularly in warm climatic regions.

### Thermal insulation

For optimum temperature measurement and mass calculation, heat transfer at the sensor must be avoided for some fluids. This can be ensured by installing thermal insulation. A wide range of materials can be used for the required insulation.

This applies for:

- Compact version
- Remote sensor version

The maximum insulation height permitted is illustrated in the diagram:

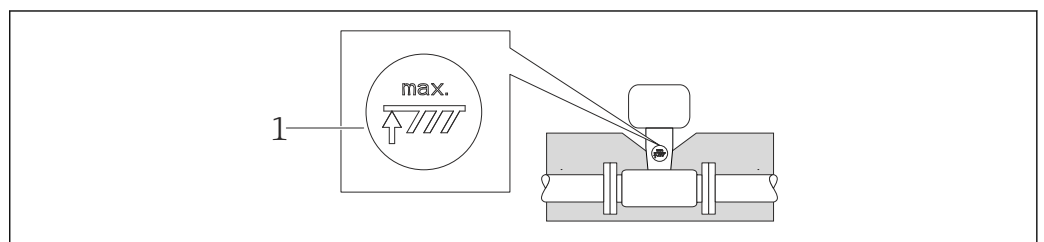

1 Maximum insulation height

A0019212

- ▶ When insulating, ensure that a sufficiently large area of the housing support remains exposed.

The uncovered part serves as a radiator and protects the electronics from overheating and excessive cooling.

#### NOTICE

#### Electronics overheating on account of thermal insulation!

- ▶ Observe the maximum permitted insulation height of the transmitter neck so that the transmitter head and/or the connection housing of the remote version is completely free.
- ▶ Observe information on the permissible temperature ranges .
- ▶ Note that a certain orientation might be required, depending on the fluid temperature → ☞ 19.

#### Vibrations

The correct operation of the measuring system is not affected by plant vibrations up to 1 g, 10 to 500 Hz. Therefore no special measures are needed to secure the sensors.

### 6.1.3 Special mounting instructions

#### Installation for delta heat measurements

Order code for "Sensor version", option 3 "Mass flow (integrated temperature measurement)"

The second temperature measurement is taken using a separate temperature sensor. The measuring device reads in this value via a communication interface.

- In the case of saturated steam delta heat measurements, the Prowirl 200 must be installed on the steam side.
- In the case of water delta heat measurements, the Prowirl 200 can be installed on the cold or warm side.

**i** In the case of saturated steam delta heat measurements, the value **0 bar abs.** must be set in the **Fixed process pressure** parameter (→ ☞ 71) in order for the measuring device to calculate on the saturated steam curve. The current input can then be used to read in the temperature.

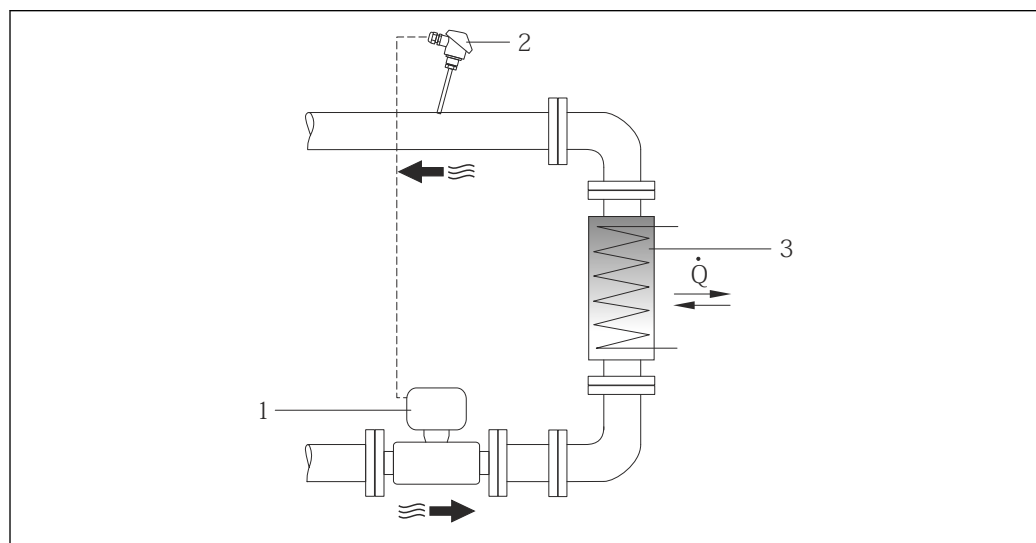

☞ 7 Layout for delta heat measurement of saturated steam and water

- 1 Prowirl
- 2 Temperature sensor
- 3 Heat exchanger
- Q Heat flow



**Weather protection cover**

Observe the following minimum head clearance: 222 mm (8.74 in)

 For information on the weather protection cover, see →  158

**6.2 Mounting the measuring device****6.2.1 Required tools****For transmitter**

- For turning the transmitter housing: Open-ended wrench 8 mm
- For opening the securing clamps: Allen key 3 mm

**For sensor**

For flanges and other process connections: Corresponding mounting tools

**6.2.2 Preparing the measuring device**

1. Remove all remaining transport packaging.
2. Remove any protective covers or protective caps present from the sensor.
3. Remove stick-on label on the electronics compartment cover.

**6.2.3 Mounting the sensor**** WARNING****Danger due to improper process sealing!**

- ▶ Ensure that the inside diameters of the gaskets are greater than or equal to that of the process connections and piping.
- ▶ Ensure that the gaskets are clean and undamaged.
- ▶ Install the gaskets correctly.

1. Ensure that the direction of the arrow on the sensor matches the flow direction of the medium.
2. To ensure compliance with device specifications, install the measuring device between the pipe flanges in a way that it is centered in the measurement section.
3. Install the measuring device or turn the transmitter housing so that the cable entries do not point upwards.

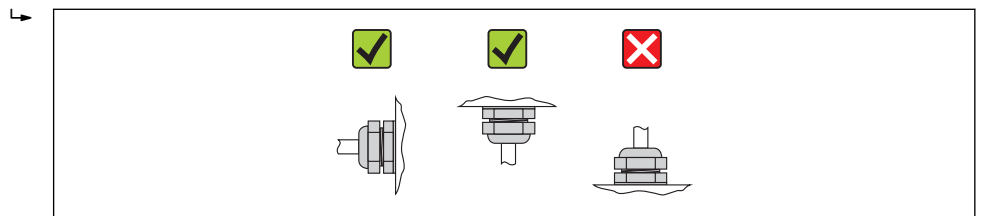

A0013964

## 6.2.4 Mounting the transmitter of the remote version

### ⚠ CAUTION

#### Ambient temperature too high!

Danger of electronics overheating and housing deformation.

- ▶ Do not exceed the permitted maximum ambient temperature .
- ▶ If operating outdoors: Avoid direct sunlight and exposure to weathering, particularly in warm climatic regions.

### ⚠ CAUTION

#### Excessive force can damage the housing!

- ▶ Avoid excessive mechanical stress.

The transmitter of the remote version can be mounted in the following ways:

- Wall mounting
- Pipe mounting

#### Wall mounting

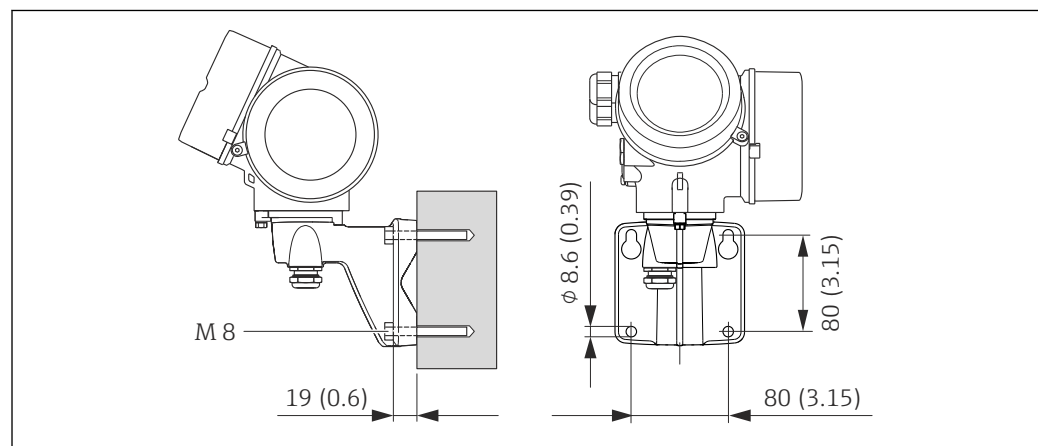

8 Engineering unit mm (in)

1. Drill the holes.
2. Insert wall plugs into the drilled holes.
3. Screw in the securing screws slightly at first.
4. Fit the transmitter housing over the securing screws and mount in place.
5. Tighten the securing screws.

### Post mounting

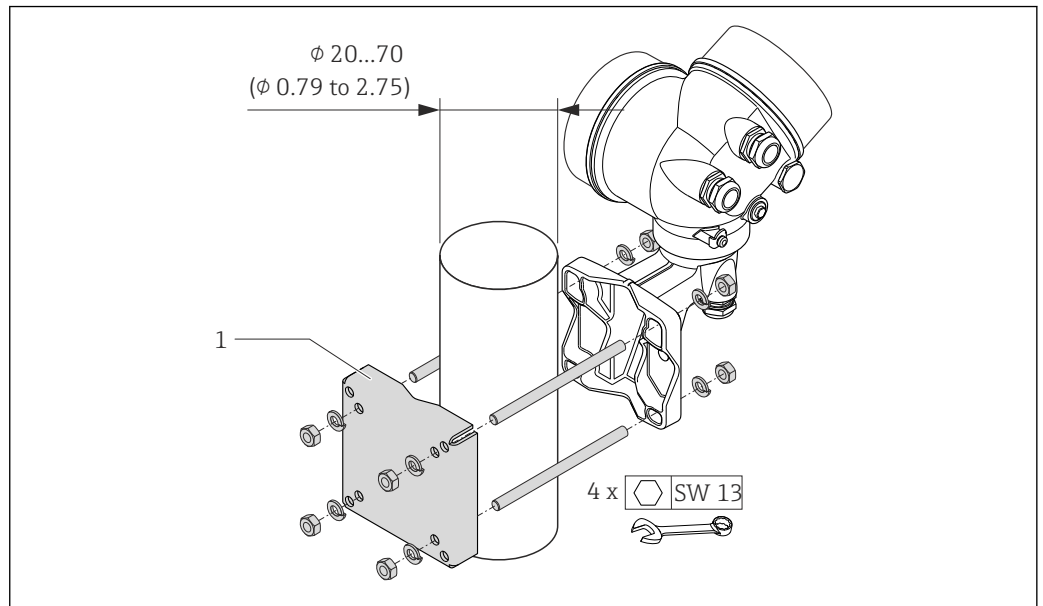

9 Engineering unit mm (in)

1 Post retainer kit for post mounting

### 6.2.5 Turning the transmitter housing

To provide easier access to the connection compartment or display module, the transmitter housing can be turned.

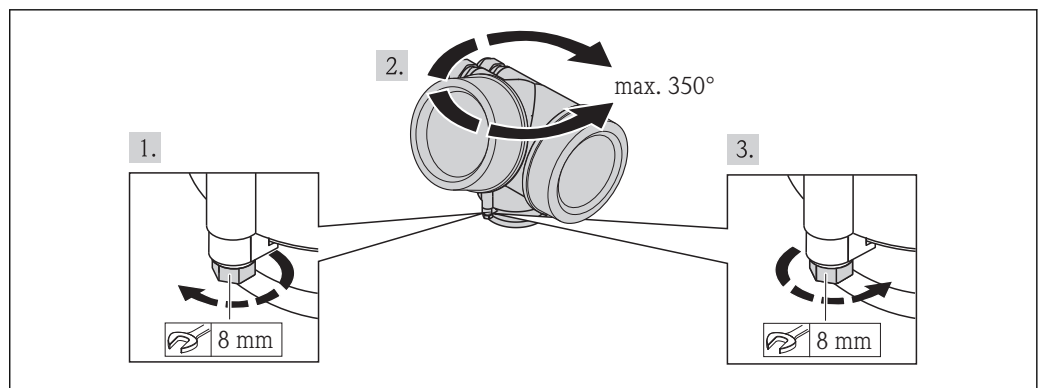

1. Release the fixing screw.
2. Turn the housing to the desired position.
3. Firmly tighten the securing screw.

### 6.2.6 Turning the display module

The display module can be turned to optimize display readability and operability.

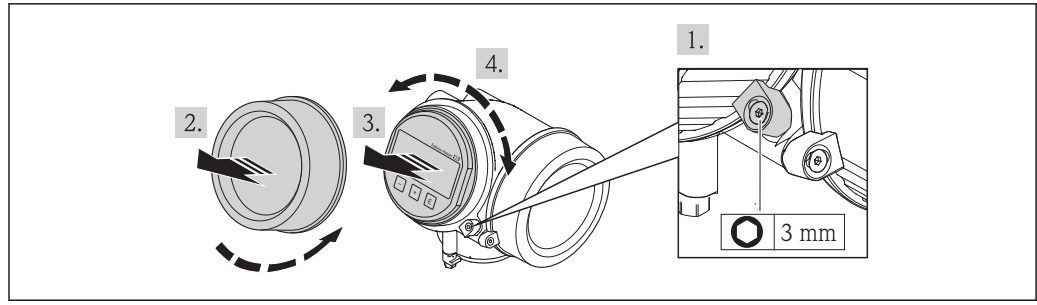

A0013905

1. Loosen the securing clamp of the electronics compartment cover using an Allen key.
2. Unscrew cover of the electronics compartment from the transmitter housing.
3. Optional: pull out the display module with a gentle rotational movement.
4. Rotate the display module into the desired position: Max.  $8 \times 45^\circ$  in each direction.
5. Without display module pulled out:  
Allow display module to engage at desired position.
6. With display module pulled out:  
Feed the cable into the gap between the housing and main electronics module and plug the display module into the electronics compartment until it engages.
7. Reverse the removal procedure to reassemble the transmitter.

### 6.3 Post-installation check

Is the device undamaged (visual inspection)?	<input type="checkbox"/>
Does the measuring device conform to the measuring point specifications? For example: <ul style="list-style-type: none"> <li>▪ Process temperature</li> <li>▪ Process pressure (refer to the section on "Pressure-temperature ratings" in the "Technical Information" document )</li> <li>▪ Ambient temperature</li> <li>▪ Measuring range → 166</li> </ul>	<input type="checkbox"/>
Has the correct orientation for the sensor been selected → 19? <ul style="list-style-type: none"> <li>▪ According to sensor type</li> <li>▪ According to medium temperature</li> <li>▪ According to medium properties (outgassing, with entrained solids)</li> </ul>	<input type="checkbox"/>
Does the arrow on the sensor nameplate match the direction of flow of the fluid through the piping → 19?	<input type="checkbox"/>
Are the measuring point identification and labeling correct (visual inspection)?	<input type="checkbox"/>
Is the device adequately protected from precipitation and direct sunlight?	<input type="checkbox"/>
Are the securing screw and securing clamp tightened securely?	<input type="checkbox"/>

## 7 Electrical connection

 The measuring device does not have an internal circuit breaker. For this reason, assign the measuring device a switch or power-circuit breaker so that the power supply line can be easily disconnected from the mains.

### 7.1 Connection conditions

#### 7.1.1 Required tools

- For cable entries: Use corresponding tools
- For securing clamp: Allen key 3 mm
- Wire stripper
- When using stranded cables: crimping tool for ferrule
- For removing cables from terminal: flat blade screwdriver  $\leq 3$  mm (0.12 in)

#### 7.1.2 Connecting cable requirements

The connecting cables provided by the customer must fulfill the following requirements.

##### Electrical safety

In accordance with applicable federal/national regulations.

##### Permitted temperature range

- $-40$  °C ( $-40$  °F) to  $+80$  °C ( $+176$  °F)
- Minimum requirement: cable temperature range  $\geq$  ambient temperature  $+20$  K

##### Signal cable

###### Current output

- For 4-20 mA: standard installation cable is sufficient.
- For 4-20 mA HART: Shielded cable recommended. Observe grounding concept of the plant.

###### Pulse/frequency/switch output

Standard installation cable is sufficient.

###### Current input

Standard installation cable is sufficient.

##### Connecting cable for remote version

###### Connecting cable (standard)

Standard cable	$2 \times 2 \times 0.34$ mm <sup>2</sup> (22 AWG) PVC cable with common shield (2 pairs, pair-stranded)
Flame resistance	According to DIN EN 60332-1-2
Oil-resistance	According to DIN EN 60811-2-1
Shielding	Galvanized copper-braid, opt. density approx. 85%
Cable length	5 m (16 ft), 10 m (32 ft), 20 m (65 ft), 30 m (98 ft)
Operating temperature	When mounted in a fixed position: $-50$ to $+105$ °C ( $-58$ to $+221$ °F); when cable can move freely: $-25$ to $+105$ °C ( $-13$ to $+221$ °F)

*Connecting cable (reinforced)*

<b>Cable, reinforced</b>	2 × 2 × 0.34 mm <sup>2</sup> (22 AWG) PVC cable with common shield (2 pairs, pair-stranded) and additional steel-wire braided sheath
<b>Flame resistance</b>	According to DIN EN 60332-1-2
<b>Oil-resistance</b>	According to DIN EN 60811-2-1
<b>Shielding</b>	Galvanized copper-braid, opt. density approx. 85%
<b>Strain relief and reinforcement</b>	Steel-wire braid, galvanized
<b>Cable length</b>	5 m (16 ft), 10 m (32 ft), 20 m (65 ft), 30 m (98 ft)
<b>Operating temperature</b>	When mounted in a fixed position: -50 to +105 °C (-58 to +221 °F); when cable can move freely: -25 to +105 °C (-13 to +221 °F)

**Cable diameter**

- Cable glands supplied:  
M20 × 1.5 with cable  $\phi$  6 to 12 mm (0.24 to 0.47 in)
- Plug-in spring terminals for device version without integrated overvoltage protection:  
wire cross-sections 0.5 to 2.5 mm<sup>2</sup> (20 to 14 AWG)
- Screw terminals for device version with integrated overvoltage protection: wire cross-sections 0.2 to 2.5 mm<sup>2</sup> (24 to 14 AWG)

### 7.1.3 Terminal assignment

#### Transmitter

4-20 mA HART connection version with additional inputs and outputs

<small>A0020738</small>	<small>A0020739</small>
<p><i>Maximum number of terminals</i>                  Terminals 1 to 6:                  Without integrated overvoltage protection</p>	<p><i>Maximum number of terminals for order code for "Accessory mounted", option NA "Overvoltage protection"</i></p> <ul style="list-style-type: none"> <li>■ Terminals 1 to 4:                      With integrated overvoltage protection</li> <li>■ Terminals 5 to 6:                      Without integrated overvoltage protection</li> </ul>
<p>1 Output 1 (passive): supply voltage and signal transmission                  2 Output 2 (passive): supply voltage and signal transmission                  3 Input (passive): supply voltage and signal transmission                  4 Ground terminal for cable shield</p>	

Order code for "Output"	Terminal numbers					
	Output 1		Output 2		Input	
	1 (+)	2 (-)	3 (+)	4 (-)	5 (+)	6 (-)
Option A	4-20 mA HART (passive)		-		-	
Option B <sup>1)</sup>	4-20 mA HART (passive)		Pulse/frequency/switch output (passive)		-	
Option C <sup>1)</sup>	4-20 mA HART (passive)		4-20 mA analog (passive)		-	
Option D <sup>1) 2)</sup>	4-20 mA HART (passive)		Pulse/frequency/switch output (passive)		4-20 mA current input (passive)	

- 1) Output 1 must always be used; output 2 is optional.
- 2) The integrated overvoltage protection is not used with option D: Terminals 5 and 6 (current input) are not protected against overvoltage.

#### Remote version

In the case of the remote version, the sensor and transmitter are mounted separately from one another and connected by a connecting cable. The sensor is connected via the

connection housing while the transmitter is connected via the connection compartment of the wall holder unit.

**i** The way the transmitter wall holder is connected depends on the measuring device approval and the version of the connecting cable used.

Connection is only possible via terminals:

- For approvals Ex n, Ex tb and cCSAus Div. 1
- If a reinforced connecting cable is used

The connection is via an M12 connector:

- For all other approvals
- If the standard connecting cable is used

Connection to the connection housing of the sensor is always via the terminals (tightening torque for terminals: 1.2 to 1.7 Nm).

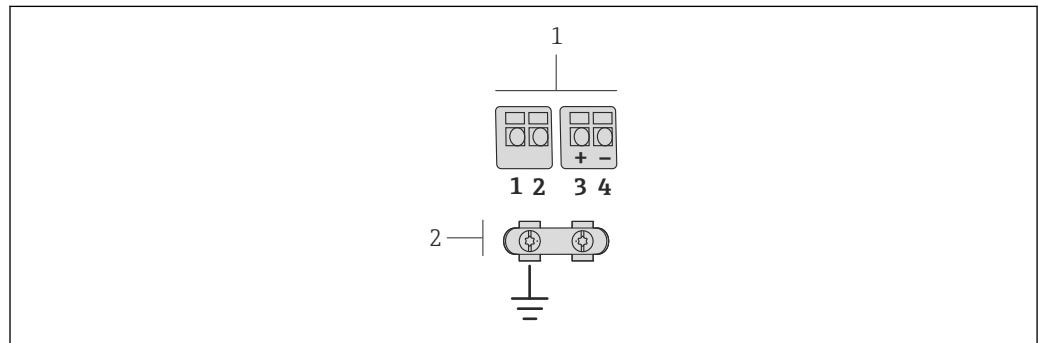

**10** Terminals for connection compartment in the transmitter wall holder and the sensor connection housing

- 1 Terminals for connecting cable
- 2 Grounding via the cable strain relief

Terminal number	Assignment	Cable color Connecting cable
1	Supply voltage	Brown
2	Grounding	White
3	RS485 (+)	Yellow
4	RS485 (-)	Green

### 7.1.4 Requirements for the supply unit

#### Supply voltage

##### Transmitter

An external power supply is required for each output.

The following supply voltage values apply for the outputs available:

Supply voltage for a compact version without a local display<sup>1)</sup>

Order code for "Output"	Minimum terminal voltage <sup>2)</sup>	Maximum terminal voltage
Option A: 4-20 mA HART	≥ DC 12 V	DC 35 V
Option B: 4-20 mA HART, pulse/ frequency/switch output	≥ DC 12 V	DC 35 V



Order code for "Output"	Minimum terminal voltage <sup>2)</sup>	Maximum terminal voltage
Option C: 4-20 mA HART + 4-20 mA analog	≥ DC 12 V	DC 30 V
Option D: 4-20 mA HART, pulse/frequency/switch output, 4-20 mA current input <sup>3)</sup>	≥ DC 12 V	DC 35 V

- 1) In event of external supply voltage of the power supply unit with load
- 2) The minimum terminal voltage increases if local operation is used: see the following table
- 3) Voltage drop 2.2 to 3 V for 3.59 to 22 mA

*Increase in minimum terminal voltage*

Local operation	Increase in minimum terminal voltage
Order code for "Display; Operation", option C: Local operation SDO2	+ DC 1 V
Order code for "Display; Operation", option E: Local operation SDO3 with lighting (backlighting <b>not used</b> )	+ DC 1 V
Order code for "Display; Operation", option E: Local operation SDO3 with lighting (backlighting <b>used</b> )	+ DC 3 V

**Load**

Load for current output: 0 to 500 Ω, depending on the external supply voltage of the power supply unit

*Calculation of the maximum load*

Depending on the supply voltage of the power supply unit ( $U_S$ ), the maximum load ( $R_B$ ) including line resistance must be observed to ensure adequate terminal voltage at the device. In doing so, observe the minimum terminal voltage

- $R_B \leq (U_S - U_{\text{term. min}}) : 0.022 \text{ A}$
- $R_B \leq 500 \text{ } \Omega$

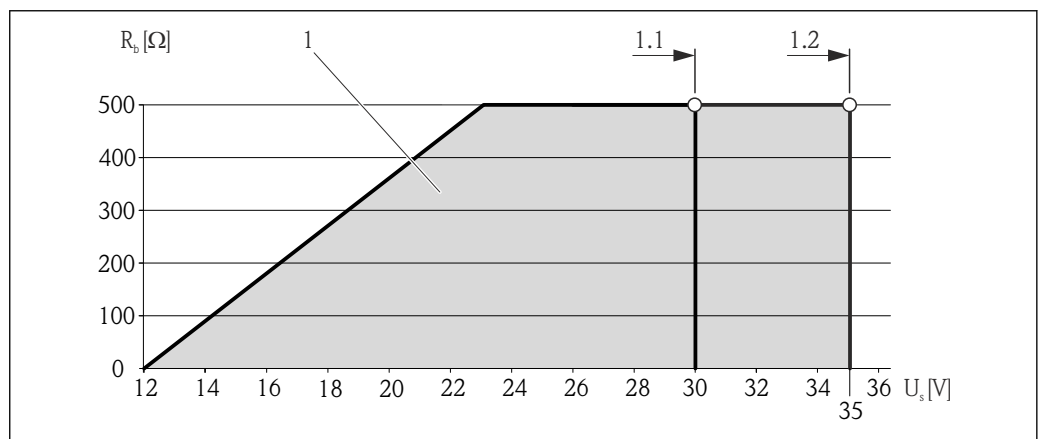

11 Load for a compact version without local operation

- 1 Operating range
- 1.1 For order code for "Output", option A "4-20 mA HART"/option B "4-20 mA HART, pulse/frequency/switch output" with Ex i and option C "4-20 mA HART + 4-20 mA analog"
- 1.2 For order code for "Output", option A "4-20 mA HART"/option B "4-20 mA HART, pulse/frequency/switch output" with non-Ex and Ex d

**Sample calculation**

Supply voltage of the supply unit:

-  $U_S = 19 \text{ V}$

-  $U_{\text{term. min}} = 12 \text{ V (measuring device)} + 1 \text{ V (local operation without lighting)} = 13 \text{ V}$

Maximum load:  $R_B \leq (19 \text{ V} - 13 \text{ V}) : 0.022 \text{ A} = 273 \ \Omega$

 The minimum terminal voltage ( $U_{\text{term. min}}$ ) increases if local operation is used  
(*Verweisziel existiert nicht, aber @y.link.required='true'*).

**7.1.5 Preparing the measuring device**

1. Remove dummy plug if present.

2. **NOTICE**

**Insufficient sealing of the housing!**

Operational reliability of the measuring device could be compromised.

- ▶ Use suitable cable glands corresponding to the degree of protection.

If measuring device is delivered without cable glands:

Provide suitable cable gland for corresponding connecting cable .

3. If measuring device is delivered with cable glands:

Observe cable specification .

**7.2 Connecting the measuring device****NOTICE****Limitation of electrical safety due to incorrect connection!**

- ▶ Have electrical connection work carried out by correspondingly trained specialists only.
- ▶ Observe applicable federal/national installation codes and regulations.
- ▶ Comply with local workplace safety regulations.
- ▶ For use in potentially explosive atmospheres, observe the information in the device-specific Ex documentation.

**7.2.1 Connecting the remote version**** WARNING****Risk of damaging the electronic components!**

- ▶ Ground the remote version and in doing so connect the sensor and transmitter to the same potential equalization.
- ▶ Only connect the sensor to a transmitter with the same serial number.

The following procedure (in the action sequence given) is recommended for the remote version:

1. Mount the transmitter and sensor.

2. Connect the connecting cable.

### 3. Connect the transmitter.

**i** The way the transmitter wall holder is connected depends on the measuring device approval and the version of the connecting cable used.

Connection is only possible via terminals:

- For approvals Ex n, Ex tb and cCSAus Div. 1
- If a reinforced connecting cable is used

The connection is via an M12 connector:

- For all other approvals
- If the standard connecting cable is used

Connection to the connection housing of the sensor is always via the terminals (tightening torque for terminals: 1.2 to 1.7 Nm).

### Connecting the sensor connection housing

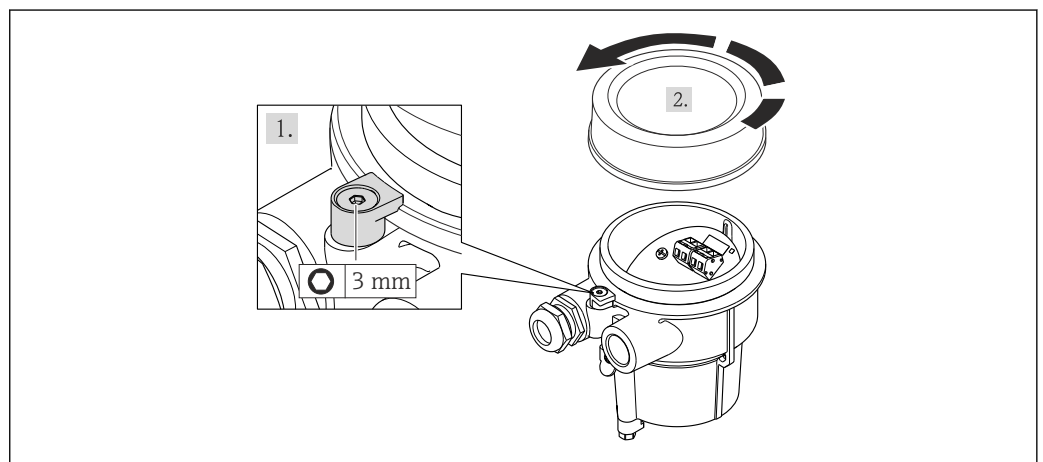

A0020410

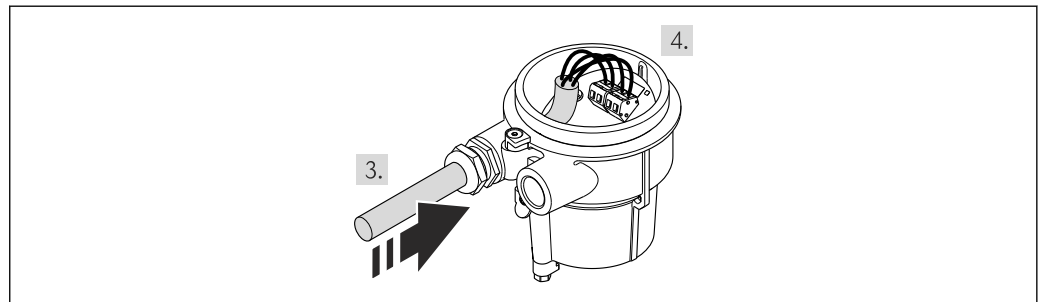

A0020411

1. Loosen the securing clamp.
2. Unscrew the housing cover.
3. Guide the connecting cable through the cable entry and into the connection housing (if using a connecting cable without an M12 device plug, use the shorter stripped end of the connecting cable).

**4. NOTICE****Terminals tightened with an incorrect tightening torque.**

Incorrect connection or damaged terminal.

- ▶ Tighten the terminals with a tightening torque in the 1.2 to 1.7 Nm range.

Wire the connecting cable:

- ↳ Terminal 1 = brown cable
- Terminal 2 = white cable
- Terminal 3 = yellow cable
- Terminal 4 = green cable

**5.** Connect the cable shield via the cable strain relief.

**6.** Reverse the removal procedure to reassemble the transmitter.

**Connection to the wall holder of the transmitter**

*Connecting the transmitter via plug*

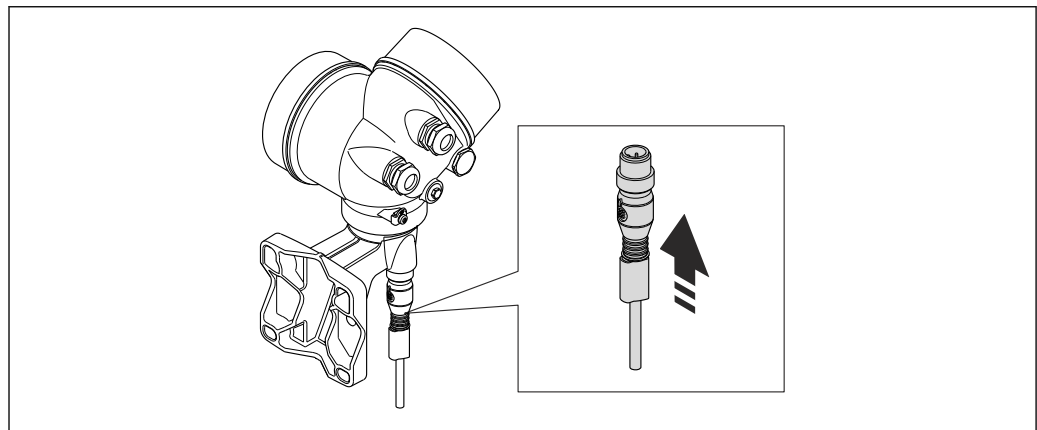

A0020412

- ▶ Connect the plug.

*Connecting the transmitter via terminals*

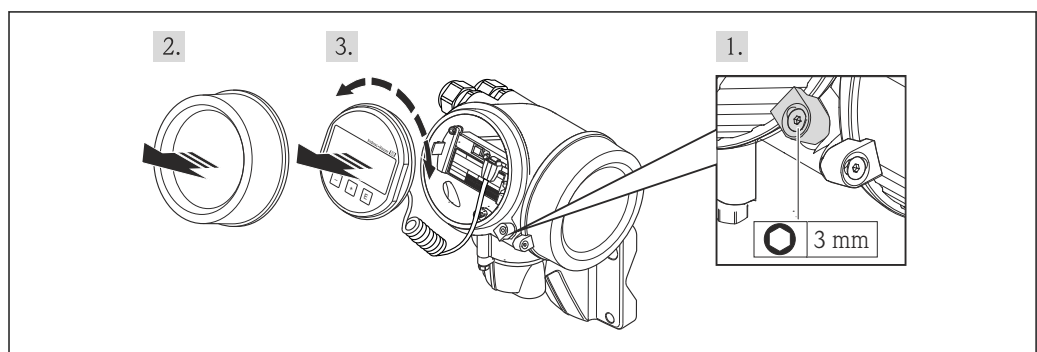

A0020404

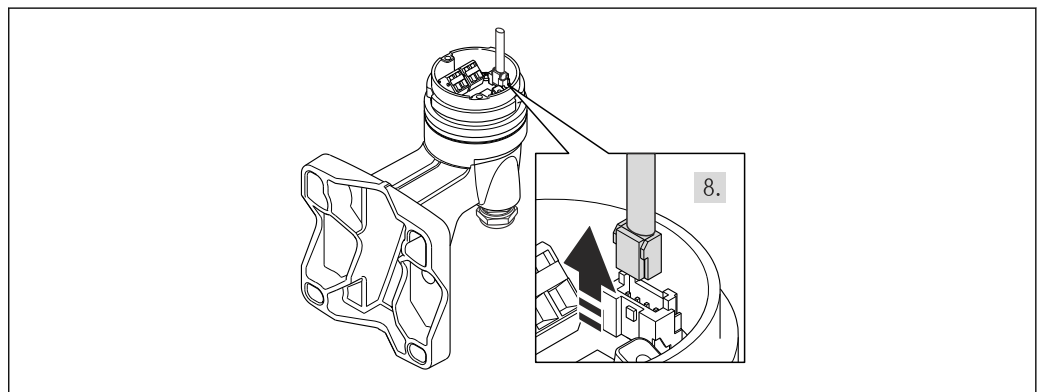
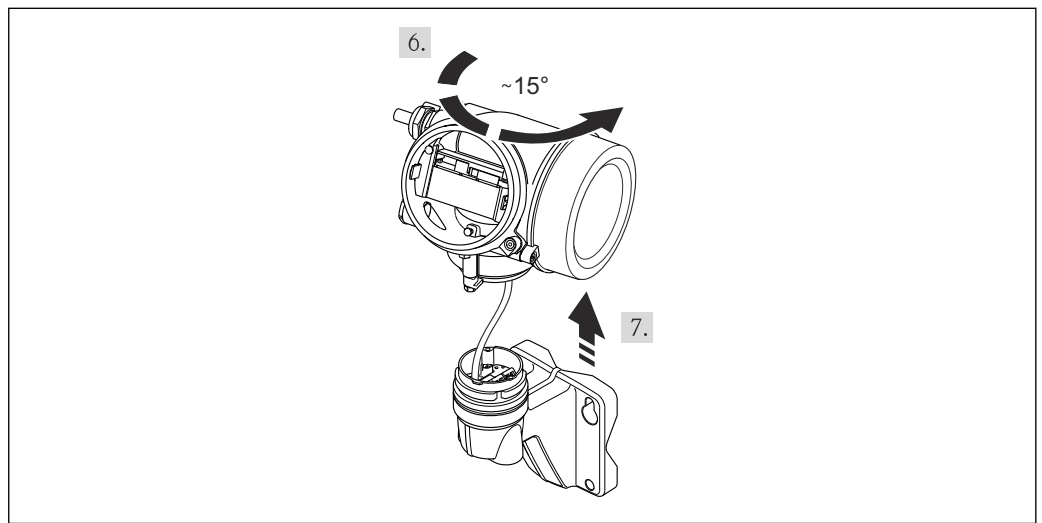
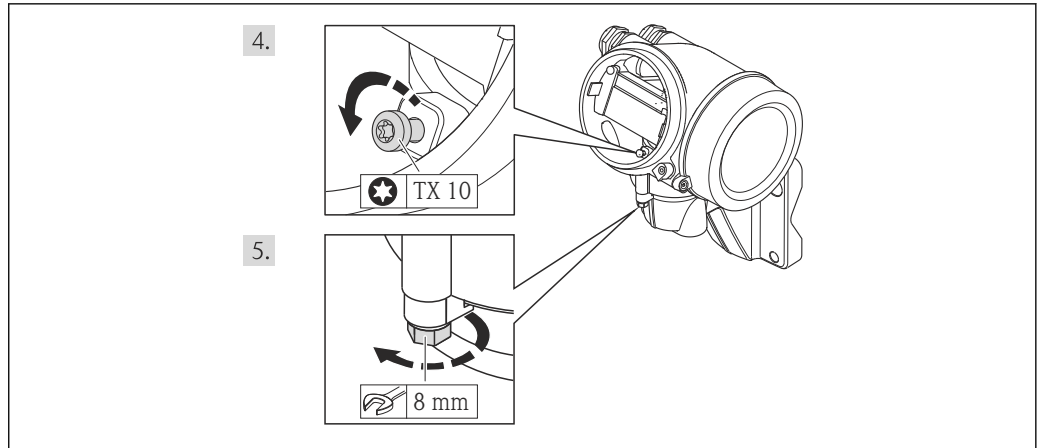

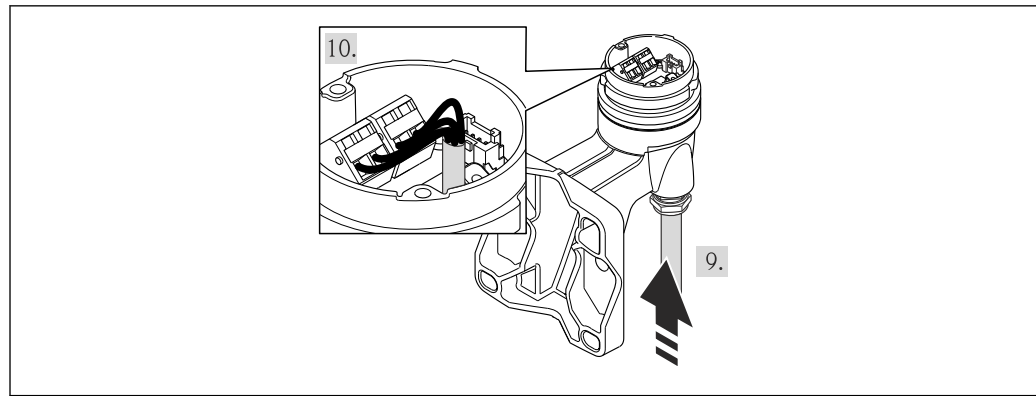

A0020409

1. Loosen the securing clamp of the transmitter housing.
2. Loosen the securing clamp of the electronics compartment cover.
3. Unscrew the electronics compartment cover.
4. Pull out the display module with a gentle rotational movement. To make it easier to access the lock switch, attach the display module to the edge of the electronics compartment.
5. Loosen the locking screw of the transmitter housing.
6. Turn the transmitter housing to the right until the mark and lift it up. The connection board of the wall housing is connected to the electronics board of the transmitter via a signal cable. Pay attention to the signal cable when lifting the transmitter housing!
7. Disconnect the signal cable from the connection board of the wall housing by pressing in the locking clip on the connector.
8. Remove the transmitter housing.
9. Guide the connecting cable through the cable entry and into the connection housing (if using a connecting cable without an M12 device plug, use the shorter stripped end of the connecting cable).
10. Wire the connecting cable:
  - ↳ Terminal 1 = brown cable
  - Terminal 2 = white cable
  - Terminal 3 = yellow cable
  - Terminal 4 = green cable
11. Connect the cable shield via the cable strain relief.
12. Reverse the removal procedure to reassemble the transmitter.

### 7.2.2 Connecting the transmitter

**Connection via terminals**

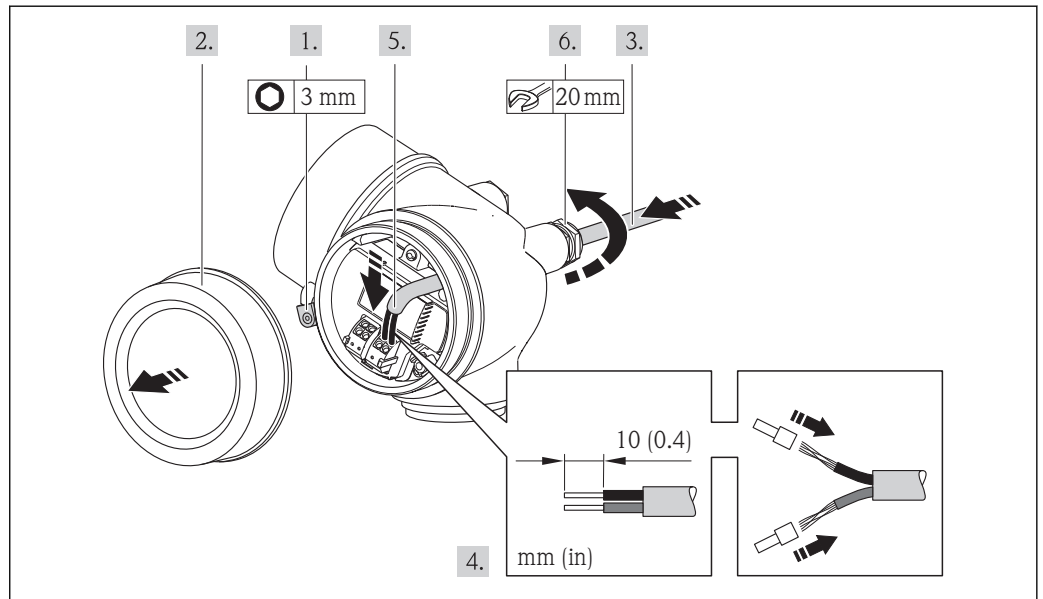

A0013836

1. Loosen the securing clamp of the connection compartment cover.
2. Unscrew the connection compartment cover.
3. Push the cable through the cable entry . To ensure tight sealing, do not remove the sealing ring from the cable entry.
4. Strip the cable and cable ends. In the case of stranded cables, also fit ferrules.
5. Connect the cable in accordance with the terminal assignment . For HART communication: when connecting the cable shielding to the ground terminal, observe the grounding concept of the facility.
6. Firmly tighten the cable glands.
7. **⚠ WARNING**

**Housing degree of protection may be voided due to insufficient sealing of the housing.**

- ▶ Screw in the screw without using any lubricant. The threads on the cover are coated with a dry lubricant.

Reverse the removal procedure to reassemble the transmitter.

**Removing a cable**

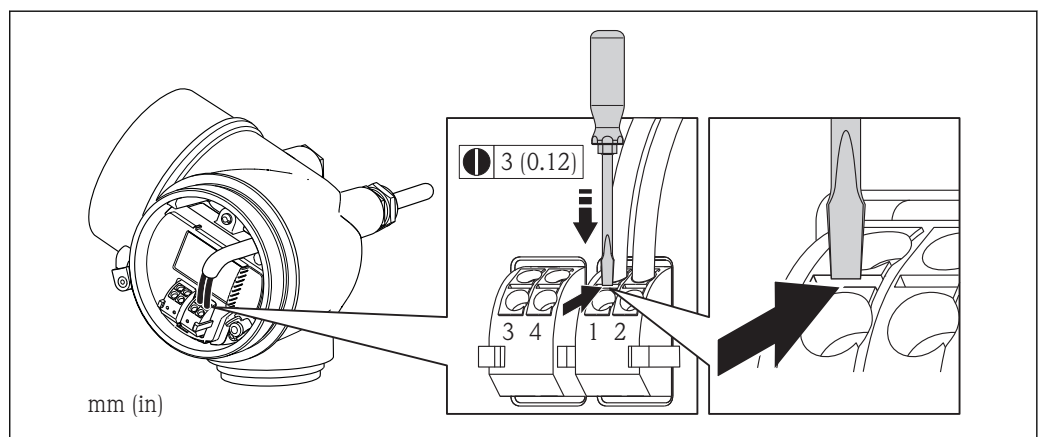

A0013835

- ▶ To remove a cable from the terminal, use a flat-blade screwdriver to push the slot between the two terminal holes while simultaneously pulling the cable end out of the terminal.

### 7.2.3 Ensuring potential equalization

#### Requirements

Please consider the following to ensure correct measurement:

- Same electrical potential for the fluid and sensor
- Remote version: same electrical potential for the sensor and transmitter
- Company-internal grounding concepts
- Pipe material and grounding

 For devices intended for use in hazardous locations, please observe the guidelines in the Ex documentation (XA).

## 7.3 Special connection instructions

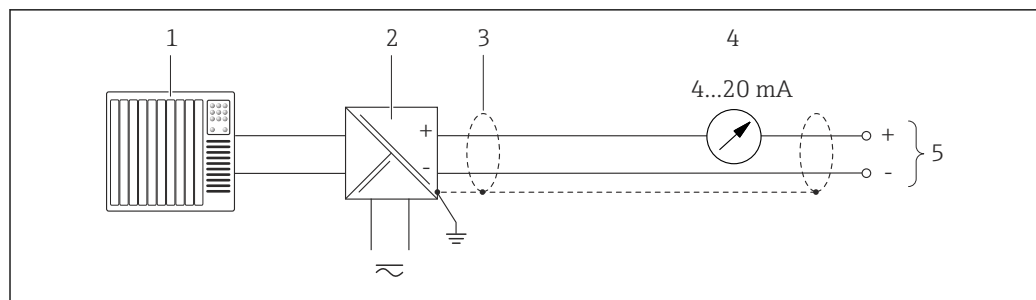

### 7.3.1 Connection examples

#### Current output 4-20 mA HART



A0015511

 12 Connection example for 4-20 mA HART current output (passive)

- 1 Automation system with current input (e.g. PLC)
- 2 Active barrier for power supply with integrated resistor for HART communication ( $\geq 250 \Omega$ ) (e.g. RN221N)  
Connection for HART operating devices →  184  
Observe the maximum load →  33
- 3 Cable shield, observe cable specifications
- 4 Analog display unit: observe maximum load →  33
- 5 Transmitter



**Pulse/frequency output**

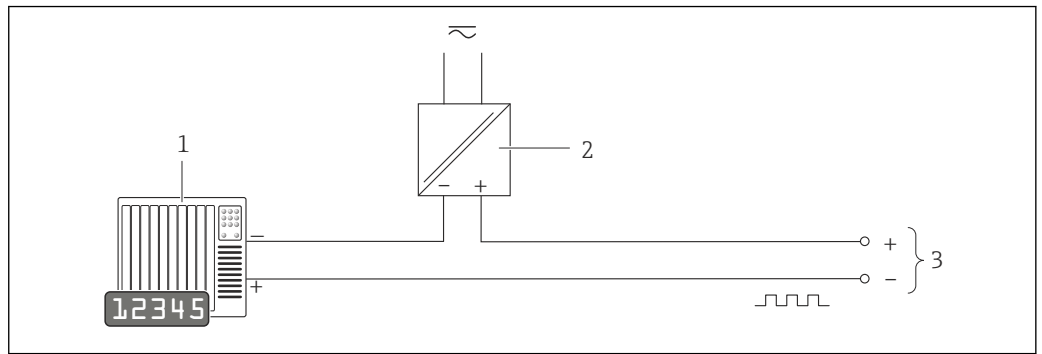

A0016801

13 Connection example for pulse/frequency output (passive)

- 1 Automation system with pulse/frequency input (e.g. PLC)
- 2 Power supply
- 3 Transmitter: observe input values → 169

**Switch output**

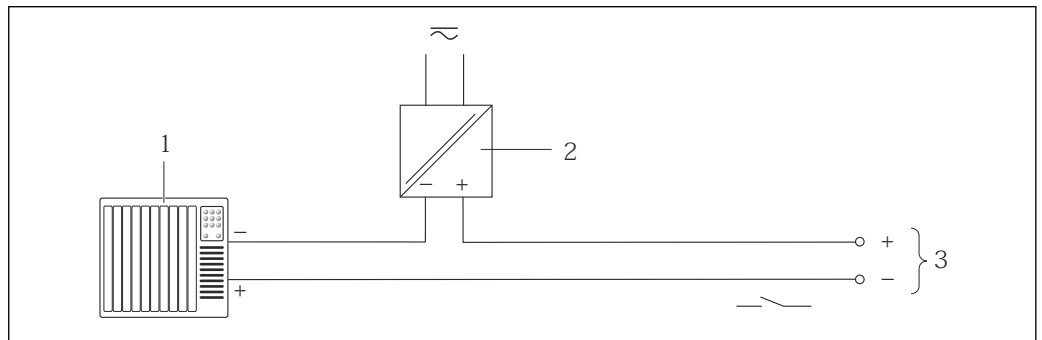

A0016802

14 Connection example for switch output (passive)

- 1 Automation system with switch input (e.g. PLC)
- 2 Power supply
- 3 Transmitter: observe input values

**Current input**

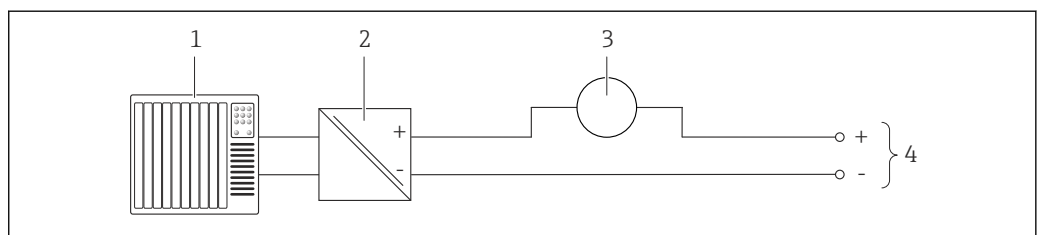

A0020741

15 Connection example for 4-20 mA current input

- 1 Control system (e.g. PLC)
- 2 Power supply
- 3 External measuring device (for reading in pressure or temperature, for instance)
- 4 Transmitter: Observe input values → 167

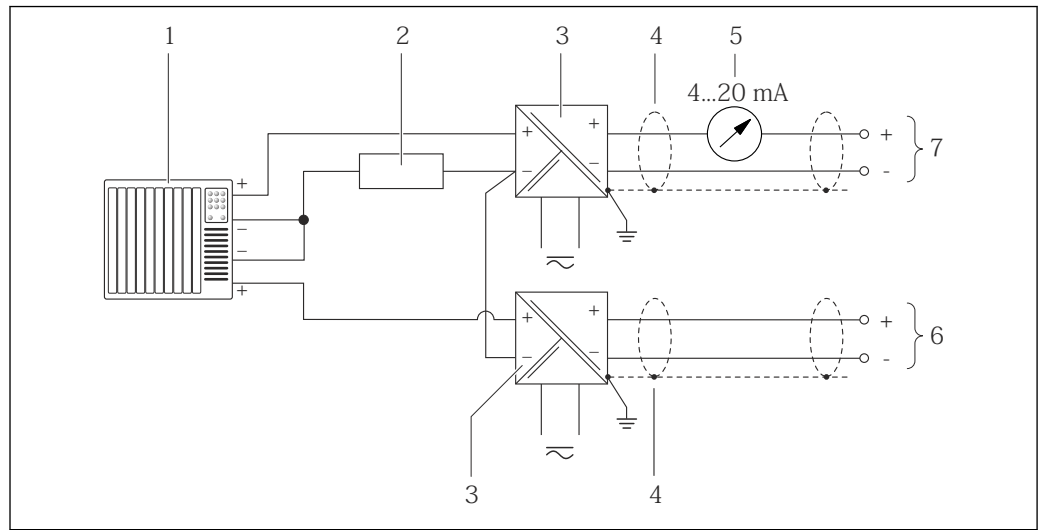
**HART input**

A0016029

16 Connection example for HART input with a common negative

- 1 Automation system with HART output (e.g. PLC)
- 2 Resistor for HART communication ( $\geq 250 \Omega$ ): observe maximum load → 33
- 3 Active barrier for power supply (e.g. RN221N)
- 4 Cable shield, observe cable specifications
- 5 Analog display unit: observe maximum load → 33
- 6 Pressure transmitter (e.g. Cerabar M, Cerabar S): see requirements
- 7 Transmitter

## 7.4 Ensuring the degree of protection

The measuring device fulfills all the requirements for the IP66/67 degree of protection, Type 4X enclosure.

To guarantee IP66/67 degree of protection, Type 4X enclosure, carry out the following steps after the electrical connection:

1. Check that the housing seals are clean and fitted correctly. Dry, clean or replace the seals if necessary.
2. Tighten all housing screws and screw covers.
3. Firmly tighten the cable glands.
4. To ensure that moisture does not enter the cable entry, route the cable so that it loops down before the cable entry ("water trap").

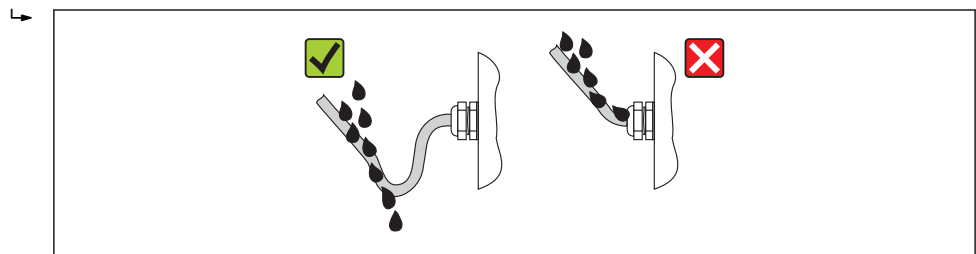

A0013960

5. Insert dummy plugs into unused cable entries.

## 7.5 Post-connection check

Are cables or the device undamaged (visual inspection)?	<input type="checkbox"/>
Do the cables comply with the requirements ?	<input type="checkbox"/>
Do the cables have adequate strain relief?	<input type="checkbox"/>
Are all the cable glands installed, firmly tightened and leak-tight? Cable run with "water trap" → 42 ?	<input type="checkbox"/>
Depending on the device version: are all the device plugs firmly tightened ?	<input type="checkbox"/>
Does the supply voltage match the specifications on the transmitter nameplate ?	<input type="checkbox"/>
Is the terminal assignment correct ?	<input type="checkbox"/>
If supply voltage is present, do values appear on the display module?	<input type="checkbox"/>
Are all housing covers installed and firmly tightened?	<input type="checkbox"/>
Is the securing clamp tightened correctly?	<input type="checkbox"/>

## 8 Operation options

### 8.1 Overview of operating options

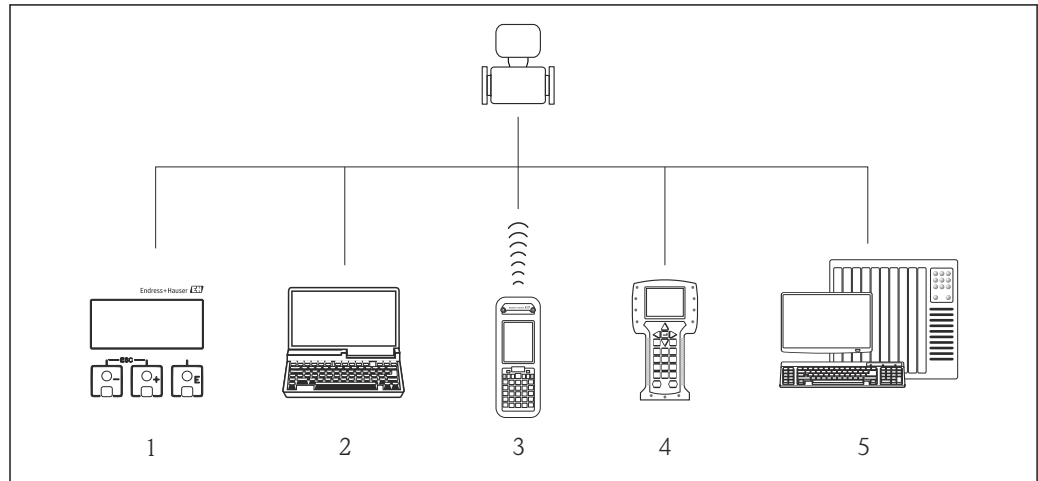

A0015607

- 1 Local operation via display module
- 2 Computer with operating tool (e.g. FieldCare, AMS Device Manager, SIMATIC PDM)
- 3 Field Xpert SFX350 or SFX370
- 4 Field Communicator 475
- 5 Automation system (e.g. PLC)

## 8.2 Structure and function of the operating menu

### 8.2.1 Structure of the operating menu

 For an overview of the operating menu with menus and parameters

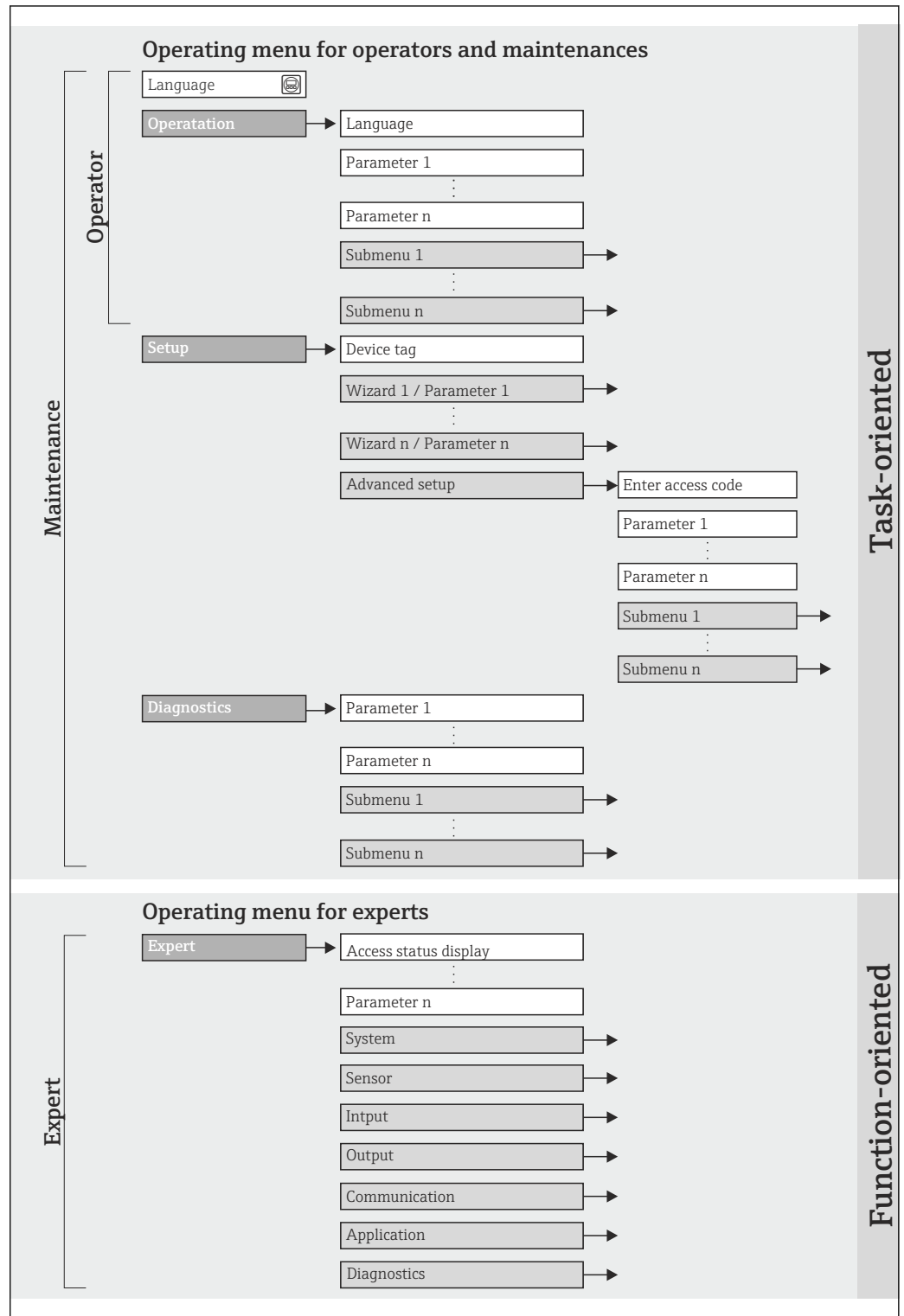

 17 Schematic structure of the operating menu

A0018237-EN

### 8.2.2 Operating philosophy

The individual parts of the operating menu are assigned to certain user roles (operator, maintenance etc.). Each user role contains typical tasks within the device lifecycle.

Menu/parameter		User role and tasks	Content/meaning
Language	task-oriented	<b>Role "Operator", "Maintenance"</b> Tasks during operation: <ul style="list-style-type: none"> <li>▪ Configuring the operational display</li> <li>▪ Reading measured values</li> </ul>	Defining the operating language
Operation			<ul style="list-style-type: none"> <li>▪ Configuring the operational display (e.g. display format, display contrast)</li> <li>▪ Resetting and controlling totalizers</li> </ul>
Setup		<b>"Maintenance" role</b> Commissioning: <ul style="list-style-type: none"> <li>▪ Configuration of the measurement</li> <li>▪ Configuration of the inputs and outputs</li> </ul>	Wizards for fast commissioning: <ul style="list-style-type: none"> <li>▪ Configure the outputs</li> <li>▪ Configuring the operational display</li> <li>▪ Define the output conditioning</li> <li>▪ Set the low flow cut off</li> </ul> Advanced setup <ul style="list-style-type: none"> <li>▪ For more customized configuration of the measurement (adaptation to special measuring conditions)</li> <li>▪ Configuration of totalizers</li> <li>▪ Administration (define access code, reset measuring device)</li> </ul>
Diagnostics		<b>"Maintenance" role</b> Fault elimination: <ul style="list-style-type: none"> <li>▪ Diagnostics and elimination of process and device errors</li> <li>▪ Measured value simulation</li> </ul>	Contains all parameters for error detection and analyzing process and device errors: <ul style="list-style-type: none"> <li>▪ Diagnostic list Contains up to 5 currently pending diagnostic messages.</li> <li>▪ Event logbook Contains up to 20 or 100 (order option "Extended HistoROM") event messages that have occurred.</li> <li>▪ Device information Contains information for identifying the device.</li> <li>▪ Measured values Contains all current measured values.</li> <li>▪ Data logging (Order option "Extended HistoROM") Storage and visualization of up to 1000 measured values</li> <li>▪ Heartbeat The functionality of the device is checked on demand and the verification results are documented.</li> <li>▪ Simulation Is used to simulate measured values or output values.</li> </ul>
Expert	function-oriented	Tasks that require detailed knowledge of the function of the device: <ul style="list-style-type: none"> <li>▪ Commissioning measurements under difficult conditions</li> <li>▪ Optimal adaptation of the measurement to difficult conditions</li> <li>▪ Detailed configuration of the communication interface</li> <li>▪ Error diagnostics in difficult cases</li> </ul>	Contains all the parameters of the device and makes it possible to access these parameters directly using an access code. The structure of this menu is based on the function blocks of the device: <ul style="list-style-type: none"> <li>▪ System Contains all higher-order device parameters which do not concern the measurement or the communication interface.</li> <li>▪ Sensor Configuration of the measurement.</li> <li>▪ Input Configuration of the input.</li> <li>▪ Output Configuration of the outputs.</li> <li>▪ Communication Configuration of the digital communication interface.</li> <li>▪ Application Configuration of the functions that go beyond the actual measurement (e.g. totalizer).</li> <li>▪ Diagnostics Error detection and analysis of process and device errors and for device simulation and Heartbeat Technology.</li> </ul>

### 8.3 Access to the operating menu via the local display

#### 8.3.1 Operational display

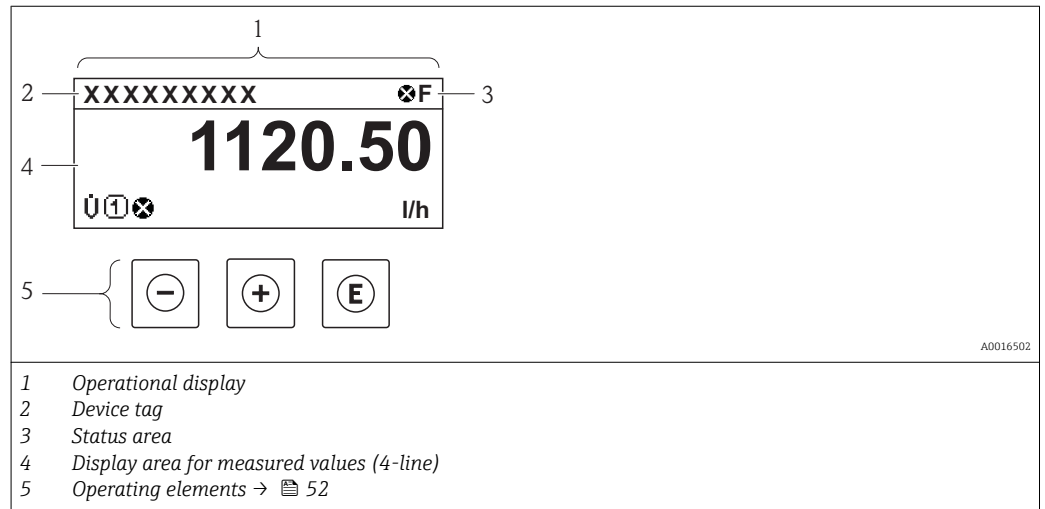

#### Status area

The following symbols appear in the status area of the operational display at the top right:

- Status signals → 138
  - **F**: Failure
  - **C**: Function check
  - **S**: Out of specification
  - **M**: Maintenance required
- Diagnostic behavior → 139
  - : Alarm
  - : Warning
- : Locking (the device is locked via the hardware)
- : Communication (communication via remote operation is active)

#### Display area

In the display area, each measured value is prefaced by certain symbol types for further description:

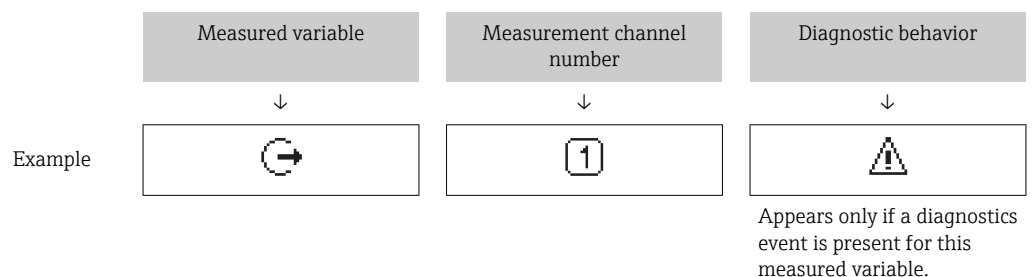

#### Measured variables

Symbol	Meaning
	Volume flow

	<p>Totalizer</p> <p> The measurement channel number indicates which of the three totalizers is displayed.</p>
	<p>Output</p> <p> The measurement channel number indicates which of the two current outputs is displayed.</p>

*Measurement channel numbers*

Symbol	Meaning
	Measurement channel 1 to 4

The measurement channel number is displayed only if more than one channel is present for the same measured variable type (e.g. totalizer 1-3).

*Diagnostic behavior*

The diagnostic behavior pertains to a diagnostic event that is relevant to the displayed measured variable. For information on the symbols → 139

The number and display format of the measured values can be configured via the **"Format display" parameter** → 89. "Operation" menu → Display → Format display

**8.3.2 Navigation view**



In the submenu	In the wizard
<p>1 Navigation view</p> <p>2 Navigation path to current position</p> <p>3 Status area</p> <p>4 Display area for navigation</p> <p>5 Operating elements →  52</p>	<p>1 Navigation view</p> <p>2 Navigation path to current position</p> <p>3 Status area</p> <p>4 Display area for navigation</p> <p>5 Operating elements →  52</p>

**Navigation path**

The navigation path - displayed at the top left in the navigation view - consists of the following elements:

	<ul style="list-style-type: none"> <li>▪ In the submenu: Display symbol for menu</li> <li>▪ In the wizard: Display symbol for wizard</li> </ul>	<p>Omission symbol for operating menu levels in between</p>	<p>Name of current</p> <ul style="list-style-type: none"> <li>▪ Submenu</li> <li>▪ Wizard</li> <li>▪ Parameter</li> </ul>
	↓	↓	↓
Examples			





 For more information about the menu icons, refer to the "Display area" section  
 →  49

**Status area**





The following appears in the status area of the navigation view in the top right corner:

- Of the submenu
  - The direct access code for the parameter you are navigating to (e.g. 0022-1)
  - If a diagnostic event is present, the diagnostic behavior and status signal
- In the wizard
  - If a diagnostic event is present, the diagnostic behavior and status signal





-  ▪ For information on the diagnostic behavior and status signal →  138
- For information on the function and entry of the direct access code →  54

**Display area**

*Menus*

Symbol	Meaning
	<b>Operation</b> Appears: <ul style="list-style-type: none"> <li>▪ In the menu next to the "Operation" selection</li> <li>▪ At the left in the navigation path in the "Operation" menu</li> </ul>
	<b>Setup</b> Appears: <ul style="list-style-type: none"> <li>▪ In the menu next to the "Setup" selection</li> <li>▪ At the left in the navigation path in the "Setup" menu</li> </ul>
	<b>Diagnostics</b> Appears: <ul style="list-style-type: none"> <li>▪ In the menu next to the "Diagnostics" selection</li> <li>▪ At the left in the navigation path in the "Diagnostics" menu</li> </ul>
	<b>Expert</b> Appears: <ul style="list-style-type: none"> <li>▪ In the menu next to the "Expert" selection</li> <li>▪ At the left in the navigation path in the "Expert" menu</li> </ul>



*Submenus, wizards, parameters*

Symbol	Meaning
	Submenu
	Wizard
	Parameters within a wizard  No display symbol exists for parameters in submenus.

*Locking*

Symbol	Meaning
	<b>Parameter locked</b> When displayed in front of a parameter name, indicates that the parameter is locked. <ul style="list-style-type: none"> <li>▪ By a user-specific access code</li> <li>▪ By the hardware write protection switch</li> </ul>

Wizard operation

Symbol	Meaning
	Switches to the previous parameter.
	Confirms the parameter value and switches to the next parameter.
	Opens the editing view of the parameter.



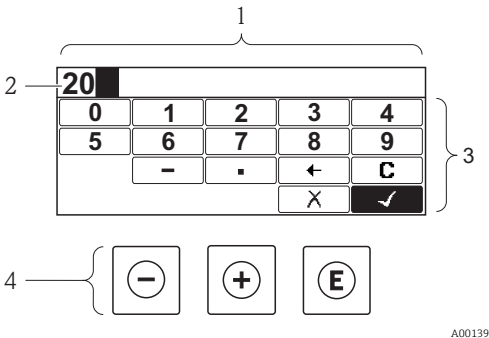
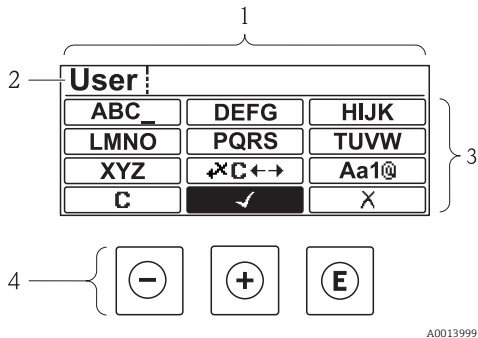



8.3.3 Editing view

Numeric editor	Text editor
	
<p>1 Editing view</p> <p>2 Display area of the entered values</p> <p>3 Input mask</p> <p>4 Operating elements → 52</p>	<p>1 Editing view</p> <p>2 Display area of the entered values</p> <p>3 Input mask</p> <p>4 Operating elements → 52</p>

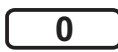
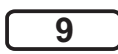









Input mask

The following input symbols are available in the input mask of the numeric and text editor:





Numeric editor

Symbol	Meaning
	Selection of numbers from 0 to 9.
	
	Inserts decimal separator at the input position.
	Inserts minus sign at the input position.
	Confirms selection.
	Moves the input position one position to the left.
	Exits the input without applying the changes.
	Clears all entered characters.







## Text editor

Symbol	Meaning
	Toggle <ul style="list-style-type: none"> <li>Between upper-case and lower-case letters</li> <li>For entering numbers</li> <li>For entering special characters</li> </ul>
 ... 	Selection of letters from A to Z.
 ... 	Selection of letters from a to z.
 ... 	Selection of special characters.
	Confirms selection.
	Switches to the selection of the correction tools.
	Exits the input without applying the changes.
	Clears all entered characters.

Correction symbols under 

Symbol	Meaning
	Clears all entered characters.
	Moves the input position one position to the right.
	Moves the input position one position to the left.
	Deletes one character immediately to the left of the input position.

### 8.3.4 Operating elements

Key	Meaning
	<p><b>Minus key</b></p> <p><i>In a menu, submenu</i> Moves the selection bar upwards in a choose list.</p> <p><i>With a Wizard</i> Confirms the parameter value and goes to the previous parameter.</p> <p><i>With a text and numeric editor</i> In the input mask, moves the selection bar to the left (backwards).</p>
	<p><b>Plus key</b></p> <p><i>In a menu, submenu</i> Moves the selection bar downwards in a choose list.</p> <p><i>With a Wizard</i> Confirms the parameter value and goes to the next parameter.</p> <p><i>With a text and numeric editor</i> Moves the selection bar to the right (forwards) in an input screen.</p>
	<p><b>Enter key</b></p> <p><i>For operational display</i></p> <ul style="list-style-type: none"> <li>■ Pressing the key briefly opens the operating menu.</li> <li>■ Pressing the key for 2 s opens the context menu.</li> </ul> <p><i>In a menu, submenu</i></p> <ul style="list-style-type: none"> <li>■ Pressing the key briefly: <ul style="list-style-type: none"> <li>- Opens the selected menu, submenu or parameter.</li> <li>- Starts the wizard.</li> <li>- If help text is open, closes the help text of the parameter.</li> </ul> </li> <li>■ Pressing the key for 2 s for parameter: <ul style="list-style-type: none"> <li>- If present, opens the help text for the function of the parameter.</li> </ul> </li> </ul> <p><i>With a Wizard</i> Opens the editing view of the parameter.</p> <p><i>With a text and numeric editor</i></p> <ul style="list-style-type: none"> <li>■ Pressing the key briefly: <ul style="list-style-type: none"> <li>- Opens the selected group.</li> <li>- Carries out the selected action.</li> </ul> </li> <li>■ Pressing the key for 2 s confirms the edited parameter value.</li> </ul>
	<p><b>Escape key combination (press keys simultaneously)</b></p> <p><i>In a menu, submenu</i></p> <ul style="list-style-type: none"> <li>■ Pressing the key briefly: <ul style="list-style-type: none"> <li>- Exits the current menu level and takes you to the next higher level.</li> <li>- If help text is open, closes the help text of the parameter.</li> </ul> </li> <li>■ Pressing the key for 2 s returns you to the operational display ("home position").</li> </ul> <p><i>With a Wizard</i> Exits the wizard and takes you to the next higher level.</p> <p><i>With a text and numeric editor</i> Closes the text or numeric editor without applying changes.</p>
	<p><b>Minus/Enter key combination (press the keys simultaneously)</b></p> <p>Reduces the contrast (brighter setting).</p>
	<p><b>Plus/Enter key combination (press and hold down the keys simultaneously)</b></p> <p>Increases the contrast (darker setting).</p>
	<p><b>Minus/Plus/Enter key combination (press the keys simultaneously)</b></p> <p><i>For operational display</i> Enables or disables the keypad lock (only SD02 display module).</p>

### 8.3.5 Opening the context menu

Using the context menu, the user can call up the following menus quickly and directly from the operational display:

- Setup
- Conf. backup disp.
- Simulation



### Calling up and closing the context menu

The user is in the operational display.

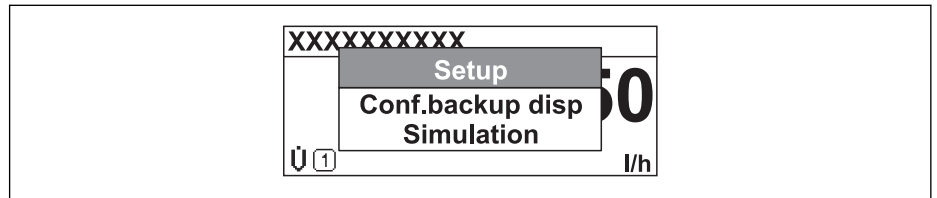

1. Press  for 2 s.
  - ↳ The context menu opens.



A0016326-EN

2. Press  +  simultaneously.
  - ↳ The context menu is closed and the operational display appears.

### Calling up the menu via the context menu

1. Open the context menu.
2. Press  to navigate to the desired menu.
3. Press  to confirm the selection.
  - ↳ The selected menu opens.

### 8.3.6 Navigating and selecting from list

Different operating elements are used to navigate through the operating menu. The navigation path is displayed on the left in the header. Icons are displayed in front of the individual menus. These icons are also shown in the header during navigation.

**i** For an explanation of the navigation view with symbols and operating elements → 48

**Example: Setting the number of displayed measured values to "2 values"**

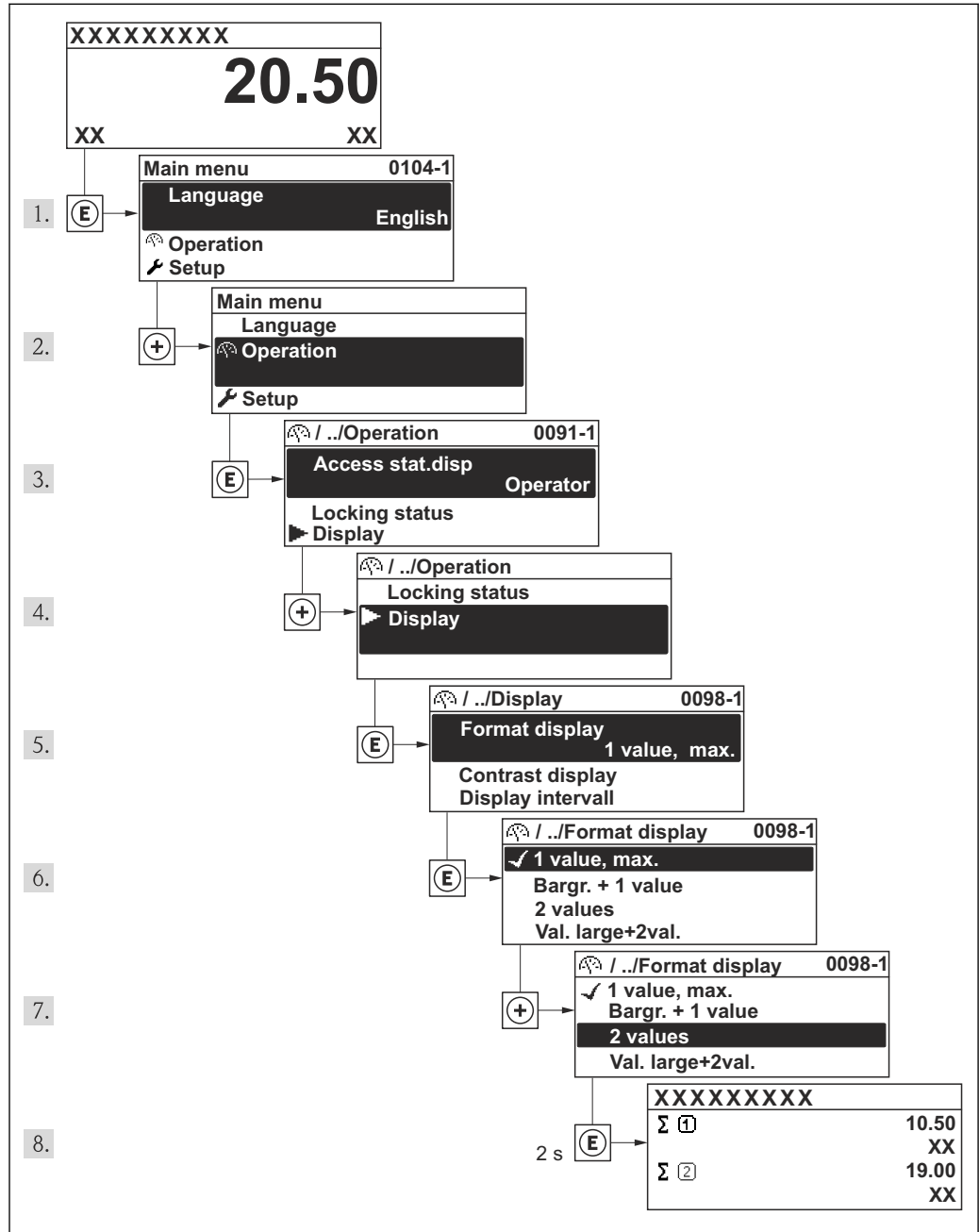

A0014010-EN

### 8.3.7 Calling the parameter directly

A parameter number is assigned to every parameter to be able to access a parameter directly via the onsite display. Entering this access code in the **Direct access** parameter calls up the desired parameter directly.

#### Navigation path

"Expert" menu → Direct access

The direct access code consists of a 4-digit number and the channel number, which identifies the channel of a process variable: e.g. 0914-1. In the navigation view, this appears on the right-hand side in the header of the selected parameter.

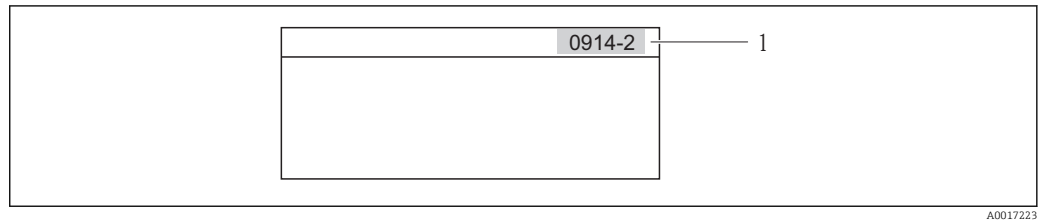

A0017223

1 Direct access code

Note the following when entering the direct access code:

- The leading zeros in the direct access code do not have to be entered.  
Example: Input of "914" instead of "0914"
- If no channel number is entered, channel 1 is jumped to automatically.  
Example: Input of "0914" → Parameter **Totalizer 1**
- If a different channel is jumped to: Enter the direct access code with the corresponding channel number.  
Example: Input of "0914-2" → Parameter **Totalizer 2**



For the direct access codes of the individual parameters

### 8.3.8 Calling up help text

For some parameters, help texts exist, which the user can call up from the navigation view. These briefly describe the function of the parameter and thus support fast and reliable commissioning.

#### Calling up and closing the help text

The user is in the navigation view and the selection bar is on a parameter.

1. Press  for 2 s.

↳ The help text for the selected parameter opens.

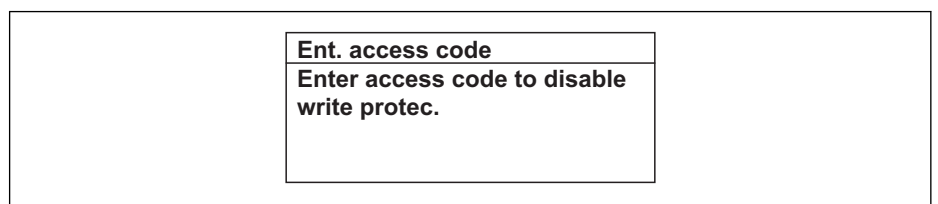

A0014002-EN

 18 Example: Help text for parameter "Enter access code"

2. Press  +  simultaneously.

↳ The help text is closed.

### 8.3.9 Changing the parameters

**i** For a description of the editing display - consisting of text editor and numeric editor - with symbols → 50, for a description of the operating elements → 52

**Example:** Changing the tag name in the "Tag description" parameter from 001-FT-101 to 001-FT-102

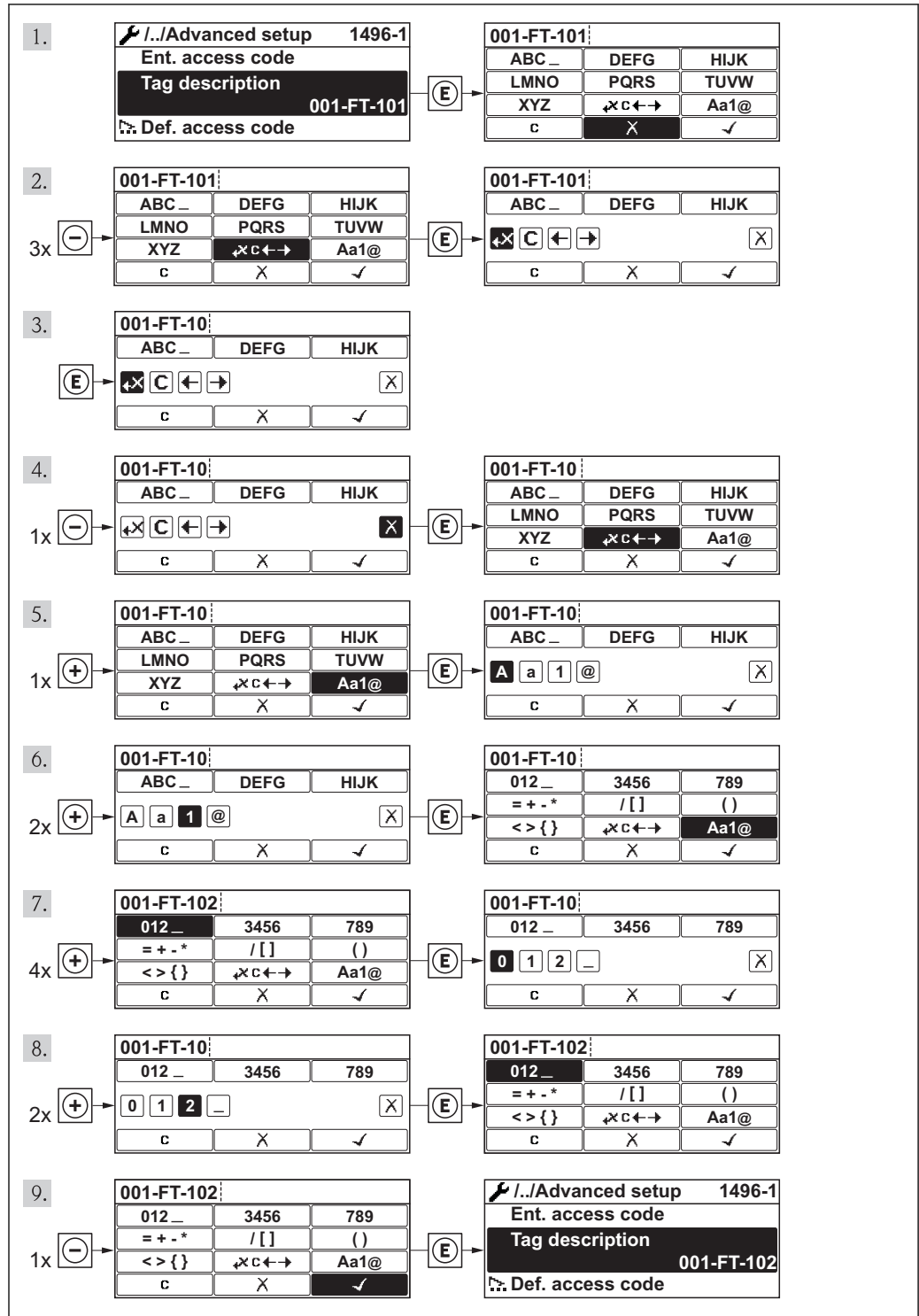

A0014020-EN



### 8.3.10 User roles and related access authorization

The two user roles "Operator" and "Maintenance" have different write access to the parameters if the customer defines a user-specific access code. This protects the device configuration via the local display from unauthorized access .

*Access authorization to parameters*

User role	Read access		Write access	
	Without access code (from the factory)	With access code	Without access code (from the factory)	With access code
Operator	✓	✓	✓	-- 1)
Maintenance	✓	✓	✓	✓

- 1) Despite the defined access code, certain parameters can always be modified and thus are excepted from the write protection, as they do not affect the measurement. Refer to the "Write protection via access code" section



If an incorrect access code is entered, the user obtains the access rights of the "Operator" role.

 The user role with which the user is currently logged on is indicated by the **Access status display** parameter. Navigation path: Operation → Access status display

### 8.3.11 Disabling write protection via access code

If the -symbol appears on the local display in front of a parameter, the parameter is write-protected by a user-specific access code and its value cannot be changed at the moment using the local display .

The locking of the write access via local operation can be disabled by entering the customer-defined access code via the respective access option.

1. After you press , the input prompt for the access code appears.
2. Enter the access code.
  - ↳ The -symbol in front of the parameters disappears; all previously write-protected parameters are now re-enabled.

### 8.3.12 Enabling and disabling the keypad lock



The keypad lock makes it possible to block access to the entire operating menu via local operation. As a result, it is no longer possible to navigate through the operating menu or change the values of individual parameters. Users can only read the measured values on the operational display.

#### Local operation with mechanical push buttons (display module SD02)

 Display module SD02: order characteristic "Display; Operation", option C



The keypad lock is switched on and off in the same way:

*Switching on the keypad lock*

- ▶ The device is in the measured value display.  
Press the  +  +  keys simultaneously.  
↳ The message **Keylock on** appears on the display: The keypad lock is switched on.

 If the user attempts to access the operating menu while the keypad lock is active, the message **Keylock on** appears.

*Switching off the keypad lock*

- ▶ The keypad lock is switched on.  
Press the  +  +  keys simultaneously.
  - ↳ The message **Keylock off** appears on the display: The keypad lock is switched off.

**Local operation with touch control (display module SD03)**

 Display module SD03: Order characteristic "Display; Operation", option **E**

The keypad lock is switched on and off via the context menu.

*Switching on the keypad lock*

The keypad lock is switched on automatically:

- Each time the device is restarted.
- If the device has not been operated for longer than one minute in the measured value display.

1. The device is in the measured value display.  
Press the  key for longer than 2 seconds.
  - ↳ A context menu appears.
2. In the context menu, select the **Keylock on** option.
  - ↳ The keypad lock is switched on.

 If the user attempts to access the operating menu while the keypad lock is active, the message **Keylock on** appears.

*Switching off the keypad lock*

1. The keypad lock is switched on.  
Press the  key for longer than 2 seconds.
  - ↳ A context menu appears.
2. In the context menu, select the **Keylock off** option.
  - ↳ The keypad lock is switched off.

## 8.4 Access to the operating menu via the operating tool

The structure of the operating menu in the operating tools is the same as for operation via the local display.

### 8.4.1 Connecting the operating tool

#### Via service interface (CDI)

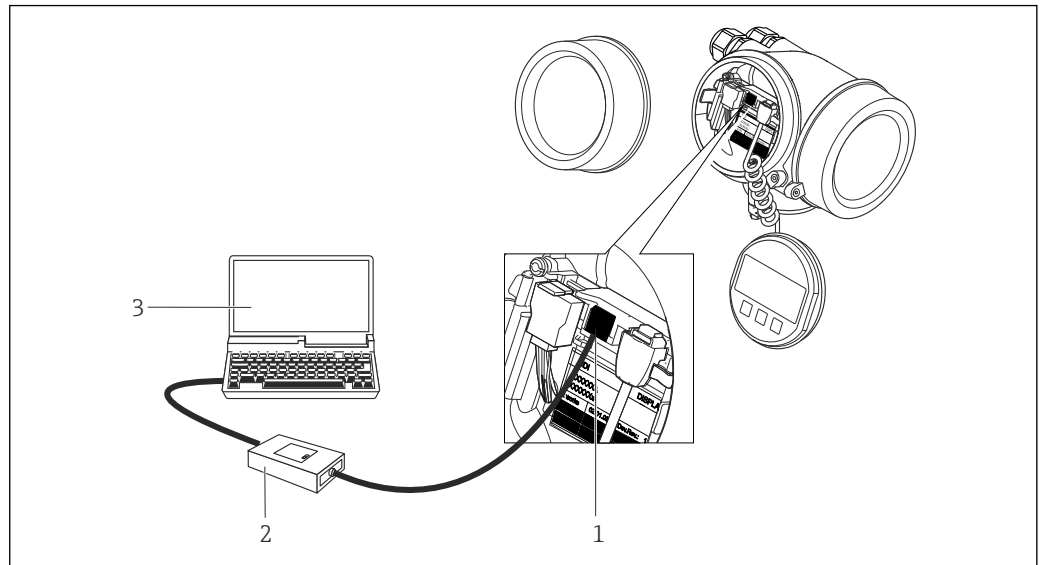

- 1 Service interface (CDI = Endress+Hauser Common Data Interface) of the measuring device  
 2 Commubox FXA291  
 3 Computer with "FieldCare" operating tool with COM DTM "CDI Communication FXA291"

A0020545

### 8.4.2 Field Xpert SFX350, SFX370

#### Function scope

Field Xpert SFX350 and Field Xpert SFX370 are mobile computers for commissioning and maintenance. They enable efficient device configuration and diagnostics for HART and FOUNDATION fieldbus devices in the **non-Ex area** (SFX350, SFX370) and the **Ex area** (SFX370).



For details, see Operating Instructions BA01202S

#### Source for device description files

See data →  62

### 8.4.3 FieldCare

#### Function scope

FDT-based plant asset management tool from Endress+Hauser. It can configure all smart field devices in a system and helps you manage them. By using the status information, it is also a simple but effective way of checking their status and condition.

Access is via:

- HART protocol
- Service interface CDI →  59

Typical functions:

- Configuring parameters of transmitters
- Loading and saving device data (upload/download)
- Documentation of the measuring point
- Visualization of the measured value memory (line recorder) and event logbook

 For additional information about FieldCare, see Operating Instructions BA00027S and BA00059S

**Source for device description files**

See information →  62

**Establishing a connection**

 For additional information, see Operating Instructions BA00027S and BA00059S

**User interface**

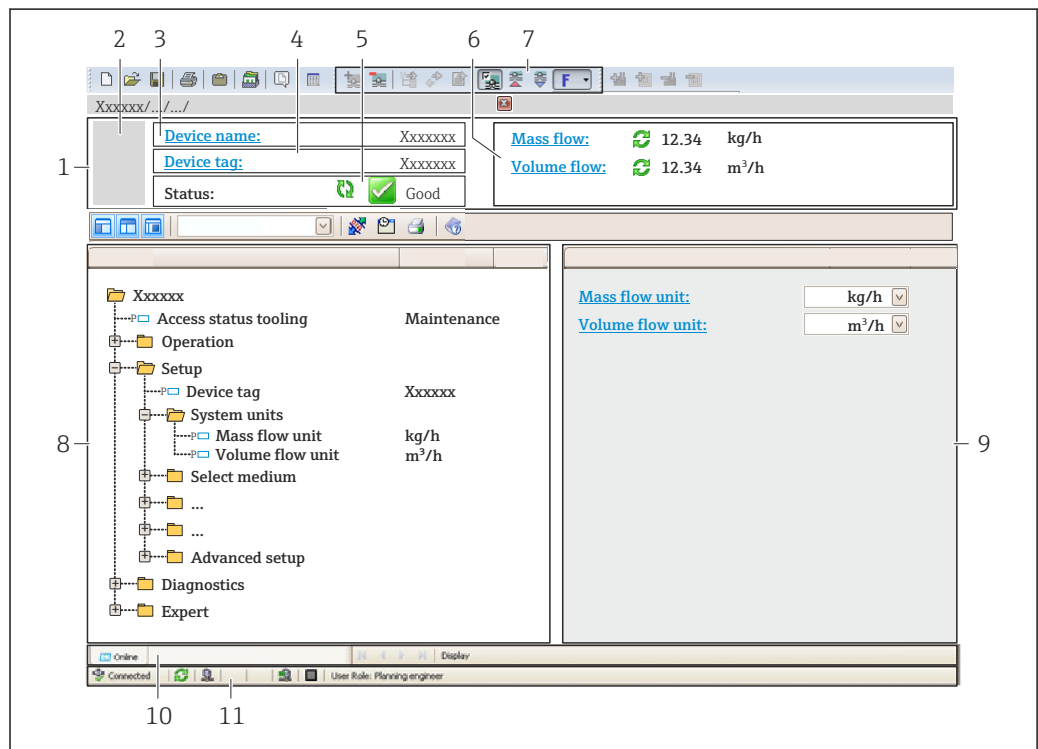

A0021051-EN

- 1 Header
- 2 Picture of device
- 3 Device name
- 4 Tag name
- 5 Status area with status signal
- 6 Display area for current measured values
- 7 Edit toolbar with additional functions such as save/restore, event list and create documentation
- 8 Navigation area with operating menu structure
- 9 Working area
- 10 Range of action
- 11 Status area

### 8.4.4 AMS Device Manager

#### Function scope

Program from Emerson Process Management for operating and configuring measuring devices via HART protocol.

#### Source for device description files

See data →  62

### 8.4.5 SIMATIC PDM

#### Function scope

SIMATIC PDM is a standardized, manufacturer-independent program from Siemens for the operation, configuration, maintenance and diagnosis of intelligent field devices via HART protocol.

#### Source for device description files

See data →  62

### 8.4.6 Field Communicator 475

#### Function scope

Industrial handheld terminal from Emerson Process Management for remote configuration and measured value display via HART protocol.

#### Source for device description files

See data →  62

## 9 System integration

### 9.1 Overview of device description files

#### 9.1.1 Current version data for the device

Firmware version	01.02.00	<ul style="list-style-type: none"> <li>▪ On the title page of the Operating instructions</li> <li>▪ On transmitter nameplate</li> <li>▪ <b>Firmware version</b> parameter "Diagnostics" menu → Device information → Firmware version</li> </ul>
Release date of firmware version	10.2014	---
Manufacturer ID	0x11	<b>Manufacturer ID</b> parameter "Diagnostics" menu → Device information → Manufacturer ID
Device type ID	0x38	<b>Device type</b> parameter "Diagnostics" menu → Device information → Device type
HART protocol revision	7	---
Device revision	3	<ul style="list-style-type: none"> <li>▪ On transmitter nameplate</li> <li>▪ <b>Device revision</b> parameter "Diagnostics" menu → Device information → Device revision</li> </ul>



For an overview of the different firmware versions for the device → 153

#### 9.1.2 Operating tools

The suitable device description file for the individual operating tools is listed in the table below, along with information on where the file can be acquired.

Operating tool via HART protocol	Sources for obtaining device descriptions
<ul style="list-style-type: none"> <li>▪ Field Xpert SFX350</li> <li>▪ Field Xpert SFX370</li> </ul>	Use update function of handheld terminal
FieldCare	<ul style="list-style-type: none"> <li>▪ <a href="http://www.endress.com">www.endress.com</a> → Download Area</li> <li>▪ CD-ROM (contact Endress+Hauser)</li> <li>▪ DVD (contact Endress+Hauser)</li> </ul>
AMS Device Manager (Emerson Process Management)	<a href="http://www.endress.com">www.endress.com</a> → Download Area
SIMATIC PDM (Siemens)	<a href="http://www.endress.com">www.endress.com</a> → Download Area
Field Communicator 475 (Emerson Process Management)	Use update function of handheld terminal

## 9.2 Measured variables via HART protocol

The following measured variables (HART device variables) are assigned to the dynamic variables at the factory:

Dynamic variables	Measured variables (HART device variables)
Primary dynamic variable (PV)	Volume flow
Secondary dynamic variable (SV)	Temperature

Dynamic variables	Measured variables (HART device variables)
Tertiary dynamic variable (TV)	Totalizer 1
Quaternary dynamic variable (QV)	Totalizer 2

The assignment of the measured variables to the dynamic variables can be modified and assigned as desired via local operation and the operating tool using the following parameters:

- Expert → Communication → HART output → Output → Assign PV
- Expert → Communication → HART output → Output → Assign SV
- Expert → Communication → HART output → Output → Assign TV
- Expert → Communication → HART output → Output → Assign QV

The following measured variables can be assigned to the dynamic variables:

#### Measured variables for PV (primary dynamic variable)

- Volume flow
- Corrected volume flow
- Mass flow
- Flow velocity
- Temperature
- Calculated saturated steam pressure
- Steam quality
- Total mass flow
- Energy flow
- Heat flow difference

#### Measured variables for SV, TV, QV (secondary, tertiary and quaternary dynamic variable)

- Volume flow
- Corrected volume flow
- Mass flow
- Flow velocity
- Temperature
- Calculated saturated steam pressure
- Steam quality
- Total mass flow
- Energy flow
- Heat flow difference
- Condensate mass flow
- Reynolds number
- Totalizer 1 to 3
- HART input
- Density
- Pressure
- Specific volume
- Degree of overheating

 The range of options increases if the measuring device has one or more application packages.

#### Device variables

The device variables are permanently assigned. A maximum of 8 device variables can be transmitted:

- 0 = volume flow
- 1 = corrected volume flow
- 2 = Mass flow
- 3 = flow velocity
- 4 = temperature

- 5 = calculated saturated steam pressure
- 6 = steam quality
- 7 = total mass flow
- 8 = energy flow
- 9 = heat flow difference
- 10 = condensate mass flow
- 11 = Reynolds number
- 12 = totalizer 1
- 13 = totalizer 2
- 14 = totalizer 3

## 9.3 Other settings

### 9.3.1 Burst mode functionality in accordance with HART 7 Specification

#### Navigation

"Expert" menu → Communication → HART output → Burst configuration → Burst configuration 1 to 3

The screenshot shows a hierarchical menu structure for burst configuration. At the top is a grey button labeled '► Burst configuration'. Below it is another grey button labeled '► Burst configuration 1 to 3'. Underneath this are ten white rectangular buttons, each containing a text label: 'Burst mode 1 to 3', 'Burst command 1 to 3', 'Burst variable 0', 'Burst variable 1', 'Burst variable 2', 'Burst variable 3', 'Burst variable 4', 'Burst variable 5', 'Burst variable 6', 'Burst variable 7', 'Burst trigger mode', and 'Burst trigger level'.



Min. update period
Max. update period

### Parameter overview with brief description

Parameter	Description	Selection / User entry	Factory setting
Burst mode 1 to 3	Activate the HART burst mode for burst message X.	<ul style="list-style-type: none"> <li>■ Off</li> <li>■ On</li> </ul>	Off
Burst command 1 to 3	Select the HART command that is sent to the HART master.	<ul style="list-style-type: none"> <li>■ Command 1</li> <li>■ Command 2</li> <li>■ Command 3</li> <li>■ Command 9</li> <li>■ Command 33</li> <li>■ Command 48</li> </ul>	Command 2
Burst variable 0		<ul style="list-style-type: none"> <li>■ Volume flow</li> <li>■ Corrected volume flow</li> <li>■ Mass flow</li> <li>■ Flow velocity</li> <li>■ Temperature</li> <li>■ Calculated saturated steam pressure *</li> <li>■ Steam quality *</li> <li>■ Total mass flow *</li> <li>■ Energy flow *</li> <li>■ Heat flow difference *</li> <li>■ Condensate mass flow *</li> <li>■ Reynolds number *</li> <li>■ Totalizer 1</li> <li>■ Totalizer 2</li> <li>■ Totalizer 3</li> <li>■ HART input</li> <li>■ Density *</li> <li>■ Pressure *</li> <li>■ Specific volume *</li> <li>■ Degrees of superheat *</li> <li>■ Percent Of Range</li> <li>■ Measured current</li> <li>■ Primary variable (PV)</li> <li>■ Secondary variable (SV)</li> <li>■ Tertiary variable (TV)</li> <li>■ Quaternary variable (QV)</li> <li>■ Not used</li> </ul>	Volume flow
Burst variable 1		See the <b>Burst variable 0</b> parameter.	Not used
Burst variable 2		See the <b>Burst variable 0</b> parameter.	Not used
Burst variable 3		See the <b>Burst variable 0</b> parameter.	Not used
Burst variable 4		See the <b>Burst variable 0</b> parameter.	Not used
Burst variable 5		See the <b>Burst variable 0</b> parameter.	Not used
Burst variable 6		See the <b>Burst variable 0</b> parameter.	Not used
Burst variable 7		See the <b>Burst variable 0</b> parameter.	Not used

Parameter	Description	Selection / User entry	Factory setting
Burst trigger mode	Select the event that triggers burst message X.	<ul style="list-style-type: none"> <li>■ Continuous</li> <li>■ Window</li> <li>■ Rising</li> <li>■ Falling</li> <li>■ On change</li> </ul>	Continuous
Burst trigger level	Enter the burst trigger value. Together with the option selected in the <b>Burst trigger mode</b> parameter the burst trigger value determines the time of burst message X.	Positive floating-point number	–
Min. update period		Positive integer	1 000 ms
Max. update period		Positive integer	2 000 ms

\* Visibility depends on order options or device settings

## 10 Commissioning

### 10.1 Function check

Before commissioning the measuring device:

- ▶ Make sure that the post-installation and post-connection checks have been performed.
- "Post-installation check" checklist → 📄 28
- "Post-connection check" checklist → 📄 43

### 10.2 Switching on the measuring device

- ▶ After a successful function check, switch on the measuring device.
  - ↳ After a successful startup, the local display switches automatically from the startup display to the operational display.

**i** If nothing appears on the local display or a diagnostic message is displayed, refer to the section on "Diagnostics and troubleshooting" → 📄 136.

### 10.3 Setting the operating language

Factory setting: English or ordered local language

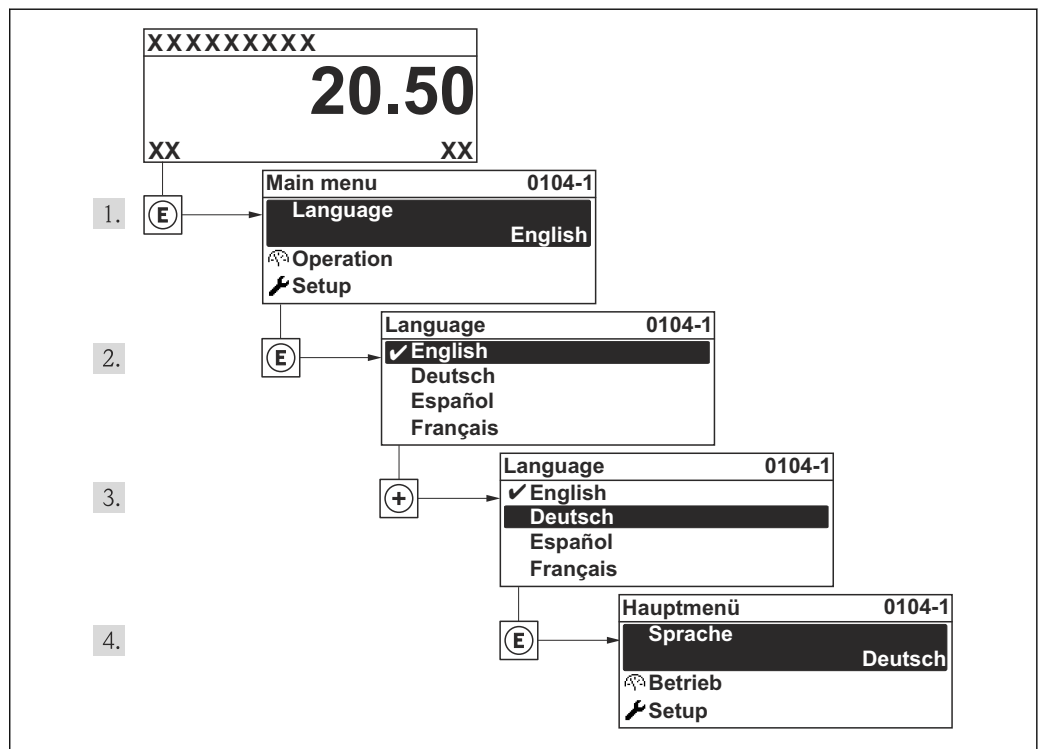

**19** Taking the example of the local display

A0013996

## 10.4 Configuring the measuring device

- The **Setup** menu with its guided wizards contains all the parameters needed for standard operation.
- Navigation to the **Setup** menu

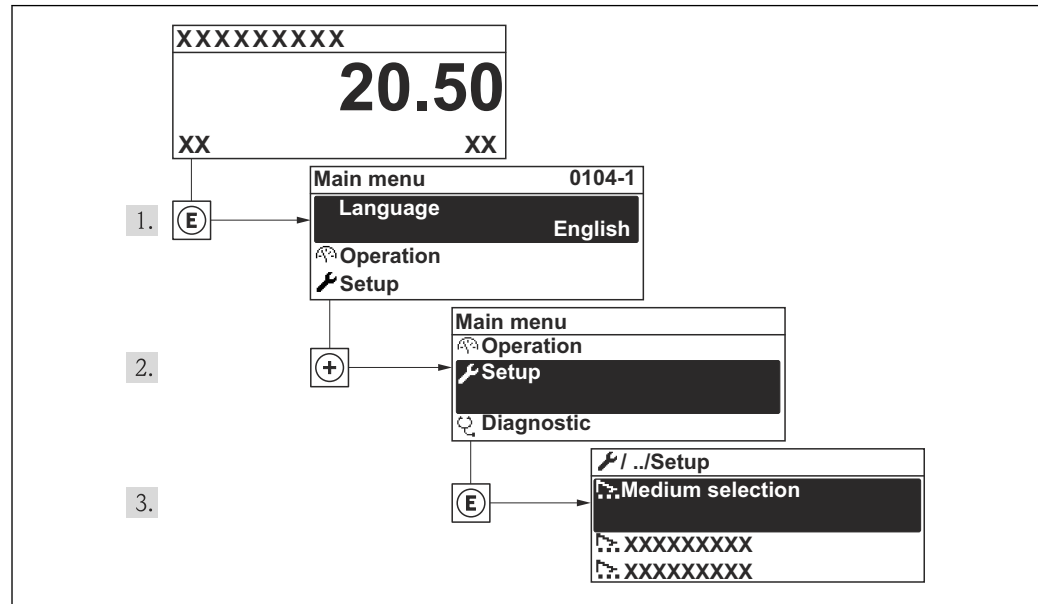

A0014007-EN

20 Taking the example of the local display

### Overview of the wizards in the "Setup" menu

🔧 Setup	
Device tag	→ 69
▶ Medium selection	→ 70
▶ Current input	→ 72
▶ Current output 1 to 2	→ 75
▶ Pulse/frequency/switch output	→ 78
▶ Display	→ 89
▶ Output conditioning	→ 91
▶ Low flow cut off	→ 92
▶ Advanced setup	→ 94

#### 10.4.1 Defining the tag name

To enable fast identification of the measuring point within the system, you can enter a unique designation using the **Device tag** parameter and thus change the factory setting.

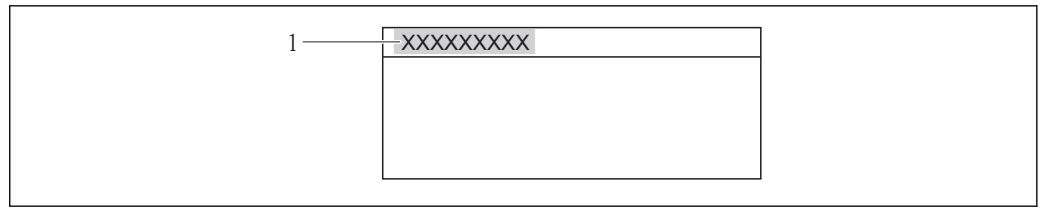

A0013375

21 Header of the operational display with tag name

1 Device tag

-  The number of characters displayed depends on the characters used.
- Enter the tag name in the "FieldCare" operating tool →  60

**Navigation**

"Setup" menu → Device tag

**Parameter overview with brief description**

Parameter	Description	User entry	Factory setting
Device tag	Enter the name for the measuring point.	Max. 32 characters such as letters, numbers or special characters (e.g. @, %, /).	Prowirl

### 10.4.2 Selecting and setting the medium

The **Medium selection** wizard guides you systematically through all the parameters that have to be configured for selecting and setting the medium.

#### Navigation

"Setup" menu → Medium selection

#### Structure of the wizard

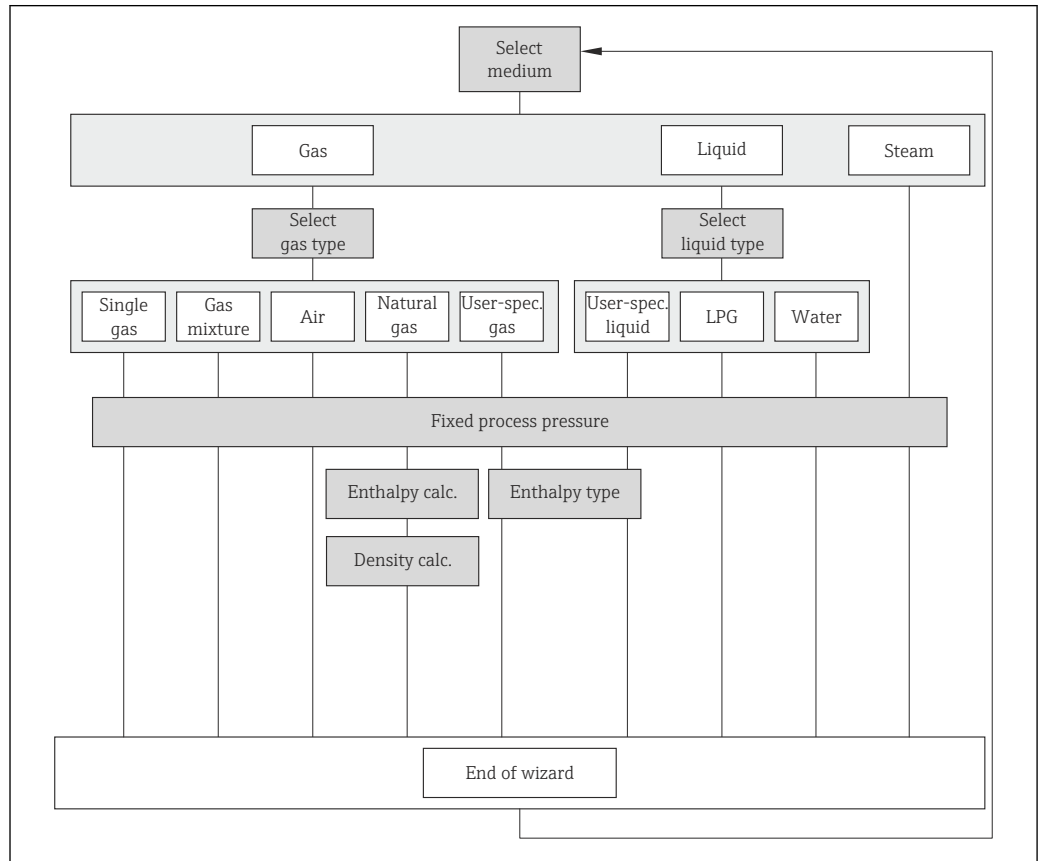



A0020776-EN

22 "Medium selection" wizard in the "Setup" menu

#### Parameter overview with brief description

Parameter	Prerequisite	Description	Selection / User entry	Factory setting
Select medium	-	Select medium type.	<ul style="list-style-type: none"> <li>■ Gas</li> <li>■ Liquid</li> <li>■ Steam</li> </ul>	Steam
Select gas type	The following conditions are met: <ul style="list-style-type: none"> <li>■ Order code                             <ul style="list-style-type: none"> <li>- "Sensor version", option "Mass flow"</li> <li>- "Application package", option "Air + Industrial gases" or option "Natural gas"</li> </ul> </li> <li>■ The <b>Gas</b> option is selected in the <b>Select medium</b> parameter.</li> </ul>	Select measured gas type.	<ul style="list-style-type: none"> <li>■ Single gas</li> <li>■ Gas mixture</li> <li>■ Air</li> <li>■ Natural gas</li> <li>■ User-specific gas</li> </ul>	User-specific gas

Parameter	Prerequisite	Description	Selection / User entry	Factory setting
Select liquid type	The following conditions are met: <ul style="list-style-type: none"> <li>▪ Order code for "Sensor version", option "Mass flow"</li> <li>▪ The <b>Liquid</b> option is selected in the <b>Select medium</b> parameter.</li> </ul>	Select measured liquid type.	<ul style="list-style-type: none"> <li>▪ Water</li> <li>▪ LPG (liquefied petroleum gas)</li> <li>▪ User-specific liquid</li> </ul>	Water
Select steam type	The following conditions are met: <ul style="list-style-type: none"> <li>▪ Order code for "Sensor version", option "Mass flow (integrated temperature measurement)"</li> <li>▪ In the <b>Select medium</b> parameter, the <b>Steam</b> option is selected.</li> </ul>	Select measured steam type.	<ul style="list-style-type: none"> <li>▪ Wet steam</li> <li>▪ Superheated steam</li> <li>▪ Saturated steam</li> </ul>	Saturated steam
Fixed process pressure	The following conditions are met: <ul style="list-style-type: none"> <li>▪ Order code for "Sensor version", option "Mass flow (integrated temperature measurement)"</li> <li>▪ In the <b>External value</b> parameter (→ 73), the <b>Pressure</b> option is not selected.</li> </ul>	Enter fixed value for process pressure.  <i>Dependency</i> The unit is taken from the <b>Pressure unit</b> parameter  For detailed information on the calculation of the measured variables with steam: → 164   For detailed information on setting the parameter in steam applications, see the Special Documentation for the <b>Wet Steam Detection and Wet Steam Measurement</b> → 188 application package.	0 to 250 bar abs.	0 bar abs.
Enthalpy calculation	The following conditions are met: <ul style="list-style-type: none"> <li>▪ Order code                             <ul style="list-style-type: none"> <li>– "Sensor version", option "Mass flow (integrated temperature measurement)"</li> <li>– "Application package", option "Natural gas"</li> </ul> </li> <li>▪ In the <b>Select medium</b> parameter, the <b>Gas</b> option is selected and in the <b>Select gas type</b> parameter, the <b>Natural gas</b> option is selected.</li> </ul>	Select the norm the enthalpy calculation is based on.	<ul style="list-style-type: none"> <li>▪ AGA5</li> <li>▪ ISO 6976</li> </ul>	AGA5

Parameter	Prerequisite	Description	Selection / User entry	Factory setting
Density calculation	The following conditions are met: <ul style="list-style-type: none"> <li>▪ In the <b>Select medium</b> parameter, the <b>Gas</b> option is selected.</li> <li>▪ In the <b>Select gas type</b> parameter, the <b>Natural gas</b> option is selected.</li> </ul>	Select the norm the density calculation is based on.	<ul style="list-style-type: none"> <li>▪ AGA Nx19</li> <li>▪ ISO 12213- 2</li> <li>▪ ISO 12213- 3</li> </ul>	AGA Nx19
Enthalpy type	The following conditions are met: <ul style="list-style-type: none"> <li>▪ In the <b>Select gas type</b> parameter, the <b>User-specific gas</b> option is selected.</li> </ul> Or <ul style="list-style-type: none"> <li>▪ In the <b>Select liquid type</b> parameter, the <b>User-specific liquid</b> option is selected.</li> </ul>	Define which kind of enthalpy is used.	<ul style="list-style-type: none"> <li>▪ Heat</li> <li>▪ Calorific value</li> </ul>	Heat

### 10.4.3 Configuring the current input

The "**Current input**" submenu guides you systematically through all the parameters that have to be set for configuring the current input.

 The **Fixed process pressure** parameter is set to the value **0 bar abs.** (ex works). In this case, the measuring device ignores the pressure read in via the current input. For the measuring device to use the external (read-in) pressure, a value > 0 bar abs. must be entered in the **Fixed process pressure** parameter.

For a detailed description of how to calculate the mass flow and energy flow:  
 →  163

#### Navigation

"Setup" menu → Current input



#### Structure of the submenu

▶ Current input



<div style="border: 1px solid black; width: 80%; margin: 0 auto; padding: 2px;">Failure mode</div>
<div style="border: 1px solid black; width: 80%; margin: 0 auto; padding: 2px;">Failure value</div>

**Parameter overview with brief description**

Parameter	Prerequisite	Description	Selection / User entry	Factory setting
External value	For the following order code: "Sensor version", option "Mass flow"	Assign variable from external device to process variable.  For detailed information on the calculation of the measured variables with steam: → 164  For detailed information on setting the parameter in steam applications, see the Special Documentation for the <b>Wet Steam Detection and Wet Steam Measurement</b> → 188 application package.	<ul style="list-style-type: none"> <li>▪ Off</li> <li>▪ Pressure</li> <li>▪ Relative pressure</li> <li>▪ Density</li> <li>▪ Temperature</li> <li>▪ 2nd temperature delta heat</li> </ul>	Off
Pressure unit	For the following order code: "Sensor version", option "Mass flow"	Select process pressure unit. <i>Effect</i> The unit is taken from the: <ul style="list-style-type: none"> <li>▪ Calculated saturated steam pressure</li> <li>▪ Atmospheric pressure</li> <li>▪ Maximum value</li> <li>▪ Fixed process pressure</li> <li>▪ Pressure</li> <li>▪ Reference pressure</li> </ul>	Unit choose list	Country-specific: <ul style="list-style-type: none"> <li>▪ bar</li> <li>▪ psi</li> </ul>
Atmospheric pressure	–	Enter atmospheric pressure value to be used for pressure correction.	0 to 250 bar	1.01325 bar
Temperature unit	–	Select temperature unit. <i>Effect</i> The selected unit applies for: <ul style="list-style-type: none"> <li>▪ Temperature</li> <li>▪ Maximum value</li> <li>▪ Minimum value</li> <li>▪ Average value</li> <li>▪ Maximum value</li> <li>▪ Minimum value</li> <li>▪ Maximum value</li> <li>▪ Minimum value</li> <li>▪ 2nd temperature delta heat</li> <li>▪ Fixed temperature</li> <li>▪ Reference combustion temperature</li> <li>▪ Reference temperature</li> <li>▪ Saturation temperature</li> </ul>	Unit choose list	Country-specific: <ul style="list-style-type: none"> <li>▪ °C</li> <li>▪ °F</li> </ul>
Density unit	–	Select density unit. <i>Effect</i> The selected unit applies for: <ul style="list-style-type: none"> <li>▪ Output</li> <li>▪ Simulation process variable</li> </ul>	Unit choose list	Country-specific: <ul style="list-style-type: none"> <li>▪ kg/m<sup>3</sup></li> <li>▪ lb/ft<sup>3</sup></li> </ul>

Parameter	Prerequisite	Description	Selection / User entry	Factory setting
Current span	–	Select current range for process value output and upper/lower level for alarm signal.	<ul style="list-style-type: none"> <li>▪ 4...20 mA</li> <li>▪ 4...20 mA NAMUR</li> <li>▪ 4...20 mA US</li> </ul>	Country-specific: <ul style="list-style-type: none"> <li>▪ 4...20 mA NAMUR</li> <li>▪ 4...20 mA US</li> </ul>
4 mA value	–	Enter 4 mA value.	Signed floating-point number	0
20 mA value	–	Enter 20 mA value.	Signed floating-point number	Depends on country and nominal diameter
Failure mode	–	Define input behavior in alarm condition.	<ul style="list-style-type: none"> <li>▪ Alarm</li> <li>▪ Last valid value</li> <li>▪ Defined value</li> </ul>	Alarm
Failure value	In the <b>Failure mode</b> parameter, the <b>Defined value</b> option is selected.	Enter value to be used by the device if input value from external device is missing.	Signed floating-point number	0

### 10.4.4 Configuring the current output

The "Current output 1 to 2" wizard guides you systematically through all the parameters that have to be set for configuring the specific current output.

#### Navigation

"Setup" menu → Current output 1 to 2

#### Structure of the wizard

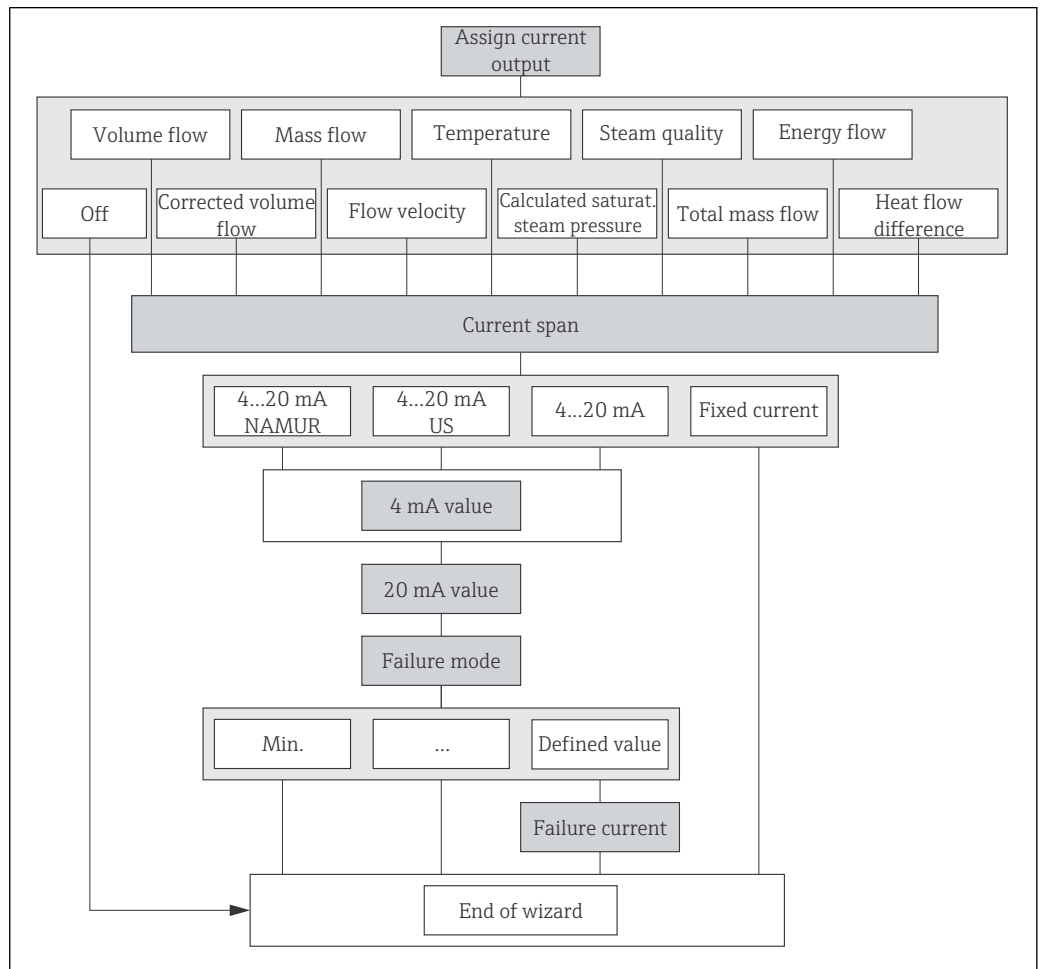

23 "Current output 1 to 2" wizard in the "Setup" menu

A0020788-EN

## Parameter overview with brief description

Parameter	Prerequisite	Description	Selection / User entry	Factory setting
Assign current output	–	Select process variable for current output.	<ul style="list-style-type: none"> <li>▪ Off</li> <li>▪ Volume flow</li> <li>▪ Corrected volume flow</li> <li>▪ Mass flow</li> <li>▪ Flow velocity</li> <li>▪ Temperature</li> <li>▪ Calculated saturated steam pressure *</li> <li>▪ Steam quality *</li> <li>▪ Total mass flow *</li> <li>▪ Energy flow *</li> <li>▪ Heat flow difference *</li> </ul>	Volume flow
Mass flow unit	–	Select mass flow unit. <i>Effect</i> The selected unit applies for: <ul style="list-style-type: none"> <li>▪ Output</li> <li>▪ Low flow cut off</li> <li>▪ Simulation process variable</li> </ul>	Unit choose list	Country-specific: <ul style="list-style-type: none"> <li>▪ kg/h</li> <li>▪ lb/min</li> </ul>
Volume flow unit	–	Select volume flow unit. <i>Effect</i> The selected unit applies for: <ul style="list-style-type: none"> <li>▪ Output</li> <li>▪ Low flow cut off</li> <li>▪ Simulation process variable</li> </ul>	Unit choose list	Country-specific: <ul style="list-style-type: none"> <li>▪ m<sup>3</sup>/h</li> <li>▪ ft<sup>3</sup>/min</li> </ul>
Corrected volume flow unit	–	Select corrected volume flow unit. <i>Effect</i> The selected unit applies for: Corrected volume flow	Unit choose list	Country-specific: <ul style="list-style-type: none"> <li>▪ Nm<sup>3</sup>/h</li> <li>▪ Sft<sup>3</sup>/h</li> </ul>
Temperature unit	–	Select temperature unit. <i>Effect</i> The selected unit applies for: <ul style="list-style-type: none"> <li>▪ Temperature</li> <li>▪ Maximum value</li> <li>▪ Minimum value</li> <li>▪ Average value</li> <li>▪ Maximum value</li> <li>▪ Minimum value</li> <li>▪ Maximum value</li> <li>▪ Minimum value</li> <li>▪ 2nd temperature delta heat</li> <li>▪ Fixed temperature</li> <li>▪ Reference combustion temperature</li> <li>▪ Reference temperature</li> <li>▪ Saturation temperature</li> </ul>	Unit choose list	Country-specific: <ul style="list-style-type: none"> <li>▪ °C</li> <li>▪ °F</li> </ul>
Energy flow unit	For the following order code: "Sensor version", option "Mass flow"	Select energy flow unit. <i>Result</i> The selected unit applies for: <ul style="list-style-type: none"> <li>▪ Outputs</li> <li>▪ Low flow cut off</li> </ul>	Unit choose list	Country-specific: <ul style="list-style-type: none"> <li>▪ kW</li> <li>▪ Btu/h</li> </ul>

Parameter	Prerequisite	Description	Selection / User entry	Factory setting
Pressure unit	For the following order code: "Sensor version", option "Mass flow"	Select process pressure unit. <i>Effect</i> The unit is taken from the: <ul style="list-style-type: none"> <li>Calculated saturated steam pressure</li> <li>Atmospheric pressure</li> <li>Maximum value</li> <li>Fixed process pressure</li> <li>Pressure</li> <li>Reference pressure</li> </ul>	Unit choose list	Country-specific: <ul style="list-style-type: none"> <li>bar</li> <li>psi</li> </ul>
Velocity unit	–	Select velocity unit. <i>Result</i> The selected unit applies for: <ul style="list-style-type: none"> <li>Flow velocity</li> <li>Maximum value</li> </ul>	Unit choose list	Country-specific: <ul style="list-style-type: none"> <li>m/s</li> <li>ft/s</li> </ul>
Current span	–	Select current range for process value output and upper/lower level for alarm signal.	<ul style="list-style-type: none"> <li>4...20 mA NAMUR</li> <li>4...20 mA US</li> <li>4...20 mA</li> <li>Fixed current</li> </ul>	Country-specific: <ul style="list-style-type: none"> <li>4...20 mA NAMUR</li> <li>4...20 mA US</li> </ul>
4 mA value	In the <b>Current span</b> parameter (→ ☰ 77), one of the following options is selected: <ul style="list-style-type: none"> <li>4...20 mA NAMUR</li> <li>4...20 mA US</li> <li>4...20 mA</li> </ul>	Enter 4 mA value.	Signed floating-point number	Country-specific: <ul style="list-style-type: none"> <li>0 m<sup>3</sup>/h</li> <li>0 ft<sup>3</sup>/min</li> </ul>
20 mA value	In the <b>Current span</b> parameter (→ ☰ 77), one of the following options is selected: <ul style="list-style-type: none"> <li>4...20 mA NAMUR</li> <li>4...20 mA US</li> <li>4...20 mA</li> </ul>	Enter 20 mA value.	Signed floating-point number	Depends on country and nominal diameter
Failure mode	In the <b>Assign current output</b> parameter (→ ☰ 76), one of the following options is selected: <ul style="list-style-type: none"> <li>Volume flow</li> <li>Corrected volume flow</li> <li>Mass flow</li> <li>Flow velocity</li> <li>Temperature</li> <li>Calculated saturated steam pressure<sup>*</sup></li> <li>Steam quality<sup>*</sup></li> <li>Total mass flow<sup>*</sup></li> <li>Energy flow<sup>*</sup></li> <li>Heat flow difference<sup>*</sup></li> </ul> In the <b>Current span</b> parameter (→ ☰ 77), one of the following options is selected: <ul style="list-style-type: none"> <li>4...20 mA NAMUR</li> <li>4...20 mA US</li> <li>4...20 mA</li> </ul>	Define output behavior in alarm condition.	<ul style="list-style-type: none"> <li>Min.</li> <li>Max.</li> <li>Last valid value</li> <li>Actual value</li> <li>Defined value</li> </ul>	Max.
Failure current	The <b>Defined value</b> option is selected in the <b>Failure mode</b> parameter.	Enter current output value in alarm condition.	3.59 to 22.5 mA	22.5 mA

\* Visibility depends on order options or device settings

### 10.4.5 Configuring the pulse/frequency/switch output

The **Pulse/frequency/switch output** wizard guides you systematically through all the parameters that can be set for configuring the selected output type.

#### Configuring the pulse output

##### Navigation

"Setup" menu → Pulse/frequency/switch output

#### Structure of the wizard for the pulse output

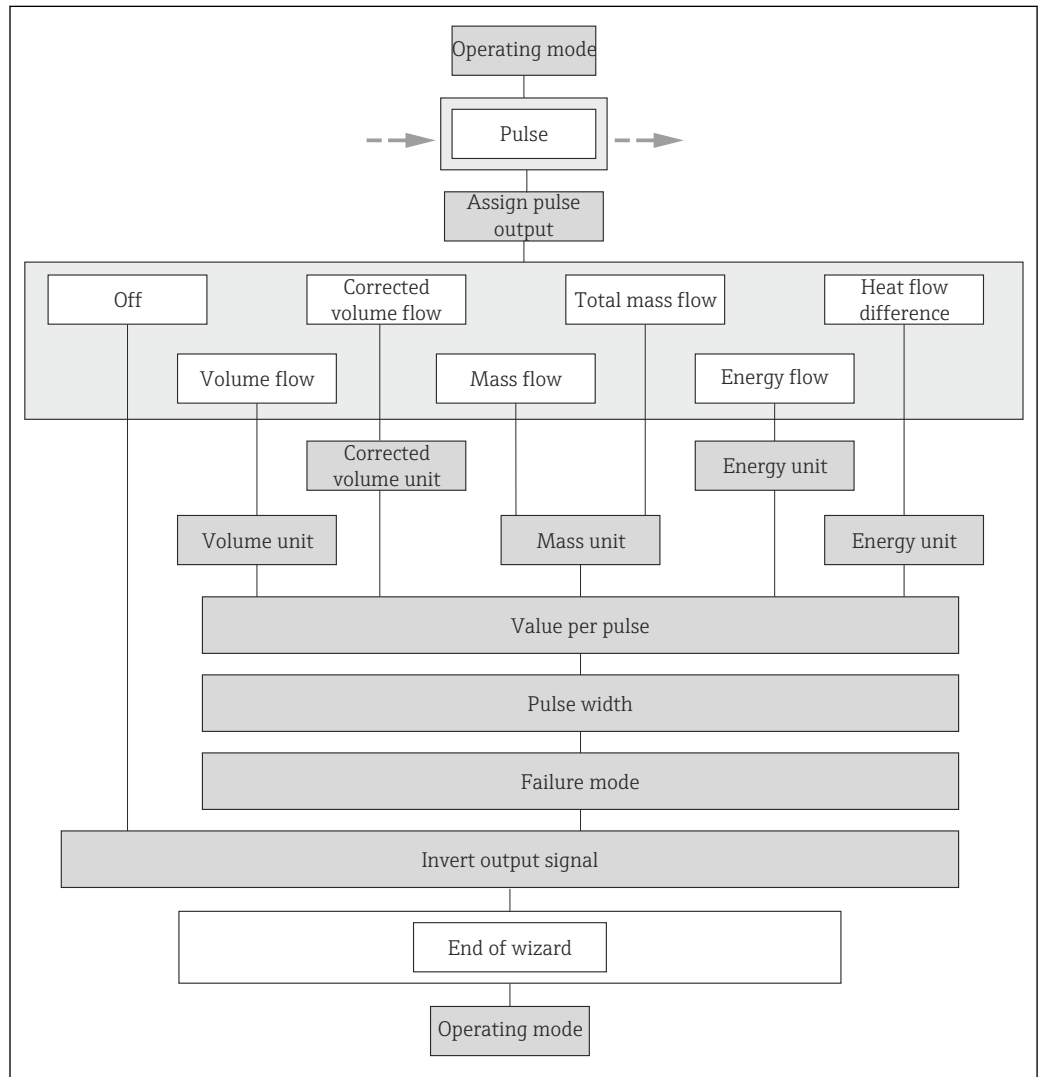

A0020792-EN

24 "Pulse/frequency/switch output" wizard in the "Setup" menu: "Operating mode" parameter "Pulse" option

## Parameter overview with brief description

Parameter	Prerequisite	Description	Selection / User entry	Factory setting
Operating mode	–	Define the output as a pulse, frequency or switch output.	<ul style="list-style-type: none"> <li>■ Pulse</li> <li>■ Frequency</li> <li>■ Switch</li> </ul>	Pulse
Assign pulse output	The <b>Pulse</b> option is selected in the <b>Operating mode</b> parameter.	Select process variable for pulse output.	<ul style="list-style-type: none"> <li>■ Off</li> <li>■ Volume flow</li> <li>■ Corrected volume flow</li> <li>■ Mass flow</li> <li>■ Total mass flow *</li> <li>■ Energy flow *</li> <li>■ Heat flow difference *</li> </ul>	Volume flow
Mass unit	–	Select mass unit.	Unit choose list	Country-specific: <ul style="list-style-type: none"> <li>■ kg</li> <li>■ lb</li> </ul>
Volume unit	–	Select volume unit.	Unit choose list	Country-specific: <ul style="list-style-type: none"> <li>■ m<sup>3</sup></li> <li>■ ft<sup>3</sup></li> </ul>
Corrected volume unit	–	Select corrected volume unit.	Unit choose list	Country-specific: <ul style="list-style-type: none"> <li>■ Nm<sup>3</sup></li> <li>■ Sft<sup>3</sup></li> </ul>
Energy unit	For the following order code: "Sensor version", option "Mass flow"	Select energy unit.	Unit choose list	Country-specific: <ul style="list-style-type: none"> <li>■ kWh</li> <li>■ Btu</li> </ul>
Value per pulse	The <b>Pulse</b> option is selected in the <b>Operating mode</b> parameter, and one of the following options is selected in the <b>Assign pulse output</b> parameter (→ 79): <ul style="list-style-type: none"> <li>■ Volume flow</li> <li>■ Corrected volume flow</li> <li>■ Mass flow</li> <li>■ Total mass flow *</li> <li>■ Energy flow *</li> <li>■ Heat flow difference *</li> </ul>	Enter measured value at which a pulse is output.	Positive floating-point number	Depends on country and nominal diameter
Pulse width	In the <b>Operating mode</b> parameter, the <b>Pulse</b> option is selected and one of the following options is selected in the <b>Assign pulse output</b> parameter (→ 79): <ul style="list-style-type: none"> <li>■ Volume flow</li> <li>■ Corrected volume flow</li> <li>■ Mass flow</li> <li>■ Total mass flow *</li> <li>■ Energy flow *</li> <li>■ Heat flow difference *</li> </ul>	Define time width of the output pulse.	5 to 2 000 ms	100 ms

Parameter	Prerequisite	Description	Selection / User entry	Factory setting
Failure mode	In the <b>Operating mode</b> parameter, the <b>Pulse</b> option is selected and one of the following options is selected in the <b>Assign pulse output</b> parameter (→ 79): <ul style="list-style-type: none"> <li>▪ Volume flow</li> <li>▪ Corrected volume flow</li> <li>▪ Mass flow</li> <li>▪ Total mass flow *</li> <li>▪ Energy flow *</li> <li>▪ Heat flow difference *</li> </ul>	Define output behavior in alarm condition.	<ul style="list-style-type: none"> <li>▪ Actual value</li> <li>▪ No pulses</li> </ul>	No pulses
Invert output signal	–	Invert the output signal.	<ul style="list-style-type: none"> <li>▪ No</li> <li>▪ Yes</li> </ul>	No

\* Visibility depends on order options or device settings



### Configuring the frequency output

#### Navigation

"Setup" menu → Pulse/frequency/switch output

#### Structure of the wizard for the frequency output

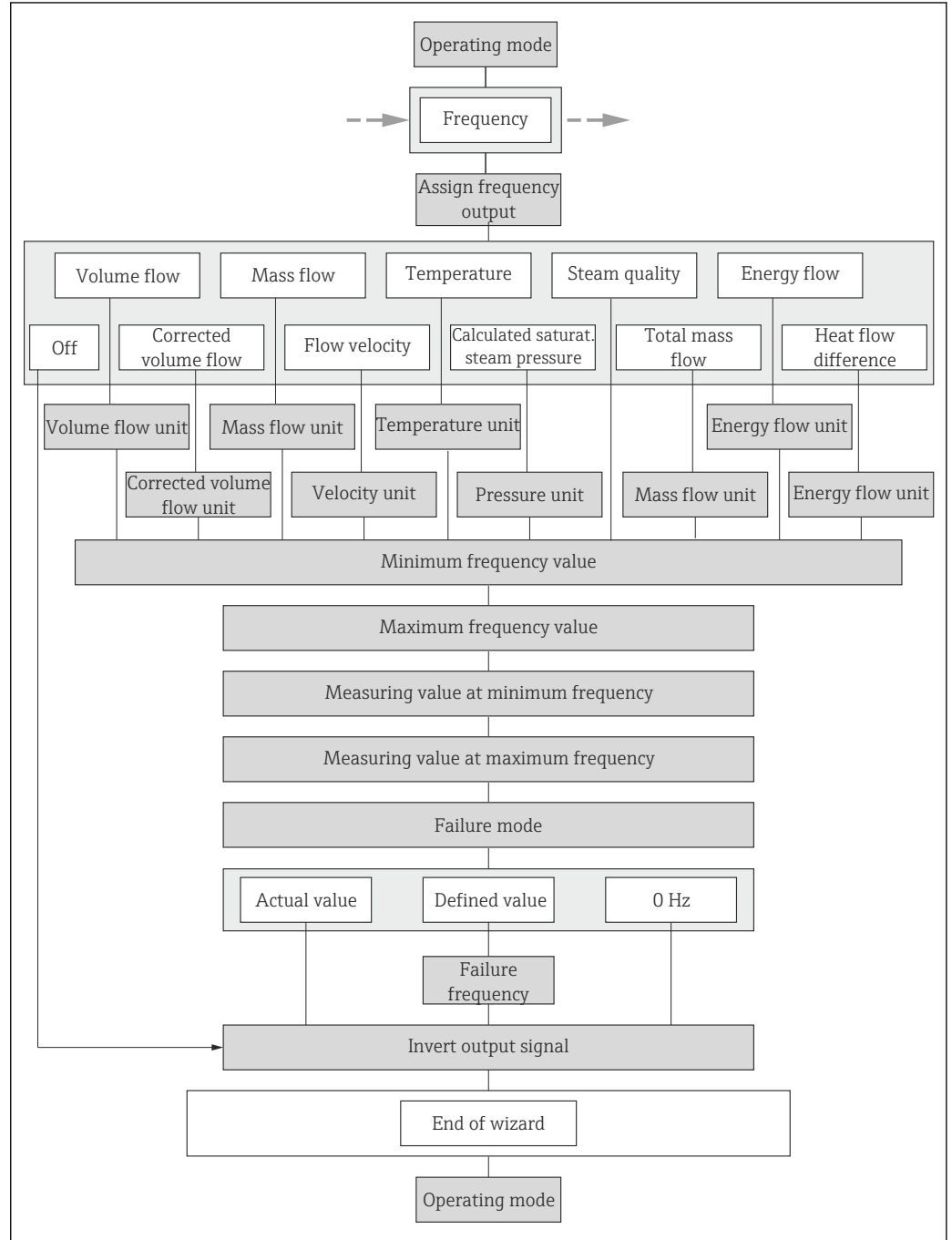



A0020789-EN

25 "Pulse/frequency/switch output" wizard in the "Setup" menu: "Operating mode" parameter "Frequency" option

## Parameter overview with brief description

Parameter	Prerequisite	Description	Selection / User entry	Factory setting
Operating mode	–	Define the output as a pulse, frequency or switch output.	<ul style="list-style-type: none"> <li>▪ Pulse</li> <li>▪ Frequency</li> <li>▪ Switch</li> </ul>	Pulse
Assign frequency output	The <b>Frequency</b> option is selected in the <b>Operating mode</b> parameter (→  79).	Select process variable for frequency output.	<ul style="list-style-type: none"> <li>▪ Off</li> <li>▪ Volume flow</li> <li>▪ Corrected volume flow</li> <li>▪ Mass flow</li> <li>▪ Flow velocity</li> <li>▪ Temperature</li> <li>▪ Calculated saturated steam pressure<sup>*</sup></li> <li>▪ Steam quality<sup>*</sup></li> <li>▪ Total mass flow<sup>*</sup></li> <li>▪ Energy flow<sup>*</sup></li> <li>▪ Heat flow difference<sup>*</sup></li> </ul>	Off
Mass flow unit	–	Select mass flow unit. <i>Effect</i> The selected unit applies for: <ul style="list-style-type: none"> <li>▪ Output</li> <li>▪ Low flow cut off</li> <li>▪ Simulation process variable</li> </ul>	Unit choose list	Country-specific: <ul style="list-style-type: none"> <li>▪ kg/h</li> <li>▪ lb/min</li> </ul>
Volume flow unit	–	Select volume flow unit. <i>Effect</i> The selected unit applies for: <ul style="list-style-type: none"> <li>▪ Output</li> <li>▪ Low flow cut off</li> <li>▪ Simulation process variable</li> </ul>	Unit choose list	Country-specific: <ul style="list-style-type: none"> <li>▪ m<sup>3</sup>/h</li> <li>▪ ft<sup>3</sup>/min</li> </ul>
Corrected volume flow unit	–	Select corrected volume flow unit. <i>Effect</i> The selected unit applies for: Corrected volume flow	Unit choose list	Country-specific: <ul style="list-style-type: none"> <li>▪ Nm<sup>3</sup>/h</li> <li>▪ Sft<sup>3</sup>/h</li> </ul>
Energy flow unit	For the following order code: "Sensor version", option "Mass flow"	Select energy flow unit. <i>Result</i> The selected unit applies for: <ul style="list-style-type: none"> <li>▪ Outputs</li> <li>▪ Low flow cut off</li> </ul>	Unit choose list	Country-specific: <ul style="list-style-type: none"> <li>▪ kW</li> <li>▪ Btu/h</li> </ul>
Pressure unit	For the following order code: "Sensor version", option "Mass flow"	Select process pressure unit. <i>Effect</i> The unit is taken from the: <ul style="list-style-type: none"> <li>▪ Calculated saturated steam pressure</li> <li>▪ Atmospheric pressure</li> <li>▪ Maximum value</li> <li>▪ Fixed process pressure</li> <li>▪ Pressure</li> <li>▪ Reference pressure</li> </ul>	Unit choose list	Country-specific: <ul style="list-style-type: none"> <li>▪ bar</li> <li>▪ psi</li> </ul>
Velocity unit	–	Select velocity unit. <i>Result</i> The selected unit applies for: <ul style="list-style-type: none"> <li>▪ Flow velocity</li> <li>▪ Maximum value</li> </ul>	Unit choose list	Country-specific: <ul style="list-style-type: none"> <li>▪ m/s</li> <li>▪ ft/s</li> </ul>

Parameter	Prerequisite	Description	Selection / User entry	Factory setting
Temperature unit	–	Select temperature unit. <i>Effect</i> The selected unit applies for: <ul style="list-style-type: none"> <li>▪ Temperature</li> <li>▪ Maximum value</li> <li>▪ Minimum value</li> <li>▪ Average value</li> <li>▪ Maximum value</li> <li>▪ Minimum value</li> <li>▪ Maximum value</li> <li>▪ Minimum value</li> <li>▪ 2nd temperature delta heat</li> <li>▪ Fixed temperature</li> <li>▪ Reference combustion temperature</li> <li>▪ Reference temperature</li> <li>▪ Saturation temperature</li> </ul>	Unit choose list	Country-specific: <ul style="list-style-type: none"> <li>▪ °C</li> <li>▪ °F</li> </ul>
Minimum frequency value	The <b>Frequency</b> option is selected in the <b>Operating mode</b> parameter, and one of the following options is selected in the <b>Assign frequency output</b> parameter (→  82): <ul style="list-style-type: none"> <li>▪ Volume flow</li> <li>▪ Corrected volume flow</li> <li>▪ Mass flow</li> <li>▪ Flow velocity</li> <li>▪ Temperature</li> <li>▪ Calculated saturated steam pressure*</li> <li>▪ Steam quality*</li> <li>▪ Total mass flow*</li> <li>▪ Energy flow*</li> <li>▪ Heat flow difference*</li> </ul>	Enter minimum frequency.	0 to 1 000 Hz	0 Hz
Maximum frequency value	The <b>Frequency</b> option is selected in the <b>Operating mode</b> parameter, and one of the following options is selected in the <b>Assign frequency output</b> parameter (→  82): <ul style="list-style-type: none"> <li>▪ Volume flow</li> <li>▪ Corrected volume flow</li> <li>▪ Mass flow</li> <li>▪ Flow velocity</li> <li>▪ Temperature</li> <li>▪ Calculated saturated steam pressure*</li> <li>▪ Steam quality*</li> <li>▪ Total mass flow*</li> <li>▪ Energy flow*</li> <li>▪ Heat flow difference*</li> </ul>	Enter maximum frequency.	0 to 1 000 Hz	1 000 Hz

Parameter	Prerequisite	Description	Selection / User entry	Factory setting
Measuring value at minimum frequency	The <b>Frequency</b> option is selected in the <b>Operating mode</b> parameter, and one of the following options is selected in the <b>Assign frequency output</b> parameter (→ 82): <ul style="list-style-type: none"> <li>▪ Volume flow</li> <li>▪ Corrected volume flow</li> <li>▪ Mass flow</li> <li>▪ Flow velocity</li> <li>▪ Temperature</li> <li>▪ Calculated saturated steam pressure *</li> <li>▪ Steam quality *</li> <li>▪ Total mass flow *</li> <li>▪ Energy flow *</li> <li>▪ Heat flow difference *</li> </ul>	Enter measured value for minimum frequency.	Signed floating-point number	Depends on country and nominal diameter
Measuring value at maximum frequency	The <b>Frequency</b> option is selected in the <b>Operating mode</b> parameter, and one of the following options is selected in the <b>Assign frequency output</b> parameter (→ 82): <ul style="list-style-type: none"> <li>▪ Volume flow</li> <li>▪ Corrected volume flow</li> <li>▪ Mass flow</li> <li>▪ Flow velocity</li> <li>▪ Temperature</li> <li>▪ Calculated saturated steam pressure *</li> <li>▪ Steam quality *</li> <li>▪ Total mass flow *</li> <li>▪ Energy flow *</li> <li>▪ Heat flow difference *</li> </ul>	Enter measured value for maximum frequency.	Signed floating-point number	Depends on country and nominal diameter
Failure mode	The <b>Frequency</b> option is selected in the <b>Operating mode</b> parameter (→ 79), and one of the following options is selected in the <b>Assign frequency output</b> parameter (→ 82): <ul style="list-style-type: none"> <li>▪ Volume flow</li> <li>▪ Corrected volume flow</li> <li>▪ Mass flow</li> <li>▪ Flow velocity</li> <li>▪ Temperature</li> <li>▪ Calculated saturated steam pressure *</li> <li>▪ Steam quality *</li> <li>▪ Total mass flow *</li> <li>▪ Energy flow *</li> <li>▪ Heat flow difference *</li> </ul>	Define output behavior in alarm condition.	<ul style="list-style-type: none"> <li>▪ Actual value</li> <li>▪ Defined value</li> <li>▪ 0 Hz</li> </ul>	0 Hz

Parameter	Prerequisite	Description	Selection / User entry	Factory setting
Failure frequency	The <b>Frequency</b> option is selected in the <b>Operating mode</b> parameter (→ 79), and one of the following options is selected in the <b>Assign frequency output</b> parameter (→ 82): <ul style="list-style-type: none"> <li>▪ Volume flow</li> <li>▪ Corrected volume flow</li> <li>▪ Mass flow</li> <li>▪ Flow velocity</li> <li>▪ Temperature</li> <li>▪ Calculated saturated steam pressure *</li> <li>▪ Steam quality *</li> <li>▪ Total mass flow *</li> <li>▪ Energy flow *</li> <li>▪ Heat flow difference *</li> </ul>	Enter frequency output value in alarm condition.	0.0 to 1250.0 Hz	0.0 Hz
Invert output signal	–	Invert the output signal.	<ul style="list-style-type: none"> <li>▪ No</li> <li>▪ Yes</li> </ul>	No

\* Visibility depends on order options or device settings

### Configuring the switch output

#### Navigation

"Setup" menu → Pulse/frequency/switch output

#### Structure of the wizard for the switch output

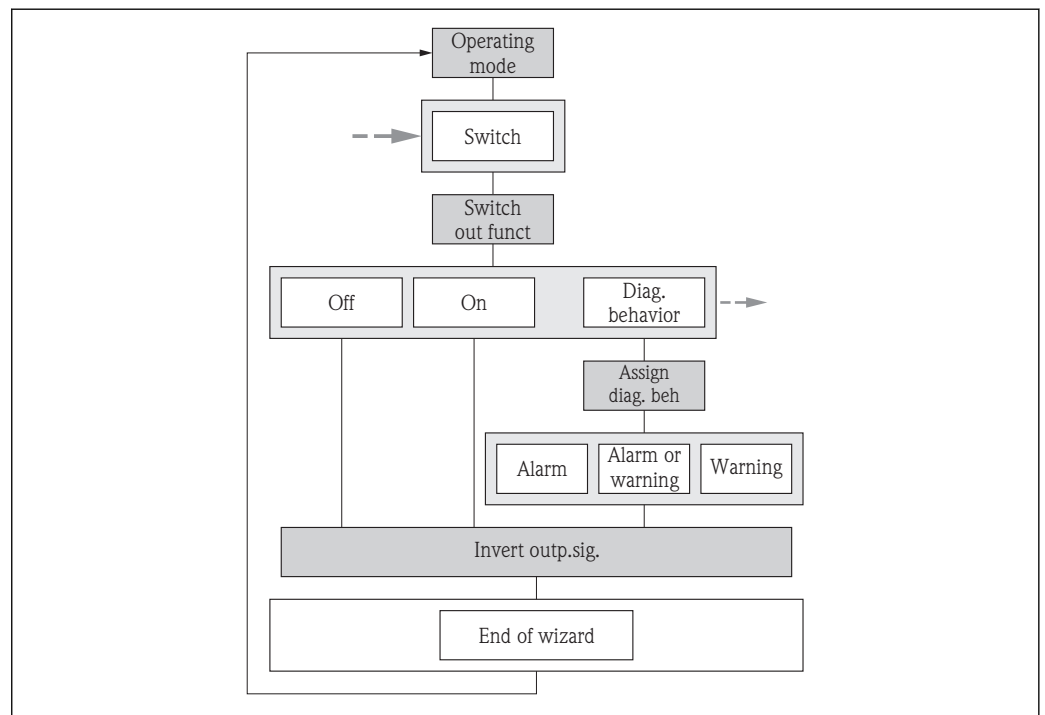

A0017439-EN

26 "Pulse/frequency/switch output" wizard in the "Setup" menu: "Operating mode" parameter "Switch" option (part 1)

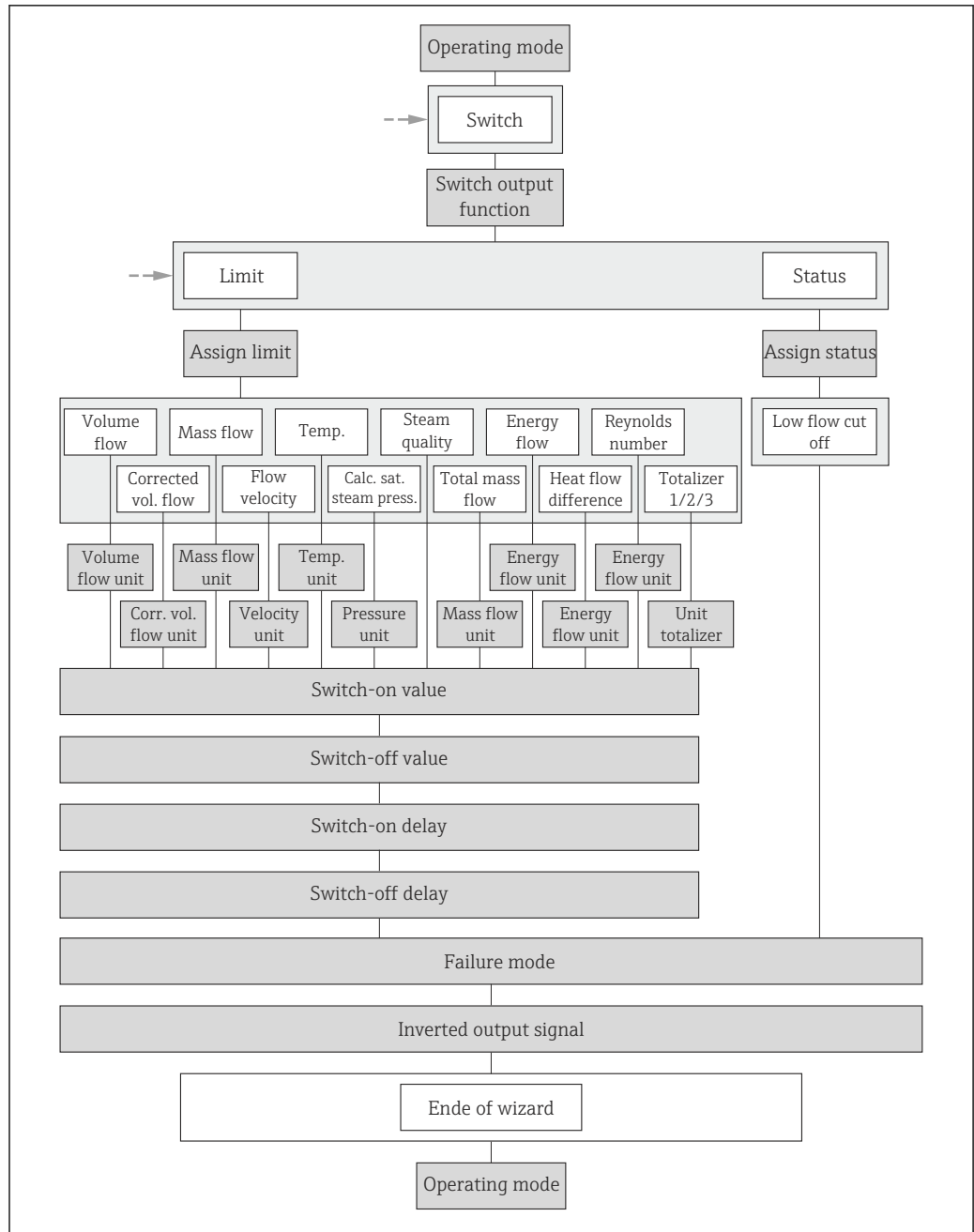

A0020794-EN

27 "Pulse/frequency/switch output" wizard in the "Setup" menu: "Operating mode" parameter "Switch" option (part 2)

**Parameter overview with brief description**

Parameter	Prerequisite	Description	Selection / User entry	Factory setting
Operating mode	-	Define the output as a pulse, frequency or switch output.	<ul style="list-style-type: none"> <li>▪ Pulse</li> <li>▪ Frequency</li> <li>▪ Switch</li> </ul>	Pulse
Switch output function	The <b>Switch</b> option is selected in the <b>Operating mode</b> parameter.	Select function for switch output.	<ul style="list-style-type: none"> <li>▪ Off</li> <li>▪ On</li> <li>▪ Diagnostic behavior</li> <li>▪ Limit</li> <li>▪ Status</li> </ul>	Off

Parameter	Prerequisite	Description	Selection / User entry	Factory setting
Assign diagnostic behavior	<ul style="list-style-type: none"> <li>The <b>Switch</b> option is selected in the <b>Operating mode</b> parameter.</li> <li>The <b>Diagnostic behavior</b> option is selected in the <b>Switch output function</b> parameter.</li> </ul>	Select diagnostic behavior for switch output.	<ul style="list-style-type: none"> <li>Alarm</li> <li>Alarm or warning</li> <li>Warning</li> </ul>	Alarm
Assign limit	<ul style="list-style-type: none"> <li>The <b>Switch</b> option is selected in the <b>Operating mode</b> parameter.</li> <li>The <b>Limit</b> option is selected in the <b>Switch output function</b> parameter.</li> </ul>	Select process variable for limit function.	<ul style="list-style-type: none"> <li>Volume flow</li> <li>Corrected volume flow</li> <li>Mass flow</li> <li>Flow velocity</li> <li>Temperature</li> <li>Calculated saturated steam pressure *</li> <li>Steam quality *</li> <li>Total mass flow *</li> <li>Energy flow *</li> <li>Heat flow difference *</li> <li>Reynolds number *</li> <li>Totalizer 1</li> <li>Totalizer 2</li> <li>Totalizer 3</li> </ul>	Volume flow
Assign flow direction check	<ul style="list-style-type: none"> <li>The <b>Switch</b> option is selected in the <b>Operating mode</b> parameter.</li> <li>The <b>Flow direction check</b> option is selected in the <b>Switch output function</b> parameter.</li> </ul>	Select process variable for flow direction monitoring.	<ul style="list-style-type: none"> <li>Off</li> <li>Volume flow</li> <li>Mass flow</li> <li>Corrected volume flow</li> </ul>	Volume flow
Assign status	<ul style="list-style-type: none"> <li>The <b>Switch</b> option is selected in the <b>Operating mode</b> parameter.</li> <li>The <b>Status</b> option is selected in the <b>Switch output function</b> parameter.</li> </ul>	Select device status for switch output.	Low flow cut off	Low flow cut off
Mass flow unit	–	Select mass flow unit. <i>Effect</i> The selected unit applies for: <ul style="list-style-type: none"> <li>Output</li> <li>Low flow cut off</li> <li>Simulation process variable</li> </ul>	Unit choose list	Country-specific: <ul style="list-style-type: none"> <li>kg/h</li> <li>lb/min</li> </ul>
Volume flow unit	–	Select volume flow unit. <i>Effect</i> The selected unit applies for: <ul style="list-style-type: none"> <li>Output</li> <li>Low flow cut off</li> <li>Simulation process variable</li> </ul>	Unit choose list	Country-specific: <ul style="list-style-type: none"> <li>m<sup>3</sup>/h</li> <li>ft<sup>3</sup>/min</li> </ul>
Corrected volume flow unit	–	Select corrected volume flow unit. <i>Effect</i> The selected unit applies for: Corrected volume flow	Unit choose list	Country-specific: <ul style="list-style-type: none"> <li>Nm<sup>3</sup>/h</li> <li>Sft<sup>3</sup>/h</li> </ul>
Energy flow unit	For the following order code: "Sensor version", option "Mass flow"	Select energy flow unit. <i>Result</i> The selected unit applies for: <ul style="list-style-type: none"> <li>Outputs</li> <li>Low flow cut off</li> </ul>	Unit choose list	Country-specific: <ul style="list-style-type: none"> <li>kW</li> <li>Btu/h</li> </ul>

Parameter	Prerequisite	Description	Selection / User entry	Factory setting
Pressure unit	For the following order code: "Sensor version", option "Mass flow"	Select process pressure unit. <i>Effect</i> The unit is taken from the: <ul style="list-style-type: none"> <li>▪ Calculated saturated steam pressure</li> <li>▪ Atmospheric pressure</li> <li>▪ Maximum value</li> <li>▪ Fixed process pressure</li> <li>▪ Pressure</li> <li>▪ Reference pressure</li> </ul>	Unit choose list	Country-specific: <ul style="list-style-type: none"> <li>▪ bar</li> <li>▪ psi</li> </ul>
Velocity unit	–	Select velocity unit. <i>Result</i> The selected unit applies for: <ul style="list-style-type: none"> <li>▪ Flow velocity</li> <li>▪ Maximum value</li> </ul>	Unit choose list	Country-specific: <ul style="list-style-type: none"> <li>▪ m/s</li> <li>▪ ft/s</li> </ul>
Unit totalizer	One of the following options is selected in the <b>Assign process variable</b> parameter (→ 116) of the <b>Totalizer 1 to 3</b> submenu: <ul style="list-style-type: none"> <li>▪ Volume flow</li> <li>▪ Corrected volume flow</li> <li>▪ Mass flow</li> <li>▪ Total mass flow *</li> <li>▪ Condensate mass flow *</li> <li>▪ Energy flow *</li> <li>▪ Heat flow difference *</li> </ul>	Select process variable totalizer unit.	Unit choose list	Country-specific: <ul style="list-style-type: none"> <li>▪ m<sup>3</sup></li> <li>▪ ft<sup>3</sup></li> </ul>
Temperature unit	–	Select temperature unit. <i>Effect</i> The selected unit applies for: <ul style="list-style-type: none"> <li>▪ Temperature</li> <li>▪ Maximum value</li> <li>▪ Minimum value</li> <li>▪ Average value</li> <li>▪ Maximum value</li> <li>▪ Minimum value</li> <li>▪ Maximum value</li> <li>▪ Minimum value</li> <li>▪ 2nd temperature delta heat</li> <li>▪ Fixed temperature</li> <li>▪ Reference combustion temperature</li> <li>▪ Reference temperature</li> <li>▪ Saturation temperature</li> </ul>	Unit choose list	Country-specific: <ul style="list-style-type: none"> <li>▪ °C</li> <li>▪ °F</li> </ul>
Switch-on value	<ul style="list-style-type: none"> <li>▪ The <b>Switch</b> option is selected in the <b>Operating mode</b> parameter.</li> <li>▪ The <b>Limit</b> option is selected in the <b>Switch output function</b> parameter.</li> </ul>	Enter measured value for the switch-on point.	Signed floating-point number	Country-specific: <ul style="list-style-type: none"> <li>▪ 0 m<sup>3</sup>/h</li> <li>▪ 0 ft<sup>3</sup>/h</li> </ul>
Switch-off value	<ul style="list-style-type: none"> <li>▪ The <b>Switch</b> option is selected in the <b>Operating mode</b> parameter.</li> <li>▪ The <b>Limit</b> option is selected in the <b>Switch output function</b> parameter.</li> </ul>	Enter measured value for the switch-off point.	Signed floating-point number	Country-specific: <ul style="list-style-type: none"> <li>▪ 0 m<sup>3</sup>/h</li> <li>▪ 0 ft<sup>3</sup>/h</li> </ul>
Switch-on delay	<ul style="list-style-type: none"> <li>▪ The <b>Switch</b> option is selected in the <b>Operating mode</b> parameter.</li> <li>▪ The <b>Limit</b> option is selected in the <b>Switch output function</b> parameter.</li> </ul>	Define delay for the switch-on of status output.	0.0 to 100.0 s	0.0 s



Parameter	Prerequisite	Description	Selection / User entry	Factory setting
Switch-off delay	<ul style="list-style-type: none"> <li>▪ The <b>Switch</b> option is selected in the <b>Operating mode</b> parameter.</li> <li>▪ The <b>Limit</b> option is selected in the <b>Switch output function</b> parameter.</li> </ul>	Define delay for the switch-off of status output.	0.0 to 100.0 s	0.0 s
Failure mode	–	Define output behavior in alarm condition.	<ul style="list-style-type: none"> <li>▪ Actual status</li> <li>▪ Open</li> <li>▪ Closed</li> </ul>	Open
Invert output signal	–	Invert the output signal.	<ul style="list-style-type: none"> <li>▪ No</li> <li>▪ Yes</li> </ul>	No

\* Visibility depends on order options or device settings

### 10.4.6 Configuring the local display

The **Display** wizard guides you systematically through all the parameters that can be configured for configuring the local display.

**Navigation**

"Setup" menu → Display

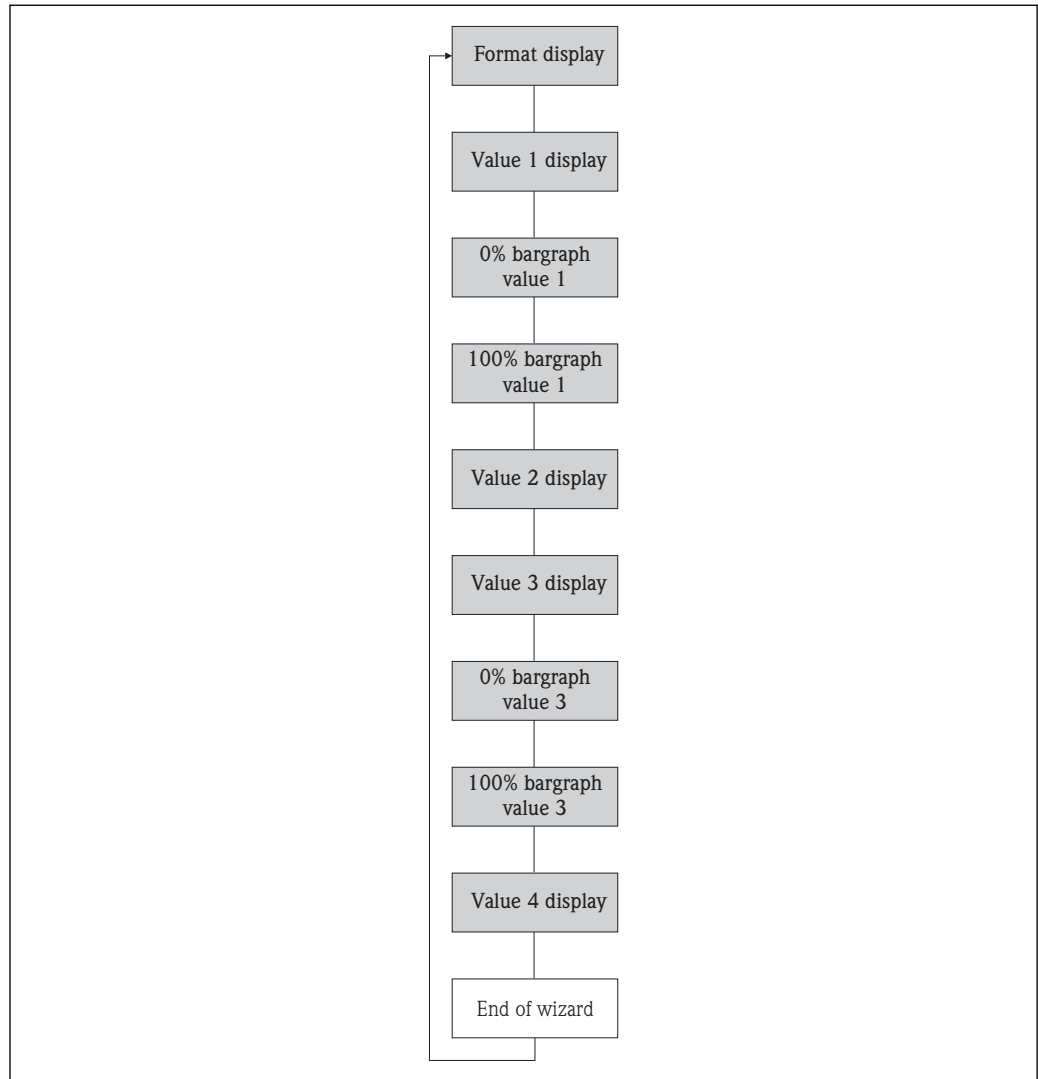
**Structure of the wizard**

28 "Display" wizard in the "Setup" menu

A0013797-EN

## Parameter overview with brief description

Parameter	Prerequisite	Description	Selection / User entry	Factory setting
Format display	A local display is provided.	Select how measured values are shown on the display.	<ul style="list-style-type: none"> <li>■ 1 value, max. size</li> <li>■ 1 bargraph + 1 value</li> <li>■ 2 values</li> <li>■ 1 value large + 2 values</li> <li>■ 4 values</li> </ul>	1 value, max. size
Value 1 display	A local display is provided.	Select the measured value that is shown on the local display.	<ul style="list-style-type: none"> <li>■ Volume flow</li> <li>■ Corrected volume flow</li> <li>■ Mass flow</li> <li>■ Flow velocity</li> <li>■ Temperature</li> <li>■ Calculated saturated steam pressure *</li> <li>■ Steam quality *</li> <li>■ Total mass flow *</li> <li>■ Condensate mass flow *</li> <li>■ Energy flow *</li> <li>■ Heat flow difference *</li> <li>■ Reynolds number *</li> <li>■ Density *</li> <li>■ Pressure *</li> <li>■ Specific volume *</li> <li>■ Degrees of superheat *</li> <li>■ Totalizer 1</li> <li>■ Totalizer 2</li> <li>■ Totalizer 3</li> <li>■ Current output 1</li> <li>■ Current output 2 *</li> </ul>	Volume flow
0% bargraph value 1	A local display is provided.	Enter 0% value for bar graph display.	Signed floating-point number	Country-specific: <ul style="list-style-type: none"> <li>■ 0 m<sup>3</sup>/h</li> <li>■ 0 ft<sup>3</sup>/h</li> </ul>
100% bargraph value 1	A local display is provided.	Enter 100% value for bar graph display.	Signed floating-point number	Depends on country and nominal diameter
Value 2 display	A local display is provided.	Select the measured value that is shown on the local display.	Picklist, see <b>Value 1 display</b> parameter	None
Value 3 display	A local display is provided.	Select the measured value that is shown on the local display.	Picklist, see <b>Value 1 display</b> parameter	None
0% bargraph value 3	A selection has been made in the <b>Value 3 display</b> parameter.	Enter 0% value for bar graph display.	Signed floating-point number	Country-specific: <ul style="list-style-type: none"> <li>■ 0 m<sup>3</sup>/h</li> <li>■ 0 ft<sup>3</sup>/h</li> </ul>
100% bargraph value 3	An option has been selected in the <b>Value 3 display</b> parameter.	Enter 100% value for bar graph display.	Signed floating-point number	0
Value 4 display	A local display is provided.	Select the measured value that is shown on the local display.	Picklist, see <b>Value 1 display</b> parameter	None

\* Visibility depends on order options or device settings

### 10.4.7 Configuring the output conditioning

The **Output conditioning** wizard guides you systematically through all the parameters that have to be set for configuring the output conditioning.

**Navigation**

"Setup" menu → Output conditioning

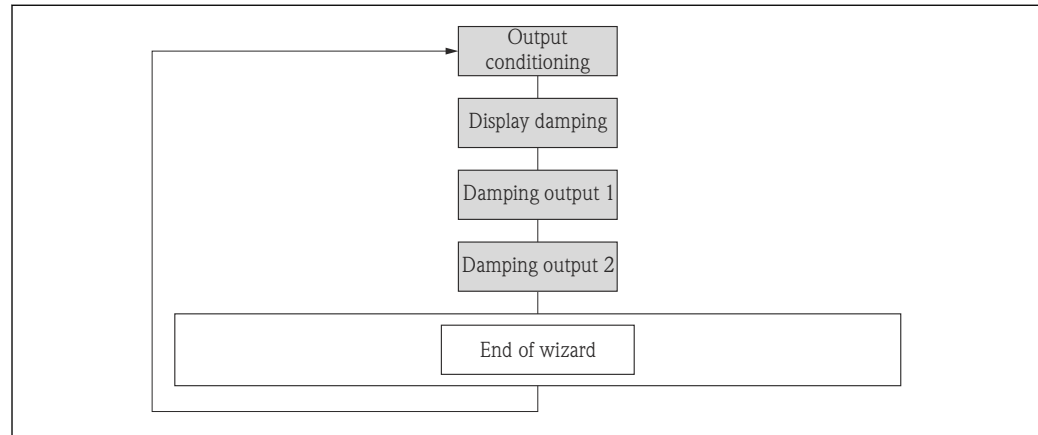
**Structure of the "Output conditioning" wizard**

A0020796-EN

29 "Output conditioning" wizard in the "Setup" menu

**Parameter overview with brief description**

Parameter	Prerequisite	Description	User entry	Factory setting
Display damping	–	Set display reaction time to fluctuations in the measured value.	0.0 to 999.9 s	5.0 s
Damping output 1	–	Set the reaction time of the output signal of the current output to fluctuations in the measured value.	0 to 999.9 s	1 s
Damping output 2	The measuring device has a second current output.	Set the reaction time of the output signal of the second current output to fluctuations in the measured value.	0 to 999.9 s	1 s
Damping output 2	The measuring device has a pulse/frequency/switch output.	Set the reaction time of the output signal of the frequency output to fluctuations in the measured value.	0 to 999.9 s	1 s

**10.4.8 Configuring the low flow cut off**

The **Low flow cut off** wizard guides you systematically through all the parameters that have to be set for configuring the low flow cut off.

**Navigation**

"Setup" menu → Low flow cut off

**Structure of the wizard**

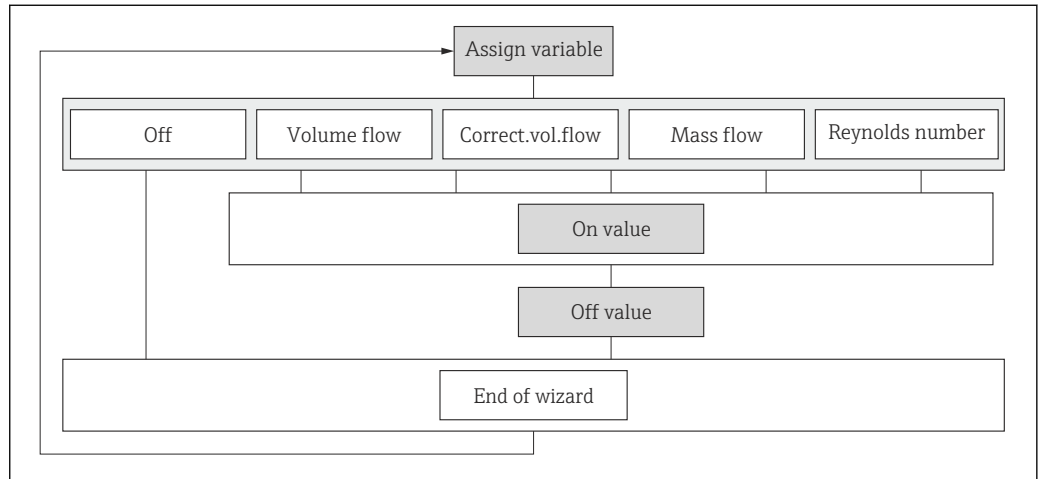

30 "Low flow cut off" wizard in the "Setup" menu

A0020775-EN

**Parameter overview with brief description**

Parameter	Prerequisite	Description	Selection / User entry	Factory setting
Assign process variable	–	Select process variable for low flow cut off.	<ul style="list-style-type: none"> <li>■ Off</li> <li>■ Volume flow</li> <li>■ Corrected volume flow</li> <li>■ Mass flow</li> <li>■ Reynolds number *</li> </ul>	Off
On value low flow cutoff	One of the following options is selected in the <b>Assign process variable</b> parameter (→ 93): <ul style="list-style-type: none"> <li>■ Volume flow</li> <li>■ Corrected volume flow</li> <li>■ Mass flow</li> <li>■ Reynolds number *</li> </ul>	Enter on value for low flow cut off.	Positive floating-point number	0
Off value low flow cutoff	One of the following options is selected in the <b>Assign process variable</b> parameter (→ 93): <ul style="list-style-type: none"> <li>■ Volume flow</li> <li>■ Corrected volume flow</li> <li>■ Mass flow</li> <li>■ Reynolds number *</li> </ul>	Enter off value for low flow cut off.	0 to 100.0 %	50 %

\* Visibility depends on order options or device settings

## 10.5 Advanced settings

The **Advanced setup** submenu together with its submenus contains parameters for specific settings.

*Navigation to the "Advanced setup" submenu*

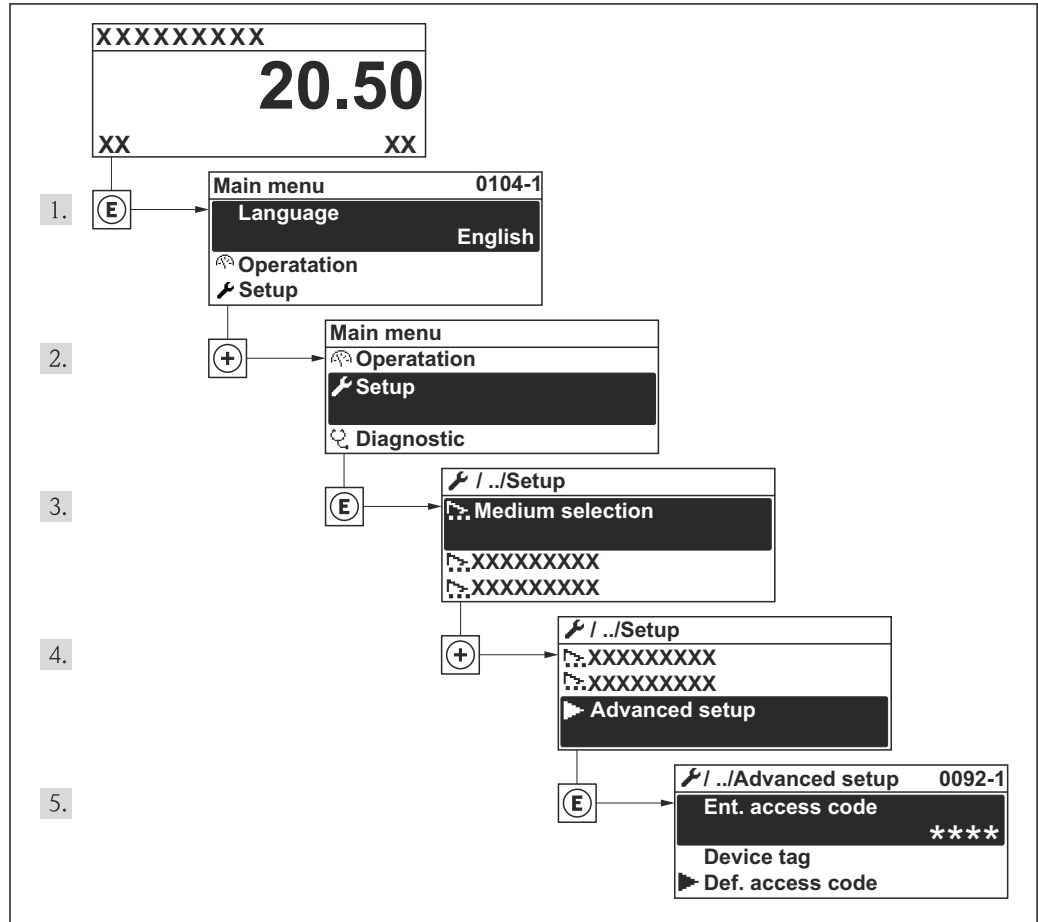

A0014009-EN

31 Taking the example of the local display

**i** The number of submenus can vary depending on the device version. Some submenus are not dealt with in the Operating Instructions. These submenus and the parameters they contain are explained in the Special Documentation for the device.

### Navigation

"Setup" menu → Advanced setup

▶ Advanced setup	
Enter access code	
▶ System units	→ 95
▶ Medium properties	→ 98
▶ External compensation	→ 112

▶ Sensor adjustment	→ 114
▶ Totalizer 1 to 3	→ 115
▶ SIL confirmation	
▶ Deactivate SIL	
▶ Display	→ 117
▶ Heartbeat setup	
▶ Configuration backup display	→ 119
▶ Administration	→ 149

### 10.5.1 Setting the system units

In the **System units** submenu the units of all the measured values can be set.

#### Navigation

"Setup" menu → Advanced setup → System units

▶ System units

Volume flow unit

Volume unit

Mass flow unit

Mass unit

Corrected volume flow unit

Corrected volume unit

Pressure unit

Temperature unit

Energy flow unit

Energy unit

Calorific value unit

Calorific value unit

Velocity unit
Density unit
Dynamic viscosity unit
Length unit

### Parameter overview with brief description

Parameter	Prerequisite	Description	Selection	Factory setting
Volume flow unit	–	Select volume flow unit. <i>Effect</i> The selected unit applies for: <ul style="list-style-type: none"> <li>▪ Output</li> <li>▪ Low flow cut off</li> <li>▪ Simulation process variable</li> </ul>	Unit choose list	Country-specific: <ul style="list-style-type: none"> <li>▪ m<sup>3</sup>/h</li> <li>▪ ft<sup>3</sup>/min</li> </ul>
Volume unit	–	Select volume unit.	Unit choose list	Country-specific: <ul style="list-style-type: none"> <li>▪ m<sup>3</sup></li> <li>▪ ft<sup>3</sup></li> </ul>
Mass flow unit	–	Select mass flow unit. <i>Effect</i> The selected unit applies for: <ul style="list-style-type: none"> <li>▪ Output</li> <li>▪ Low flow cut off</li> <li>▪ Simulation process variable</li> </ul>	Unit choose list	Country-specific: <ul style="list-style-type: none"> <li>▪ kg/h</li> <li>▪ lb/min</li> </ul>
Mass unit	–	Select mass unit.	Unit choose list	Country-specific: <ul style="list-style-type: none"> <li>▪ kg</li> <li>▪ lb</li> </ul>
Corrected volume flow unit	–	Select corrected volume flow unit. <i>Effect</i> The selected unit applies for: Corrected volume flow	Unit choose list	Country-specific: <ul style="list-style-type: none"> <li>▪ Nm<sup>3</sup>/h</li> <li>▪ Sft<sup>3</sup>/h</li> </ul>
Corrected volume unit	–	Select corrected volume unit.	Unit choose list	Country-specific: <ul style="list-style-type: none"> <li>▪ Nm<sup>3</sup></li> <li>▪ Sft<sup>3</sup></li> </ul>
Pressure unit	For the following order code: "Sensor version", option "Mass flow"	Select process pressure unit. <i>Effect</i> The unit is taken from the: <ul style="list-style-type: none"> <li>▪ Calculated saturated steam pressure</li> <li>▪ Atmospheric pressure</li> <li>▪ Maximum value</li> <li>▪ Fixed process pressure</li> <li>▪ Pressure</li> <li>▪ Reference pressure</li> </ul>	Unit choose list	Country-specific: <ul style="list-style-type: none"> <li>▪ bar</li> <li>▪ psi</li> </ul>



Parameter	Prerequisite	Description	Selection	Factory setting
Temperature unit	–	Select temperature unit. <i>Effect</i> The selected unit applies for: <ul style="list-style-type: none"> <li>▪ Temperature</li> <li>▪ Maximum value</li> <li>▪ Minimum value</li> <li>▪ Average value</li> <li>▪ Maximum value</li> <li>▪ Minimum value</li> <li>▪ Maximum value</li> <li>▪ Minimum value</li> <li>▪ 2nd temperature delta heat</li> <li>▪ Fixed temperature</li> <li>▪ Reference combustion temperature</li> <li>▪ Reference temperature</li> <li>▪ Saturation temperature</li> </ul>	Unit choose list	Country-specific: <ul style="list-style-type: none"> <li>▪ °C</li> <li>▪ °F</li> </ul>
Energy flow unit	For the following order code: "Sensor version", option "Mass flow"	Select energy flow unit. <i>Result</i> The selected unit applies for: <ul style="list-style-type: none"> <li>▪ Outputs</li> <li>▪ Low flow cut off</li> </ul>	Unit choose list	Country-specific: <ul style="list-style-type: none"> <li>▪ kW</li> <li>▪ Btu/h</li> </ul>
Energy unit	For the following order code: "Sensor version", option "Mass flow"	Select energy unit.	Unit choose list	Country-specific: <ul style="list-style-type: none"> <li>▪ kWh</li> <li>▪ Btu</li> </ul>
Calorific value unit	The following conditions are met: <ul style="list-style-type: none"> <li>▪ Order code for "Sensor version", option "Mass flow"</li> <li>▪ The <b>Gross calorific value volume</b> option or the <b>Net calorific value volume</b> option is selected in the <b>Calorific value type</b> parameter.</li> </ul>	Select calorific value unit. <i>Result</i> The selected unit applies for: Reference gross calorific value	Unit choose list	Country-specific: <ul style="list-style-type: none"> <li>▪ kJ/Nm<sup>3</sup></li> <li>▪ Btu/Sft<sup>3</sup></li> </ul>
Calorific value unit (Mass)	The following conditions are met: <ul style="list-style-type: none"> <li>▪ Order code for "Sensor version", option "Mass flow"</li> <li>▪ The <b>Gross calorific value mass</b> option or the <b>Net calorific value mass</b> option is selected in the <b>Calorific value type</b> parameter.</li> </ul>	Select calorific value unit.	Unit choose list	Country-specific: <ul style="list-style-type: none"> <li>▪ kJ/kg</li> <li>▪ Btu/lb</li> </ul>
Velocity unit	–	Select velocity unit. <i>Result</i> The selected unit applies for: <ul style="list-style-type: none"> <li>▪ Flow velocity</li> <li>▪ Maximum value</li> </ul>	Unit choose list	Country-specific: <ul style="list-style-type: none"> <li>▪ m/s</li> <li>▪ ft/s</li> </ul>
Density unit	–	Select density unit. <i>Effect</i> The selected unit applies for: <ul style="list-style-type: none"> <li>▪ Output</li> <li>▪ Simulation process variable</li> </ul>	Unit choose list	Country-specific: <ul style="list-style-type: none"> <li>▪ kg/m<sup>3</sup></li> <li>▪ lb/ft<sup>3</sup></li> </ul>
Specific volume unit	For the following order code: "Sensor version", option "Mass flow"	Select the unit for the specific volume. <i>Result</i> The selected unit applies for: Specific volume	Unit choose list	Country-specific: <ul style="list-style-type: none"> <li>▪ m<sup>3</sup>/kg</li> <li>▪ ft<sup>3</sup>/lb</li> </ul>

Parameter	Prerequisite	Description	Selection	Factory setting
Dynamic viscosity unit	–	Select dynamic viscosity unit. <i>Result</i> The selected unit applies for: <ul style="list-style-type: none"> <li>▪ <b>Dynamic viscosity</b> parameter (gases)</li> <li>▪ <b>Dynamic viscosity</b> parameter (liquids)</li> </ul>	Unit choose list	Pa s
Length unit	–	Select length unit for nominal diameter. <i>Effect</i> The selected unit applies for: <ul style="list-style-type: none"> <li>▪ Inlet run</li> <li>▪ Mating pipe diameter</li> </ul>	Unit choose list	Country-specific: <ul style="list-style-type: none"> <li>▪ mm</li> <li>▪ in</li> </ul>

### 10.5.2 Setting the medium properties

In the **Medium properties** submenu the reference values for the measuring application can be set.

#### Navigation

"Setup" menu → Advanced setup → Medium properties

▶ Medium properties

Dynamic viscosity
Dynamic viscosity
► Gas composition

### Parameter overview with brief description

Parameter	Prerequisite	Description	Selection / User entry	Factory setting
Enthalpy type	The following conditions are met: <ul style="list-style-type: none"> <li>In the <b>Select gas type</b> parameter, the <b>User-specific gas</b> option is selected.</li> <li>Or</li> <li>In the <b>Select liquid type</b> parameter, the <b>User-specific liquid</b> option is selected.</li> </ul>	Define which kind of enthalpy is used.	<ul style="list-style-type: none"> <li>Heat</li> <li>Calorific value</li> </ul>	Heat
Calorific value type	The <b>Calorific value type</b> parameter is visible.	Select calculation based on gross calorific value or net calorific value.	<ul style="list-style-type: none"> <li>Gross calorific value volume</li> <li>Net calorific value volume</li> <li>Gross calorific value mass</li> <li>Net calorific value mass</li> </ul>	Gross calorific value mass
Reference combustion temperature	The <b>Reference combustion temperature</b> parameter is visible.	Enter reference combustion temperature to calculate the natural gas energy value.  <i>Dependency</i> The unit is taken from the <b>Temperature unit</b> parameter	-200 to 450 °C	20 °C
Reference density	The following conditions are met: <ul style="list-style-type: none"> <li>In the <b>Select gas type</b> parameter, the <b>User-specific gas</b> option is selected.</li> <li>Or</li> <li>In the <b>Select liquid type</b> parameter, the <b>Water</b> option or <b>User-specific liquid</b> option is selected.</li> </ul>	Enter fixed value for reference density.  <i>Dependency</i> The unit is taken from the <b>Density unit</b> parameter	0.01 to 15 000 kg/m <sup>3</sup>	1 000 kg/m <sup>3</sup>
Reference gross calorific value	The following conditions are met: <ul style="list-style-type: none"> <li>In the <b>Select medium</b> parameter, the <b>Gas</b> option is selected.</li> <li>In the <b>Select gas type</b> parameter, the <b>Natural gas</b> option is selected.</li> <li>In the <b>Density calculation</b> parameter, the <b>ISO 12213-3</b> option is selected.</li> </ul>	Enter reference gross calorific value of the natural gas.  <i>Dependency</i> The unit is taken from the <b>Calorific value unit</b> parameter	Positive floating-point number	50 000 kJ/Nm <sup>3</sup>

Parameter	Prerequisite	Description	Selection / User entry	Factory setting
Reference pressure	The following conditions are met: <ul style="list-style-type: none"> <li>Order code for "Sensor version", option "Mass flow (integrated temperature measurement)"</li> <li>The <b>Gas</b> option is selected in the <b>Select medium</b> parameter.</li> </ul>	Enter reference pressure for the calculation of the reference density. <i>Dependency</i> The unit is taken from the <b>Pressure unit</b> parameter	0 to 250 bar	1.01325 bar
Reference temperature	The following conditions are met: <ul style="list-style-type: none"> <li>The <b>Gas</b> option is selected in the <b>Select medium</b> parameter.</li> <li>Or</li> <li>The <b>Liquid</b> option is selected in the <b>Select medium</b> parameter.</li> </ul>	Enter reference temperature for calculating the reference density. <i>Dependency</i> The unit is taken from the <b>Temperature unit</b> parameter	-200 to 450 °C	20 °C
Reference Z-factor	In the <b>Select gas type</b> parameter, the <b>User-specific gas</b> option is selected.	Enter real gas constant Z for gas under reference conditions.	0.1 to 2	1
Linear expansion coefficient	The following conditions are met: <ul style="list-style-type: none"> <li>The <b>Liquid</b> option is selected in the <b>Select medium</b> parameter.</li> <li>The <b>User-specific liquid</b> option is selected in the <b>Select liquid type</b> parameter.</li> </ul>	Enter linear, medium-specific expansion coefficient for calculating the reference density.	$1.0^{-6}$ to $2.0^{-3}$	$2.06^{-4}$
Relative density	The following conditions are met: <ul style="list-style-type: none"> <li>In the <b>Select medium</b> parameter, the <b>Gas</b> option is selected.</li> <li>In the <b>Select gas type</b> parameter, the <b>Natural gas</b> option is selected.</li> <li>In the <b>Density calculation</b> parameter, the <b>ISO 12213-3</b> option is selected.</li> </ul>	Enter a relative density of the natural gas.	0.55 to 0.9	0.664
Specific heat capacity	The following conditions are met: <ul style="list-style-type: none"> <li>Selected medium: <ul style="list-style-type: none"> <li>In the <b>Select gas type</b> parameter, the <b>User-specific gas</b> option is selected.</li> <li>Or</li> <li>In the <b>Select liquid type</b> parameter, the <b>User-specific liquid</b> option is selected.</li> </ul> </li> <li>In the <b>Enthalpy type</b> parameter, the <b>Heat</b> option is selected.</li> </ul>	Enter the specific heat capacity of the medium. <i>Dependency</i> The unit is taken from the <b>Specific heat capacity unit</b> parameter	0 to 50 kJ/(kgK)	4.187 kJ/(kgK)

Parameter	Prerequisite	Description	Selection / User entry	Factory setting
Calorific value	The following conditions are met: <ul style="list-style-type: none"> <li>▪ Selected medium: <ul style="list-style-type: none"> <li>– In the <b>Select gas type</b> parameter, the <b>User-specific gas</b> option is selected.</li> <li>Or</li> <li>– In the <b>Select liquid type</b> parameter, the <b>User-specific liquid</b> option is selected.</li> </ul> </li> <li>▪ In the <b>Enthalpy type</b> parameter, the <b>Calorific value</b> option is selected.</li> <li>▪ In the <b>Calorific value type</b> parameter, the <b>Gross calorific value volume</b> option or <b>Gross calorific value mass</b> option is selected.</li> </ul>	Enter gross calorific value to calculate the energy flow.	Positive floating-point number	50 000 kJ/kg
Z-factor	In the <b>Select gas type</b> parameter, the <b>User-specific gas</b> option is selected.	Enter real gas constant Z for gas under operation conditions.	0.1 to 2.0	1
Dynamic viscosity (Gases)	The following conditions are met: <ul style="list-style-type: none"> <li>▪ Order code for "Sensor version", option "Volume flow"</li> <li>▪ The <b>Gas</b> option or the <b>Steam</b> option is selected in the <b>Select medium</b> parameter.</li> <li>Or</li> <li>▪ The <b>User-specific gas</b> option is selected in the <b>Select gas type</b> parameter.</li> </ul>	Enter fixed value for dynamic viscosity for a gas/steam. <i>Dependency</i> The unit is taken from the <b>Dynamic viscosity unit</b> parameter.	Positive floating-point number	0.015 cP
Dynamic viscosity (Liquids)	The following conditions are met: <ul style="list-style-type: none"> <li>▪ Order code for "Sensor version", option "Volume flow"</li> <li>▪ The <b>Liquid</b> option is selected in the <b>Select medium</b> parameter.</li> <li>Or</li> <li>▪ The <b>User-specific liquid</b> option is selected in the <b>Select liquid type</b> parameter.</li> </ul>	Enter fixed value for dynamic viscosity for a liquid. <i>Dependency</i> The unit is taken from the <b>Dynamic viscosity unit</b> parameter.	Positive floating-point number	1 cP

### Configuring the gas composition

In the **Gas composition** submenu the gas composition for the measuring application can be set.

**Navigation**

"Setup" menu → Advanced setup → Medium properties → Gas composition

► Gas composition
Gas type
Gas mixture
Mol% Ar
Mol% C <sub>2</sub> H <sub>3</sub> Cl
Mol% C <sub>2</sub> H <sub>4</sub>
Mol% C <sub>2</sub> H <sub>6</sub>
Mol% C <sub>3</sub> H <sub>8</sub>
Mol% CH <sub>4</sub>
Mol% Cl <sub>2</sub>
Mol% CO
Mol% CO <sub>2</sub>
Mol% H <sub>2</sub>
Mol% H <sub>2</sub> O
Mol% H <sub>2</sub> S
Mol% HCl
Mol% He
Mol% i-C <sub>4</sub> H <sub>10</sub>
Mol% i-C <sub>5</sub> H <sub>12</sub>
Mol% Kr
Mol% N <sub>2</sub>
Mol% n-C <sub>10</sub> H <sub>22</sub>
Mol% n-C <sub>4</sub> H <sub>10</sub>

Mol% n-C5H12
Mol% n-C6H14
Mol% n-C7H16
Mol% n-C8H18
Mol% n-C9H20
Mol% Ne
Mol% NH3
Mol% O2
Mol% SO2
Mol% Xe
Mol% other gas
Relative humidity

## Parameter overview with brief description

Parameter	Prerequisite	Description	Selection / User entry	Factory setting
Gas type	The following conditions are met: <ul style="list-style-type: none"> <li>▪ In the <b>Select medium</b> parameter, the <b>Gas</b> option is selected.</li> <li>▪ In the <b>Select gas type</b> parameter, the <b>Single gas</b> option is selected.</li> </ul>	Select measured gas type.	<ul style="list-style-type: none"> <li>▪ Hydrogen H2</li> <li>▪ Helium He</li> <li>▪ Neon Ne</li> <li>▪ Argon Ar</li> <li>▪ Krypton Kr</li> <li>▪ Xenon Xe</li> <li>▪ Nitrogen N2</li> <li>▪ Oxygen O2</li> <li>▪ Chlorine Cl2</li> <li>▪ Ammonia NH3</li> <li>▪ Carbon monoxide CO</li> <li>▪ Carbon dioxide CO2</li> <li>▪ Sulfur dioxide SO2</li> <li>▪ Hydrogen sulfide H2S</li> <li>▪ Hydrogen chloride HCl</li> <li>▪ Methane CH4</li> <li>▪ Ethane C2H6</li> <li>▪ Propane C3H8</li> <li>▪ Butane C4H10</li> <li>▪ Ethylene C2H4</li> <li>▪ Vinyl Chloride C2H3Cl</li> </ul>	Methane CH4
Gas mixture	The following conditions are met: <ul style="list-style-type: none"> <li>▪ In the <b>Select medium</b> parameter, the <b>Gas</b> option is selected.</li> <li>▪ In the <b>Select gas type</b> parameter, the <b>Gas mixture</b> option is selected.</li> </ul>	Select measured gas mixture.	<ul style="list-style-type: none"> <li>▪ Hydrogen H2</li> <li>▪ Helium He</li> <li>▪ Neon Ne</li> <li>▪ Argon Ar</li> <li>▪ Krypton Kr</li> <li>▪ Xenon Xe</li> <li>▪ Nitrogen N2</li> <li>▪ Oxygen O2</li> <li>▪ Chlorine Cl2</li> <li>▪ Ammonia NH3</li> <li>▪ Carbon monoxide CO</li> <li>▪ Carbon dioxide CO2</li> <li>▪ Sulfur dioxide SO2</li> <li>▪ Hydrogen sulfide H2S</li> <li>▪ Hydrogen chloride HCl</li> <li>▪ Methane CH4</li> <li>▪ Ethane C2H6</li> <li>▪ Propane C3H8</li> <li>▪ Butane C4H10</li> <li>▪ Ethylene C2H4</li> <li>▪ Vinyl Chloride C2H3Cl</li> <li>▪ Others</li> </ul>	Methane CH4



Parameter	Prerequisite	Description	Selection / User entry	Factory setting
Mol% Ar	<p>The following conditions are met:</p> <p>In the <b>Select medium</b> parameter, the <b>Gas</b> option is selected.</p> <ul style="list-style-type: none"> <li>- In the <b>Select gas type</b> parameter, the <b>Gas mixture</b> option is selected and in the <b>Gas mixture</b> parameter, the <b>Argon Ar</b> option is selected.</li> </ul> <p>Or</p> <ul style="list-style-type: none"> <li>- In the <b>Select gas type</b> parameter, the <b>Natural gas</b> option is selected and in the <b>Density calculation</b> parameter, the <b>ISO 12213-2</b> option is selected.</li> </ul>	Enter amount of substance for the gas mixture.	0 to 100 %	0 %
Mol% C2H3Cl	<p>The following conditions are met:</p> <ul style="list-style-type: none"> <li>▪ In the <b>Select medium</b> parameter, the <b>Gas</b> option is selected.</li> <li>▪ In the <b>Select gas type</b> parameter, the <b>Gas mixture</b> option is selected.</li> <li>▪ In the <b>Gas mixture</b> parameter, the <b>Vinyl Chloride C2H3Cl</b> option is selected.</li> </ul>	Enter amount of substance for the gas mixture.	0 to 100 %	0 %
Mol% C2H4	<p>The following conditions are met:</p> <ul style="list-style-type: none"> <li>▪ In the <b>Select medium</b> parameter, the <b>Gas</b> option is selected.</li> <li>▪ In the <b>Select gas type</b> parameter, the <b>Gas mixture</b> option is selected.</li> <li>▪ In the <b>Gas mixture</b> parameter, the <b>Ethylene C2H4</b> option is selected.</li> </ul>	Enter amount of substance for the gas mixture.	0 to 100 %	0 %
Mol% C2H6	<p>The following conditions are met:</p> <p>In the <b>Select medium</b> parameter, the <b>Gas</b> option is selected.</p> <ul style="list-style-type: none"> <li>- In the <b>Select gas type</b> parameter, the <b>Gas mixture</b> option is selected and in the <b>Gas mixture</b> parameter, the <b>Ethane C2H6</b> option is selected.</li> </ul> <p>Or</p> <ul style="list-style-type: none"> <li>- In the <b>Select gas type</b> parameter, the <b>Natural gas</b> option is selected and in the <b>Density calculation</b> parameter, the <b>ISO 12213-2</b> option is selected.</li> </ul>	Enter amount of substance for the gas mixture.	0 to 100 %	0 %

Parameter	Prerequisite	Description	Selection / User entry	Factory setting
Mol% C3H8	<p>The following conditions are met: In the <b>Select medium</b> parameter, the <b>Gas</b> option is selected.</p> <ul style="list-style-type: none"> <li>- In the <b>Select gas type</b> parameter, the <b>Gas mixture</b> option is selected and in the <b>Gas mixture</b> parameter, the <b>Propane C3H8</b> option is selected.</li> </ul> <p>Or</p> <ul style="list-style-type: none"> <li>- In the <b>Select gas type</b> parameter, the <b>Natural gas</b> option is selected and in the <b>Density calculation</b> parameter, the <b>ISO 12213-2</b> option is selected.</li> </ul>	Enter amount of substance for the gas mixture.	0 to 100 %	0 %
Mol% CH4	<p>The following conditions are met: In the <b>Select medium</b> parameter, the <b>Gas</b> option is selected.</p> <ul style="list-style-type: none"> <li>- In the <b>Select gas type</b> parameter, the <b>Gas mixture</b> option is selected and in the <b>Gas mixture</b> parameter, the <b>Methane CH4</b> option is selected.</li> </ul> <p>Or</p> <ul style="list-style-type: none"> <li>- In the <b>Select gas type</b> parameter, the <b>Natural gas</b> option is selected.</li> </ul>	Enter amount of substance for the gas mixture.	0 to 100 %	100 %
Mol% Cl2	<p>The following conditions are met:</p> <ul style="list-style-type: none"> <li>▪ In the <b>Select medium</b> parameter, the <b>Gas</b> option is selected.</li> <li>▪ In the <b>Select gas type</b> parameter, the <b>Gas mixture</b> option is selected.</li> <li>▪ In the <b>Gas mixture</b> parameter, the <b>Chlorine Cl2</b> option is selected.</li> </ul>	Enter amount of substance for the gas mixture.	0 to 100 %	0 %
Mol% CO	<p>The following conditions are met: In the <b>Select medium</b> parameter, the <b>Gas</b> option is selected.</p> <ul style="list-style-type: none"> <li>- In the <b>Select gas type</b> parameter, the <b>Gas mixture</b> option is selected and in the <b>Gas mixture</b> parameter, the <b>Carbon monoxide CO</b> option is selected.</li> </ul> <p>Or</p> <ul style="list-style-type: none"> <li>- In the <b>Select gas type</b> parameter, the <b>Natural gas</b> option is selected and in the <b>Density calculation</b> parameter, the <b>ISO 12213-2</b> option is selected.</li> </ul>	Enter amount of substance for the gas mixture.	0 to 100 %	0 %

Parameter	Prerequisite	Description	Selection / User entry	Factory setting
Mol% CO <sub>2</sub>	<p>The following conditions are met:</p> <p>In the <b>Select medium</b> parameter, the <b>Gas</b> option is selected.</p> <ul style="list-style-type: none"> <li>- In the <b>Select gas type</b> parameter, the <b>Gas mixture</b> option is selected and in the <b>Gas mixture</b> parameter, the <b>Carbon dioxide CO<sub>2</sub></b> option is selected.</li> </ul> <p>Or</p> <ul style="list-style-type: none"> <li>- In the <b>Select gas type</b> parameter, the <b>Natural gas</b> option is selected.</li> </ul>	Enter amount of substance for the gas mixture.	0 to 100 %	0 %
Mol% H <sub>2</sub>	<p>The following conditions are met:</p> <p>In the <b>Select medium</b> parameter, the <b>Gas</b> option is selected.</p> <ul style="list-style-type: none"> <li>- In the <b>Select gas type</b> parameter, the <b>Gas mixture</b> option is selected and in the <b>Gas mixture</b> parameter, the <b>Hydrogen H<sub>2</sub></b> option is selected.</li> </ul> <p>Or</p> <ul style="list-style-type: none"> <li>- In the <b>Select gas type</b> parameter, the <b>Natural gas</b> option is selected and in the <b>Density calculation</b> parameter, the <b>AGA Nx19</b> option is <b>not</b> selected.</li> </ul>	Enter amount of substance for the gas mixture.	0 to 100 %	0 %
Mol% H <sub>2</sub> O	<p>The following conditions are met:</p> <ul style="list-style-type: none"> <li>▪ In the <b>Select medium</b> parameter, the <b>Gas</b> option is selected.</li> <li>▪ In the <b>Select gas type</b> parameter, the <b>Natural gas</b> option is selected.</li> <li>▪ In the <b>Density calculation</b> parameter, the <b>ISO 12213-2</b> option is selected.</li> </ul>	Enter amount of substance for the gas mixture.	0 to 100 %	0 %
Mol% H <sub>2</sub> S	<p>The following conditions are met:</p> <p>In the <b>Select medium</b> parameter, the <b>Gas</b> option is selected.</p> <ul style="list-style-type: none"> <li>- In the <b>Select gas type</b> parameter, the <b>Gas mixture</b> option is selected and in the <b>Gas mixture</b> parameter, the <b>Hydrogen sulfide H<sub>2</sub>S</b> option is selected.</li> </ul> <p>Or</p> <ul style="list-style-type: none"> <li>- In the <b>Select gas type</b> parameter, the <b>Natural gas</b> option is selected and in the <b>Density calculation</b> parameter, the <b>ISO 12213-2</b> option is selected.</li> </ul>	Enter amount of substance for the gas mixture.	0 to 100 %	0 %

Parameter	Prerequisite	Description	Selection / User entry	Factory setting
Mol% HCl	The following conditions are met: <ul style="list-style-type: none"> <li>▪ In the <b>Select medium</b> parameter, the <b>Gas</b> option is selected.</li> <li>▪ In the <b>Select gas type</b> parameter, the <b>Gas mixture</b> option is selected.</li> <li>▪ In the <b>Gas mixture</b> parameter, the <b>Hydrogen chloride HCl</b> option is selected.</li> </ul>	Enter amount of substance for the gas mixture.	0 to 100 %	0 %
Mol% He	The following conditions are met: In the <b>Select medium</b> parameter, the <b>Gas</b> option is selected. – In the <b>Select gas type</b> parameter, the <b>Gas mixture</b> option is selected and in the <b>Gas mixture</b> parameter, the <b>Helium He</b> option is selected. Or – In the <b>Select gas type</b> parameter, the <b>Natural gas</b> option is selected and in the <b>Density calculation</b> parameter, the <b>ISO 12213-2</b> option is selected.	Enter amount of substance for the gas mixture.	0 to 100 %	0 %
Mol% i-C4H10	The following conditions are met: <ul style="list-style-type: none"> <li>▪ In the <b>Select medium</b> parameter, the <b>Gas</b> option is selected.</li> <li>▪ In the <b>Select gas type</b> parameter, the <b>Natural gas</b> option is selected.</li> <li>▪ In the <b>Density calculation</b> parameter, the <b>ISO 12213-2</b> option is selected.</li> </ul>	Enter amount of substance for the gas mixture.	0 to 100 %	0 %
Mol% i-C5H12	The following conditions are met: <ul style="list-style-type: none"> <li>▪ In the <b>Select medium</b> parameter, the <b>Gas</b> option is selected.</li> <li>▪ In the <b>Select gas type</b> parameter, the <b>Natural gas</b> option is selected.</li> <li>▪ In the <b>Density calculation</b> parameter, the <b>ISO 12213-2</b> option is selected.</li> </ul>	Enter amount of substance for the gas mixture.	0 to 100 %	0 %
Mol% Kr	The following conditions are met: <ul style="list-style-type: none"> <li>▪ In the <b>Select medium</b> parameter, the <b>Gas</b> option is selected.</li> <li>▪ In the <b>Select gas type</b> parameter, the <b>Gas mixture</b> option is selected.</li> <li>▪ In the <b>Gas mixture</b> parameter, the <b>Krypton Kr</b> option is selected.</li> </ul>	Enter amount of substance for the gas mixture.	0 to 100 %	0 %

Parameter	Prerequisite	Description	Selection / User entry	Factory setting
Mol% N2	<p>The following conditions are met:</p> <p>In the <b>Select medium</b> parameter, the <b>Gas</b> option is selected.</p> <ul style="list-style-type: none"> <li>- In the <b>Select gas type</b> parameter, the <b>Gas mixture</b> option is selected and in the <b>Gas mixture</b> parameter, the <b>Nitrogen N2</b> option is selected.</li> </ul> <p>Or</p> <ul style="list-style-type: none"> <li>- In the <b>Select gas type</b> parameter, the <b>Natural gas</b> option is selected and in the <b>Density calculation</b> parameter, the <b>AGA Nx19</b> option or the <b>ISO 12213- 2</b> option is selected.</li> </ul>	Enter amount of substance for the gas mixture.	0 to 100 %	0 %
Mol% n-C10H22	<p>The following conditions are met:</p> <ul style="list-style-type: none"> <li>▪ In the <b>Select medium</b> parameter, the <b>Gas</b> option is selected.</li> <li>▪ In the <b>Select gas type</b> parameter, the <b>Natural gas</b> option is selected.</li> <li>▪ In the <b>Density calculation</b> parameter, the <b>ISO 12213- 2</b> option is selected.</li> </ul>	Enter amount of substance for the gas mixture.	0 to 100 %	0 %
Mol% n-C4H10	<p>The following conditions are met:</p> <ul style="list-style-type: none"> <li>▪ In the <b>Select medium</b> parameter, the <b>Gas</b> option is selected.</li> <li>- In the <b>Select gas type</b> parameter, the <b>Gas mixture</b> option is selected and in the <b>Gas mixture</b> parameter, the <b>Butane C4H10</b> option is selected.</li> </ul> <p>Or</p> <ul style="list-style-type: none"> <li>- In the <b>Select gas type</b> parameter, the <b>Natural gas</b> option is selected and in the <b>Density calculation</b> parameter, the <b>ISO 12213- 2</b> option is selected.</li> </ul> <ul style="list-style-type: none"> <li>▪ Or</li> <li>In the <b>Select medium</b> parameter, the <b>Liquid</b> option is selected and in the <b>Select liquid type</b> parameter, the <b>LPG</b> option is selected.</li> </ul>	Enter amount of substance for the gas mixture.	0 to 100 %	0 %

Parameter	Prerequisite	Description	Selection / User entry	Factory setting
Mol% n-C5H12	The following conditions are met: <ul style="list-style-type: none"> <li>▪ In the <b>Select medium</b> parameter, the <b>Gas</b> option is selected.</li> <li>▪ In the <b>Select gas type</b> parameter, the <b>Natural gas</b> option is selected.</li> <li>▪ In the <b>Density calculation</b> parameter, the <b>ISO 12213-2</b> option is selected.</li> </ul>	Enter amount of substance for the gas mixture.	0 to 100 %	0 %
Mol% n-C6H14	The following conditions are met: <ul style="list-style-type: none"> <li>▪ In the <b>Select medium</b> parameter, the <b>Gas</b> option is selected.</li> <li>▪ In the <b>Select gas type</b> parameter, the <b>Natural gas</b> option is selected.</li> <li>▪ In the <b>Density calculation</b> parameter, the <b>ISO 12213-2</b> option is selected.</li> </ul>	Enter amount of substance for the gas mixture.	0 to 100 %	0 %
Mol% n-C7H16	The following conditions are met: <ul style="list-style-type: none"> <li>▪ In the <b>Select medium</b> parameter, the <b>Gas</b> option is selected.</li> <li>▪ In the <b>Select gas type</b> parameter, the <b>Natural gas</b> option is selected.</li> <li>▪ In the <b>Density calculation</b> parameter, the <b>ISO 12213-2</b> option is selected.</li> </ul>	Enter amount of substance for the gas mixture.	0 to 100 %	0 %
Mol% n-C8H18	The following conditions are met: <ul style="list-style-type: none"> <li>▪ In the <b>Select medium</b> parameter, the <b>Gas</b> option is selected.</li> <li>▪ In the <b>Select gas type</b> parameter, the <b>Natural gas</b> option is selected.</li> <li>▪ In the <b>Density calculation</b> parameter, the <b>ISO 12213-2</b> option is selected.</li> </ul>	Enter amount of substance for the gas mixture.	0 to 100 %	0 %
Mol% n-C9H20	The following conditions are met: <ul style="list-style-type: none"> <li>▪ In the <b>Select medium</b> parameter, the <b>Gas</b> option is selected.</li> <li>▪ In the <b>Select gas type</b> parameter, the <b>Natural gas</b> option is selected.</li> <li>▪ In the <b>Density calculation</b> parameter, the <b>ISO 12213-2</b> option is selected.</li> </ul>	Enter amount of substance for the gas mixture.	0 to 100 %	0 %

Parameter	Prerequisite	Description	Selection / User entry	Factory setting
Mol% Ne	The following conditions are met: <ul style="list-style-type: none"> <li>▪ In the <b>Select medium</b> parameter, the <b>Gas</b> option is selected.</li> <li>▪ In the <b>Select gas type</b> parameter, the <b>Gas mixture</b> option is selected.</li> <li>▪ In the <b>Gas mixture</b> parameter, the <b>Neon Ne</b> option is selected.</li> </ul>	Enter amount of substance for the gas mixture.	0 to 100 %	0 %
Mol% NH <sub>3</sub>	The following conditions are met: <ul style="list-style-type: none"> <li>▪ In the <b>Select medium</b> parameter, the <b>Gas</b> option is selected.</li> <li>▪ In the <b>Select gas type</b> parameter, the <b>Gas mixture</b> option is selected.</li> <li>▪ In the <b>Gas mixture</b> parameter, the <b>Ammonia NH<sub>3</sub></b> option is selected.</li> </ul>	Enter amount of substance for the gas mixture.	0 to 100 %	0 %
Mol% O <sub>2</sub>	The following conditions are met: In the <b>Select medium</b> parameter, the <b>Gas</b> option is selected. – In the <b>Select gas type</b> parameter, the <b>Gas mixture</b> option is selected and in the <b>Gas mixture</b> parameter, the <b>Oxygen O<sub>2</sub></b> option is selected. Or – In the <b>Select gas type</b> parameter, the <b>Natural gas</b> option is selected and in the <b>Density calculation</b> parameter, the <b>ISO 12213-2</b> option is selected.	Enter amount of substance for the gas mixture.	0 to 100 %	0 %
Mol% SO <sub>2</sub>	The following conditions are met: <ul style="list-style-type: none"> <li>▪ In the <b>Select medium</b> parameter, the <b>Gas</b> option is selected.</li> <li>▪ In the <b>Select gas type</b> parameter, the <b>Gas mixture</b> option is selected.</li> <li>▪ In the <b>Gas mixture</b> parameter, the <b>Sulfur dioxide SO<sub>2</sub></b> option is selected.</li> </ul>	Enter amount of substance for the gas mixture.	0 to 100 %	0 %
Mol% Xe	The following conditions are met: <ul style="list-style-type: none"> <li>▪ In the <b>Select medium</b> parameter, the <b>Gas</b> option is selected.</li> <li>▪ In the <b>Select gas type</b> parameter, the <b>Gas mixture</b> option is selected.</li> <li>▪ In the <b>Gas mixture</b> parameter, the <b>Xenon Xe</b> option is selected.</li> </ul>	Enter amount of substance for the gas mixture.	0 to 100 %	0 %

Parameter	Prerequisite	Description	Selection / User entry	Factory setting
Mol% other gas	The following conditions are met: <ul style="list-style-type: none"> <li>In the <b>Select medium</b> parameter, the <b>Gas</b> option is selected.</li> <li>In the <b>Select gas type</b> parameter, the <b>Gas mixture</b> option is selected.</li> <li>In the <b>Gas mixture</b> parameter, the <b>Others</b> option is selected.</li> </ul>	Enter amount of substance for the gas mixture.	0 to 100 %	0 %
Relative humidity	The following conditions are met: <ul style="list-style-type: none"> <li>In the <b>Select medium</b> parameter, the <b>Gas</b> option is selected.</li> <li>In the <b>Select gas type</b> parameter, the <b>Air</b> option is selected.</li> </ul>	Enter humidity content of air in %.	0 to 100 %	0 %

### 10.5.3 Performing external compensation

The **External compensation** submenu contains parameters which can be used to enter external or fixed values. These values are used for internal calculations.

 The **Fixed process pressure** parameter is set to the value **0 bar abs.** (ex works). In this case, the measuring device ignores the pressure read in via the current input. For the measuring device to use the external (read-in) pressure, a value > 0 bar abs. must be entered in the **Fixed process pressure** parameter.

For a detailed description of how to calculate the mass flow and energy flow:  
→  163





#### Navigation





"Setup" menu → Advanced setup → External compensation

▶ External compensation



## Parameter overview with brief description

Parameter	Prerequisite	Description	Selection / User entry	Factory setting
External value	For the following order code: "Sensor version", option "Mass flow"	Assign variable from external device to process variable.  For detailed information on the calculation of the measured variables with steam: →  164  For detailed information on setting the parameter in steam applications, see the Special Documentation for the <b>Wet Steam Detection and Wet Steam Measurement</b> →  188 application package.	<ul style="list-style-type: none"> <li>■ Off</li> <li>■ Pressure</li> <li>■ Relative pressure</li> <li>■ Density</li> <li>■ Temperature</li> <li>■ 2nd temperature delta heat</li> </ul>	Off
Atmospheric pressure	In the <b>External value</b> parameter, the <b>Relative pressure</b> option is selected.	Enter atmospheric pressure value to be used for pressure correction. <i>Dependency</i> The unit is taken from the <b>Pressure unit</b> parameter	0 to 250 bar	1.01325 bar
Delta heat calculation	The <b>Delta heat calculation</b> parameter is visible.	Calculates the transferred heat of a heat exchanger (= delta heat).	<ul style="list-style-type: none"> <li>■ Off</li> <li>■ Device on cold side</li> <li>■ Device on warm side</li> </ul>	Device on warm side
Fixed density	For the following order code: "Sensor version", option "Volume flow"	Enter fixed value for medium density. <i>Dependency</i> The unit is taken from the <b>Density unit</b> parameter.	0.01 to 15 000 kg/m <sup>3</sup>	1 000 kg/m <sup>3</sup>
Fixed temperature	–	Enter a fixed value for process temperature. <i>Dependency</i> The unit is taken from the <b>Temperature unit</b> parameter	–200 to 450 °C	20 °C
2nd temperature delta heat	The <b>2nd temperature delta heat</b> parameter is visible.	Enter 2nd temperature value to calculate the delta heat. <i>Dependency</i> The unit is taken from the <b>Temperature unit</b> parameter	–200 to 450 °C	20 °C

Parameter	Prerequisite	Description	Selection / User entry	Factory setting
Fixed process pressure	<p>The following conditions are met:</p> <ul style="list-style-type: none"> <li>Order code for "Sensor version", option "Mass flow (integrated temperature measurement)"</li> <li>In the <b>External value</b> parameter (→ 73), the <b>Pressure</b> option is not selected.</li> </ul>	<p>Enter fixed value for process pressure.</p> <p><i>Dependency</i> The unit is taken from the <b>Pressure unit</b> parameter</p> <p> For detailed information on the calculation of the measured variables with steam: → 164</p> <p> For detailed information on setting the parameter in steam applications, see the Special Documentation for the <b>Wet Steam Detection</b> and <b>Wet Steam Measurement</b> → 188 application package.</p>	0 to 250 bar abs.	0 bar abs.
Steam quality	<p>The following conditions are met:</p> <ul style="list-style-type: none"> <li>Order code for "Application package": <ul style="list-style-type: none"> <li>Option ES "Wet steam detection"</li> <li>Option EU "Wet steam measurement"</li> </ul> </li> <li>In the <b>Select medium</b> parameter, the <b>Steam</b> option is selected.</li> </ul> <p> The software options currently enabled are displayed in the <b>Software option overview</b> parameter.</p>	<p>Select compensation mode for steam quality.</p> <p> For detailed information on setting the parameter in steam applications, see the Special Documentation for the <b>Wet Steam Detection</b> and <b>Wet Steam Measurement</b> → 188 application package.</p>	<ul style="list-style-type: none"> <li>Fixed value</li> <li>Calculated value</li> </ul>	Fixed value
Steam quality value	<p>The following conditions are met:</p> <ul style="list-style-type: none"> <li>In the <b>Select medium</b> parameter, the <b>Steam</b> option is selected.</li> <li>In the <b>Steam quality</b> parameter, the <b>Fixed value</b> option is selected.</li> </ul>	<p>Enter fixed value for steam quality.</p> <p> For detailed information on setting the parameter in steam applications, see the Special Documentation for the <b>Wet Steam Detection</b> and <b>Wet Steam Measurement</b> → 188 application package.</p>	0 to 100 %	100 %

### 10.5.4 Carrying out a sensor adjustment

The **Sensor adjustment** submenu contains parameters that pertain to the functionality of the sensor.

#### Navigation

"Setup" menu → Advanced setup → Sensor adjustment

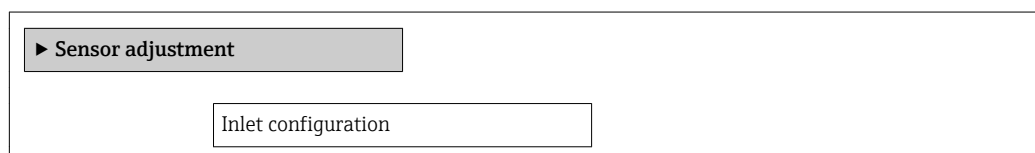

<div style="border: 1px solid black; width: 80%; margin: 0 auto; padding: 2px;">Inlet run</div> <div style="border: 1px solid black; width: 80%; margin: 10px auto; padding: 2px;">Mating pipe diameter</div> <div style="border: 1px solid black; width: 80%; margin: 10px auto; padding: 2px;">Installation factor</div>
--

**Parameter overview with brief description**

Parameter	Prerequisite	Description	Selection / User entry	Factory setting
Inlet configuration	The <b>inlet run correction</b> feature: <ul style="list-style-type: none"> <li>■ Is a standard feature and can only be used in Prowirl F 200.</li> <li>■ Can be used for the following pressure ratings and nominal diameters: DN 15 to 150 (1 to 6")                             <ul style="list-style-type: none"> <li>- EN (DIN)</li> <li>- ASME B16.5, Sch. 40/80</li> </ul> </li> </ul>	Select inlet configuration.	<ul style="list-style-type: none"> <li>■ Off</li> <li>■ Single elbow</li> <li>■ Double elbow</li> <li>■ Double elbow 3D</li> <li>■ Reduction</li> </ul>	Off
Inlet run	The <b>inlet run correction</b> feature: <ul style="list-style-type: none"> <li>■ Is a standard feature and can only be used in Prowirl F 200.</li> <li>■ Can be used for the following pressure ratings and nominal diameters: DN 15 to 150 (1 to 6")                             <ul style="list-style-type: none"> <li>- EN (DIN)</li> <li>- ASME B16.5, Sch. 40/80</li> </ul> </li> </ul>	Define length of the straight inlet run.  <i>Dependency</i> The unit is taken from the <b>Length unit</b> parameter	0 to 20 m	0 m
Mating pipe diameter	-	Enter diameter of mating pipe to enable diameter mismatch correction.  Detailed information on diameter mismatch correction: →  174 <i>Dependency</i> The unit is taken from the <b>Length unit</b> parameter.	0 to 1 m (0 to 3 ft) Input value = 0: Diameter mismatch correction is disabled.	Country-specific: <ul style="list-style-type: none"> <li>■ 0 m</li> <li>■ 0 ft</li> </ul>
Installation factor	-	Enter factor to adjust for installation conditions.	Positive floating-point number	1.0

**10.5.5 Configuring the totalizer**

In the "**Totalizer 1 to 3**" submenu the individual totalizer can be configured.



**Navigation**

"Setup" menu → Advanced setup → Totalizer 1 to 3

<div style="border: 1px solid black; width: 80%; margin: 0 auto; padding: 2px; background-color: #cccccc;">▶ Totalizer 1 to 3</div> <div style="border: 1px solid black; width: 80%; margin: 10px auto; padding: 2px;">Assign process variable</div>
--

Unit totalizer
Failure mode

### Parameter overview with brief description

Parameter	Prerequisite	Description	Selection	Factory setting
Assign process variable	–	Select process variable for totalizer.	<ul style="list-style-type: none"> <li>■ Off</li> <li>■ Volume flow</li> <li>■ Corrected volume flow</li> <li>■ Mass flow</li> <li>■ Total mass flow *</li> <li>■ Condensate mass flow *</li> <li>■ Energy flow *</li> <li>■ Heat flow difference *</li> </ul>	Volume flow
Unit totalizer	One of the following options is selected in the <b>Assign process variable</b> parameter (→  116) of the <b>Totalizer 1 to 3</b> submenu: <ul style="list-style-type: none"> <li>■ Volume flow</li> <li>■ Corrected volume flow</li> <li>■ Mass flow</li> <li>■ Total mass flow *</li> <li>■ Condensate mass flow *</li> <li>■ Energy flow *</li> <li>■ Heat flow difference *</li> </ul>	Select process variable totalizer unit.	Unit choose list	Country-specific: <ul style="list-style-type: none"> <li>■ m<sup>3</sup></li> <li>■ ft<sup>3</sup></li> </ul>
Totalizer operation mode	–	Select totalizer calculation mode.	<ul style="list-style-type: none"> <li>■ Net flow total</li> <li>■ Forward flow total</li> <li>■ Reverse flow total</li> </ul>	Net flow total
Failure mode	One of the following options is selected in the <b>Assign process variable</b> parameter (→  116) of the <b>Totalizer 1 to 3</b> submenu: <ul style="list-style-type: none"> <li>■ Volume flow</li> <li>■ Corrected volume flow</li> <li>■ Mass flow</li> <li>■ Total mass flow *</li> <li>■ Condensate mass flow *</li> <li>■ Energy flow *</li> <li>■ Heat flow difference *</li> </ul>	Define totalizer behavior in alarm condition.	<ul style="list-style-type: none"> <li>■ Stop</li> <li>■ Actual value</li> <li>■ Last valid value</li> </ul>	Stop

\* Visibility depends on order options or device settings

### 10.5.6 Carrying out additional display configurations

In the **Display** submenu you can set all the parameters associated with the configuration of the local display.

#### Navigation

"Setup" menu → Advanced setup → Display

► Display

Format display

Value 1 display

0% bargraph value 1

100% bargraph value 1

Decimal places 1

Value 2 display

Decimal places 2

Value 3 display

0% bargraph value 3

100% bargraph value 3

Decimal places 3

Value 4 display

Decimal places 4

Language

Display interval

Display damping

Header

Header text

Separator

Backlight

## Parameter overview with brief description

Parameter	Prerequisite	Description	Selection / User entry	Factory setting
Format display	A local display is provided.	Select how measured values are shown on the display.	<ul style="list-style-type: none"> <li>▪ 1 value, max. size</li> <li>▪ 1 bargraph + 1 value</li> <li>▪ 2 values</li> <li>▪ 1 value large + 2 values</li> <li>▪ 4 values</li> </ul>	1 value, max. size
Value 1 display	A local display is provided.	Select the measured value that is shown on the local display.	<ul style="list-style-type: none"> <li>▪ Volume flow</li> <li>▪ Corrected volume flow</li> <li>▪ Mass flow</li> <li>▪ Flow velocity</li> <li>▪ Temperature</li> <li>▪ Calculated saturated steam pressure *</li> <li>▪ Steam quality *</li> <li>▪ Total mass flow *</li> <li>▪ Condensate mass flow *</li> <li>▪ Energy flow *</li> <li>▪ Heat flow difference *</li> <li>▪ Reynolds number *</li> <li>▪ Density *</li> <li>▪ Pressure *</li> <li>▪ Specific volume *</li> <li>▪ Degrees of superheat *</li> <li>▪ Totalizer 1</li> <li>▪ Totalizer 2</li> <li>▪ Totalizer 3</li> <li>▪ Current output 1</li> <li>▪ Current output 2 *</li> </ul>	Volume flow
0% bargraph value 1	A local display is provided.	Enter 0% value for bar graph display.	Signed floating-point number	Country-specific: <ul style="list-style-type: none"> <li>▪ 0 m<sup>3</sup>/h</li> <li>▪ 0 ft<sup>3</sup>/h</li> </ul>
100% bargraph value 1	A local display is provided.	Enter 100% value for bar graph display.	Signed floating-point number	Depends on country and nominal diameter
Decimal places 1	A measured value is specified in the <b>Value 1 display</b> parameter.	Select the number of decimal places for the display value.	<ul style="list-style-type: none"> <li>▪ x</li> <li>▪ x.x</li> <li>▪ x.xx</li> <li>▪ x.xxx</li> <li>▪ x.xxxx</li> </ul>	x.xx
Value 2 display	A local display is provided.	Select the measured value that is shown on the local display.	Picklist, see <b>Value 1 display</b> parameter	None
Decimal places 2	A measured value is specified in the <b>Value 2 display</b> parameter.	Select the number of decimal places for the display value.	<ul style="list-style-type: none"> <li>▪ x</li> <li>▪ x.x</li> <li>▪ x.xx</li> <li>▪ x.xxx</li> <li>▪ x.xxxx</li> </ul>	x.xx
Value 3 display	A local display is provided.	Select the measured value that is shown on the local display.	Picklist, see <b>Value 1 display</b> parameter	None
0% bargraph value 3	A selection has been made in the <b>Value 3 display</b> parameter.	Enter 0% value for bar graph display.	Signed floating-point number	Country-specific: <ul style="list-style-type: none"> <li>▪ 0 m<sup>3</sup>/h</li> <li>▪ 0 ft<sup>3</sup>/h</li> </ul>
100% bargraph value 3	An option has been selected in the <b>Value 3 display</b> parameter.	Enter 100% value for bar graph display.	Signed floating-point number	0

Parameter	Prerequisite	Description	Selection / User entry	Factory setting
Decimal places 3	A measured value is specified in the <b>Value 3 display</b> parameter.	Select the number of decimal places for the display value.	<ul style="list-style-type: none"> <li>■ x</li> <li>■ x.x</li> <li>■ x.xx</li> <li>■ x.xxx</li> <li>■ x.xxxx</li> </ul>	x.xx
Value 4 display	A local display is provided.	Select the measured value that is shown on the local display.	Picklist, see <b>Value 1 display</b> parameter	None
Decimal places 4	A measured value is specified in the <b>Value 4 display</b> parameter.	Select the number of decimal places for the display value.	<ul style="list-style-type: none"> <li>■ x</li> <li>■ x.x</li> <li>■ x.xx</li> <li>■ x.xxx</li> <li>■ x.xxxx</li> </ul>	x.xx
Language	A local display is provided.	Set display language.	<ul style="list-style-type: none"> <li>■ English</li> <li>■ Deutsch *</li> <li>■ Français *</li> <li>■ Español *</li> <li>■ Italiano *</li> <li>■ Nederlands *</li> <li>■ Portuguesa *</li> <li>■ Polski *</li> <li>■ русский язык (Russian) *</li> <li>■ Svenska *</li> <li>■ Türkçe *</li> <li>■ 中文 (Chinese) *</li> <li>■ 日本語 (Japanese) *</li> <li>■ 한국어 (Korean) *</li> <li>■ Bahasa Indonesia *</li> <li>■ tiếng Việt (Vietnamese) *</li> <li>■ čeština (Czech) *</li> </ul>	English (alternatively, the ordered language is preset in the device)
Display interval	A local display is provided.	Set time measured values are shown on display if display alternates between values.	1 to 10 s	5 s
Display damping	A local display is provided.	Set display reaction time to fluctuations in the measured value.	0.0 to 999.9 s	5.0 s
Header	A local display is provided.	Select header contents on local display.	<ul style="list-style-type: none"> <li>■ Device tag</li> <li>■ Free text</li> </ul>	Device tag
Header text	The <b>Free text</b> option is selected in the <b>Header</b> parameter.	Enter display header text.	Max. 12 characters such as letters, numbers or special characters (e.g. @, %, /)	-----
Separator	A local display is provided.	Select decimal separator for displaying numerical values.	<ul style="list-style-type: none"> <li>■ . (point)</li> <li>■ , (comma)</li> </ul>	. (point)
Backlight	–	Switch the local display backlight on and off.   Only for device version with local display SD03 (touch control)	<ul style="list-style-type: none"> <li>■ Disable</li> <li>■ Enable</li> </ul>	Disable

\* Visibility depends on order options or device settings

## 10.6 Configuration management

After commissioning, you can save the current device configuration, copy it to another measuring point or restore the previous device configuration.

You can do so using the **Configuration management** parameter and the related options found in the **Configuration backup display** submenu.

**Navigation**

"Setup" menu → Advanced setup → Configuration backup display

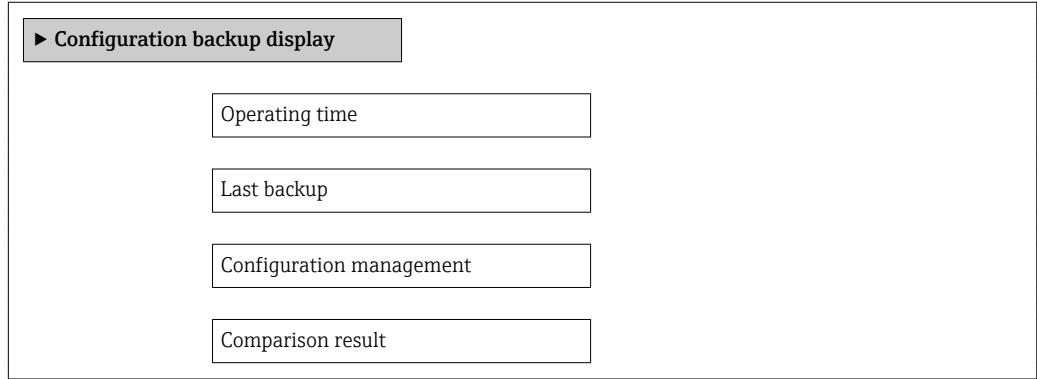

**Parameter overview with brief description**

Parameter	Prerequisite	Description	User interface / Selection	Factory setting
Operating time	–	Indicates how long the device has been in operation.	Days (d), hours (h), minutes (m) and seconds (s)	–
Last backup	A local display is provided.	Indicates when the last data backup was saved to the display module.	Days (d), hours (h), minutes (m) and seconds (s)	–
Configuration management	A local display is provided.	Select action for managing the device data in the display module.	<ul style="list-style-type: none"> <li>▪ Cancel</li> <li>▪ Execute backup</li> <li>▪ Restore</li> <li>▪ Duplicate</li> <li>▪ Compare</li> <li>▪ Clear backup data</li> </ul>	Cancel
Comparison result	A local display is provided.	Comparison between present device data and display backup.	<ul style="list-style-type: none"> <li>▪ Settings identical</li> <li>▪ Settings not identical</li> <li>▪ No backup available</li> <li>▪ Backup settings corrupt</li> <li>▪ Check not done</li> <li>▪ Dataset incompatible</li> </ul>	Check not done

**10.6.1 Function scope of the "Configuration management" parameter**

Options	Description
Execute backup	The current device configuration is backed up from the integrated HistoROM to the device's display module. The backup copy includes the transmitter data of the device.
Restore	The last backup copy of the device configuration is restored from the display module to the device's integrated HistoROM. The backup copy includes the transmitter data of the device.
Duplicate	The transmitter configuration from another device is duplicated to the device using the display module.



Options	Description
Compare	The device configuration saved in the display module is compared with the current device configuration of the integrated HistoROM.
Clear backup data	The backup copy of the device configuration is deleted from the display module of the device.

**i** *Integrated HistoROM*  
 A HistoROM is a "non-volatile" device memory in the form of an EEPROM.

**i** While this action is in progress, the configuration cannot be edited via the local display and a message on the processing status appears on the display.

## 10.7 Simulation

The **Simulation** submenu enables you to simulate, without a real flow situation, various process variables in the process and the device alarm mode and to verify downstream signal chains (switching valves or closed-control loops).

**Navigation**  
 "Diagnostics" menu → Simulation

▶ Simulation

Assign simulation process variable

Value process variable

Simulation current input 1

Value current input 1

Simulation current output 1 to 2

Value current output 1 to 2

Frequency simulation

Frequency value

Pulse simulation

Pulse value

Switch output simulation





Switch status

Simulation device alarm

Diagnostic event category
Simulation diagnostic event

### Parameter overview with brief description

Parameter	Prerequisite	Description	Selection / User entry	Factory setting
Assign simulation process variable	–	Select a process variable for the simulation process that is activated.	<ul style="list-style-type: none"> <li>▪ Off</li> <li>▪ Volume flow</li> <li>▪ Corrected volume flow</li> <li>▪ Mass flow</li> <li>▪ Flow velocity</li> <li>▪ Temperature</li> <li>▪ Calculated saturated steam pressure *</li> <li>▪ Steam quality *</li> <li>▪ Total mass flow *</li> <li>▪ Condensate mass flow *</li> <li>▪ Energy flow</li> <li>▪ Heat flow difference *</li> <li>▪ Reynolds number</li> </ul>	Off
Value process variable	One of the following options is selected in the <b>Assign simulation process variable</b> parameter (→ 122): <ul style="list-style-type: none"> <li>▪ Volume flow</li> <li>▪ Corrected volume flow</li> <li>▪ Mass flow</li> <li>▪ Flow velocity</li> <li>▪ Temperature *</li> <li>▪ Calculated saturated steam pressure *</li> <li>▪ Steam quality *</li> <li>▪ Total mass flow *</li> <li>▪ Condensate mass flow *</li> <li>▪ Energy flow *</li> <li>▪ Heat flow difference *</li> <li>▪ Reynolds number *</li> </ul>	Enter the simulation value for the selected process variable.	Depends on the process variable selected	0
Simulation current input 1	–	Switch simulation of the current input on and off.	<ul style="list-style-type: none"> <li>▪ Off</li> <li>▪ On</li> </ul>	Off
Value current input 1	In the <b>Simulation current input</b> parameter the <b>On</b> option is selected.	Enter the current value for simulation.	3.59 to 22.5 mA	3.59 mA
Simulation current output 1 to 2	–	Switch the simulation of the current output on and off.	<ul style="list-style-type: none"> <li>▪ Off</li> <li>▪ On</li> </ul>	Off
Value current output 1 to 2	In the <b>Simulation current output 1 to 2</b> parameter, the <b>On</b> option is selected.	Enter the current value for simulation.	3.59 to 22.5 mA	3.59 mA
Frequency simulation	The <b>Frequency</b> option is selected in the <b>Operating mode</b> parameter.	Switch the simulation of the frequency output on and off.	<ul style="list-style-type: none"> <li>▪ Off</li> <li>▪ On</li> </ul>	Off
Frequency value	The <b>On</b> option is selected in the <b>Frequency simulation</b> parameter.	Enter the frequency value for the simulation.	0.0 to 1 250.0 Hz	0.0 Hz

Parameter	Prerequisite	Description	Selection / User entry	Factory setting
Pulse simulation	The <b>Pulse</b> option is selected in the <b>Operating mode</b> parameter.	Set and switch off the pulse output simulation.  For <b>Fixed value</b> option: <b>Pulse width</b> parameter (→  79) defines the pulse width of the pulses output.	<ul style="list-style-type: none"> <li>▪ Off</li> <li>▪ Fixed value</li> <li>▪ Down-counting value</li> </ul>	Off
Pulse value	In the <b>Pulse simulation</b> parameter (→  123), the <b>Down-counting value</b> option is selected.	Enter the number of pulses for simulation.	0 to 65 535	0
Switch output simulation	The <b>Switch</b> option is selected in the <b>Operating mode</b> parameter.	Switch the simulation of the switch output on and off.	<ul style="list-style-type: none"> <li>▪ Off</li> <li>▪ On</li> </ul>	Off
Switch status	The <b>On</b> option is selected in the <b>Switch output simulation</b> parameter (→  123).	Select the status of the status output for the simulation.	<ul style="list-style-type: none"> <li>▪ Open</li> <li>▪ Closed</li> </ul>	Open
Simulation device alarm	–	Switch the device alarm on and off.	<ul style="list-style-type: none"> <li>▪ Off</li> <li>▪ On</li> </ul>	Off
Diagnostic event category	–	Select a diagnostic event category.	<ul style="list-style-type: none"> <li>▪ Sensor</li> <li>▪ Electronics</li> <li>▪ Configuration</li> <li>▪ Process</li> </ul>	Process
Simulation diagnostic event	–	Select a diagnostic event for the simulation process that is activated.	<ul style="list-style-type: none"> <li>▪ Off</li> <li>▪ Diagnostic event picklist (depends on the category selected)</li> </ul>	Off

\* Visibility depends on order options or device settings

## 10.8 Protecting settings from unauthorized access

The following options exist for protecting the configuration of the measuring device from unintentional modification after commissioning:

- Write protection via access code
- Write protection via write protection switch
- Write protection via keypad lock →  57

### 10.8.1 Write protection via access code

With the customer-specific access code, the parameters for the measuring device configuration are write-protected and their values can no longer be changed via local operation.

#### Navigation



"Setup" menu → Advanced setup → Administration → Define access code

▶ Define access code

### Defining the access code via local display

1. Navigate to the **Enter access code** parameter.
2. Define a max. 4-digit numeric code as an access code.
3. Enter the access code again to confirm the code.
  - ↳ The -symbol appears in front of all write-protected parameters.

The device automatically locks the write-protected parameters again if a key is not pressed for 10 minutes in the navigation and editing view. The device locks the write-protected parameters automatically after 60 s if the user skips back to the operational display mode from the navigation and editing view.

-  If write access is activated via access code, it can be also be deactivated only via the access code →  57.
  - The user role with which the user is currently logged on via the local display →  57 is indicated by the **Access status display** parameter. Navigation path: "Operation" menu → Access status display

### Parameters which can always be modified via the local display

Certain parameters that do not affect the measurement are excepted from write protection via the local display. Despite the defined access code, these parameters can always be modified even if the other parameters are locked.

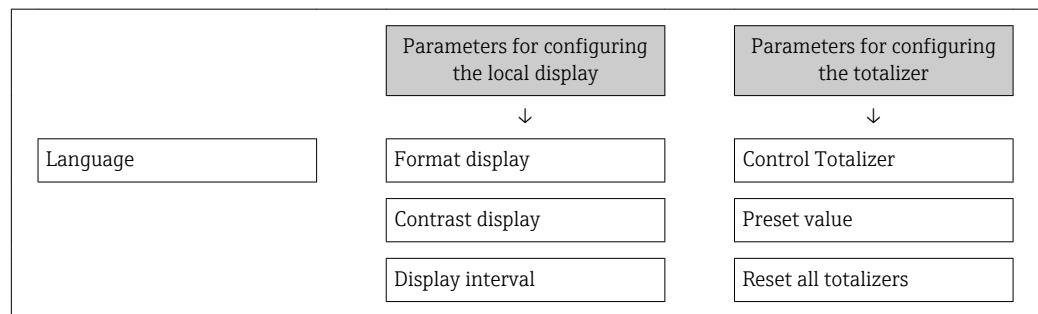

### 10.8.2 Write protection via write protection switch

Unlike write protection via a user-specific access code, this allows write access to the entire operating menu - other than the **"Contrast display" parameter** - to be locked.

The parameter values are now read only and cannot be edited any more (exception **"Contrast display" parameter**):

- Via local display
- Via service interface (CDI)
- Via HART protocol

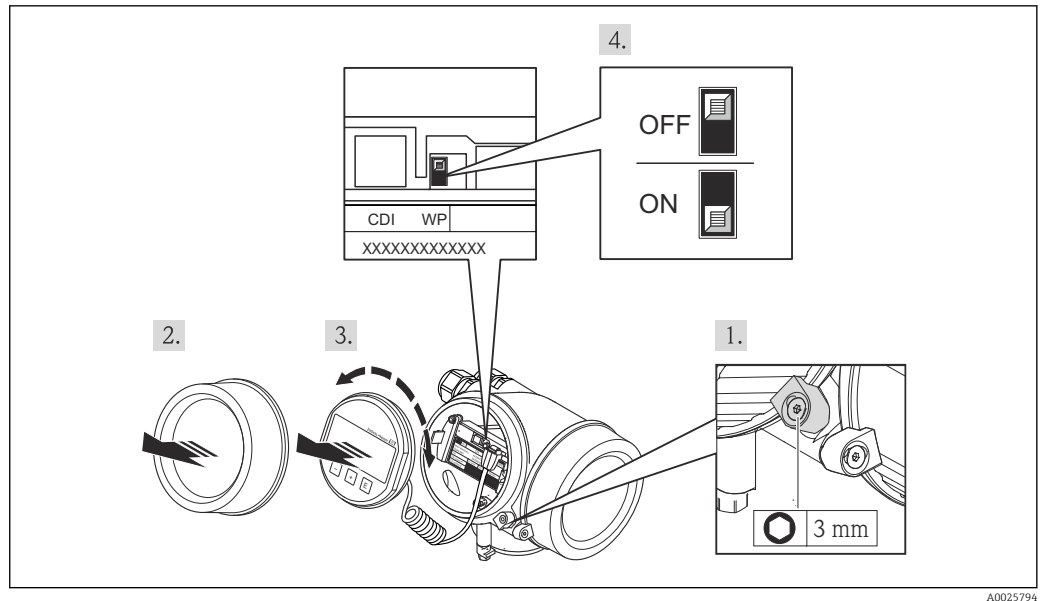

A0025794

1. Loosen the securing clamp.
2. Unscrew the electronics compartment cover.
3. Pull out the display module with a gentle rotational movement. To make it easier to access the write protection switch, attach the display module to the edge of the electronics compartment.
  - ↳ Display module is attached to the edge of the electronics compartment.

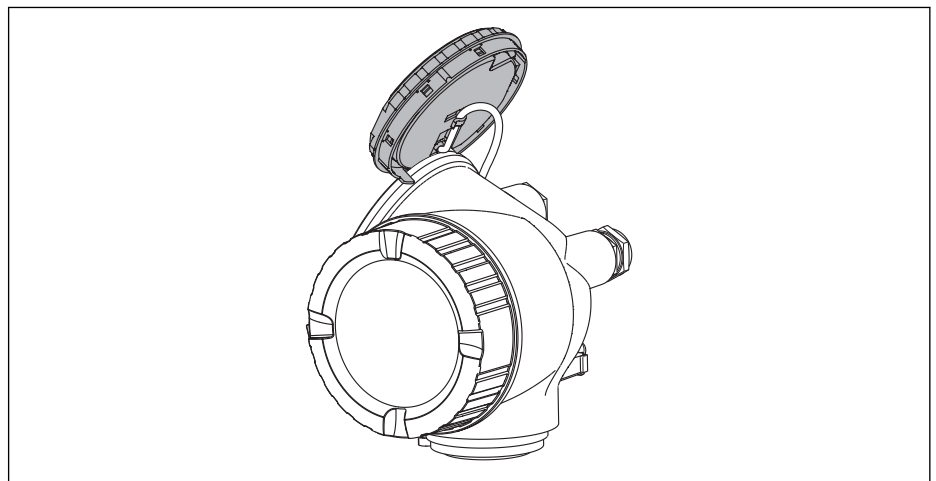

A0013909

4. Setting the write protection switch (WP) on the main electronics module to the **ON** position enables hardware write protection. Setting the write protection switch (WP) on the main electronics module to the **OFF** position (factory setting) disables hardware write protection.
  - ↳ If hardware write protection is enabled, the **Locking status** parameter displays the **Hardware locked** option . In addition, on the local display the -symbol appears in front of the parameters in the header of the operational display and in the navigation view.

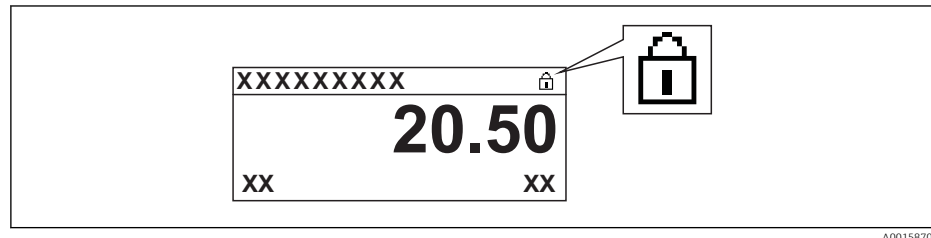

A0015870

If hardware write protection is disabled, no option is displayed in the **Locking status** parameter . On the local display, the -symbol disappears from in front of the parameters in the header of the operational display and in the navigation view.

5. Feed the cable into the gap between the housing and main electronics module and plug the display module into the electronics compartment in the desired direction until it engages.
6. Reverse the removal procedure to reassemble the transmitter.

# 11 Operation

## 11.1 Reading the device locking status

Device active write protection: **Locking status** parameter

### Navigation



"Operation" menu → Locking status

*Function scope of the "Locking status" parameter*



Options	Description
None	The access status displayed in " <b>Access status display</b> " parameter applies →  57. Only appears on local display.
Hardware locked	The DIP switch for hardware locking is activated on the main electronics module. This prevents write access to the parameters .
Temporarily locked	Write access to the parameters is temporarily lock due to device-internal processing (e.g. data upload/download, reset). Once the internal processing has been completed, the parameters can be changed once again.

## 11.2 Adjusting the operating language

Information →  67

 For information on the operating languages supported by the measuring device →  185

## 11.3 Configuring the display

- Basic settings for the local display →  89
- Advanced settings for the local display →  117

## 11.4 Reading measured values

With the **Measured values** submenu, it is possible to read all the measured values.

### 11.4.1 Process variables

The **Process variables** submenu contains all the parameters needed to display the current measured values for every process variable.

### Navigation

"Diagnostics" menu → Measured values → Process variables

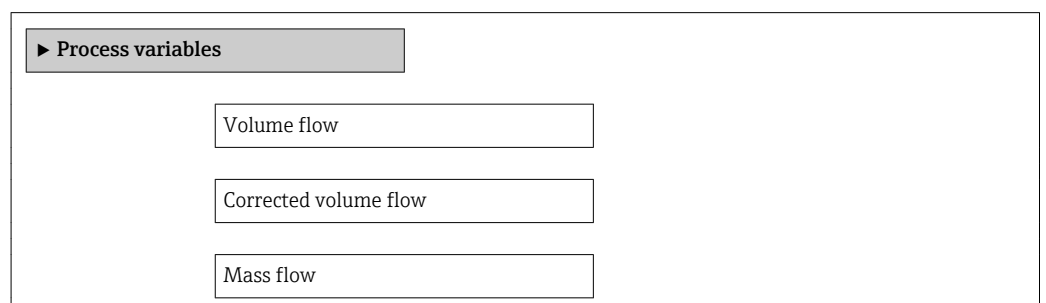

Flow velocity
Temperature
Calculated saturated steam pressure
Steam quality
Total mass flow
Condensate mass flow
Energy flow
Heat flow difference
Reynolds number
Density
Specific volume
Pressure
Compressibility factor
Degrees of superheat

**Parameter overview with brief description**

Parameter	Prerequisite	Description	User interface
Volume flow	-	Displays the volume flow currently measured. <i>Dependency</i> The unit is taken from the <b>Volume flow unit</b> parameter	Signed floating-point number
Corrected volume flow	-	Displays the corrected volume flow currently calculated. <i>Dependency</i> The unit is taken from: <b>Corrected volume flow unit</b> parameter	Signed floating-point number
Mass flow	-	Displays the mass flow currently calculated. <i>Dependency</i> The unit is taken from the <b>Mass flow unit</b> parameter	Signed floating-point number
Flow velocity	-	Displays the flow velocity currently calculated. <i>Dependency</i> The unit is taken from the <b>Velocity unit</b> parameter	Signed floating-point number



Parameter	Prerequisite	Description	User interface
Temperature	–	Displays the temperature currently measured. <i>Dependency</i> The unit is taken from the <b>Temperature unit</b> parameter	Signed floating-point number
Calculated saturated steam pressure	The following conditions are met: <ul style="list-style-type: none"> <li>Order code for "Sensor version", option "Mass flow"</li> <li>The <b>Steam</b> option is selected in the <b>Select medium</b> parameter.</li> </ul>	Displays the saturated steam pressure currently calculated. <i>Dependency</i> The unit is taken from the <b>Pressure unit</b> parameter	Signed floating-point number
Steam quality	The following conditions are met: <ul style="list-style-type: none"> <li>Order code for "Sensor version", option "Mass flow"</li> <li>The <b>Steam</b> option is selected in the <b>Select medium</b> parameter.</li> </ul>	Displays the current steam quality. Depends on the compensation mode of the steam quality (Steam quality parameter (7605)).	Signed floating-point number
Total mass flow	The following conditions are met: <ul style="list-style-type: none"> <li>Order code for "Application package", option EU "Wet steam measurement"</li> <li>The <b>Steam</b> option is selected in the <b>Select medium</b> parameter.</li> </ul>	Displays the total mass flow currently calculated (steam and condensate). <i>Dependency</i> The unit is taken from the <b>Mass flow unit</b> parameter	Signed floating-point number
Condensate mass flow	The following conditions are met: <ul style="list-style-type: none"> <li>Order code for "Application package", option EU "Wet steam measurement"</li> <li>The <b>Steam</b> option is selected in the <b>Select medium</b> parameter.</li> </ul>	Displays the condensate mass flow currently calculated. <i>Dependency</i> The unit is taken from the <b>Mass flow unit</b> parameter	Signed floating-point number
Energy flow	For the following order code: "Sensor version", option "Mass flow"	Displays the energy flow currently calculated. <i>Dependency</i> The unit is taken from the <b>Energy flow unit</b> parameter	Signed floating-point number
Heat flow difference	The following conditions are met: Order code for "Sensor version", option "Mass flow"  In the <b>Select gas type</b> parameter, one of the following options is selected: <ul style="list-style-type: none"> <li>Single gas</li> <li>Gas mixture</li> <li>Natural gas</li> <li>User-specific gas</li> </ul>	Displays the heat flow difference currently calculated. <i>Dependency</i> The unit is taken from the <b>Energy flow unit</b> parameter	Signed floating-point number
Reynolds number	For the following order code: "Sensor version", option "Mass flow"	Displays the Reynolds number currently calculated.	Signed floating-point number
Density	For the following order code: "Sensor version", option "Mass flow"	Displays the density currently measured. <i>Dependency</i> The unit is taken from the <b>Density unit</b> parameter	Positive floating-point number
Specific volume	For the following order code: "Sensor version", option "Mass flow"	Displays the current value for the specific volume. <i>Dependency</i> The unit is taken from the <b>Specific volume unit</b> parameter	Positive floating-point number
Pressure	For the following order code: <ul style="list-style-type: none"> <li>"Sensor version", option "Mass flow"</li> <li>In the <b>External value</b> parameter, the <b>Pressure</b> option is selected.</li> </ul>	Displays the current process pressure. <i>Dependency</i> The unit is taken from the <b>Pressure unit</b> parameter	0 to 250 bar

Parameter	Prerequisite	Description	User interface
Compressibility factor	The following conditions are met: Order code for "Sensor version", option "Mass flow"  In the <b>Select medium</b> parameter, the <b>Gas</b> option or <b>Steam</b> option is selected.	Displays the compressibility factor currently calculated.	0 to 2
Degrees of superheat	In the <b>Select medium</b> parameter, the <b>Steam</b> option is selected.	Displays the degree of superheating currently calculated.	0 to 500 K

### 11.4.2 Totalizer

The **Totalizer** submenu contains all the parameters needed to display the current measured values for every totalizer.

#### Navigation

"Diagnostics" menu → Measured values → Totalizer

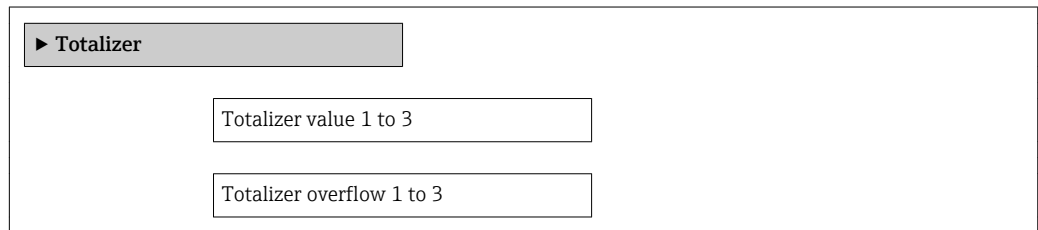

#### Parameter overview with brief description

Parameter	Prerequisite	Description	User interface
Totalizer value 1 to 3	One of the following options is selected in the <b>Assign process variable</b> parameter (→ ⓘ 116) of the <b>Totalizer 1 to 3</b> submenu: <ul style="list-style-type: none"> <li>■ Volume flow</li> <li>■ Corrected volume flow</li> <li>■ Mass flow</li> <li>■ Total mass flow *</li> <li>■ Condensate mass flow *</li> <li>■ Energy flow *</li> <li>■ Heat flow difference *</li> </ul>	Displays the current totalizer counter value.	Signed floating-point number
Totalizer overflow 1 to 3	One of the following options is selected in the <b>Assign process variable</b> parameter (→ ⓘ 116) of the <b>Totalizer 1 to 3</b> submenu: <ul style="list-style-type: none"> <li>■ Volume flow</li> <li>■ Corrected volume flow</li> <li>■ Mass flow</li> <li>■ Total mass flow *</li> <li>■ Condensate mass flow *</li> <li>■ Energy flow *</li> <li>■ Heat flow difference *</li> </ul>	Displays the current totalizer overflow.	Integer with sign

\* Visibility depends on order options or device settings

### 11.4.3 Input values

The **Input values** submenu guides you systematically to the individual input values.

 The submenu only appears if the device was ordered with a current input → ⓘ 31.

**Navigation**

"Diagnostics" menu → Measured values → Input values

**Structure of the submenu**

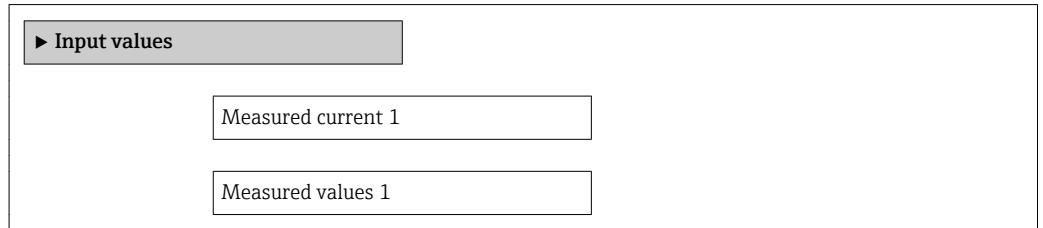

**Parameter overview with brief description**

Parameter	Description	User interface
Measured current 1	Displays the current value of the current input.	3.59 to 22.5 mA
Measured values 1	Displays the current input value. <i>Dependency</i> The display depends on the option selected in the <b>External value</b> parameter.	Signed floating-point number

**11.4.4 Output values**

The **Output values** submenu contains all the parameters needed to display the current measured values for every output.

**Navigation**

"Diagnostics" menu → Measured values → Output values

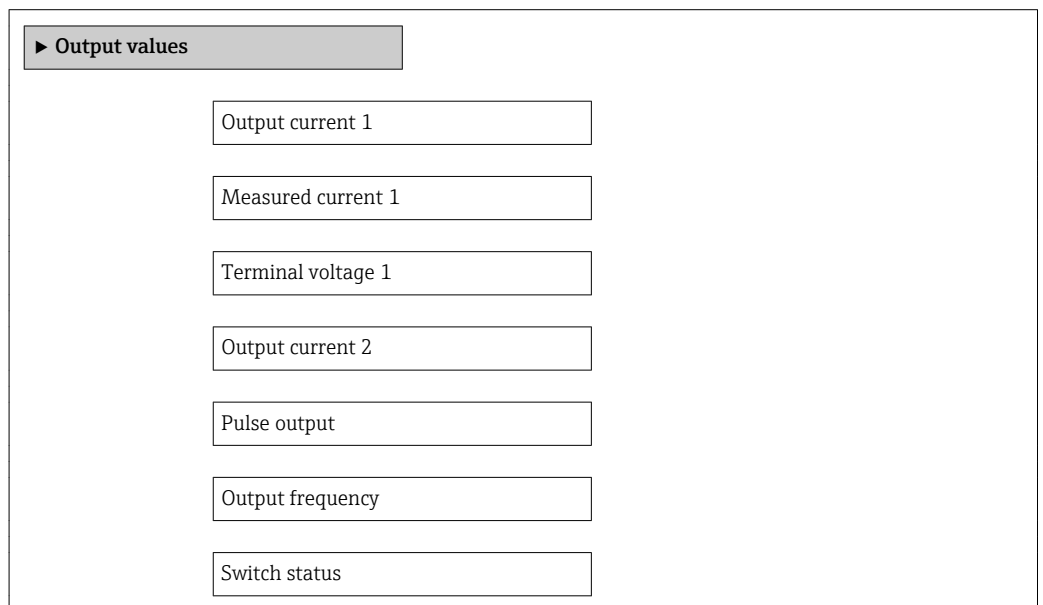



### Parameter overview with brief description

Parameter	Prerequisite	Description	User interface
Output current 1	–	Displays the current value currently calculated for the current output.	3.59 to 22.5 mA
Measured current 1	–	Displays the current value currently measured for the current output.	0 to 30 mA
Terminal voltage 1	–	Displays the current terminal voltage that is applied at the current output.	0.0 to 50.0 V
Output current 2	–	Displays the current value currently calculated for the current output.	3.59 to 22.5 mA
Pulse output	The <b>Pulse</b> option is selected in the <b>Operating mode</b> parameter.	Displays the pulse frequency currently output.	Positive floating-point number
Output frequency	In the <b>Operating mode</b> parameter, the <b>Frequency</b> option is selected.	Displays the value currently measured for the frequency output.	0 to 1 250 Hz
Switch status	In the <b>Operating mode</b> parameter, the <b>Switch</b> option is selected.	Displays the current switch output status.	<ul style="list-style-type: none"> <li>▪ Open</li> <li>▪ Closed</li> </ul>

## 11.5 Adapting the measuring device to the process conditions

The following are available for this purpose:

- Basic settings using the **Setup** menu →  68
- Advanced settings using the **Advanced setup** submenu →  94

## 11.6 Performing a totalizer reset

The totalizers are reset in the **Operation** submenu:

- Control Totalizer
- Reset all totalizers

*Function scope of the "Control Totalizer" parameter*

Options	Description
Totalize	The totalizer is started.
Reset + hold	The totaling process is stopped and the totalizer is reset to 0.
Preset + hold	The totaling process is stopped and the totalizer is set to its defined start value from the <b>Preset value</b> parameter.
Reset + totalize	The totalizer is reset to 0 and the totaling process is restarted.
Preset + totalize	The totalizer is set to the defined start value from the <b>Preset value</b> parameter and the totaling process is restarted.
Hold	Totalizing is stopped.

*Function scope of the "Reset all totalizers" parameter*

Options	Description
Reset + totalize	Resets all totalizers to 0 and restarts the totaling process. This deletes all the flow values previously totalized.

**Navigation**

"Operation" menu → Totalizer handling

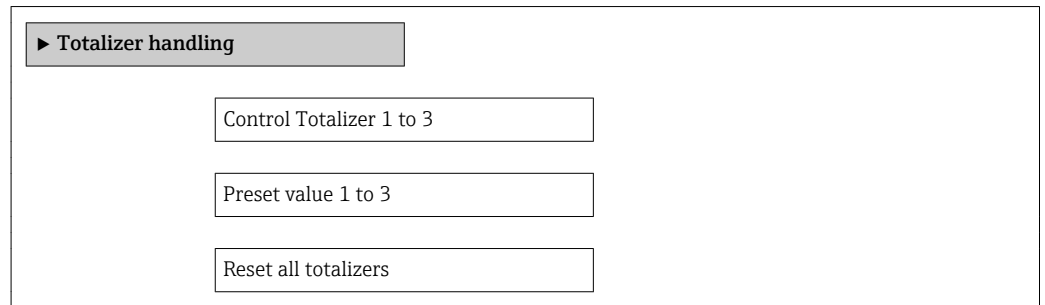

**Parameter overview with brief description**

Parameter	Prerequisite	Description	Selection / User entry	Factory setting
Control Totalizer 1 to 3	One of the following options is selected in the <b>Assign process variable</b> parameter (→ ⓘ 116) of the <b>Totalizer 1 to 3</b> submenu: <ul style="list-style-type: none"> <li>▪ Volume flow</li> <li>▪ Corrected volume flow</li> <li>▪ Mass flow</li> <li>▪ Total mass flow *</li> <li>▪ Condensate mass flow *</li> <li>▪ Energy flow *</li> <li>▪ Heat flow difference *</li> </ul>	Control totalizer value.	<ul style="list-style-type: none"> <li>▪ Totalize</li> <li>▪ Reset + hold</li> <li>▪ Preset + hold</li> <li>▪ Reset + totalize</li> <li>▪ Preset + totalize</li> </ul>	Totalize
Preset value 1 to 3	One of the following options is selected in the <b>Assign process variable</b> parameter (→ ⓘ 116) of the <b>Totalizer 1 to 3</b> submenu: <ul style="list-style-type: none"> <li>▪ Volume flow</li> <li>▪ Corrected volume flow</li> <li>▪ Mass flow</li> <li>▪ Total mass flow *</li> <li>▪ Condensate mass flow *</li> <li>▪ Energy flow *</li> <li>▪ Heat flow difference *</li> </ul>	Specify start value for totalizer. <i>Dependency</i>  The unit of the selected process variable is specified for the totalizer in the <b>Unit totalizer</b> parameter (→ ⓘ 88).	Signed floating-point number	Country-specific: <ul style="list-style-type: none"> <li>▪ 0 m<sup>3</sup></li> <li>▪ 0 ft<sup>3</sup></li> </ul>
Reset all totalizers	–	Reset all totalizers to 0 and start.	<ul style="list-style-type: none"> <li>▪ Cancel</li> <li>▪ Reset + totalize</li> </ul>	Cancel

\* Visibility depends on order options or device settings

**11.7 Showing data logging**

The **Extended HistoROM** application package must be enabled in the device (order option) for the **Data logging** submenu to appear. This contains all the parameters for the measured value history.

 The measured value history is also available via the FieldCare plant asset management tool → ⓘ 59.

**Function scope**

- A total of 1000 measured values can be stored
- 4 logging channels
- Adjustable logging interval for data logging
- Display of the measured value trend for each logging channel in the form of a chart

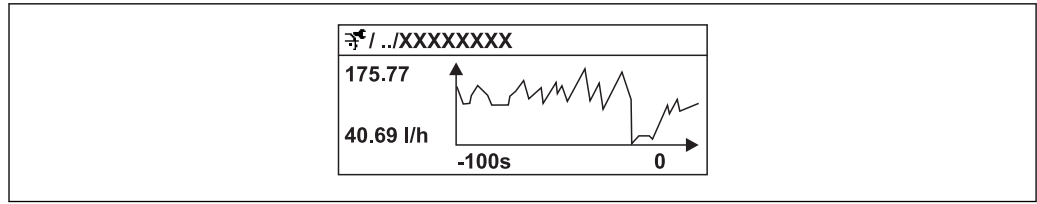

A0016222

32 Chart of a measured value trend

- x-axis: depending on the number of channels selected displays 250 to 1000 measured values of a process variable.
- y-axis: displays the approximate measured value span and constantly adapts this to the ongoing measurement.

**i** If the length of the logging interval or the assignment of the process variables to the channels is changed, the content of the data logging is deleted.

**Navigation**

"Diagnostics" menu → Data logging

**"Data logging" submenu**

▶ Data logging

Assign channel 1

Assign channel 2

Assign channel 3

Assign channel 4

Logging interval

Clear logging data



▶ Display channel 1

▶ Display channel 2

▶ Display channel 3

▶ Display channel 4

## Parameter overview with brief description

Parameter	Prerequisite	Description	Selection / User entry	Factory setting
Assign channel 1 to 4	<p>The <b>Extended HistoROM</b> application package is available.</p> <p> The software options currently enabled are displayed in the <b>Software option overview</b> parameter.</p>	Assign process variable to logging channel.	<ul style="list-style-type: none"> <li>▪ Off</li> <li>▪ Volume flow</li> <li>▪ Corrected volume flow</li> <li>▪ Mass flow</li> <li>▪ Flow velocity</li> <li>▪ Temperature</li> <li>▪ Calculated saturated steam pressure</li> <li>▪ Steam quality</li> <li>▪ Total mass flow</li> <li>▪ Condensate mass flow</li> <li>▪ Energy flow</li> <li>▪ Heat flow difference</li> <li>▪ Reynolds number</li> <li>▪ Current output 1</li> <li>▪ Current output 2 *</li> <li>▪ Density</li> <li>▪ Pressure</li> <li>▪ Specific volume</li> <li>▪ Degrees of superheat</li> <li>▪ Vortex frequency</li> <li>▪ Electronic temperature</li> </ul>	Off
Logging interval	<p>The <b>Extended HistoROM</b> application package is available.</p> <p> The software options currently enabled are displayed in the <b>Software option overview</b> parameter.</p>	Define the logging interval for data logging. This value defines the time interval between the individual data points in the memory.	1.0 to 3 600.0 s	10.0 s
Clear logging data	<p>The <b>Extended HistoROM</b> application package is available.</p> <p> The software options currently enabled are displayed in the <b>Software option overview</b> parameter.</p>	Clear the entire logging data.	<ul style="list-style-type: none"> <li>▪ Cancel</li> <li>▪ Clear data</li> </ul>	Cancel

\* Visibility depends on order options or device settings

## 12 Diagnostics and troubleshooting

### 12.1 General troubleshooting

*For local display*





Problem	Possible causes	Remedy
Local display dark and no output signals	Supply voltage does not match the value indicated on the nameplate.	Apply the correct supply voltage .
Local display dark and no output signals	The polarity of the supply voltage is wrong.	Correct the polarity.
Local display dark and no output signals	No contact between connecting cables and terminals.	Check the connection of the cables and correct if necessary.
Local display dark and no output signals	Terminals are not plugged into the I/O electronics module correctly.	Check terminals.
Local display dark and no output signals	I/O electronics module is defective.	Order spare part → ☰ 155.
Local display is dark, but signal output is within the valid range	Display is set too bright or too dark.	<ul style="list-style-type: none"> <li>▪ Set the display brighter by simultaneously pressing ☐ + ☐.</li> <li>▪ Set the display darker by simultaneously pressing ☐ + ☐.</li> </ul>
Local display is dark, but signal output is within the valid range	The cable of the display module is not plugged in correctly.	Insert the plug correctly into the main electronics module and display module.
Local display is dark, but signal output is within the valid range	Display module is defective.	Order spare part → ☰ 155.
Backlighting of local display is red	Diagnostic event with "Alarm" diagnostic behavior has occurred.	Take remedial measures → ☰ 143
Text on local display appears in a foreign language and cannot be understood.	Incorrect operating language is configured.	<ol style="list-style-type: none"> <li>1. Press ☐ + ☐ for 2 s ("home position").</li> <li>2. Press ☐.</li> <li>3. Set the desired language in the <b>Language</b> parameter.</li> </ol>
Message on local display: "Communication Error" "Check Electronics"	Communication between the display module and the electronics is interrupted.	<ul style="list-style-type: none"> <li>▪ Check the cable and the connector between the main electronics module and display module.</li> <li>▪ Order spare part → ☰ 155.</li> </ul>

*For output signals*

Problem	Possible causes	Remedy
Signal output outside the valid range	Main electronics module is defective.	Order spare part → ☰ 155.
Signal output outside the valid current range (< 3.6 mA or > 22 mA)	I/O electronics module is defective.	Order spare part → ☰ 155.
Device shows correct value on local display, but signal output is incorrect, though in the valid range.	Configuration error	Check and correct the parameter configuration.
Device measures incorrectly.	Configuration error or device is operated outside the application.	<ol style="list-style-type: none"> <li>1. Check and correct parameter configuration.</li> <li>2. Observe limit values specified in the "Technical Data".</li> </ol>



*For access*

Problem	Possible causes	Remedy
No write access to parameters	Hardware write protection enabled	Set the write protection switch on the main electronics module to the OFF position .
No write access to parameters	Current user role has limited access authorization	1. Check user role →  57. 2. Enter correct customer-specific access code →  57.
No connection via HART protocol	Communication resistor missing or incorrectly installed.	Install the communication resistor (250 Ω) correctly. Observe the maximum load →  33.
No connection via HART protocol	Commubox <ul style="list-style-type: none"> <li>■ Connected incorrectly</li> <li>■ Configured incorrectly</li> <li>■ Drivers not installed correctly</li> <li>■ USB interface on computer configured incorrectly</li> </ul>	Observe the documentation for the Commubox.  FXA195 HART: Document "Technical Information" TI00404F
No connection via service interface	Incorrect configuration of USB interface on PC or driver not installed correctly.	Observe the documentation for the Commubox.  FXA291: Document "Technical Information" TI00405C

## 12.2 Diagnostic information on local display

### 12.2.1 Diagnostic message

Faults detected by the self-monitoring system of the measuring device are displayed as a diagnostic message in alternation with the operational display.

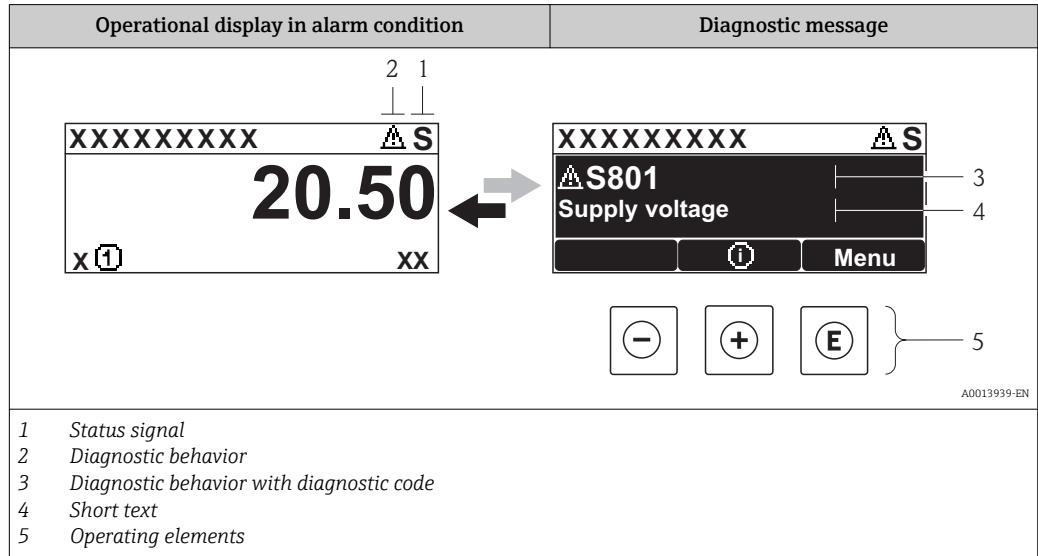

If two or more diagnostic events are pending simultaneously, only the message of the diagnostic event with the highest priority is shown.

- i** Other diagnostic events that have occurred can be called up in the **Diagnostics** menu:
  - Via parameters → 146
  - Via submenus → 147



#### Status signals

The status signals provide information on the state and reliability of the device by categorizing the cause of the diagnostic information (diagnostic event).

- i** The status signals are categorized according to VDI/VDE 2650 and NAMUR Recommendation NE 107: F = Failure, C = Function Check, S = Out of Specification, M = Maintenance Required

Symbol	Meaning
<b>F</b> <small>A0013956</small>	<b>Failure</b> A device error has occurred. The measured value is no longer valid.
<b>C</b> <small>A0013959</small>	<b>Function check</b> The device is in service mode (e.g. during a simulation).
<b>S</b> <small>A0013958</small>	<b>Out of specification</b> The device is operated: <ul style="list-style-type: none"> <li>▪ Outside its technical specification limits (e.g. outside the process temperature range)</li> <li>▪ Outside of the configuration carried out by the user (e.g. maximum flow in parameter <b>20 mA value</b>)</li> </ul>
<b>M</b> <small>A0013957</small>	<b>Maintenance required</b> Maintenance is required. The measured value remains valid.

### Diagnostic behavior



Symbol	Meaning
 <small>A0013961</small>	<b>Alarm</b> <ul style="list-style-type: none"> <li>Measurement is interrupted.</li> <li>Signal outputs and totalizers assume the defined alarm condition.</li> <li>A diagnostic message is generated.</li> <li>For local display with touch control: the background lighting changes to red.</li> </ul>
 <small>A0013962</small>	<b>Warning</b> Measurement is resumed. The signal outputs and totalizers are not affected. A diagnostic message is generated.

### Diagnostic information

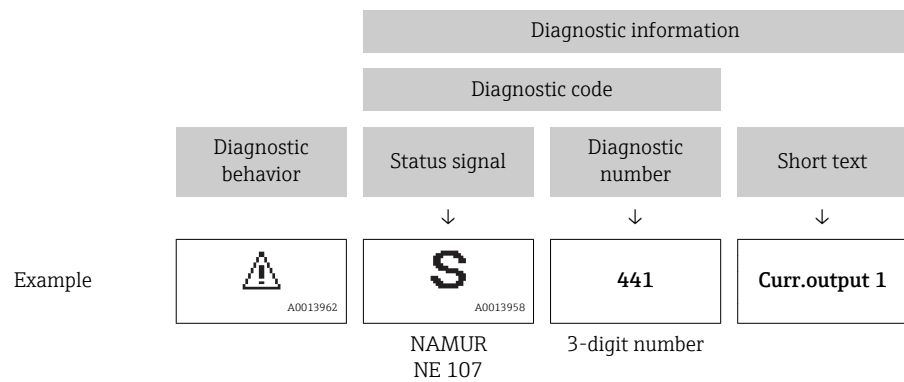
The fault can be identified using the diagnostic information. The short text helps you by providing information about the fault. In addition, the corresponding symbol for the diagnostic behavior is displayed in front of the diagnostic information on the local display.



### Operating elements

Key	Meaning
 <small>A0013970</small>	<b>Plus key</b> <i>In a menu, submenu</i> Opens the message about remedy information.
 <small>A0013952</small>	<b>Enter key</b> <i>In a menu, submenu</i> Opens the operating menu.

## 12.2.2 Calling up remedial measures

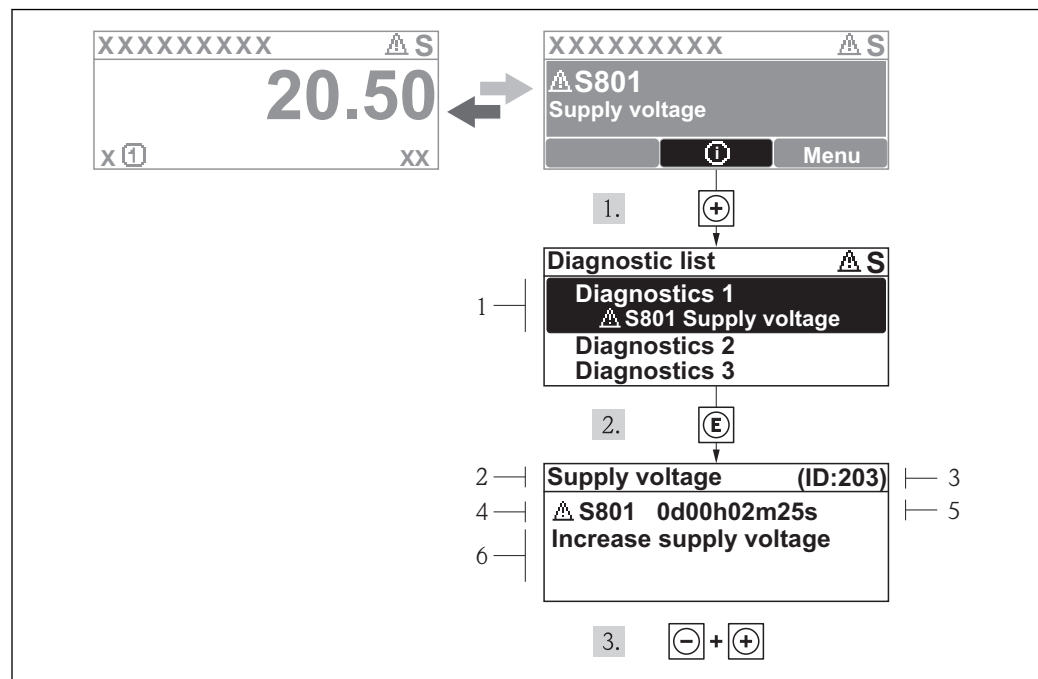

A0013940-EN

33 Message for remedial measures

- 1 Diagnostic information
- 2 Short text
- 3 Service ID
- 4 Diagnostic behavior with diagnostic code
- 5 Operation time of occurrence
- 6 Remedial measures

The user is in the diagnostic message.

1. Press (i symbol).
  - ↳ The **Diagnostic list** submenu opens.
2. Select the desired diagnostic event with or and press .
  - ↳ The message for the remedial measures for the selected diagnostic event opens.
3. Press + simultaneously.
  - ↳ The message for the remedial measures closes.

The user is in the **Diagnostics** menu at an entry for a diagnostics event, e.g. in the **Diagnostic list** submenu or the **Previous diagnostics** parameter.

1. Press .
  - ↳ The message for the remedial measures for the selected diagnostic event opens.
2. Press + simultaneously.
  - ↳ The message for the remedial measures closes.

## 12.3 Diagnostic information in FieldCare

### 12.3.1 Diagnostic options

Any faults detected by the measuring device are displayed on the home page of the operating tool once the connection has been established.

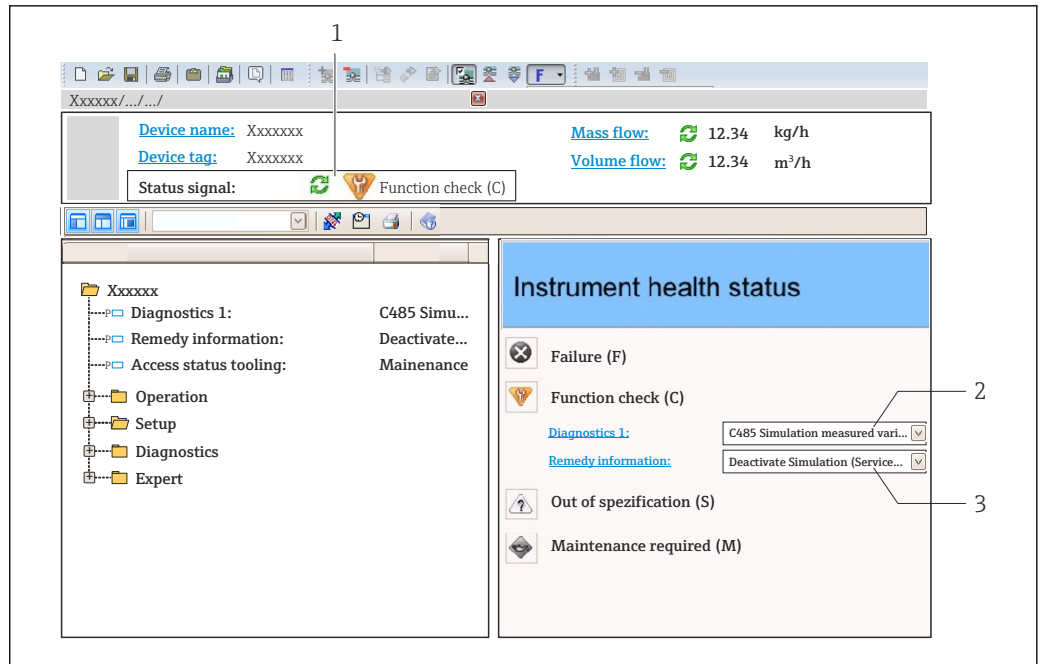

- 1 Status area with status signal → 138
- 2 Diagnostic information → 139
- 3 Remedy information with Service ID

- i** Furthermore, diagnostic events that have occurred can be viewed in the **Diagnostics** menu:
  - Via parameter → 146
  - Via submenu → 147

### Diagnostic information

The fault can be identified using the diagnostic information. The short text helps you by providing information about the fault. In addition, the corresponding symbol for the diagnostic behavior is displayed in front of the diagnostic information on the local display.

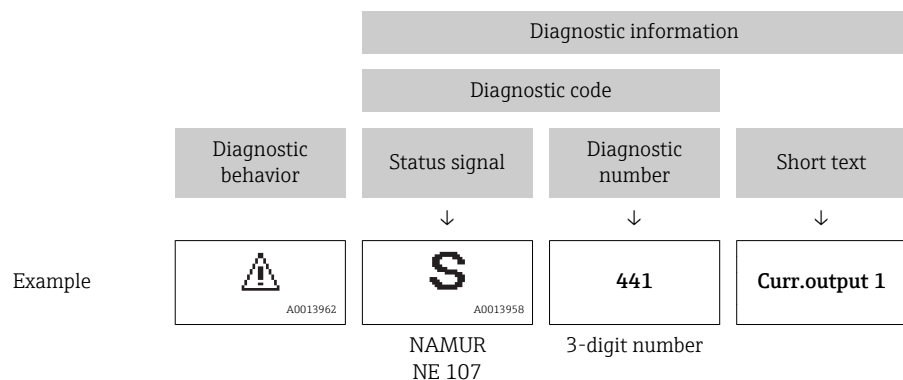

### 12.3.2 Calling up remedy information

Remedy information is provided for every diagnostic event to ensure that problems can be rectified quickly:

- On the home page  
Remedy information is displayed in a separate field below the diagnostics information.
- In the **Diagnostics** menu  
Remedy information can be called up in the working area of the user interface.

The user is in the **Diagnostics** menu.

1. Call up the desired parameter.
2. On the right in the working area, mouse over the parameter.
  - ↳ A tool tip with remedy information for the diagnostic event appears.

## 12.4 Adapting the diagnostic information

### 12.4.1 Adapting the diagnostic behavior

Each item of diagnostic information is assigned a specific diagnostic behavior at the factory. The user can change this assignment for certain diagnostic information in the **Diagnostic behavior** submenu.

"Expert" menu → System → Diagnostic handling → Diagnostic behavior

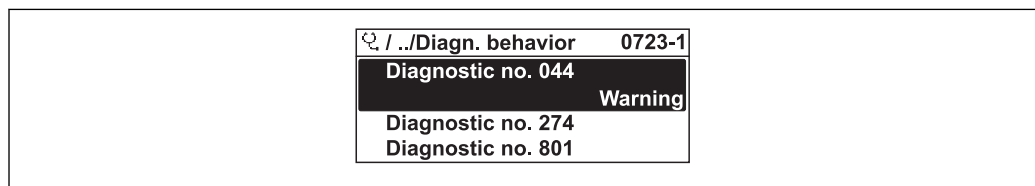

A0014048-EN

34 Taking the example of the local display

You can assign the following options to the diagnostic number as the diagnostic behavior:

Options	Description
Alarm	Measurement is interrupted. Signal outputs and totalizers assume the defined alarm condition. A diagnostic message is generated. For local display with touch control: the background lighting changes to red.
Warning	Measurement is resumed. The signal outputs and totalizers are not affected. A diagnostic message is generated.
Logbook entry only	The device continues to measure. The diagnostic message is entered in the Event logbook (events list) submenu only and is not displayed in alternation with the measured value display.
Off	The diagnostic event is ignored, and no diagnostic message is generated or entered.

### 12.4.2 Adapting the status signal

Each item of diagnostic information is assigned a specific status signal at the factory. The user can change this assignment for certain diagnostic information in the **Diagnostic event category** submenu.

"Expert" menu → Communication → Diagnostic event category

#### Available status signals



Configuration as per HART 7 Specification (Condensed Status), in accordance with NAMUR NE107.

Symbol	Meaning
<b>F</b> A0013956	<b>Failure</b> A device error has occurred. The measured value is no longer valid.
<b>C</b> A0013959	<b>Function check</b> The device is in service mode (e.g. during a simulation).

Symbol	Meaning
<b>S</b> <small>A0013958</small>	<b>Out of specification</b> The device is operated: <ul style="list-style-type: none"> <li>▪ Outside its technical specification limits (e.g. outside the process temperature range)</li> <li>▪ Outside of the configuration carried out by the user (e.g. maximum flow in parameter <b>20 mA value</b>)</li> </ul>
<b>M</b> <small>A0013957</small>	<b>Maintenance required</b> Maintenance is required. The measured value remains valid.
<b>N</b> <small>A0023076</small>	Has no effect on the condensed status.

## 12.5 Overview of diagnostic information

 The amount of diagnostic information and the number of measured variables affected increase if the measuring device has one or more application packages.

 In the case of some items of diagnostic information, the status signal and the diagnostic behavior can be changed. Change the diagnostic information →  142

Diagnostic number	Short text	Remedy instructions	Status signal [from the factory]	Diagnostic behavior [from the factory]
<b>Diagnostic of sensor</b>				
004	Sensor defective	1. Check plug connections 2. Change pre-amplifier 3. Change DSC sensor	F	Alarm
022	Temperature sensor defective	1. Check plug connections 2. Change pre-amplifier 3. Change DSC sensor	F	Alarm <sup>1)</sup>
046	Sensor limit exceeded	1. Check plug connections 2. Change pre-amplifier 3. Change DSC sensor	S	Warning
062	Sensor connection defective	1. Check plug connections 2. Change pre-amplifier 3. Change DSC sensor	F	Alarm
082	Data storage	1. Change main electronic module 2. Change sensor	F	Alarm
083	Memory content	1. Restart device 2. Restore S-Dat data 3. Change sensor	F	Alarm
114	Sensor leaky	Change DSC sensor	F	Alarm
122	Temperature sensor defective	1. Check plug connections 2. Change pre-amplifier 3. Change DSC sensor	M	Warning <sup>1)</sup>
<b>Diagnostic of electronic</b>				
242	Software incompatible	1. Check software 2. Flash or change main electronics module	F	Alarm
252	Modules incompatible	1. Check electronic modules 2. Change I/O or main electronic module	F	Alarm
261	Electronic modules	1. Restart device 2. Check electronic modules 3. Change I/O Modul or main electronics	F	Alarm

Diagnostic number	Short text	Remedy instructions	Status signal [from the factory]	Diagnostic behavior [from the factory]
262	Module connection	1. Check module connections 2. Change electronic modules	F	Alarm
270	Main electronic failure	Change main electronic module	F	Alarm
271	Main electronic failure	1. Restart device 2. Change main electronic module	F	Alarm
272	Main electronic failure	1. Restart device 2. Contact service	F	Alarm
273	Main electronic failure	1. Emergency operation via display 2. Change main electronics	F	Alarm
275	I/O module failure	Change I/O module	F	Alarm
276	I/O module failure	1. Restart device 2. Change I/O module	F	Alarm
277	Electronics defective	1. Change pre-amplifier 2. Change main electronic module	F	Alarm
282	Data storage	1. Restart device 2. Contact service	F	Alarm
283	Memory content	1. Transfer data or reset device 2. Contact service	F	Alarm
302	Device verification active	Device verification active, please wait.	C	Warning
311	Electronic failure	1. Transfer data or reset device 2. Contact service	F	Alarm
311	Electronic failure	Maintenance required! 1. Do not perform reset 2. Contact service	M	Warning
350	Pre-amplifier defective	Change pre-amplifier	F	Alarm <sup>1)</sup>
351	Pre-amplifier defective	Change pre-amplifier	F	Alarm
370	Pre-amplifier defective	1. Check plug connections 2. Check cabel connection of remote version 3. Change pre-amplifier or main electronic module	F	Alarm
371	Temperature sensor defective	1. Check plug connections 2. Change pre-amplifier 3. Change DSC sensor	M	Warning <sup>1)</sup>
<b>Diagnostic of configuration</b>				
410	Data transfer	1. Check connection 2. Retry data transfer	F	Alarm
412	Processing Download	Download active, please wait	C	Warning
431	Trim 1 to 2	Carry out trim	C	Warning
437	Configuration incompatible	1. Restart device 2. Contact service	F	Alarm
438	Dataset	1. Check data set file 2. Check device configuration 3. Up- and download new configuration	M	Warning
441	Current output 1 to 2	1. Check process 2. Check current output settings	S	Warning <sup>1)</sup>
442	Frequency output	1. Check process 2. Check frequency output settings	S	Warning <sup>1)</sup>



Diagnostic number	Short text	Remedy instructions	Status signal [from the factory]	Diagnostic behavior [from the factory]
443	Pulse output	1. Check process 2. Check pulse output settings	S	Warning <sup>1)</sup>
444	Current input 1	1. Check process 2. Check current input settings	S	Warning <sup>1)</sup>
453	Flow override	Deactivate flow override	C	Warning
484	Simulation failure mode	Deactivate simulation	C	Alarm
485	Simulation measured variable	Deactivate simulation	C	Warning
486	Simulation current input 1	Deactivate simulation	C	Warning
491	Simulation current output 1 to 2	Deactivate simulation	C	Warning
492	Simulation frequency output	Deactivate simulation frequency output	C	Warning
493	Simulation pulse output	Deactivate simulation pulse output	C	Warning
494	Switch output simulation	Deactivate simulation switch output	C	Warning
495	Simulation diagnostic event	Deactivate simulation	C	Warning
538	Flow computer configuration incorrect	Check input value (pressure, temperature)	S	Warning
539	Flow computer configuration incorrect	1. Check input value (pressure, temperature) 2. Check allowed values of the medium properties	S	Alarm
540	Flow computer configuration incorrect	Check entered reference value using the document Operating Instructions	S	Warning
570	Inverted delta heat	Check configuration of mounting location (parameter Installation direction)	F	Alarm
<b>Diagnostic of process</b>				
801	Supply voltage too low	Increase supply voltage	S	Warning
803	Current loop	1. Check wiring 2. Change I/O module	F	Alarm
828	Ambient temperature too low	Increase ambient temperature of pre-amplifier	S	Warning <sup>1)</sup>
829	Ambient temperature too high	Reduce ambient temperature of pre-amplifier	S	Warning <sup>1)</sup>
832	Electronic temperature too high	Reduce ambient temperature	S	Warning <sup>1)</sup>
833	Electronic temperature too low	Increase ambient temperature	S	Warning <sup>1)</sup>
834	Process temperature too high	Reduce process temperature	S	Warning <sup>1)</sup>
835	Process temperature too low	Increase process temperature	S	Warning <sup>1)</sup>
841	Flow velocity too high	Reduce flow velocity	S	Warning <sup>1)</sup>
842	Process limit	Low flow cut off active! 1. Check low flow cut off configuration	S	Warning



Diagnostic number	Short text	Remedy instructions	Status signal [from the factory]	Diagnostic behavior [from the factory]
844	Sensor range exceeded	Reduce flow velocity	S	Warning <sup>1)</sup>
870	Measuring inaccuracy increased	1. Check process 2. Increase flow volume	S	Warning <sup>1)</sup>
871	Near steam saturation limit	Check process conditions	S	Warning <sup>1)</sup>
872	Wet steam detected	1. Check process 2. Check plant	S	Warning <sup>1)</sup>
873	Water detected	Check process (water in piping)	S	Warning <sup>1)</sup>
874	X% spec invalid	1. Check pressure, temperature 2. Check flow velocity 3. Check for flow fluctuation	S	Warning <sup>1)</sup>
882	Input signal	1. Check input configuration 2. Check external device or process conditions	F	Alarm
945	Sensor range exceeded	Check immediately process conditions (pressure-temperature rating)	S	Warning <sup>1)</sup>
946	Vibration detected	Check installation	S	Warning
947	Vibration exceeded	Check installation	S	Alarm <sup>1)</sup>
972	Degrees of superheat limit exceeded	1. Controll process conditions 2. Install pressure transmitter or enter correct fixed pressure value	S	Warning <sup>1)</sup>



1) Diagnostic behavior can be changed.

-  Operating conditions for displaying the following diagnostics information:
- Diagnostics information 871: The process temperature is less than 2K from the saturated steam line.
  - Diagnostics information 872: The measured steam quality has dropped below the configured limit value for the steam quality (limit value: "Expert" menu → System → Diagnostic handling → Diagnostic limits → Steam quality limit).
  - Diagnostics information 873: The process temperature is  $\leq 0$  °C.
  - Diagnostics information 874: Wet steam detection/measurement is outside the specified limits for the following process parameters: pressure, temperature, velocity.
  - Diagnostics information 972: The degree of superheat has exceeded the configured limit value (limit value: "Expert" menu → System → Diagnostic handling → Diagnostic limits → Degrees of superheat limit).

## 12.6 Pending diagnostic events

The **Diagnostics** menu allows the user to view the current diagnostic event and the previous diagnostic event separately.

-  To call up the measures to rectify a diagnostic event:
- Via local display →  140
  - Via "FieldCare" operating tool →  141

-  Other pending diagnostic events can be displayed in the **Diagnostic list** submenu →  147

**Navigation**  
 "Diagnostics" menu

**Structure of the submenu**

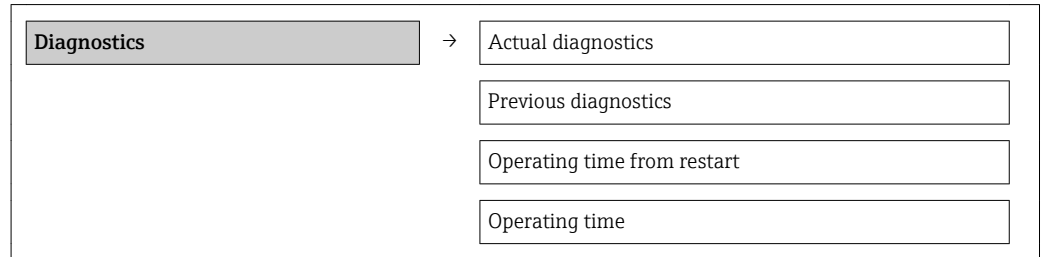

**Parameter overview with brief description**

Parameter	Prerequisite	Description	User interface
Actual diagnostics	A diagnostic event has occurred.	Shows the current occurred diagnostic event along with its diagnostic information.  ⓘ If two or more messages occur simultaneously, the message with the highest priority is shown on the display.	Symbol for diagnostic behavior, diagnostic code and short message.
Previous diagnostics	Two diagnostic events have already occurred.	Shows the diagnostic event that occurred prior to the current diagnostic event along with its diagnostic information.	Symbol for diagnostic behavior, diagnostic code and short message.
Operating time from restart	-	Shows the time the device has been in operation since the last device restart.	Days (d), hours (h), minutes (m) and seconds (s)
Operating time	-	Indicates how long the device has been in operation.	Days (d), hours (h), minutes (m) and seconds (s)

## 12.7 Diagnostic list

In the **Diagnostic list** submenu, up to 5 currently pending diagnostic events can be displayed along with the related diagnostic information. If more than 5 diagnostic events are pending, the events with the highest priority are shown on the display.

**Navigation path**

**Diagnostics** menu → **Diagnostic list** submenu

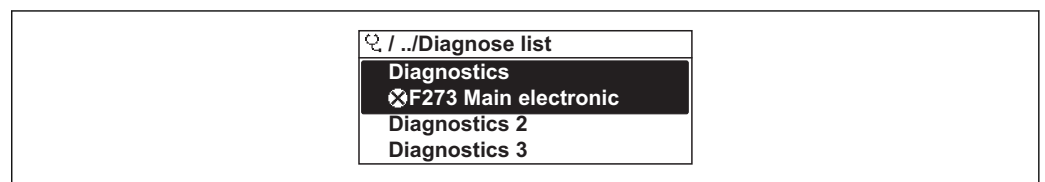

A0014006-EN

35 Taking the example of the local display

- i To call up the measures to rectify a diagnostic event:
  - Via local display → 140
  - Via "FieldCare" operating tool → 141

## 12.8 Event logbook

### 12.8.1 Event history

A chronological overview of the event messages that have occurred is provided in the **Events list** submenu.

#### Navigation path

"Diagnostics" menu → Event logbook → Events list

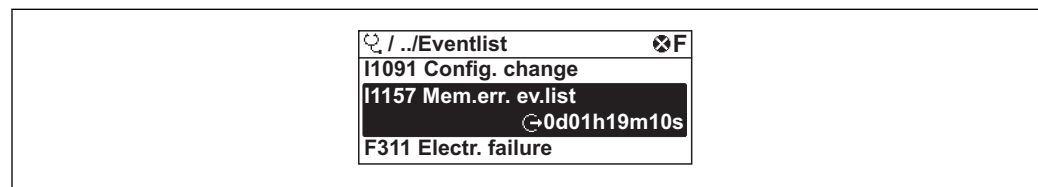



A0014008-EN



 36 Taking the example of the local display

A maximum of 20 event messages can be displayed in chronological order. If the advanced HistoROM function is enabled in the device (order option), up to 100 entries can be displayed.



The event history includes entries for:

- Diagnostic events →  143
- Information events →  148

In addition to the operation time of its occurrence, each event is also assigned a symbol that indicates whether the event has occurred or is ended:

- Diagnostic event
  - : Event has occurred
  - : Event has ended
- Information event
  - : Event has occurred

 To call up the measures to rectify a diagnostic event:

- Via local display →  140
- Via "FieldCare" operating tool →  141

 For filtering the displayed event messages →  148

### 12.8.2 Filtering the event logbook

Using the **Filter options** parameter, you can define which category of event messages is displayed in the **Events list** submenu.

#### Navigation path

"Diagnostics" menu → Event logbook → Filter options

#### Filter categories

- All
- Failure (F)
- Function check (C)
- Out of specification (S)
- Maintenance required (M)
- Information (I)

### 12.8.3 Overview of information events

Unlike a diagnostic event, an information event is displayed in the event logbook only and not in the diagnostic list.

Info number	Info name
I1000	----- (Device ok)
I1079	Sensor changed
I1089	Power on
I1090	Configuration reset
I1091	Configuration changed
I1092	Trend data deleted
I1110	Write protection switch changed
I1137	Electronic changed
I1151	History reset
I1154	Reset terminal voltage min/max
I1155	Reset electronic temperature
I1156	Memory error trend
I1157	Memory error event list
I1185	Display backup done
I1186	Restore via display done
I1187	Settings downloaded with display
I1188	Display data cleared
I1189	Backup compared
I1227	Sensor emergency mode activated
I1228	Sensor emergency mode failed
I1256	Display: access status changed
I1264	Safety sequence aborted
I1335	Firmware changed
I1397	Fieldbus: access status changed
I1398	CDI: access status changed
I1444	Device verification passed
I1445	Device verification failed
I1459	Failed: I/O module verification
I1461	Failed: Sensor verification
I1512	Download started
I1513	Download finished
I1514	Upload started
I1515	Upload finished
I1552	Failed: Main electronic verification
I1553	Failed: Pre-amplifier verification

## 12.9 Resetting the measuring device

Using the **Device reset** parameter it is possible to reset the entire device configuration or some of the configuration to a defined state.

**Navigation**

"Setup" menu → Advanced setup → Administration → Device reset

The screenshot shows a hierarchical menu structure. At the top is a grey button labeled 'Administration'. Below it is a grey button labeled 'Define access code'. Underneath that are two white input fields: 'Define access code' and 'Confirm access code'. At the bottom of the menu is a white button labeled 'Device reset'.

**Parameter overview with brief description**

Parameter	Description	Selection	Factory setting
Device reset	Reset the device configuration - either entirely or in part - to a defined state.	<ul style="list-style-type: none"> <li>■ Cancel</li> <li>■ To factory defaults</li> <li>■ To delivery settings</li> <li>■ Restart device</li> </ul>	Cancel

**12.9.1 Function scope of the "Device reset" parameter**

Options	Description
Cancel	No action is executed and the user exits the parameter.
To delivery settings	Every parameter for which a customer-specific default setting was ordered is reset to this customer-specific value. All other parameters are reset to the factory setting.
Restart device	The restart resets every parameter whose data are in the volatile memory (RAM) to the factory setting (e.g. measured value data). The device configuration remains unchanged.
History reset	Every parameter is reset to the factory setting.

**12.10 Device information**

The **Device information** submenu contains all the parameters that display different information for identifying the device.





**Navigation**

"Diagnostics" menu → Device information

The screenshot shows a grey button labeled 'Device information' at the top. Below it are three white input fields stacked vertically, labeled 'Device tag', 'Serial number', and 'Firmware version'.

Device name
Order code
Extended order code 1
Extended order code 2
Extended order code 3
ENP version
Device revision
Device ID
Device type
Manufacturer ID

**Parameter overview with brief description**



Parameter	Description	User interface	Factory setting
Device tag	Display the name for the measuring point.	Max. 32 characters such as letters, numbers or special characters (e.g. @, %, /)	Prowirl
Serial number	Shows the serial number of the measuring device.	A maximum of 11-digit character string comprising letters and numbers.	-
Firmware version	Shows the device firmware version installed.	Character string in the format xx.yy	01.02
Device name	Shows the name of the transmitter.  The name can be found on the nameplate of the transmitter.	Prowirl	-
Order code	Shows the device order code.  The order code can be found on the nameplate of the sensor and transmitter in the "Order code" field.	Character string composed of letters, numbers and certain punctuation marks (e.g. /).	-
Extended order code 1	Shows the 1st part of the extended order code.  The extended order code can also be found on the nameplate of the sensor and transmitter in the "Ext. ord. cd." field.	Character string	-
Extended order code 2	Shows the 2nd part of the extended order code.  The extended order code can also be found on the nameplate of the sensor and transmitter in the "Ext. ord. cd." field.	Character string	-

Parameter	Description	User interface	Factory setting
Extended order code 3	Shows the 3rd part of the extended order code.  The extended order code can also be found on the nameplate of the sensor and transmitter in the "Ext. ord. cd." field.	Character string	–
ENP version	Shows the version of the electronic nameplate (ENP).	Character string	2.02.00
Device revision	Shows the device revision with which the device is registered with the HART Communication Foundation.	2-digit hexadecimal number	0x03
Device ID	Enter device ID of external device.	6-digit hexadecimal number	–
Device type	Displays the device type with which the measuring device is registered with the HART Communication Foundation.	0 to 255	0x38
Manufacturer ID	Displays the manufacturer ID with which the measuring device is registered with the HART Communication Foundation.	0 to 255	0x11



## 12.11 Firmware history

Release date	Firmware version	Order code for "Firmware version"	Firmware changes	Documentation type	Documentation
10.2014	01.02.00	Option 74	<ul style="list-style-type: none"> <li>■ No need to restart device after parameter download</li> <li>■ Additional process variables:               <ul style="list-style-type: none"> <li>- Pressure</li> <li>- Degree of overheating</li> <li>- Specific volume</li> </ul> </li> <li>■ Process variables interconnectable with local display, the data logger (trend) and as HART device variable</li> <li>■ Verification progress is displayed (0-100%)</li> <li>■ New Wet Steam Measurement application package</li> <li>■ Operation in steam simplified</li> <li>■ More robust signal processing in event of low flow rates in wet steam</li> </ul>	Operating Instructions	BA01155D/06/EN/03.14
02.2014	01.01.00	Option 75	In accordance with HART 7 Specification	Operating Instructions	BA01155D/06/EN/02.14
09.2013	01.00.00	Option 76	Original firmware	Operating Instructions	BA01155D/06/EN/01.13

-  Flashing the firmware to the current version or to the previous version is possible via the service interface (CDI) .
-  For the compatibility of the firmware version with the previous version, the installed device description files and operating tools, observe the information about the device in the "Manufacturer's information" document.
-  The manufacturer's information is available:
  - In the Downloads area of the Endress+Hauser web site: [www.endress.com](http://www.endress.com) → Downloads
  - Specify the following details:
    - Text search: Manufacturer's information
    - Media type: Documentation – Technical Documentation

## 13 Maintenance

### 13.1 Maintenance tasks

No special maintenance work is required.

#### 13.1.1 Exterior cleaning

When cleaning the exterior of measuring devices, always use cleaning agents that do not attack the surface of the housing or the seals.

#### 13.1.2 Interior cleaning

##### NOTICE

**The use of unsuitable equipment or cleaning liquids can damage the transducer.**

- ▶ Do not use pigs to clean the pipe.

#### 13.1.3 Replacing seals

##### Replacing sensor seals

##### NOTICE

**Under normal circumstances, wetted seals must not be replaced.**

Replacement is necessary only in special circumstances, for example if aggressive or corrosive fluids are incompatible with the seal material.

- ▶ The time span between the individual replacement procedures depends on the fluid properties.
- ▶ Only Endress+Hauser sensor seals may be used: replacement seals

##### Replacing housing seals

The housing seals must be clean and undamaged when inserted into their grooves. Dry, clean or replace the seals if necessary.

##### NOTICE

**When the measuring device is used in a dusty atmosphere:**

- ▶ only use the associated Endress+Hauser housing seals.

### 13.2 Measuring and test equipment

Endress+Hauser offers a wide variety of measuring and test equipment, such as W@M or device tests.



Your Endress+Hauser Sales Center can provide detailed information on the services.



For a list of some of the measuring and test equipment, refer to the "Accessories" chapter of the "Technical Information" document for the device.

### 13.3 Endress+Hauser services

Endress+Hauser offers a wide variety of services for maintenance such as recalibration, maintenance service or device tests.



Your Endress+Hauser Sales Center can provide detailed information on the services.

## 14 Repair

### 14.1 General notes

#### Repair and conversion concept

The Endress+Hauser repair and conversion concept provides for the following:

- The measuring devices have a modular design.
- Spare parts are grouped into logical kits with the associated Installation Instructions.
- Repairs are carried out by Endress+Hauser Service or by correspondingly trained customers.
- Certified devices can be converted into other certified devices by Endress+Hauser Service or at the factory only.

#### Notes for repair and conversion

For repair and modification of a measuring device, observe the following notes:

- Use only original Endress+Hauser spare parts.
- Carry out the repair according to the Installation Instructions.
- Observe the applicable standards, federal/national regulations, Ex documentation (XA) and certificates.
- Document every repair and each conversion and enter them into the *W@M* life cycle management database.

### 14.2 Spare parts

Some interchangeable measuring device components are listed on an overview sign in the connection compartment cover.

The spare part overview sign contains the following information:

- A list of the most important spare parts for the measuring device, including their ordering information.
- The URL for the *W@M Device Viewer* ([www.endress.com/deviceviewer](http://www.endress.com/deviceviewer)):  
All the spare parts for the measuring device, along with the order code, are listed here and can be ordered. If available, users can also download the associated Installation Instructions.

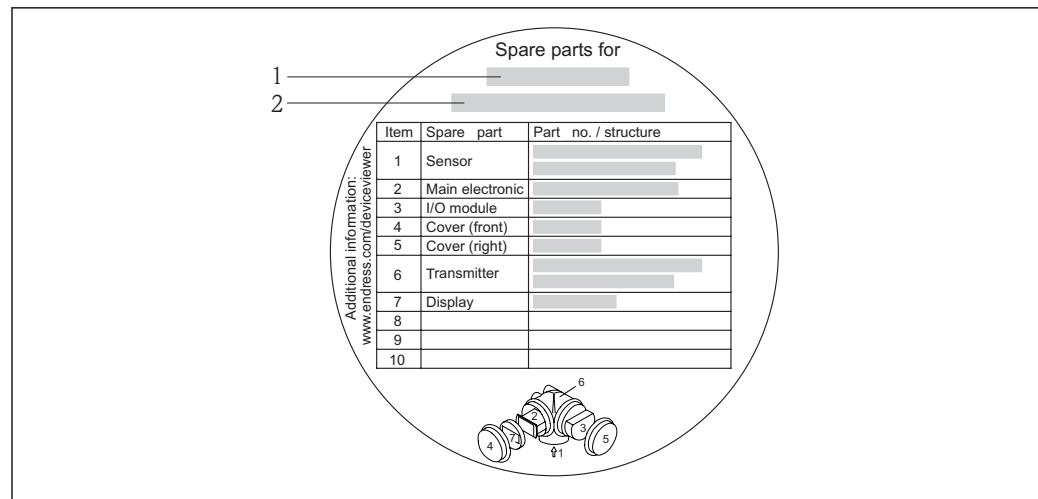

37 Example for "Spare part overview sign" in connection compartment cover

- 1 Measuring device name
- 2 Measuring device serial number

- i** Measuring device serial number:
- Is located on the device nameplate and the spare part overview sign.
  - Can be read out via the **Serial number** parameter in the **Device information** submenu .

## 14.3 Endress+Hauser services

Endress+Hauser offers a wide range of services.

- i** Your Endress+Hauser Sales Center can provide detailed information on the services.

## 14.4 Return

The measuring device must be returned if it is need of repair or a factory calibration, or if the wrong measuring device has been delivered or ordered. Legal specifications require Endress+Hauser, as an ISO-certified company, to follow certain procedures when handling products that are in contact with the medium.

To ensure safe, swift and professional device returns, please refer to the procedure and conditions for returning devices provided on the Endress+Hauser website at <http://www.endress.com/support/return-material>

## 14.5 Disposal

### 14.5.1 Removing the measuring device

1. Switch off the device.
2. **⚠ WARNING**

**Danger to persons from process conditions.**

- ▶ Beware of hazardous process conditions such as pressure in the measuring device, high temperatures or aggressive fluids.

Carry out the mounting and connection steps from the chapters "Mounting the measuring device" and "Connecting the measuring device" in the logically reverse sequence. Observe the safety instructions.

## 14.5.2 Disposing of the measuring device

### WARNING

**Danger to personnel and environment from fluids that are hazardous to health.**

- ▶ Ensure that the measuring device and all cavities are free of fluid residues that are hazardous to health or the environment, e.g. substances that have permeated into crevices or diffused through plastic.

Observe the following notes during disposal:





- Observe valid federal/national regulations.
- Ensure proper separation and reuse of the device components.



## 15 Accessories

Various accessories, which can be ordered with the device or subsequently from Endress+Hauser, are available for the device. Detailed information on the order code in question is available from your local Endress+Hauser sales center or on the product page of the Endress+Hauser website: [www.endress.com](http://www.endress.com).

### 15.1 Device-specific accessories

#### 15.1.1 For the transmitter







Accessories	Description
Prowirl 200 transmitter	<p>Transmitter for replacement or storage. Use the order code to define the following specifications:</p> <ul style="list-style-type: none"> <li>▪ Approvals</li> <li>▪ Output</li> <li>▪ Display / operation</li> <li>▪ Housing</li> <li>▪ Software</li> </ul> <p> For details, see Installation Instructions EA01056D</p>
Remote display FHX50	<p>FHX50 housing for accommodating a display module →  184.</p> <ul style="list-style-type: none"> <li>▪ FHX50 housing suitable for: <ul style="list-style-type: none"> <li>– SD02 display module (push buttons)</li> <li>– SD03 display module (touch control)</li> </ul> </li> <li>▪ Housing material: <ul style="list-style-type: none"> <li>– Plastic PBT</li> <li>– Stainless steel CF-3M (316L, 1.4404)</li> </ul> </li> <li>▪ Length of connecting cable: up to max. 60 m (196 ft) (cable lengths available for order: 5 m (16 ft), 10 m (32 ft), 20 m (65 ft), 30 m (98 ft))</li> </ul> <p>The measuring device can be ordered with the FHX50 housing and a display module. The following options must be selected in the separate order codes:</p> <ul style="list-style-type: none"> <li>▪ Order code for measuring device, feature 030: Option L or M "Prepared for FHX50 display"</li> <li>▪ Order code for FHX50 housing, feature 050 (device version): Option A "Prepared for FHX50 display"</li> <li>▪ Order code for FHX50 housing, depends on the desired display module in feature 020 (display, operation): <ul style="list-style-type: none"> <li>– Option C: for an SD02 display module (push buttons)</li> <li>– Option E: for an SD03 display module (touch control)</li> </ul> </li> </ul> <p>The FHX50 housing can also be ordered as a retrofit kit. The measuring device display module is used in the FHX50 housing. The following options must be selected in the order code for the FHX50 housing:</p> <ul style="list-style-type: none"> <li>▪ Feature 050 (measuring device version): option B "Not prepared for FHX50 display"</li> <li>▪ Feature 020 (display, operation): option A "None, existing displayed used"</li> </ul> <p> For details, see Special Documentation SD01007F</p> <p>(Order number: FHX50)</p>
Overvoltage protection for 2-wire devices	<p>Ideally, the overvoltage protection module should be ordered directly with the device. See product structure, characteristic 610 "Accessory mounted", option NA "Overvoltage protection". Separate order necessary only if retrofitting.</p> <ul style="list-style-type: none"> <li>▪ OVP10: For 1-channel devices (characteristic 020, option A):</li> <li>▪ OVP20: For 2-channel devices (characteristic 020, options B, C, E or G)</li> </ul> <p> For details, see Special Documentation SD01090F.</p>



Weather protection cover	Is used to protect the measuring device from the effects of the weather: e.g. rainwater, excess heating from direct sunlight or extreme cold in winter.  For details, see Special Documentation SD00333F
Connecting cable for remote version	<ul style="list-style-type: none"> <li>■ Connecting cable available in various lengths: <ul style="list-style-type: none"> <li>- 5 m (16 ft)</li> <li>- 10 m (32 ft)</li> <li>- 20 m (65 ft)</li> <li>- 30 m (98 ft)</li> </ul> </li> <li>■ Reinforced cables available on request.</li> </ul>  Standard length: 5 m (16 ft) Is always supplied if no other cable length has been ordered.
Post mounting kit	Post mounting kit for transmitter.  The post mounting kit can only be ordered together with a transmitter.  (Order number: DK8WM-B)

### 15.1.2 For the sensor



Accessories	Description
Flow conditioner	Is used to shorten the necessary inlet run. (Order number: DK7ST)

## 15.2 Communication-specific accessories



Accessories	Description
Commubox FXA195 HART	For intrinsically safe HART communication with FieldCare via the USB interface.  For details, see "Technical Information" TI00404F
Commubox FXA291	Connects Endress+Hauser field devices with a CDI interface (= Endress+Hauser Common Data Interface) and the USB port of a computer or laptop.  For details, see the "Technical Information" document TI405C/07
HART Loop Converter HMX50	Is used to evaluate and convert dynamic HART process variables to analog current signals or limit values.  For details, see "Technical Information" TI00429F and Operating Instructions BA00371F
Wireless HART adapter SWA70	Is used for the wireless connection of field devices. The WirelessHART adapter can be easily integrated into field devices and existing infrastructures, offers data protection and transmission safety and can be operated in parallel with other wireless networks with minimum cabling complexity.  For details, see Operating Instructions BA00061S
Fieldgate FXA320	Gateway for the remote monitoring of connected 4-20 mA measuring devices via a Web browser.  For details, see "Technical Information" TI00025S and Operating Instructions BA00053S
Fieldgate FXA520	Gateway for the remote diagnostics and remote configuration of connected HART measuring devices via a Web browser.  For details, see "Technical Information" TI00025S and Operating Instructions BA00051S

Field Xpert SFX350	Field Xpert SFX350 is a mobile computer for commissioning and maintenance. It enables efficient device configuration and diagnostics for HART and FOUNDATION Fieldbus devices in the <b>non-Ex area</b> .  For details, see Operating Instructions BA01202S
Field Xpert SFX370	Field Xpert SFX370 is a mobile computer for commissioning and maintenance. It enables efficient device configuration and diagnostics for HART and FOUNDATION Fieldbus devices in the <b>non-Ex area</b> and the <b>Ex area</b> .  For details, see Operating Instructions BA01202S



### 15.3 Service-specific accessories

Accessories	Description
Applicator	Software for selecting and sizing Endress+Hauser measuring devices: <ul style="list-style-type: none"> <li>Calculation of all the necessary data for identifying the optimum flowmeter: e.g. nominal diameter, pressure loss, accuracy or process connections.</li> <li>Graphic illustration of the calculation results</li> </ul> Administration, documentation and access to all project-related data and parameters throughout the entire life cycle of a project. Applicator is available: <ul style="list-style-type: none"> <li>Via the Internet: <a href="https://wapps.endress.com/applicator">https://wapps.endress.com/applicator</a></li> <li>On CD-ROM for local PC installation.</li> </ul>
W@M	Life cycle management for your plant W@M supports you with a wide range of software applications over the entire process: from planning and procurement, to the installation, commissioning and operation of the measuring devices. All the relevant device information, such as the device status, spare parts and device-specific documentation, is available for every device over the entire life cycle. The application already contains the data of your Endress+Hauser device. Endress+Hauser also takes care of maintaining and updating the data records. W@M is available: <ul style="list-style-type: none"> <li>Via the Internet: <a href="http://www.endress.com/lifecyclemanagement">www.endress.com/lifecyclemanagement</a></li> <li>On CD-ROM for local PC installation.</li> </ul>
FieldCare	FDT-based plant asset management tool from Endress+Hauser. It can configure all smart field units in your system and helps you manage them. By using the status information, it is also a simple but effective way of checking their status and condition.  For details, see Operating Instructions BA00027S and BA00059S
DeviceCare	Tool for connecting and configuring Endress+Hauser field devices.  For details, see Innovation brochure IN01047S

### 15.4 System components

Accessories	Description
Memograph M graphic display recorder	The Memograph M graphic display recorder provides information on all relevant measured variables. Measured values are recorded correctly, limit values are monitored and measuring points analyzed. The data are stored in the 256 MB internal memory and also on a SD card or USB stick.  For details, see "Technical Information" TI00133R and Operating Instructions BA00247R
RN221N	Active barrier with power supply for safe separation of 4-20 mA standard signal circuits. Offers bidirectional HART transmission.  For details, see "Technical Information" TI00073R and Operating Instructions BA00202R



RNS221	<p>Supply unit for powering two 2-wire measuring devices solely in the non-Ex area. Bidirectional communication is possible via the HART communication jacks.</p> <p> For details, see "Technical Information" TI00081R and Brief Operating Instructions KA00110R</p>
Cerabar M	<p>The pressure transmitter for measuring the absolute and gauge pressure of gases, steam and liquids. It can be used to read in the operating pressure value.</p> <p> For details, see "Technical Information" TI00426P, TI00436P and Operating Instructions BA00200P, BA00382P</p>
Cerabar S	<p>The pressure transmitter for measuring the absolute and gauge pressure of gases, steam and liquids. It can be used to read in the operating pressure value.</p> <p> For details, see "Technical Information" TI00383P and Operating Instructions BA00271P</p>

## 16 Technical data

### 16.1 Application

Depending on the version ordered, the measuring device can also measure potentially explosive, flammable, poisonous and oxidizing media.

To ensure that the device remains in proper operating condition for its service life, use the measuring device only for media against which the process-wetted materials are adequately resistant.

### 16.2 Function and system design

---

Measuring principle	Vortex meters work on the principle of the <i>Karman vortex street</i> .
---------------------	--

---

Measuring system	<p>The device consists of a transmitter and a sensor.</p> <p>Two device versions are available:</p> <ul style="list-style-type: none"> <li>■ Compact version – transmitter and sensor form a mechanical unit.</li> <li>■ Remote version - transmitter and sensor are mounted in separate locations.</li> </ul> <p>For information on the structure of the device →  11</p>
------------------	---

### 16.3 Input

---

Measured variable	<p><b>Direct measured variables</b></p> <p>Order code for "Sensor version":</p> <ul style="list-style-type: none"> <li>■ Option 4 "Volume flow, Alloy 718" and</li> <li>■ Option 5 "Volume flow, titanium": Volume flow</li> </ul> <p>Order code for "Sensor version":</p> <p>Option 6 "Mass flow, Alloy 718":</p> <ul style="list-style-type: none"> <li>- Volume flow</li> <li>- Temperature</li> </ul> <p><b>Calculated measured variables</b></p> <p>Order code for "Sensor version":</p> <ul style="list-style-type: none"> <li>■ Option 4 "Volume flow, Alloy 718" and</li> <li>■ Option 5 "Volume flow, titanium":             <ul style="list-style-type: none"> <li>- In the case of constant process conditions: Mass flow <sup>1)</sup> or Corrected volume flow</li> <li>- The totalized values for Volume flow, Mass flow, or Corrected volume flow</li> </ul> </li> </ul> <p>Order code for "Sensor version":</p> <p>Option 6 "Mass flow, Alloy 718":</p> <ul style="list-style-type: none"> <li>- Corrected volume flow</li> <li>- Mass flow</li> <li>- Calculated saturated steam pressure</li> <li>- Energy flow</li> </ul>
-------------------	--

---

1) A fixed density must be entered for calculating the mass flow (Setup menu → Advanced setup submenu → External compensation submenu → Fixed density parameter).

- Heat flow difference
- Specific volume
- Degrees of superheat

#### Calculation of the measured variables

The meter electronics system of the Prowirl 200 unit with the order code "Sensor version", option 3 "Mass flow, Alloy 718" has a flow computer. This computer can calculate the following secondary measured variables directly from the primary measured variables recorded using the pressure value (entered or external) and/or temperature value (measured or entered).

#### Mass flow and corrected volume flow

Medium	Fluid	Standards	Explanation
Steam <sup>1)</sup>	-	IAPWS-IF97/ ASME	If integrated temperature measurement is provided and the process pressure is fixed, or if the pressure is read in via the current input/HART
Gas	Single gas	NEL40	If the process pressure is fixed, or if the pressure is read in via the current input/HART
	Gas mixture	NEL40	
	Air	NEL40	
	Natural gas	ISO 12213-2	Contains AGA8-DC92 If the process pressure is fixed, or if the pressure is read in via the current input/HART
		AGA NX-19	If the process pressure is fixed, or if the pressure is read in via the current input/HART
		ISO 12213-3	Contains SGERG-88, AGA8 Gross Method 1 If the process pressure is fixed, or if the pressure is read in via the current input/HART
Other gases	Linear equation	Ideal gases If the process pressure is fixed, or if the pressure is read in via the current input/HART	
Liquids	Water	IAPWS-IF97/ ASME	
	Liquefied gas	Tables	Propane and butane mixture
	Other liquid	Linear equation	Ideal liquids

- 1) The Prowirl 200 is able to calculate the volume flow, and other measured variables derived from the volume flow, across all steam types with full compensation using the pressure and temperature. For information on setting the device behavior, see the "Perform external compensation" section →  112

#### Mass flow calculation

Volume flow × operating density

- Operating density for saturated steam, water and other liquids: depends on the temperature
- Operating density for superheated steam and all other gases: depends on the temperature and process pressure

#### Corrected volume flow calculation

(Volume flow × operating density)/reference density

- Operating density for water and other liquids: depends on the temperature
- Operating density for all other gases: depends on the temperature and process pressure

*Energy flow*

Medium	Fluid	Standards	Explanation	Heat/energy option
Steam <sup>1)</sup>	–	IAPWS-IF97/ASME	If the process pressure is fixed, or if the pressure is read in via the current input/HART	Heat Gross calorific value <sup>2)</sup> in relation to mass Net calorific value <sup>3)</sup> in relation to mass Gross calorific value <sup>2)</sup> in relation to corrected volume Net calorific value <sup>3)</sup> in relation to corrected volume
Gas	Single gas	ISO 6976	Contains GPA 2172 If the process pressure is fixed, or if the pressure is read in via the current input/HART	
	Gas mixture	ISO 6976	Contains GPA 2172 If the process pressure is fixed, or if the pressure is read in via the current input/HART	
	Air	NEL40	If the process pressure is fixed, or if the pressure is read in via the current input/HART	
	Natural gas	ISO 6976	Contains GPA 2172 If the process pressure is fixed, or if the pressure is read in via the current input/HART	
AGA 5				
Liquids	Water	IAPWS-IF97/ASME		
	Liquefied gas	ISO 6976	Contains GPA 2172	
	Other liquid	Linear equation		

- 1) The Prowirl 200 is able to calculate the volume flow, and other measured variables derived from the volume flow, across all steam types with full compensation using the pressure and temperature. For information on setting the device behavior, see the "Perform external compensation" section → 112
- 2) Gross calorific value: combustion energy + condensation energy of the flue gas (gross calorific value > net calorific value)
- 3) Net calorific value: only combustion energy



*Mass flow and energy flow calculation*

**NOTICE**

**The process pressure (p) in the process pipe is required to calculate the process variables and the limit values of the measuring range.**

- ▶ In the case of the HART device, the process pressure can be read in from an external transmitter (e.g. Cerabar-M) via the 4 to 20mA current input or via HART or entered as a fixed value in the **External compensation** submenu (→ 112).

Steam is calculated based on the following factors:

- The measuring device calculates the density with full compensation using the pressure and temperature measured variables.
- Assuming superheated steam conditions the measuring device calculates until the saturation point is reached. The diagnostic behavior of the diagnostic message **△S871 Near steam saturation limit** is set to **Off** by default (ex works) →  143. This diagnostic behavior can optionally be redefined as an alarm or a warning →  142. Then the diagnostic message **△S871 Near steam saturation limit** is triggered at 2 K above saturation.
- The smaller of the following two pressure values is always used to calculate the density:
  - The measured pressure which is either entered as the Fixed process pressure (→  71) ≠ 0 bar abs. or read in via the current input/HART
  - The saturated steam pressure which is determined from the saturated steam line (IAPWS-IF97/ASME)
- If the fixed process pressure = 0 bar abs. the measuring device only calculates on the saturated steam curve using temperature compensation.

 For detailed information on performing external compensation: →  112

#### Calculated value

The unit calculates the mass flow, heat flow, energy flow, density and specific enthalpy from the measured volume flow and the measured temperature and/or the pressure based on international standard IAPWS-IF97/ASME.

Formulae for calculation:

- Mass flow:  $m = q \cdot \rho (T, p)$
- Heat quantity:  $E = q \cdot \rho (T, p) \cdot h_D (T, p)$

$m$  = Mass flow

$E$  = Heat quantity

$q$  = Volume flow (measured)

$h_D$  = Specific enthalpy

$T$  = Process temperature (measured)

$p$  = Process pressure

$\rho$  = Density<sup>2)</sup>

#### Pre-programmed gases

The following gases are pre-programmed in the flow computer:

Hydrogen <sup>1)</sup>	Helium 4	Neon	Argon
Krypton	Xenon	Nitrogen	Oxygen
Chlorine	Ammonia	Carbon monoxide <sup>1)</sup>	Carbon dioxide
Sulfur dioxide	Hydrogen sulfide <sup>1)</sup>	Hydrogen chloride	Methane <sup>1)</sup>
Ethane <sup>1)</sup>	Propane <sup>1)</sup>	Butane <sup>1)</sup>	Ethylene (ethene) <sup>1)</sup>
Vinyl chloride	Mixtures of up to 8 components of these gases <sup>1)</sup>		

- 1) The energy flow is calculated as per ISO 6976 (contains GPA 2172) or AGA5 - in relation to the net calorific value or gross calorific value .

2) From steam data as per IAPWS-IF97 (ASME), for the measured temperature and the specified pressure

*Energy flow calculation*

Volume flow × operating density × specific enthalpy

- Operating density for saturated steam and water: depends on the temperature
- Operating density for superheated steam, natural gas ISO 6976 (contains GPA 2172), natural gas AGA5: depends on the temperature and pressure

*Heat flow difference*

- Between saturated steam upstream from a heat exchanger and condensate downstream from the heat exchanger (second temperature read in via current input/HART) in accordance with IAPWS-IF97/ASME →  24.
- Between warm and cold water (second temperature read in via current input/HART) in accordance with IAPWS-IF97/ASME.

*Vapor pressure and steam temperature*

The measuring device can perform the following in saturated steam measurements between the feed line and return line of any heating liquid (second temperature read in via current input/HART and Cp value entered):

- Calculate the saturation pressure of the steam from the measured temperature and output the value in accordance with IAPWS-IF97/ASME.
- Calculate the saturation temperature of the steam from the specified pressure and output the value in accordance with IAPWS-IF97/ASME.

Measuring range

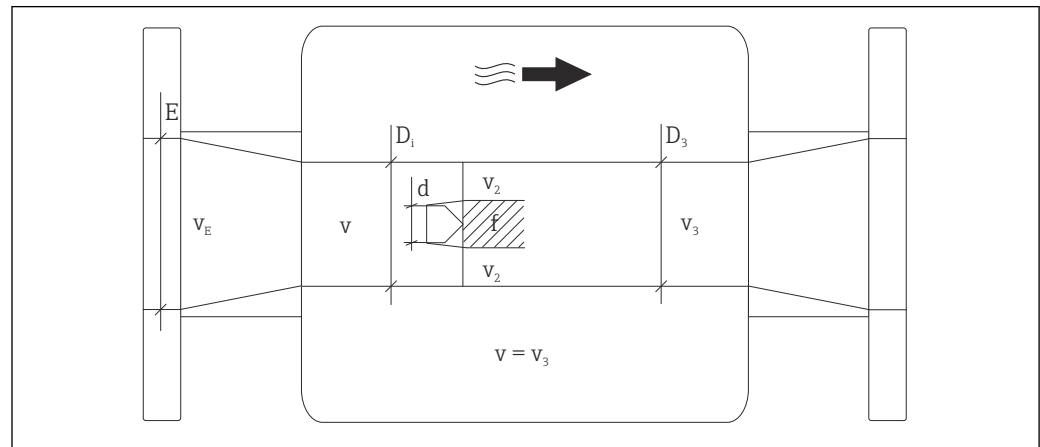

The measuring range depends on the fluid and nominal diameter.

**Flow velocity**



A0027507

- E* DN diameter
- v<sub>E</sub>* Velocity in process pipe
- v* Bluff body approaching flow velocity (*Re* is based on this)
- v<sub>2</sub>* Maximum velocity (applies only to oxygen) *v<sub>2</sub> = v<sub>max</sub>*
- v<sub>3</sub>* Velocity when leaving the measuring device
- D<sub>i</sub>* Internal diameter *D<sub>i</sub> = D<sub>3</sub>*
- D<sub>3</sub>* Internal diameter *D<sub>3</sub> = D<sub>i</sub>*
- d* Width of bluff body
- f* Vortex shedding frequency

 The Applicator can be used for calculation purposes. →  160

Maximum volume flow	Strouhal number	Reynolds number
$Q_{\max(G)} = v_{\max} \cdot \frac{\pi}{4} D_i^2$ <p style="text-align: right; font-size: small;">A0027504</p>	$Sr = \frac{f \cdot d}{v}$ <p style="text-align: right; font-size: small;">A0027505</p>	$Re = \frac{\rho \cdot v \cdot D_i}{\mu}$ <p style="text-align: right; font-size: small;">A0027506</p>

**Lower range value**

Depends on the density of the medium and the Reynolds number ( $Re_{\min} = 5\,000$ ,  $Re_{\text{linear}} = 20\,000$ ). The Reynolds number is dimensionless and indicates the ratio of the inertia force of a fluid to its viscous force. It is used to characterize the flow. The Reynolds number is calculated as follows:

$Re = \frac{4 \cdot Q \text{ [m}^3\text{/s]} \cdot \rho \text{ [kg/m}^3\text{]}}{\pi \cdot di \text{ [m]} \cdot \mu \text{ [Pa}\cdot\text{s]}}$	$Re = \frac{4 \cdot Q \text{ [ft}^3\text{/s]} \cdot \rho \text{ [lb/ft}^3\text{]}}{\pi \cdot di \text{ [ft]} \cdot \mu \text{ [0.001 cP]}}$
---	---

A0003794

*Re = Reynolds number; Q = flow; di = internal diameter; μ = dynamic viscosity, ρ = density*

$\text{DN 15...150} \rightarrow v_{\min.} = \frac{6}{\sqrt{\rho \text{ [kg/m}^3\text{]}}} \text{ [m/s]}$
$\text{DN } \frac{1}{2}\text{...6"} \rightarrow v_{\min.} = \frac{4.92}{\sqrt{\rho \text{ [lb/ft}^3\text{]}}} \text{ [ft/s]}$

A0020557

**Upper range value**

**Liquids:**

The upper range value must be calculated as follows:

$v_{\max} = 9 \text{ m/s (30 ft/s)}$  and  $v_{\max} = 350/\sqrt{\rho} \text{ m/s (130}/\sqrt{\rho} \text{ ft/s)}$

- ▶ Use the lower value.

*Gas/steam:*

Nominal diameter	$v_{\max}$
Standard device: DN 15 (½")	46 m/s (151 ft/s) and $350/\sqrt{\rho} \text{ m/s (130}/\sqrt{\rho} \text{ ft/s)}$ (Use the lower value.)
Standard device: DN 25 (1"), DN 40 (1½")	75 m/s (246 ft/s) and $350/\sqrt{\rho} \text{ m/s (130}/\sqrt{\rho} \text{ ft/s)}$ (Use the lower value.)
Standard device: DN 50 to 150 (2 to 8")	120 m/s (394 ft/s) and $350/\sqrt{\rho} \text{ m/s (130}/\sqrt{\rho} \text{ ft/s)}$ (Use the lower value.) Calibrated range: up to 75 m/s (246 ft/s)

For information on the Applicator → 160

Operable flow range      Up to 45: 1 (ratio between lower and upper range value)

**Input signal**

**Current input**



Current input	4-20 mA (passive)
Resolution	1 μA

<b>Voltage drop</b>	Typically: 2.2 to 3 V for 3.6 to 22 mA
<b>Maximum voltage</b>	≤35 V
<b>Possible input variables</b>	<ul style="list-style-type: none"> <li>■ Pressure</li> <li>■ Temperature</li> <li>■ Density</li> </ul>

**External measured values**

To increase the accuracy of certain measured variables or to calculate the corrected volume flow, the automation system can continuously write different measured values to the measuring device:

- Operating pressure to increase accuracy (Endress+Hauser recommends the use of a pressure measuring device for absolute pressure, e.g. Cerabar M or Cerabar S)
- Medium temperature to increase accuracy (e.g. iTEMP)
- Reference density for calculating the corrected volume flow

-  ■ Various pressure transmitters can be ordered from Endress+Hauser: see "Accessories" section →  160
  - Please comply with the special mounting instructions when using pressure transmitters →  24

It is recommended to read in external measured values to calculate the following measured variables:

- Energy flow
- Mass flow
- Corrected volume flow

*Current input*

The measured values are written from the automation system to the measuring device via the current input →  167.

*HART protocol*

The measured values are written from the automation system to the measuring device via the HART protocol. The pressure transmitter must support the following protocol-specific functions:

- HART protocol
- Burst mode

## 16.4 Output

Output signal

**Current output**

<b>Current output 1</b>	4-20 mA HART (passive)
<b>Current output 2</b>	4-20 mA (passive)
<b>Resolution</b>	< 1 µA
<b>Damping</b>	Adjustable: 0.0 to 999.9 s
<b>Assignable measured variables</b>	<ul style="list-style-type: none"> <li>■ Volume flow</li> <li>■ Corrected volume flow</li> <li>■ Mass flow</li> <li>■ Flow velocity</li> <li>■ Temperature</li> <li>■ Calculated saturated steam pressure</li> <li>■ Total mass flow</li> <li>■ Energy flow</li> <li>■ Heat flow difference</li> </ul>



**Pulse/frequency/switch output**

<b>Function</b>	Can be set to pulse, frequency or switch output
<b>Version</b>	Passive, open collector
<b>Maximum input values</b>	<ul style="list-style-type: none"> <li>▪ DC 35 V</li> <li>▪ 50 mA</li> </ul>
<b>Voltage drop</b>	<ul style="list-style-type: none"> <li>▪ For ≤ 2 mA: 2 V</li> <li>▪ For 10 mA: 8 V</li> </ul>
<b>Residual current</b>	≤ 0.05 mA
<b>Pulse output</b>	
<b>Pulse width</b>	Adjustable: 5 to 2 000 ms
<b>Maximum pulse rate</b>	100 Impulse/s
<b>Pulse value</b>	Adjustable
<b>Assignable measured variables</b>	<ul style="list-style-type: none"> <li>▪ Total volume flow</li> <li>▪ Total corrected volume flow</li> <li>▪ Total mass flow</li> <li>▪ Total energy flow</li> <li>▪ Total heat flow difference</li> </ul>
<b>Frequency output</b>	
<b>Output frequency</b>	Adjustable: 0 to 1 000 Hz
<b>Damping</b>	Adjustable: 0 to 999 s
<b>Pulse/pause ratio</b>	1:1
<b>Assignable measured variables</b>	<ul style="list-style-type: none"> <li>▪ Volume flow</li> <li>▪ Corrected volume flow</li> <li>▪ Mass flow</li> <li>▪ Flow velocity</li> <li>▪ Temperature</li> <li>▪ Calculated saturated steam pressure</li> <li>▪ Steam quality</li> <li>▪ Total mass flow</li> <li>▪ Energy flow</li> <li>▪ Heat flow difference</li> </ul>
<b>Switch output</b>	
<b>Switching behavior</b>	Binary, conductive or non-conductive
<b>Switching delay</b>	Adjustable: 0 to 100 s
<b>Number of switching cycles</b>	Unlimited
<b>Assignable functions</b>	<ul style="list-style-type: none"> <li>▪ Off</li> <li>▪ On</li> <li>▪ Diagnostic behavior</li> <li>▪ Limit value <ul style="list-style-type: none"> <li>- Volume flow</li> <li>- Corrected volume flow</li> <li>- Mass flow</li> <li>- Flow velocity</li> <li>- Temperature</li> <li>- Calculated saturated steam pressure</li> <li>- Steam quality</li> <li>- Total mass flow</li> <li>- Energy flow</li> <li>- Heat flow difference</li> <li>- Reynolds number</li> <li>- Totalizer 1-3</li> </ul> </li> <li>▪ Status</li> <li>▪ Status of low flow cut off</li> </ul>

Signal on alarm

Depending on the interface, failure information is displayed as follows:

### Current output

#### HART

Device diagnostics	Device condition can be read out via HART Command 48
--------------------	--

### Pulse/frequency/switch output

Pulse output	
Failure mode	No pulses
Frequency output	
Failure mode	Choose from: <ul style="list-style-type: none"> <li>■ Actual value</li> <li>■ 0 Hz</li> <li>■ Defined value: 0 to 1 250 Hz</li> </ul>
Switch output	
Failure mode	Choose from: <ul style="list-style-type: none"> <li>■ Current status</li> <li>■ Open</li> <li>■ Closed</li> </ul>

### Local display

Plain text display	With information on cause and remedial measures
Backlight	Additionally for device version with SD03 local display: red lighting indicates a device error.

 Status signal as per NAMUR recommendation NE 107

### Operating tool

- Via digital communication:
  - HART protocol
- Via service interface

Plain text display	With information on cause and remedial measures
--------------------	---

Load →  33

Low flow cut off      The switch points for low flow cut off are user-selectable.

Galvanic isolation      All outputs are galvanically isolated from one another.

### Protocol-specific data

#### HART

- For information on the device description files
- For information on the dynamic variables and measured variables (HART device variables)

## 16.5 Power supply

Terminal assignment →  31

Supply voltage

### Transmitter

An external power supply is required for each output.

The following supply voltage values apply for the outputs available:

*Supply voltage for a compact version without a local display <sup>1)</sup>*

Order code for "Output"	Minimum terminal voltage <sup>2)</sup>	Maximum terminal voltage
Option A: 4-20 mA HART	≥ DC 12 V	DC 35 V
Option B: 4-20 mA HART, pulse/frequency/switch output	≥ DC 12 V	DC 35 V
Option C: 4-20 mA HART + 4-20 mA analog	≥ DC 12 V	DC 30 V
Option D: 4-20 mA HART, pulse/frequency/switch output, 4-20 mA current input <sup>3)</sup>	≥ DC 12 V	DC 35 V

- 1) In event of external supply voltage of the power supply unit with load
- 2) The minimum terminal voltage increases if local operation is used: see the following table
- 3) Voltage drop 2.2 to 3 V for 3.59 to 22 mA

### Increase in minimum terminal voltage

Local operation	Increase in minimum terminal voltage
Order code for "Display; Operation", option C: Local operation SDO2	+ DC 1 V
Order code for "Display; Operation", option E: Local operation SDO3 with lighting (backlighting <b>not used</b> )	+ DC 1 V
Order code for "Display; Operation", option E: Local operation SDO3 with lighting (backlighting <b>used</b> )	+ DC 3 V

Power consumption

### Transmitter

Order code for "Output"	Maximum power consumption
Option A: 4-20 mA HART	770 mW
Option B: 4-20 mA HART, pulse/frequency/switch output	<ul style="list-style-type: none"> <li>■ Operation with output 1: 770 mW</li> <li>■ Operation with output 1 and 2: 2 770 mW</li> </ul>
Option C: 4-20 mA HART + 4-20 mA analog	<ul style="list-style-type: none"> <li>■ Operation with output 1: 660 mW</li> <li>■ Operation with output 1 and 2: 1 320 mW</li> </ul>
Option D: 4-20 mA HART, pulse/frequency/switch output, 4-20 mA current input	<ul style="list-style-type: none"> <li>■ Operation with output 1: 770 mW</li> <li>■ Operation with output 1 and 2: 2 770 mW</li> <li>■ Operation with output 1 and input: 840 mW</li> <li>■ Operation with output 1, 2 and input: 2 840 mW</li> </ul>

Current consumption

**Current output**

For every 4-20 mA or 4-20 mA HART current output: 3.6 to 22.5 mA

 If the option **Defined value** is selected in the **Failure mode** parameter :  
3.59 to 22.5 mA

**Current input**

3.59 to 22.5 mA

 Internal current limiting: max. 26 mA

Power supply failure

- Totalizers stop at the last value measured.
- Configuration is retained in the device memory (HistoROM).
- Error messages (incl. total operated hours) are stored.

Electrical connection

→  34

Terminals

- For device version without integrated overvoltage protection: plug-in spring terminals for wire cross-sections 0.5 to 2.5 mm<sup>2</sup> (20 to 14 AWG)
- For device version with integrated overvoltage protection: screw terminals for wire cross-sections 0.2 to 2.5 mm<sup>2</sup> (24 to 14 AWG)

Cable entries

- Cable gland: M20 × 1.5 with cable  $\phi$ 6 to 12 mm (0.24 to 0.47 in)
- Thread for cable entry:
  - NPT 1/2"
  - G 1/2"

Cable specification

→  29

Overvoltage protection

The device can be ordered with integrated overvoltage protection for diverse approvals: *Order code for "Accessory mounted", option NA "Overvoltage protection"*

<b>Input voltage range</b>	Values correspond to supply voltage specifications <sup>1)</sup>
<b>Resistance per channel</b>	2 · 0.5 $\Omega$ max
<b>DC sparkover voltage</b>	400 to 700 V
<b>Trip surge voltage</b>	< 800 V
<b>Capacitance at 1 MHz</b>	< 1.5 pF
<b>Nominal discharge current (8/20 <math>\mu</math>s)</b>	10 kA
<b>Temperature range</b>	-40 to +85 °C (-40 to +185 °F)

1) The voltage is reduced by the amount of the internal resistance  $I_{min} \cdot R_i$

 Depending on the temperature class, restrictions apply to the ambient temperature for device versions with overvoltage protection .

 For detailed information on the temperature tables, see the separate document entitled "Safety Instructions" (XA) for the device.

## 16.6 Performance characteristics

Reference operating conditions

- Error limits following ISO/DIN 11631
- +20 to +30 °C (+68 to +86 °F)
- 2 to 4 bar (29 to 58 psi)
- Calibration system traceable to national standards
- Calibration with the process connection corresponding to the particular standard

 To obtain measured errors, use the *Applicator* sizing tool →  160 →  187

Maximum measured error

### Base accuracy

o.r. = of reading, Re = Reynolds number

### Volume flow

The measured error for the volume flow is as follows depending on the Reynolds number and the compressibility of the medium under measurement:

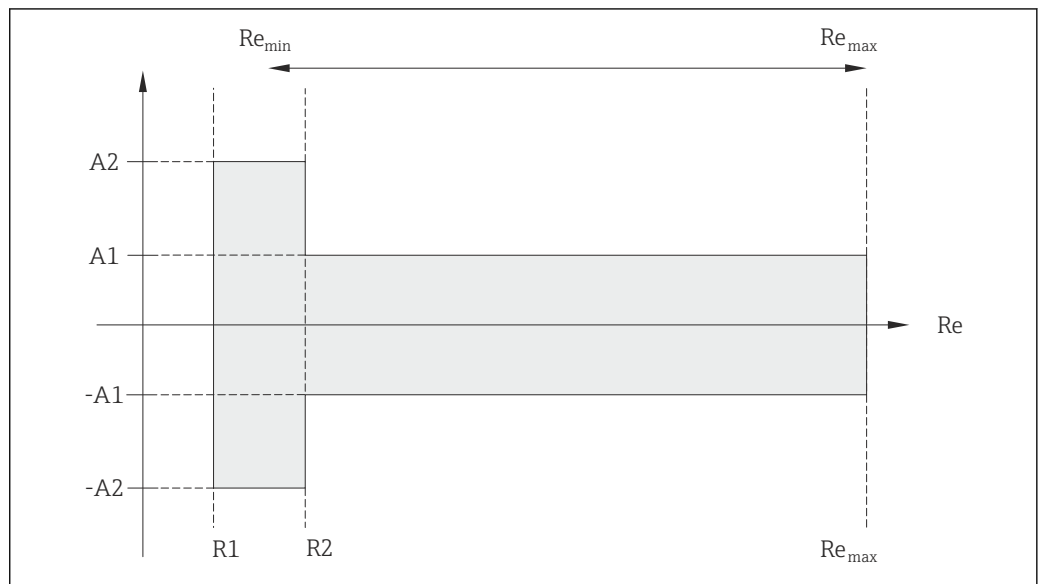

A0019703

Deviation of volume flow value (absolute) from the reading			
Medium type		Incompressible	Compressible <sup>1)</sup>
Re range	Measured value deviation	Standard	Standard
R1 to R2	A2	< 10 %	< 10 %
R2 to Re <sub>max</sub>	A1	< 0.75 %	< 1.0 %

1) Accuracy specifications valid up to 75 m/s (246 ft/s)

Reynolds numbers	Incompressible	Compressible
	Standard	Standard
R1	5 000	
R2	20 000	

**Temperature**

- Saturated steam and liquids at room temperature if  $T > 100\text{ °C}$  (212 °F) applies: < 1 °C (1.8 °F)
- Gas: < 1 % o.r. [K]
- Volume flow: > 70 m/s (230 ft/s): 2% o.r.

Rise time 50 % (stirred under water, following IEC 60751): 8 s

**Mass flow (saturated steam)**

- Flow velocities 20 to 50 m/s (66 to 164 ft/s),  $T > 150\text{ °C}$  (302 °F) or (423 K)
  - Re > 20 000: < 1.7 % o.r.
  - Re between 5 000 to 20 000: < 10 % o.r.
- Flow velocities 10 to 70 m/s (33 to 210 ft/s),  $T > 140\text{ °C}$  (284 °F) or (413 K)
  - Re > 20 000: < 2 % o.r.
  - Re between 5 000 to 20 000: < 10 % o.r.
- Flow velocities < 10 m/s (33 ft/s): Re > 5000: 5%

 The use of a Cerabar S is required for the measured errors listed in the following section. The measured error used to calculate the error in the measured pressure is 0.15%.

**Mass flow of superheated steam and gas (single gas, gas mixture, air: NEL40; natural gas: ISO 12213-2 contains AGA8-DC92, AGA NX-19, ISO 12213-3 contains SGERG-88 and AGA8 Gross Method 1)**

- Re > 20 000 and process pressure < 40 bar abs. (580 psi abs.): 1.7 % o.r.
- Re between 5 000 to 20 000 and process pressure < 40 bar abs. (580 psi abs.): 10 % o.r.
- Re > 20 000 and process pressure < 120 bar abs. (1 740 psi abs.): 2.6 % o.r.
- Re between 5 000 to 20 000 and process pressure < 120 bar abs. (1 740 psi abs.): 10 % o.r.

abs. = absolute

**Mass flow (water)**

- Re 20 000: < 0.85 % o.r.
- Re between 5 000 to 20 000: < 10 % o.r.

**Mass flow (user-defined liquids)**

To specify the system accuracy, Endress+Hauser requires information about the type of liquid and its operating temperature or information in table form about the dependency between the liquid density and the temperature.

*Example*

- Acetone is to be measured at fluid temperatures from +70 to +90 °C (+158 to +194 °F).
- For this purpose, the **Reference temperature** parameter (7703) (here 80 °C (176 °F)), **Reference density** parameter (7700) (here 720.00 kg/m<sup>3</sup>) and **Linear expansion coefficient** parameter (7621) (here  $18.0298 \times 10^{-4}\text{ 1/°C}$ ) must be entered in the transmitter.
- The overall system uncertainty, which is less than 0.9 % for the example above, is comprised of the following measurement uncertainties: uncertainty of volume flow measurement, uncertainty of temperature measurement, uncertainty of the density-temperature correlation used (incl. the resulting uncertainty of density).

**Mass flow (other media)**

Depends on the selected fluid and the pressure value, which is specified in the parameters. Individual error analysis must be performed.

**Diameter mismatch correction**

Prowirl 200 can correct shifts in the calibration factor which are caused, for example, by diameter mismatch between the device flange (e.g. ASME B16.5/Sch. 80, DN 50 (2")) and the mating pipe (e.g. ASME B16.5/Sch. 40, DN 50 (2")). Only apply diameter mismatch correction within the following limit values (listed below) for which test measurements have also been performed.

**Flange connection:**

- DN 15 (1/2"): ±20 % of the internal diameter
- DN 25 (1"): ±15 % of the internal diameter
- DN 40 (1 1/2"): ±12 % of the internal diameter
- DN ≥ 50 (2"): ±10 % of the internal diameter

If the standard internal diameter of the ordered process connection differs from the internal diameter of the mating pipe, an additional measuring uncertainty of approx. 2 % o.r. must be expected.

**Example**

Influence of the diameter mismatch without using the correction function:

- Mating pipe DN 100 (4"), schedule 80
- Device flange DN 100 (4"), schedule 40
- This installation position results in a diameter mismatch of 5 mm (0.2 in). If the correction function is not used, an additional measuring uncertainty of approx. 2 % o.r. must be expected.

**Accuracy of outputs**

The outputs have the following base accuracy specifications.

*Current output*

Accuracy	±10 µA
----------	--------

*Pulse/frequency output*

o.r. = of reading

Accuracy	Max. ±100 ppm o.r.
----------	--------------------

Repeatability o.r. = of reading  
±0.2 % o.r.

Response time If all the configurable functions for filter times (flow damping, display damping, current output time constant, frequency output time constant, status output time constant) are set to 0, in the event of vortex frequencies of 10 Hz and higher a response time of max( $T_v$ , 100 ms) can be expected.

In the event of measuring frequencies < 10 Hz, the response time is > 100 ms and can be up to 10 s.  $T_v$  is the average vortex period duration of the flowing fluid.

Influence of ambient temperature

**Current output**

o.r. = of reading

Additional error, based on span of 16 mA:

Temperature coefficient at zero point (4 mA)	0.02 %/10 K
Temperature coefficient with span (20 mA)	0.05 %/10 K

**Pulse/frequency output**

o.r. = of reading

<b>Temperature coefficient</b>	Max. ±100 ppm o.r.
--------------------------------	--------------------



## 16.7 Installation

"Mounting requirements" →  19

## 16.8 Environment

Ambient temperature range

### Temperature tables

-  Observe the interdependencies between the permitted ambient and fluid temperatures when operating the device in hazardous areas.
-  For detailed information on the temperature tables, see the separate document entitled "Safety Instructions" (XA) for the device.

Storage temperature

All components apart from the display modules:  
-50 to +80 °C (-58 to +176 °F)

### Remote display and operating module DKX001

-50 to +80 °C (-58 to +176 °F)

Climate class

DIN EN 60068-2-38 (test Z/AD)

Degree of protection

### Transmitter

- As standard: IP66/67, type 4X enclosure
- When housing is open: IP20, type 1 enclosure
- Display module: IP20, type 1 enclosure

### Sensor

IP66/67, type 4X enclosure

Vibration resistance

- For compact/remote version made of coated aluminum and remote version made of stainless steel:  
Acceleration up to 2 g (if gain set to factory setting), 10 to 500 Hz, following IEC 60068-2-6
- For the compact version made of stainless steel:  
Acceleration up to 1 g (if gain set to factory setting), 10 to 500 Hz, following IEC 60068-2-6

Electromagnetic compatibility (EMC)

As per IEC/EN 61326 and NAMUR Recommendation 21 (NE 21)

-  For details, refer to the Declaration of Conformity.



## 16.9 Process

Medium temperature range **DSC sensor**<sup>3)</sup>

Order code for "Sensor version":

- **Option 1 "Volume flow, basis":**  
-40 to +260 °C (-40 to +500 °F), stainless steel
- **Option 2 "Volume flow, high-temperature/low-temperature":**  
-200 to +400 °C (-328 to +752 °F), stainless steel
- **Option 3 "Mass flow (integrated temperature measurement)":**  
-200 to +400 °C (-328 to +752 °F), stainless steel

Order code for "Sensor option":

**Option CD "Harsh environment"**<sup>4)</sup>, DSC sensor components Alloy C22:  
-200 to +400 °C (-328 to +752 °F), DSC sensor Alloy C22

### Seals

- -200 to +400 °C (-328 to +752 °F) for graphite (standard)
- -15 to +175 °C (+5 to +347 °F) for Viton
- -20 to +275 °C (-4 to +527 °F) for Kalrez
- -200 to +260 °C (-328 to +500 °F) for Gylon

Pressure-temperature ratings



An overview of the pressure-temperature ratings for the process connections is provided in the "Technical Information" document

Secondary containment pressure rating

The following overpressure resistance values apply to the sensor shaft in the event of a membrane rupture:

Sensor version	Overpressure, sensor shaft in [bar a]
Volume flow, basis	200
Volume flow, high-temperature/low-temperature	200
Mass flow (integrated temperature measurement)	200

Pressure loss

For a precise calculation, use the Applicator → 160.

## 16.10 Mechanical construction

Design, dimensions



For the dimensions and installation lengths of the device, see the "Technical Information" document, "Mechanical construction" section

Weight

### Compact version

Weight data:

- Including the transmitter:
  - Order code for "Housing", option C: 1.8 kg (4.0 lb)
  - Order code for "Housing", option B: 4.5 kg (9.9 lb)
- Excluding packaging material

3) Capacitance sensor

4) Aggressive atmosphere (salts or chloride in the air)

*Weight in SI units*

All values (weight) refer to devices with EN (DIN), PN 250 flanges. Weight information in [kg].

DN [mm]	Weight [kg]	
	Order code for "Housing", option C Aluminum, AlSi10Mg, coated	Order code for "Housing", option B Stainless steel, 1.4404 (316L)
15	15.1	17.8
25	16.1	18.8
40	21.1	23.8
50	23.1	2..8
80	41.1	43.8
100	64.1	66.8
150	152.1	154.8

*Weight in US units*

All values (weight) refer to devices with ASME B16.5, Class 1500/Sch. 80 flanges. Weight information in [lbs].

DN [in]	Weight [lbs]	
	Order code for "Housing", option C Aluminum, AlSi10Mg, coated	Order code for "Housing", option B Stainless steel, 1.4404 (316L)
½	29.0	34.9
1	37.8	43.7
1½	44.4	50.3
2	66.5	72.4
3	108.3	114.3
4	156.8	162.8
6	381.7	387.7

**Transmitter remote version**

*Wall-mount housing*

Depends on the material of the wall-mount housing:

- Aluminum, AlSi10Mg, coated: 2.4 kg (5.2 lb)
- Stainless steel, 1.4404 (316L): 6.0 kg (13.2 lb)

**Sensor remote version**

Weight data:

- Including the connection housing:
  - Aluminum, AlSi10Mg, coated: 0.8 kg (1.8 lb)
  - Stainless cast steel, 1.4408 (CF3M): 2.0 kg (4.4 lb)
- Excluding the connecting cable
- Excluding packaging material

*Weight in SI units*

All values (weight) refer to devices with EN (DIN), PN 250 flanges. Weight information in [kg].

DN [mm]	Weight [kg]	
	Connection housing Aluminum, AlSi10Mg, coated	Connection housing Stainless cast steel, 1.4408 (CF3M)
15	14.1	15.3
25	15.1	16.3
40	20.1	21.3
50	22.1	23.3
80	40.1	41.3
100	63.1	64.3
150	151.1	152.3

*Weight in US units*

All values (weight) refer to devices with ASME B16.5, Class 1500/Sch. 80 flanges. Weight information in [lbs].

DN [in]	Weight [lbs]	
	Connection housing Aluminum, AlSi10Mg, coated	Connection housing Stainless cast steel, 1.4408 (CF3M)
½	26.6	29.4
1	35.4	38.2
1½	42.0	44.8
2	64.1	66.8
3	105.9	108.7
4	154.5	157.2
6	379.3	382.1

**Accessories***Flow conditioner**Weight in SI units*

DN <sup>1)</sup> [mm]	Pressure rating	Weight [kg]
15	PN 63	0.05
25	PN 63	0.2
40	PN 63	0.4
50	PN 63	0.6
80	PN 63	1.4
100	PN 63	2.4
150	PN 63	7.8

1) EN (DIN)

DN <sup>1)</sup> [mm]	Pressure rating	Weight [kg]
15	40K	0.06
25	40K	0.1
40	40K	0.3
50	40K	0.5
80	40K	1.3
100	40K	2.1
150	40K	6.2

1) JIS

Materials

**Transmitter housing**

*Compact version*

- Order code for "Housing", option **B** "Compact, stainless":  
Stainless steel CF-3M (316L, 1.4404)
- Order code for "Housing", option **C** "Compact, aluminum coated":  
Aluminum, AlSi10Mg, coated
- Window material: glass

*Remote version*

- Order code for "Housing", option **J** "Remote, aluminum coated":  
Aluminum, AlSi10Mg, coated
- Order code for "Housing", option **K** "Remote, stainless":  
For maximum corrosion resistance: stainless steel 1.4404 (316L)
- Window material: glass

**Cable entries/cable glands**

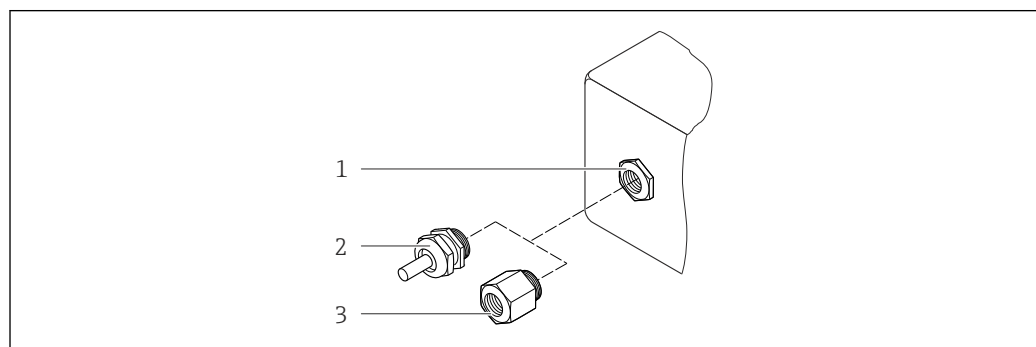

A0020640

38 Possible cable entries/cable glands

- 1 Cable entry in transmitter housing, wall-mount housing or connection housing with internal thread M20 x 1.5
- 2 Cable gland M20 x 1.5
- 3 Adapter for cable entry with internal thread G ½" or NPT ½"

Order code for "Housing", option B "Compact, stainless", option K "Remote, stainless"

Cable entry/cable gland	Type of protection	Material
Cable gland M20 × 1.5	<ul style="list-style-type: none"> <li>■ Non-Ex</li> <li>■ Ex ia</li> <li>■ Ex ic</li> <li>■ Ex nA</li> <li>■ Ex tb</li> </ul>	Stainless steel ,1.4404
Adapter for cable entry with internal thread G ½"	For non-Ex and Ex (except for CSA Ex d/XP)	Stainless steel, 1.4404 (316L)
Adapter for cable entry with internal thread NPT ½"	For non-Ex and Ex	

Order code for "Housing": option C "Compact, aluminum coated", option J "Remote, aluminum coated"

Cable entry/cable gland	Type of protection	Material
Cable gland M20 × 1.5	<ul style="list-style-type: none"> <li>■ Non-Ex</li> <li>■ Ex ia</li> <li>■ Ex ic</li> </ul>	Plastic
	Adapter for cable entry with internal thread G ½"	Nickel-plated brass
Adapter for cable entry with internal thread NPT ½"	For non-Ex and Ex (except for CSA Ex d/XP)	Nickel-plated brass
Thread NPT ½" via adapter	For non-Ex and Ex	

### Connecting cable for remote version

- Standard cable: PVC cable with copper shield
- Reinforced cable: PVC cable with copper shield and additional steel wire braided jacket

### Sensor connection housing

- Coated aluminum AlSi10Mg
- Stainless cast steel, 1.4408 (CF3M), in compliance with NACE MR0175-2003 and MR0103-2003

### Measuring tubes

#### Pressure ratings up to PN 160, Class 600, and JIS 40K:

Stainless cast steel, 1.4408 (CF3M), in compliance with AD2000 (for AD2000 the temperature range is limited to -10 to +400 °C (+14 to +752 °F)) and in compliance with NACE MR0175-2003 and MR0103-2003

#### Pressure ratings PN 250, Class 900 to 1500 and butt-weld version:

Stainless steel, 1.4571 similar to 316Ti, NACE available on request

### DSC sensor

#### Pressure ratings up to PN 63/100/160, Class 600, and JIS 40K:

Parts in contact with medium (marked as "wet" on the DSC sensor flange): UNS N07718 similar to Alloy 718/2.4668, in compliance with NACE MR0175-2003 and MR0103-2003

Parts not in contact with medium:

- Stainless steel 1.4301 (304)
- Order code for "Sensor option", option CD "Harsh environment"<sup>5)</sup>, DSC sensor, Alloy C22 sensor component":

Alloy C22 sensor: UNS N06022 similar to Alloy C22/2.4602, in compliance with NACE MR0175-2003 and MR0103-2003

#### Pressure ratings up to PN 250, Class 900/1500:

- Parts in contact with medium (marked as "wet" on the DSC sensor flange):  
Titanium Gr. 5 similar to 3.7165
- Parts not in contact with medium:  
Stainless steel 1.4301 (304)

#### Process connections

##### Pressure ratings up to PN 63/100/160, Class 600, and JIS 40K:

Stainless cast steel, multiple certifications, 1.4408 (CF3M)

##### Pressure ratings up to PN 250:

Stainless steel, 1.4571 similar to F316 Ti

##### Pressure ratings Class 900/1500:

Stainless steel, F316/F316L similar to 1.4404

 List of all available process connections →  183

#### Seals

- Graphite (standard)  
Sigraflex Hochdruck™ with smooth sheet metal insert made of stainless steel, 316/316L (BAM-certified for oxygen applications, "high quality in terms of TA Luft" (German Clean Air Act))
- FPM (Viton)
- Kalrez 6375
- Gylon 3504 (BAM-certified for oxygen applications, "high quality in terms of TA Luft" (German Clean Air Act"))

*Ultra-high pressure version*

Graphite (standard)

Pressure rating PN 250, Class 900 to 1500: Grafoil with perforated metal insert made of stainless steel, 1.4404 (316/316L)

#### Housing support

Stainless steel, 1.4408 (CF3M)

#### Accessories

*Weather protection cover*

Stainless steel 1.4404 (316L)

*Flow conditioner*

Stainless steel, multiple certifications, 1.4404 (316, 316L), in compliance with NACE MR0175-2003 and MR0103-2003

5) Aggressive atmosphere (salts or chlorides in the air)

## Process connections

- EN 1092-1 (DIN 2501)
- ASME B16.5
- JIS B2220



For information on the different materials used in the process connections

## 16.11 Operability

## Local operation



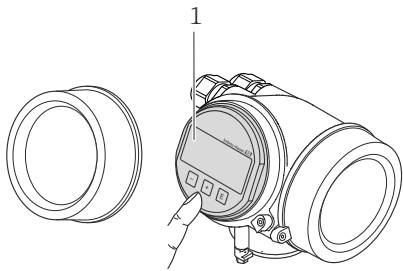
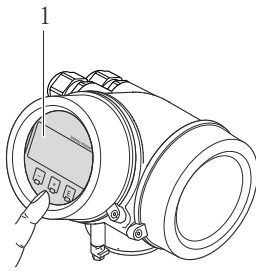



## Via display module

Order code for "Display; Operation", option C "SD02"	Order code for "Display; Operation", option E "SD03"
 <p style="text-align: right; font-size: small;">A0015544</p>	 <p style="text-align: right; font-size: small;">A0015546</p>
1 Operation with pushbuttons	1 Operation with touch control

### Display elements

- 4-line display
- With order code for "Display; operation", option E:  
White background lighting; switches to red in event of device errors
- Format for displaying measured variables and status variables can be individually configured
- Permitted ambient temperature for the display:  $-20$  to  $+60$  °C ( $-4$  to  $+140$  °F)  
The readability of the display may be impaired at temperatures outside the temperature range.

### Operating elements

- With order code for "Display; operation", option C:  
Local operation with 3 push buttons: , , 
- With order code for "Display; operation", option E:  
External operation via touch control; 3 optical keys: , , 
- Operating elements also accessible in various hazardous areas

### Additional functionality

- Data backup function  
The device configuration can be saved in the display module.
- Data comparison function  
The device configuration saved in the display module can be compared to the current device configuration.
- Data transfer function  
The transmitter configuration can be transmitted to another device using the display module.

**Via remote display and operating module FHX50**

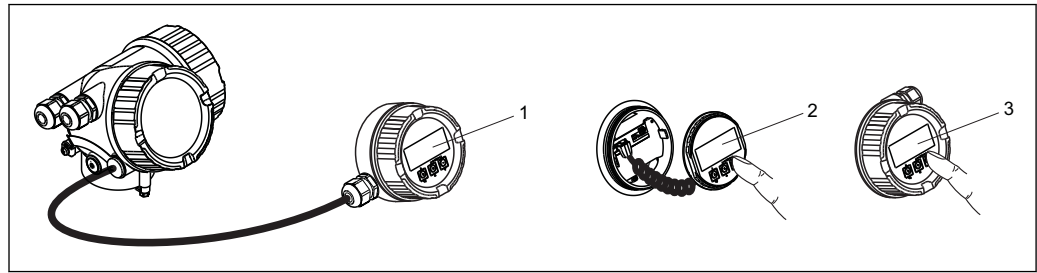

A0013137

▣ 39 Operating options via FHX50

- 1 Housing of remote display and operating module FHX50
- 2 SD02 display and operating module, push buttons: cover must be opened for operation
- 3 SD03 display and operating module, optical buttons: operation possible through cover glass

Remote operation

**Via HART protocol**

This communication interface is available in device versions with a HART output.

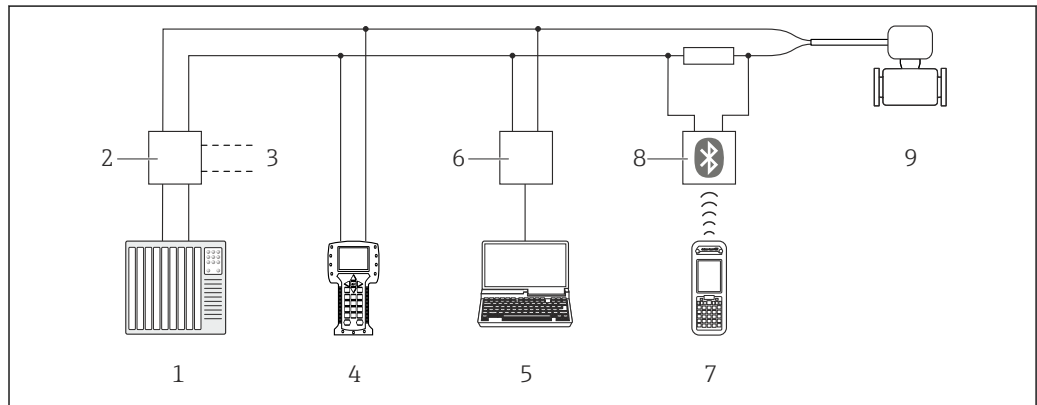

A0013764

▣ 40 Options for remote operation via HART protocol

- 1 Control system (e.g. PLC)
- 2 Transmitter power supply unit, e.g. RN221N (with communication resistor)
- 3 Connection for Commubox FXA195 and Field Communicator 475
- 4 Field Communicator 475
- 5 Computer with operating tool (e.g. FieldCare, AMS Device Manager, SIMATIC PDM)
- 6 Commubox FXA195 (USB)
- 7 Field Xpert SFX350 or SFX370
- 8 VIATOR Bluetooth modem with connecting cable
- 9 Transmitter



## Service interface

## Via service interface (CDI)

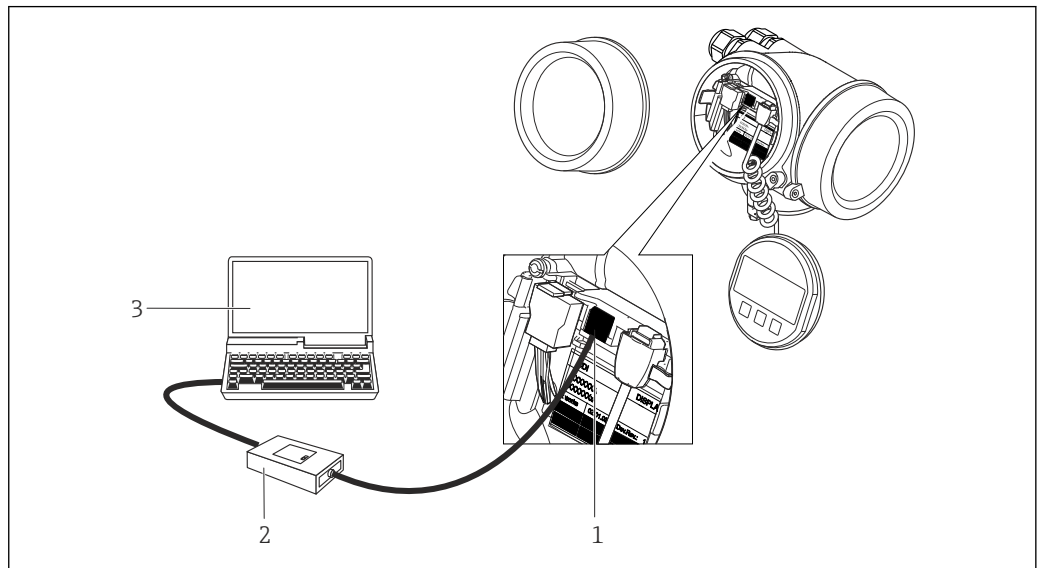

- 1 Service interface (CDI = Endress+Hauser Common Data Interface) of the measuring device  
 2 Commubox FXA291  
 3 Computer with "FieldCare" operating tool with COM DTM "CDI Communication FXA291"

A0020545

## Languages

Can be operated in the following languages:

- Via local display:  
English, German, French, Spanish, Italian, Dutch, Portuguese, Polish, Russian, Swedish, Turkish, Chinese, Japanese, Korean, Bahasa (Indonesian), Vietnamese, Czech
- Via "FieldCare" operating tool:  
English, German, French, Spanish, Italian, Chinese, Japanese

## 16.12 Certificates and approvals

## CE mark

The measuring system is in conformity with the statutory requirements of the applicable EC Directives. These are listed in the corresponding EC Declaration of Conformity along with the standards applied.

Endress+Hauser confirms successful testing of the device by affixing to it the CE mark.

## C-Tick symbol

The measuring system meets the EMC requirements of the "Australian Communications and Media Authority (ACMA)".



## Ex approval

The devices are certified for use in hazardous areas and the relevant safety instructions are provided in the separate "Safety Instructions" (XA) document. Reference is made to this document on the nameplate.

## Functional safety

The measuring device can be used for flow monitoring systems (min., max., range) up to SIL 2 (single-channel architecture) and SIL 3 (multichannel architecture with homogeneous redundancy) and is independently evaluated and certified by the TÜV in accordance with IEC 61508.

The following types of monitoring in safety equipment are possible:  
Volume flow

 Functional Safety Manual with information on the SIL device →  187

Pressure Equipment Directive	<ul style="list-style-type: none"> <li>■ With the PED/G1/x (x = category) marking on the sensor nameplate, Endress+Hauser confirms compliance with the "Essential Safety Requirements" specified in Annex I of the Pressure Equipment Directive 97/23/EC.</li> <li>■ Devices not bearing this marking (PED) are designed and manufactured according to good engineering practice. They meet the requirements of Art.3 Section 3 of the Pressure Equipment Directive 97/23/EC. The range of application is indicated in tables 6 to 9 in Annex II of the Pressure Equipment Directive.</li> </ul>
Experience	The Prowirl 200 measuring system is the official successor to Prowirl 72 and Prowirl 73.
Other standards and guidelines	<ul style="list-style-type: none"> <li>■ EN 60529 Degrees of protection provided by enclosures (IP code)</li> <li>■ DIN ISO 13359 Measurement of conductive liquid flow in closed conduits - Flanged-type electromagnetic flowmeters - Overall length</li> <li>■ EN 61010-1 Safety requirements for electrical equipment for measurement, control and laboratory use - general requirements</li> <li>■ IEC/EN 61326 Emission in accordance with Class A requirements. Electromagnetic compatibility (EMC requirements).</li> <li>■ NAMUR NE 21 Electromagnetic compatibility (EMC) of industrial process and laboratory control equipment</li> <li>■ NAMUR NE 32 Data retention in the event of a power failure in field and control instruments with microprocessors</li> <li>■ NAMUR NE 43 Standardization of the signal level for the breakdown information of digital transmitters with analog output signal.</li> <li>■ NAMUR NE 53 Software of field devices and signal-processing devices with digital electronics</li> <li>■ NAMUR NE 105 Specifications for integrating fieldbus devices in engineering tools for field devices</li> <li>■ NAMUR NE 107 Self-monitoring and diagnosis of field devices</li> <li>■ NAMUR NE 131 Requirements for field devices for standard applications</li> <li>■ ASME BPVC Section VIII, Division 1 Rules for Construction of Pressure Vessels</li> </ul>

## 16.13 Application packages

Many different application packages are available to enhance the functionality of the device. Such packages might be needed to address safety aspects or specific application requirements.



The application packages can be ordered with the device or subsequently from Endress+Hauser. Detailed information on the order code in question is available from your local Endress+Hauser sales center or on the product page of the Endress+Hauser website: [www.endress.com](http://www.endress.com).



Detailed information on the application packages:

- Special Documentation for the device → 188
- Special Documentation for the device

## 16.14 Accessories

 Overview of accessories available for order →  158

## 16.15 Supplementary documentation

 For an overview of the scope of the associated Technical Documentation, refer to the following:

- The *W@M Device Viewer* : Enter the serial number from the nameplate ([www.endress.com/deviceviewer](http://www.endress.com/deviceviewer))
- The *Endress+Hauser Operations App*: Enter the serial number from the nameplate or scan the 2-D matrix code (QR code) on the nameplate.

### Standard documentation

#### Brief Operating Instructions

Measuring device	Documentation code
Prowirl O 200	KA01137D

#### Technical Information

Measuring device	Documentation code
Prowirl O 200	TI01085D

#### Description of device parameters

Measuring device	Documentation code
Prowirl 200	GP01019D

### Supplementary device-dependent documentation



#### Safety Instructions

Contents	Documentation code
ATEX/IECEX Ex d, Ex tb	XA01148D
ATEX/IECEX Ex ia, Ex tb	XA01151D
ATEX/IECEX Ex ic, Ex nA	XA01152D
cCSA <sub>US</sub> XP	XA01153D
cCSA <sub>US</sub> IS	XA01154D
NEPSI Ex d	XA01238D
NEPSI Ex i	XA01239D
NEPSI Ex ic, Ex nA	XA01240D
INMETRO Ex d	XA01250D
INMETRO Ex i	XA01042D
INMETRO Ex nA	XA01043D

### Special Documentation

Contents	Documentation code
Information on the Pressure Equipment Directive	SD01163D
Functional Safety Manual	SD01162D
Heartbeat Technology	SD01204D
Natural gas	SD01194D
Air + Industrial Gases (Single Gas + Gas Mixtures)	SD01195D

### Installation Instructions

Contents	Documentation code
Installation Instructions for spare part sets	 <a href="#">Overview of accessories available for order →</a>  158

# Index

## A

- Access authorization to parameters
  - Read access . . . . . 57
  - Write access . . . . . 57
- Access code . . . . . 57
  - Incorrect input . . . . . 57
- Adapting the diagnostic behavior . . . . . 142
- Adapting the status signal . . . . . 142
- Ambient temperature
  - Influence . . . . . 175
- Ambient temperature range . . . . . 23
- AMS Device Manager . . . . . 61
  - Function . . . . . 61
- Application . . . . . 9, 162
- Applicator . . . . . 166
- Approvals . . . . . 185

## B

- Burst mode . . . . . 64

## C

- C-Tick symbol . . . . . 185
- Cable entries
  - Technical data . . . . . 172
- Cable entry
  - Degree of protection . . . . . 42
- CE mark . . . . . 10, 185
- Certificates . . . . . 185
- Check
  - Installation . . . . . 28
- Checklist
  - Post-connection check . . . . . 43
  - Post-installation check . . . . . 28
- Cleaning
  - Exterior cleaning . . . . . 154
  - Interior cleaning . . . . . 154
  - Replacing housing seals . . . . . 154
  - Replacing seals . . . . . 154
  - Replacing sensor seals . . . . . 154
- Climate class . . . . . 176
- Commissioning . . . . . 67
  - Advanced settings . . . . . 94
  - Configuring the measuring device . . . . . 68
- Communication-specific data . . . . . 62
- Connecting cable . . . . . 29
- Connecting the measuring device . . . . . 34
- Connection
  - see Electrical connection
- Connection preparations . . . . . 34
- Connection tools . . . . . 29
- Context menu
  - Closing . . . . . 52
  - Explanation . . . . . 52
  - Opening . . . . . 52
- Current consumption . . . . . 172

## D

- Declaration of Conformity . . . . . 10
- Define access code . . . . . 124
- Degree of protection . . . . . 42, 176
- Designated use . . . . . 9
- Device components . . . . . 11
- Device description files . . . . . 62
- Device documentation
  - Supplementary documentation . . . . . 8
- Device locking, status . . . . . 127
- Device name
  - Sensor . . . . . 14
  - Transmitter . . . . . 13
- Device repair . . . . . 155
- Device revision . . . . . 62
- Device type ID . . . . . 62
- Diagnostic behavior
  - Explanation . . . . . 139
  - Symbols . . . . . 139
- Diagnostic information
  - Design, description . . . . . 139, 141
  - FieldCare . . . . . 140
  - Local display . . . . . 138
  - Overview . . . . . 143
  - Remedy information . . . . . 143
- Diagnostic list . . . . . 147
- Diagnostic message . . . . . 138
- Diagnostics
  - Symbols . . . . . 138
- DIP switches
  - see Write protection switch
- Direct access . . . . . 54
- Direct access code . . . . . 49
- Disabling write protection . . . . . 123
- Display
  - see Local display
- Display area
  - For operational display . . . . . 47
  - In the navigation view . . . . . 49
- Display values
  - For locking status . . . . . 127
- Disposal . . . . . 156
- Document
  - Function . . . . . 6
  - Symbols used . . . . . 6
- Document function . . . . . 6

## E

- Electrical connection
  - Commubox FXA195 (USB) . . . . . 184
  - Commubox FXA291 . . . . . 59, 185
  - Degree of protection . . . . . 42
  - Field Communicator 475 . . . . . 184
  - Field Xpert SFX350/SFX370 . . . . . 184
  - Measuring device . . . . . 29

- Operating tool (e.g. FieldCare, AMS Device Manager, SIMATIC PDM) . . . . . 184
  - Operating tools
    - Via HART protocol . . . . . 184
    - Via service interface (CDI) . . . . . 59, 185
  - Transmitter power supply unit . . . . . 184
  - VIATOR Bluetooth modem . . . . . 184
  - Electromagnetic compatibility . . . . . 176
  - Enabling write protection . . . . . 123
  - Endress+Hauser services
    - Maintenance . . . . . 154
    - Repair . . . . . 156
  - Environment
    - Ambient temperature range . . . . . 23
    - Storage temperature . . . . . 176
    - Vibration resistance . . . . . 176
  - Error messages
    - see Diagnostic messages
  - Event history . . . . . 148
  - Events list . . . . . 148
  - Ex approval . . . . . 185
  - Experience . . . . . 186
  - Extended order code
    - Sensor . . . . . 14
    - Transmitter . . . . . 13
  - Exterior cleaning . . . . . 154
- F**
- Field Communicator
    - Function . . . . . 61
  - Field Communicator 475 . . . . . 61
  - Field of application
    - Residual risks . . . . . 10
  - Field Xpert
    - Function . . . . . 59
  - Field Xpert SFX350 . . . . . 59
  - FieldCare . . . . . 59
    - Device description file . . . . . 62
    - Establishing a connection . . . . . 60
    - Function . . . . . 59
    - User interface . . . . . 60
  - Filtering the event logbook . . . . . 148
  - Firmware
    - Release date . . . . . 62
    - Version . . . . . 62
  - Firmware history . . . . . 153
  - Flow direction . . . . . 19
  - Function check . . . . . 67
  - Function scope
    - AMS Device Manager . . . . . 61
    - Field Communicator . . . . . 61
    - Field Communicator 475 . . . . . 61
    - Field Xpert . . . . . 59
    - SIMATIC PDM . . . . . 61
  - Functional safety (SIL) . . . . . 185
  - Functions
    - see Parameter
- G**
- Galvanic isolation . . . . . 170
- H**
- Hardware write protection . . . . . 124
  - HART protocol
    - Device variables . . . . . 62
    - Measured variables . . . . . 62
  - Help text
    - Calling up . . . . . 55
    - Close . . . . . 55
    - Explanation . . . . . 55
  - HistoROM . . . . . 119
- I**
- I/O electronics module . . . . . 11, 38
  - Identifying the measuring device . . . . . 12
  - Incoming acceptance . . . . . 12
  - Influence
    - Ambient temperature . . . . . 175
  - Information on the document . . . . . 6
  - Inlet runs . . . . . 20
  - Input . . . . . 162
  - Input mask . . . . . 50
  - Inspection
    - Received goods . . . . . 12
  - Inspection check
    - Connection . . . . . 43
  - Installation . . . . . 19
  - Installation conditions
    - Inlet and outlet runs . . . . . 20
    - Mounting location . . . . . 19
    - Orientation . . . . . 19
    - Thermal insulation . . . . . 23
    - Vibrations . . . . . 24
  - Installation dimensions . . . . . 22
  - Interior cleaning . . . . . 154
- K**
- Keypad lock
    - Disabling . . . . . 57
    - Enabling . . . . . 57
- L**
- Languages, operation options . . . . . 185
  - Line recorder . . . . . 133
  - Load . . . . . 33
  - Local display . . . . . 183
    - Editing view . . . . . 50
    - Navigation view . . . . . 48
    - see Diagnostic message
    - see In alarm condition
    - see Operational display
  - Low flow cut off . . . . . 170
- M**
- Main electronics module . . . . . 11
  - Maintenance tasks . . . . . 154
  - Managing the device configuration . . . . . 119

- Manufacturer ID . . . . . 62
- Manufacturing date . . . . . 13, 14
- Materials . . . . . 180
- Maximum measured error . . . . . 173
- Measured variables
  - Calculated . . . . . 162
  - Measured . . . . . 162
  - see Process variables
- Measuring and test equipment . . . . . 154
- Measuring device
  - Configuration . . . . . 68
  - Conversion . . . . . 155
  - Disposal . . . . . 157
  - Mounting the sensor . . . . . 25
  - Preparing for electrical connection . . . . . 34
  - Preparing for mounting . . . . . 25
  - Removing . . . . . 156
  - Repair . . . . . 155
  - Structure . . . . . 11
  - Switch-on . . . . . 67
- Measuring principle . . . . . 162
- Measuring range . . . . . 166
- Measuring system . . . . . 162
- Media . . . . . 9
- Medium temperature range . . . . . 177
- Menu
  - Diagnostics . . . . . 146
  - Operation . . . . . 127
  - Setup . . . . . 68
- Menus
  - For measuring device configuration . . . . . 68
  - For specific settings . . . . . 94
- Mounting dimensions
  - see Installation dimensions
- Mounting location . . . . . 19
- Mounting preparations . . . . . 25
- Mounting requirements
  - Installation dimensions . . . . . 22
- Mounting tools . . . . . 25
- N**
- Nameplate
  - Sensor . . . . . 14
  - Transmitter . . . . . 13
- Navigation path (navigation view) . . . . . 48
- Navigation view
  - In the submenu . . . . . 48
  - In the wizard . . . . . 48
- Nominal pressure
  - Secondary containment . . . . . 177
- Numeric editor . . . . . 50
- O**
- Operable flow range . . . . . 167
- Operating elements . . . . . 52, 139
- Operating keys
  - see Operating elements
- Operating menu
  - Menus, submenus . . . . . 45
- Structure . . . . . 45
  - Submenus and user roles . . . . . 46
- Operating options . . . . . 44
- Operating philosophy . . . . . 46
- Operation . . . . . 127
- Operation options . . . . . 44
- Operational display . . . . . 47
- Operational safety . . . . . 10
- Order code . . . . . 12, 13, 14
- Orientation (vertical, horizontal) . . . . . 19
- Outlet runs . . . . . 20
- Output . . . . . 168
- Output signal . . . . . 168
- P**
- Packaging disposal . . . . . 18
- Parameter
  - Changing . . . . . 56
  - Enter a value . . . . . 56
- Parameter settings
  - Administration (Submenu) . . . . . 149
  - Burst configuration 1 to 3 (Submenu) . . . . . 64
  - Configuration backup display (Submenu) . . . . . 119
  - Current input (Wizard) . . . . . 72
  - Current output 1 to 2 (Wizard) . . . . . 75
  - Data logging (Submenu) . . . . . 133
  - Device information (Submenu) . . . . . 150
  - Diagnostics (Menu) . . . . . 146
  - Display (Submenu) . . . . . 117
  - Display (Wizard) . . . . . 89
  - External compensation (Submenu) . . . . . 112
  - Gas composition (Submenu) . . . . . 101
  - Input values (Submenu) . . . . . 130
  - Low flow cut off (Wizard) . . . . . 92
  - Medium properties (Submenu) . . . . . 98
  - Medium selection (Wizard) . . . . . 70
  - Output conditioning (Wizard) . . . . . 91
  - Output values (Submenu) . . . . . 131
  - Process variables (Submenu) . . . . . 127
  - Pulse/frequency/switch output (Wizard) . . . . . 78, 81, 85
  - Sensor adjustment (Submenu) . . . . . 114
  - Setup (Menu) . . . . . 68
  - Simulation (Submenu) . . . . . 121
  - System units (Submenu) . . . . . 95
  - Totalizer (Submenu) . . . . . 130
  - Totalizer 1 to 3 (Submenu) . . . . . 115
  - Totalizer handling (Submenu) . . . . . 132
- Performance characteristics . . . . . 173
- Post-connection check (checklist) . . . . . 43
- Post-installation check . . . . . 67
- Post-installation check (checklist) . . . . . 28
- Potential equalization . . . . . 40
- Power consumption . . . . . 171
- Power supply failure . . . . . 172
- Pressure Equipment Directive . . . . . 186
- Pressure loss . . . . . 177
- Pressure-temperature ratings . . . . . 177
- Process
  - Pressure loss . . . . . 177

- Process conditions
  - Medium temperature . . . . . 177
- Process connections . . . . . 183
- Product safety . . . . . 10
- Protecting parameter settings . . . . . 123
- R**
- Read access . . . . . 57
- Reading measured values . . . . . 127
- Recalibration . . . . . 154
- Reference operating conditions . . . . . 173
- Registered trademarks . . . . . 8
- Remedial measures
  - Calling up . . . . . 140
  - Closing . . . . . 140
- Remote operation . . . . . 184
- Remote version
  - Connecting the connecting cable . . . . . 34
- Repair . . . . . 155
  - Notes . . . . . 155
- Repair of a device . . . . . 155
- Repeatability . . . . . 175
- Replacement
  - Device components . . . . . 155
- Replacing seals . . . . . 154
- Requirements for personnel . . . . . 9
- Response time . . . . . 175
- Return . . . . . 156
- S**
- Safety . . . . . 9
- Sensor
  - Mounting . . . . . 25
- Serial number . . . . . 13, 14
- Setting the operating language . . . . . 67
- Settings
  - Adapting the measuring device to the process conditions . . . . . 132
  - Advanced display configurations . . . . . 117
  - Current input . . . . . 72
  - Current output . . . . . 75
  - Device reset . . . . . 149
  - Device tag . . . . . 68
  - External compensation . . . . . 112
  - Gas composition . . . . . 101
  - Local display . . . . . 89
  - Low flow cut off . . . . . 92
  - Managing the device configuration . . . . . 119
  - Medium . . . . . 70
  - Medium properties . . . . . 98
  - Operating language . . . . . 67
  - Output conditioning . . . . . 91
  - Pulse output . . . . . 78
  - Pulse/frequency/switch output . . . . . 78, 81
  - Resetting the totalizer . . . . . 132
  - Sensor adjustment . . . . . 114
  - Simulation . . . . . 121
  - Switch output . . . . . 85
  - System units . . . . . 95
  - Totalizer . . . . . 115
  - Totalizer reset . . . . . 132
- Showing data logging . . . . . 133
- Signal on alarm . . . . . 169
- SIL (functional safety) . . . . . 185
- SIMATIC PDM . . . . . 61
  - Function . . . . . 61
- Spare part . . . . . 155
- Spare parts . . . . . 155
- Special connection instructions . . . . . 40
- Standards and guidelines . . . . . 186
- Status area
  - For operational display . . . . . 47
  - In the navigation view . . . . . 49
- Status signals . . . . . 138
- Storage conditions . . . . . 17
- Storage temperature . . . . . 17
- Storage temperature range . . . . . 176
- Structure
  - Measuring device . . . . . 11
  - Operating menu . . . . . 45
- Submenu
  - Administration . . . . . 149
  - Advanced setup . . . . . 94
  - Burst configuration 1 to 3 . . . . . 64
  - Configuration backup display . . . . . 119
  - Data logging . . . . . 133
  - Device information . . . . . 150
  - Display . . . . . 117
  - Events list . . . . . 148
  - External compensation . . . . . 112
  - Gas composition . . . . . 101
  - Input values . . . . . 130
  - Medium properties . . . . . 98
  - Output values . . . . . 131
  - Overview . . . . . 46
  - Process variables . . . . . 127
  - Sensor adjustment . . . . . 114
  - Simulation . . . . . 121
  - System units . . . . . 95
  - Totalizer . . . . . 130
  - Totalizer 1 to 3 . . . . . 115
  - Totalizer handling . . . . . 132
- Supplementary documentation . . . . . 187
- Supply unit
  - Requirements . . . . . 32
- Supply voltage . . . . . 32, 171
- Symbols
  - For communication . . . . . 47
  - For correction . . . . . 50
  - For diagnostic behavior . . . . . 47
  - For locking . . . . . 47
  - For measured variable . . . . . 47
  - For measurement channel number . . . . . 47
  - For menus . . . . . 49
  - For parameters . . . . . 49
  - For status signal . . . . . 47
  - For submenu . . . . . 49
  - For wizard . . . . . 49



- In the status area of the local display . . . . . 47
- In the text and numeric editor . . . . . 50
- System design
  - Measuring system . . . . . 162
  - see Measuring device design
- System integration . . . . . 62
- T**
- Technical data, overview . . . . . 162
- Temperature range
  - Ambient temperature range for display . . . . . 183
  - Storage temperature . . . . . 17
- Terminal assignment . . . . . 31, 38
- terminal voltage . . . . . 33
- Terminals . . . . . 172
- Text editor . . . . . 50
- Thermal insulation . . . . . 23
- Tool tip
  - see Help text
- Tools
  - Electrical connection . . . . . 29
  - Installation . . . . . 25
  - Transport . . . . . 17
- Transmitter
  - Connecting the signal cables . . . . . 38
  - Turning the display module . . . . . 27
  - Turning the housing . . . . . 27
- Transporting the measuring device . . . . . 17
- Troubleshooting
  - General . . . . . 136
- Turning the display module . . . . . 27
- Turning the electronics housing
  - see Turning the transmitter housing
- Turning the transmitter housing . . . . . 27
- U**
- Use of the measuring device
  - Borderline cases . . . . . 9
  - Incorrect use . . . . . 9
  - see Designated use
- User interface
  - Current diagnostic event . . . . . 146
  - Previous diagnostic event . . . . . 146
- User roles . . . . . 46
- V**
- Version data for the device . . . . . 62
- Vibration resistance . . . . . 176
- Vibrations . . . . . 24
- W**
- W@M . . . . . 154, 155
- W@M Device Viewer . . . . . 12, 155
- Weight
  - Compact version . . . . . 177
  - SI units . . . . . 178
  - US units . . . . . 178
  - Flow conditioner . . . . . 179
  - Sensor remote version
    - SI units . . . . . 179
- US units . . . . . 179
- Transport (notes) . . . . . 17
- Wizard
  - Current input . . . . . 72
  - Current output 1 to 2 . . . . . 75
  - Define access code . . . . . 123
  - Display . . . . . 89
  - Low flow cut off . . . . . 92
  - Medium selection . . . . . 70
  - Output conditioning . . . . . 91
  - Pulse/frequency/switch output . . . . . 78, 81, 85
- Workplace safety . . . . . 10
- Write access . . . . . 57
- Write protection
  - Via access code . . . . . 123
  - Via write protection switch . . . . . 124
- Write protection switch . . . . . 124

[www.addresses.endress.com](http://www.addresses.endress.com)

---