

Operating Instructions

Proline Promag P 100

EtherNet/IP

Electromagnetic flowmeter

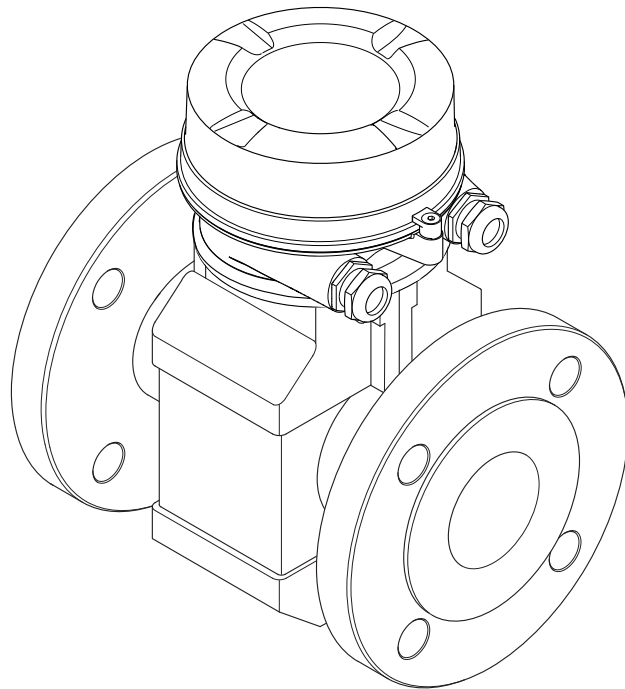

- Make sure the document is stored in a safe place such that it is always available when working on or with the device.
- To avoid danger to individuals or the facility, read the "Basic safety instructions" section carefully, as well as all other safety instructions in the document that are specific to working procedures.
- The manufacturer reserves the right to modify technical data without prior notice. Your Endress+Hauser Sales Center will supply you with current information and updates to these Instructions.

Table of contents

1	Document information	5	6.3	Post-installation check	26
1.1	Document function	5	7	Electrical connection	27
1.2	Symbols used	5	7.1	Connection conditions	27
1.2.1	Safety symbols	5	7.1.1	Required tools	27
1.2.2	Electrical symbols	5	7.1.2	Requirements for connecting cable	27
1.2.3	Tool symbols	6	7.1.3	Terminal assignment	28
1.2.4	Symbols for certain types of information	6	7.1.4	Pin assignment, device plug	29
1.2.5	Symbols in graphics	6	7.1.5	Preparing the measuring device	29
1.3	Documentation	7	7.2	Connecting the measuring device	29
1.3.1	Standard documentation	7	7.2.1	Connecting the transmitter	29
1.3.2	Supplementary device-dependent documentation	7	7.2.2	Ensuring potential equalization	31
1.4	Registered trademarks	7	7.3	Special connection instructions	33
2	Basic safety instructions	8	7.3.1	Connection examples	33
2.1	Requirements for the personnel	8	7.4	Hardware settings	33
2.2	Designated use	8	7.4.1	Setting the device address	33
2.3	Workplace safety	9	7.5	Ensuring the degree of protection	34
2.4	Operational safety	9	7.6	Post-connection check	35
2.5	Product safety	9	8	Operation options	36
2.6	IT security	9	8.1	Overview of operation options	36
3	Product description	11	8.2	Structure and function of the operating menu	37
3.1	Product design	11	8.2.1	Structure of the operating menu	37
3.1.1	Device version with EtherNet/IP communication type	11	8.2.2	Operating philosophy	38
4	Incoming acceptance and product identification	12	8.3	Access to the operating menu via the Web browser	38
4.1	Incoming acceptance	12	8.3.1	Function range	38
4.2	Product identification	12	8.3.2	Prerequisites	39
4.2.1	Transmitter nameplate	13	8.3.3	Establishing a connection	39
4.2.2	Sensor nameplate	14	8.3.4	Logging on	40
4.2.3	Symbols on measuring device	15	8.3.5	User interface	41
5	Storage and transport	16	8.3.6	Disabling the Web server	42
5.1	Storage conditions	16	8.3.7	Logging out	42
5.2	Transporting the product	16	8.4	Access to the operating menu via the operating tool	43
5.3	Packaging disposal	17	8.4.1	Connecting the operating tool	43
6	Mounting	17	8.4.2	FieldCare	44
6.1	Installation conditions	17	9	System integration	46
6.1.1	Mounting position	17	9.1	Overview of device description files	46
6.1.2	Requirements from environment and process	19	9.1.1	Current version data for the device	46
6.2	Mounting the measuring device	21	9.1.2	Operating tools	46
6.2.1	Required tools	21	9.2	Overview of system files	46
6.2.2	Preparing the measuring device	22	9.3	Integrating the measuring device in the system	46
6.2.3	Mounting the sensor	22	10	Commissioning	48
6.2.4	Turning the display module	25	10.1	Function check	48
			10.2	Configuring the device address via software	48
			10.2.1	Ethernet network and Web server	48
			10.3	Configuring the measuring device	48
			10.3.1	Defining the tag name	48

10.3.2	Setting the system units	49	13	Maintenance	80
10.3.3	Configuring the local display	50	13.1	Maintenance tasks	80
10.3.4	Configuring the communication interface	52	13.1.1	Exterior cleaning	80
10.3.5	Configuring the low flow cut off	53	13.1.2	Interior cleaning	80
10.3.6	Configuring empty pipe detection	54	13.1.3	Replacing seals	80
10.4	Advanced settings	55	13.2	Measuring and test equipment	80
10.4.1	Carrying out a sensor adjustment	55	13.3	Endress+Hauser services	80
10.4.2	Configuring the totalizer	55	14	Repair	81
10.4.3	Carrying out additional display configurations	57	14.1	General notes	81
10.4.4	Performing electrode cleaning	59	14.2	Spare parts	81
10.5	Simulation	60	14.3	Endress+Hauser services	81
10.6	Protecting settings from unauthorized access	61	14.4	Return	81
10.6.1	Write protection via access code	61	14.5	Disposal	81
10.6.2	Write protection via write protection switch	61	14.5.1	Removing the measuring device	81
			14.5.2	Disposing of the measuring device	82
11	Operation	63	15	Accessories	83
11.1	Read out and modify current Ethernet settings	63	15.1	Device-specific accessories	83
11.2	Reading device locking status	63	15.1.1	For the transmitter	83
11.3	Reading measured values	64	15.1.2	For the sensor	83
11.3.1	Process variables	64	15.2	Communication-specific accessories	83
11.3.2	Totalizer	64	15.3	Service-specific accessories	83
11.4	Adapting the measuring device to the process conditions	65	15.4	System components	84
11.5	Performing a totalizer reset	65	16	Technical data	85
12	Diagnostics and troubleshooting	67	16.1	Application	85
12.1	General troubleshooting	67	16.2	Function and system design	85
12.2	Diagnostic information via light emitting diodes	68	16.3	Input	85
12.2.1	Transmitter	68	16.4	Output	87
12.3	Diagnostic information in the Web browser	69	16.5	Power supply	90
12.3.1	Diagnostic options	69	16.6	Performance characteristics	91
12.3.2	Calling up remedy information	70	16.7	Installation	92
12.4	Diagnostic information in FieldCare	70	16.8	Environment	92
12.4.1	Diagnostic options	70	16.9	Process	93
12.4.2	Calling up remedy information	71	16.10	Mechanical construction	95
12.5	Diagnostic information via communication interface	71	16.11	Operability	99
12.5.1	Reading out diagnostic information	71	16.12	Certificates and approvals	101
12.6	Adapting the diagnostic information	72	16.13	Application packages	102
12.6.1	Adapting the diagnostic behavior	72	16.14	Accessories	102
12.7	Overview of diagnostic information	72	16.15	Supplementary documentation	103
12.8	Pending diagnostic events	74	17	Appendix	104
12.9	Diagnostic list	75	17.1	Overview of the operating menu	104
12.10	Event logbook	75	17.1.1	Main menu	104
12.10.1	Event history	75	17.1.2	"Operation" menu	104
12.10.2	Filtering the event logbook	76	17.1.3	"Setup" menu	105
12.10.3	Overview of information events	76	17.1.4	"Diagnostics" menu	107
12.11	Resetting the measuring device	77	17.1.5	"Expert" menu	109
12.12	Device information	77	Index	119	
12.13	Firmware history	78			





1 Document information

1.1 Document function







These Operating Instructions contain all the information that is required in various phases of the life cycle of the device: from product identification, incoming acceptance and storage, to mounting, connection, operation and commissioning through to troubleshooting, maintenance and disposal.

1.2 Symbols used



1.2.1 Safety symbols

Symbol	Meaning
	DANGER! This symbol alerts you to a dangerous situation. Failure to avoid this situation will result in serious or fatal injury.
	WARNING! This symbol alerts you to a dangerous situation. Failure to avoid this situation can result in serious or fatal injury.
	CAUTION! This symbol alerts you to a dangerous situation. Failure to avoid this situation can result in minor or medium injury.
	NOTE! This symbol contains information on procedures and other facts which do not result in personal injury.











1.2.2 Electrical symbols

Symbol	Meaning
	Direct current A terminal to which DC voltage is applied or through which direct current flows.
	Alternating current A terminal to which alternating voltage is applied or through which alternating current flows.
	Direct current and alternating current <ul style="list-style-type: none"> ▪ A terminal to which alternating voltage or DC voltage is applied. ▪ A terminal through which alternating current or direct current flows.
	Ground connection A grounded terminal which, as far as the operator is concerned, is grounded via a grounding system.
	Protective ground connection A terminal which must be connected to ground prior to establishing any other connections.
	Equipotential connection A connection that has to be connected to the plant grounding system: This may be a potential equalization line or a star grounding system depending on national or company codes of practice.





1.2.3 Tool symbols

Symbol	Meaning
	Allen key
	Open-ended wrench



1.2.4 Symbols for certain types of information

Symbol	Meaning
	Permitted Indicates procedures, processes or actions that are permitted.
	Preferred Indicates procedures, processes or actions that are preferred.
	Forbidden Indicates procedures, processes or actions that are forbidden.
	Tip Indicates additional information.
	Reference to documentation Refers to the corresponding device documentation.
	Reference to page Refers to the corresponding page number.
	Reference to graphic Refers to the corresponding graphic number and page number.
	Series of steps
	Result of a sequence of actions
	Help in the event of a problem
	Visual inspection

1.2.5 Symbols in graphics

Symbol	Meaning
1, 2, 3, ...	Item numbers
	Series of steps
A, B, C, ...	Views
A-A, B-B, C-C, ...	Sections
	Flow direction
	Hazardous area Indicates a hazardous area.
	Safe area (non-hazardous area) Indicates the non-hazardous area.

1.3 Documentation

-  For an overview of the scope of the associated Technical Documentation, refer to the following:
- The CD-ROM provided for the device (depending on the device version, the CD-ROM might not be part of the delivery!)
 - The *W@M Device Viewer* : Enter the serial number from the nameplate (www.endress.com/deviceviewer)
 - The *Endress+Hauser Operations App*: Enter the serial number from the nameplate or scan the 2-D matrix code (QR code) on the nameplate.
-  For a detailed list of the individual documents along with the documentation code (→  103)

1.3.1 Standard documentation

Document type	Purpose and content of the document
Technical Information	Planning aid for your device The document contains all the technical data on the device and provides an overview of the accessories and other products that can be ordered for the device.
Brief Operating Instructions	Guide that takes you quickly to the 1st measured value The Brief Operating Instructions contain all the essential information from incoming acceptance to initial commissioning.

1.3.2 Supplementary device-dependent documentation

Additional documents are supplied depending on the device version ordered: Always comply strictly with the instructions in the supplementary documentation. The supplementary documentation is an integral part of the device documentation.

1.4 Registered trademarks

EtherNet/IP™

Trademark of ODVA, Inc.

Microsoft®

Registered trademark of the Microsoft Corporation, Redmond, Washington, USA

Applicator®, FieldCare®, Field Xpert™, HistoROM®, Heartbeat Technology™

Registered or registration-pending trademarks of the Endress+Hauser Group

2 Basic safety instructions

2.1 Requirements for the personnel

The personnel for installation, commissioning, diagnostics and maintenance must fulfill the following requirements:

- ▶ Trained, qualified specialists must have a relevant qualification for this specific function and task
- ▶ Are authorized by the plant owner/operator
- ▶ Are familiar with federal/national regulations
- ▶ Before beginning work, the specialist staff must have read and understood the instructions in the Operating Instructions and supplementary documentation as well as in the certificates (depending on the application)
- ▶ Following instructions and basic conditions

The operating personnel must fulfill the following requirements:

- ▶ Being instructed and authorized according to the requirements of the task by the facility's owner-operator
- ▶ Following the instructions in these Operating Instructions

2.2 Designated use

Application and media

Depending on the version ordered, the measuring device can also measure potentially explosive, flammable, poisonous and oxidizing media.

Measuring devices for use in hazardous areas, in hygienic applications or in applications where there is an increased risk due to process pressure, are labeled accordingly on the nameplate.

To ensure that the measuring device remains in proper condition for the operation time:

- ▶ Only use the measuring device in full compliance with the data on the nameplate and the general conditions listed in the Operating Instructions and supplementary documentation.
- ▶ Based on the nameplate, check whether the ordered device is permitted for the intended use in the hazardous area (e.g. explosion protection, pressure vessel safety).
- ▶ Use the measuring device only for media against which the process-wetted materials are adequately resistant.
- ▶ If the measuring device is not operated at atmospheric temperature, compliance with the relevant basic conditions specified in the associated device documentation is absolutely essential: "Documentation" section (→  7).

Incorrect use

Non-designated use can compromise safety. The manufacturer is not liable for damage caused by improper or non-designated use.

WARNING

Danger of breakage of the sensor due to corrosive or abrasive fluids!

- ▶ Verify the compatibility of the process fluid with the sensor material.
- ▶ Ensure the resistance of all fluid-wetted materials in the process.
- ▶ Observe the specified pressure and temperature range.

Verification for borderline cases:

- ▶ For special fluids and fluids for cleaning, Endress+Hauser is glad to provide assistance in verifying the corrosion resistance of fluid-wetted materials, but does not accept any warranty or liability as minute changes in the temperature, concentration or level of contamination in the process can alter the corrosion resistance properties.

Residual risks

The external surface temperature of the housing can increase by max. 10 K due to the power consumption of the electronic components. Hot process fluids passing through the measuring device will further increase the surface temperature of the housing. The surface of the sensor, in particular, can reach temperatures which are close to the fluid temperature.

Possible burn hazard due to fluid temperatures!

- ▶ For elevated fluid temperature, ensure protection against contact to prevent burns.

2.3 Workplace safety

For work on and with the device:

- ▶ Wear the required personal protective equipment according to federal/national regulations.

For welding work on the piping:

- ▶ Do not ground the welding unit via the measuring device.

If working on and with the device with wet hands:

- ▶ It is recommended to wear gloves on account of the higher risk of electric shock.

2.4 Operational safety

Risk of injury.

- ▶ Operate the device in proper technical condition and fail-safe condition only.
- ▶ The operator is responsible for interference-free operation of the device.

Conversions to the device

Unauthorized modifications to the device are not permitted and can lead to unforeseeable dangers.

- ▶ If, despite this, modifications are required, consult with Endress+Hauser.

Repair

To ensure continued operational safety and reliability,

- ▶ Carry out repairs on the device only if they are expressly permitted.
- ▶ Observe federal/national regulations pertaining to repair of an electrical device.
- ▶ Use original spare parts and accessories from Endress+Hauser only.

2.5 Product safety

This measuring device is designed in accordance with good engineering practice to meet state-of-the-art safety requirements, has been tested, and left the factory in a condition in which it is safe to operate.

It meets general safety standards and legal requirements. It also complies with the EC directives listed in the device-specific EC Declaration of Conformity. Endress+Hauser confirms this by affixing the CE mark to the device.

2.6 IT security

We only provide a warranty if the device is installed and used as described in the Operating Instructions. The device is equipped with security mechanisms to protect it against any inadvertent changes to the device settings.

IT security measures in line with operators' security standards and designed to provide additional protection for the device and device data transfer must be implemented by the operators themselves.

3 Product description

3.1 Product design

3.1.1 Device version with EtherNet/IP communication type

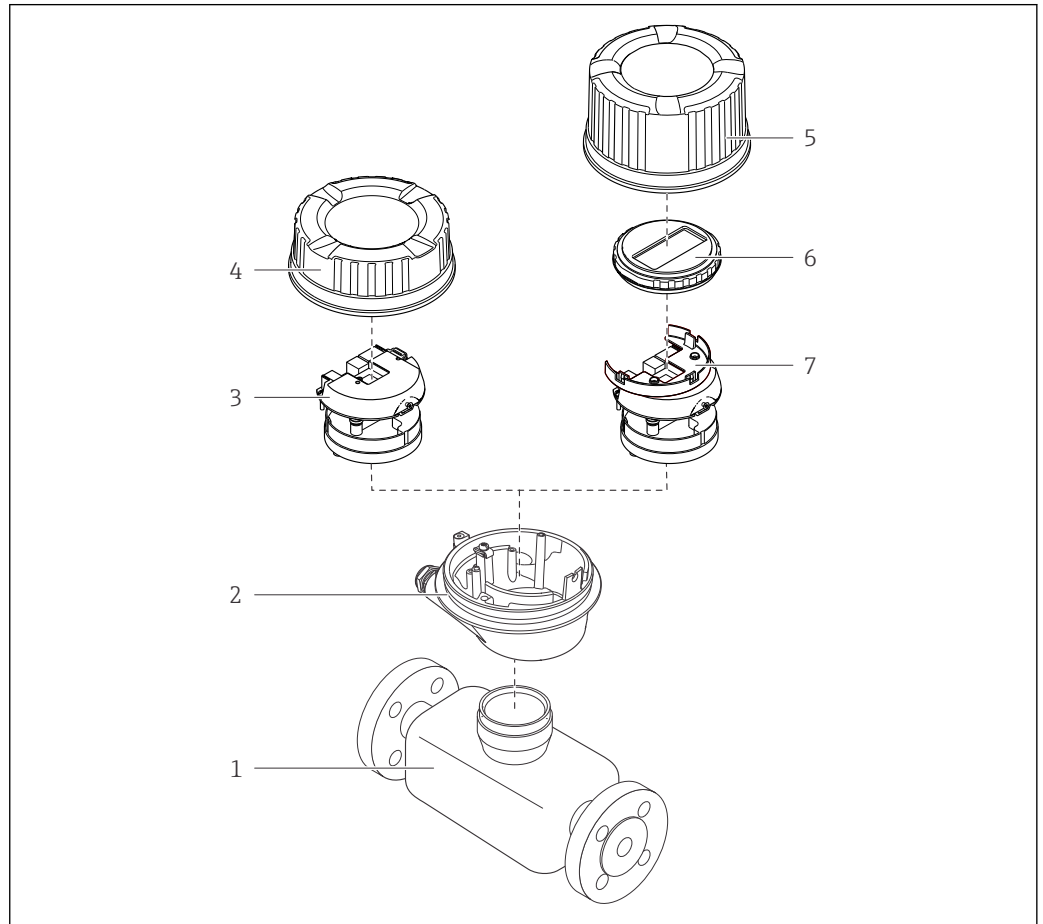





A0023153

1 Important components of a measuring device

- 1 Sensor
- 2 Transmitter housing
- 3 Main electronics module
- 4 Transmitter housing cover
- 5 Transmitter housing cover (version for optional onsite display)
- 6 Onsite display (optional)
- 7 Main electronics module (with bracket for optional onsite display)





4 Incoming acceptance and product identification

4.1 Incoming acceptance

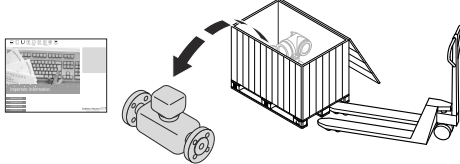



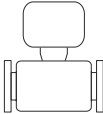

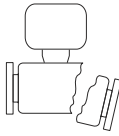



Are the order codes on the delivery note (1) and the product sticker (2) identical?

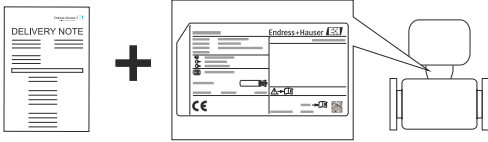





Are the goods undamaged?

Do the nameplate data match the ordering information on the delivery note?

Is the CD-ROM with the Technical Documentation (depends on device version) and documents present?



-  If one of the conditions is not satisfied, contact your Endress+Hauser Sales Center.
- Depending on the device version, the CD-ROM might not be part of the delivery! In such cases, the technical documentation is available via the Internet or via the *Endress+Hauser Operations App*, see the "Product identification" section (→  13).

4.2 Product identification

The following options are available for identification of the measuring device:

- Nameplate specifications
- Order code with breakdown of the device features on the delivery note
- Enter serial numbers from nameplates in *W@M Device Viewer* (www.endress.com/deviceviewer): All information about the measuring device is displayed.
- Enter the serial number from the nameplates into the *Endress+Hauser Operations App* or scan the 2-D matrix code (QR code) on the nameplate with the *Endress+Hauser Operations App*: all the information for the measuring device is displayed.

For an overview of the scope of the associated Technical Documentation, refer to the following:

- The chapters "Additional standard documentation on the device" (→  7) and "Supplementary device-dependent documentation" (→  7)
- The *W@M Device Viewer*: Enter the serial number from the nameplate (www.endress.com/deviceviewer)
- The *Endress+Hauser Operations App*: Enter the serial number from the nameplate or scan the 2-D matrix code (QR code) on the nameplate.

4.2.1 Transmitter nameplate

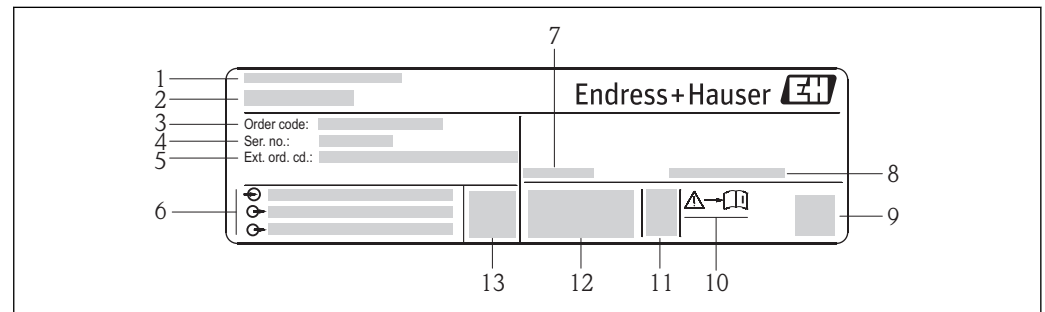

A0017520

 2 Example of a transmitter nameplate

- 1 Manufacturing location
- 2 Name of the transmitter
- 3 Order code
- 4 Serial number
- 5 Extended order code
- 6 Electrical connection data, e.g. available inputs and outputs, supply voltage
- 7 Permitted ambient temperature range (T_a)
- 8 Degree of protection
- 9 2-D matrix code
- 10 Document number of safety-related supplementary documentation
- 11 Manufacturing date: year-month
- 12 CE mark, C-Tick
- 13 Firmware version (FW)

4.2.2 Sensor nameplate

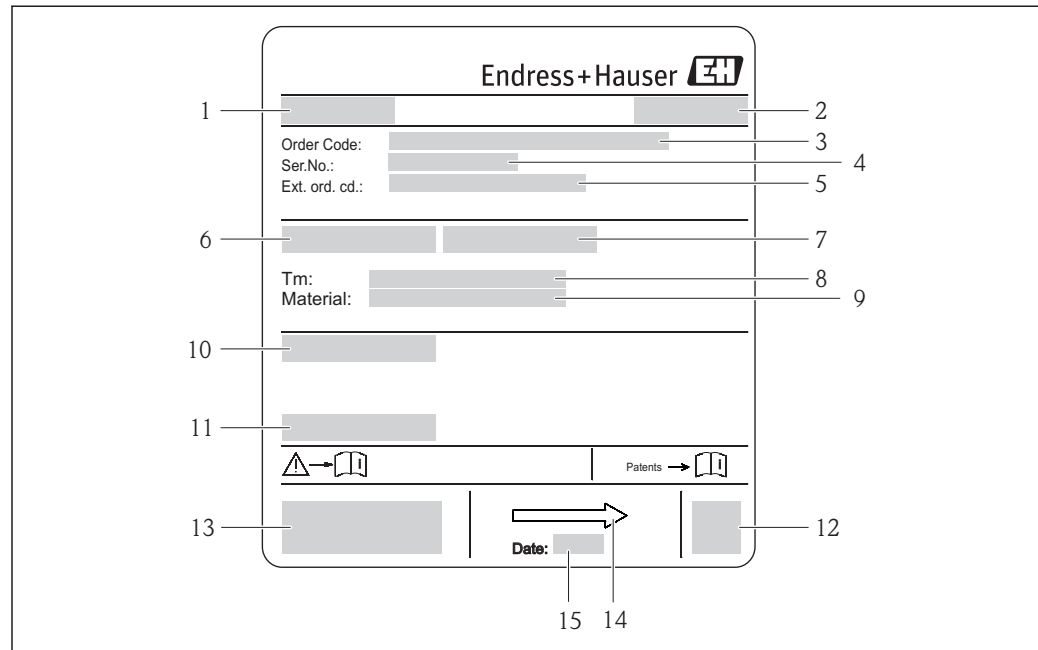

A0017186

 3 Example of sensor nameplate

- 1 Name of the sensor
- 2 Manufacturing location
- 3 Order code
- 4 Serial number (Ser. no.)
- 5 Extended order code (Ext. ord. cd.)
- 6 Nominal diameter of sensor
- 7 Test pressure of the sensor
- 8 Medium temperature range
- 9 Material of lining and electrodes
- 10 Degree of protection: e.g. IP, NEMA
- 11 Permitted ambient temperature (T_a)
- 12 2-D matrix code
- 13 CE mark, C-Tick
- 14 Flow direction
- 15 Manufacturing date: year-month





Order code

The measuring device is reordered using the order code.

Extended order code

- The device type (product root) and basic specifications (mandatory features) are always listed.
- Of the optional specifications (optional features), only the safety and approval-related specifications are listed (e.g. LA). If other optional specifications are also ordered, these are indicated collectively using the # placeholder symbol (e.g. #LA#).
- If the ordered optional specifications do not include any safety and approval-related specifications, they are indicated by the + placeholder symbol (e.g. XXXXXX-ABCDE +).

4.2.3 Symbols on measuring device

Symbol	Meaning
	WARNING! This symbol alerts you to a dangerous situation. Failure to avoid this situation can result in serious or fatal injury.
 A0011194	Reference to documentation Refers to the corresponding device documentation.
 A0011199	Protective ground connection A terminal which must be connected to ground prior to establishing any other connections.

5 Storage and transport

5.1 Storage conditions

Observe the following notes for storage:

- Store in the original packaging to ensure protection from shock.
- Do not remove protective covers or protective caps installed on process connections. They prevent mechanical damage to the sealing surfaces and contamination in the measuring tube.
- Protect from direct sunlight to avoid unacceptably high surface temperatures.
- Select a storage location where moisture cannot collect in the measuring device as fungus and bacteria infestation can damage the lining.
- Store in a dry and dust-free place.
- Do not store outdoors.
- Storage temperature(→ 📄 92)

5.2 Transporting the product

⚠ WARNING

Center of gravity of the measuring device is higher than the suspension points of the webbing slings.

Risk of injury if the measuring device slips.

- ▶ Secure the measuring device from rotating or slipping.
- ▶ Observe the weight specified on the packaging (stick-on label).
- ▶ Observe the transport instructions on the stick-on label on the electronics compartment cover.

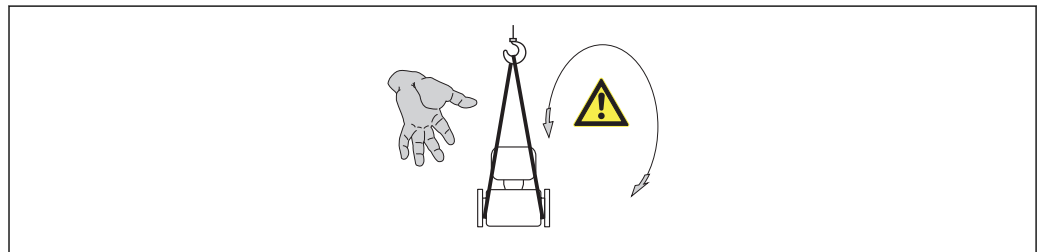

A0015606

- i** ▪ Transport the measuring device to the measuring point in the original packaging.
- Lifting gear
 - Webbing slings: Do not use chains, as they could damage the housing.
 - For wood crates, the floor structure enables these to be loaded lengthwise or broadside using a forklift.
- Use the webbing slings to lift the measuring device at the process connections; do not lift at the transmitter housing.
- Do not remove protective covers or protective caps installed on process connections. They prevent mechanical damage to the sealing surfaces and contamination in the measuring tube.

5.3 Packaging disposal

All packaging materials are environmentally friendly and 100% recyclable:

- Measuring device secondary packaging: polymer stretch film that conforms to EC Directive 2002/95/EC (RoHS).
- Packaging:
 - Wood crate, treated in accordance with ISPM 15 standard, which is confirmed by the affixed IPPC logo.
 - or
 - Carton in accordance with European Packaging Directive 94/62EC; recyclability is confirmed by the affixed RESY symbol.
- Seaworthy packaging (optional): Wood crate, treated in accordance with ISPM 15 standard, which is confirmed by the affixed IPPC logo.
- Carrying and mounting hardware:
 - Disposable plastic pallet
 - Plastic straps
 - Plastic adhesive strips
- Dunnage: Paper cushion

6 Mounting

6.1 Installation conditions

6.1.1 Mounting position

Mounting location

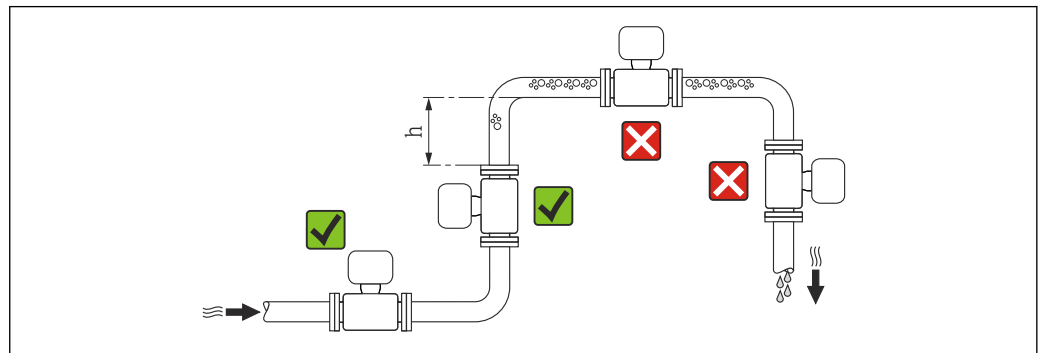

A0023343



Preferably install the sensor in an ascending pipe, and ensure a sufficient distance to the next pipe elbow: $h \geq 2 \times DN$

To prevent measuring errors arising from accumulation of gas bubbles in the measuring tube, avoid the following mounting locations in the pipe:

- Highest point of a pipeline.
- Directly upstream of a free pipe outlet in a down pipe.

Installation in down pipes

Install a siphon with a vent valve downstream of the sensor in down pipes whose length $h \geq 5 \text{ m}$ (16.4 ft). This precaution is to avoid low pressure and the consequent risk of damage to the measuring tube. This measure also prevents the system losing prime.

 For information on the liner's resistance to partial vacuum (\rightarrow  94)

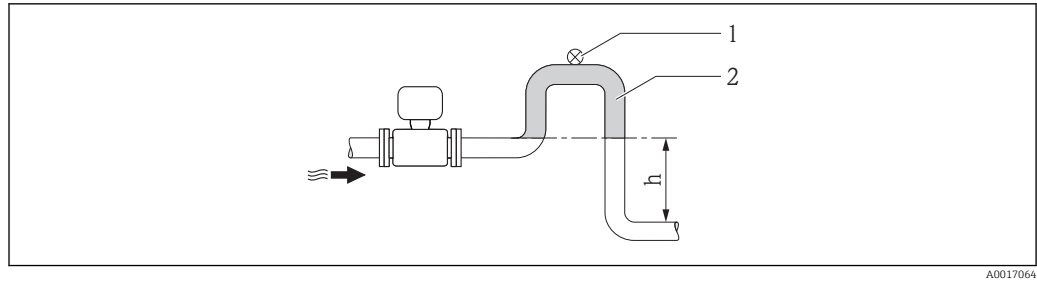

4 Installation in a down pipe

- 1 Vent valve
- 2 Pipe siphon
- h Length of down pipe

Installation in partially filled pipes

A partially filled pipe with a gradient necessitates a drain-type configuration. The empty pipe detection (EPD) function offers additional protection by detecting empty or partially filled pipes.

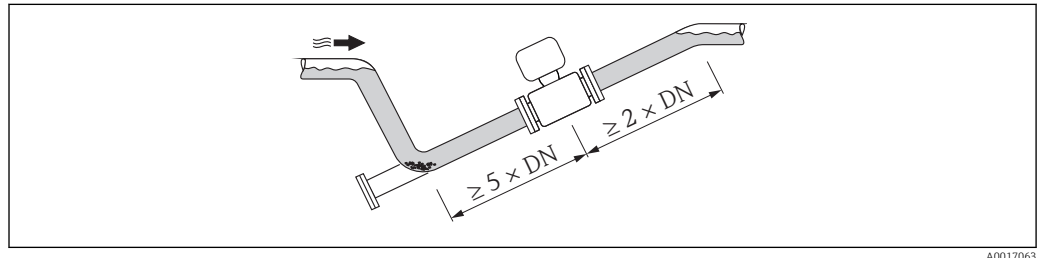

Orientation

The direction of the arrow on the sensor nameplate helps you to install the sensor according to the flow direction (direction of medium flow through the piping).

An optimum orientation position helps avoid gas and air accumulations and deposits in the measuring tube.

The measuring device also offers the empty pipe detection function to detect partially filled measuring pipes in the event of outgassing fluids or variable process pressures.

Vertical

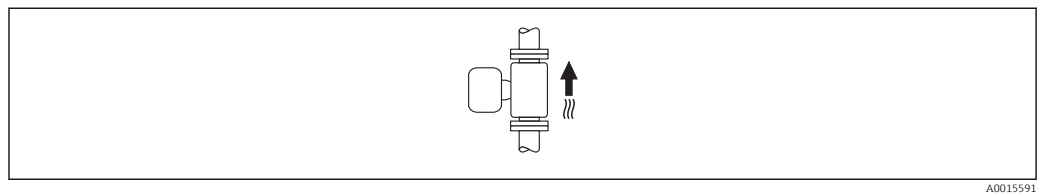

This is the optimum for self-emptying piping systems and for use in conjunction with empty pipe detection.

Horizontal

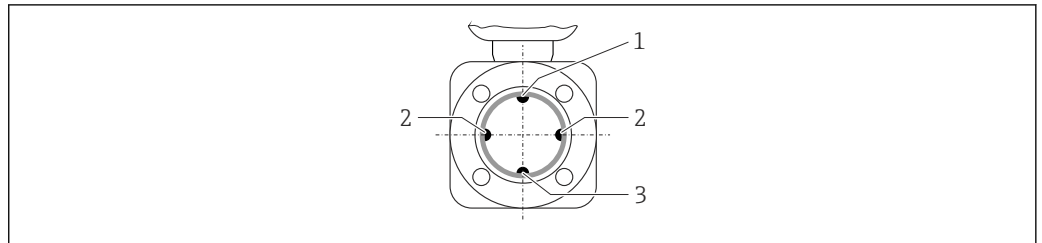

A0016260

- 1 EPD electrode for empty pipe detection
- 2 Measuring electrodes for signal detection
- 3 Reference electrode for potential equalization

-  The measuring electrode plane must be horizontal. This prevents brief insulation of the two measuring electrodes by entrained air bubbles.
- The empty pipe detection only works if the transmitter housing is pointing upwards as otherwise there is no guarantee that the empty pipe detection function will actually respond to a partially filled or empty measuring tube.

Inlet and outlet runs

If possible, install the sensor upstream from fittings such as valves, T-pieces or elbows.

Observe the following inlet and outlet runs to comply with accuracy specifications:

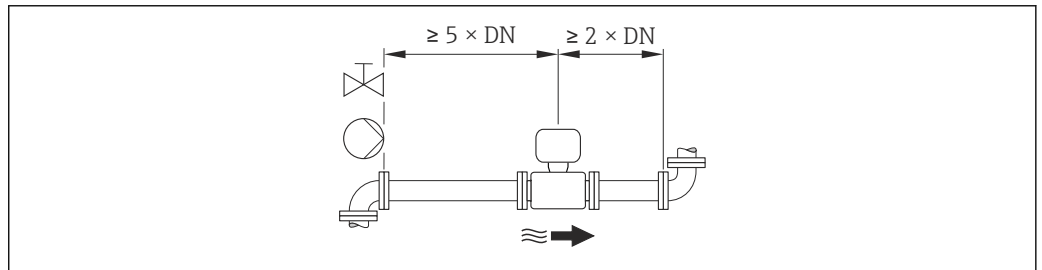

A0016275

Installation dimensions

 For the dimensions and installation lengths of the device, see the "Technical Information" document, "Mechanical construction" section

6.1.2 Requirements from environment and process

Ambient temperature range

Transmitter	-40 to +60 °C (-40 to +140 °F)
Sensor	<ul style="list-style-type: none"> ▪ Process connection material, carbon steel: -10 to +60 °C (+14 to +140 °F) ▪ Process connection material, stainless steel: -40 to +60 °C (-40 to +140 °F)
Liner	Do not exceed or fall below the permitted temperature range of the liner (→ 93).

If operating outdoors:

- Install the measuring device in a shady location.
- Avoid direct sunlight, particularly in warm climatic regions.
- Avoid direct exposure to weather conditions.

Temperature tables

SI units

T _a [°C]	T6 [85 °C]	T5 [100 °C]	T4 [135 °C]	T3 [200 °C]	T2 [300 °C]	T1 [450 °C]
30	50	95	130	150	150	150
50	-	95	130	150	150	150
60	-	95	110	110	110	110

US units

T _a [°F]	T6 [185 °F]	T5 [212 °F]	T4 [275 °F]	T3 [392 °F]	T2 [572 °F]	T1 [842 °F]
86	122	203	266	302	302	302
122	-	203	266	302	302	302
140	-	203	230	230	230	230

System pressure

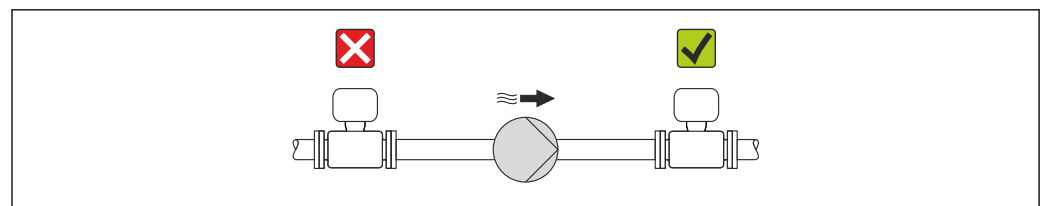

Never install the sensor on the pump suction side in order to avoid the risk of low pressure, and thus damage to the liner.

i Furthermore, install pulse dampers if reciprocating, diaphragm or peristaltic pumps are used.

- i** ■ For information on the liner's resistance to partial vacuum (→ 94)
- Information on the shock resistance of the measuring system (→ 93)
- Information on the vibration resistance of the measuring system (→ 93)

Vibrations

In the event of very strong vibrations, the pipe and sensor must be supported and fixed.

- i** Information on the shock resistance of the measuring system (→ 93)
- Information on the vibration resistance of the measuring system (→ 93)

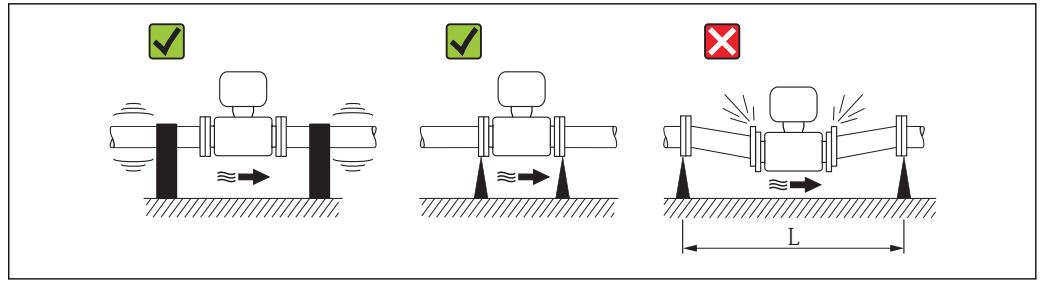

5 Measures to avoid device vibrations ($L > 10\text{ m}$ (33 ft))

Adapters

Suitable adapters to DIN EN 545 (double-flange reducers) can be used to install the sensor in larger-diameter pipes. The resultant increase in the rate of flow improves measuring accuracy with very slow-moving fluids. The nomogram shown here can be used to calculate the pressure loss caused by reducers and expanders.

i The nomogram only applies to liquids with a viscosity similar to that of water.

1. Calculate the ratio of the diameters d/D .
2. From the nomogram read off the pressure loss as a function of flow velocity (downstream from the reduction) and the d/D ratio.

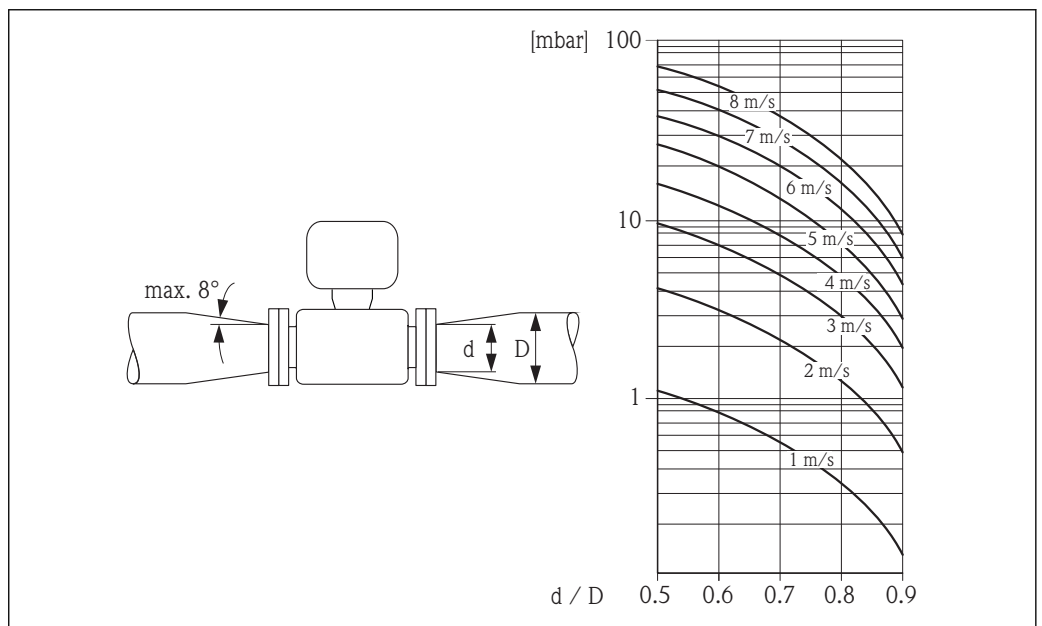

6.2 Mounting the measuring device

6.2.1 Required tools

For sensor

For flanges and other process connections:

- Screws, nuts, seals etc. are not included in the scope of supply and must be provided by the customer.
- Appropriate mounting tools

6.2.2 Preparing the measuring device

1. Remove all remaining transport packaging.
2. Remove any protective covers or protective caps present from the sensor.
3. Remove stick-on label on the electronics compartment cover.

6.2.3 Mounting the sensor

⚠ WARNING

Danger due to improper process sealing!

- ▶ Ensure that the inside diameters of the gaskets are greater than or equal to that of the process connections and piping.
 - ▶ Ensure that the gaskets are clean and undamaged.
 - ▶ Install the gaskets correctly.
1. Ensure that the direction of the arrow on the sensor matches the flow direction of the medium.
 2. To ensure compliance with device specifications, install the measuring device between the pipe flanges in a way that it is centered in the measurement section.
 3. If using ground disks, comply with the Installation Instructions provided.
 4. Observe required screw tightening torques (→  23).
 5. Install the measuring device or turn the transmitter housing so that the cable entries do not point upwards.

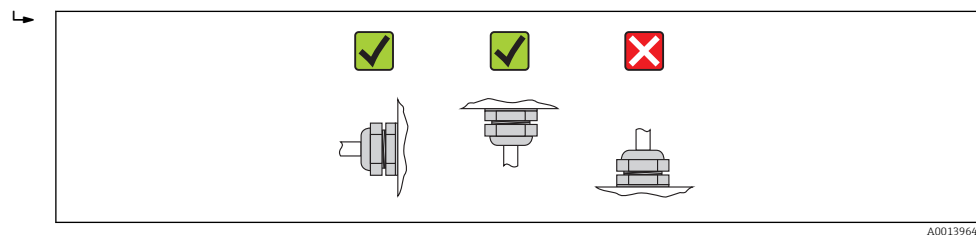

A0013964

Mounting the seals

⚠ CAUTION

An electrically conductive layer could form on the inside of the measuring tube!

Risk of measuring signal short circuit.

- ▶ Do not use electrically conductive sealing compounds such as graphite.

Comply with the following instructions when installing seals:

- When mounting the process connections, make sure that the seals concerned are clean and centered correctly.
- For DIN flanges: only use seals according to DIN EN 1514-1.
- For "PFA" lining: additional seals are **always** required.
- For "PTFE" lining: generally additional seals are **not** required.

Mounting the ground cable/ground disks

Comply with the information on potential equalization and detailed mounting instructions for the use of ground cables/ground disks (→  31).

Screw tightening torques

Please note the following:

- The screw tightening torques listed below apply only to lubricated threads and to pipes not subjected to tensile stress.
- Tighten the screws uniformly and in diagonally opposite sequence.
- Overtightening the screws will deform the sealing faces or damage the seals.

Screw tightening torques for EN 1092-1 (DIN 2501), PN 40/25

Nominal diameter [mm]	Pressure rating [bar]	Threaded fasteners [mm]	Max. screw tightening torque [Nm]	
			PTFE	PFA
15	PN 40	4 × M12	11	–
25	PN 40	4 × M12	26	20
32	PN 40	4 × M16	41	35
40	PN 40	4 × M16	52	47
50	PN 40	4 × M16	65	59
65 ¹⁾	PN 16	8 × M16	43	40
65	PN 40	8 × M16	43	40
80	PN 16	8 × M16	53	48
80	PN 40	8 × M16	53	48
100	PN 16	8 × M16	57	51
100	PN 40	8 × M20	78	70
125	PN 16	8 × M16	75	67
125	PN 40	8 × M24	111	99
150	PN 16	8 × M20	99	85
150	PN 40	8 × M24	136	120
200	PN 10	8 × M20	141	101
200	PN 16	12 × M20	94	67
200	PN 25	12 × M24	138	105
250	PN 10	12 × M20	110	–
250	PN 16	12 × M24	131	–
250	PN 25	12 × M27	200	–
300	PN 10	12 × M20	125	–
300	PN 16	12 × M24	179	–
300	PN 25	16 × M27	204	–
350	PN 10	16 × M20	188	–
350	PN 16	16 × M24	254	–
350	PN 25	16 × M30	380	–
400	PN 10	16 × M24	260	–
400	PN 16	16 × M27	330	–
400	PN 25	16 × M33	488	–
450	PN 10	20 × M24	235	–
450	PN 16	20 × M27	300	–
450	PN 25	20 × M33	385	–
500	PN 10	20 × M24	265	–
500	PN 16	20 × M30	448	–

Nominal diameter [mm]	Pressure rating [bar]	Threaded fasteners [mm]	Max. screw tightening torque [Nm]	
			PTFE	PFA
500	PN 25	20 × M33	533	–
600	PN 10	20 × M27	345	–
600 ¹⁾	PN 16	20 × M33	658	–
600	PN 25	20 × M36	731	–

1) Designed acc. to EN 1092-1 (not to DIN 2501)

Screw tightening torques for ASME B16.5, Class 150/300

Nominal diameter		Pressure rating [psi]	Threaded fasteners [in]	Max. screw tightening torque [Nm] ([lbf · ft])	
[mm]	[in]			PTFE	PFA
15	½	Class 150	4 × ½	6 (4)	– (-)
15	½	Class 300	4 × ½	6 (4)	– (-)
25	1	Class 150	4 × ½	11 (8)	10 (7)
25	1	Class 300	4 × 5/8	14 (10)	12 (9)
40	1 ½	Class 150	4 × ½	24 (18)	21 (15)
40	1 ½	Class 300	4 × ¾	34 (25)	31 (23)
50	2	Class 150	4 × 5/8	47 (35)	44 (32)
50	2	Class 300	8 × 5/8	23 (17)	22 (16)
80	3	Class 150	4 × 5/8	79 (58)	67 (49)
80	3	Class 300	8 × ¾	47 (35)	42 (31)
100	4	Class 150	8 × 5/8	56 (41)	50 (37)
100	4	Class 300	8 × ¾	67 (49)	59 (44)
150	6	Class 150	8 × ¾	106 (78)	86 (63)
150	6	Class 300	12 × ¾	73 (54)	67 (49)
200	8	Class 150	8 × ¾	143 (105)	109 (80)
250	10	Class 150	12 × 7/8	135 (100)	– (-)
300	12	Class 150	12 × 7/8	178 (131)	– (-)
350	14	Class 150	12 × 1	260 (192)	– (-)
400	16	Class 150	16 × 1	246 (181)	– (-)
450	18	Class 150	16 × 1 1/8	371 (274)	– (-)
500	20	Class 150	20 × 1 1/8	341 (252)	– (-)
600	24	Class 150	20 × 1 ¼	477 (352)	– (-)

Screw tightening torques for JIS B2220, 10/20K

Nominal diameter [mm]	Pressure rating [bar]	Threaded fasteners [mm]	Max. screw tightening torque [Nm]	
			PTFE	PFA
25	10K	4 × M16	32	27
25	20K	4 × M16	32	27
32	10K	4 × M16	38	–
32	20K	4 × M16	38	–
40	10K	4 × M16	41	37

Nominal diameter [mm]	Pressure rating [bar]	Threaded fasteners [mm]	Max. screw tightening torque [Nm]	
			PTFE	PFA
40	20K	4 × M16	41	37
50	10K	4 × M16	54	46
50	20K	8 × M16	27	23
65	10K	4 × M16	74	63
65	20K	8 × M16	37	31
80	10K	8 × M16	38	32
80	20K	8 × M20	57	46
100	10K	8 × M16	47	38
100	20K	8 × M20	75	58
125	10K	8 × M20	80	66
125	20K	8 × M22	121	103
150	10K	8 × M20	99	81
150	20K	12 × M22	108	72
200	10K	12 × M20	82	54
200	20K	12 × M22	121	88
250	10K	12 × M22	133	-
250	20K	12 × M24	212	-
300	10K	16 × M22	99	-
300	20K	16 × M24	183	-

Screw tightening torques for AS 2129, Table E

Nominal diameter [mm]	Threaded fasteners [mm]	Max. screw tightening torque [Nm]
		PTFE
25	4 × M12	21
50	4 × M16	42

Screw tightening torques for AS 4087, PN 16

Nominal diameter [mm]	Threaded fasteners [mm]	Max. screw tightening torque [Nm]
		PTFE
50	4 × M16	42

6.2.4 Turning the display module

The display module can be turned to optimize display readability.

Aluminum housing version, AlSi10Mg, coated

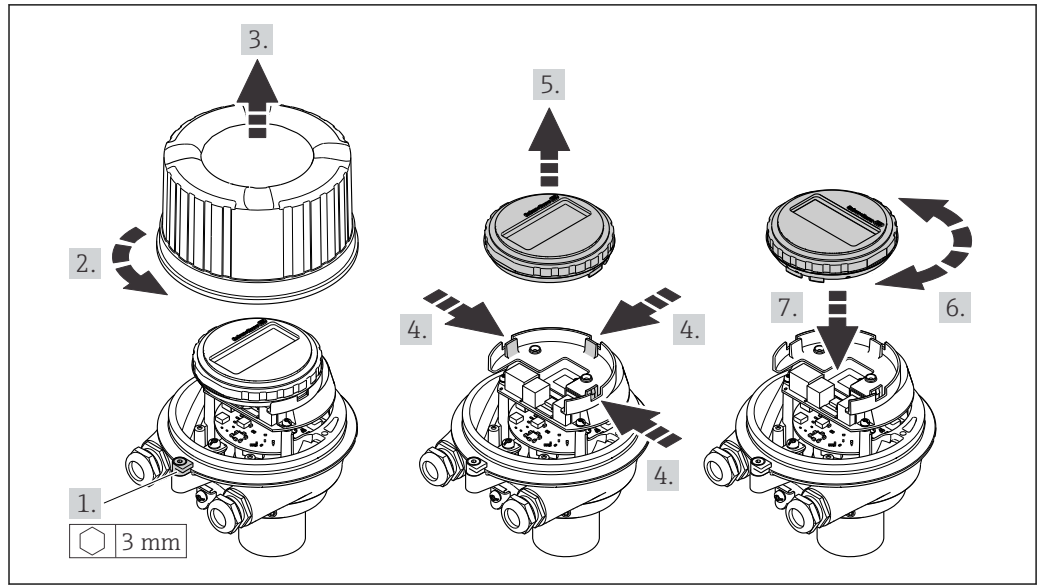

A0023192

6.3 Post-installation check

Is the device undamaged (visual inspection)?	<input type="checkbox"/>
Does the measuring device conform to the measuring point specifications? For example: <ul style="list-style-type: none"> ■ Process temperature ■ Process pressure (refer to the section on "Pressure-temperature ratings" in the "Technical Information" document) ■ Ambient temperature ■ Measuring range 	<input type="checkbox"/>
Has the correct orientation for the sensor been selected ? <ul style="list-style-type: none"> ■ According to sensor type ■ According to medium temperature ■ According to medium properties (outgassing, with entrained solids) 	<input type="checkbox"/>
Does the arrow on the sensor nameplate match the direction of flow of the fluid through the piping ?	<input type="checkbox"/>
Are the measuring point identification and labeling correct (visual inspection)?	<input type="checkbox"/>
Is the device adequately protected from precipitation and direct sunlight?	<input type="checkbox"/>
Have the fixing screws been tightened with the correct tightening torque?	<input type="checkbox"/>

7 Electrical connection

 The measuring device does not have an internal circuit breaker. For this reason, assign the measuring device a switch or power-circuit breaker so that the power supply line can be easily disconnected from the mains.

7.1 Connection conditions

7.1.1 Required tools

- For cable entries: Use corresponding tools
- For securing clamp (on aluminum housing): Allen screw 3 mm
- For securing screw (for stainless steel housing): open-ended wrench 8 mm
- Wire stripper
- When using stranded cables: crimping tool for ferrule

7.1.2 Requirements for connecting cable

The connecting cables provided by the customer must fulfill the following requirements.

Electrical safety

In accordance with applicable federal/national regulations.

Permitted temperature range

- -40 °C (-40 °F) to $+80\text{ °C}$ ($+176\text{ °F}$)
- Minimum requirement: cable temperature range \geq ambient temperature $+20\text{ K}$

Power supply cable

Standard installation cable is sufficient.

Signal cable

EtherNet/IP

The standard ANSI/TIA/EIA-568-B.2 Annex specifies CAT 5 as the minimum category for a cable used for EtherNet/IP. CAT 5e and CAT 6 are recommended.

 For more information on planning and installing EtherNet/IP networks, please refer to the "Media Planning and Installation Manual. EtherNet/IP" of the ODVA Organization.

Cable diameter

- Cable glands supplied:
M20 \times 1.5 with cable ϕ 6 to 12 mm (0.24 to 0.47 in)
- Spring terminals:
Wire cross-sections 0.5 to 2.5 mm² (20 to 14 AWG)

7.1.3 Terminal assignment

Transmitter

EtherNet/IP connection version

Order code for "Output", option **N**

Depending on the housing version, the transmitters can be ordered with terminals or device plugs.

Order code for "Housing"	Connection methods available		Possible options for order code "Electrical connection"
	Output	Power supply	
Option A	Device plug	Terminals	<ul style="list-style-type: none"> ▪ Option L: plug M12x1 + thread NPT 1/2" ▪ Option N: plug M12x1 + coupling M20 ▪ Option P: plug M12x1 + thread G 1/2" ▪ Option U: plug M12x1 + thread M20
Option A	Device plug	Device plug	Option Q : 2 x plug M12x1
Order code for "Housing": Option A : compact, coated aluminum			

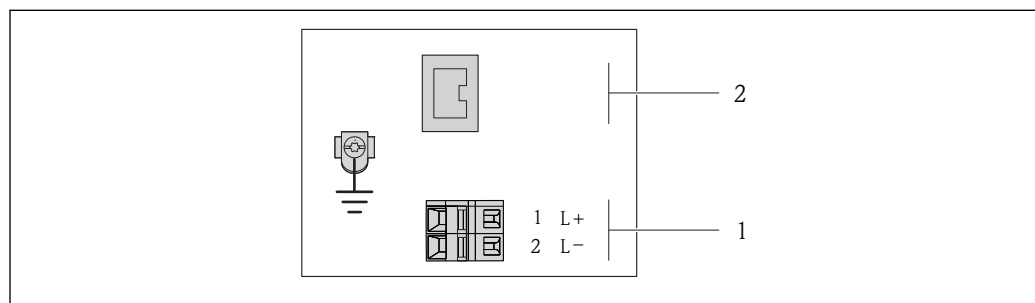

A0017054

6 EtherNet/IP terminal assignment

- 1 Power supply: DC 24 V
- 2 EtherNet/IP

Order code for "Output"	Terminal number		Output Device plug M12x1
	Power supply 2 (L-)	1 (L+)	
Option N	DC 24 V		EtherNet/IP
Order code for "Output": Option N : EtherNet/IP			

7.1.4 Pin assignment, device plug

EtherNet/IP

Device plug for supply voltage (device side)

Pin	Assignment		Coding	Plug/socket
1	L+	DC 24 V	A	Plug
2				
3				
4	L-	DC 24 V		
5		Grounding/shielding		

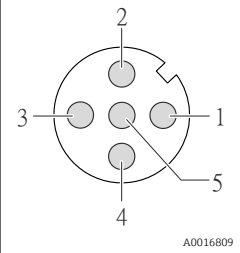

Device plug for signal transmission (device side)

Pin	Assignment		Coding	Plug/socket
1	+	Tx	D	Socket
2	+	Rx		
3	-	Tx		
4	-	Rx		

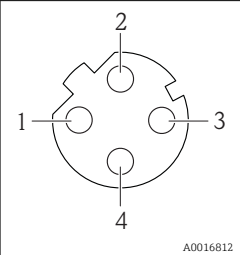

7.1.5 Preparing the measuring device

1. Remove dummy plug if present.
2. **NOTICE!** Insufficient sealing of the housing! Operational reliability of the measuring device could be compromised. Use suitable cable glands corresponding to the degree of protection.
If measuring device is delivered without cable glands:
Provide suitable cable gland for corresponding connecting cable (→ 27).
3. If measuring device is delivered with cable glands:
Observe cable specification (→ 27).

7.2 Connecting the measuring device

NOTICE

Limitation of electrical safety due to incorrect connection!

- ▶ Have electrical connection work carried out by correspondingly trained specialists only.
- ▶ Observe applicable federal/national installation codes and regulations.
- ▶ Comply with local workplace safety regulations.
- ▶ For use in potentially explosive atmospheres, observe the information in the device-specific Ex documentation.

7.2.1 Connecting the transmitter

The connection of the transmitter depends on the following order codes:

- Housing version: compact or ultra-compact
- Connection version: device plug or terminals

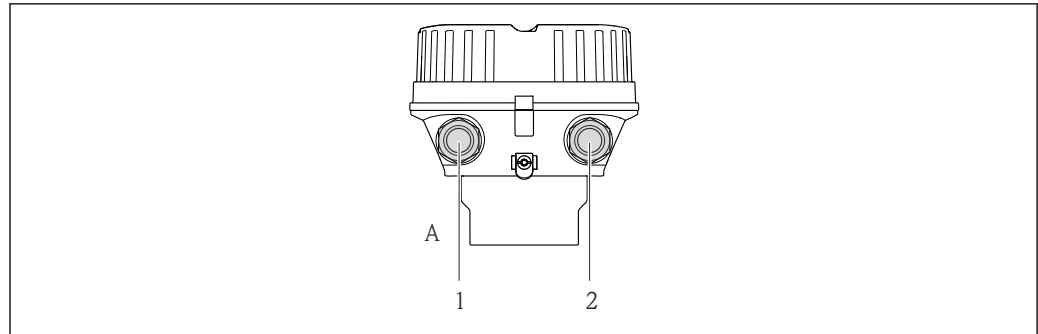

A0019824

7 Device versions and connection versions

- A Housing version: compact, aluminum coated
 1 Cable entry or device plug for signal transmission
 2 Cable entry or device plug for supply voltage

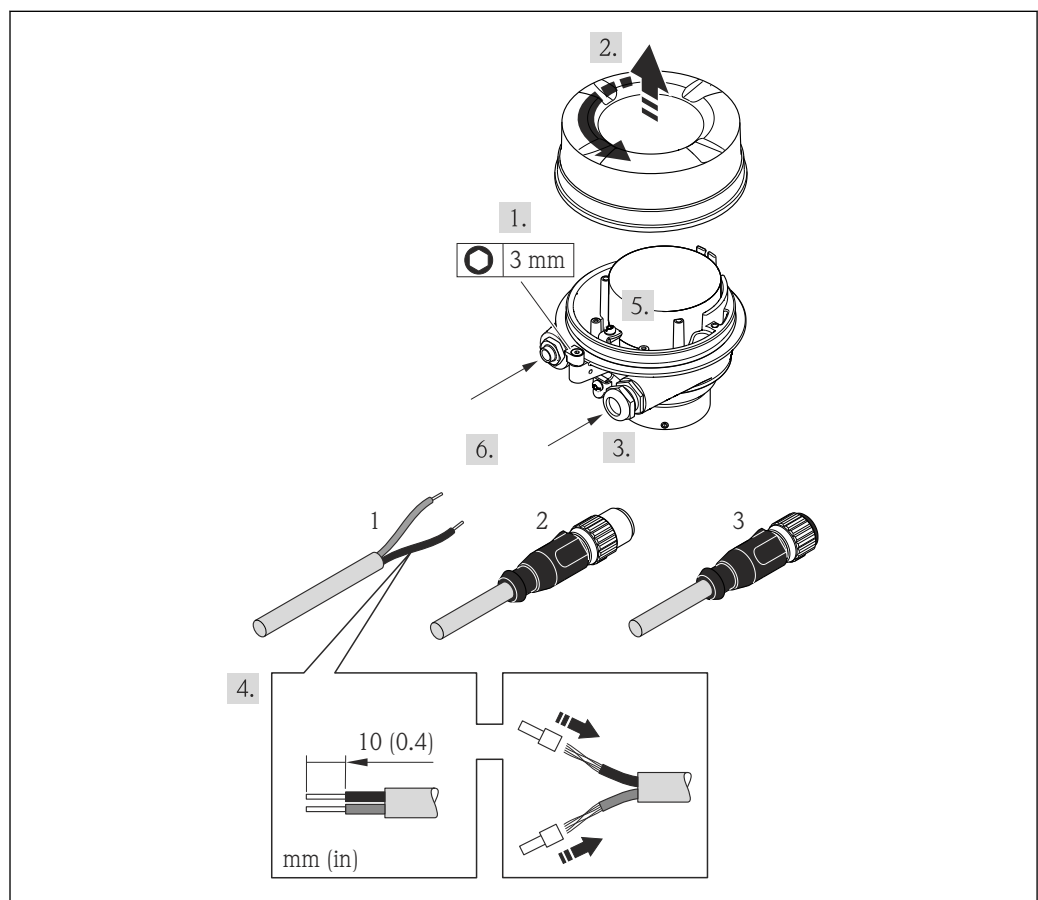

A0019823

8 Device versions with connection examples

- 1 Cable
 2 Device plug for signal transmission
 3 Device plug for supply voltage

For device version with device plug: only pay attention to Step 6.

1. Depending on the housing version, loosen the securing clamp or fixing screw of the housing cover.
2. Depending on the housing version, unscrew or open the housing cover and disconnect the local display from the main electronics module where necessary (→ 99).
3. Push the cable through the cable entry. To ensure tight sealing, do not remove the sealing ring from the cable entry.

4. Strip the cable and cable ends. In the case of stranded cables, also fit ferrules.
5. Connect the cable in accordance with the terminal assignment or the device plug pin assignment .
6. Depending on the device version: tighten the cable glands or plug in the device plug and tighten .
7. **WARNING!** Housing degree of protection may be voided due to insufficient sealing of the housing. Screw in the screw without using any lubricant. The threads on the cover are coated with a dry lubricant.
Reverse the removal procedure to reassemble the transmitter.

7.2.2 Ensuring potential equalization

CAUTION

Electrode damage can result in the complete failure of the device!

- ▶ Make sure that the fluid and sensor have the same electrical potential.
- ▶ Pay attention to internal grounding concepts in the company.
- ▶ Pay attention to the pipe material or grounding.

Connection examples for standard situations

Metal, grounded pipe

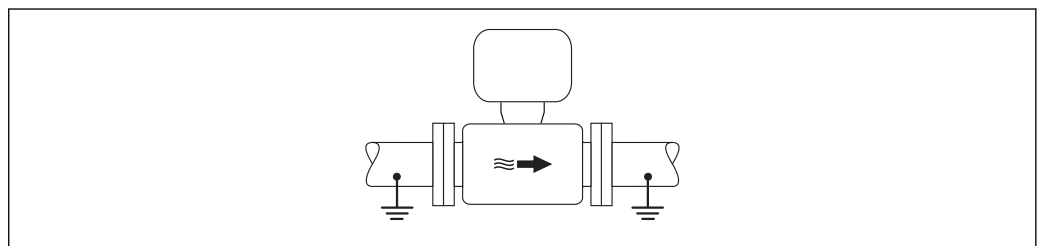

A0016315

9 Potential equalization via measuring tube

Connection example in special situations

Unlined and ungrounded metal pipe

This connection method also applies in situations where:

- The customary potential equalization is not used
- Equalizing currents are present

Ground cable	Copper wire, at least 6 mm^2 (0.0093 in ²)
---------------------	--

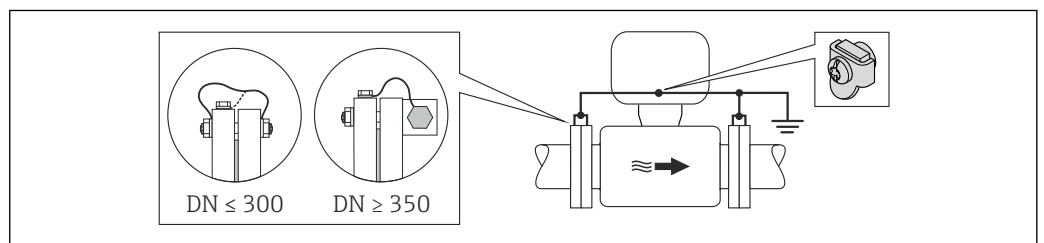

A0016317

10 Potential equalization via ground terminal and pipe flanges

1. Connect both sensor flanges to the pipe flange via a ground cable and ground them.

2. If $DN \leq 300$ (12"): Mount the ground cable directly on the conductive flange coating of the sensor with the flange screws. If $DN \geq 350$ (14"): Mount the ground cable directly on the metal transport bracket. Observe torques (\rightarrow 23).
3. Connect the connection housing of the transmitter or sensor to ground potential by means of the ground terminal provided for the purpose.

Plastic pipe or pipe with insulating liner

This connection method also applies in situations where:

- The customary potential equalization is not used
- Equalizing currents are present

Ground cable	Copper wire, at least 6 mm^2 (0.0093 in^2)
---------------------	--

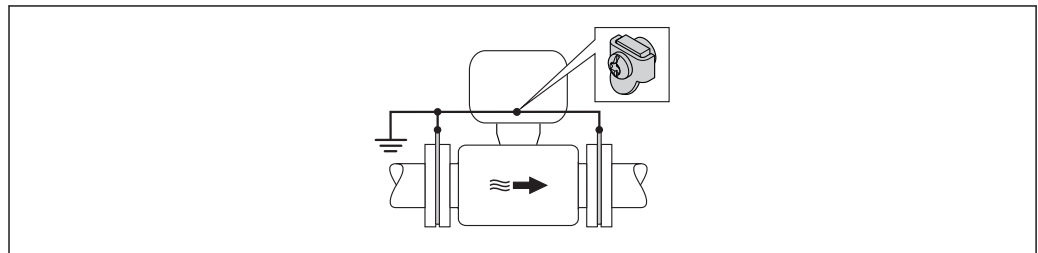

A0016318

11 Potential equalization via ground terminal and ground disks

1. Connect the ground disks to the ground terminal via the ground cable.
2. Connect the ground disks to ground potential.

Pipe with a cathodic protection unit

This connection method is only used if the following two conditions are met:

- Metal pipe without liner or pipe with electrically conductive liner
- Cathodic protection is integrated in the personal protection equipment

Ground cable	Copper wire, at least 6 mm^2 (0.0093 in^2)
---------------------	--

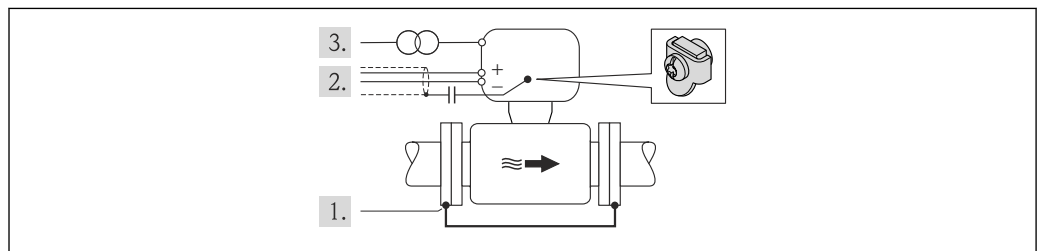

A0016319

Prerequisite: The sensor is installed in the pipe in a way that provides electrical insulation.

1. Connect the two flanges of the pipe to one another via a ground cable.
2. Guide the shield of the signal lines through a capacitor.
3. Connect the measuring device to the power supply such that it is floating in relation to the protective ground (isolation transformer).

7.3 Special connection instructions

7.3.1 Connection examples

EtherNet/IP

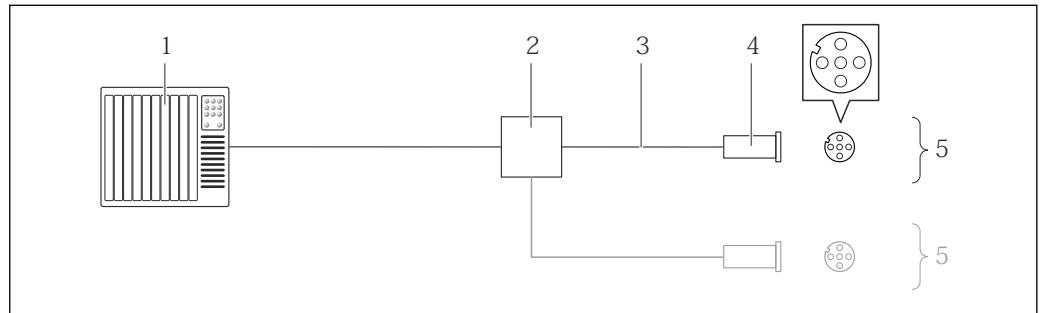

12 Connection example for EtherNet/IP

- 1 Control system (e.g. PLC)
- 2 Ethernet switch
- 3 Observe cable specifications (→ 27)
- 4 Connector
- 5 Transmitter

7.4 Hardware settings

7.4.1 Setting the device address

EtherNet/IP

The IP address of the measuring device can be configured for the network via DIP switches.

Addressing data

IP address and configuration options			
1st octet	2nd octet	3rd octet	4th octet
192.	168.	1.	XXX
	↓		↓
	Can only be configured via software addressing		Can be configured via software addressing and hardware addressing

IP address range	1 to 254 (4th octet)
IP address broadcast	255
Addressing mode ex works	Software addressing; all DIP switches for hardware addressing are set to OFF.
IP address ex works	DHCP server active

i For device addressing via software (→ 48)

Setting the address

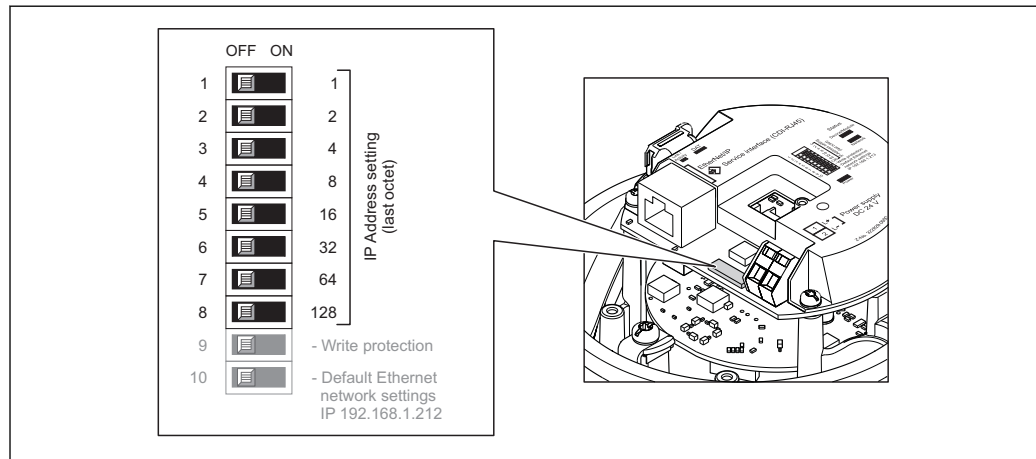

A0017913

1. Depending on the housing version, loosen the securing clamp or fixing screw of the housing cover.
2. Depending on the housing version, unscrew or open the housing cover and disconnect the local display from the main electronics module where necessary (→ 99).
3. Set the desired IP address using the corresponding DIP switches on the I/O electronics module.
 - ↳ Hardware addressing with the configured IP address is enabled after 10 s.
4. Reverse the removal procedure to reassemble the transmitter.

7.5 Ensuring the degree of protection

The measuring device fulfills all the requirements for the IP66/67 degree of protection, Type 4X enclosure.

To guarantee IP66/67 degree of protection, Type 4X enclosure, carry out the following steps after the electrical connection:

1. Check that the housing seals are clean and fitted correctly. Dry, clean or replace the seals if necessary.
2. Tighten all housing screws and screw covers.
3. Firmly tighten the cable glands.
4. To ensure that moisture does not enter the cable entry, route the cable so that it loops down before the cable entry ("water trap").

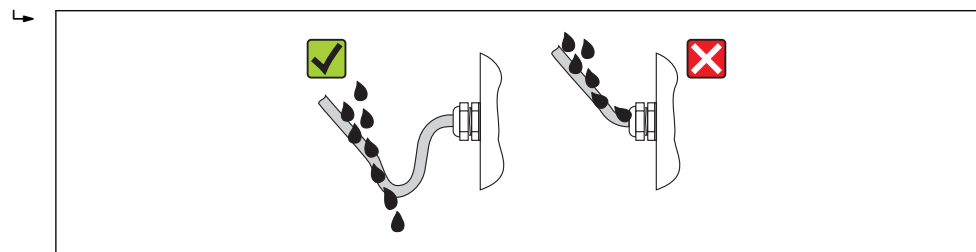

A0013960

5. Insert dummy plugs into unused cable entries.

7.6 Post-connection check

Are cables or the device undamaged (visual inspection)?	<input type="checkbox"/>
Do the cables comply with the requirements (→ 37)?	<input type="checkbox"/>
Do the cables have adequate strain relief?	<input type="checkbox"/>
Are all the cable glands installed, firmly tightened and leak-tight? Cable run with "water trap" (→ 34)?	<input type="checkbox"/>
Depending on the device version: are all the device plugs firmly tightened (→ 29)?	<input type="checkbox"/>
Does the supply voltage match the specifications on the transmitter nameplate (→ 90)?	<input type="checkbox"/>
Is the terminal assignment or the pin assignment of the device plug correct?	<input type="checkbox"/>
If supply voltage is present, is the power LED on the electronics module of the transmitter lit green (→ 11)?	<input type="checkbox"/>
Is the potential equalization established correctly (→ 31)?	<input type="checkbox"/>
Depending on the device version, is the securing clamp or fixing screw firmly tightened?	<input type="checkbox"/>

8 Operation options

8.1 Overview of operation options

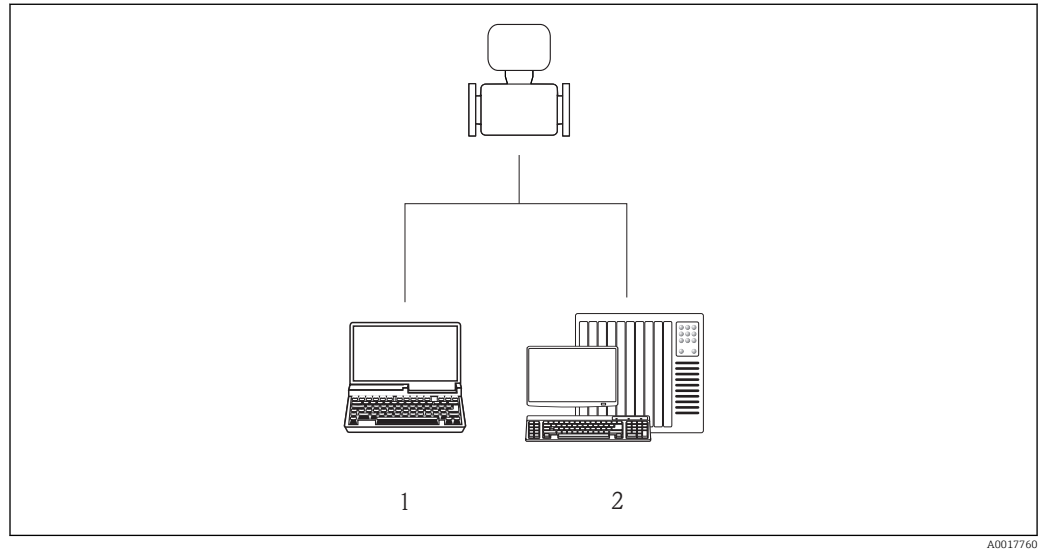



- 1 Computer with Web browser (e.g. Internet Explorer) or with "FieldCare" operating tool
- 2 Automation system, e.g. "RSLogix" (Rockwell Automation) and work station for measuring device operation with Add-on Profile Level 3 for "RSLogix 5000" software (Rockwell Automation)

8.2 Structure and function of the operating menu

8.2.1 Structure of the operating menu

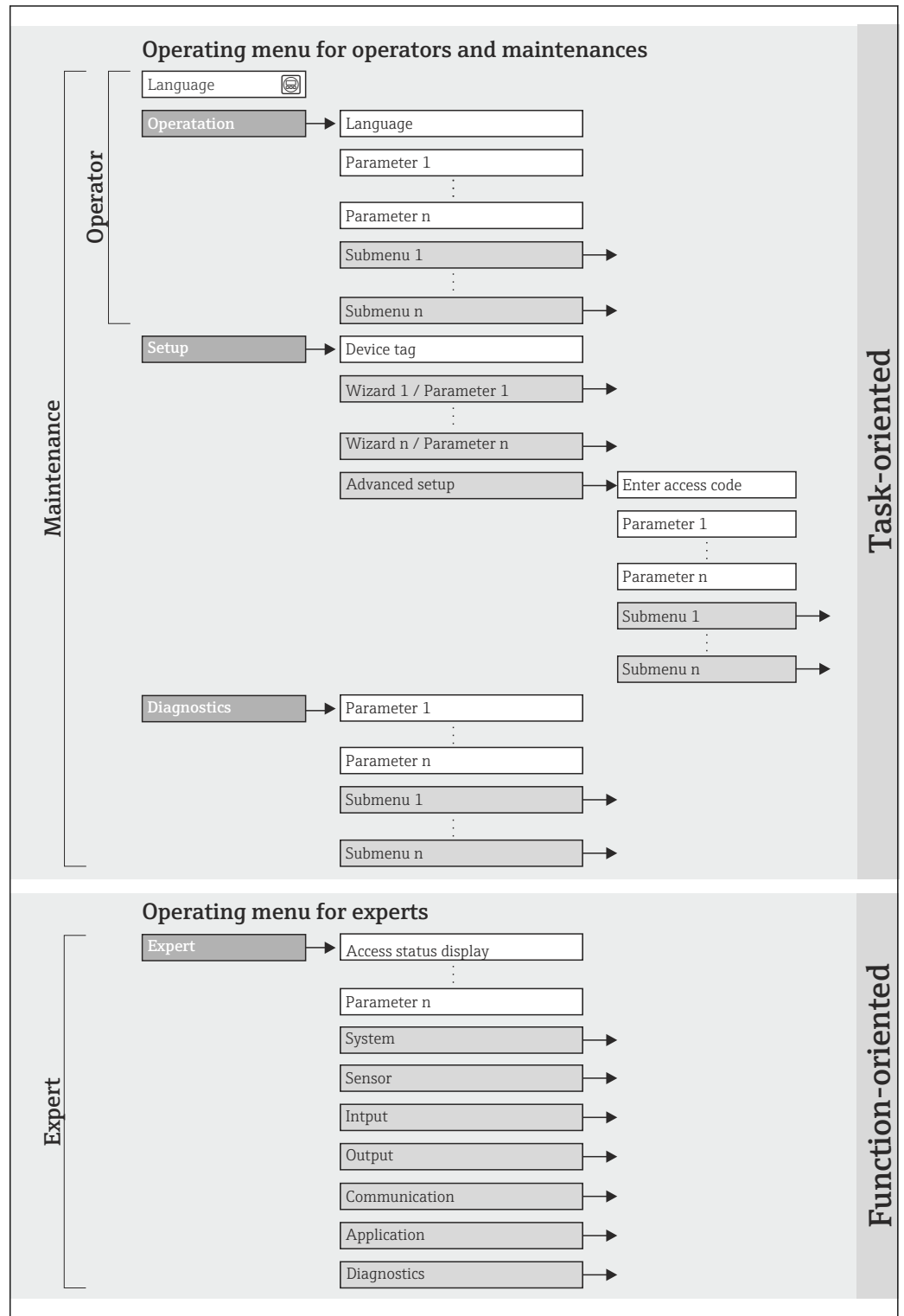
 For an overview of the operating menu with menus and parameters



 13 Schematic structure of the operating menu

A0018237-EN

8.2.2 Operating philosophy

The individual parts of the operating menu are assigned to certain user roles. Each user role corresponds to typical tasks within the device lifecycle.

Menu		User role and tasks	Content/meaning
Operation	task-oriented	Role "Operator", "Maintenance" Tasks during operation: Reading measured values	<ul style="list-style-type: none"> ▪ Defining the Web server operating language ▪ Resetting and controlling totalizers
Setup		"Maintenance" role Commissioning: <ul style="list-style-type: none"> ▪ Configuration of the measurement ▪ Configuration of the communication interface 	Submenus for fast commissioning: <ul style="list-style-type: none"> ▪ Setting the individual system units ▪ Defining the medium ▪ Configuration of the digital communication interface ▪ Configuring the low flow cut off "Advanced setup" submenu: <ul style="list-style-type: none"> ▪ For more customized configuration of the measurement (adaptation to special measuring conditions) ▪ Configuration of totalizers "Device reset" submenu Resets the device configuration to certain settings
Diagnostics		"Maintenance" role Fault elimination: <ul style="list-style-type: none"> ▪ Diagnostics and elimination of process and device errors ▪ Measured value simulation 	Contains all parameters for error detection and analyzing process and device errors: <ul style="list-style-type: none"> ▪ "Diagnostic list" submenu Contains up to 5 currently pending diagnostic messages. ▪ "Event logbook" submenu Contains 20 event messages that have occurred. ▪ "Device information" submenu Contains information for identifying the device. ▪ "Measured values" submenu Contains all current measured values. ▪ "Simulation" submenu Is used to simulate measured values or output values.
Expert	function-oriented	Tasks that require detailed knowledge of the function of the device: <ul style="list-style-type: none"> ▪ Commissioning measurements under difficult conditions ▪ Optimal adaptation of the measurement to difficult conditions ▪ Detailed configuration of the communication interface ▪ Error diagnostics in difficult cases 	Contains all the parameters of the device and makes it possible to access these parameters directly using an access code. The structure of this menu is based on the function blocks of the device: <ul style="list-style-type: none"> ▪ "System" submenu Contains all higher-order device parameters that do not pertain either to measurement or the measured value communication. ▪ "Sensor" submenu Configuration of the measurement. ▪ "Communication" submenu Configuration of the digital communication interface and the Web server. ▪ "Application" submenu Configuration of the functions that go beyond the actual measurement (e.g. totalizer). ▪ "Diagnostics" submenu Error detection and analysis of process and device errors and for device simulation and Heartbeat Technology.



8.3 Access to the operating menu via the Web browser

8.3.1 Function range

Thanks to the integrated Web server the device can be operated and configured via a Web browser. In addition to the measured values, status information on the device is also displayed and allows the user to monitor the status of the device. Furthermore the device data can be managed and the network parameters can be configured.

8.3.2 Prerequisites

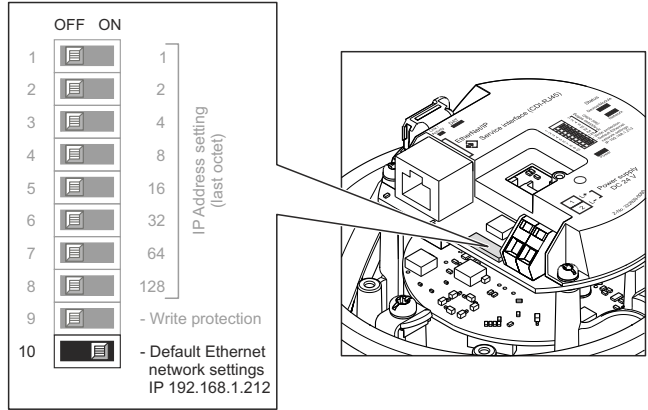
Hardware

Connecting cable	Standard Ethernet cable with RJ45 connector
Computer	RJ45 interface
Measuring device:	Web server must be enabled; factory setting: ON  For information on enabling the Web server (→ 42)
IP address	<p>If the IP address of the device is not known, communication with the Web server can be established via the standard IP address 192.168.1.212. The DHCP function is enabled in the device at the factory, i.e. the device expects an IP address to be assigned by the network. This function can be disabled and the device can be set to the standard IP address 192.168.1.212: set switch DIP switch No. 10 from OFF → ON.</p>  <p style="text-align: right; font-size: small;">A0017965</p>  <ul style="list-style-type: none"> ▪ Once the DIP switch has been activated, the device must be restarted before the device uses the standard IP address. ▪ If the standard IP address (DIP switch No. 10 = ON) is used, there is no connection to the EtherNet/IP network.

Software of the computer

Web browsers supported	<ul style="list-style-type: none"> ▪ Microsoft Internet Explorer (min. 8.x) ▪ Mozilla Firefox ▪ Google chrome
Recommended operating systems	<ul style="list-style-type: none"> ▪ Windows XP ▪ Windows 7
User rights for TCP/IP settings	User rights required for TCP/IP settings (e.g. for changes to IP address, subnet mask)
Computer configuration	<ul style="list-style-type: none"> ▪ JavaScript is enabled ▪ If JavaScript cannot be enabled, enter <code>http://XXX.XXX.X.XXX/basic.html</code> in the address line of the Web browser, e.g. <code>http://192.168.1.212/basic.html</code>. A fully functional but simplified version of the operating menu structure starts in the Web browser.

 When installing a new firmware version:
 To enable correct data display, clear the temporary memory (cache) of the Web browser under **Internet options**.

8.3.3 Establishing a connection

Configuring the Internet protocol of the computer

The following information refers to the default Ethernet settings of the device.

IP address of the device: 192.168.1.212 (factory setting)

IP address	192.168.1.XXX; for XXX all numerical values except: 0, 212 and 255 → e.g. 192.168.1.213
Subnet mask	255.255.255.0
Default gateway	192.168.1.212 or leave cells empty

1. Switch on the measuring device and connect to the computer via the cable (→  43).
2. If a 2nd network card is not used: all the applications on the notebook should be closed, or all the applications that require the Internet or network, such as e-mail, SAP applications, Internet or Windows Explorer, i.e. close all open Internet browsers.
3. Configure the properties of the Internet protocol (TCP/IP) as defined in the table above.



Starting the Web browser

1. Start the Web browser on the computer.
2. If the IP address of the measuring device is known, enter the defined device address in the address line of the Web browser. If it is unknown, set DIP switch No. 10 to ON, restart the device and enter the standard IP address: 192.168.1.212 (→  39).

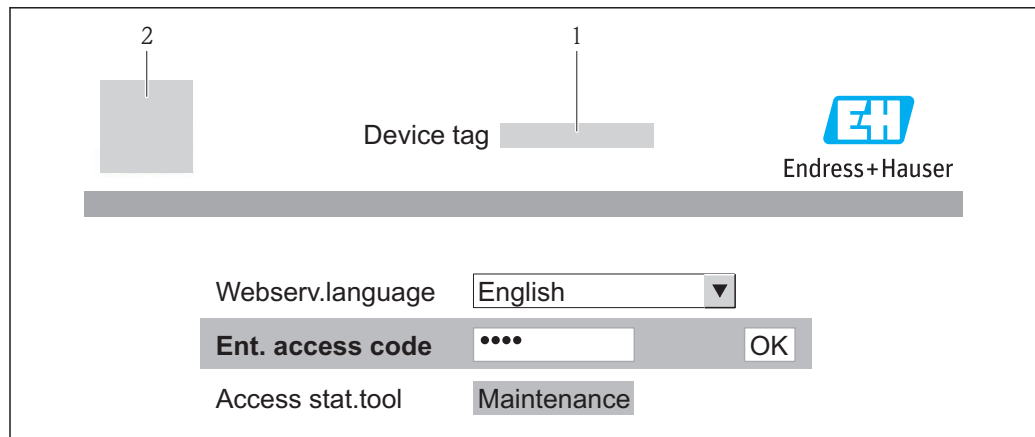
The login page appears.





- 1 Device tag (→  48)
- 2 Picture of device

 If a login page does not appear, or if the page is incomplete (→  67)

8.3.4 Logging on

1. Select the preferred operating language for the Web browser.
2. Enter the access code.
3. Press **OK** to confirm your entry.

Access code	0000 (factory setting); can be changed by customer (→  61)
--------------------	---

 If no action is performed for 10 minutes, the Web browser automatically returns to the login page.

8.3.5 User interface

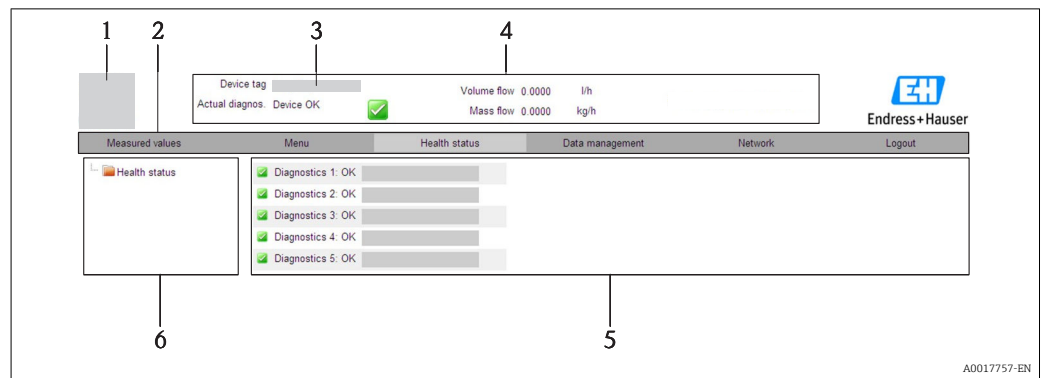

- 1 Picture of device
- 2 Function row with 6 functions
- 3 Device tag
- 4 Header
- 5 Working area
- 6 Navigation area

Header

The following information appears in the header:

- Device tag (→ 48)
- Device status with status signal (→ 69)
- Current measured values (→ 64)

Function row

Functions	Meaning
Measured values	The measured values of the device are displayed
Menu	Access to the operating menu structure of the device, same as for the operating tool
Device status	Displays the diagnostic messages currently pending, listed in order of priority
Data management	<ul style="list-style-type: none"> ■ Data exchange between PC and measuring device: <ul style="list-style-type: none"> - Upload the configuration from the device (XML format, create configuration back-up) - Save the configuration to the device (XML format, restore configuration) - Export the event list (.csv file) - Export parameter settings (.csv file, create documentation of the measuring point configuration) - Export the Heartbeat verification log (PDF file, only available with the "Heartbeat Verification" application package) ■ Upload the device driver for system integration from the device
Network configuration	Configuration and checking of all the parameters required for establishing the connection to the device: <ul style="list-style-type: none"> ■ Network settings (e.g. IP address, MAC address) ■ Device information (e.g. serial number, firmware version)
Logout	End the operation and call up the login page

Navigation area

If a function is selected in the function bar, the submenus of the function open in the navigation area. The user can now navigate through the menu structure.

Working area

Depending on the selected function and the related submenus, various actions can be performed in this area:

- Configuring parameters
- Reading measured values
- Calling up help text
- Starting an upload/download

8.3.6 Disabling the Web server

The Web server for the measuring device can be enabled and disabled as required via the **Web server functionality** parameter.

Navigation

"Expert" menu → Communication → Web server

Parameter overview with brief description

Parameter	Description	Selection	Factory setting
Web server functionality	Switch the Web server on and off.	<ul style="list-style-type: none"> ▪ Off ▪ On 	On

Enabling the Web server

If the Web server is disabled it can only be re-enabled with the **Web server functionality** parameter via the following operating options:

Via "FieldCare" operating tool

8.3.7 Logging out

 Before logging out, perform a data backup via the **Data management** function (upload configuration from device) if necessary.

1. Select the **Logout** entry in the function row.
↳ The home page with the Login box appears.
2. Close the Web browser.
3. Reset the modified properties of the Internet protocol (TCP/IP) if they are no longer needed (→  39).

 If communication with the Web server was established via the standard IP address 192.168.1.212, DIP switch No. 10 must be reset (from ON → OFF) and the IP address of the device is active again for network communication.

8.4 Access to the operating menu via the operating tool

8.4.1 Connecting the operating tool

Via service interface (CDI-RJ45)

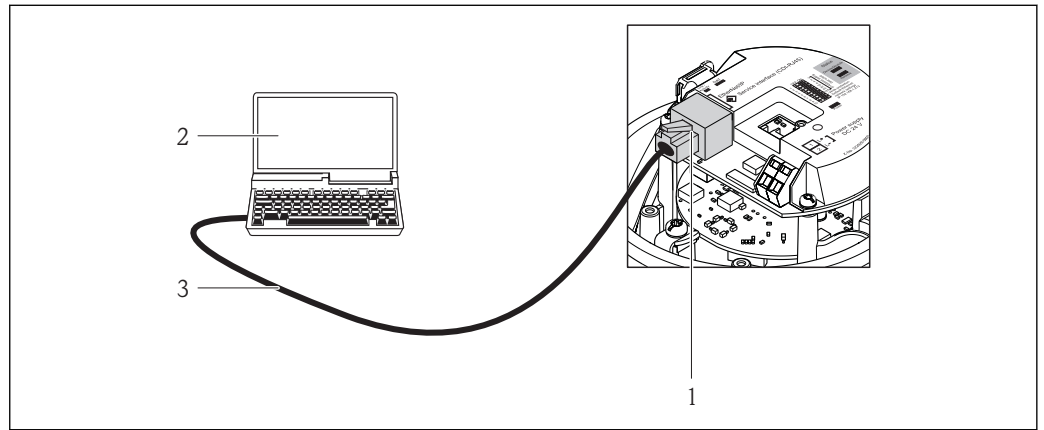

A0016940

14 Connection for order code for "Output", option N: EtherNet/IP

- 1 Service interface (CDI -RJ45) and EtherNet/IP interface of the measuring device with access to the integrated Web server
- 2 Computer with Web browser (e.g. Internet Explorer) for accessing the integrated device Web server or with "FieldCare" operating tool with COM DTM "CDI Communication TCP/IP"
- 3 Standard Ethernet connecting cable with RJ45 plug

Via Ethernet-based fieldbus

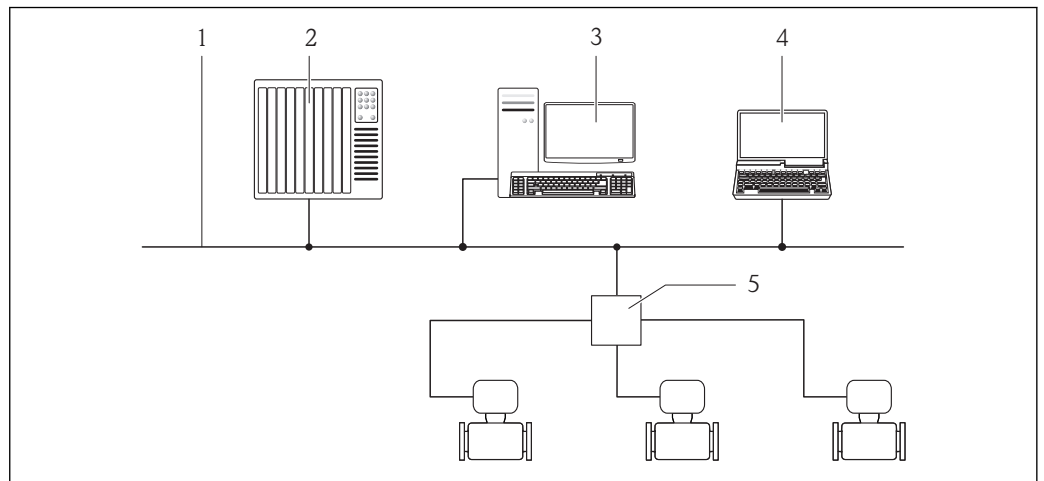

A0016961

- 1 Ethernet network
- 2 Automation system, e.g. "RSLogix" (Rockwell Automation)
- 3 Workstation for measuring device operation: with Add-on Profile Level 3 for "RSLogix 5000" (Rockwell Automation) or with Electronic Data Sheet (EDS)
- 4 Computer with Web browser (e.g. Internet Explorer) for accessing the integrated device Web server or with "FieldCare" operating tool with COM DTM "CDI Communication TCP/IP"
- 5 Ethernet switch

8.4.2 FieldCare

Function scope

FDT-based plant asset management tool from Endress+Hauser. It can configure all smart field devices in a system and helps you manage them. By using the status information, it is also a simple but effective way of checking their status and condition.

Access takes place via:

Service interface CDI-RJ45 (→  43)

Typical functions:

- Configuring parameters of transmitters
- Loading and saving device data (upload/download)
- Documentation of the measuring point
- Visualization of the measured value memory (line recorder) and event logbook

 For details, see Operating Instructions BA00027S and BA00059S

Source for device description files

See data (→  46)

Establishing a connection

Via service interface (CDI-RJ45)

1. Start FieldCare and launch the project.
2. In the network: Add a device.
 - ↳ The **Add device** window opens.
3. Select the **CDI Communication TCP/IP** option from the list and press **OK** to confirm.
4. Right-click **CDI Communication TCP/IP** and select the **Add device** option in the context menu that opens.
5. Select the desired device from the list and press **OK** to confirm.
 - ↳ The **CDI Communication TCP/IP (Configuration)** window opens.
6. Enter the device address in the **IP address** field and press **Enter** to confirm: 192.168.1.212 (factory setting); if the IP address is not known (→  63).
7. Establish the online connection to the device.

 For details, see Operating Instructions BA00027S and BA00059S

User interface

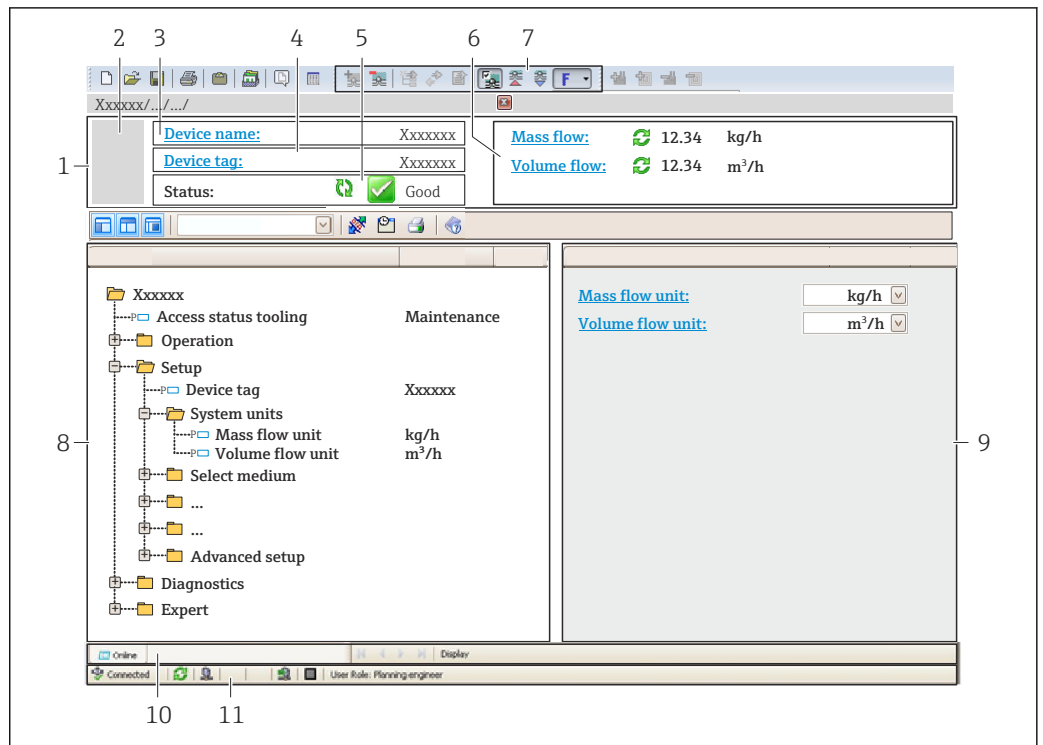



A0021051-EN

- 1 Header
- 2 Picture of device
- 3 Device name
- 4 Device tag (→ 48)
- 5 Status area with status signal (→ 69)
- 6 Display area for current measured values
- 7 Event list with additional functions such as save/load, events list and document creation
- 8 Navigation area with operating menu structure
- 9 Operating range
- 10 Range of action
- 11 Status area

9 System integration

9.1 Overview of device description files

9.1.1 Current version data for the device

Firmware version	01.01.zz	<ul style="list-style-type: none"> ▪ On the title page of the Operating instructions ▪ On transmitter nameplate(→  12) ▪ Parameter firmware version Diagnostics → Device info → Firmware version
Release date of firmware version	10.2014	---
Manufacturer ID	0x49E	Manufacturer ID parameter Diagnostics → Device info → Manufacturer ID
Device type ID	0x103A	Device type parameter Diagnostics → Device info → Device type
Device revision	<ul style="list-style-type: none"> ▪ Major revision 2 ▪ Minor revision 1 	<ul style="list-style-type: none"> ▪ On transmitter nameplate(→  12) ▪ Device revision parameter Diagnostics → Device info → Device revision
Device profile	Generic device (product type: 0x2B)	

9.1.2 Operating tools

The suitable device description file for the operating tool is listed in the table below, along with information on where the file can be acquired.



Operating tool via service interface (CDI)	Sources for obtaining device descriptions
FieldCare	<ul style="list-style-type: none"> ▪ www.endress.com → Download Area ▪ CD-ROM (contact Endress+Hauser) ▪ DVD (contact Endress+Hauser)

9.2 Overview of system files

System files	Version	Description	How to acquire
Electronic Data Sheet (EDS system file)	2.1	Certified in accordance with the following ODVA guidelines: <ul style="list-style-type: none"> ▪ Conformance test ▪ Performance test ▪ PlugFest Embedded EDS Support (File Object 0x37)	<ul style="list-style-type: none"> ▪ www.endress.com → Download Area ▪ EDS system file integrated in the device: can be downloaded via the Web browser (→  41)
Add-on Profile Level 3	<ul style="list-style-type: none"> ▪ Major revision 2 ▪ Minor revision 1 	System file for "RSLogix 5000" software (Rockwell Automation)	www.endress.com → Download Area

9.3 Integrating the measuring device in the system



 A detailed description of how to integrate the device into an automation system (e.g. from Rockwell Automation) is available as a separate document: www.endress.com → Select country → Automation → Digital Communication → Fieldbus device integration → EtherNet/IP

 For information on the protocol-specific data of EtherNet/IP (→  88)

10 Commissioning

10.1 Function check

Before commissioning the device, make sure that the post-installation and post-connection checks have been performed.

- "Post-installation check" checklist (→  26)
- "Post-connection check" checklist (→  35)

10.2 Configuring the device address via software

In the "**Communication**" submenu the device address can be set.



Navigation

"Setup" menu → Communication → Device address

10.2.1 Ethernet network and Web server

When delivered, the measuring device has the following factory settings:

IP address	192.168.1.212
Subnet mask	255.255.255.0
Default gateway	192.168.1.212

-  ▪ If hardware addressing is active, software addressing is disabled.
- If a switch is made to hardware addressing, the address configured via software addressing is retained for the first 9 places (the first three octets).
- If the IP address of the device is not known, the device address currently configured can be read out (→  63).

10.3 Configuring the measuring device

The **Setup** menu with its submenus contains all the parameters needed for standard operation.

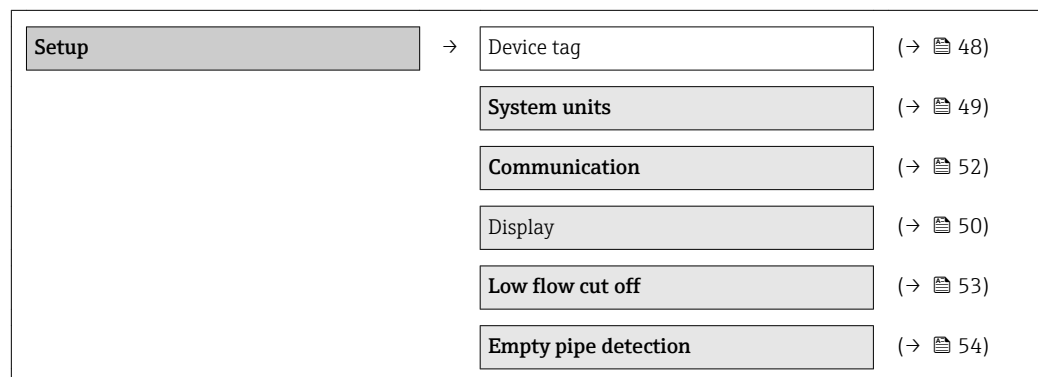

Structure of the "Setup" menu



10.3.1 Defining the tag name

To enable fast identification of the measuring point within the system, you can enter a unique designation using the **Device tag** parameter and thus change the factory setting.

 The number of characters displayed depends on the characters used.

 For information on the tag name in the "FieldCare" operating tool (→  45)

Navigation

"Setup" menu → Device tag

Parameter overview with brief description

Parameter	Description	User entry	Factory setting
Device tag	Enter tag for measuring point.	Max. 32 characters, such as letters, numbers or special characters (e.g. @, %, /).	Promag 100

10.3.2 Setting the system units

In the **System units** submenu the units of all the measured values can be set.

Navigation

"Setup" menu → System units

System units

→

Volume flow unit

Volume unit

Conductivity unit

Temperature unit

Mass flow unit

Mass unit

Density unit

Corrected volume flow unit

Corrected volume unit

Parameter overview with brief description

Parameter	Description	Selection	Factory setting
Volume flow unit	Select volume flow unit. <i>Result</i> The selected unit applies for: <ul style="list-style-type: none"> ■ Output ■ Low flow cut off ■ Simulation process variable 	Unit choose list	Country-specific: <ul style="list-style-type: none"> ■ l/h ■ gal/min (us)
Volume unit	Select volume unit. Result The selected unit is taken from: Volume flow unit parameter	Unit choose list	Country-specific: <ul style="list-style-type: none"> ■ l ■ gal (us)

Parameter	Description	Selection	Factory setting
Conductivity unit	Select conductivity unit. <i>Result</i> The selected unit applies for: Simulation process variable	Unit choose list	$\mu\text{S}/\text{cm}$
Temperature unit	Select temperature unit. <i>Result</i> The selected unit applies for: <ul style="list-style-type: none"> ▪ Output ▪ Reference temperature ▪ Simulation process variable 	Unit choose list	Country-specific: <ul style="list-style-type: none"> ▪ °C (Celsius) ▪ °F (Fahrenheit)
Mass flow unit	Select mass flow unit. <i>Result</i> The selected unit applies for: <ul style="list-style-type: none"> ▪ Output ▪ Low flow cut off ▪ Simulation process variable 	Unit choose list	Country-specific: <ul style="list-style-type: none"> ▪ kg/h ▪ lb/min
Mass unit	Select mass unit. <i>Result</i> The selected unit is taken from: Mass flow unit parameter	Unit choose list	Country-specific: <ul style="list-style-type: none"> ▪ kg ▪ lb
Density unit	Select density unit. <i>Result</i> The selected unit applies for: <ul style="list-style-type: none"> ▪ Output ▪ Simulation process variable ▪ Density adjustment (in Expert menu) 	Unit choose list	Country-specific: <ul style="list-style-type: none"> ▪ kg/l ▪ lb/ft³
Corrected volume flow unit	Select corrected volume flow unit. <i>Result</i> The selected unit applies for: <ul style="list-style-type: none"> ▪ Output ▪ Low flow cut off ▪ Simulation process variable 	Unit choose list	Country-specific: <ul style="list-style-type: none"> ▪ NI/h ▪ Sft³/h
Corrected volume unit	Select corrected volume unit. Result The selected unit is taken from: Corrected volume flow unit parameter	Unit choose list	Country-specific: <ul style="list-style-type: none"> ▪ NI ▪ Sft³

10.3.3 Configuring the local display

The **Display** wizard guides you systematically through all the parameters that can be configured for configuring the local display.

Navigation

"Setup" menu → Display

Structure of the wizard

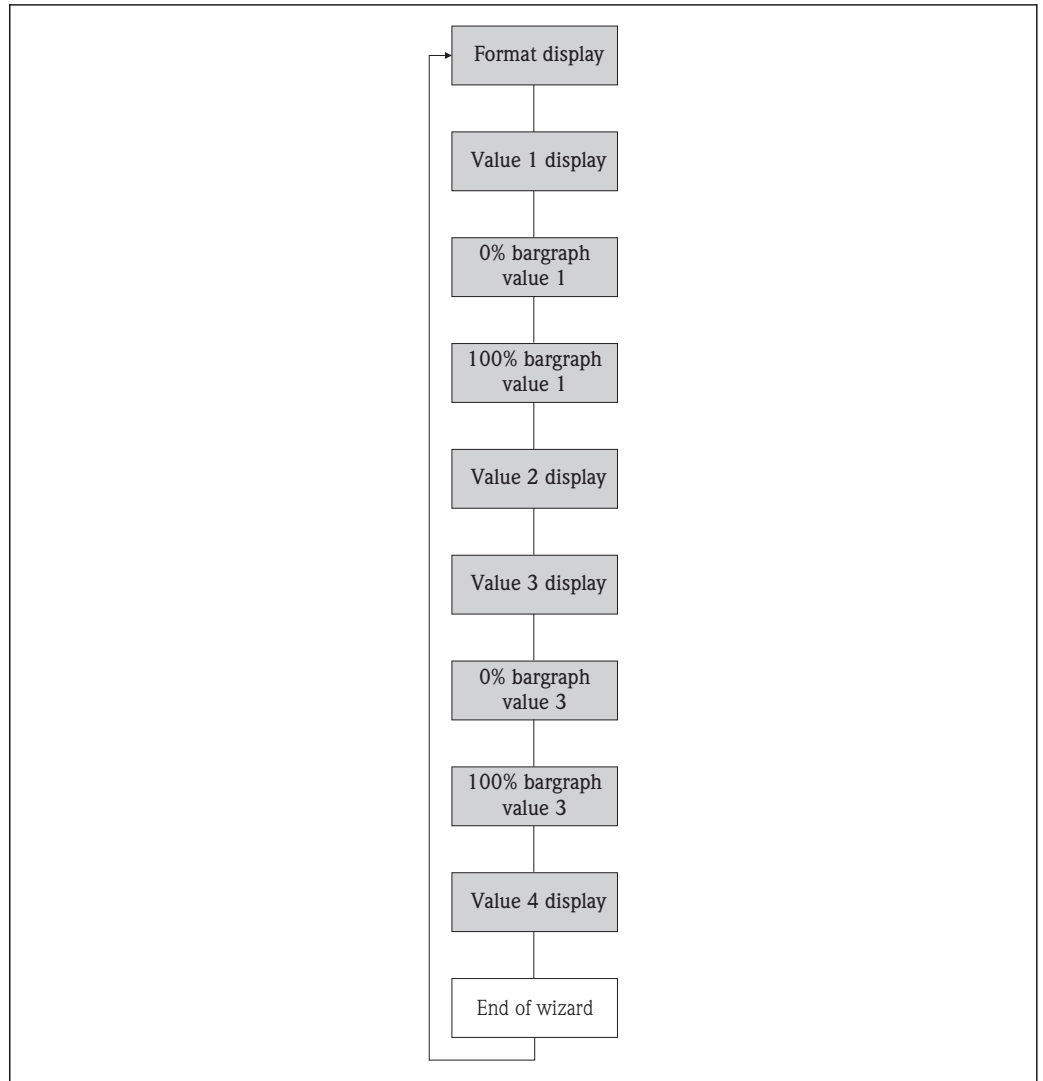

A0013797-EN

15 "Display" wizard in the "Setup" menu

Parameter overview with brief description

Parameter	Description	Selection / User entry	Factory setting
Format display	Select how measured values are shown on the display.	<ul style="list-style-type: none"> ■ 1 value, max. size ■ 1 bargraph + 1 value ■ 2 values ■ 1 value large + 2 values ■ 4 values 	1 value, max. size
Value 1 display	Select the measured value that is shown on the local display.	<ul style="list-style-type: none"> ■ Volume flow ■ Mass flow ■ Corrected volume flow ■ Flow velocity ■ Conductivity ■ Corrected conductivity ■ Totalizer 1 ■ Totalizer 2 ■ Totalizer 3 ■ None 	Volume flow
0% bargraph value 1	Enter 0% value for bar graph display.	Signed floating-point number	0 l/h
100% bargraph value 1	Enter 100% value for bar graph display.	Signed floating-point number	0.025 l/h

Parameter	Description	Selection / User entry	Factory setting
Value 2 display	Select the measured value that is shown on the local display.	Picklist (see 1st display value)	None
Value 3 display	Select the measured value that is shown on the local display.	Picklist (see 1st display value)	None
0% bargraph value 3	Enter 0% value for bar graph display.	Signed floating-point number	0
100% bargraph value 3	Enter 100% value for bar graph display.	Signed floating-point number	0
Value 4 display	Select the measured value that is shown on the local display.	Picklist (see 1st display value)	None

10.3.4 Configuring the communication interface

The "**Communication**" submenu guides you systematically through all the parameters that have to be configured for selecting and setting the communication interface.



Navigation

"Setup" menu → Communication

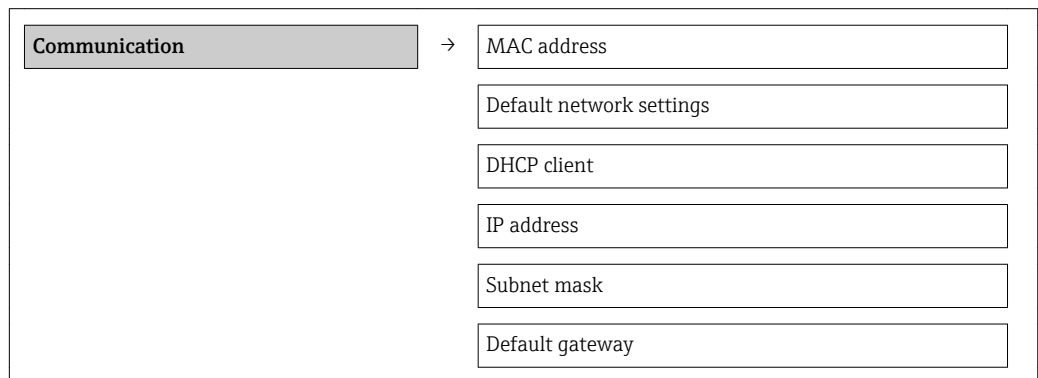
Structure of the submenu



Parameter overview with brief description

Parameter	Description	User interface / Selection / User entry	Factory setting
MAC address	Displays the MAC address of the measuring device.  MAC = Media Access Control	Unique 12-digit character string comprising letters and numbers, e.g.: 00:07:05:10:01:5F	Each measuring device is given an individual address.
Default network settings	Select whether to restore network settings.	<ul style="list-style-type: none"> ▪ Off ▪ On 	Off
DHCP client	Select to activate/deactivate DHCP client functionality. Result If the web server's DHCP client functionality is activated, the IP address, subnet mask and default gateway are automatically set.  Identification is via the MAC address of the measuring device.	<ul style="list-style-type: none"> ▪ Off ▪ On 	On
IP address	Displays the IP address of the Web server of the measuring device.	4 octet: 0 to 255 (in the particular octet)	192.168.1.212

Parameter	Description	User interface / Selection / User entry	Factory setting
Subnet mask	Displays the subnet mask.	4 octet: 0 to 255 (in the particular octet)	255.255.255.0
Default gateway	Displays the default gateway.	4 octet: 0 to 255 (in the particular octet)	0.0.0.0

10.3.5 Configuring the low flow cut off

The **Low flow cut off** submenu contains parameters that must be configured for the configuration of low flow cut off.

Navigation

"Setup" menu → Low flow cut off

Structure of the submenu

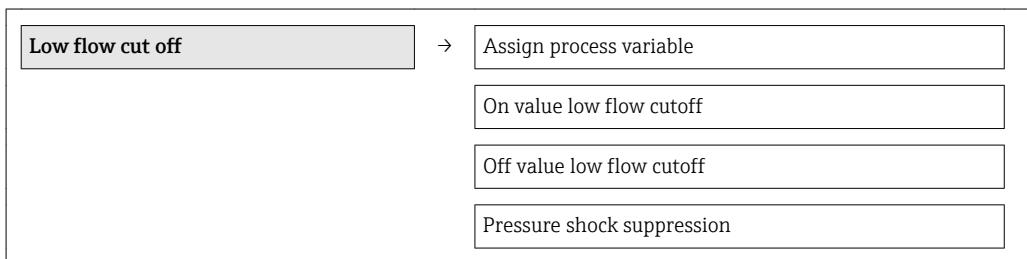

Parameter overview with brief description

Parameter	Prerequisite	Description	Selection / User entry	Factory setting
Assign process variable	–	Select process variable for low flow cut off.	<ul style="list-style-type: none"> ▪ Off ▪ Volume flow ▪ Mass flow ▪ Corrected volume flow 	Volume flow
On value low flow cutoff	One of the following options is selected in the Assign process variable parameter: <ul style="list-style-type: none"> ▪ Mass flow ▪ Volume flow ▪ Corrected volume flow 	Enter on value for low flow cut off.	Signed floating-point number	For liquids: depends on country and nominal diameter
Off value low flow cutoff	One of the following options is selected in the Assign process variable parameter: <ul style="list-style-type: none"> ▪ Mass flow ▪ Volume flow ▪ Corrected volume flow 	Enter off value for low flow cut off.	0 to 100.0 %	50 %
Pressure shock suppression	One of the following options is selected in the Assign process variable parameter: <ul style="list-style-type: none"> ▪ Mass flow ▪ Volume flow ▪ Corrected volume flow 	Enter time frame for signal suppression (= active pressure shock suppression).	0 to 100 s	0 s

10.3.6 Configuring empty pipe detection

The **Empty pipe detection** submenu contains parameters that must be configured for the configuration of low flow cut off.

Navigation

"Setup" menu → Empty pipe detection

Structure of the submenu

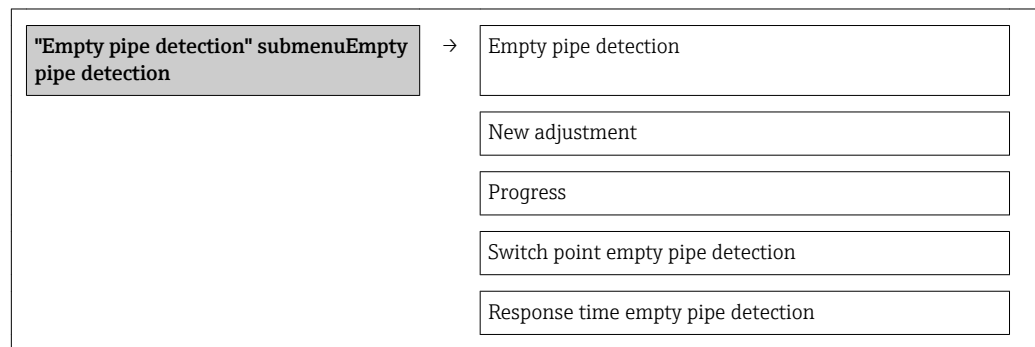

Parameter overview with brief description

Parameter	Prerequisite	Description	Selection / User interface / User entry	Factory setting
Empty pipe detection	-	Switch empty pipe detection on and off.	<ul style="list-style-type: none"> ▪ Off ▪ On 	Off
New adjustment	-	Select type of adjustment.	<ul style="list-style-type: none"> ▪ Cancel ▪ Empty pipe adjust ▪ Full pipe adjust 	Cancel
Progress	-		<ul style="list-style-type: none"> ▪ Ok ▪ Busy ▪ Not ok 	-
Switch point empty pipe detection	-	Enter hysteresis in %, below this value the measuring tube will be detected as empty.	0 to 100 %	10 %
Response time empty pipe detection	One of the following options is selected in the Assign process variable parameter: <ul style="list-style-type: none"> ▪ Density ▪ Reference density 	Enter the time before diagnostic message S862 'Pipe empty' is displayed for empty pipe detection.	0 to 100 s	1 s

10.4 Advanced settings

The **Advanced setup** submenu with its submenus contains parameters for specific settings.

Overview of the parameters and submenus in the "Advanced setup" submenu

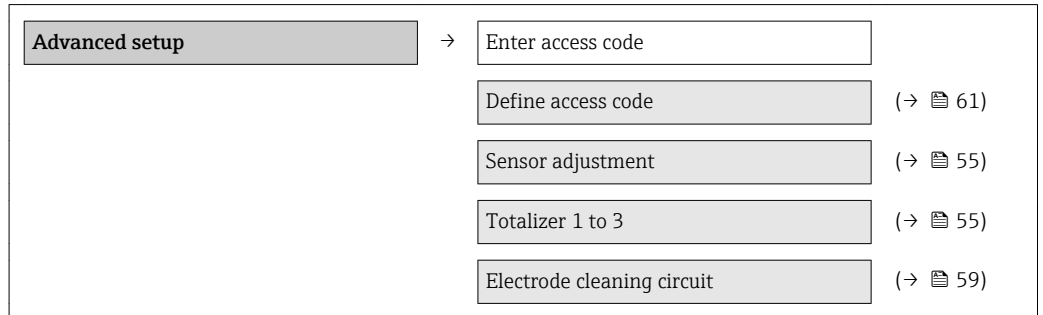

10.4.1 Carrying out a sensor adjustment

The **Sensor adjustment** submenu contains parameters that pertain to the functionality of the sensor.

Navigation

"Setup" menu → Advanced setup → Sensor adjustment

Structure of the submenu



Parameter overview with brief description

Parameter	Description	Selection	Factory setting
Installation direction	Set sign of flow direction to match the direction of the arrow on the sensor.	<ul style="list-style-type: none"> ▪ Flow in arrow direction ▪ Flow against arrow direction 	Flow in arrow direction

10.4.2 Configuring the totalizer

In the **"Totalizer 1 to 3"** submenu the individual totalizers can be configured.

Navigation

"Setup" menu → Advanced setup → Totalizer 1 to 3

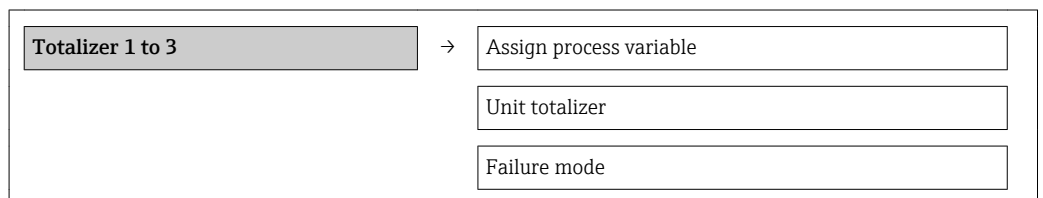

Parameter overview with brief description

Parameter	Description	Selection	Factory setting
Assign process variable	Select process variable for totalizer.	<ul style="list-style-type: none"> ▪ Off ▪ Volume flow ▪ Mass flow ▪ Corrected volume flow 	Volume flow
Unit totalizer	Select process variable totalizer unit.	Unit choose list	1
Totalizer operation mode	Select totalizer calculation mode.	<ul style="list-style-type: none"> ▪ Net flow total ▪ Forward flow total ▪ Reverse flow total 	Net flow total
Failure mode	Define totalizer behavior in alarm condition.	<ul style="list-style-type: none"> ▪ Stop ▪ Actual value ▪ Last valid value 	Stop

10.4.3 Carrying out additional display configurations

In the **"Display"** submenu you can set all the parameters involved in the configuration of the local display.

Navigation

"Setup" menu → Advanced setup → Display

Structure of the submenu

Display	→	Format display
		Value 1 display
		0% bargraph value 1
		100% bargraph value 1
		Decimal places 1
		Value 2 display
		Decimal places 2
		Value 3 display
		0% bargraph value 3
		100% bargraph value 3
		Decimal places 3
		Value 4 display
		Decimal places 4
		Display language
		Display interval
		Display damping
		Header
		Header text
		Separator
		Backlight

Parameter overview with brief description

Parameter	Description	Selection / User entry	Factory setting
Format display	Select how measured values are shown on the display.	<ul style="list-style-type: none"> ▪ 1 value, max. size ▪ 1 bargraph + 1 value ▪ 2 values ▪ 1 value large + 2 values ▪ 4 values 	1 value, max. size
Value 1 display	Select the measured value that is shown on the local display.	<ul style="list-style-type: none"> ▪ Volume flow ▪ Mass flow ▪ Corrected volume flow ▪ Flow velocity ▪ Conductivity ▪ Corrected conductivity ▪ Totalizer 1 ▪ Totalizer 2 ▪ Totalizer 3 ▪ None 	Volume flow
0% bargraph value 1	Enter 0% value for bar graph display.	Signed floating-point number	0 l/h
100% bargraph value 1	Enter 100% value for bar graph display.	Signed floating-point number	0.025 l/h
Decimal places 1	Select the number of decimal places for the display value.	<ul style="list-style-type: none"> ▪ x ▪ x.x ▪ x.xx ▪ x.xxx ▪ x.xxxx 	x.xx
Value 2 display	Select the measured value that is shown on the local display.	Picklist (see 1st display value)	None
Decimal places 2	Select the number of decimal places for the display value.	<ul style="list-style-type: none"> ▪ x ▪ x.x ▪ x.xx ▪ x.xxx ▪ x.xxxx 	x.xx
Value 3 display	Select the measured value that is shown on the local display.	Picklist (see 1st display value)	None
0% bargraph value 3	Enter 0% value for bar graph display.	Signed floating-point number	0
100% bargraph value 3	Enter 100% value for bar graph display.	Signed floating-point number	0
Decimal places 3	Select the number of decimal places for the display value.	<ul style="list-style-type: none"> ▪ x ▪ x.x ▪ x.xx ▪ x.xxx ▪ x.xxxx 	x.xx
Value 4 display	Select the measured value that is shown on the local display.	Picklist (see 1st display value)	None
Decimal places 4	Select the number of decimal places for the display value.	<ul style="list-style-type: none"> ▪ x ▪ x.x ▪ x.xx ▪ x.xxx ▪ x.xxxx 	x.xx

Parameter	Description	Selection / User entry	Factory setting
Display language	Set display language.	<ul style="list-style-type: none"> ▪ English ▪ Deutsch ▪ Français ▪ Español ▪ Italiano ▪ Nederlands ▪ Portuguesa ▪ Polski ▪ русский язык (Russian) ▪ Svenska ▪ Türkçe ▪ 中文 (Chinese) ▪ 日本語 (Japanese) ▪ 한국어 (Korean) ▪ العربية (Arabic) ▪ Bahasa Indonesia ▪ ภาษาไทย (Thai) ▪ tiếng Việt (Vietnamese) ▪ čeština (Czech) 	English (alternatively, the ordered language is preset in the device)
Display interval	Set time measured values are shown on display if display alternates between values.	1 to 10 s	5 s
Display damping	Set display reaction time to fluctuations in the measured value.	0.0 to 999.9 s	0.0 s
Header	Select header contents on local display.	<ul style="list-style-type: none"> ▪ Device tag ▪ Free text 	Device tag
Header text	Enter display header text.		-----
Separator	Select decimal separator for displaying numerical values.	<ul style="list-style-type: none"> ▪ . ▪ , 	.
Backlight	Switch the local display backlight on and off.	<ul style="list-style-type: none"> ▪ Disable ▪ Enable 	Enable

10.4.4 Performing electrode cleaning

The **Electrode cleaning circuit** submenu contains parameters that must be configured for the configuration of electrode cleaning.

 The submenu is only available if the device was ordered with electrode cleaning.

Navigation

"Setup" menu → Advanced setup → Electrode cleaning circuit

Structure of the submenu

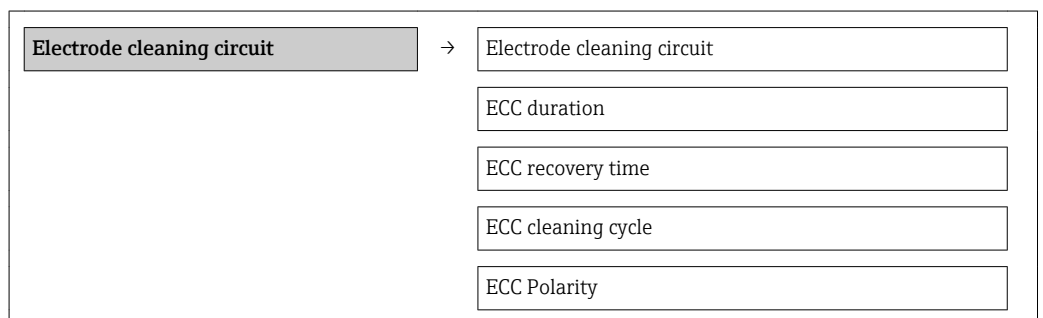

Parameter overview with brief description

Parameter	Description	Selection / User entry / User interface	Factory setting
Electrode cleaning circuit	Enable the cyclic electrode cleaning circuit.	<ul style="list-style-type: none"> ■ Off ■ On 	Off
ECC duration	Enter the duration of electrode cleaning in seconds.	0.01 to 30 s	2 s
ECC recovery time	Define recovery time after electrode cleaning. During this time the current output values will be held at last valid value.	1 to 3.0 ⁺³⁸ s	60 s
ECC cleaning cycle	Enter the pause duration between electrode cleaning cycles.	0.5 to 168 h	0.5 h
ECC Polarity	Select the polarity of the electrode cleaning circuit.	<ul style="list-style-type: none"> ■ Positive ■ Negative 	Positive

10.5 Simulation

The "**Simulation**" submenu enables you to simulate, without a real flow situation, various process variables in the process and the device alarm mode and to verify downstream signal chains (switching valves or closed-control loops).

Navigation

"Diagnostics" menu → Simulation

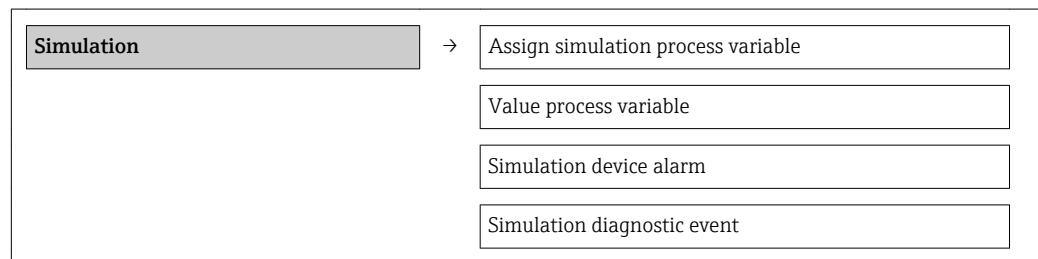

Parameter overview with brief description

Parameter	Prerequisite	Description	Selection / User entry	Factory setting
Assign simulation process variable	–	Select a process variable for the simulation process that is activated.	<ul style="list-style-type: none"> ■ Off ■ Volume flow ■ Mass flow ■ Corrected volume flow ■ Conductivity ■ Corrected conductivity ■ Temperature 	Off
Value process variable	A process variable is selected in the Assign simulation process variable parameter.	Enter the simulation value for the selected process variable.	Signed floating-point number	0

Parameter	Prerequisite	Description	Selection / User entry	Factory setting
Simulation device alarm	–	Switch the device alarm on and off.	<ul style="list-style-type: none"> ▪ Off ▪ On 	Off
Simulation diagnostic event	–	Switch simulation of the diagnostic event on and off. For the simulation, you can choose from the diagnostic events of the category selected in the Diagnostic event category parameter.	<ul style="list-style-type: none"> ▪ Off ▪ Picklist Diagnostic events (depends on the selected category) 	Off

10.6 Protecting settings from unauthorized access

The following options exist for protecting the configuration of the measuring device from unintentional modification after commissioning:

- Write protection via access code for Web browser (→ 61)
- Write protection via write protection switch (→ 61)

10.6.1 Write protection via access code

With the customer-specific access code, access to the measuring device via the Web browser is protected, as are the parameters for the measuring device configuration.

Navigation

"Setup" menu → Advanced setup → Administration → Define access code

Structure of the submenu

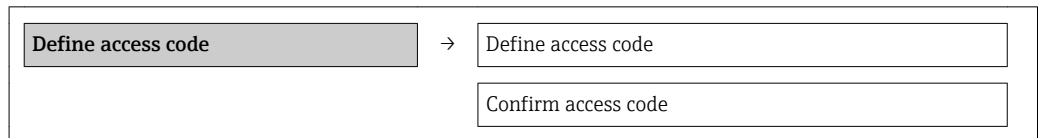

Defining the access code via the Web browser

1. Navigate to the **Enter access code** parameter.
2. Define a max. 4-digit numeric code as an access code.
3. Enter the access code again to confirm the code.
 - ↳ The Web browser switches to the login page.

i If no action is performed for 10 minutes, the Web browser automatically returns to the login page.

i The user role with which the user is currently logged on via the Web browser is indicated by the **Access status tooling** parameter. Navigation path: Operation → Access status tooling

10.6.2 Write protection via write protection switch

The write protection switch makes it possible to block write access to the entire operating menu with the exception of the following parameters:

- External pressure
- External temperature
- Reference density
- All parameters for configuring the totalizer

The parameter values are now read only and cannot be edited any more:

- Via service interface (CDI-RJ45)
- Via Ethernet network
- Via PROFIBUS DP

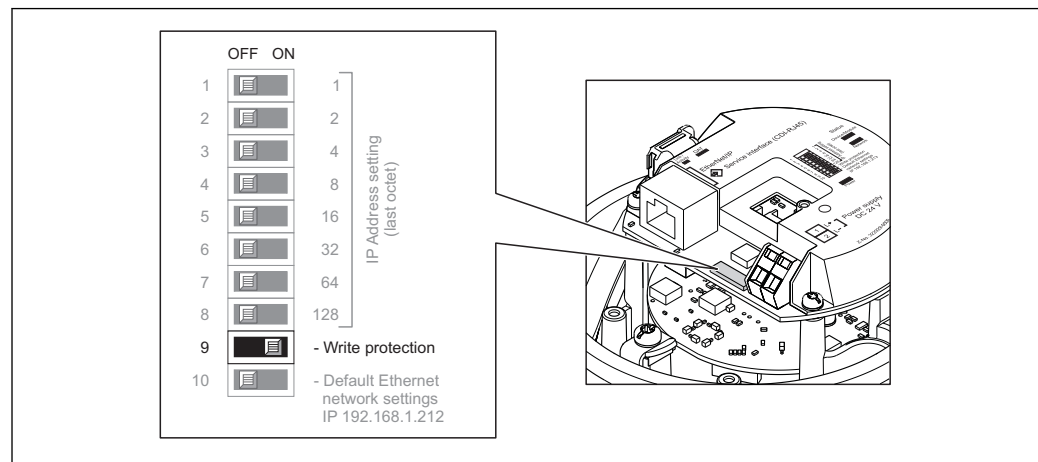

A0017915

1. Depending on the housing version, loosen the securing clamp or fixing screw of the housing cover.
2. Depending on the housing version, unscrew or open the housing cover and disconnect the local display from the main electronics module where necessary (→ 99).
3. Setting the write protection switch on the I/O electronics module to the ON position enables the hardware write protection. Setting the write protection switch on the I/O electronics module to the OFF position (factory setting) disables the hardware write protection.
 - ↳ If hardware write protection is enabled, the **Hardware locked** option is displayed in the **Locking status** parameter (→ 63); if disabled, no option is displayed in the **Locking status** parameter (→ 63)
4. Reverse the removal procedure to reassemble the transmitter.

11 Operation

11.1 Read out and modify current Ethernet settings

If the Ethernet settings such as the IP address of the measuring device are unknown, they can be read out and modified as explained in the following example for an IP address.

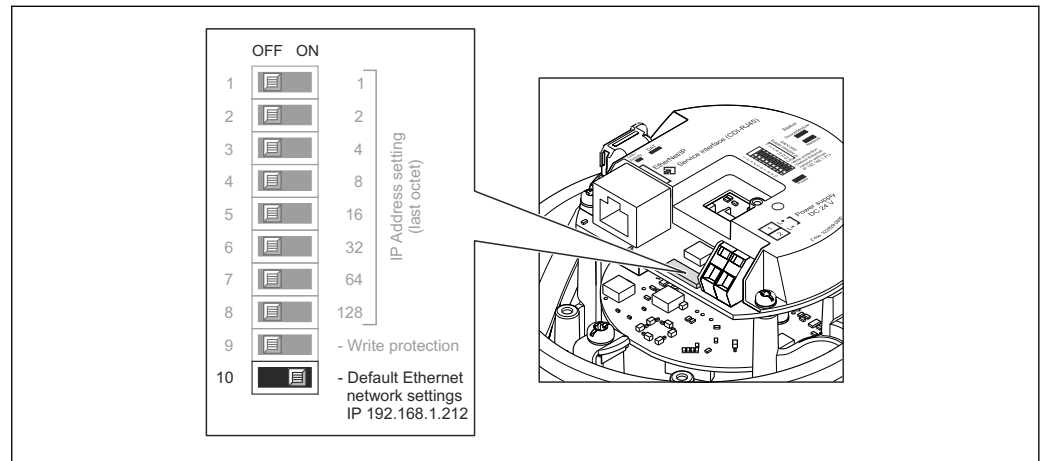

Prerequisite

- Software addressing is enabled: All the DIP switches for hardware addressing are set to OFF. (→ 33)
- Measuring device is switched on.

1. Set the DIP switch for "Default Ethernet network settings, IP 192.168.1.212" from OFF → ON.
2. Restart the device.
 - ↳ The device's Ethernet settings are reset to their factory settings:
IP address: 192.168.1.212; Subnet mask: 255.255.255.0; Default gateway: 192.168.1.212
3. Enter the default setting for the IP address in the address line of the Web browser.
4. In the operating menu navigate to the **IP address** parameter: "Setup" menu → Communication → IP address
 - ↳ The parameter displays the configured IP address.
5. Change the IP address of the device if necessary.
6. Set the DIP switch for "Default Ethernet network settings, IP 192.168.1.212" from ON → OFF.
7. Restart the device.
 - ↳ The modified IP address of the device is now enabled.

11.2 Reading device locking status

The write protection types that are currently active can be determined using the **Locking status** parameter.

Navigation

"Operation" menu → Locking status

Function scope of "Locking status" parameter

Options	Description
Hardware locked	The write protection switch (DIP switch) for hardware locking is activated on the I/O electronic module. This prevents write access to the parameters (→ 61).
Temporarily locked	Due to internal processing in the device (e.g. up-/downloading of data, reset), write access to the parameters is blocked for a short time. Once the internal processing has been completed, the parameters can be changed once again.

11.3 Reading measured values

Using the **Measured values** submenu, it is possible to read all the measured values.

"Diagnostics" menu → Measured values

11.3.1 Process variables

The **Process variables** submenu contains all the parameters needed to display the current measured values for every process variable.

Navigation

"Diagnostics" menu → Measured values → Process variables

Structure of the submenu

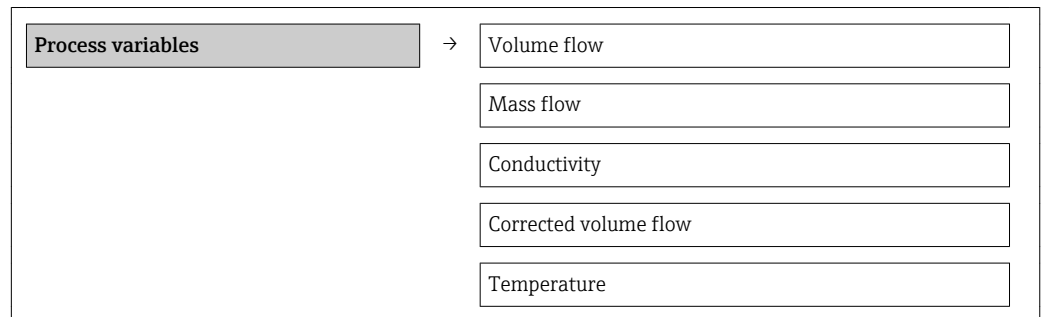

Structure of the submenu

Parameter overview with brief description

Parameter	Description	User interface
Volume flow	Displays the volume flow currently measured.	Signed floating-point number
Mass flow	Displays the mass flow currently calculated.	Signed floating-point number
Conductivity	Displays the corrected volume flow currently calculated.	Signed floating-point number
Corrected volume flow	Displays the temperature currently measured.	Signed floating-point number
Temperature	Displays the saturated steam pressure currently calculated.	Positive floating-point number

11.3.2 Totalizer

The **"Totalizer" submenu** contains all the parameters needed to display the current measured values for every totalizer.

Navigation

"Diagnostics" menu → Measured values → Totalizer

Structure of the submenu

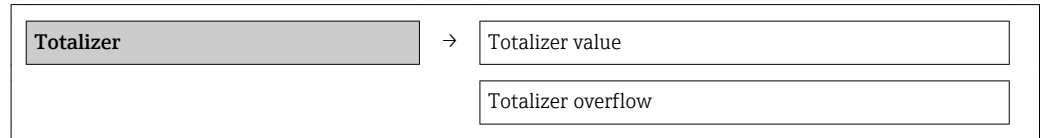

Parameter overview with brief description

Parameter	Description	User interface	Factory setting
Totalizer value #	Displays the current totalizer counter value.	Signed floating-point number	0 1
Totalizer overflow #	Displays the current totalizer overflow.	-32 000.0 to 32 000.0	0

11.4 Adapting the measuring device to the process conditions

The following are available for this purpose:

- Basic settings using the **Setup** menu (→ 48)
- Advanced settings using the **Advanced setup** submenu (→ 55)

11.5 Performing a totalizer reset

Function scope of "Control Totalizer" parameter

Options	Description
Totalize	The totalizer is started.
Stop	Totalizing is stopped.
Reset + hold	The totaling process is stopped and the totalizer is reset to 0.
Preset + hold	The totaling process is stopped and the totalizer is set to its defined start value from the Preset value parameter.
Reset + totalize	The totalizer is reset to 0 and the totaling process is restarted.
Preset + totalize	The totalizer is set to the defined start value in Preset value parameter and the totaling process is restarted.

Function scope of "Reset all totalizers" parameter

Options	Description
Reset + totalize	Resets all totalizers to 0 and restarts the totaling process. This deletes all the flow values previously totalized.

Navigation

"Operation" menu → Operation

Structure of the submenu

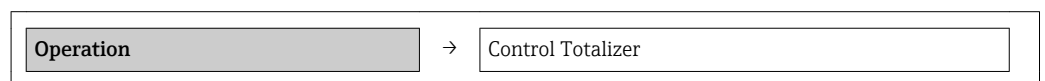

	Preset value
	Reset all totalizers

Parameter overview with brief description

Parameter	Description	Selection / User entry	Factory setting
Control Totalizer #	Control totalizer value.	<ul style="list-style-type: none"> ■ Totalize ■ Reset + hold ■ Preset + hold ■ Reset + totalize ■ Preset + totalize ■ Last valid value 	Totalize
Preset value #	Specify start value for totalizer.	Signed floating-point number	01
Reset all totalizers	Reset all totalizers to 0 and start.	<ul style="list-style-type: none"> ■ Cancel ■ Reset + totalize 	Cancel





12 Diagnostics and troubleshooting

12.1 General troubleshooting

For output signals

Problem	Possible causes	Remedy
Green power LED on the main electronics module of the transmitter is dark	Supply voltage does not match that specified on the nameplate.	Apply the correct supply voltage (→  29).
Device measures incorrectly.	Configuration error or device is operated outside the application.	1. Check and correct parameter configuration. 2. Observe limit values specified in the "Technical Data".

For access

Problem	Possible causes	Remedy
No write access to parameters	Hardware write protection enabled	Set the write protection switch on the main electronics module to the OFF position (→  61).
No connection via EtherNet/IP	Device plug connected incorrectly	Check the pin assignment of the device plug .
Not connecting to Web server	<ul style="list-style-type: none"> ▪ Incorrect IP address ▪ IP address is not known 	<ol style="list-style-type: none"> 1. If addressing via hardware: open the transmitter and check the IP address configured (last octet). 2. Check the IP address of the measuring device with the network manager. 3. If the IP address is not known, set DIP switch No. 10 on the I/O electronics module to ON, restart the device and enter the default setting for the IP address 192.168.1.212. <p> EtherNet/IP communication is interrupted by enabling the DIP switch.</p>
Not connecting to Web server	Incorrect setting for the Ethernet interface of the computer	<ol style="list-style-type: none"> 1. Check the properties of the Internet protocol (TCP/IP) (→  39). 2. Check the network settings with the IT manager.
Not connecting to Web server	Web server disabled	Via the "FieldCare" operating tool check whether the Web server of the measuring device is enabled and enable it if necessary (→  42).
Not connecting to Web server	The use of the proxy server is not disabled in the Web browser settings of the computer.	<p>Disable the use of the proxy server in the Web browser settings of the computer.</p> <p>Using the example of MS Internet Explorer:</p> <ol style="list-style-type: none"> 1. Under <i>Control Panel</i> open <i>Internet options</i>. 2. Select the <i>Connections</i> tab and then double-click <i>LAN settings</i>. 3. In the <i>LAN settings</i> disable the use of the proxy server and select <i>OK</i> to confirm.

Problem	Possible causes	Remedy
Not connecting to Web server	Other network connections or programs are still active on the computer.	<ul style="list-style-type: none"> ▪ Make sure that no other network connections are established by the computer (also no WLAN) and close other programs with network access to the computer. ▪ If using a docking station for notebooks make sure that a network connection to another network is not active.
No or incomplete display of contents in the Web browser	<ul style="list-style-type: none"> ▪ JavaScript not enabled ▪ JavaScript cannot be enabled 	<ol style="list-style-type: none"> 1. Enable JavaScript. 2. Enter http://XXX.XXX.X.XXX/basic.html as the IP address.
Web browser frozen and operation no longer possible	Data transfer active	Wait until data transfer or current action is finished.
Web browser frozen and operation no longer possible	Connection lost	<ol style="list-style-type: none"> 1. Check cable connection and power supply. 2. Refresh the Web browser and restart if necessary.
Content of Web browser incomplete or difficult to read	Not using optimum version of Web server.	<ol style="list-style-type: none"> 1. Use the correct Web browser version (→ 39). 2. Clear the Web browser cache and restart the Web browser.
Content of Web browser incomplete or difficult to read	Unsuitable view settings.	Change the font size/display ratio of the Web browser.

12.2 Diagnostic information via light emitting diodes

12.2.1 Transmitter

Various light emitting diodes (LEDs) on the main electronics module of the transmitter provide information on device status.

LED	Color	Meaning
Power	Off	Supply voltage is off or too low
	Green	Supply voltage is ok
Device status	Green	Device status is ok
	Flashing red	A device error of diagnostic behavior "Warning" has occurred
	Red	A device error of diagnostic behavior "Alarm" has occurred
	Alternately flashing red/green	Boot loader is active
Network status	Off	Device has no EtherNet/IP address
	Green	Device's EtherNet/IP connection is active
	Flashing green	Device has EtherNet/IP address but no EtherNet/IP connection
	Red	EtherNet/IP address of the device has been assigned twice
	Flashing red	Device's EtherNet/IP connection is in timeout mode
Link/Activity	Orange	Link available but no activity
	Flashing orange	Activity present
Communication	Flashing white	

12.3 Diagnostic information in the Web browser

12.3.1 Diagnostic options

Any faults detected by the measuring device are displayed in the Web browser on the home page once the user has logged on.

1 Status area with status signal
 2 Diagnostic information
 3 Remedial measures with Service ID

- i** Furthermore, diagnostic events that have occurred can be viewed in the **Diagnostics** menu:
 - Via parameters (→ 74)
 - Via submenus (→ 75)

Status signals

The status signals provide information on the state and reliability of the device by categorizing the cause of the diagnostic information (diagnostic event).

Symbol	Meaning
 A0017271	Failure A device error has occurred. The measured value is no longer valid.
 A0017278	Function check The device is in service mode (e.g. during a simulation).
 A0017277	Out of specification The device is operated: Outside its technical specification limits (e.g. outside the process temperature range)
 A0017276	Maintenance required Maintenance is required. The measured value is still valid.

- i** The status signals are categorized in accordance with VDI/VDE 2650 and NAMUR Recommendation NE 107.

Diagnostic information

The fault can be identified using the diagnostic information. The short text helps you by providing information about the fault.

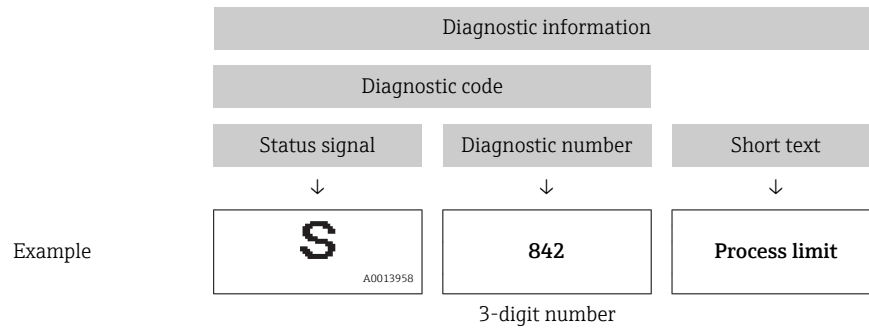

12.3.2 Calling up remedy information

Remedy information is provided for every diagnostic event to ensure that problems can be rectified quickly. These measures are displayed in red along with the diagnostic event and the related diagnostic information.

12.4 Diagnostic information in FieldCare

12.4.1 Diagnostic options

Any faults detected by the measuring device are displayed on the home page of the operating tool once the connection has been established.

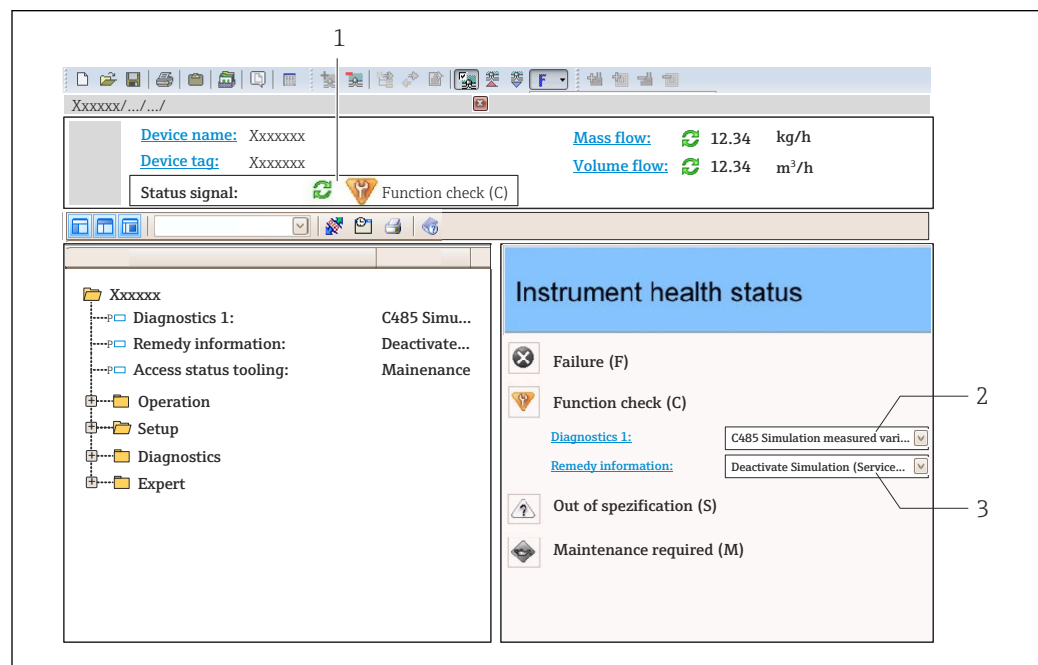

A0021799-EN

- 1 Status area with status signal
- 2 Diagnostic information (→ 70)
- 3 Remedial measures with Service ID

- i** Furthermore, diagnostic events that have occurred can be viewed in the **Diagnostics** menu:
 - Via parameters (→ 📄 74)
 - Via submenu (→ 📄 75)

Diagnostic information

The fault can be identified using the diagnostic information. The short text helps you by providing information about the fault.

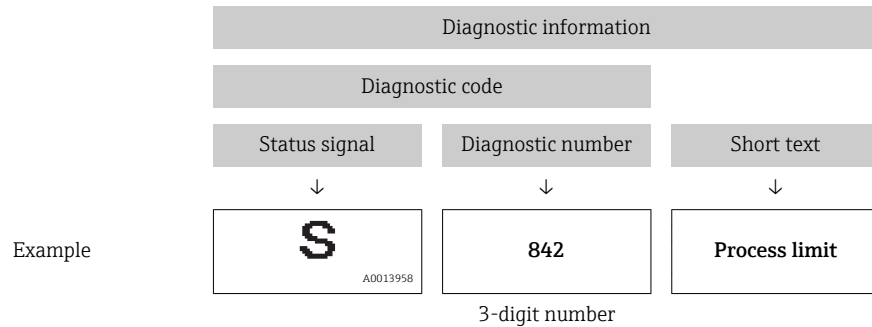

12.4.2 Calling up remedy information

Remedy information is provided for every diagnostic event to ensure that problems can be rectified quickly:

- On the home page
Remedy information is displayed in a separate field below the diagnostics information.
- In the **Diagnostics** menu
Remedy information can be called up in the working area of the user interface.

The user is in the **Diagnostics** menu.

1. Call up the desired parameter.
2. On the right in the working area, mouse over the parameter.
 - ↳ A tool tip with remedy information for the diagnostic event appears.

12.5 Diagnostic information via communication interface

12.5.1 Reading out diagnostic information

The current diagnostic event and associated diagnostic information can be read out via the input assembly (fix assembly):

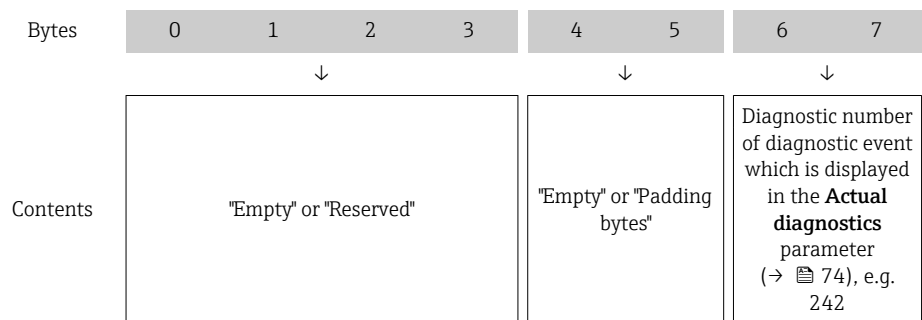

- i** For content of bytes 8 to 16 (→ 📄 88)

12.6 Adapting the diagnostic information

12.6.1 Adapting the diagnostic behavior

Each item of diagnostic information is assigned a specific diagnostic behavior at the factory. The user can change this assignment for certain diagnostics information in the **Diagnostic behavior** submenu .



"Expert" menu → System → Diagnostic handling → Diagnostic behavior

You can assign the following options to the diagnostic number as the diagnostic behavior:

Options	Description
Alarm	Measurement is interrupted. The totalizers assume the defined alarm condition. A diagnostic message is generated.
Warning	Measurement is resumed. The totalizers are not affected. A diagnostic message is generated.
Logbook entry only	The device continues to measure. The diagnostic message is entered in the Event logbook (events list) submenu only and is not displayed in alternation with the measured value display.
Off	The diagnostic event is ignored, and no diagnostic message is generated or entered.

12.7 Overview of diagnostic information

 The amount of diagnostic information and the number of measured variables affected increase if the measuring device has one or more application packages.

 In the case of some items of diagnostic information, the status signal and the diagnostic behavior can be changed. Adapt the diagnostic information (→  72)

Diagnostic number	Short text	Remedy instructions	Status signal [from the factory]	Diagnostic behavior [from the factory]
Diagnostic of sensor				
004	Sensor	1. Change sensor 2. Contact service	S	Alarm
022	Sensor temperature	1. Change main electronic module 2. Change sensor	F	Alarm
043	Sensor short circuit	1. Check sensor and cable 2. Change sensor or cable	S	Warning
062	Sensor connection	1. Check sensor connections 2. Contact service	F	Alarm
082	Data storage	1. Check module connections 2. Contact service	F	Alarm
083	Memory content	1. Restart device 2. Contact service	F	Alarm
190	Special event 1	Contact service	F	Alarm
Diagnostic of electronic				
201	Device failure	1. Restart device 2. Contact service	F	Alarm
222	Electronic drift	Change main electronic module	F	Alarm
242	Software incompatible	1. Check software 2. Flash or change main electronics module	F	Alarm

Diagnostic number	Short text	Remedy instructions	Status signal [from the factory]	Diagnostic behavior [from the factory]
252	Modules incompatible	1. Check electronic modules 2. Change electronic modules	F	Alarm
262	Module connection	1. Check module connections 2. Change main electronics	F	Alarm
270	Main electronic failure	Change main electronic module	F	Alarm
271	Main electronic failure	1. Restart device 2. Change main electronic module	F	Alarm
272	Main electronic failure	1. Restart device 2. Contact service	F	Alarm
273	Main electronic failure	Change electronic	F	Alarm
281	Electronic initialization	Firmware update active, please wait!	F	Alarm
283	Memory content	1. Reset device 2. Contact service	F	Alarm
302	Device verification active	Device verification active, please wait.	C	Warning
311	Electronic failure	1. Reset device 2. Contact service	F	Alarm
311	Electronic failure	1. Do not reset device 2. Contact service	M	Warning
322	Electronic drift	1. Perform verification manually 2. Change electronic	S	Warning
382	Data storage	1. Insert DAT module 2. Change DAT module	F	Alarm
383	Memory content	1. Restart device 2. Check or change DAT module 3. Contact service	F	Alarm
390	Special event 2	Contact service	F	Alarm
Diagnostic of configuration				
410	Data transfer	1. Check connection 2. Retry data transfer	F	Alarm
411	Up-/download active	Up-/download active, please wait	C	Warning
437	Configuration incompatible	1. Restart device 2. Contact service	F	Alarm
438	Dataset	1. Check data set file 2. Check device configuration 3. Up- and download new configuration	M	Warning
453	Flow override	Deactivate flow override	C	Warning
484	Simulation failure mode	Deactivate simulation	C	Alarm
485	Simulation measured variable	Deactivate simulation	C	Warning
495	Simulation diagnostic event	Deactivate simulation	C	Warning
500	Electrode 1 potential exceeded	1. Check process cond. 2. Increase system pressure	F	Alarm
500	Electrode difference voltage too high	1. Check process cond. 2. Increase system pressure	F	Alarm
530	Electrode cleaning is running	1. Check process cond. 2. Increase system pressure	C	Warning



Diagnostic number	Short text	Remedy instructions	Status signal [from the factory]	Diagnostic behavior [from the factory]
531	Empty pipe detection	Execute EPD adjustment	S	Warning
537	Configuration	1. Check IP addresses in network 2. Change IP address	F	Warning
590	Special event 3	Contact service	F	Alarm
Diagnostic of process				
832	Electronic temperature too high	Reduce ambient temperature	S	Warning ¹⁾
833	Electronic temperature too low	Increase ambient temperature	S	Warning ¹⁾
834	Process temperature too high	Reduce process temperature	S	Warning ¹⁾
835	Process temperature too low	Increase process temperature	S	Warning ¹⁾
842	Process limit	Low flow cut off active! 1. Check low flow cut off configuration	S	Warning
862	Empty pipe	1. Check for gas in process 2. Adjust empty pipe detection	S	Warning
882	Input signal	1. Check input configuration 2. Check external device or process conditions	F	Alarm
937	EMC interference	1. Check ambient conditions regarding EMC influence 2. Change main electronic module	S	Warning
937	EMC interference	Change main electronic module	S	Warning
990	Special event 4	Contact service	F	Alarm



1) Diagnostic status is changeable.

12.8 Pending diagnostic events

The **Diagnostics** menu allows the user to view the current diagnostic event and the previous diagnostic event separately.

 To call up the measures to rectify a diagnostic event:

- Via Web browser (→  70)
- Via "FieldCare" operating tool (→  71)

 Other pending diagnostic events can be displayed in the **Diagnostic list** submenu (→  75)

Navigation

"Diagnostics" menu

Structure of the submenu

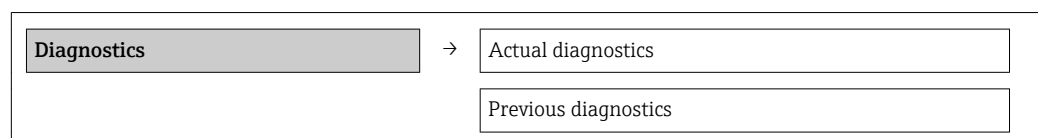

Parameter overview with brief description

Parameter	Prerequisite	Description	User interface	Factory setting
Actual diagnostics	1 diagnostic event has occurred.	Displays the current diagnostic event along with the diagnostic information.  If two or more messages occur simultaneously, the message with the highest priority is shown on the display.	Symbol for diagnostic behavior, diagnostic code and short message.	–
Previous diagnostics	2 diagnostic events have already occurred.	Displays the diagnostic event that occurred prior to the current diagnostic event along with the diagnostic information.	Symbol for diagnostic behavior, diagnostic code and short message.	–

12.9 Diagnostic list



In the **Diagnostic list** submenu, up to 5 currently pending diagnostic events can be displayed along with the related diagnostic information. If more than 5 diagnostic events are pending, the events with the highest priority are shown on the display.

Navigation path

Diagnostics menu → **Diagnostic list** submenu



To call up the measures to rectify a diagnostic event:

- Via Web browser (→  70)
- Via "FieldCare" operating tool (→  71)

12.10 Event logbook

12.10.1 Event history



A chronological overview of the event messages that have occurred is provided in the **Events list** submenu.

Navigation path



"Diagnostics" menu → Event logbook → Events list

A maximum of 20 event messages can be displayed in chronological order.

The event history includes entries for:



- Diagnostic events (→  72)
- Information events (→  76)

In addition to the operation time of its occurrence, each event is also assigned a symbol that indicates whether the event has occurred or is ended:

- Diagnostic event
 - : Event has occurred
 - : Event has ended
- Information event
 - : Event has occurred



To call up the measures to rectify a diagnostic event:

- Via Web browser (→  70)
- Via "FieldCare" operating tool (→  71)



For filtering the displayed event messages (→  76)

12.10.2 Filtering the event logbook

Using the **Filter options** parameter, you can define which category of event messages is displayed in the **Events list** submenu.

Navigation path

"Diagnostics" menu → Event logbook → Filter options

Filter categories

- All
- Failure (F)
- Function check (C)
- Out of specification (S)
- Maintenance required (M)
- Information (I)

12.10.3 Overview of information events

Unlike a diagnostic event, an information event is displayed in the event logbook only and not in the diagnostic list.

Info number	Info name
I1000	----- (Device ok)
I1089	Power on
I1090	Configuration reset
I1091	Configuration changed
I1110	Write protection switch changed
I1137	Electronic changed
I1151	History reset
I1155	Reset electronic temperature
I1157	Memory error event list
I1185	Display backup done
I1186	Restore via display done
I1187	Settings downloaded with display
I1188	Display data cleared
I1189	Backup compared
I1256	Display: access status changed
I1264	Safety sequence aborted
I1335	Firmware changed
I1351	Empty pipe detection adjustment failure
I1353	Empty pipe detection adjustment ok
I1361	Wrong web server login
I1397	Fieldbus: access status changed
I1398	CDI: access status changed
I1444	Device verification passed
I1445	Device verification failed
I1457	Failed: Measured error verification
I1459	Failed: I/O module verification
I1461	Failed: Sensor verification
I1462	Failed: Sensor electronic module verific.

12.11 Resetting the measuring device

Using the **Device reset** parameter it is possible to reset the entire device configuration or some of the configuration to a defined state.

"Setup" menu → Advanced setup → Administration

Function scope of "Device reset" parameter

Options	Description
Cancel	No action is executed and the user exits the parameter.
To delivery settings	Every parameter for which a customer-specific default setting was ordered is reset to this customer-specific value. All other parameters are reset to the factory setting.  This option is not visible if no customer-specific settings have been ordered.
Restart device	The restart resets every parameter whose data are in the volatile memory (RAM) to the factory setting (e.g. measured value data). The device configuration remains unchanged.
History reset	Every parameter is reset to its factory setting.

12.12 Device information

The **Device information** submenu contains all the parameters that display different information for identifying the device.

Navigation

"Diagnostics" menu → Device information

Device information

→

Device tag

Serial number

Firmware version

Device name

Order code

Extended order code 1

Extended order code 2

Extended order code 3

ENP version

IP address

Subnet mask

Default gateway

Parameter overview with brief description

Parameter	Description	User interface / User entry	Factory setting
Device tag	Enter tag for measuring point.	Max. 32 characters, such as letters, numbers or special characters (e.g. @, %, /)	Promag 100
Serial number	Displays the serial number of the measuring device.	Max. 11-digit character string comprising letters and numbers.	79AFF16000
Firmware version	Displays the device firmware version installed.	Character string with the following format: xx.yy.zz	01.01
Device name	Displays the name of the transmitter.	Character string composed of letters, numbers and certain punctuation marks.	Promag 100
Order code	Displays the device order code.	Character string composed of letters, numbers and certain punctuation marks	-
Extended order code 1	Displays the 1st part of the extended order code.	Character string	-
Extended order code 2	Displays the 2nd part of the extended order code.	Character string	-
Extended order code 3	Displays the 3rd part of the extended order code.	Character string	-
ENP version	Displays the version of the electronic nameplate.	Character string in the format xx.yy.zz	2.02.00
IP address	Displays the IP address of the Web server of the measuring device.	4 octet: 0 to 255 (in the particular octet)	192.168.1.212
Subnet mask	Displays the subnet mask.	4 octet: 0 to 255 (in the particular octet)	255.255.255.0
Default gateway	Displays the default gateway.	4 octet: 0 to 255 (in the particular octet)	0.0.0.0

12.13 Firmware history

Release date	Firmware version	Order code for "Firmware version"	Firmware changes	Documentation type	Documentation
06.2012	01.00.00	-	Original firmware	-	-
04.2013	01.01.zz	Option 73	Update	Operating Instructions	BA01174D/06/EN/01.13
10.2014	01.01.zz	Option 71	<ul style="list-style-type: none"> ▪ Integration of optional onsite display ▪ Heartbeat functionality for Rockwell AOP ▪ New unit "Beer Barrel (BBL)" ▪ Simulation of diagnostic events 	Operating Instructions	BA01174D/06/EN/02.14

 Flashing the firmware to the current version or to the previous version is possible via the service interface (CDI) .

 For the compatibility of the firmware version with the previous version, the installed device description files and operating tools, observe the information about the device in the "Manufacturer's information" document.

-  The manufacturer's information is available:
- In the Download Area of the Endress+Hauser Internet site: www.endress.com → Download
 - Specify the following details:
 - Product root: e.g. 5H1B
 - Text search: Manufacturer's information
 - Search range: documentation

13 Maintenance

13.1 Maintenance tasks

No special maintenance work is required.

13.1.1 Exterior cleaning

When cleaning the exterior of measuring devices, always use cleaning agents that do not attack the surface of the housing or the seals.

13.1.2 Interior cleaning

No interior cleaning is planned for the device.

13.1.3 Replacing seals

The sensor's seals (particularly aseptic molded seals) must be replaced periodically.

The interval between changes depends on the frequency of the cleaning cycles, the cleaning temperature and the medium temperature.

Replacement seals (accessory) (->  102)

13.2 Measuring and test equipment

Endress+Hauser offers a wide variety of measuring and test equipment, such as W@M or device tests.

 Your Endress+Hauser Sales Center can provide detailed information on the services.

 For a list of some of the measuring and test equipment, refer to the "Accessories" chapter of the "Technical Information" document for the device.

13.3 Endress+Hauser services

Endress+Hauser offers a wide variety of services for maintenance such as recalibration, maintenance service or device tests.

 Your Endress+Hauser Sales Center can provide detailed information on the services.

14 Repair

14.1 General notes

Repair and conversion concept

The Endress+Hauser repair and conversion concept provides for the following:

- The measuring devices have a modular design.
- Spare parts are grouped into logical kits with the associated Installation Instructions.
- Repairs are carried out by Endress+Hauser Service or by correspondingly trained customers.
- Certified devices can be converted into other certified devices by Endress+Hauser Service or at the factory only.

Notes for repair and conversion

For repair and modification of a measuring device, observe the following notes:

- Use only original Endress+Hauser spare parts.
- Carry out the repair according to the Installation Instructions.
- Observe the applicable standards, federal/national regulations, Ex documentation (XA) and certificates.
- Document every repair and each conversion and enter them into the *W@M* life cycle management database.

14.2 Spare parts



Measuring device serial number:

- Is located on the nameplate of the device.
- Can be read out via the **Serial number** parameter in the **Device information** submenu (→ 77).

14.3 Endress+Hauser services



Contact your Endress+Hauser Sales Center for information on services and spare parts.

14.4 Return

The measuring device must be returned if repairs or a factory calibration are required, or if the wrong measuring device has been ordered or delivered. According to legal regulations, Endress+Hauser, as an ISO-certified company, is required to follow certain procedures when handling returned products that are in contact with medium.

To ensure swift, safe and professional device returns, please read the return procedures and conditions on the Endress+Hauser website at

www.services.endress.com/return-material

14.5 Disposal

14.5.1 Removing the measuring device

1. Switch off the device.
2. **WARNING!** Danger to persons from process conditions. Beware of hazardous process conditions such as pressure in the measuring device, high temperatures or aggressive fluids.

Carry out the mounting and connection steps from the chapters "Mounting the measuring device" and "Connecting the measuring device" in the logically reverse sequence. Observe the safety instructions.

14.5.2 Disposing of the measuring device

⚠ WARNING

Danger to personnel and environment from fluids that are hazardous to health.

- ▶ Ensure that the measuring device and all cavities are free of fluid residues that are hazardous to health or the environment, e.g. substances that have permeated into crevices or diffused through plastic.

Observe the following notes during disposal:

- Observe valid federal/national regulations.
- Ensure proper separation and reuse of the device components.

15 Accessories

Various accessories, which can be ordered with the device or subsequently from Endress+Hauser, are available for the device. Detailed information on the order code in question is available from your local Endress+Hauser sales center or on the product page of the Endress+Hauser website: www.endress.com.

15.1 Device-specific accessories

15.1.1 For the transmitter

Accessories	Description
Ground cable	Set, consisting of two ground cables for potential equalization.

15.1.2 For the sensor

Accessories	Description
Ground disks	<p>Are used to ground the fluid in lined measuring tubes to ensure proper measurement.</p> <p> For details, see Installation Instructions EA00070D</p>

15.2 Communication-specific accessories

Accessories	Description
-------------	-------------

15.3 Service-specific accessories

Accessories	Description
Applicator	<p>Software for selecting and sizing Endress+Hauser measuring devices:</p> <ul style="list-style-type: none"> ▪ Calculation of all the necessary data for identifying the optimum flowmeter: e.g. nominal diameter, pressure loss, accuracy or process connections. ▪ Graphic illustration of the calculation results <p>Administration, documentation and access to all project-related data and parameters over the entire life cycle of a project.</p> <p>Applicator is available:</p> <ul style="list-style-type: none"> ▪ Via the Internet: https://wapps.endress.com/applicator ▪ On CD-ROM for local PC installation.

W@M	<p>Life cycle management for your plant</p> <p>W@M supports you with a wide range of software applications over the entire process: from planning and procurement, to the installation, commissioning and operation of the measuring devices. All the relevant device information, such as the device status, spare parts and device-specific documentation, is available for every device over the entire life cycle.</p> <p>The application already contains the data of your Endress+Hauser device. Endress+Hauser also takes care of maintaining and updating the data records.</p> <p>W@M is available:</p> <ul style="list-style-type: none"> ■ Via the Internet: www.endress.com/lifecyclemanagement ■ On CD-ROM for local PC installation.
FieldCare	<p>FDT-based plant asset management tool from Endress+Hauser.</p> <p>It can configure all smart field units in your system and helps you manage them. By using the status information, it is also a simple but effective way of checking their status and condition.</p> <p> For details, see Operating Instructions BA00027S and BA00059S</p>

15.4 System components

Accessories	Description
Memograph M graphic display recorder	<p>The Memograph M graphic display recorder provides information on all relevant measured variables. Measured values are recorded correctly, limit values are monitored and measuring points analyzed. The data are stored in the 256 MB internal memory and also on a SD card or USB stick.</p> <p> For details, see "Technical Information" TI00133R and Operating Instructions BA00247R</p>

16 Technical data

16.1 Application

Depending on the version ordered, the measuring device can also measure potentially explosive, flammable, poisonous and oxidizing media.

To ensure that the device remains in proper operating condition for its service life, use the measuring device only for media against which the process-wetted materials are adequately resistant.

16.2 Function and system design

Measuring principle	Electromagnetic flow measurement on the basis of <i>Faraday's law of magnetic induction</i> .
Measuring system	One device version is available: compact version, transmitter and sensor form a mechanical unit. For information on the structure of the device (→  11)

16.3 Input

Measured variable	<p>Direct measured variables</p> <ul style="list-style-type: none"> ▪ Volume flow (proportional to induced voltage) ▪ Electrical conductivity <p>Calculated measured variables</p> <ul style="list-style-type: none"> ▪ Mass flow ▪ Corrected volume flow
Measuring range	Typically $v = 0.01$ to 10 m/s (0.03 to 33 ft/s) with the specified accuracy Electrical conductivity: 5 to $10\,000$ $\mu\text{S/cm/cm}$

Flow characteristic values in SI units

Nominal diameter		Recommended flow	Factory settings
[mm]	[in]	min./max. full scale value ($v \sim 0.3/10$ m/s) [dm ³ /min]	Low flow cut off ($v \sim 0.04$ m/s) [dm ³ /min]
15	½	4 to 100	0.5
25	1	9 to 300	1
32	–	15 to 500	2
40	1 ½	25 to 700	3
50	2	35 to 1 100	5
65	–	60 to 2 000	8
80	3	90 to 3 000	12
100	4	145 to 4 700	20

Nominal diameter		Recommended flow min./max. full scale value (v ~ 0.3/10 m/s) [dm ³ /min]	Factory settings Low flow cut off (v ~ 0.04 m/s) [dm ³ /min]
[mm]	[in]		
125	–	220 to 7 500	30
150	6	20 to 600 m ³ /h	2.5 m ³ /h
200	8	35 to 1 100 m ³ /h	5 m ³ /h
250	10	55 to 1 700 m ³ /h	7.5 m ³ /h
300	12	80 to 2 400 m ³ /h	10 m ³ /h
350	14	110 to 3 300 m ³ /h	15 m ³ /h
400	16	140 to 4 200 m ³ /h	20 m ³ /h
450	18	180 to 5 400 m ³ /h	25 m ³ /h
500	20	220 to 6 600 m ³ /h	30 m ³ /h
600	24	310 to 9 600 m ³ /h	40 m ³ /h

Flow characteristic values in US units

Nominal diameter		Recommended flow min./max. full scale value (v ~ 0.3/10 m/s) [gal/min]	Factory settings Low flow cut off (v ~ 0.04 m/s) [gal/min]
[in]	[mm]		
½	15	1.0 to 27	0.15
1	25	2.5 to 80	0.25
1 ½	40	7 to 190	0.75
2	50	10 to 300	1.25
3	80	24 to 800	2.5
4	100	40 to 1 250	4
6	150	90 to 2 650	12
8	200	155 to 4 850	15
10	250	250 to 7 500	30
12	300	350 to 10 600	45
14	350	500 to 15 000	60
16	400	600 to 19 000	60
18	450	800 to 24 000	90
20	500	1 000 to 30 000	120
24	600	1 400 to 44 000	180

Recommended measuring range

"Flow limit" section (→  95)

Operable flow range



Over 1000 : 1

Input signal

External measured values

To increase the accuracy of certain measured variables or to calculate the corrected volume flow, the automation system can continuously write different measured values to the measuring device:

- Operating pressure to increase accuracy (Endress+Hauser recommends the use of a pressure measuring device for absolute pressure, e.g. Cerabar M or Cerabar S)
- Medium temperature to increase accuracy (e.g. iTEMP)
- Reference density for calculating the corrected volume flow

 Various pressure transmitters and temperature measuring devices can be ordered from Endress+Hauser: see "Accessories" section (→  84)

It is recommended to read in external measured values to calculate the following measured variables:

Corrected volume flow

Fieldbus

The measured values are written from the automation system to the measuring device via EtherNet/IP.

16.4 Output

Output signal

EtherNet/IP

Standards	In accordance with IEEE 802.3
------------------	-------------------------------

Signal on alarm

Depending on the interface, failure information is displayed as follows:

EtherNet/IP

Device diagnostics	Device condition can be read out in Input Assembly
---------------------------	--

Local display

Plain text display	With information on cause and remedial measures
Backlight	Red backlighting indicates a device error.

 Status signal as per NAMUR recommendation NE 107

Operating tool

- Via digital communication:
EtherNet/IP
- Via service interface

Plain text display	With information on cause and remedial measures
---------------------------	---

Web browser

Plain text display	With information on cause and remedial measures
---------------------------	---

Light emitting diodes (LED)

Status information	Status indicated by various light emitting diodes The following information is displayed depending on the device version: <ul style="list-style-type: none"> ▪ Supply voltage active ▪ Data transmission active ▪ Device alarm/error has occurred ▪ EtherNet/IP network available ▪ EtherNet/IP connection established
---------------------------	--

Low flow cut off The switch points for low flow cut off are user-selectable.

Galvanic isolation The following connections are galvanically isolated from each other:

- Outputs
- Power supply

Protocol-specific data **EtherNet/IP**

Protocol	<ul style="list-style-type: none"> ▪ The CIP Networks Library Volume 1: Common Industrial Protocol ▪ The CIP Networks Library Volume 2: EtherNet/IP Adaptation of CIP 		
Communication type	<ul style="list-style-type: none"> ▪ 10Base-T ▪ 100Base-TX 		
Device profile	Generic device (product type: 0x2B)		
Manufacturer ID	0x49E		
Device type ID	0x103A		
Baud rates	Automatic ¹⁹ / ₁₀₀ Mbit with half-duplex and full-duplex detection		
Polarity	Auto-polarity for automatic correction of crossed TxD and RxD pairs		
Supported CIP connections	Max. 3 connections		
Explicit connections	Max. 6 connections		
I/O connections	Max. 6 connections (scanner)		
Configuration options for measuring device	<ul style="list-style-type: none"> ▪ DIP switches on the electronics module for IP addressing ▪ Manufacturer-specific software (FieldCare) ▪ Add-on Profile Level 3 for Rockwell Automation control systems ▪ Web browser ▪ Electronic Data Sheet (EDS) integrated in the measuring device 		
Configuration of the EtherNet interface	<ul style="list-style-type: none"> ▪ Speed: 10 MBit, 100 MBit, auto (factory setting) ▪ Duplex: half-duplex, full-duplex, auto (factory setting) 		
Configuration of the device address	<ul style="list-style-type: none"> ▪ DIP switches on the electronics module for IP addressing (last octet) ▪ DHCP ▪ Manufacturer-specific software (FieldCare) ▪ Add-on Profile Level 3 for Rockwell Automation control systems ▪ Web browser ▪ EtherNet/IP tools, e.g. RSLinx (Rockwell Automation) 		
Device Level Ring (DLR)	No		
Fix Input			
RPI	5 ms to 10 s (factory setting: 20 ms)		
Exclusive Owner Multicast		Instance	Size [byte]
	Instance configuration:	0x68	398
	O → T configuration:	0x66	56
	T → O configuration:	0x64	32
Exclusive Owner Multicast		Instance	Size [byte]

	Instance configuration:	0x69	-
	O → T configuration:	0x66	56
	T → O configuration:	0x64	32
Input only Multicast		Instance	Size [byte]
	Instance configuration:	0x68	398
	O → T configuration:	0xC7	-
	T → O configuration:	0x64	32
Input only Multicast		Instance	Size [byte]
	Instance configuration:	0x69	-
	O → T configuration:	0xC7	-
	T → O configuration:	0x64	32
Input Assembly	<ul style="list-style-type: none"> ■ Current device diagnostics ■ Volume flow ■ Mass flow ■ Corrected volume flow ■ Totalizer 1 ■ Totalizer 2 ■ Totalizer 3 		
Configurable Input			
RPI	5 ms to 10 s (factory setting: 20 ms)		
Exclusive Owner Multicast		Instance	Size [byte]
	Instance configuration:	0x68	398
	O → T configuration:	0x66	56
	T → O configuration:	0x65	88
Exclusive Owner Multicast		Instance	Size [byte]
	Instance configuration:	0x69	-
	O → T configuration:	0x66	56
	T → O configuration:	0x65	88
Input only Multicast		Instance	Size [byte]
	Instance configuration:	0x68	398
	O → T configuration:	0xC7	-
	T → O configuration:	0x65	88
Input only Multicast		Instance	Size [byte]
	Instance configuration:	0x69	-
	O → T configuration:	0xC7	-
	T → O configuration:	0x65	88

Configurable Input Assembly	<ul style="list-style-type: none"> ▪ Volume flow ▪ Corrected volume flow ▪ Mass flow ▪ Electronic temperature ▪ Totalizer 1 to 3 ▪ Flow velocity ▪ Volume flow unit ▪ Corrected volume flow unit ▪ Mass flow unit ▪ Temperature unit ▪ Unit totalizer 1-3 ▪ Flow velocity unit ▪ Verification result ▪ Verification status <p> The range of options increases if the measuring device has one or more application packages.</p>
Fix Output	
Output Assembly	<ul style="list-style-type: none"> ▪ Activation of reset totalizers 1-3 ▪ Activation of reference density compensation ▪ Activation of temperature compensation ▪ Reset totalizers 1-3 ▪ External density ▪ Density unit ▪ External temperature ▪ Activation verification ▪ Start verification
Configuration	
Configuration Assembly	<p>Only the most common configurations are listed below.</p> <ul style="list-style-type: none"> ▪ Software write protection ▪ Mass flow unit ▪ Mass unit ▪ Volume flow unit ▪ Volume unit ▪ Corrected volume flow unit ▪ Corrected volume unit ▪ Density unit ▪ Reference density unit ▪ Temperature unit ▪ Pressure unit ▪ Length ▪ Totalizer 1-3: <ul style="list-style-type: none"> - Assignment - Unit - Measuring mode - Failure mode ▪ Alarm delay

16.5 Power supply

Terminal assignment (→  28)

Pin assignment, device plug (→  29)

Supply voltage

Transmitter

For device version with all communication types: DC 20 to 30 V

The power unit must be tested to ensure it meets safety requirements (e.g. PELV, SELV).

Power consumption

Transmitter

Order code for "Output"	Maximum Power consumption
Option N: EtherNet/IP	3.5 W

Current consumption

Transmitter

Order code for "Output"	Maximum Current consumption	Maximum switch-on current
Option N: EtherNet/IP	145 mA	18 A (<0.125 ms)

Power supply failure

- Totalizers stop at the last value measured.
- Depending on the device version, the configuration is retained in the device memory or in the plug-in memory (HistoROM DAT).
- Error messages (incl. total operated hours) are stored.

Electrical connection

(→  29)

Potential equalization

(→  31)

Terminals

TransmitterSpring terminals for wire cross-sections 0.5 to 2.5 mm² (20 to 14 AWG)

Cable entries

- Cable gland: M20 × 1.5 with cable ϕ 6 to 12 mm (0.24 to 0.47 in)
- Thread for cable entry:
 - NPT 1/2"
 - G 1/2"
 - M20

Cable specification

(→  27)

16.6 Performance characteristics

Reference operating conditions

In accordance with DIN EN 29104

- Fluid temperature: +28±2 °C (+82±4 °F)
- Ambient temperature range: +22±2 °C (+72±4 °F)
- Warm-up period: 30 min

Installation

- Inlet run > 10 × DN
- Outlet run > 5 × DN
- Sensor and transmitter grounded.
- The sensor is centered in the pipe.

Maximum measured error

Error limits under reference operating conditions

o.r. = of reading

Volume flow

- ±0.5 % o.r. ± 1 mm/s (0.04 in/s)
- Optional: ±0.2 % o.r. ± 2 mm/s (0.08 in/s)

i Fluctuations in the supply voltage do not have any effect within the specified range.

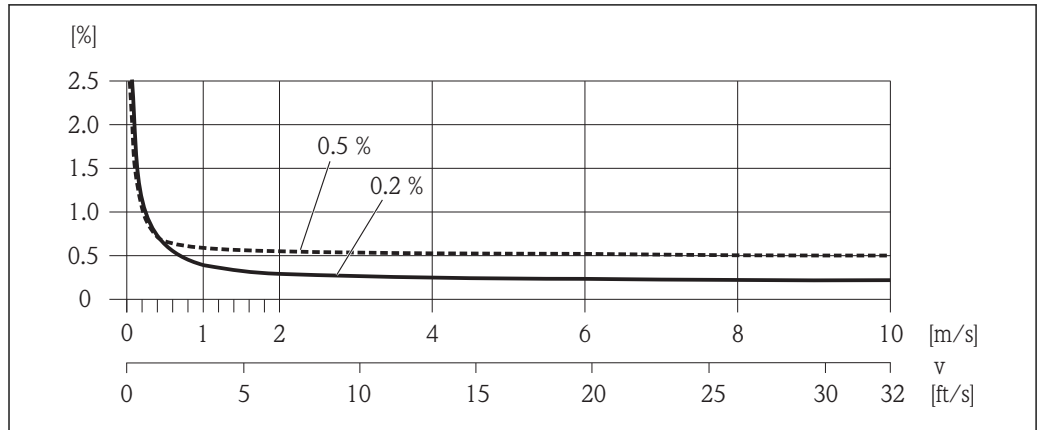

16 Maximum measured error in % o.r.

Electrical conductivity
Max. measured error not specified.

Repeatability	o.r. = of reading
	Volume flow
	Max. ± 0.1 % o.r. ± 0.5 mm/s (0.02 in/s)
	Electrical conductivity
	Max. ± 5 % o.r.

Temperature measurement response time $T_{90} < 15$ s

16.7 Installation

"Mounting requirements" (\rightarrow **17**)

16.8 Environment

Ambient temperature range (\rightarrow **19**)

Storage temperature

The storage temperature corresponds to the operating temperature range of the measuring transmitter and the appropriate measuring sensors.

- Protect the measuring device against direct sunlight during storage in order to avoid unacceptably high surface temperatures.
- Select a storage location where moisture cannot collect in the measuring device as fungus or bacteria infestation can damage the liner.
- If protection caps or protective covers are mounted these should never be removed before installing the measuring device.

Degree of protection	<p>Transmitter and sensor</p> <ul style="list-style-type: none"> ■ As standard: IP66/67, type 4X enclosure ■ With the order code for "Sensor options", option CM: IP69K can also be ordered ■ When housing is open: IP20, type 1 enclosure ■ Display module: IP20, type 1 enclosure
Shock resistance	As per IEC/EN 60068-2-31
Vibration resistance	Acceleration up to 2 g following IEC 60068-2-6
Mechanical load	<ul style="list-style-type: none"> ■ Protect the transmitter housing against mechanical effects, such as shock or impact. ■ Never use the transmitter housing as a ladder or climbing aid.
Electromagnetic compatibility (EMC)	<ul style="list-style-type: none"> ■ As per IEC/EN 61326 and NAMUR Recommendation 21 (NE 21) ■ Complies with emission limits for industry as per EN 55011 (Class A) <p> For details refer to the Declaration of Conformity.</p>

16.9 Process

Medium temperature range

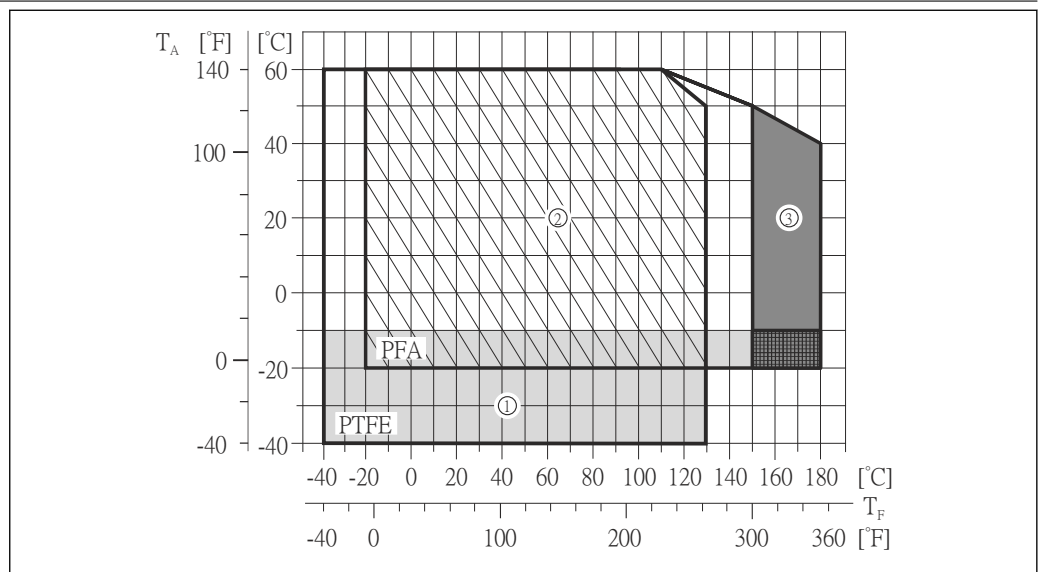

T_A Ambient temperature

T_F Medium temperature

- 1 Gray area: the ambient and fluid temperature range of -10 to -40 °C (-14 to -40 °F) applies to stainless flanges only
- 2 Hatched area: harsh environment and IP68 only up to $+130$ °C ($+266$ °F)
- 3 Dark-gray area: high-temperature version with insulation

Conductivity $\geq 5 \mu\text{S/cm}$ for liquids in general

Pressure-temperature ratings

 An overview of the pressure-temperature ratings for the process connections is provided in the "Technical Information" document

Pressure tightness







"-" = no specifications possible

Liner: PFA

Nominal diameter		Limit values for absolute pressure in [mbar] ([psi]) for fluid temperatures:		
[mm]	[in]	+25 °C (+77 °F)	+80 °C (+176 °F)	+100 to +180 °C (+212 to +356 °F)
25	1	0 (0)	0 (0)	0 (0)
32	-	0 (0)	0 (0)	0 (0)
40	1 ½	0 (0)	0 (0)	0 (0)
50	2	0 (0)	0 (0)	0 (0)
65	-	0 (0)	-	0 (0)
80	3	0 (0)	-	0 (0)
100	4	0 (0)	-	0 (0)
125	-	0 (0)	-	0 (0)
150	6	0 (0)	-	0 (0)
200	8	0 (0)	-	0 (0)

Liner: PTFE

Nominal diameter		Limit values for absolute pressure in [mbar] ([psi]) for fluid temperatures:			
[mm]	[in]	+25 °C (+77 °F)	+80 °C (+176 °F)	+100 °C (+212 °F)	+130 °C (+266 °F)
15	½	0 (0)	0 (0)	0 (0)	100 (1.45)
25	1	0 (0)	0 (0)	0 (0)	100 (1.45)
32	-	0 (0)	0 (0)	0 (0)	100 (1.45)
40	1 ½	0 (0)	0 (0)	0 (0)	100 (1.45)
50	2	0 (0)	0 (0)	0 (0)	100 (1.45)
65	-	0 (0)	-	40 (0.58)	130 (1.89)
80	3	0 (0)	-	40 (0.58)	130 (1.89)
100	4	0 (0)	-	135 (1.96)	170 (2.47)
125	-	135 (1.96)	-	240 (3.48)	385 (5.58)
150	6	135 (1.96)	-	240 (3.48)	385 (5.58)
200	8	200 (2.90)	-	290 (4.21)	410 (5.95)
250	10	330 (4.79)	-	400 (5.80)	530 (7.69)
300	12	400 (5.80)	-	500 (7.25)	630 (9.14)
350	14	470 (6.82)	-	600 (8.70)	730 (10.6)
400	16	540 (7.83)	-	670 (9.72)	800 (11.6)
450	18	No negative pressure permitted!			
500	20				
600	24				

Flow limit	<p>The diameter of the pipe and the flow rate determine the nominal diameter of the sensor. The optimum velocity of flow is between 2 to 3 m/s (6.56 to 9.84 ft/s). Also match the velocity of flow (v) to the physical properties of the fluid:</p> <ul style="list-style-type: none"> ■ $v < 2$ m/s (6.56 ft/s): for abrasive fluids (e.g. potter's clay, lime milk, ore slurry) ■ $v > 2$ m/s (6.56 ft/s): for fluids producing buildup (e.g. wastewater sludges) <p> A necessary increase in the flow velocity can be achieved by reducing the sensor nominal diameter.</p> <p> For an overview of the measuring range full scale values, see the "Measuring range" section (→  85)</p>
Pressure loss	<ul style="list-style-type: none"> ■ No pressure loss occurs if the sensor is installed in a pipe with the same nominal diameter. ■ Pressure losses for configurations incorporating adapters according to DIN EN 545 (→  21)
System pressure	(→  20)
Vibrations	(→  20)

16.10 Mechanical construction

Design, dimensions	 For the dimensions and installation lengths of the device, see the "Technical Information" document, "Mechanical construction" section
--------------------	--

Weight	<p>Compact version</p> <ul style="list-style-type: none"> ■ Including the transmitter ■ High-temperature version + 1.5 kg (3.31 lbs) ■ Weight specifications apply to standard pressure ratings and without packaging material.
--------	---

Weight in SI units

Nominal diameter		EN (DIN), AS ¹⁾		ASME		JIS	
[mm]	[in]	Pressure rating	[kg]	Pressure rating	[kg]	Pressure rating	[kg]
15	½	PN 40	4.5	Class 150	4.5	10K	4.5
25	1	PN 40	5.3	Class 150	5.3	10K	5.3
32	–	PN 40	6	Class 150	–	10K	5.3
40	1 ½	PN 40	7.4	Class 150	7.4	10K	6.3
50	2	PN 40	8.6	Class 150	8.6	10K	7.3
65	–	PN 16	10	Class 150	–	10K	9.1
80	3	PN 16	12	Class 150	12	10K	10.5
100	4	PN 16	14	Class 150	14	10K	12.7
125	–	PN 16	19.5	Class 150	–	10K	19
150	6	PN 16	23.5	Class 150	23.5	10K	22.5
200	8	PN 10	43	Class 150	43	10K	39.9
250	10	PN 10	63	Class 150	73	10K	67.4
300	12	PN 10	68	Class 150	108	10K	70.3

Nominal diameter		EN (DIN), AS ¹⁾		ASME		JIS	
[mm]	[in]	Pressure rating	[kg]	Pressure rating	[kg]	Pressure rating	[kg]
350	14	PN 10	103	Class 150	173		
400	16	PN 10	118	Class 150	203		
450	18	PN 10	159	Class 150	253		
500	20	PN 10	154	Class 150	283		
600	24	PN 10	206	Class 150	403		

1) For flanges to AS, only DN 25 and 50 are available.

Weight in US units

Nominal diameter		ASME	
[mm]	[in]	Pressure rating	[lbs]
15	½	Class 150	9.92
25	1	Class 150	11.7
40	1 ½	Class 150	16.3
50	2	Class 150	19.0
80	3	Class 150	26.5
100	4	Class 150	30.9
150	6	Class 150	51.8
200	8	Class 150	94.8
250	10	Class 150	161.0
300	12	Class 150	238.1
350	14	Class 150	381.5
400	16	Class 150	447.6
450	18	Class 150	557.9
500	20	Class 150	624.0
600	24	Class 150	888.6

Measuring tube specification

Nominal diameter		Pressure rating					Process connection internal diameter			
[mm]	[in]	EN (DIN)	ASME	AS 2129	AS 4087	JIS	PFA		PTFE	
		[bar]	[psi]	[bar]	[bar]	[bar]	[mm]	[in]	[mm]	[in]
15	½	PN 40	Class 150	-	-	20K	-	-	15	0.59
25	1	PN 40	Class 150	Table E	-	20K	23	0.91	26	1.02
32	-	PN 40	-	-	-	20K	32	1.26	35	1.38
40	1 ½	PN 40	Class 150	-	-	20K	36	1.42	41	1.61
50	2	PN 40	Class 150	Table E	PN 16	10K	48	1.89	52	2.05
65	-	PN 16	-	-	-	10K	63	2.48	67	2.64
80	3	PN 16	Class 150	-	-	10K	75	2.95	80	3.15
100	4	PN 16	Class 150	-	-	10K	101	3.98	104	4.09
125	-	PN 16	-	-	-	10K	126	4.96	129	5.08
150	6	PN 16	Class 150	-	-	10K	154	6.06	156	6.14

Nominal diameter		Pressure rating					Process connection internal diameter			
		EN (DIN)	ASME	AS 2129	AS 4087	JIS	PFA		PTFE	
[mm]	[in]	[bar]	[psi]	[bar]	[bar]	[bar]	[mm]	[in]	[mm]	[in]
200	8	PN 10	Class 150	-	-	10K	201	7.91	202	7.95
250	10	PN 10	Class 150	-	-	10K	-	-	256	10.1
300	12	PN 10	Class 150	-	-	10K	-	-	306	12.0
350	14	PN 10	Class 150	-	-	-	-	-	337	13.3
400	16	PN 10	Class 150	-	-	-	-	-	387	15.2
450	18	PN 10	Class 150	-	-	-	-	-	432	17.0
500	20	PN 10	Class 150	-	-	-	-	-	487	19.2
600	24	PN 10	Class 150	-	-	-	-	23	593	23.3

Materials

Transmitter housing

Order code for "Housing", option A "Compact, aluminum coated":
Aluminum, AlSi10Mg, coated

Cable entries/cable glands

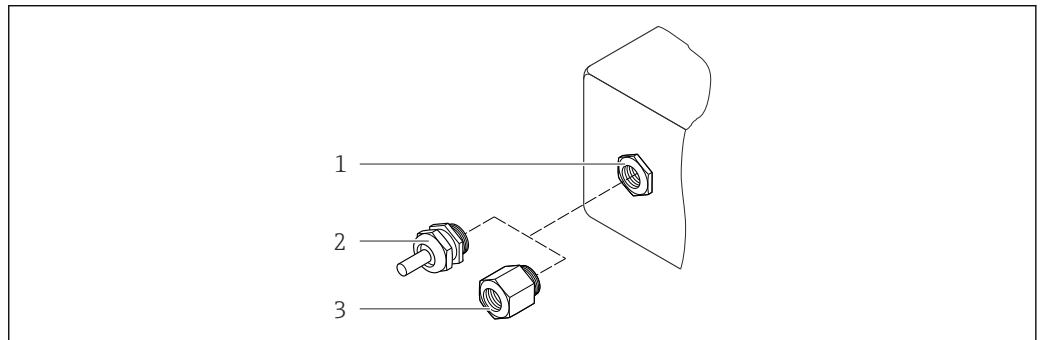

17 Possible cable entries/cable glands

- 1 Cable entry in transmitter housing, wall-mount housing or connection housing with internal thread M20 x 1.5
- 2 Cable gland M20 x 1.5
- 3 Adapter for cable entry with internal thread G 1/2" or NPT 1/2"

Order code for "Housing", option A "Compact, coated aluminum"

The various cable entries are suitable for hazardous and non-hazardous areas.

Cable entry/cable gland	Material
Cable gland M20 x 1.5	Nickel-plated brass
Adapter for cable entry with internal thread G 1/2"	
Adapter for cable entry with internal thread NPT 1/2"	

Device plug

Electrical connection	Material
Plug M12x1	<ul style="list-style-type: none"> ▪ Socket: Stainless steel, 1.4404 (316L) ▪ Contact housing: Polyamide ▪ Contacts: Gold-plated brass

Sensor housing

- DN 15 to 300 (½ to 12"): coated aluminum AlSi10Mg
- DN 350 to 600 (14 to 24"): carbon steel with protective varnish

Measuring tubes

Stainless steel, 1.4301/304/1.4306/304L; for flanges made of carbon with Al/Zn protective coating (DN 15 to 300 (½ to 12")) or protective varnish (DN 350 to 600 (14 to 24"))

Liner

- PFA
- PTFE

Process connections

EN 1092-1 (DIN 2501)

Stainless steel, 1.4571 (F316L); carbon steel, FE410WB¹⁾/S235JRG2; Alloy C22, 2.4602 (UNS N06022)

ASME B16.5

Stainless steel, F316L; carbon steel, A105¹⁾

JIS B2220

Stainless steel, 1.0425 (F316L)¹⁾; carbon steel, S235JRG2/HII

AS 2129 Table E

- DN 25 (1"): carbon steel, A105/S235JRG2
- DN 40 (1 ½"): carbon steel, A105/S275JR

AS 4087 PN 16

Carbon steel, A105/S275JR

 List of all available process connections (→  99)

Electrodes

Stainless steel, 1.4435 (F316L); Alloy C22, 2.4602 (UNS N06022); platinum; tantalum; titanium

Seals



In accordance with DIN EN 1514-1

Accessories

Ground disks

Stainless steel, 1.4435 (F316L); Alloy C22, 2.4602 (UNS N06022); tantalum; titanium

1) DN 15 to 300 (½ to 12") with Al/Zn protective coating; DN 350 to 600 (14 to 24") with protective varnish

Fitted electrodes	<p>Measuring electrodes, reference electrodes and electrodes for empty pipe detection:</p> <ul style="list-style-type: none"> ■ Standard: stainless steel, 1.4435 (F316L); Alloy C22, 2.4602 (UNS N06022); tantalum, titanium ■ Optional: only platinum measuring electrodes
Process connections	<ul style="list-style-type: none"> ■ EN 1092-1 (DIN 2501): DN ≤ 300 (12") form A, DN ≥ 350 (14") flat face; dimensions as per DIN 2501, DN 65 PN 16 and DN 600 (24") PN 16 only as per EN 1092-1 ■ ASME B16.5 ■ JIS B2220 ■ AS 2129 Table E ■ AS 4087 PN 16 <p> For information on the materials of the process connections (→  98)</p>
Surface roughness	<p>Stainless steel electrodes, 1.4435 (F316L); Alloy C22, 2.4602 (UNS N06022); platinum; tantalum; titanium: ≤ 0.3 to 0.5 μm (11.8 to 19.7 μin) (All data relate to parts in contact with fluid)</p> <p>Liner with PFA: ≤ 0.4 μm (15.7 μin) (All data relate to parts in contact with fluid)</p>

16.11 Operability

Local display	<p>The local display is only available with the following device version: Order code for "Display; Operation", option B: 4-line; via communication</p> <p>Display element</p> <ul style="list-style-type: none"> ■ 4-line liquid crystal display with 16 characters per line. ■ White background lighting; switches to red in event of device errors. ■ Format for displaying measured variables and status variables can be individually configured. ■ Permitted ambient temperature for the display: -20 to +60 °C (-4 to +140 °F). The readability of the display may be impaired at temperatures outside the temperature range. <p>Disconnecting the local display from the main electronics module</p> <p> In the case of the "Compact, aluminum coated" housing version, the local display must only be disconnected manually from the main electronics module. In the case of the "Compact, hygienic, stainless" and "Ultra compact, hygienic, stainless" housing versions, the local display is integrated in the housing cover and is disconnected from the main electronics module when the housing cover is opened.</p> <p><i>"Compact, aluminum coated" housing version</i></p> <p>The local display is plugged onto the main electronics module. The electronic connection between the local display and main electronics module is established via a connecting cable.</p> <p>For some work performed on the measuring device (e.g. electrical connection), it is advisable to disconnect the local display from the main electronics module:</p> <ol style="list-style-type: none"> 1. Press in the side latches of the local display. 2. Remove the local display from the main electronics module. Pay attention to the length of the connecting cable when doing so.
---------------	---

Once the work is completed, plug the local display back on.

Remote operation

Via Ethernet-based fieldbus

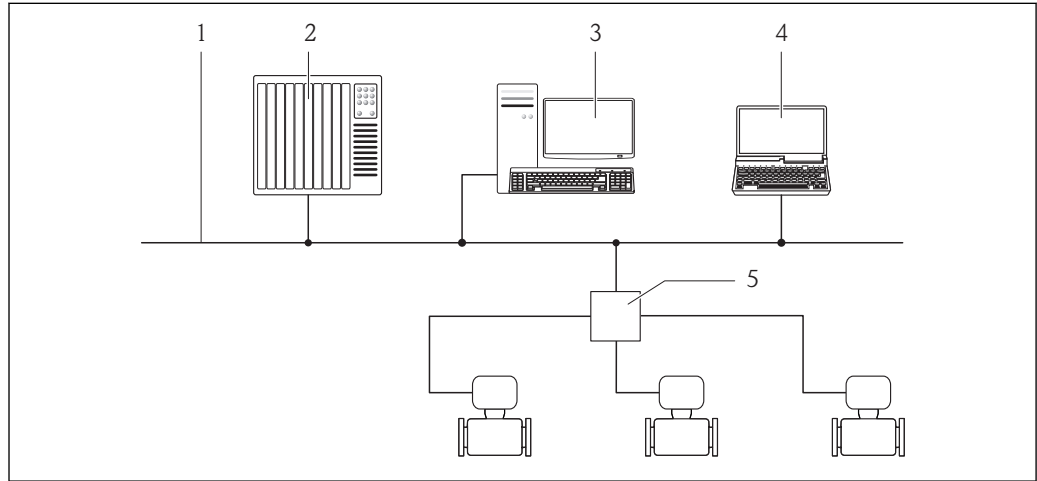

A0016961

- 1 Ethernet network
- 2 Automation system, e.g. "RSLogix" (Rockwell Automation)
- 3 Workstation for measuring device operation: with Add-on Profile Level 3 for "RSLogix 5000" (Rockwell Automation) or with Electronic Data Sheet (EDS)
- 4 Computer with Web browser (e.g. Internet Explorer) for accessing the integrated device Web server or with "FieldCare" operating tool with COM DTM "CDI Communication TCP/IP"
- 5 Ethernet switch

Service interface

Service interface (CDI-RJ45)

EtherNet/IP

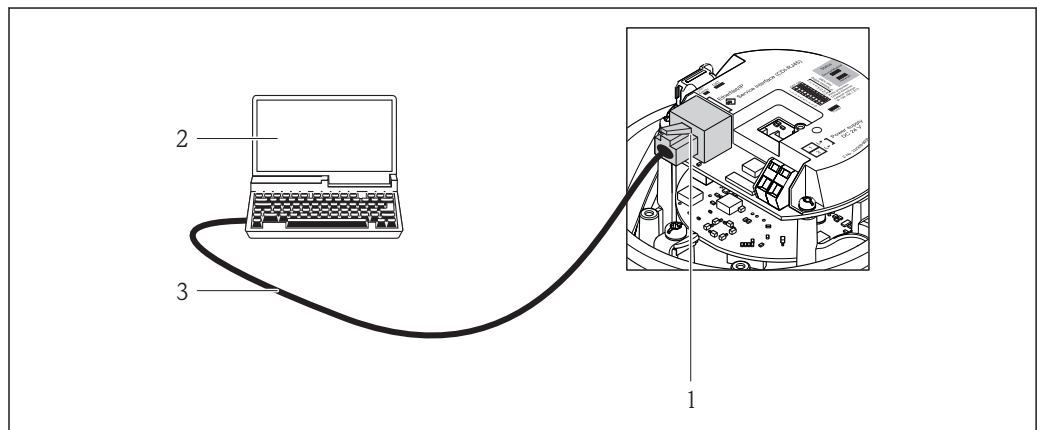

A0016940

18 Connection for order code for "Output", option N: EtherNet/IP

- 1 Service interface (CDI -RJ45) and EtherNet/IP interface of the measuring device with access to the integrated Web server
- 2 Computer with Web browser (e.g. Internet Explorer) for accessing the integrated device Web server or with "FieldCare" operating tool with COM DTM "CDI Communication TCP/IP"
- 3 Standard Ethernet connecting cable with RJ45 plug

Languages	<p>Can be operated in the following languages:</p> <ul style="list-style-type: none"> ■ Via "FieldCare" operating tool: English, German, French, Spanish, Italian, Chinese, Japanese ■ Via Web browser English, German, French, Spanish, Italian, Dutch, Portuguese, Polish, Russian, Turkish, Chinese, Japanese, Bahasa (Indonesian), Vietnamese, Czech
-----------	--

16.12 Certificates and approvals

CE mark	<p>The measuring system is in conformity with the statutory requirements of the applicable EC Directives. These are listed in the corresponding EC Declaration of Conformity along with the standards applied.</p> <p>Endress+Hauser confirms successful testing of the device by affixing to it the CE mark.</p>
C-Tick symbol	<p>The measuring system meets the EMC requirements of the "Australian Communications and Media Authority (ACMA)".</p>
Ex approval	<p>The devices are certified for use in hazardous areas and the relevant safety instructions are provided in the separate "Safety Instructions" (XA) document. Reference is made to this document on the nameplate.</p>
EtherNet/IP certification	<p>The measuring device is certified and registered by the ODVA (Open Device Vendor Association). The measuring system meets all the requirements of the following specifications:</p> <ul style="list-style-type: none"> ■ Certified in accordance with the ODVA Conformance Test ■ EtherNet/IP Performance Test ■ EtherNet/IP PlugFest compliance ■ The device can also be operated with certified devices of other manufacturers (interoperability)
Pressure Equipment Directive	<ul style="list-style-type: none"> ■ With the PED/G1/x (x = category) marking on the sensor nameplate, Endress+Hauser confirms compliance with the "Essential Safety Requirements" specified in Annex I of the Pressure Equipment Directive 97/23/EC. ■ Devices not bearing this marking (PED) are designed and manufactured according to good engineering practice. They meet the requirements of Art.3 Section 3 of the Pressure Equipment Directive 97/23/EC. The range of application is indicated in tables 6 to 9 in Annex II of the Pressure Equipment Directive.
Other standards and guidelines	<ul style="list-style-type: none"> ■ EN 60529 Degrees of protection provided by enclosures (IP code) ■ EN 61010-1 Safety requirements for electrical equipment for measurement, control and laboratory use ■ IEC/EN 61326 Emission in accordance with Class A requirements. Electromagnetic compatibility (EMC requirements). ■ NAMUR NE 21 Electromagnetic compatibility (EMC) of industrial process and laboratory control equipment ■ NAMUR NE 32 Data retention in the event of a power failure in field and control instruments with microprocessors

- NAMUR NE 43
Standardization of the signal level for the breakdown information of digital transmitters with analog output signal.
- NAMUR NE 53
Software of field devices and signal-processing devices with digital electronics
- NAMUR NE 105
Specifications for integrating fieldbus devices in engineering tools for field devices
- NAMUR NE 107
Self-monitoring and diagnosis of field devices
- NAMUR NE 131
Requirements for field devices for standard applications

16.13 Application packages

Many different application packages are available to enhance the functionality of the device. Such packages might be needed to address safety aspects or specific application requirements.

The application packages can be ordered from Endress+Hauser either directly with the device or subsequently. Detailed information on the order code in question is available from your local Endress+Hauser sales center or on the product page of the Endress+Hauser website: www.endress.com.



Cleaning

Package	Description
Electrode cleaning circuit (ECC)	The electrode cleaning circuit (ECC) function has been developed to have a solution for applications where magnetite (Fe ₃ O ₄) deposits frequently occur (e.g. hot water). Since magnetite is highly conductive this build up leads to measuring errors and ultimately to the loss of signal. The application package is designed to AVOID build up of highly conductive matter and thin layers (typical of magnetite).

Heartbeat Technology

Package	Description
Heartbeat Verification +Monitoring	<p>Heartbeat Monitoring: Continuously supplies monitoring data, which are characteristic of the measuring principle, for an external condition monitoring system. This makes it possible to:</p> <ul style="list-style-type: none"> ■ Draw conclusions - using these data and other information - about the impact the measuring application has on the measuring performance over time. ■ Schedule servicing in time. ■ Monitor the product quality, e.g. gas pockets. <p>Heartbeat Verification: Makes it possible to check the device functionality on demand when the device is installed, without having to interrupt the process.</p> <ul style="list-style-type: none"> ■ Access via onsite operation or other operating interfaces, such as FieldCare for instance. ■ Documentation of device functionality within the framework of manufacturer specifications, for proof testing for instance. ■ End-to-end, traceable documentation of the verification results, including report. ■ Makes it possible to extend calibration intervals in accordance with operator's risk assessment.

16.14 Accessories

 Overview of accessories available for order (→  83)

16.15 Supplementary documentation

-  For an overview of the scope of the associated Technical Documentation, refer to the following:
- The CD-ROM provided for the device (depending on the device version, the CD-ROM might not be part of the delivery!)
 - The *W@M Device Viewer* : Enter the serial number from the nameplate (www.endress.com/deviceviewer)
 - The *Endress+Hauser Operations App*: Enter the serial number from the nameplate or scan the 2-D matrix code (QR code) on the nameplate.

Standard documentation

Brief Operating Instructions

Measuring device	Documentation code
Promag P 100	KA01143D

Technical Information

Measuring device	Documentation code
Promag P 100	TI01102D

Supplementary device-dependent documentation



Safety Instructions

Contents	Documentation code
ATEX/IECEX Ex nA	XA01090D

Special Documentation

Contents	Documentation code
Information on the Pressure Equipment Directive	SD01056D
Heartbeat Technology	SD01149D

Installation Instructions

Contents	Documentation code
Installation Instructions for spare part sets	 Overview of accessories available for order (→  83)

17 Appendix

17.1 Overview of the operating menu

The following tables provide an overview of the entire operating menu structure with menus and parameters. The page reference indicates where a description of the parameter can be found in the manual.

* = The submenu only appears if it has been additionally ordered ("Technical Information", Section "Application packages").





























17.1.1 Main menu

Main menu	→	Display language	(→ 59)
		Operation	(→ 104)
		Setup	(→ 105)
		Diagnostics	(→ 107)
		Expert	(→ 109)





















17.1.2 "Operation" menu

Operation	→		
Display language			(→ 59)
Web server language			
Access status display			
Access status tooling			
Locking status			(→ 61)
Display	→		(→ 50)
Format display			(→ 51)
Contrast display			
Backlight			(→ 59)
Display interval			(→ 59)
Totalizer handling	→		(→ 65)
Control Totalizer 1 to 3			(→ 66)
Preset value 1 to 3			(→ 66)
Reset all totalizers			(→ 65)

17.1.3 "Setup" menu







Setup →	(→  48)
Device tag	(→  49)
System units →	(→  49)
Volume flow unit	(→  49)
Volume unit	(→  49)
Conductivity unit	(→  50)
Temperature unit	(→  50)
Mass flow unit	(→  50)
Mass unit	(→  50)
Density unit	(→  50)
Corrected volume flow unit	(→  50)
Corrected volume unit	(→  50)
Communication →	(→  52)
MAC address	(→  52)
Default network settings	(→  52)
DHCP client	(→  52)
IP address	(→  52)
Subnet mask	(→  53)
Default gateway	(→  53)
Display →	(→  50)
Format display	(→  51)
Value 1 display	(→  51)
0% bargraph value 1	(→  51)
100% bargraph value 1	(→  51)
Value 2 display	(→  52)
Value 3 display	(→  52)
0% bargraph value 3	(→  52)
100% bargraph value 3	(→  52)
Value 4 display	(→  52)
Low flow cut off →	























Assign process variable		(→ 53)
On value low flow cutoff		(→ 53)
Off value low flow cutoff		(→ 53)
Pressure shock suppression		(→ 53)
Empty pipe detection	→	(→ 54)
Empty pipe detection		(→ 54)
New adjustment		(→ 54)
Progress		(→ 54)
Switch point empty pipe detection		(→ 54)
Response time part. filled pipe detect.		(→ 54)
Advanced setup	→	(→ 55)
Enter access code		(→ 61)
	Sensor adjustment	→ (→ 55)
	Installation direction	(→ 55)
	Totalizer 1 to 3	→ (→ 55)
	Assign process variable	(→ 56)
	Unit totalizer	(→ 56)
	Totalizer operation mode	(→ 56)
	Failure mode	(→ 56)
	Display	→ (→ 57)
	Format display	(→ 51)
	Value 1 display	(→ 51)
	0% bargraph value 1	(→ 51)
	100% bargraph value 1	(→ 51)
	Decimal places 1	(→ 58)
	Value 2 display	(→ 52)
	Decimal places 2	(→ 58)
	Value 3 display	(→ 52)
	0% bargraph value 3	(→ 52)
	100% bargraph value 3	(→ 52)

Decimal places 3		(→  58)
Value 4 display		(→  52)
Decimal places 4		(→  58)
Display language		(→  59)
Display interval		(→  59)
Display damping		(→  59)
Header		(→  59)
Header text		(→  59)
Separator		(→  59)
Backlight		(→  59)
Electrode cleaning circuit ¹⁾	→	(→  59)
Electrode cleaning circuit		(→  60)
ECC duration		(→  60)
ECC recovery time		(→  60)
ECC cleaning cycle		(→  60)
ECC Polarity		(→  60)
Administration	→	
		Define access code → (→  61)
		Define access code (→  61)
		Confirm access code (→  61)
Device reset		(→  77)

1) Order code for "Application package", option EC "ECC electrode cleaning"

17.1.4 "Diagnostics" menu

Diagnostics	→	(→  67)
Actual diagnostics		(→  75)
Previous diagnostics		(→  75)
Operating time from restart		(→  75)
Operating time		(→  0)
		Diagnostic list → (→  75)
		Diagnostics 1 to 5 (→  75)

Event logbook	→		(→  75)
Filter options			(→  76)
Device information	→		(→  77)
Device tag			(→  78)
Serial number			(→  78)
Firmware version			(→  78)
Device name			(→  78)
Order code			(→  78)
Extended order code 1 to 3			(→  78)
ENP version			(→  78)
IP address			(→  52)
Subnet mask			(→  53)
Default gateway			(→  53)
Measured values	→		
		Process variables	→ (→  64)
		Volume flow	(→  64)
		Mass flow	(→  64)
		Conductivity	(→  64)
		Corrected volume flow	(→  64)
		Temperature	(→  64)
		Totalizer 1 to 3	→ (→  64)
		Totalizer value 1 to 3	(→  65)
		Totalizer overflow 1 to 3	(→  65)
Heartbeat¹⁾	→		(→  103)
		Performing verification	→
		Year	
		Month	
		Day	
		Hour	
		AM/PM	
		Minute	

	External device information	
	Start verification	
	Progress	
	Status	
	Overall result	
	Verification results →	
	Date/time	
	Verification ID	
	Operating time	
	Overall result	
	Sensor	
	Sensor electronic module	
	I/O module	
	Monitoring results →	
	Noise	
	Coil current shot time	
	Reference electrode potential against PE	
Simulation →		(→ 60)
	Assign simulation process variable	(→ 60)
	Value process variable	(→ 60)
	Simulation device alarm	(→ 61)
	Simulation diagnostic event	(→ 61)

1) Order code for "Application package", option EB "Heartbeat Verification + Monitoring", see the Special Documentation for the device

17.1.5 "Expert" menu

The following tables provide an overview of the **Expert** menu (→ 109) with its submenus and parameters. The direct access code to the parameter is given in brackets. The page reference indicates where a description of the parameter can be found in the manual.







Overview "Expert" menu

Expert →	(→ 38)
-----------------	--------

Direct access (0106)	
Locking status (0004)	(→ 📖 63)
Access status display (0091)	
Access status tooling (0005)	(→ 📖 61)
Enter access code (0092)	
	System (→ 📖 110)
	Sensor (→ 📖 112)
	Communication (→ 📖 115)
	Application (→ 📖 115)
	Diagnostics (→ 📖 116)

"System" submenu

System →	
Display →	(→ 📖 57)
Display language (0104)	(→ 📖 59)
Format display (0098)	(→ 📖 51)
Value 1 display (0107)	(→ 📖 51)
0% bargraph value 1 (0123)	(→ 📖 51)
100% bargraph value 1 (0125)	(→ 📖 51)
Decimal places 1 (0095)	(→ 📖 58)
Value 2 display (0108)	(→ 📖 52)
Decimal places 2 (0117)	(→ 📖 58)
Value 3 display (0110)	(→ 📖 52)
0% bargraph value 3 (0124)	(→ 📖 52)
100% bargraph value 3 (0126)	(→ 📖 52)
Value 4 display (0109)	(→ 📖 52)
Decimal places 4 (0119)	(→ 📖 58)
Display interval (0096)	(→ 📖 59)
Display damping (0094)	(→ 📖 59)

Header (0097)		(→  59)
Header text (0112)		(→  59)
Separator (0101)		(→  59)
Contrast display (0105)		
Backlight (0111)		(→  59)
Access status display (0091)		
Diagnostic handling	→	(→  67)
Alarm delay (0651)		
	Diagnostic behavior	→
	Assign behavior of diagnostic no. 531 (0741)	
	Assign behavior of diagnostic no. 832 (0681)	
	Assign behavior of diagnostic no. 833 (0682)	
	Assign behavior of diagnostic no. 834 (0700)	
	Assign behavior of diagnostic no. 835 (0702)	
	Assign behavior of diagnostic no. 862 (0745)	
	Assign behavior of diagnostic no. 937 (0743)	
	Assign behavior of diagnostic no. 302 (0739)	
	Administration	→
	Define access code (0093)	(→  61)
Device reset (0000)		(→  77)
Activate SW option (0029)		
Software option overview (0015)		

"Sensor" submenu

Sensor	→		
Measured values	→		(→ 64)
		Process variables	→ (→ 64)
		Volume flow (1847)	(→ 64)
		Mass flow (1838)	(→ 64)
		Conductivity (1850)	(→ 64)
		Corrected volume flow (1851)	(→ 64)
		Temperature (1853)	(→ 64)
		Totalizer 1 to 3	→ (→ 64)
		Totalizer value 1 to 3 (0911-1 to 3)	(→ 65)
		Totalizer overflow 1 to 3 (0910-1 to 3)	(→ 65)
		System units	→ (→ 49)
		Volume flow unit (0553)	(→ 49)
		Volume unit (0563)	(→ 49)
		Conductivity unit (0582)	(→ 50)
		Temperature unit (0557)	(→ 50)
		Mass flow unit (0554)	(→ 50)
		Mass unit (0574)	(→ 50)
		Density unit (0555)	(→ 50)
		Corrected volume flow unit (0558)	(→ 50)
		Corrected volume unit (0575)	(→ 50)
		Date/time format (2812)	
		User-specific units	→
		User volume text (0567)	
		User volume offset (0569)	
		User volume factor	
		User mass text	
		User mass offset (0562)	

	User mass factor (0561)	
Process parameters	→	(→ 48)
Filter options (6710)		
Flow damping (6661)		
Flow override (1839)		
Conductivity damping (1803)		
Temperature damping (1886)		
Conductivity measurement (6514)		
	Low flow cut off	→
	Assign process variable (1837)	(→ 53)
	On value low flow cutoff (1805)	(→ 53)
	Off value low flow cutoff (1804)	(→ 53)
	Pressure shock suppression (1806)	(→ 53)
	Empty pipe detection	→
	Empty pipe detection (1860)	(→ 54)
	Switch point empty pipe detection (6562)	(→ 54)
	Response time part. filled pipe detect. (1859)	(→ 54)
	New adjustment (6560)	(→ 54)
	Progress (6571)	(→ 54)
	Empty pipe adjust value (6527)	
	Full pipe adjust value (6548)	
	Measured value EPD (6559)	
	Electrode cleaning circuit¹⁾	→ (→ 59)
	Electrode cleaning circuit (6528)	(→ 60)
	ECC duration (6555)	(→ 60)

	ECC recovery time (6556)	(→ 60)
	ECC cleaning cycle (6557)	(→ 60)
	ECC Polarity (6631)	(→ 60)
External compensation →		
Temperature source (6712)		
External temperature (6673)		
Density source (6615)		
External density (6630)		
Fixed density (6623)		
Reference density (1885)		
Sensor adjustment →		
Installation direction (1809)		(→ 55)
Integration time (6533)		
Measuring period (6536)		
	Process variable adjustment →	
	Volume flow offset (1841)	
	Volume flow factor (1846)	
	Mass flow offset (1831)	
	Mass flow factor (1832)	
	Conductivity offset (1848)	
	Conductivity factor (1849)	
	Corrected volume flow offset (1866)	
	Corrected volume flow factor (1867)	
	Temperature offset (1870)	
	Temperature factor (1871)	

Calibration	→
Nominal diameter (2807)	
Calibration factor (6025)	
Zero point (6195)	
Conductivity calibration factor (6718)	



1) Order code for "Application package", option EC "ECC electrode cleaning"

"Communication" submenu













Communication	→	
Configuration	→	(→ ⓘ 52)
Web server language (7221)		
MAC address (7214)		(→ ⓘ 52)
Default network settings (7401)		(→ ⓘ 52)
DHCP client (7212)		(→ ⓘ 52)
IP address (7209)		(→ ⓘ 52)
Subnet mask (7211)		(→ ⓘ 53)
Default gateway (7210)		(→ ⓘ 53)
Web server functionality		
Configurable input assembly	→	
Input assembly position 1 to 20 (7402-1 to 20)		







"Application" submenu

Application	→	
Reset all totalizers (2806)		(→ ⓘ 66)
Totalizer 1 to 3	→	(→ ⓘ 55)
Assign process variable (0914)		(→ ⓘ 56)
Unit totalizer (0915)		(→ ⓘ 56)
Totalizer operation mode		(→ ⓘ 56)

Control Totalizer 1 to 3 (0912-1 to 3)		(→  66)
Preset value 1 to 3 (0913-1 to 3)		(→  66)
Failure mode (0901)		(→  56)
Concentration	→	
Concentration unit		
User concentration text		
User concentration factor		
User concentration offset		
A 0		
A 1 to 4		
B 1 to 3		

"Diagnostics" submenu

Diagnostics	→	(→  67)
Actual diagnostics (0691)		(→  75)
Timestamp (0667)		
Previous diagnostics (0690)		(→  75)
Timestamp (0672)		
Operating time from restart (0653)		(→  75)
Operating time (0652)		(→  75)
Diagnostic list	→	(→  75)
Diagnostics 1 to 5 (0692-1 to 5)		(→  75)
Timestamp 1 to 5 (0683-1 to 5)		
Event logbook	→	(→  75)
Filter options (0705)		(→  76)
Device information	→	(→  77)
Device tag (0011)		(→  78)
Serial number (0009)		(→  78)

Firmware version (0010)		(→  78)
Device name (0013)		(→  78)
Order code (0008)		(→  78)
Extended order code 1 to 3 (0023-1 to 3)		(→  78)
Configuration counter (0233)		
ENP version (0012)		(→  78)
Min/max values	→	
Reset min/max values (6151)		
	Main electronic temperature	→
	Minimum value (6547)	
	Maximum value (6545)	
	Temperature	→
	Minimum value (6030)	
	Maximum value (6029)	
Heartbeat ¹⁾	→	(→  103)
	Heartbeat base settings	→
	Plant operator (2754)	
	Location (2751)	
	Performing verification	→
	Year (2846)	
	Month (2845)	
	Day (2842)	
	Hour (2843)	
	AM/PM (2813)	
	Minute (2844)	
	External device information (12101)	
	Start verification (12127)	
	Progress (2808)	
	Status (12153)	

	Overall result (12149)	
	Verification results	→
	Date/time (12142)	
	Verification ID (12141)	
	Operating time (12126)	
	Overall result (12149)	
	Sensor (12152)	
	Sensor electronic module (12151)	
	I/O module (12145)	
	Monitoring results	→
	Noise (12158)	
	Coil current shot time (12150)	
	Reference electrode potential against PE (12155)	
Simulation		→ (→ 60)
	Assign simulation process variable (1810)	→ (→ 60)
	Value process variable (1811)	→ (→ 60)
	Simulation device alarm (0654)	→ (→ 61)
	Simulation diagnostic event (0737)	→ (→ 61)

1) Order code for "Application package", option EB "Heartbeat Verification + Monitoring", see the Special Documentation for the device

Index

A

- Adapters 21
- Adapting the diagnostic behavior 72
- Ambient temperature range 19
- Application 8, 85
- Applicator 85
- Approvals 101

C

- C-Tick symbol 101
- Cable entries
 - Technical data 91
- Cable entry
 - Degree of protection 34
- CE mark 9, 101
- Certificates 101
- Checklist
 - Post-connection check 35
 - Post-installation check 26
- Cleaning
 - Exterior cleaning 80
 - Interior cleaning 80
- Commissioning 48
 - Advanced settings 55
 - Configuring the measuring device 48
- Conductivity 93
- Connecting cable 27
- Connecting the measuring device 29
- Connection
 - see Electrical connection
- Connection examples, potential equalization 31
- Connection preparations 29
- Connection tools 27
- Current consumption 91

D

- Declaration of Conformity 9
- Define access code 61
- Degree of protection 34, 93
- Design
 - Measuring device 11
- Designated use 8
- Device components 11
- Device description files 46
- Device documentation
 - Supplementary documentation 7
- Device locking, status 63
- Device name
 - Sensor 14
 - Transmitter 13
- Device repair 81
- Device revision 46
- Device type ID 46
- Diagnostic information
 - Communication interface 71
 - Design, description 70, 71

- FieldCare 70
- Light emitting diodes 68
- Overview 72
- Remedial measures 72
- Web browser 69
- Diagnostic list 75
- DIP switch
 - see Write protection switch
- Disabling write protection 61
- Display
 - Current diagnostic event 74
 - Previous diagnostic event 74
- Display values
 - For locking status 63
- Disposal 81
- Document
 - Function 5
 - Symbols used 5
- Document function 5
- Down pipe 17

E

- ECC 59
- Electrical connection
 - Degree of protection 34
 - Measuring device 27
 - Operating tools
 - Via Ethernet network 43, 100
 - Via service interface (CDI-RJ45) 43
 - RSLogix 5000 43, 100
 - Web server 43
- Electromagnetic compatibility 93
- Enabling write protection 61
- Endress+Hauser services
 - Maintenance 80
 - Repair 81
- Environment
 - Ambient temperature range 19
 - Mechanical load 93
 - Shock resistance 93
 - Storage temperature 92
 - Vibration resistance 93
- Error messages
 - see Diagnostic messages
- EtherNet/IP
 - Diagnostic information 71
- EtherNet/IP certification 101
- Event history 75
- Events list 75
- Ex approval 101
- Extended order code
 - Sensor 14
 - Transmitter 13
- Exterior cleaning 80

F

Field of application	
Residual risks	9
FieldCare	44
Device description file	46
Establishing a connection	44
Function	44
User interface	45
Filtering the event logbook	76
Firmware	
Release date	46
Version	46
Firmware history	78
Fitted electrodes	99
Fix assembly	71
Flow direction	18
Flow limit	95
Function check	48
Functions	
see Parameter	

G

Galvanic isolation	88
--------------------	----

H

Hardware write protection	61
---------------------------	----

I

I/O electronics module	11, 29
Identifying the measuring device	12
Incoming acceptance	12
Information on the document	5
Inlet runs	19
Input	85
Inspection	
Installation	26
Received goods	12
Inspection check	
Connection	35
Installation conditions	
Adapters	21
Down pipe	17
Inlet and outlet runs	19
Mounting location	17
Orientation	18
Partially filled pipe	18
System pressure	20
Vibrations	20
Installation dimensions	19
Interior cleaning	80

L

Languages, operation options	101
Low flow cut off	88

M

Main electronics module	11
Maintenance tasks	80
Replacing seals	80

Manufacturer ID	46
Manufacturing date	13, 14
Materials	97
Maximum measured error	91
Measured variables	
Calculated	85
Measured	85
see Process variables	
Measuring and test equipment	80
Measuring device	
Configuration	48
Conversion	81
Design	11
Disposal	82
Integrating via HART protocol	46
Mounting the sensor	22
Mounting the ground cable/ground disks	22
Mounting the seals	22
Screw tightening torques	23
Preparing for electrical connection	29
Preparing for mounting	22
Removing	81
Repair	81
Measuring principle	85
Measuring range	85
Measuring system	85
Measuring tube specification	96
Mechanical load	93
Media	8
Medium temperature range	93
menu	
Diagnostics	74
Operation	63
Setup	48
Menus	
For measuring device configuration	48
For specific settings	55
Mounting	17
Mounting dimensions	
see Installation dimensions	
Mounting location	17
Mounting preparations	22
Mounting requirements	
Installation dimensions	19
Mounting tools	21

N

Nameplate	
Sensor	14
Transmitter	13

O

Operable flow range	86
Operating menu	
Menus, submenus	37
Overview of menus with parameters	104
Structure	37
Submenus and user roles	38
Operating philosophy	38

- Operation 63
- Operation options 36
- Operational safety 9
- Order code 13, 14
- Orientation (vertical, horizontal) 18
- Outlet runs 19
- Output 87
- Output signal 87
- Overview
 - Operating menu 104
- P**
- Packaging disposal 17
- Parameter settings
 - Communication (submenu) 52
 - Device information (submenu) 77
 - Diagnostics (menu) 74
 - Display (submenu) 57
 - Display (wizard) 50
 - Electrode cleaning circuit (submenu) 59
 - Empty pipe detection (wizard) 54
 - Low flow cut off (wizard) 53
 - Operation (submenu) 65
 - Process variables (submenu) 64
 - Sensor adjustment (submenu) 55
 - Setup (menu) 48
 - Simulation (submenu) 60
 - System units (submenu) 49
 - Totalizer (submenu) 64
 - Totalizer 1 to 3 (submenu) 55
 - Web server (submenu) 42
- Partially filled pipe 18
- Performance characteristics 91
- Post-connection check (checklist) 35
- Post-installation check 48
- Post-installation check (checklist) 26
- Potential equalization 31, 91
- Power consumption 91
- Power supply failure 91
- Pressure Equipment Directive 101
- Pressure loss 95
- Pressure tightness 94
- Pressure-temperature ratings 94
- Process conditions
 - Conductivity 93
 - Flow limit 95
 - Medium temperature 93
 - Pressure loss 95
 - Pressure tightness 94
- Process connections 99
- Product safety 9
- Protecting parameter settings 61
- R**
- Reading measured values 64
- Reading out diagnostic information, EtherNet/IP 71
- Recalibration 80
- Reference operating conditions 91
- Registered trademarks 7
- Remote operation 100
- Repair 81
 - Notes 81
- Repair of a device 81
- Repeatability 92
- Replacement
 - Device components 81
- Replacing seals 80
- Requirements for personnel 8
- Returning devices 81
- S**
- Safety 8
- Screw tightening torques 23
- Sensor
 - Mounting 22
- Serial number 13, 14
- Service interface (CDI-RJ45) 100
- Settings
 - Adapting the measuring device to the process conditions 65
 - Advanced display configurations 57
 - Communication interface 52
 - Device reset 77
 - Device tag 48
 - Electrode cleaning circuit (ECC) 59
 - Empty pipe detection (EPD) 54
 - Local display 50
 - Low flow cut off 53
 - Resetting the totalizer 65
 - Sensor adjustment 55
 - Simulation 60
 - System units 49
 - Totalizer 55
 - Totalizer reset 65
- Shock resistance 93
- Signal on alarm 87
- Software release 46
- Spare part 81
- Spare parts 81
- Special connection instructions 33
- Standards and guidelines 101
- Status signals 69
- Storage conditions 16
- Storage temperature 16
- Storage temperature range 92
- Structure
 - Operating menu 37
- submenu
 - Communication 48, 52
 - Device information 77
 - Display 57
 - Electrode cleaning circuit 59
 - Operation 65
 - Process variables 64
 - Sensor adjustment 55
 - Simulation 60
 - System units 49
 - Totalizer 64

Totalizer 1 to 3	55	Empty pipe detection	54
Web server	42	Low flow cut off	53
Submenu		Workplace safety	9
Define access code	61	Write protection	
Events list	75	Via access code	61
Overview	38	Via write protection switch	61
Process variables	64	Write protection switch	61
Supplementary documentation	103		
Supply voltage	90		
Surface roughness	99		
System design			
Measuring system	85		
see Measuring device design			
System file			
Release date	46		
Source	46		
Version	46		
System integration	46		
System pressure	20		
T			
Technical data, overview	85		
Temperature measurement response time	92		
Temperature range			
Storage temperature	16		
Terminal assignment	28, 29		
Terminals	91		
Tools			
Electrical connection	27		
For mounting	21		
Transport	16		
Transmitter			
Connecting the signal cables	29		
Turning the display module	25		
Transporting the measuring device	16		
Troubleshooting			
General	67		
Turning the display module	25		
U			
Use of the measuring device			
Borderline cases	8		
Incorrect use	8		
see Designated use			
User roles	38		
V			
Version data for the device	46		
Vibration resistance	93		
Vibrations	20		
W			
W@M	80, 81		
W@M Device Viewer	12, 81		
Weight			
Compact version	95		
Transport (notes)	16		
wizard			
Define access code	61		
Display	50		

www.addresses.endress.com
