

Brief Operating Instructions

Proline Cubemass C 100

Coriolis flowmeter

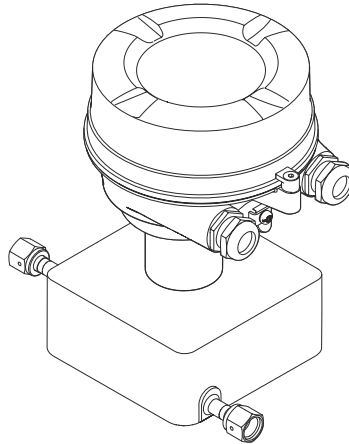

These Instructions are Brief Operating Instructions; they are not a substitute for the Operating Instructions pertaining to the device.

Detailed information about the device can be found in the Operating Instructions and the other documentation:

- On the CD-ROM supplied (is not included in the delivery for all device versions).
- Available for all device versions via:
 - Internet: www.endress.com/deviceviewer
 - Smart phone/tablet: *Endress+Hauser Operations App*

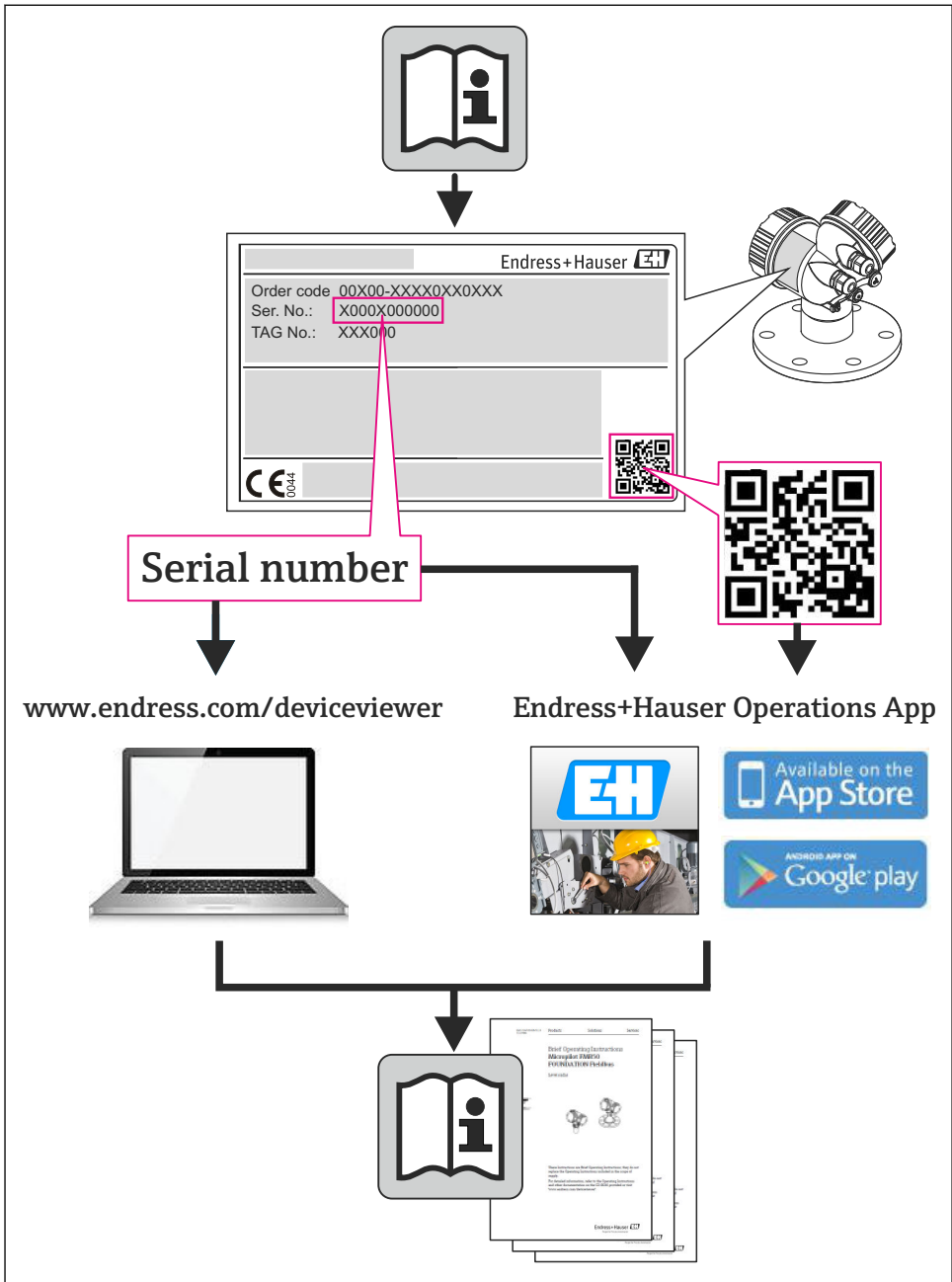





Table of contents

1	Document information	4
1.1	Symbols used	4
2	Basic safety instructions	5
2.1	Requirements for the personnel	5
2.2	Designated use	6
2.3	Workplace safety	7
2.4	Operational safety	7
2.5	Product safety	7
2.6	IT security	7
3	Product description	7
4	Incoming acceptance and product identification	8
4.1	Incoming acceptance	8
4.2	Product identification	9
5	Storage and transport	9
5.1	Storage conditions	9
5.2	Transporting the product	9
6	Installation	11
6.1	Installation conditions	11
6.2	Mounting the measuring device	19
6.3	Post-installation check	22
7	Electrical connection	23
7.1	Connection conditions	23
7.2	Connecting the measuring device	36
7.3	Hardware settings	38
7.4	Ensuring the degree of protection	43
7.5	Post-connection check	44
8	Operation options	45
8.1	Structure and function of the operating menu	45
8.2	Access to the operating menu via the Web browser	45
8.3	Access to the operating menu via the operating tool	49
9	System integration	49
9.1	Cyclic data transmission	49
10	Commissioning	54
10.1	Function check	54
10.2	Establishing a connection via FieldCare	54
10.3	Configuring the device address via software	54
10.4	Configuring the measuring device	55
10.5	Protecting settings from unauthorized access	55
11	Diagnostic information	56







1 Document information

1.1 Symbols used





1.1.1 Safety symbols

Symbol	Meaning
	DANGER! This symbol alerts you to a dangerous situation. Failure to avoid this situation will result in serious or fatal injury.
	WARNING! This symbol alerts you to a dangerous situation. Failure to avoid this situation can result in serious or fatal injury.
	CAUTION! This symbol alerts you to a dangerous situation. Failure to avoid this situation can result in minor or medium injury.
	NOTE! This symbol contains information on procedures and other facts which do not result in personal injury.









1.1.2 Electrical symbols

Symbol	Meaning	Symbol	Meaning
	Direct current		Alternating current
	Direct current and alternating current		Ground connection A grounded terminal which, as far as the operator is concerned, is grounded via a grounding system.
	Protective ground connection A terminal which must be connected to ground prior to establishing any other connections.		Equipotential connection A connection that has to be connected to the plant grounding system: This may be a potential equalization line or a star grounding system depending on national or company codes of practice.



1.1.3 Tool symbols

Symbol	Meaning	Symbol	Meaning
	Torx screwdriver		Flat blade screwdriver
	Phillips head screwdriver		Allen key
	Open-ended wrench		

1.1.4 Symbols for certain types of information

Symbol	Meaning	Symbol	Meaning
	Permitted Procedures, processes or actions that are permitted.		Preferred Procedures, processes or actions that are preferred.
	Forbidden Procedures, processes or actions that are forbidden.		Tip Indicates additional information.
	Reference to documentation		Reference to page
	Reference to graphic	1. 2. 3. ...	Series of steps
	Result of a sequence of actions		Visual inspection

1.1.5 Symbols in graphics

Symbol	Meaning	Symbol	Meaning
1, 2, 3, ...	Item numbers	1. 2. 3. ...	Series of steps
A, B, C, ...	Views	A-A, B-B, C-C, ...	Sections
	Hazardous area		Safe area (non-hazardous area)
	Flow direction		

2 Basic safety instructions

2.1 Requirements for the personnel

The personnel must fulfill the following requirements for its tasks:

- ▶ Trained, qualified specialists must have a relevant qualification for this specific function and task
- ▶ Are authorized by the plant owner/operator
- ▶ Are familiar with federal/national regulations
- ▶ Before beginning work, the specialist staff must have read and understood the instructions in the Operating Instructions and supplementary documentation as well as in the certificates (depending on the application)
- ▶ Following instructions and basic conditions

2.2 Designated use

Application and media

The measuring device described in these Instructions is intended only for flow measurement of liquids and gases.

Depending on the version ordered, the measuring device can also measure potentially explosive, flammable, poisonous and oxidizing media.

Measuring devices for use in hazardous areas, in hygienic applications or in applications where there is an increased risk due to process pressure, are labeled accordingly on the nameplate.

To ensure that the measuring device remains in proper condition for the operation time:

- ▶ Only use the measuring device in full compliance with the data on the nameplate and the general conditions listed in the Operating Instructions and supplementary documentation.
- ▶ Based on the nameplate, check whether the ordered device is permitted for the intended use in the hazardous area (e.g. explosion protection, pressure vessel safety).
- ▶ Use the measuring device only for media against which the process-wetted materials are adequately resistant.
- ▶ If the measuring device is not operated at atmospheric temperature, compliance with the relevant basic conditions specified in the associated device documentation is absolutely essential.

Incorrect use

Non-designated use can compromise safety. The manufacturer is not liable for damage caused by improper or non-designated use.

WARNING

Danger of breakage of the measuring tube due to corrosive or abrasive fluids.

Housing breakage due to mechanical overload possible!

- ▶ Verify the compatibility of the process fluid with the measuring tube material.
- ▶ Ensure the resistance of all fluid-wetted materials in the process.
- ▶ Observe the specified pressure and temperature range.

Verification for borderline cases:

- ▶ For special fluids and fluids for cleaning, Endress+Hauser is glad to provide assistance in verifying the corrosion resistance of fluid-wetted materials, but does not accept any warranty or liability as minute changes in the temperature, concentration or level of contamination in the process can alter the corrosion resistance properties.

Residual risks

WARNING

Danger of housing breaking due to measuring tube breakage!

- ▶ In the event of a measuring tube breakage for a device version without rupture disk it is possible for the pressure loading capacity of the sensor housing to be exceeded. This can lead to rupture or failure of the sensor housing.

The external surface temperature of the housing can increase by max. 20 K due to the power consumption of the electronic components. Hot process fluids passing through the measuring

device will further increase the surface temperature of the housing. The surface of the sensor, in particular, can reach temperatures which are close to the fluid temperature.

Possible burn hazard due to fluid temperatures!

- ▶ For elevated fluid temperature, ensure protection against contact to prevent burns.

2.3 Workplace safety

For work on and with the device:

- ▶ Wear the required personal protective equipment according to federal/national regulations.

For welding work on the piping:

- ▶ Do not ground the welding unit via the measuring device.

If working on and with the device with wet hands:

- ▶ It is recommended to wear gloves on account of the higher risk of electric shock.

2.4 Operational safety

Risk of injury.

- ▶ Operate the device in proper technical condition and fail-safe condition only.
- ▶ The operator is responsible for interference-free operation of the device.

2.5 Product safety

This measuring device is designed in accordance with good engineering practice to meet state-of-the-art safety requirements, has been tested, and left the factory in a condition in which it is safe to operate.

It meets general safety standards and legal requirements. It also complies with the EC directives listed in the device-specific EC Declaration of Conformity. Endress+Hauser confirms this by affixing the CE mark to the device.

2.6 IT security

We only provide a warranty if the device is installed and used as described in the Operating Instructions. The device is equipped with security mechanisms to protect it against any inadvertent changes to the device settings.

IT security measures in line with operators' security standards and designed to provide additional protection for the device and device data transfer must be implemented by the operators themselves.

3 Product description

One device version is available: compact version - transmitter and sensor form a mechanical unit.

 For detailed information on the product description, see the Operating Instructions for the device.

4 Incoming acceptance and product identification

4.1 Incoming acceptance

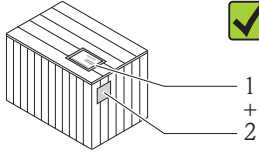
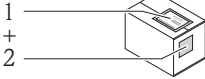

Are the order codes on the delivery note (1) and the product sticker (2) identical?

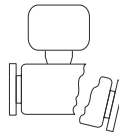
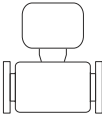
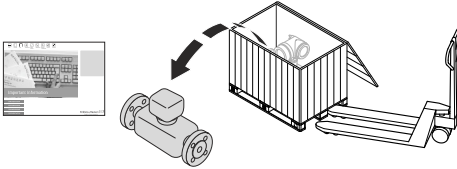

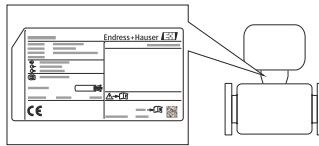

Are the goods undamaged?



Do the nameplate data match the ordering information on the delivery note?



Is the CD-ROM with the Technical Documentation (depends on device version) and documents present?

-  If one of the conditions is not satisfied, contact your Endress+Hauser Sales Center.
-  Depending on the device version, the CD-ROM might not be part of the delivery! The Technical Documentation is available via the Internet or via the *Endress+Hauser Operations App*.

4.2 Product identification

The following options are available for identification of the measuring device:

- Nameplate specifications
- Order code with breakdown of the device features on the delivery note
- Enter serial numbers from nameplates in *W@M Device Viewer* (www.endress.com/deviceviewer): All information about the measuring device is displayed.
- Enter the serial number from the nameplates into the *Endress+Hauser Operations App* or scan the 2-D matrix code (QR code) on the nameplate with the *Endress+Hauser Operations App*: all the information for the measuring device is displayed.

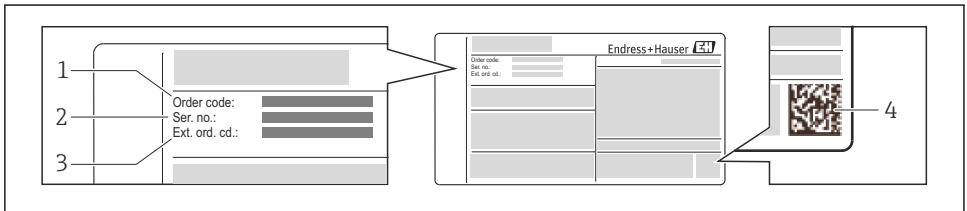

A0021952

1 Example of a nameplate

- 1 Order code
- 2 Serial number (Ser. no.)
- 3 Extended order code (Ext. ord. cd.)
- 4 2-D matrix code (QR code)

 For detailed information on the breakdown of the specifications on the nameplate, see the Operating Instructions for the device .

5 Storage and transport

5.1 Storage conditions

Observe the following notes for storage:

- Store in original packaging.
- Do not remove protective covers or protective caps installed on process connections.
- Protect from direct sunlight.
- Storage temperature: -40 to +80 °C (-40 to +176 °F),
Order Code "Test, Certificate", Option JM: -50 to +60 °C (-58 to +140 °F),
- Store in a dry and dust-free place.
- Do not store outdoors.

5.2 Transporting the product

Transport the measuring device to the measuring point in the original packaging.

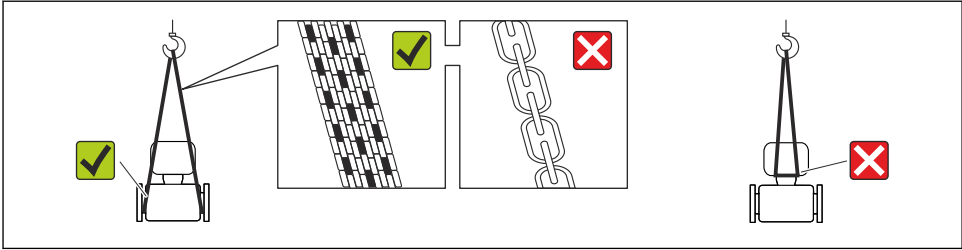

i Do not remove protective covers or caps installed on process connections. They prevent mechanical damage to the sealing surfaces and contamination in the measuring tube.

5.2.1 Measuring devices without lifting lugs

⚠ WARNING

Center of gravity of the measuring device is higher than the suspension points of the webbing slings.

Risk of injury if the measuring device slips.

- ▶ Secure the measuring device against slipping or turning.
- ▶ Observe the weight specified on the packaging (stick-on label).

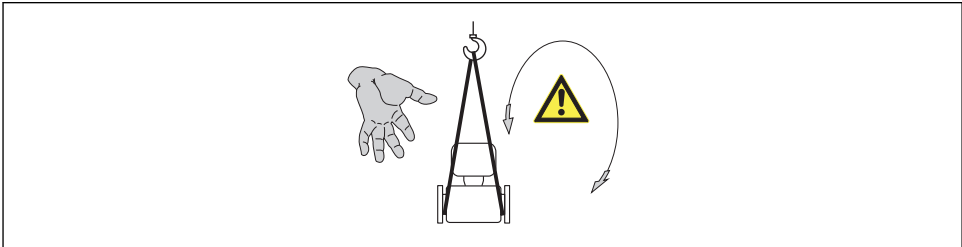

5.2.2 Measuring devices with lifting lugs

⚠ CAUTION

Special transportation instructions for devices with lifting lugs

- ▶ Only use the lifting lugs fitted on the device or flanges to transport the device.
- ▶ The device must always be secured at two lifting lugs at least.

5.2.3 Transporting with a fork lift

If transporting in wood crates, the floor structure enables the crates to be lifted lengthwise or at both sides using a forklift.

6 Installation

6.1 Installation conditions

No special measures such as supports are necessary. External forces are absorbed by the construction of the device.

6.1.1 Mounting position

Mounting location

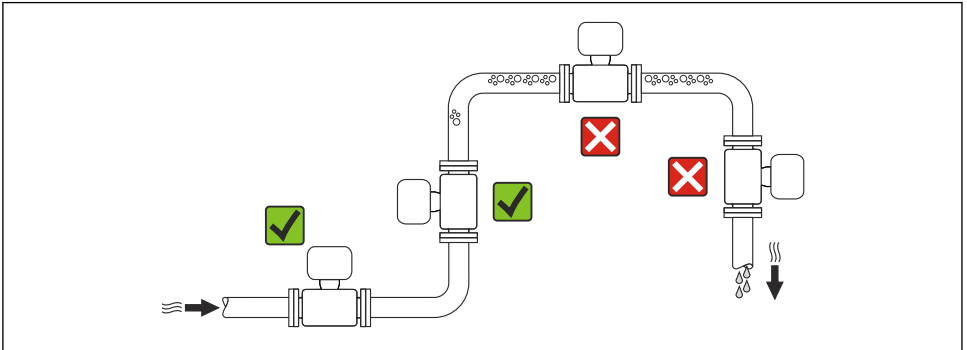

A0023344

Installation in down pipes

However, the following installation suggestion allows for installation in an open vertical pipeline. Pipe restrictions or the use of an orifice with a smaller cross-section than the nominal diameter prevent the sensor running empty while measurement is in progress.

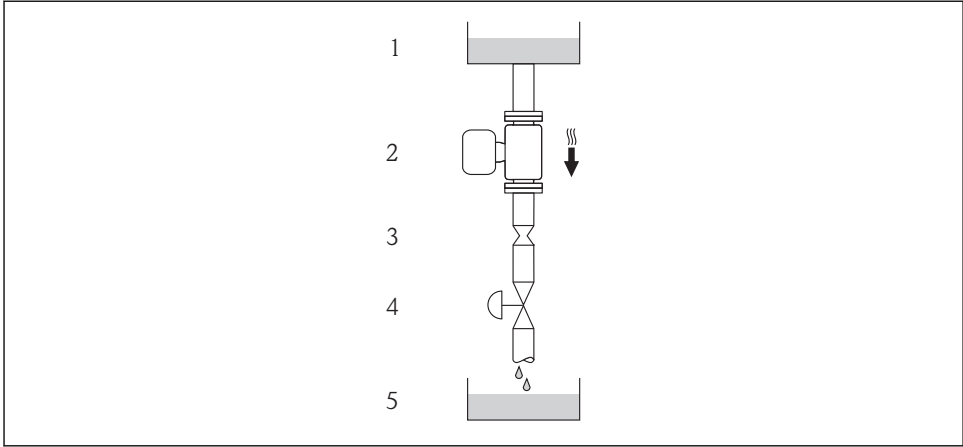

A0015596



2 Installation in a down pipe (e.g. for batching applications)

- 1 Supply tank
- 2 Sensor
- 3 Orifice plate, pipe restriction
- 4 Valve
- 5 Batching tank

DN		Ø orifice plate, pipe restriction	
[mm]	[in]	[mm]	[in]
1	1/24	0.8	0.03
2	1/12	1.5	0.06
4	1/8	3.0	0.12
6	1/4	5.0	0.20

Orientation

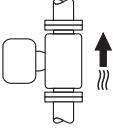
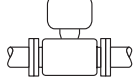
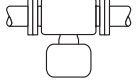
The direction of the arrow on the sensor nameplate helps you to install the sensor according to the flow direction.

Orientation			Recommendation
A	Vertical orientation	 A0015591	☑☑
B	Horizontal orientation, transmitter head up	 A0015589	☑☑ ¹⁾ Exception:
C	Horizontal orientation, transmitter head down	 A0015590	☑☑ ²⁾ Exception:
D	Horizontal orientation, transmitter head at side	 A0015592	☒

- 1) Applications with low process temperatures may reduce the ambient temperature. To maintain the minimum ambient temperature for the transmitter, this orientation is recommended.
- 2) Applications with high process temperatures may increase the ambient temperature. To maintain the maximum ambient temperature for the transmitter, this orientation is recommended.

Inlet and outlet runs

No special precautions need to be taken for fittings which create turbulence, such as valves, elbows or T-pieces, as long as no cavitation occurs (→ 14).

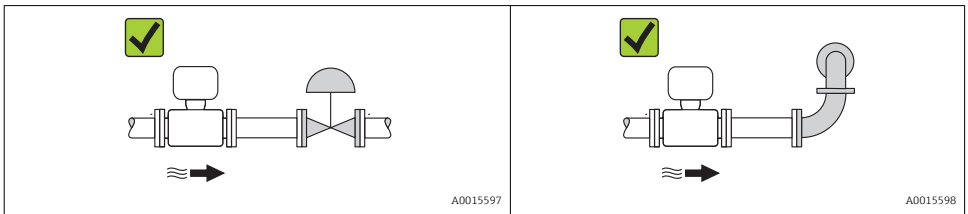

 For the dimensions and installation lengths of the device, see the "Technical Information" document, "Mechanical construction" section

6.1.2 Requirements from environment and process

Ambient temperature range

Measuring device	Non-Ex	-40 to +60 °C (-40 to +140 °F)
	Ex na, NI version	-40 to +60 °C (-40 to +140 °F)

	Ex ia, IS version	<ul style="list-style-type: none"> ■ -40 to +60 °C (-40 to +140 °F) ■ -50 to +60 °C (-58 to +140 °F) (Order code for "Test, certificate", option JM)
Local display		-20 to +60 °C (-4 to +140 °F) The readability of the display may be impaired at temperatures outside the temperature range.
Safety Barrier Promass 100		-40 to +60 °C (-40 to +140 °F)

► If operating outdoors:

Avoid direct sunlight, particularly in warm climatic regions.

System pressure

For this reason, the following mounting locations are recommended:

- At the lowest point in a vertical pipe
- Downstream from pumps (no danger of vacuum)

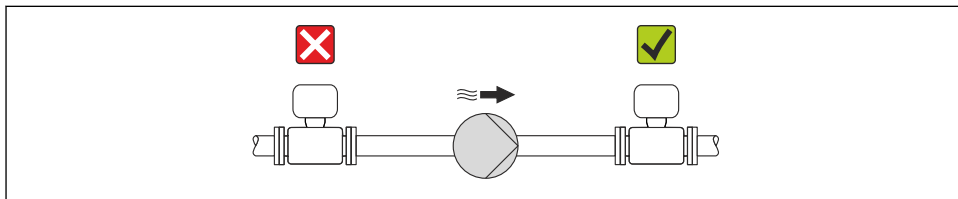

A0015594

Thermal insulation

In the case of some fluids, it is important that the heat radiated from the sensor to the transmitter is kept to a minimum. A wide range of materials can be used for the required insulation.

NOTICE

Electronics overheating on account of thermal insulation!

- Observe maximum permitted insulation height of the transmitter neck so that the transmitter head is completely free.

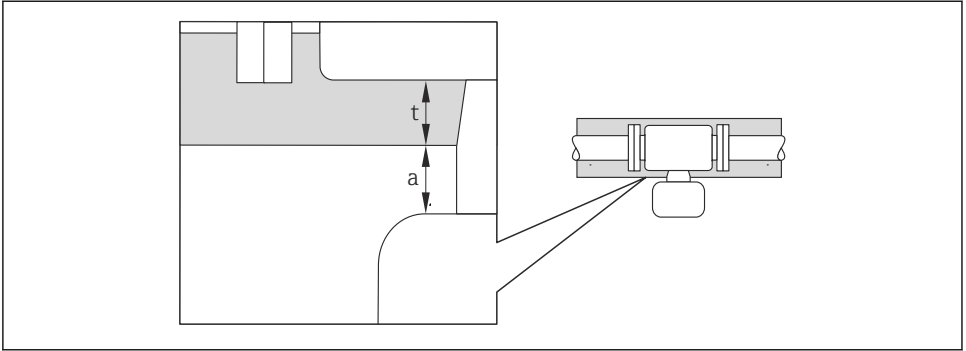

A0019919

- a* Minimum distance to insulation
- t* maximum Insulation thickness

The minimum distance between the transmitter housing and the insulation is 10 mm (0.39 in) so that the transmitter head remains completely exposed.

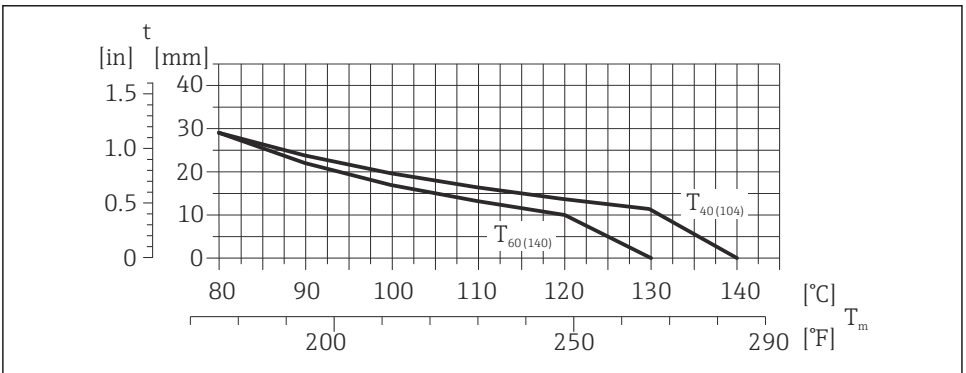

A0023173

- 3 *Maximum recommended insulation thickness depending on the temperature of the medium and the ambient temperature*

- t* Insulation thickness
- T_m Medium temperature
- $T_{40(104)}$ Maximum recommended insulation thickness at an ambient temperature of $T_a = 40^\circ\text{C}$ (104 °F)
- $T_{60(140)}$ Maximum recommended insulation thickness at an ambient temperature of $T_a = 60^\circ\text{C}$ (140 °F)

NOTICE

Danger of overheating with insulation

- ▶ Ensure that the temperature at the lower end of the transmitter housing does not exceed 80°C (176 °F)

NOTICE

The insulation can also be thicker than the maximum recommended insulation thickness.

Prerequisite:

- ▶ Ensure that convection takes place on a sufficiently large scale at the transmitter neck.
- ▶ Ensure that a sufficiently large area of the housing support remains exposed. The uncovered part serves as a radiator and protects the electronics from overheating and excessive cooling.

Heating**NOTICE**

Electronics can overheat due to elevated ambient temperature!

- ▶ Observe maximum permitted ambient temperature for the transmitter (→  13).
- ▶ Depending on the fluid temperature, take the device orientation requirements into account .

NOTICE

Danger of overheating when heating

- ▶ Ensure that the temperature at the lower end of the transmitter housing does not exceed 80 °C (176 °F)
- ▶ Ensure that convection takes place on a sufficiently large scale at the transmitter neck.
- ▶ Ensure that a sufficiently large area of the housing support remains exposed. The uncovered part serves as a radiator and protects the electronics from overheating and excessive cooling.

Heating options

If a fluid requires that no heat loss should occur at the sensor, users can avail of the following heating options:

- Electrical heating, e.g. with electric band heaters
- Via pipes carrying hot water or steam
- Via heating jackets



For detailed information about heating with electrical band heaters, refer to the Operating Instructions for the device on the CD-ROM provided

Vibrations

The high oscillation frequency of the measuring tubes ensures that the correct operation of the measuring system is not influenced by plant vibrations.

6.1.3 Special mounting instructions**Rupture disk**

Make sure that the function and operation of the rupture disk is not impeded through the installation of the device. The position of the rupture disk is indicated on a sticker beside it. For additional information that is relevant to the process .

The existing connecting nozzles are not intended for the purpose of rinsing or pressure monitoring, but instead serve as the mounting location for the rupture disk.

However, by means of the connection available on the rupture disk holder, the escaping fluid (in case of a disk rupture) can be collected by connecting a suitable relief system.

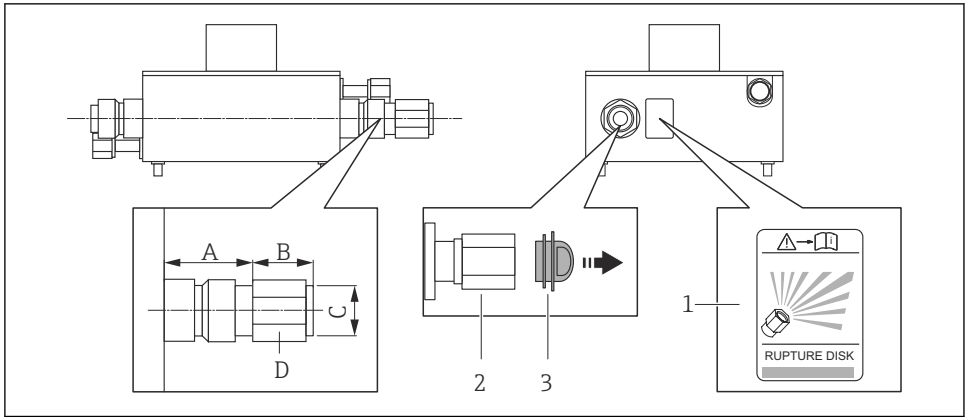

A0019637

- 1 Rupture disk label
- 2 Rupture disk with 1/2" NPT internal thread with 1" width across flat
- 3 Transport protection

DN		A		B		C	D
[mm]	[in]	[mm]	[in]	[mm]	[in]	[in]	[in]
1 to 6	1/24 to 1/4	33	1.3	Approx.42	Approx.1.65	1/2 NPT	AF 1

For detailed information about using a rupture disk, refer to the Operating Instructions for the device on the CD-ROM provided

Wall mounting

⚠ WARNING

Incorrect sensor mounting

Risk of injury if measuring tube breaks

- ▶ The sensor should never be installed in a pipe in a way that it is freely suspended
- ▶ Using the base plate, mount the sensor directly on the floor, wall or ceiling.
- ▶ Support the sensor on a securely mounted support base (e.g. angle bracket).

The following mounting versions are recommended for the installation.

Vertical

- Mounted directly on a wall using the base plate, or
- Device supported on an angle bracket mounted on the wall

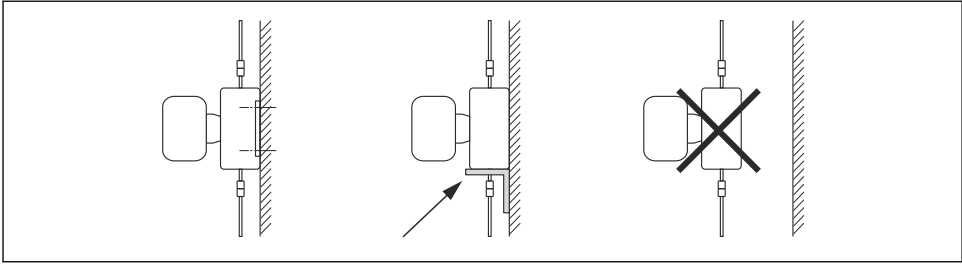

A0019631

Horizontal

Device standing on a solid support base

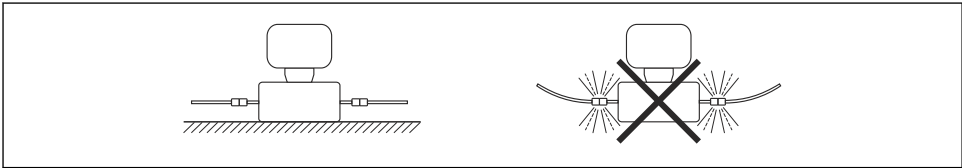

A0019632

Mounting plate

The universal mounting plate can be used to affix or place the unit on a flat surface (order code for "Accessories", option PA).

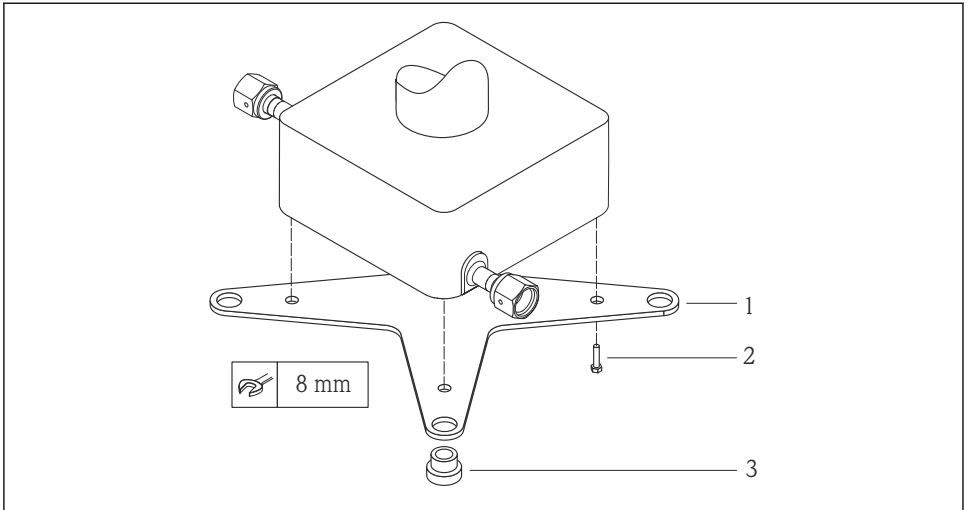

A0019768

4 Mounting kit for Cubemass mounting plate

- 1 1 x Cubemass mounting plate
- 2 4 x screw M5 x 8
- 3 4 x grommet

Zero point adjustment

All measuring devices are calibrated in accordance with state-of-the-art technology. Calibration takes place under reference conditions. Therefore, a zero point adjustment in the field is generally not required.

Experience shows that zero point adjustment is advisable only in special cases:

- To achieve maximum measuring accuracy even with low flow rates
- Under extreme process or operating conditions (e.g. very high process temperatures or very high-viscosity fluids).

6.2 Mounting the measuring device

6.2.1 Required tools

For sensor

For flanges and other process connections: Corresponding mounting tools

6.2.2 Preparing the measuring device

1. Remove all remaining transport packaging.
2. Remove any protective covers or protective caps present from the sensor.
3. Remove stick-on label on the electronics compartment cover.

6.2.3 Mounting the measuring device

⚠ WARNING

Danger due to improper process sealing!

- ▶ Ensure that the inside diameters of the gaskets are greater than or equal to that of the process connections and piping.
- ▶ Ensure that the gaskets are clean and undamaged.
- ▶ Install the gaskets correctly.

1. Ensure that the direction of the arrow on the nameplate of the sensor matches the flow direction of the fluid.
2. Install the measuring device or turn the transmitter housing so that the cable entries do not point upwards.

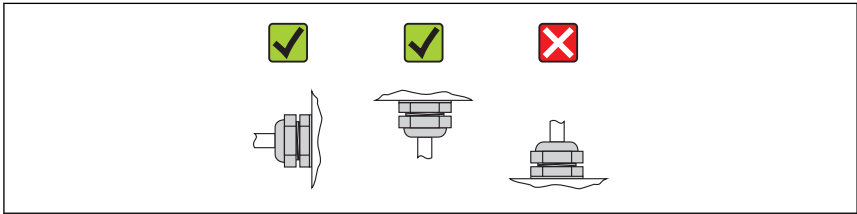

A0013964

6.2.4 Turning the display module

The local display is only available with the following device version:

Order code for "Display; Operation", option **B**: 4-line; lit, via communication

The display module can be turned to optimize display readability.

Aluminum housing version, AlSi10Mg, coated

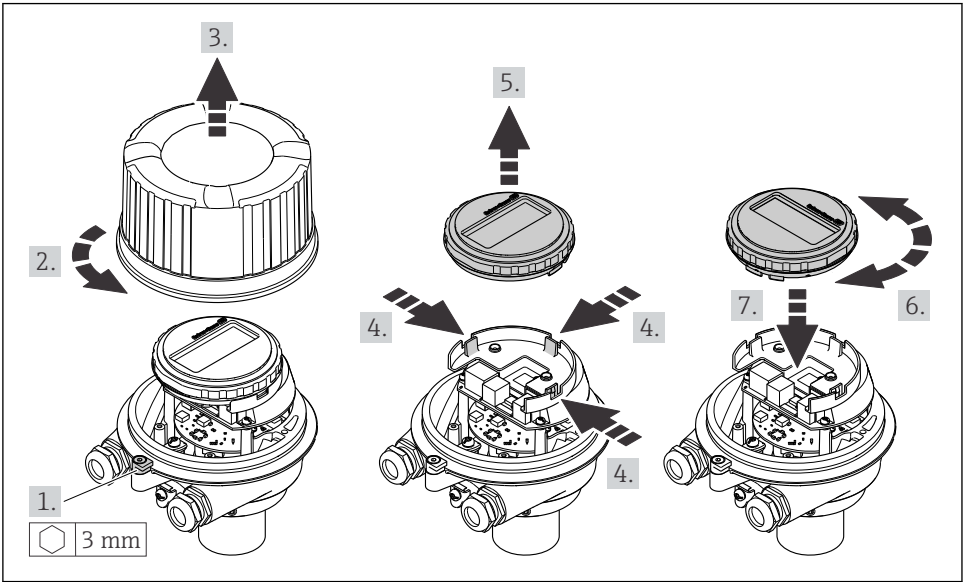

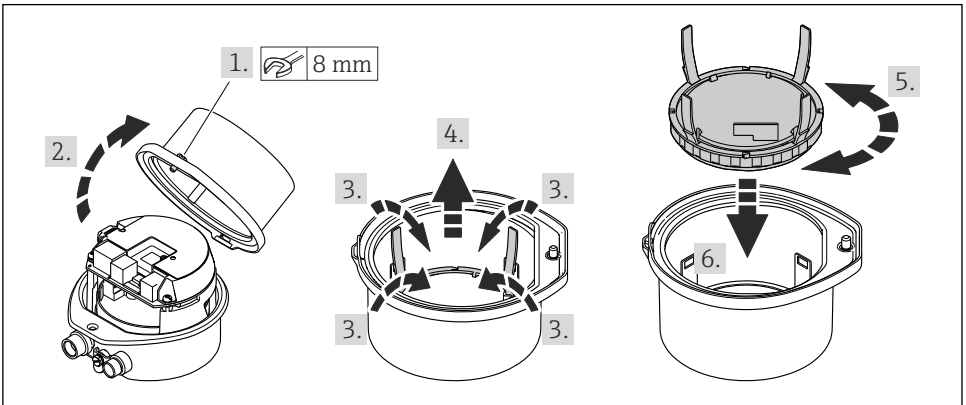

A0023192

Compact and ultra-compact housing version, hygienic, stainless



A0023195

6.3 Post-installation check

Is the device undamaged (visual inspection)?	<input type="checkbox"/>
Does the measuring device conform to the measuring point specifications? For example: <ul style="list-style-type: none"> ▪ Process temperature ▪ Process pressure (refer to the chapter on "Pressure-temperature ratings" of the "Technical Information" document on the CD-ROM provided) ▪ Ambient temperature (→  13) ▪ Measuring range 	<input type="checkbox"/>
Has the correct orientation for the sensor been selected ? <ul style="list-style-type: none"> ▪ According to sensor type ▪ According to medium temperature ▪ According to medium properties (outgassing, with entrained solids) 	<input type="checkbox"/>
Does the arrow on the sensor nameplate match the direction of flow of the fluid through the piping (→  12)?	<input type="checkbox"/>
Are the measuring point identification and labeling correct (visual inspection)?	<input type="checkbox"/>
Is the device adequately protected from precipitation and direct sunlight?	<input type="checkbox"/>
Are the securing screw and securing clamp tightened securely?	<input type="checkbox"/>

7 Electrical connection



The measuring device does not have an internal circuit breaker. For this reason, assign the measuring device a switch or power-circuit breaker so that the power supply line can be easily disconnected from the mains.

7.1 Connection conditions

7.1.1 Required tools

- For cable entries: Use corresponding tools
- For securing clamp (on aluminum housing): Allen screw 3 mm
- For securing screw (for stainless steel housing): open-ended wrench 8 mm
- Wire stripper
- When using stranded cables: crimping tool for ferrule

7.1.2 Requirements for connecting cable

The connecting cables provided by the customer must fulfill the following requirements.

Electrical safety

In accordance with applicable federal/national regulations.

Permitted temperature range

- -40 °C (-40 °F) to $+80\text{ °C}$ ($+176\text{ °F}$)
- Minimum requirement: cable temperature range \geq ambient temperature $+20\text{ K}$

Power supply cable

Standard installation cable is sufficient.

Signal cable

Current output

For 4-20 mA HART: Shielded cable recommended. Observe grounding concept of the plant.

Pulse/frequency/switch output

Standard installation cable is sufficient.

FOUNDATION Fieldbus

Twisted, shielded two-wire cable.



For further information on planning and installing FOUNDATION Fieldbus networks see:

- Operating Instructions for "FOUNDATION Fieldbus Overview" (BA00013S)
- FOUNDATION Fieldbus Guideline
- IEC 61158-2 (MBP)

PROFIBUS PA

Twisted, shielded two-wire cable. Cable type A is recommended.

 For further information on planning and installing PROFIBUS PA networks see:

- Operating Instructions "PROFIBUS DP/PA: Guidelines for planning and commissioning" (BA00034S)
- PNO Directive 2.092 "PROFIBUS PA User and Installation Guideline"
- IEC 61158-2 (MBP)

PROFIBUS DP

The IEC 61158 standard specifies two types of cable (A and B) for the bus line which can be used for every transmission rate. Cable type A is recommended.

 For detailed information about the specification of the connecting cable, see the Operating Instructions for the device.

Modbus RS485

The EIA/TIA-485 standard specifies two types of cable (A and B) for the bus line which can be used for every transmission rate. Cable type A is recommended.

 For detailed information about the specification of the connecting cable, see the Operating Instructions for the device.

EtherNet/IP

The standard ANSI/TIA/EIA-568-B.2 Annex specifies CAT 5 as the minimum category for a cable used for EtherNet/IP. CAT 5e and CAT 6 are recommended.

 For more information on planning and installing EtherNet/IP networks, please refer to the "Media Planning and Installation Manual. EtherNet/IP" of ODVA Organization.

Connecting cable between Safety Barrier Promass 100 and measuring device

Cable type	Shielded twisted-pair cable with 2x2 wires. When grounding the cable shield, observe the grounding concept of the plant.
Maximum cable resistance	2.5 Ω, one side

 Comply with the maximum cable resistance specifications to ensure the operational reliability of the measuring device.

Wire cross-section		Maximum cable length	
[mm ²]	[AWG]	[m]	[ft]
0.5	20	70	230
0.75	18	100	328
1.0	17	100	328
1.5	16	200	656
2.5	14	300	984

Cable diameter

- Cable glands supplied:
M20 × 1.5 with cable ϕ 6 to 12 mm (0.24 to 0.47 in)
- Spring terminals:
Wire cross-sections 0.5 to 2.5 mm² (20 to 14 AWG)
- With Safety Barrier Promass 100:
Plug-in screw terminals for wire cross-sections 0.5 to 2.5 mm² (20 to 14 AWG)

7.1.3 Terminal assignment

Transmitter

Connection version 4-20 mA HART with pulse/frequency/switch output

Order code for "Output", option **B**

Depending on the housing version, the transmitters can be ordered with terminals or device plugs.

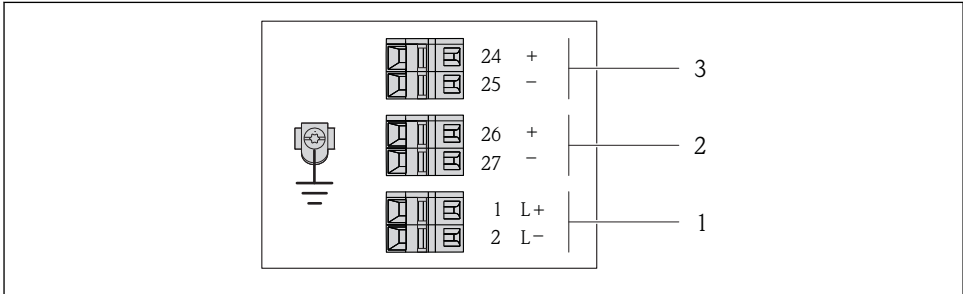

A0016888

5 Terminal assignment 4-20 mA HART with pulse/frequency/switch output

- 1 Power supply: DC 24 V
- 2 Output 1: 4-20 mA HART (active)
- 3 Output 2: pulse/frequency/switch output (passive)

Order code for "Output"	Terminal number					
	Power supply		Output 1		Output 2	
	2 (L-)	1 (L+)	27 (-)	26 (+)	25 (-)	24 (+)
Option B	DC 24 V		4-20 mA HART (active)		Pulse/frequency/switch output (passive)	
Order code for "Output": Option B: 4-20 mA HART with pulse/frequency/switch output						

PROFIBUS DP connection version



For use in the non-hazardous area and Zone 2/Div. 2.

Order code for "Output", option L

Depending on the housing version, the transmitters can be ordered with terminals or device plugs.

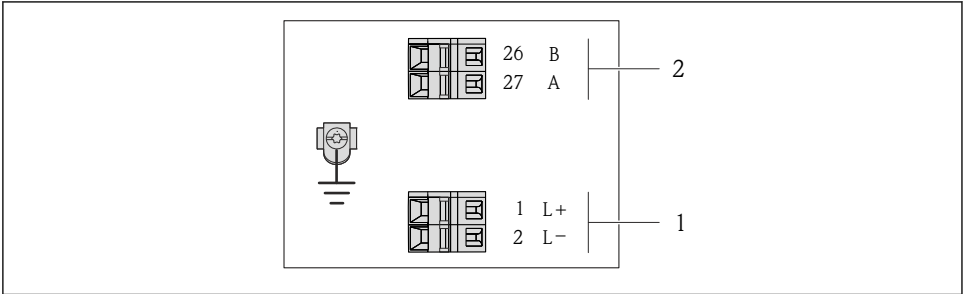

A0022716

6 *PROFIBUS DP terminal assignment*

- 1 Power supply: DC 24 V
- 2 PROFIBUS DP

Order code for "Output"	Terminal number			
	Power supply		Output	
	2 (L-)	1 (L+)	26 (RxD/TxD-P)	27 (RxD/TxD-N)
Option L	DC 24 V		B	A
Order code for "Output": Option L: PROFIBUS DP, for use in non-hazardous areas and Zone 2/div. 2				

Modbus RS485 connection version

 For use in the non-hazardous area and Zone 2/Div. 2.

Order code for "Output", option **M**

Depending on the housing version, the transmitters can be ordered with terminals or device plugs.

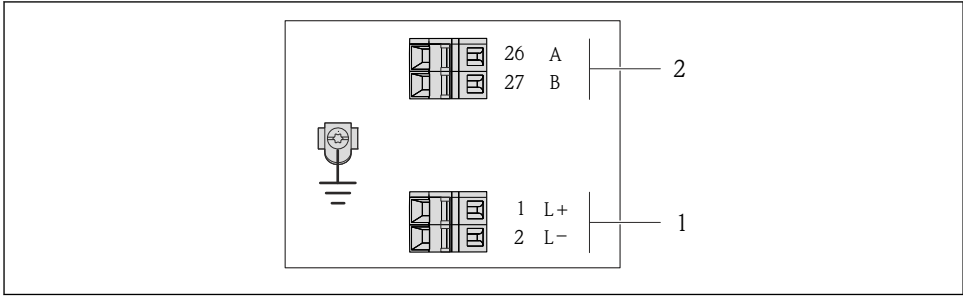

 7 *Modbus RS485 terminal assignment, connection version for use in non-hazardous areas and Zone 2/Div. 2*

- 1 *Power supply: DC 24 V*
- 2 *Modbus RS485*

Order code for "Output"	Terminal number			
	Power supply		Output	
	2 (L-)	1 (L+)	27 (B)	26 (A)
Option M	DC 24 V		Modbus RS485	
Order code for "Output": Option M Modbus RS485, for use in non-hazardous areas and Zone 2/Div. 2				

Modbus RS485 connection version



For use in the intrinsically safe area. Connection via Safety Barrier Promass 100.

Order code for "Output", option **M**

Depending on the housing version, the transmitters can be ordered with terminals or device plugs.

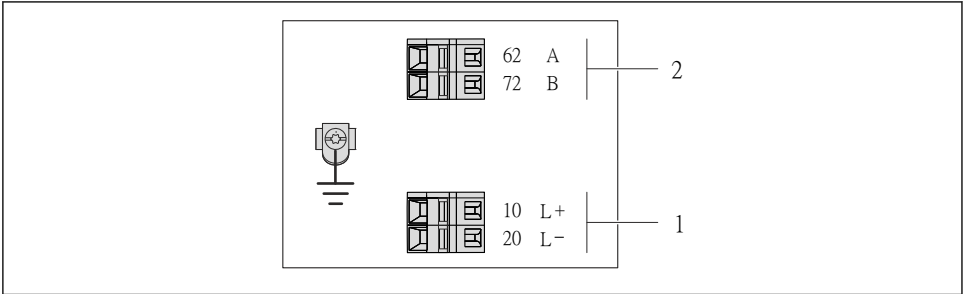

A0017053

8 *Modbus RS485 terminal assignment, connection version for use in intrinsically safe areas (connection via Safety Barrier Promass 100)*

- 1 *Intrinsically safe power supply*
- 2 *Modbus RS485*

Order code for "Output"	20 (L-)	10 (L+)	72 (B)	62 (A)
Option M	Intrinsically safe supply voltage		Modbus RS485 intrinsically safe	
Order code for "Output": Option M : Modbus RS485, for use in intrinsically safe areas (connection via Safety Barrier Promass 100)				

EtherNet/IP connection version

Order code for "Output", option **N**

Depending on the housing version, the transmitters can be ordered with terminals or device plugs.

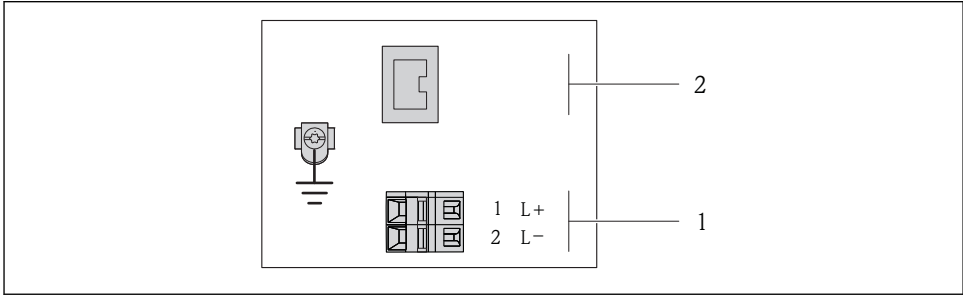

A0017054

9 *EtherNet/IP terminal assignment*

- 1 Power supply: DC 24 V
- 2 EtherNet/IP

Order code for "Output"	Terminal number		Output Device plug M12x1
	2 (L-)	1 (L+)	
Option N	DC 24 V		EtherNet/IP
Order code for "Output": Option N : EtherNet/IP			

Safety Barrier Promass 100

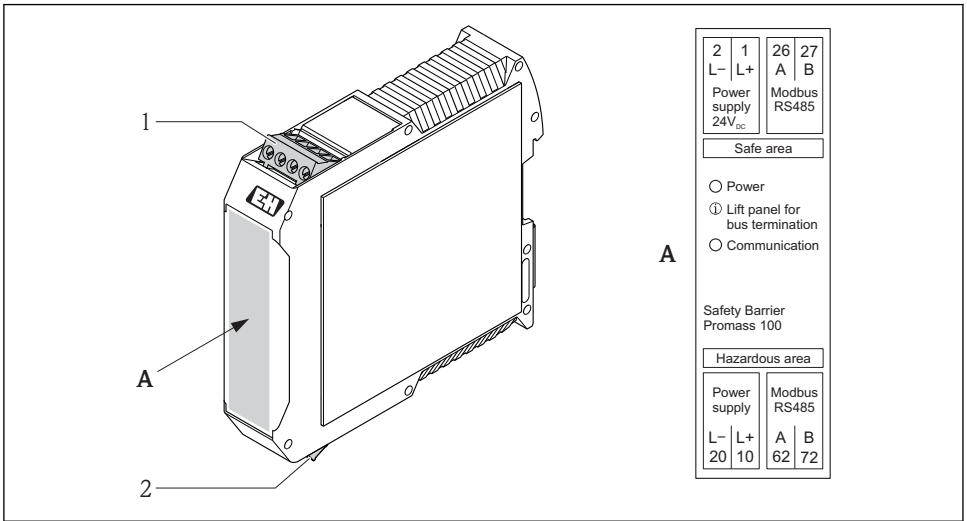

A0016922

10 Safety Barrier Promass 100 with terminals

- 1 Non-hazardous area and Zone 2/Div. 2
- 2 Intrinsically safe area

7.1.4 Pin assignment, device plug

Supply voltage

For all connection versions except MODBUS RS485 intrinsically safe (device side)

 Device plug MODBUS RS485 intrinsically safe with supply voltage (→  33)

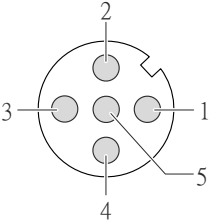
 A0016809	Pin	Assignment	
	1	L+	DC 24 V
	2		
	3		
	4	L-	DC 24 V
	5		Grounding/shielding
Coding		Plug/socket	
A		Plug	

4-20 mA HART with pulse/frequency/switch output

Device plug for signal transmission (device side)

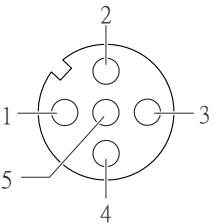
 A0016810	Pin	Assignment	
	1	+	4-20 mA HART (active)
	2	-	4-20 mA HART (active)
	3	+	Pulse/frequency/switch output (passive)
	4	-	Pulse/frequency/switch output (passive)
	5		Grounding/shielding
Coding		Plug/socket	
A		Socket	

PROFIBUS DP

 For use in the non-hazardous area and Zone 2/Div. 2.

Device plug for signal transmission (device side)

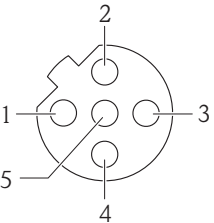
 A0016811	Pin	Assignment	
	1		
	2	A	PROFIBUS DP
	3		
	4	B	PROFIBUS DP
	5		Grounding/shielding
Coding		Plug/socket	
B		Socket	

MODBUS RS485

Device plug for signal transmission with supply voltage (device side), MODBUS RS485 (intrinsically safe)

<p style="text-align: right; font-size: small;">A0016809</p>	Pin		Assignment
	1	L+	Supply voltage, intrinsically safe
	2	A	Modbus RS485 intrinsically safe
	3	B	
	4	L-	Supply voltage, intrinsically safe
	5		Grounding/shielding
Coding		Plug/socket	
A		Plug	

Device plug for signal transmission (device side), MODBUS RS485 (not intrinsically safe)



For use in the non-hazardous area and Zone 2/Div. 2.

<p style="text-align: right; font-size: small;">A0016811</p>	Pin		Assignment
	1		
	2	A	Modbus RS485
	3		
	4	B	Modbus RS485
	5		Grounding/shielding
Coding		Plug/socket	
B		Socket	

EtherNet/IP

Device plug for signal transmission (device side)

<p style="text-align: right; font-size: small;">A0016812</p>	Pin		Assignment
	1	+	Tx
	2	+	Rx
	3	-	Tx
	4	-	Rx
	Coding		Plug/socket
D		Socket	

7.1.5 Shielding and grounding

Modbus

The shielding and grounding concept requires compliance with the following:

- Electromagnetic compatibility (EMC)
- Explosion protection
- Personal protection equipment
- National installation regulations and guidelines
- Observe cable specification (→  23).
- Keep the stripped and twisted lengths of cable shield to the ground terminal as short as possible.
- Seamless cable shielding.

Grounding of the cable shield

To comply with EMC requirements:

- Ensure the cable shield is grounded to the potential matching line at multiple points.
- Connect every local ground terminal to the potential matching line.

NOTICE

In systems without potential matching, the multiple grounding of the cable shield causes mains frequency equalizing currents!

Damage to the bus cable shield.

- ▶ Only ground the bus cable shield to either the local ground or the protective ground at one end.

PROFIBUS DP

Optimum electromagnetic compatibility (EMC) of the fieldbus system can only be guaranteed if the system components and, in particular, the lines are shielded and the shield forms as complete a cover as possible. A shield coverage of 90% is ideal.

- To ensure an optimum EMC protective effect, connect the shield as often as possible to the reference ground.
- For reasons of explosion protection, you should refrain from grounding however.

To comply with both requirements, the fieldbus system allows three different types of shielding:

- Shielding at both ends.
- Shielding at one end on the feed side with capacitance termination at the field device.
- Shielding at one end on the feed side.

Experience shows that the best results with regard to EMC are achieved in most cases in installations with one-sided shielding on the feed side (without capacitance termination at the field device). Appropriate measures with regard to input wiring must be taken to allow unrestricted operation when EMC interference is present. These measures have been taken into account for this device. Operation in the event of disturbance variables as per NAMUR NE21 is thus guaranteed.

Where applicable, national installation regulations and guidelines must be observed during the installation!

Where there are large differences in potential between the individual grounding points, only one point of the shielding is connected directly with the reference ground. In systems without potential equalization, therefore, cable shielding of fieldbus systems should only be grounded on one side, for example at the fieldbus supply unit or at safety barriers.

NOTICE

In systems without potential matching, the multiple grounding of the cable shield causes mains frequency equalizing currents!

Damage to the bus cable shield.

- ▶ Only ground the bus cable shield to either the local ground or the protective ground at one end. Insulate the shield that is not connected.

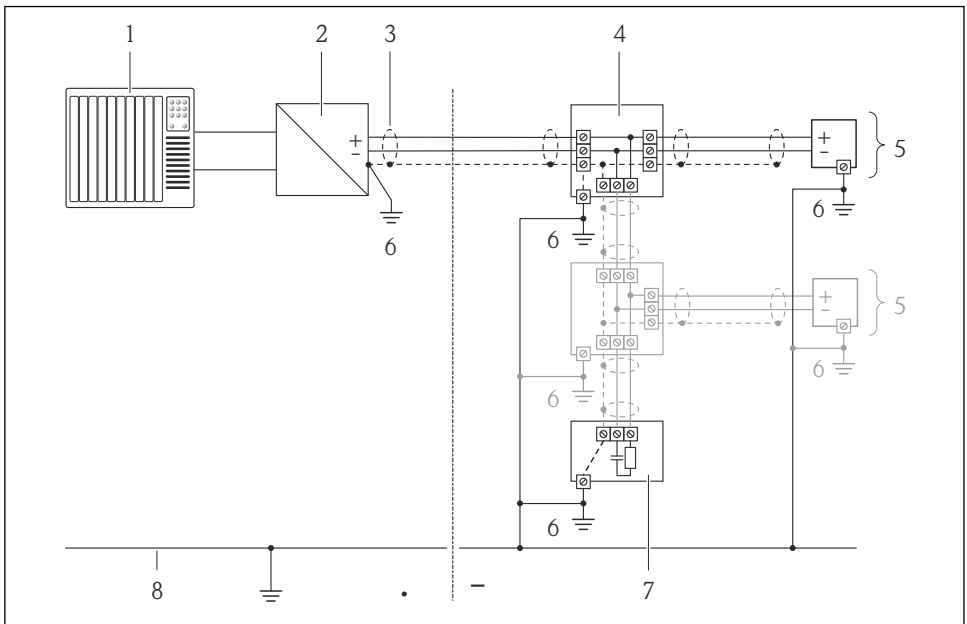

A0019004

- 1 Controller (e.g. PLC)
- 2 Segment coupler PROFIBUS DP/PA
- 3 Cable shield
- 4 T-box
- 5 Measuring device
- 6 Local grounding
- 7 Bus terminator
- 8 Potential matching line

7.1.6 Preparing the measuring device

1. Remove dummy plug if present.

2. **NOTICE!** Insufficient sealing of the housing! Operational reliability of the measuring device could be compromised. Use suitable cable glands corresponding to the degree of protection.

If measuring device is delivered without cable glands:

Provide suitable cable gland for corresponding connecting cable (→ 📄 23).

3. If measuring device is delivered with cable glands:

Observe cable specification (→ 📄 23).

7.2 Connecting the measuring device

NOTICE

Limitation of electrical safety due to incorrect connection!

- ▶ For use in potentially explosive atmospheres, observe the information in the device-specific Ex documentation.

7.2.1 Connecting the transmitter

The connection of the transmitter depends on the following order codes:

- Housing version: compact or ultra-compact
- Connection version: device plug or terminals

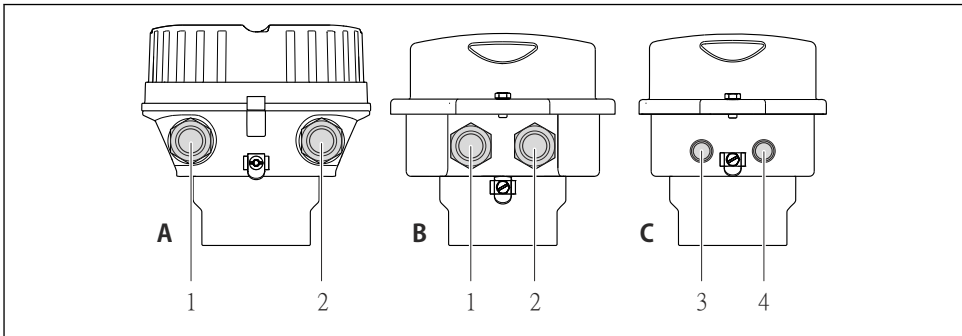

A0016924

📄 11 Housing versions and connection versions

- A Housing version: compact, aluminum coated
- B Housing version: compact hygienic, stainless
- 1 Cable entry or device plug for signal transmission
- 2 Cable entry or device plug for supply voltage
- C Housing version: ultra-compact, hygienic, stainless:
- 3 Device plug for signal transmission
- 4 Device plug for supply voltage

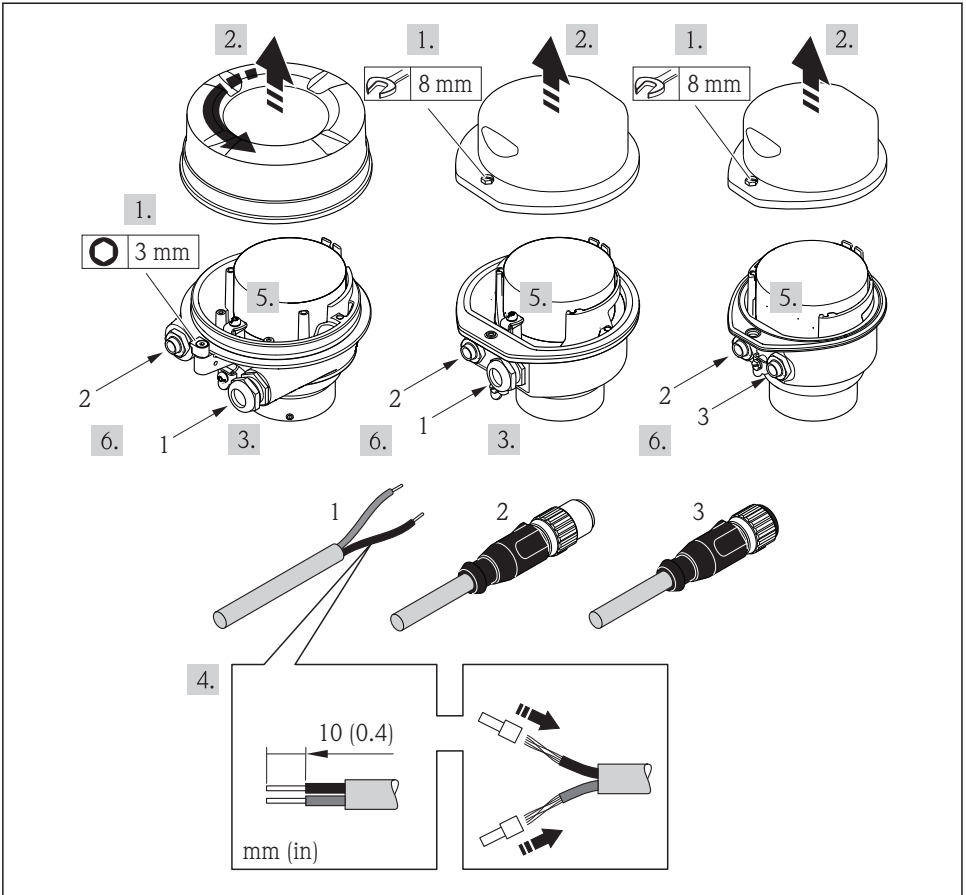

A0017844

12 Device versions with connection examples

- 1 Cable
- 2 Device plug for signal transmission
- 3 Device plug for supply voltage

i Depending on the housing version disconnect the local display from the main electronics module: Operating Instructions for the device .

▶ Connect the cable in accordance with the terminal assignment or the device plug pin assignment .

7.2.2 Connecting the Safety Barrier Promass 100

In the case of the device version with Modbus RS485 intrinsically safe, the transmitter must be connected to the Safety Barrier Promass 100.

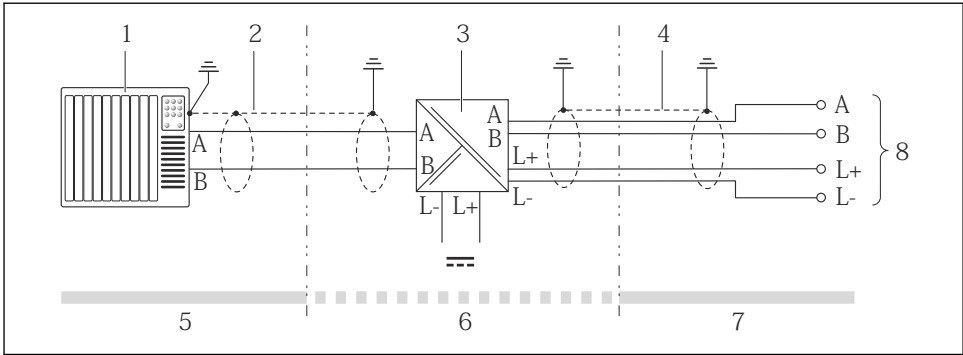

A0016804

13 Electrical connection between the transmitter and Safety Barrier Promass 100

- 1 Control system (e.g. PLC)
- 2 Observe cable specification
- 3 Safety Barrier Promass 100: terminal assignment
- 4 Observe cable specification (→ 24)
- 5 Non-hazardous area
- 6 Non-hazardous area and Zone 2/Div. 2
- 7 Intrinsically safe area
- 8 Transmitter: terminal assignment

7.2.3 Ensuring potential equalization

Requirements

No special measures for potential equalization are required.

 For devices intended for use in hazardous locations, please observe the guidelines in the Ex documentation (XA).

7.3 Hardware settings

7.3.1 Setting the device address

EtherNet/IP

The IP address of the measuring device can be configured for the network via DIP switches.



Addressing data

IP address and configuration options			
1st octet	2nd octet	3rd octet	4th octet
192.	168.	1.	XXX

↓
Can only be configured via software addressing

↓
Can be configured via software addressing and hardware addressing

IP address range	1 to 254 (4th octet)
IP address broadcast	255
Addressing mode ex works	Software addressing; all DIP switches for hardware addressing are set to OFF.
IP address ex works	DHCP server active

 For device addressing via software (→  54)

Setting the address

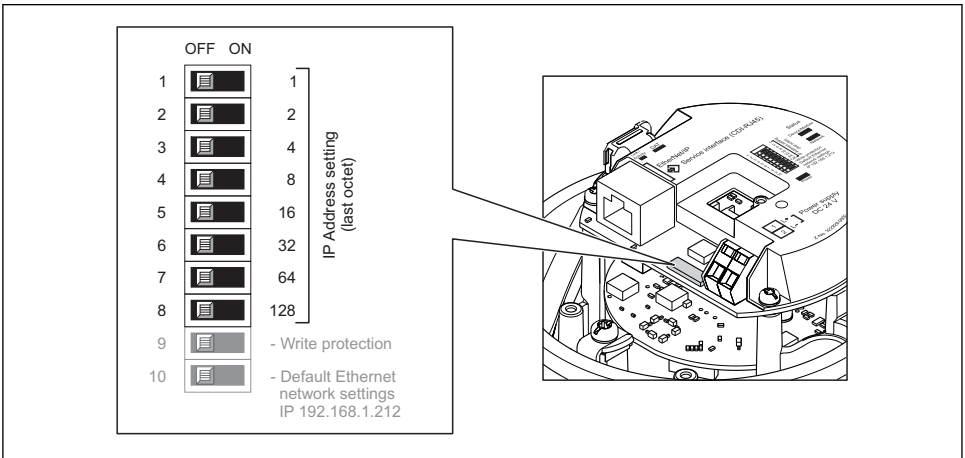

▶ Set the desired IP address using the corresponding DIP switches on the I/O electronics module.

↳ Hardware addressing with the configured IP address is enabled after 10 s.

PROFIBUS DP

The address must always be configured for a PROFIBUS DP/PA device. The valid address range is between 1 and 126. In a PROFIBUS DP/PA network, each address can only be assigned once. If an address is not configured correctly, the device is not recognized by the master. All measuring devices are delivered from the factory with the device address 126 and with the software addressing method.

Setting the address

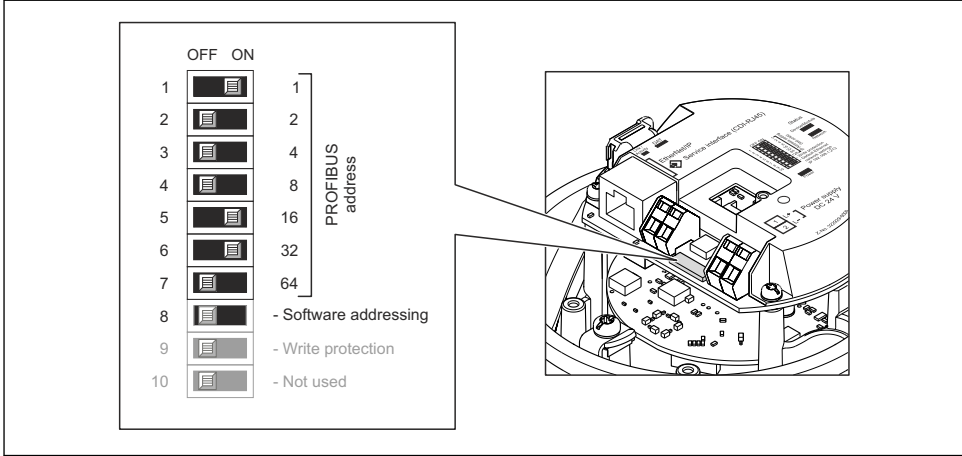

A0021265

14 Addressing using DIP switches on the I/O electronics module

1. Disable software addressing via DIP switch 8 (OFF).
2. Set the desired device address via the corresponding DIP switches.
 - ↳ Example (→ 14, 40): $1 + 16 + 32 = \text{device address } 49$

The device demands rebooting after 10 s. After rebooting, hardware addressing is enabled with the configured IP address.

7.3.2 Enabling the terminating resistor

PROFIBUS DP

To avoid incorrect communication transmission caused by impedance mismatch, terminate the PROFIBUS DP cable correctly at the start and end of the bus segment.

- If the device is operated with a baud rate of 1.5 MBaud and under:
For the last transmitter on the bus, terminate via DIP switch 2 (bus termination) and DIP switch 1 and 3 (bus polarization). Setting: ON – ON – ON (→ 15, 41).
- For baud rates > 1.5 MBaud:
Due to the capacitance load of the user and the line reflections generated as a result, ensure that an external bus terminator is used.

i It is generally advisable to use an external bus terminator as the entire segment can fail if a device that is terminated internally is defective.

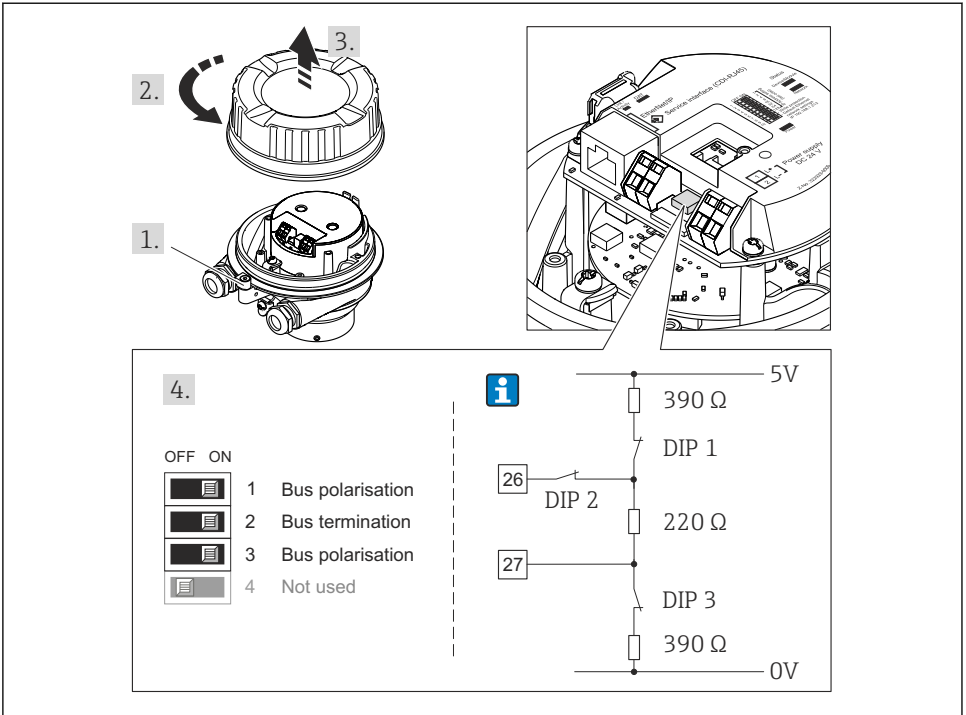

A002.1274

15 Termination using DIP switches on the I/O electronics module (for baud rates < 1.5 MBaud)

Modbus RS485

To avoid incorrect communication transmission caused by impedance mismatch, terminate the Modbus RS485 cable correctly at the start and end of the bus segment.

If the transmitter is used in the non-hazardous area or Zone 2/Div. 2

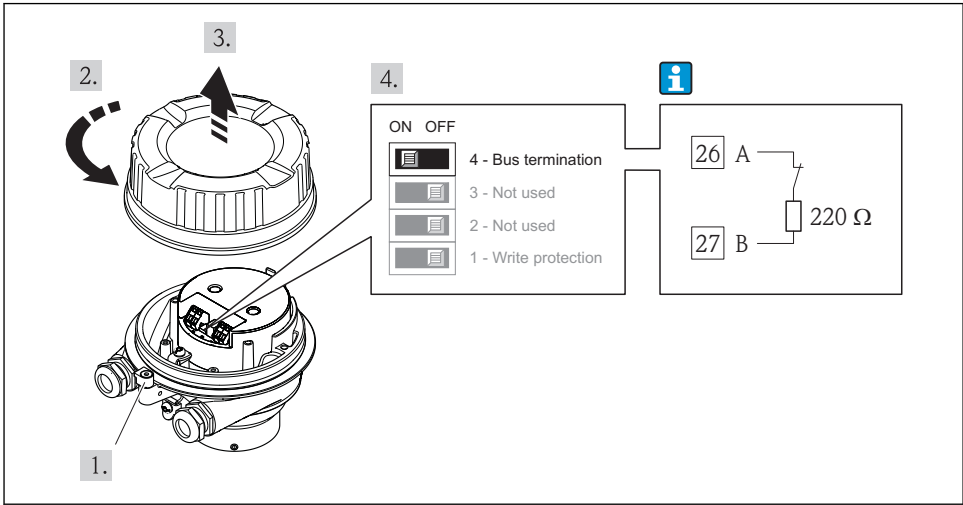

A0017610

16 Terminating resistor can be enabled via DIP switch on the main electronics module

If the transmitter is used in the intrinsically safe area

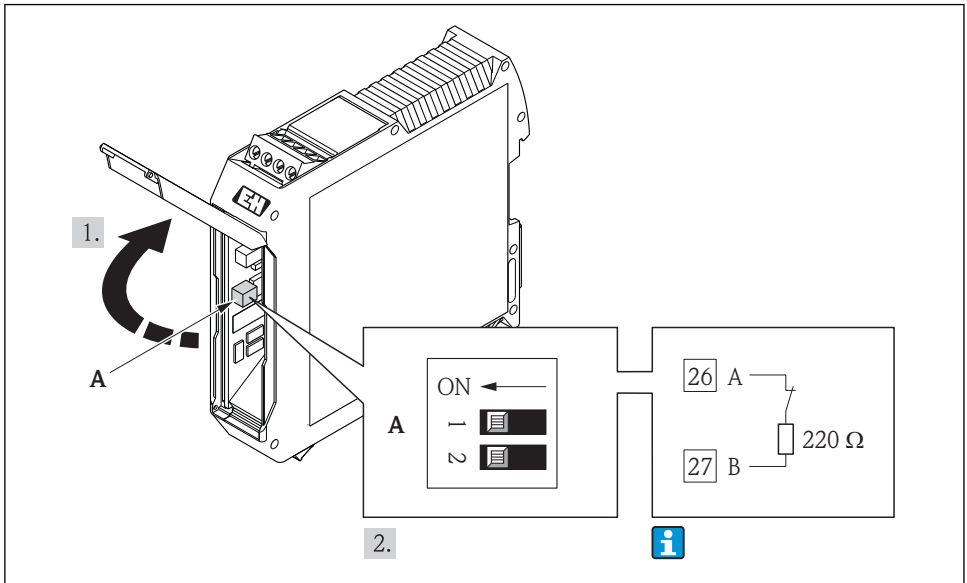

17 Terminating resistor can be enabled via DIP switch in the Safety Barrier Promass 100

7.4 Ensuring the degree of protection

The measuring device fulfills all the requirements for the IP66/67 degree of protection, Type 4X enclosure.

To guarantee IP66/67 degree of protection, Type 4X enclosure, carry out the following steps after the electrical connection:

1. Check that the housing seals are clean and fitted correctly. Dry, clean or replace the seals if necessary.
2. Tighten all housing screws and screw covers.
3. Firmly tighten the cable glands.
4. To ensure that moisture does not enter the cable entry, route the cable so that it loops down before the cable entry ("water trap").

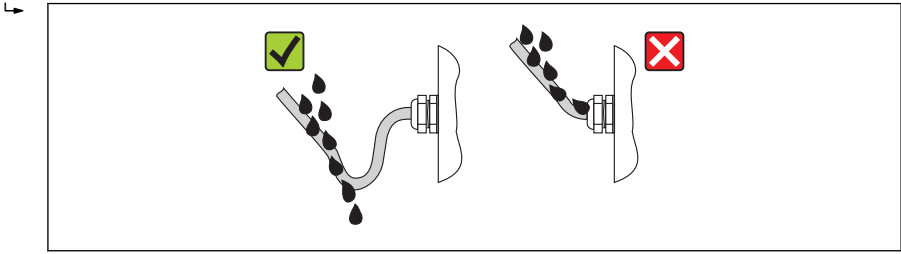

A0013960

- 5. Insert dummy plugs into unused cable entries.

7.5 Post-connection check

Are cables or the device undamaged (visual inspection)?	<input type="checkbox"/>
Do the cables comply with the requirements (→ 23)?	<input type="checkbox"/>
Do the cables have adequate strain relief?	<input type="checkbox"/>
Are all the cable glands installed, firmly tightened and leak-tight? Cable run with "water trap" (→ 43)?	<input type="checkbox"/>
Depending on the device version: are all the device plugs firmly tightened (→ 36)?	<input type="checkbox"/>
<ul style="list-style-type: none"> ▪ Does the supply voltage match the specifications on the transmitter nameplate ? ▪ For device version with Modbus RS485 intrinsically safe: does the supply voltage match the specifications on the nameplate of the Safety Barrier Promass 100 ? 	<input type="checkbox"/>
Is the terminal assignment or the pin assignment of the device plug correct?	<input type="checkbox"/>
<ul style="list-style-type: none"> ▪ If supply voltage is present, is the power LED on the electronics module of the transmitter lit green ? ▪ For device version with Modbus RS485 intrinsically safe, if supply voltage is present, is the power LED on the Safety Barrier Promass 100 lit ? 	<input type="checkbox"/>
Depending on the device version, is the securing clamp or fixing screw firmly tightened?	<input type="checkbox"/>

8 Operation options

8.1 Structure and function of the operating menu

8.1.1 Structure of the operating menu

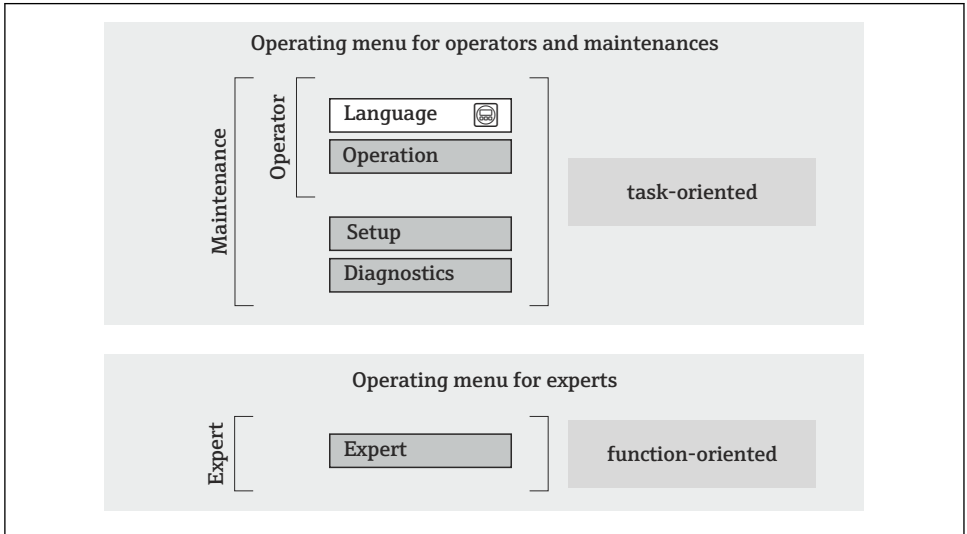

A0014058-EN

 18 Schematic structure of the operating menu

8.1.2 Operating philosophy

The individual parts of the operating menu are assigned to certain user roles (operator, maintenance etc.). Each user role contains typical tasks within the device lifecycle.

 For detailed information on the operating philosophy, see the Operating Instructions for the device.

8.2 Access to the operating menu via the Web browser

A Web browser is available on device versions with the following communication types: HART, PROFIBUS-DP, EtherNet/IP

This type of access is available with the following device version:
Order code for "Output", option **N**: EtherNet/IP

8.2.1 Function range

Thanks to the integrated Web server the device can be operated and configured via a Web browser.

8.2.2 Prerequisites

Computer hardware

Interface	The computer must have an RJ45 interface.
Connecting cable	Standard Ethernet cable with RJ45 connector.
Screen	Recommended size: $\geq 12"$ (depends on the screen resolution)  Web server operation is not optimized for touch screens!

Computer software

Recommended operating systems	Microsoft Windows 7 or higher.  Microsoft Windows XP is supported.
Web browsers supported	<ul style="list-style-type: none"> ▪ Microsoft Internet Explorer 8 or higher ▪ Mozilla Firefox ▪ Google chrome

Computer settings

User rights	User rights are required for TCP/IP and proxy server settings (for changes to the IP address, subnet mask etc.).
Proxy server settings of the Web browser	The Web browser setting <i>Use proxy server for LAN</i> must be disabled .
JavaScript	JavaScript must be enabled.  If JavaScript cannot be enabled: enter <code>http://XXX.XXX.X.XXX/basic.html</code> in the address line of the Web browser, e.g. <code>http://192.168.1.212/basic.html</code> . A fully functional but simplified version of the operating menu structure starts in the Web browser.

Measuring device

Web server	Web server must be enabled; factory setting: ON
IP address	If the IP address of the device is not known, communication with the Web server can be established via the standard IP address 192.168.1.212. The DHCP function is enabled in the device at the factory, i.e. the device expects an IP address to be assigned by the network. This function can be disabled and the device can be set to the standard IP address 192.168.1.212: set switch DIP switch No. 10 from OFF \rightarrow ON.

OFF ON

1 1
2 2
3 4
4 8
5 16
6 32
7 64
8 128

IP Address setting (last octet)

9 - Write protection
10 - Default Ethernet network settings IP 192.168.1.212

A0017965

i ■ Once the DIP switch has been activated, the device must be restarted before the device uses the standard IP address.
■ If the standard IP address (DIP switch No. 10 = ON) is used, there is no connection to the EtherNet/IP network.

8.2.3 Establishing a connection

Configuring the Internet protocol of the computer

The following information refers to the default Ethernet settings of the device.

IP address of the device: 192.168.1.212 (factory setting)

IP address	192.168.1.XXX; for XXX all numerical values except: 0, 212 and 255 → e.g. 192.168.1.213
Subnet mask	255.255.255.0
Default gateway	192.168.1.212 or leave cells empty

1. Switch on the measuring device and connect to the computer via the cable .
2. If a 2nd network card is not used: all the applications on the notebook should be closed, or all the applications that require the Internet or network, such as e-mail, SAP applications, Internet or Windows Explorer, i.e. close all open Internet browsers.
3. Configure the properties of the Internet protocol (TCP/IP) as defined in the table above.

Starting the Web browser

1. Enter the IP address of the Web server in the address line of the Web browser: 192.168.1.212
2. If the IP address of the measuring device is known, enter the defined device address in the address line of the Web browser. If it is unknown, set DIP switch No. 10 to ON, restart the device and enter the standard IP address: 192.168.1.212 (→ 47).

The login page appears.

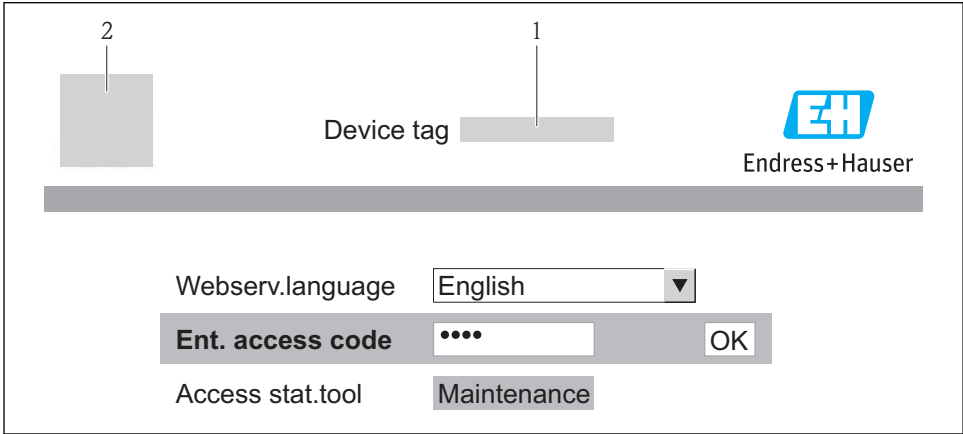

A0017362

- 1 Device tag
- 2 Picture of device

8.2.4 Logging on

Access code	0000 (factory setting); can be changed by customer
-------------	--

8.2.5 User interface

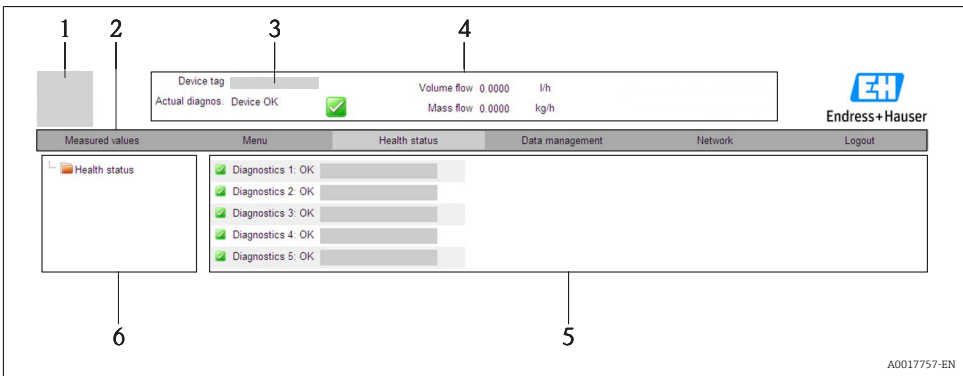

A0017757-EN

- 1 Picture of device
- 2 Function row with 6 functions
- 3 Device tag
- 4 Header
- 5 Working area
- 6 Navigation area

Header

The following information appears in the header:

- Device tag
- Device status with status signal
- Current measured values

Function row

Functions	Meaning
Measured values	The measured values of the device are displayed
Menu	Access to the operating menu structure of the device, same as for the operating tool
Device status	Displays the diagnostic messages currently pending, listed in order of priority
Data management	<ul style="list-style-type: none"> ■ Data exchange between PC and measuring device: <ul style="list-style-type: none"> – Upload the configuration from the device (XML format, create configuration back-up) – Save the configuration to the device (XML format, restore configuration) – Export the event list (.csv file) – Export parameter settings (.csv file, create documentation of the measuring point configuration) – Export the Heartbeat verification log (PDF file, only available with the "Heartbeat Verification" application package) ■ Upload the device driver for system integration from the device
Network configuration	Configuration and checking of all the parameters required for establishing the connection to the device: <ul style="list-style-type: none"> ■ Network settings (e.g. IP address, MAC address) ■ Device information (e.g. serial number, firmware version)
Logout	End the operation and call up the login page

8.3 Access to the operating menu via the operating tool



For detailed information about access to the operating menu via operating tool, refer to the Operating Instructions for the device .

9 System integration



For detailed information on system integration, see the Operating Instructions for the device.



Applies only to device version with EtherNet/IP communication type





A detailed description of how to integrate the device into an automation system (e.g. from Rockwell Automation) is available as a separate document: www.endress.com → Select country → Automation → Digital Communication → Feldbus device integration → EtherNet/IP

9.1 Cyclic data transmission

Cyclic data transmission when using the device master file (GSD).

9.1.1 Block model

The block model shows which input and output data the measuring device makes available for cyclic data exchange. Cyclic data exchange takes place with a PROFIBUS master (Class 1), e.g. a control system etc.

Measuring device				Control system
Transducer Block	Analog Input block 1 to 8 (→  50)	Output value AI	→	PROFIBUS DP
		Output value TOTAL	→	
	Totalizer block 1 to 3 (→  51)	Controller SETTOT	←	
		Configuration MODETOT	←	
	Analog Output block 1 to 3 (→  52)	Input values AO	←	
	Discrete Input block 1 to 2 (→  53)	Output values DI	→	
	Discrete Output block 1 to 3 (→  53)	Input values DO	←	

Defined order of modules

The modules are permanently assigned to the slots, i.e. when configuring the modules, the order and the arrangement of the modules must be respected.

Slot	Module	Function block
1 to 8	AI	Analog Input block 1 to 8
9	TOTAL or SETTOT_TOTAL or SETTOT_MODETOT_TOTAL	Totalizer block 1
10		Totalizer block 2
11		Totalizer block 3
12 to 14	AO	Analog Output block 1 to 3
15 to 16	DI	Discrete Input block 1 to 2
17 to 19	DO	Discrete Output block 1 to 3

To optimize the data throughput rate of the PROFIBUS network, it is advisable to only configure modules that are processed in the PROFIBUS master system. Any resulting gaps between the configured modules must be assigned to the EMPTY_MODULE.

9.1.2 Description of the modules



The data structure is described from the perspective of the PROFIBUS master:

- Input data: Are sent from the measuring device to the PROFIBUS master.
- Output data: Are sent from the PROFIBUS master to the measuring device.

AI module (Analog Input)

Transmit an input variable from the measuring device to the PROFIBUS master (Class 1).

Selection: input variable

The input variable can be specified using the CHANNEL parameter.

CHANNEL	Input variable	CHANNEL	Input variable
32961	Mass flow	901	Target fluid mass flow ¹⁾
33122	Volume flow	793	Carrier mass flow
33093	Corrected volume flow	794	Concentration
708	Flow velocity	33092	Reference density
32850	Density	33101	Temperature
1042	Electronics temperature	263	Carrier tube temperature ²⁾

- 1) Only available with the "Concentration" application package
 2) Only available with the "Heartbeat Verification" application package

Factory setting

Function block	Factory setting	Function block	Factory setting
AI 1	Mass flow	AI 5	Reference density
AI 2	Volume flow	AI 6	Temperature
AI 3	Corrected volume flow	AI 7	Off
AI 4	Density	AI 8	Off

TOTAL module

Transmit a totalizer value from the measuring device to the PROFIBUS master (Class 1).

Selection: totalizer value

The totalizer value can be specified using the CHANNEL parameter.

CHANNEL	Input variable	CHANNEL	Input variable
32961	Mass flow	901	Target fluid mass flow ¹⁾
33122	Volume flow	793	Carrier mass flow
33093	Corrected volume flow		

- 1) Only available with the "Concentration" application package

Factory setting

Function block	Factory setting: TOTAL
Totalizer 1, 2 and 3	Mass flow

SETTOT_TOTAL module

The module combination consists of the SETTOT and TOTAL functions:

- SETTOT: Control the totalizers via the PROFIBUS master.
- TOTAL: Transmit the totalizer value along with the status to the PROFIBUS master.

Selection: control totalizer

CHANNEL	Value SETTOT	Control totalizer
33310	0	Totalize
33046	1	Resetting
33308	2	Adopt totalizer initial setting

Factory setting

Function block	Factory setting: Value SETTOT (meaning)
Totalizer 1, 2 and 3	0 (totalizing)

SETTOT_MODETOT_TOTAL module

The module combination consists of the SETTOT, MODETOT and TOTAL functions:

- SETTOT: Control the totalizers via the PROFIBUS master.
- MODETOT: Configure the totalizers via the PROFIBUS master.
- TOTAL: Transmit the totalizer value along with the status to the PROFIBUS master.

Selection: totalizer configuration

CHANNEL	MODETOT value	Totalizer configuration
33306	0	Balancing
33028	1	Balance the positive flow
32976	2	Balance the negative flow
32928	3	Stop totalizing

Factory setting

Function block	Factory setting: Value MODETOT (meaning)
Totalizer 1, 2 and 3	0 (balancing)

AO module (Analog Output)

Transmit a compensation value from the PROFIBUS master (Class 1) to the measuring device.

Assigned compensation values

A compensation value is permanently assigned to the individual Analog Output blocks.

CHANNEL	Function block	Compensation value
306	AO 1	External pressure ¹⁾
307	AO 2	External temperature ¹⁾
488	AO 3	External reference density

1) The compensation variables must be transmitted to the device in the SI basic unit



The selection is made via: "Expert" menu → Sensor → External compensation

DI module (Discrete Input)

Transmit discrete input values from the measuring device to the PROFIBUS master (Class 1).

Selection: device function

The device function can be specified using the CHANNEL parameter.

CHANNEL	Device function	Factory setting: state (meaning)
894	Empty pipe detection	<ul style="list-style-type: none"> ■ 0 (device function not active) ■ 1 (device function active)
895	Low flow cut off	
1430	Status verification ¹⁾	

1) Only available with the "Heartbeat Verification" application package

Factory setting

Function block	Factory setting	Function block	Factory setting
DI 1	Empty pipe detection	DI 2	Low flow cut off

DO module (Discrete Output)

Transmit discrete output values from the PROFIBUS master (Class 1) to the measuring device.

Assigned device functions

A device function is permanently assigned to the individual Discrete Output blocks.

CHANNEL	Function block	Device function	Values: control (meaning)
891	DO 1	Flow override	<ul style="list-style-type: none"> ▪ 0 (disable device function) ▪ 1 (enable device function)
890	DO 2	Zero point adjustment	
1429	DO 3	Start verification ¹⁾	

1) Only available with the "Heartbeat Verification" application package



EMPTY_MODULE module

This module is used to assign empty spaces arising from modules not being used in the slots (→  50).

10 Commissioning

10.1 Function check

Before commissioning the device, make sure that the post-installation and post-connection checks have been performed.

- "Post-installation check" checklist (→  22)
- "Post-connection check" checklist (→  44)

10.2 Establishing a connection via FieldCare

 For detailed information on establishing a connection via FieldCare, see the Operating Instructions for the device.

10.3 Configuring the device address via software

In the "Communication" submenu the device address can be set.

Navigation

"Setup" menu → Communication → Device address

10.3.1 Ethernet network and Web server

When delivered, the measuring device has the following factory settings:

IP address	192.168.1.212
Subnet mask	255.255.255.0
Default gateway	192.168.1.212



- If hardware addressing is active, software addressing is disabled.
- If a switch is made to hardware addressing, the address configured via software addressing is retained for the first 9 places (the first three octets).



If the IP address of the device is not known, the device address currently configured can be read out: Operating Instructions for the device

10.3.2 PROFIBUS network

At time of delivery, the measuring device has the following factory setting:

Device address	126
----------------	-----



If hardware addressing is active, software addressing is blocked (→ 38)

10.4 Configuring the measuring device

The **Setup** menu with its submenus is used for fast commissioning of the measuring device. The submenus contain all the parameters required for configuration, such as parameters for measurement or communication.



The submenus available in the particular device can vary on account of the device version (e.g. communication method).

Submenu	Meaning
System units	Set the units of all the measured values
Medium selection	Define the medium
Communication	Configure the digital communication interface
Low flow cut off	Set the low flow cut off
Partially filled pipe detection	Configure partial and empty pipe detection

10.5 Protecting settings from unauthorized access

The following options exist for protecting the configuration of the measuring device from unintentional modification after commissioning:

- Write protection via access code for Web browser
- Write protection via write protection switch



For detailed information on protecting the settings against unauthorized access, see the Operating Instructions for the device.

11 Diagnostic information

Any faults detected by the measuring device are displayed on the home page of the operating tool once the connection has been established and on the home page of the web browser once the user has logged on.

Remedial measures are provided for each diagnostic event to ensure that problems can be rectified quickly.

- Web browser: Remedial measures are displayed in red on the home page next to the diagnostic event.
- FieldCare: Remedial measures are displayed on the home page in a separate field below the diagnostic event.

www.addresses.endress.com
