

# Operating Instructions

## Proline Promass A 100

### HART

Coriolis flowmeter

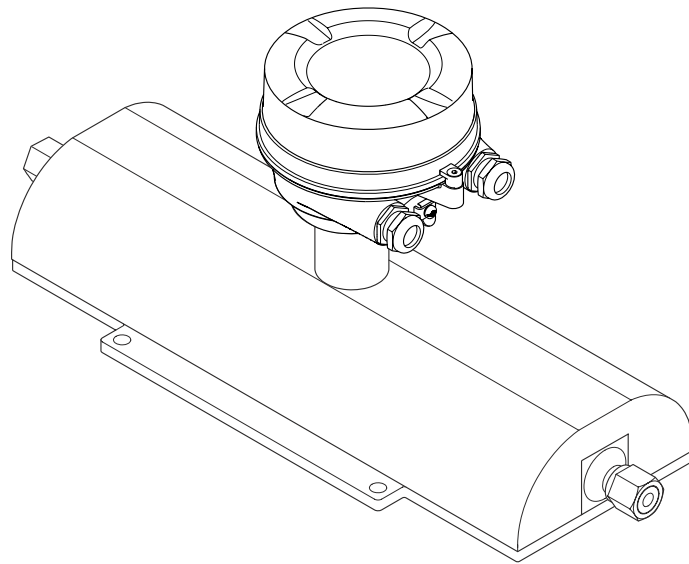

- Make sure the document is stored in a safe place such that it is always available when working on or with the device.
- To avoid danger to individuals or the facility, read the "Basic safety instructions" section carefully, as well as all other safety instructions in the document that are specific to working procedures.
- The manufacturer reserves the right to modify technical data without prior notice. Your Endress+Hauser Sales Center will supply you with current information and updates to these Instructions.

## Table of contents

<b>1</b>	<b>Document information</b> . . . . .	<b>5</b>	6.3	Post-installation check . . . . .	25
1.1	Document function . . . . .	5	<b>7</b>	<b>Electrical connection</b> . . . . .	<b>27</b>
1.2	Symbols used . . . . .	5	7.1	Connection conditions . . . . .	27
1.2.1	Safety symbols . . . . .	5	7.1.1	Required tools . . . . .	27
1.2.2	Electrical symbols . . . . .	5	7.1.2	Requirements for connecting cable . . .	27
1.2.3	Tool symbols . . . . .	6	7.1.3	Terminal assignment . . . . .	28
1.2.4	Symbols for certain types of information . . . . .	6	7.1.4	Pin assignment, device plug . . . . .	29
1.2.5	Symbols in graphics . . . . .	6	7.1.5	Preparing the measuring device . . . . .	29
1.3	Documentation . . . . .	7	7.2	Connecting the measuring device . . . . .	29
1.3.1	Standard documentation . . . . .	7	7.2.1	Connecting the transmitter . . . . .	29
1.3.2	Supplementary device-dependent documentation . . . . .	7	7.3	Special connection instructions . . . . .	31
1.4	Registered trademarks . . . . .	7	7.3.1	Connection examples . . . . .	31
<b>2</b>	<b>Basic safety instructions</b> . . . . .	<b>8</b>	7.4	Ensuring the degree of protection . . . . .	31
2.1	Requirements for the personnel . . . . .	8	7.5	Post-connection check . . . . .	31
2.2	Designated use . . . . .	8	<b>8</b>	<b>Operation options</b> . . . . .	<b>33</b>
2.3	Workplace safety . . . . .	9	8.1	Overview of operation options . . . . .	33
2.4	Operational safety . . . . .	9	8.2	Structure and function of the operating menu . . . . .	34
2.5	Product safety . . . . .	9	8.2.1	Structure of the operating menu . . . . .	34
2.6	IT security . . . . .	9	8.2.2	Operating philosophy . . . . .	35
<b>3</b>	<b>Product description</b> . . . . .	<b>11</b>	8.3	Access to the operating menu via the Web browser . . . . .	35
3.1	Product design . . . . .	11	8.3.1	Function range . . . . .	35
3.1.1	Device version with HART communication type . . . . .	11	8.3.2	Prerequisites . . . . .	36
<b>4</b>	<b>Incoming acceptance and product identification</b> . . . . .	<b>12</b>	8.3.3	Establishing a connection . . . . .	36
4.1	Incoming acceptance . . . . .	12	8.3.4	Logging on . . . . .	37
4.2	Product identification . . . . .	12	8.3.5	User interface . . . . .	37
4.2.1	Transmitter nameplate . . . . .	13	8.3.6	Disabling the Web server . . . . .	38
4.2.2	Sensor nameplate . . . . .	14	8.3.7	Logging out . . . . .	39
4.2.3	Symbols on measuring device . . . . .	15	8.4	Access to the operating menu via the operating tool . . . . .	39
<b>5</b>	<b>Storage and transport</b> . . . . .	<b>16</b>	8.4.1	Connecting the operating tool . . . . .	39
5.1	Storage conditions . . . . .	16	8.4.2	Field Xpert SFX350, SFX370 . . . . .	40
5.2	Transporting the product . . . . .	16	8.4.3	FieldCare . . . . .	40
5.3	Packaging disposal . . . . .	17	8.4.4	AMS Device Manager . . . . .	42
<b>6</b>	<b>Installation</b> . . . . .	<b>18</b>	8.4.5	SIMATIC PDM . . . . .	42
6.1	Installation conditions . . . . .	18	8.4.6	Field Communicator 475 . . . . .	43
6.1.1	Mounting position . . . . .	18	<b>9</b>	<b>System integration</b> . . . . .	<b>44</b>
6.1.2	Requirements from environment and process . . . . .	20	9.1	Overview of device description files . . . . .	44
6.1.3	Special mounting instructions . . . . .	22	9.1.1	Current version data for the device . . .	44
6.2	Mounting the measuring device . . . . .	25	9.1.2	Operating tools . . . . .	44
6.2.1	Required tools . . . . .	25	9.2	Measured variables via HART protocol . . . . .	44
6.2.2	Preparing the measuring device . . . . .	25	9.3	Other settings . . . . .	46
6.2.3	Mounting the measuring device . . . . .	25	9.3.1	Burst mode functionality in accordance with HART 7 Specification . . . . .	46
			<b>10</b>	<b>Commissioning</b> . . . . .	<b>49</b>
			10.1	Function check . . . . .	49

10.2	Configuring the measuring device . . . . .	49	12.11	Firmware history . . . . .	90
10.2.1	Defining the tag name . . . . .	49	<b>13</b>	<b>Maintenance . . . . .</b>	<b>91</b>
10.2.2	Setting the system units . . . . .	49	13.1	Maintenance tasks . . . . .	91
10.2.3	Selecting and setting the medium . . . . .	52	13.1.1	Exterior cleaning . . . . .	91
10.2.4	Configuring the current output . . . . .	53	13.1.2	Interior cleaning . . . . .	91
10.2.5	Configuring the pulse/frequency/ switch output . . . . .	55	13.2	Measuring and test equipment . . . . .	91
10.2.6	Configuring the local display . . . . .	59	13.3	Endress+Hauser services . . . . .	91
10.2.7	Configuring the HART input . . . . .	60	<b>14</b>	<b>Repair . . . . .</b>	<b>92</b>
10.2.8	Configuring the output conditioning . . . . .	61	14.1	General notes . . . . .	92
10.2.9	Configuring the low flow cut off . . . . .	64	14.2	Spare parts . . . . .	92
10.2.10	Configuring the partial filled pipe detection . . . . .	65	14.3	Endress+Hauser services . . . . .	92
10.3	Advanced settings . . . . .	66	14.4	Return . . . . .	92
10.3.1	Calculated values . . . . .	66	14.5	Disposal . . . . .	92
10.3.2	Carrying out a sensor adjustment . . . . .	67	14.5.1	Removing the measuring device . . . . .	92
10.3.3	Configuring the totalizer . . . . .	68	14.5.2	Disposing of the measuring device . . . . .	93
10.3.4	Carrying out additional display configurations . . . . .	69	<b>15</b>	<b>Accessories . . . . .</b>	<b>94</b>
10.4	Simulation . . . . .	71	15.1	Device-specific accessories . . . . .	94
10.5	Protecting settings from unauthorized access . . . . .	73	15.1.1	For the sensor . . . . .	94
10.5.1	Write protection via access code . . . . .	73	15.2	Communication-specific accessories . . . . .	94
10.5.2	Write protection via write protection switch . . . . .	74	15.3	Service-specific accessories . . . . .	95
<b>11</b>	<b>Operation . . . . .</b>	<b>75</b>	15.4	System components . . . . .	95
11.1	Reading device locking status . . . . .	75	<b>16</b>	<b>Technical data . . . . .</b>	<b>96</b>
11.2	Configuring the display . . . . .	75	16.1	Application . . . . .	96
11.3	Reading measured values . . . . .	75	16.2	Function and system design . . . . .	96
11.3.1	Process variables . . . . .	75	16.3	Input . . . . .	96
11.3.2	Totalizer . . . . .	76	16.4	Output . . . . .	97
11.3.3	Output values . . . . .	76	16.5	Power supply . . . . .	100
11.4	Adapting the measuring device to the process conditions . . . . .	77	16.6	Performance characteristics . . . . .	101
11.5	Performing a totalizer reset . . . . .	77	16.7	Installation . . . . .	104
<b>12</b>	<b>Diagnostics and troubleshooting . . . . .</b>	<b>79</b>	16.8	Environment . . . . .	104
12.1	General troubleshooting . . . . .	79	16.9	Process . . . . .	105
12.2	Diagnostic information via light emitting diodes . . . . .	80	16.10	Mechanical construction . . . . .	107
12.2.1	Transmitter . . . . .	80	16.11	Operability . . . . .	109
12.3	Diagnostic information in FieldCare . . . . .	80	16.12	Certificates and approvals . . . . .	112
12.3.1	Diagnostic options . . . . .	80	16.13	Application packages . . . . .	113
12.3.2	Calling up remedy information . . . . .	81	16.14	Accessories . . . . .	113
12.4	Adapting the diagnostic information . . . . .	82	16.15	Documentation . . . . .	114
12.4.1	Adapting the diagnostic behavior . . . . .	82	<b>17</b>	<b>Appendix . . . . .</b>	<b>115</b>
12.4.2	Adapting the status signal . . . . .	82	17.1	Overview of the operating menu . . . . .	115
12.5	Overview of diagnostic information . . . . .	82	17.1.1	Main menu . . . . .	115
12.6	Pending diagnostic events . . . . .	85	17.1.2	"Operation" menu . . . . .	115
12.7	Diagnostic list . . . . .	86	17.1.3	"Setup" menu . . . . .	115
12.8	Event logbook . . . . .	86	17.1.4	"Diagnostics" menu . . . . .	120
12.8.1	Event history . . . . .	86	17.1.5	"Expert" menu . . . . .	123
12.8.2	Filtering the event logbook . . . . .	87	<b>Index . . . . .</b>	<b>138</b>	
12.8.3	Overview of information events . . . . .	87			
12.9	Resetting the measuring device . . . . .	88			
12.10	Device information . . . . .	88			





# 1 Document information

## 1.1 Document function







These Operating Instructions contain all the information that is required in various phases of the life cycle of the device: from product identification, incoming acceptance and storage, to mounting, connection, operation and commissioning through to troubleshooting, maintenance and disposal.

## 1.2 Symbols used



### 1.2.1 Safety symbols

Symbol	Meaning
	<b>DANGER!</b> This symbol alerts you to a dangerous situation. Failure to avoid this situation will result in serious or fatal injury.
	<b>WARNING!</b> This symbol alerts you to a dangerous situation. Failure to avoid this situation can result in serious or fatal injury.
	<b>CAUTION!</b> This symbol alerts you to a dangerous situation. Failure to avoid this situation can result in minor or medium injury.
	<b>NOTE!</b> This symbol contains information on procedures and other facts which do not result in personal injury.











### 1.2.2 Electrical symbols

Symbol	Meaning
	<b>Direct current</b> A terminal to which DC voltage is applied or through which direct current flows.
	<b>Alternating current</b> A terminal to which alternating voltage is applied or through which alternating current flows.
	<b>Direct current and alternating current</b> <ul style="list-style-type: none"> <li>▪ A terminal to which alternating voltage or DC voltage is applied.</li> <li>▪ A terminal through which alternating current or direct current flows.</li> </ul>
	<b>Ground connection</b> A grounded terminal which, as far as the operator is concerned, is grounded via a grounding system.
	<b>Protective ground connection</b> A terminal which must be connected to ground prior to establishing any other connections.
	<b>Equipotential connection</b> A connection that has to be connected to the plant grounding system: This may be a potential equalization line or a star grounding system depending on national or company codes of practice.





### 1.2.3 Tool symbols

Symbol	Meaning
	Allen key
	Open-ended wrench



### 1.2.4 Symbols for certain types of information

Symbol	Meaning
	<b>Permitted</b> Indicates procedures, processes or actions that are permitted.
	<b>Preferred</b> Indicates procedures, processes or actions that are preferred.
	<b>Forbidden</b> Indicates procedures, processes or actions that are forbidden.
	<b>Tip</b> Indicates additional information.
	<b>Reference to documentation</b> Refers to the corresponding device documentation.
	<b>Reference to page</b> Refers to the corresponding page number.
	<b>Reference to graphic</b> Refers to the corresponding graphic number and page number.
	<b>Series of steps</b>
	<b>Result of a sequence of actions</b>
	<b>Help in the event of a problem</b>
	<b>Visual inspection</b>

### 1.2.5 Symbols in graphics

Symbol	Meaning
<b>1, 2, 3,...</b>	Item numbers
	Series of steps
<b>A, B, C, ...</b>	Views
<b>A-A, B-B, C-C, ...</b>	Sections
	Flow direction
	<b>Hazardous area</b> Indicates a hazardous area.
	<b>Safe area (non-hazardous area)</b> Indicates the non-hazardous area.

## 1.3 Documentation

-  For an overview of the scope of the associated Technical Documentation, refer to the following:
- The CD-ROM provided for the device (depending on the device version, the CD-ROM might not be part of the delivery!)
  - The *W@M Device Viewer* : Enter the serial number from the nameplate ([www.endress.com/deviceviewer](http://www.endress.com/deviceviewer))
  - The *Endress+Hauser Operations App*: Enter the serial number from the nameplate or scan the 2-D matrix code (QR code) on the nameplate.
-  For a detailed list of the individual documents along with the documentation code (→  114)

### 1.3.1 Standard documentation

Document type	Purpose and content of the document
Technical Information	<b>Planning aid for your device</b> The document contains all the technical data on the device and provides an overview of the accessories and other products that can be ordered for the device.
Brief Operating Instructions	<b>Guide that takes you quickly to the 1st measured value</b> The Brief Operating Instructions contain all the essential information from incoming acceptance to initial commissioning.

### 1.3.2 Supplementary device-dependent documentation

Additional documents are supplied depending on the device version ordered: Always comply strictly with the instructions in the supplementary documentation. The supplementary documentation is an integral part of the device documentation.

## 1.4 Registered trademarks

### HART®

Registered trademark of the HART Communication Foundation, Austin, USA

### Microsoft®

Registered trademark of the Microsoft Corporation, Redmond, Washington, USA

### TRI-CLAMP®

Registered trademark of Ladish & Co., Inc., Kenosha, USA

### SWAGELOK®

Registered trademark of Swagelok & Co., Solon, USA

### Applicator®, FieldCare®, Field Xpert™, HistoROM®, Heartbeat Technology™

Registered or registration-pending trademarks of the Endress+Hauser Group

## 2 Basic safety instructions

### 2.1 Requirements for the personnel

The personnel for installation, commissioning, diagnostics and maintenance must fulfill the following requirements:

- ▶ Trained, qualified specialists must have a relevant qualification for this specific function and task
- ▶ Are authorized by the plant owner/operator
- ▶ Are familiar with federal/national regulations
- ▶ Before beginning work, the specialist staff must have read and understood the instructions in the Operating Instructions and supplementary documentation as well as in the certificates (depending on the application)
- ▶ Following instructions and basic conditions

The operating personnel must fulfill the following requirements:

- ▶ Being instructed and authorized according to the requirements of the task by the facility's owner-operator
- ▶ Following the instructions in these Operating Instructions

### 2.2 Designated use

#### Application and media

The measuring device described in these Instructions is intended only for flow measurement of liquids and gases.

Depending on the version ordered, the measuring device can also measure potentially explosive, flammable, poisonous and oxidizing media.

Measuring devices for use in hazardous areas, in hygienic applications or in applications where there is an increased risk due to process pressure, are labeled accordingly on the nameplate.

To ensure that the measuring device remains in proper condition for the operation time:

- ▶ Only use the measuring device in full compliance with the data on the nameplate and the general conditions listed in the Operating Instructions and supplementary documentation.
- ▶ Based on the nameplate, check whether the ordered device is permitted for the intended use in the hazardous area (e.g. explosion protection, pressure vessel safety).
- ▶ Use the measuring device only for media against which the process-wetted materials are adequately resistant.
- ▶ If the measuring device is not operated at atmospheric temperature, compliance with the relevant basic conditions specified in the associated device documentation is absolutely essential: "Documentation" section (→  7).

#### Incorrect use

Non-designated use can compromise safety. The manufacturer is not liable for damage caused by improper or non-designated use.

#### **WARNING**

#### **Danger of breakage of the measuring tube due to corrosive or abrasive fluids.**

Housing breakage due to mechanical overload possible!

- ▶ Verify the compatibility of the process fluid with the measuring tube material.
- ▶ Ensure the resistance of all fluid-wetted materials in the process.
- ▶ Observe the specified pressure and temperature range.

Verification for borderline cases:

- ▶ For special fluids and fluids for cleaning, Endress+Hauser is glad to provide assistance in verifying the corrosion resistance of fluid-wetted materials, but does not accept any



warranty or liability as minute changes in the temperature, concentration or level of contamination in the process can alter the corrosion resistance properties.

#### **Residual risks**

The external surface temperature of the housing can increase by max. 20 K due to the power consumption of the electronic components. Hot process fluids passing through the measuring device will further increase the surface temperature of the housing. The surface of the sensor, in particular, can reach temperatures which are close to the fluid temperature.

Possible burn hazard due to fluid temperatures!

- ▶ For elevated fluid temperature, ensure protection against contact to prevent burns.

## **2.3 Workplace safety**

For work on and with the device:

- ▶ Wear the required personal protective equipment according to federal/national regulations.

For welding work on the piping:

- ▶ Do not ground the welding unit via the measuring device.

If working on and with the device with wet hands:

- ▶ It is recommended to wear gloves on account of the higher risk of electric shock.

## **2.4 Operational safety**

Risk of injury.

- ▶ Operate the device in proper technical condition and fail-safe condition only.
- ▶ The operator is responsible for interference-free operation of the device.

#### **Conversions to the device**

Unauthorized modifications to the device are not permitted and can lead to unforeseeable dangers.

- ▶ If, despite this, modifications are required, consult with Endress+Hauser.

#### **Repair**

To ensure continued operational safety and reliability,

- ▶ Carry out repairs on the device only if they are expressly permitted.
- ▶ Observe federal/national regulations pertaining to repair of an electrical device.
- ▶ Use original spare parts and accessories from Endress+Hauser only.

## **2.5 Product safety**

This measuring device is designed in accordance with good engineering practice to meet state-of-the-art safety requirements, has been tested, and left the factory in a condition in which it is safe to operate.

It meets general safety standards and legal requirements. It also complies with the EC directives listed in the device-specific EC Declaration of Conformity. Endress+Hauser confirms this by affixing the CE mark to the device.

## **2.6 IT security**

We only provide a warranty if the device is installed and used as described in the Operating Instructions. The device is equipped with security mechanisms to protect it against any inadvertent changes to the device settings.

IT security measures in line with operators' security standards and designed to provide additional protection for the device and device data transfer must be implemented by the operators themselves.

## 3 Product description

### 3.1 Product design

#### 3.1.1 Device version with HART communication type

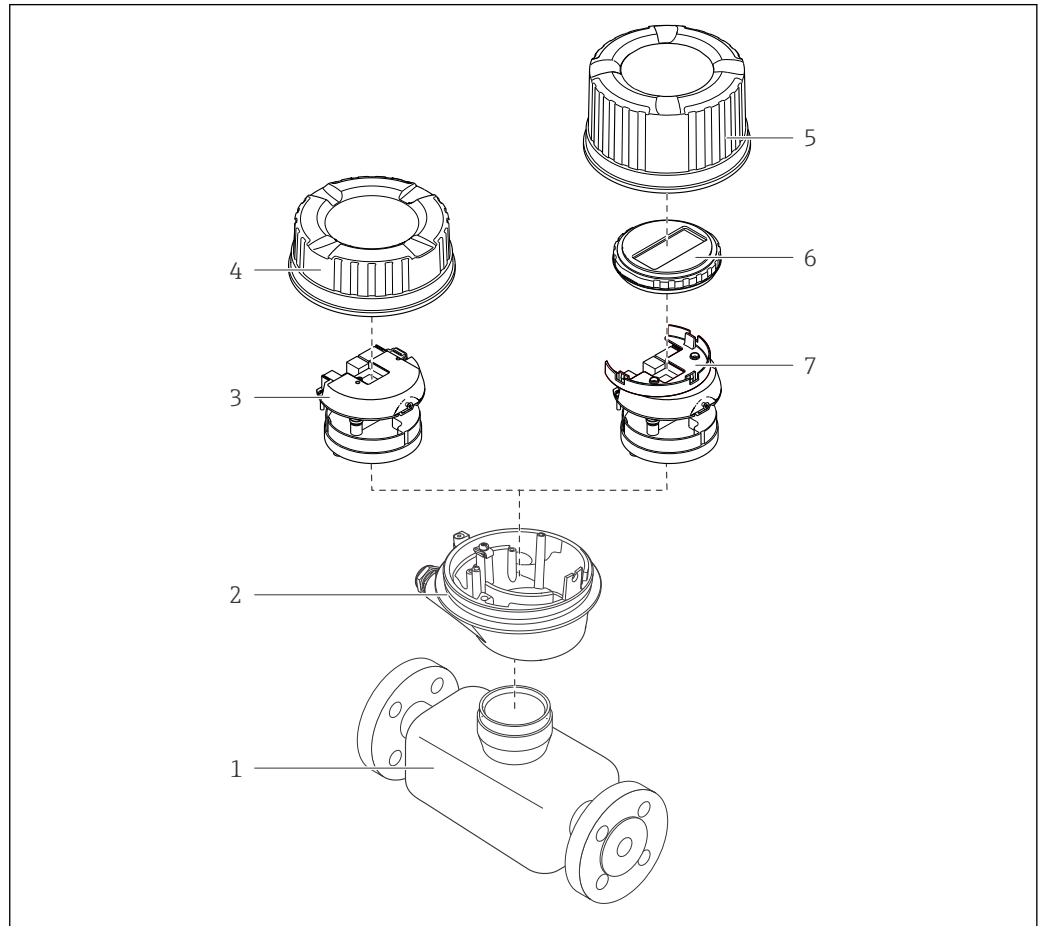





A0023153

#### 1 Important components of a measuring device

- 1 Sensor
- 2 Transmitter housing
- 3 Main electronics module
- 4 Transmitter housing cover
- 5 Transmitter housing cover (version for optional onsite display)
- 6 Onsite display (optional)
- 7 Main electronics module (with bracket for optional onsite display)

## 4 Incoming acceptance and product identification

### 4.1 Incoming acceptance





    

1  
+  
2

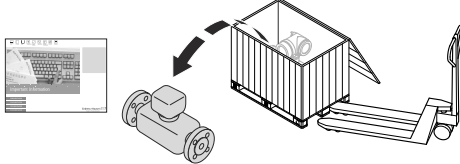

1  
+  
2

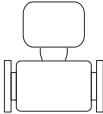
Are the order codes on the delivery note (1) and the product sticker (2) identical?

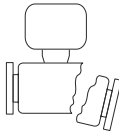



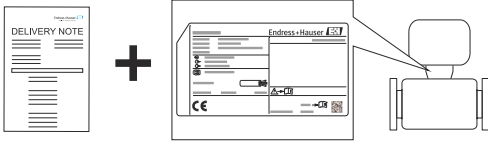

Are the goods undamaged?

Do the nameplate data match the ordering information on the delivery note?

Is the CD-ROM with the Technical Documentation (depends on device version) and documents present?



-  If one of the conditions is not satisfied, contact your Endress+Hauser Sales Center.
- Depending on the device version, the CD-ROM might not be part of the delivery! In such cases, the technical documentation is available via the Internet or via the *Endress+Hauser Operations App*, see the "Product identification" section (→  13).

### 4.2 Product identification

The following options are available for identification of the measuring device:

- Nameplate specifications
- Order code with breakdown of the device features on the delivery note
- Enter serial numbers from nameplates in *W@M Device Viewer* ([www.endress.com/deviceviewer](http://www.endress.com/deviceviewer)): All information about the measuring device is displayed.
- Enter the serial number from the nameplates into the *Endress+Hauser Operations App* or scan the 2-D matrix code (QR code) on the nameplate with the *Endress+Hauser Operations App*: all the information for the measuring device is displayed.

For an overview of the scope of the associated Technical Documentation, refer to the following:

- The chapters "Additional standard documentation on the device" (→  7) and "Supplementary device-dependent documentation" (→  7)
- The *W@M Device Viewer*: Enter the serial number from the nameplate ([www.endress.com/deviceviewer](http://www.endress.com/deviceviewer))
- The *Endress+Hauser Operations App*: Enter the serial number from the nameplate or scan the 2-D matrix code (QR code) on the nameplate.

### 4.2.1 Transmitter nameplate

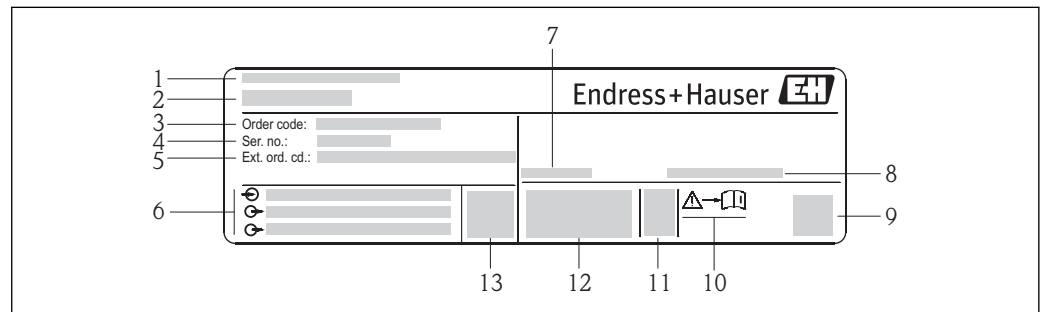

A0017520

 2 Example of a transmitter nameplate

- 1 Manufacturing location
- 2 Name of the transmitter
- 3 Order code
- 4 Serial number
- 5 Extended order code
- 6 Electrical connection data, e.g. available inputs and outputs, supply voltage
- 7 Permitted ambient temperature range ( $T_a$ )
- 8 Degree of protection
- 9 2-D matrix code
- 10 Document number of safety-related supplementary documentation (→  114)
- 11 Manufacturing date: year-month
- 12 CE mark, C-Tick
- 13 Firmware version (FW)

## 4.2.2 Sensor nameplate

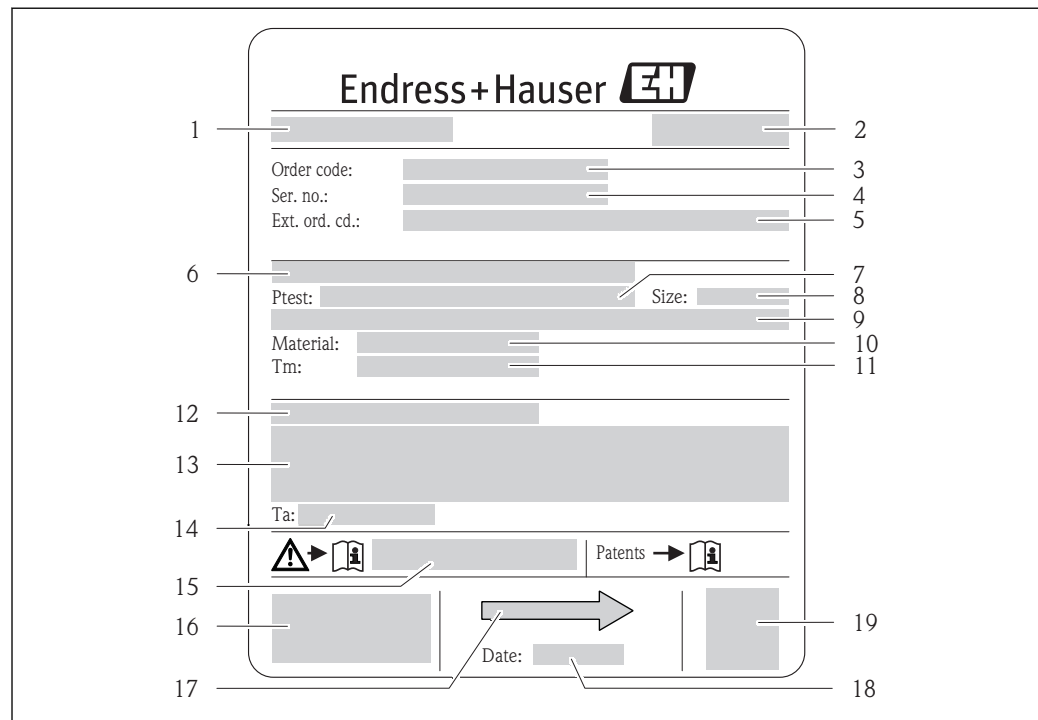

A0017923

 3 Example of a sensor nameplate

- 1 Name of the sensor
- 2 Manufacturing location
- 3 Order code
- 4 Serial number (Ser. no.)
- 5 Extended order code (Ext. ord. cd.)
- 6 Flange nominal diameter/nominal pressure
- 7 Test pressure of the sensor
- 8 Nominal diameter of sensor
- 9 Sensor-specific data: e.g. pressure range of secondary containment, wide-range density specification (special density calibration)
- 10 Material of measuring tube and manifold
- 11 Fluid temperature range
- 12 Degree of protection
- 13 Approval information for explosion protection and Pressure Equipment Directive
- 14 Permitted ambient temperature (T<sub>a</sub>)
- 15 Document number of safety-related supplementary documentation (→  114)
- 16 CE mark, C-Tick
- 17 Flow direction
- 18 Manufacturing date: year-month
- 19 2-D matrix code



### Order code

The measuring device is reordered using the order code.

#### Extended order code

- The device type (product root) and basic specifications (mandatory features) are always listed.
- Of the optional specifications (optional features), only the safety and approval-related specifications are listed (e.g. LA). If other optional specifications are also ordered, these are indicated collectively using the # placeholder symbol (e.g. #LA#).
- If the ordered optional specifications do not include any safety and approval-related specifications, they are indicated by the + placeholder symbol (e.g. XXXXXX-ABCDE +).

### 4.2.3 Symbols on measuring device

Symbol	Meaning
	<b>WARNING!</b> This symbol alerts you to a dangerous situation. Failure to avoid this situation can result in serious or fatal injury.
 A0011194	<b>Reference to documentation</b> Refers to the corresponding device documentation.
 A0011199	<b>Protective ground connection</b> A terminal which must be connected to ground prior to establishing any other connections.

## 5 Storage and transport

### 5.1 Storage conditions

Observe the following notes for storage:

- Store in the original packaging to ensure protection from shock.
- Do not remove protective covers or protective caps installed on process connections. They prevent mechanical damage to the sealing surfaces and fouling in the measuring tube.
- Protect from direct sunlight to avoid unacceptably high surface temperatures.
- Storage temperature:  $-40$  to  $+80$  °C ( $-40$  to  $+176$  °F), preferable for  $+20$  °C ( $+68$  °F)
- Store in a dry and dust-free place.
- Do not store outdoors.

### 5.2 Transporting the product

#### **⚠ WARNING**

**Center of gravity of the measuring device is higher than the suspension points of the webbing slings.**

Risk of injury if the measuring device slips.

- ▶ Secure the measuring device from rotating or slipping.
- ▶ Observe the weight specified on the packaging (stick-on label).
- ▶ Observe the transport instructions on the stick-on label on the electronics compartment cover.

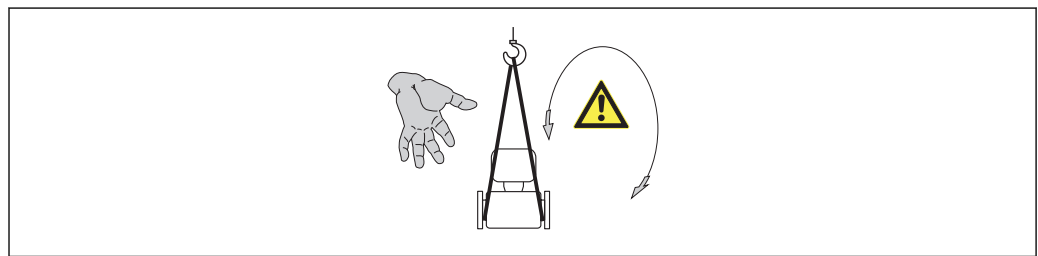

A0015606

Observe the following notes during transport:

- Transport the measuring device to the measuring point in the original packaging.
- Lifting gear
  - Webbing slings: Do not use chains, as they could damage the housing.
  - For wood crates, the floor structure enables these to be loaded lengthwise or broadside using a forklift.
- For measuring device > DN 40 (1½ in): lift the measuring device using the webbing slings at the process connections; do not lift at the transmitter housing.
- Do not remove protective covers or protective caps installed on process connections. They prevent mechanical damage to the sealing surfaces and contamination in the measuring tube.



### 5.3 Packaging disposal

All packaging materials are environmentally friendly and 100% recyclable:

- Measuring device secondary packaging: polymer stretch film that conforms to EC Directive 2002/95/EC (RoHS).
- Packaging:
  - Wood crate, treated in accordance with ISPM 15 standard, which is confirmed by the affixed IPPC logo.
  - or
  - Carton in accordance with European Packaging Directive 94/62EC; recyclability is confirmed by the affixed RESY symbol.
- Seaworthy packaging (optional): Wood crate, treated in accordance with ISPM 15 standard, which is confirmed by the affixed IPPC logo.
- Carrying and mounting hardware:
  - Disposable plastic pallet
  - Plastic straps
  - Plastic adhesive strips
- Dunnage: Paper cushion

## 6 Installation

### 6.1 Installation conditions

No special measures such as supports are necessary. External forces are absorbed by the construction of the device.

#### 6.1.1 Mounting position

##### Mounting location

To prevent measuring errors arising from accumulation of gas bubbles in the measuring tube, avoid the following mounting locations in the pipe:

- Highest point of a pipeline.
- Directly upstream of a free pipe outlet in a down pipe.

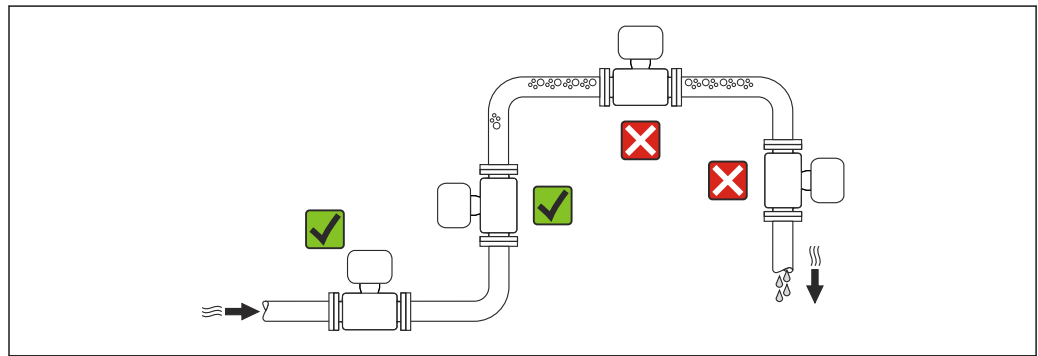

A0023344

##### Installation in down pipes

However, the following installation suggestion allows for installation in an open vertical pipeline. Pipe restrictions or the use of an orifice with a smaller cross-section than the nominal diameter prevent the sensor running empty while measurement is in progress.

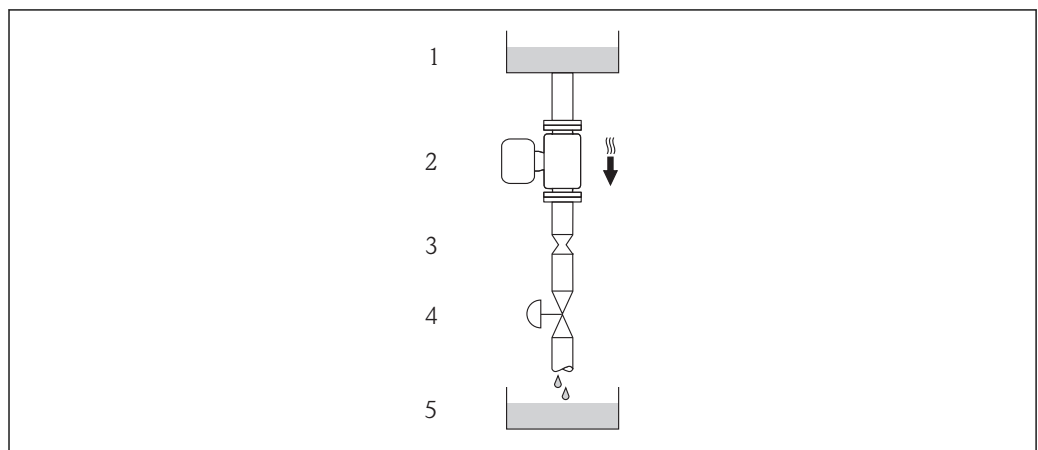

A0015596



4 Installation in a down pipe (e.g. for batching applications)

- 1 Supply tank
- 2 Sensor
- 3 Orifice plate, pipe restriction
- 4 Valve
- 5 Batching tank

DN		Ø orifice plate, pipe restriction	
[mm]	[in]	[mm]	[in]
1	1/24	0.8	0.03
2	1/12	1.5	0.06
4	1/6	3.0	0.12

**Orientation**

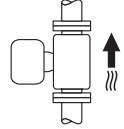
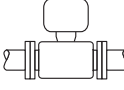
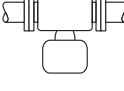
The direction of the arrow on the sensor nameplate helps you to install the sensor according to the flow direction (direction of medium flow through the piping).

Orientation		Recommendation	
<b>A</b>	Vertical orientation	 A0015591	☑☑
<b>B</b>	Horizontal orientation, transmitter head up	 A0015589	☑☑ <sup>1)</sup> Exception:
<b>C</b>	Horizontal orientation, transmitter head down	 A0015590	☑☑ <sup>2)</sup> Exception:
<b>D</b>	Horizontal orientation, transmitter head at side	 A0015592	☒

- 1) Applications with low process temperatures may reduce the ambient temperature. To maintain the minimum ambient temperature for the transmitter, this orientation is recommended.
- 2) Applications with high process temperatures may increase the ambient temperature. To maintain the maximum ambient temperature for the transmitter, this orientation is recommended.

**Inlet and outlet runs**

No special precautions need to be taken for fittings which create turbulence, such as valves, elbows or T-pieces, as long as no cavitation occurs (→ 20).



*Installation dimensions*

 For the dimensions and installation lengths of the device, see the "Technical Information" document, "Mechanical construction" section

## 6.1.2 Requirements from environment and process

### Ambient temperature range

Measuring device	Non-Ex	-40 to +60 °C (-40 to +140 °F)
	Ex na, NI version	-40 to +60 °C (-40 to +140 °F)
	Ex ia, IS version	<ul style="list-style-type: none"> <li>▪ -40 to +60 °C (-40 to +140 °F)</li> <li>▪ -50 to +60 °C (-58 to +140 °F) (Order code for "Test, certificate", option JM)</li> </ul>
Local display		-20 to +60 °C (-4 to +140 °F) The readability of the display may be impaired at temperatures outside the temperature range.

- ▶ If operating outdoors:  
Avoid direct sunlight, particularly in warm climatic regions.

### System pressure

It is important that cavitation does not occur, or that gases entrained in the liquids do not outgas.

Cavitation is caused if the pressure drops below the vapor pressure:

- In liquids that have a low boiling point (e.g. hydrocarbons, solvents, liquefied gases)
  - In suction lines
- ▶ Ensure the system pressure is sufficiently high to prevent cavitation and outgassing.

For this reason, the following mounting locations are recommended:

- At the lowest point in a vertical pipe
- Downstream from pumps (no danger of vacuum)

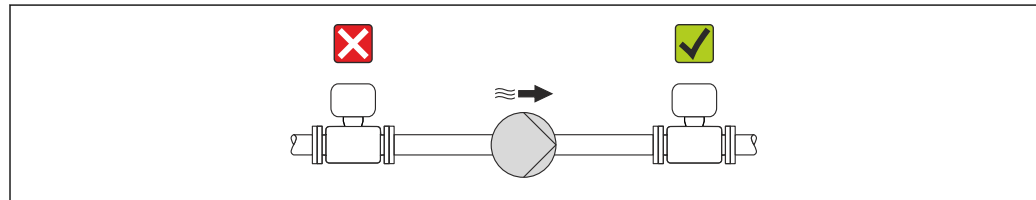

A0015594

### Thermal insulation

In the case of some fluids, it is important that the heat radiated from the sensor to the transmitter is kept to a minimum. A wide range of materials can be used for the required insulation.

#### NOTICE

#### Electronics overheating on account of thermal insulation!

- ▶ Observe maximum permitted insulation height of the transmitter neck so that the transmitter head is completely free.

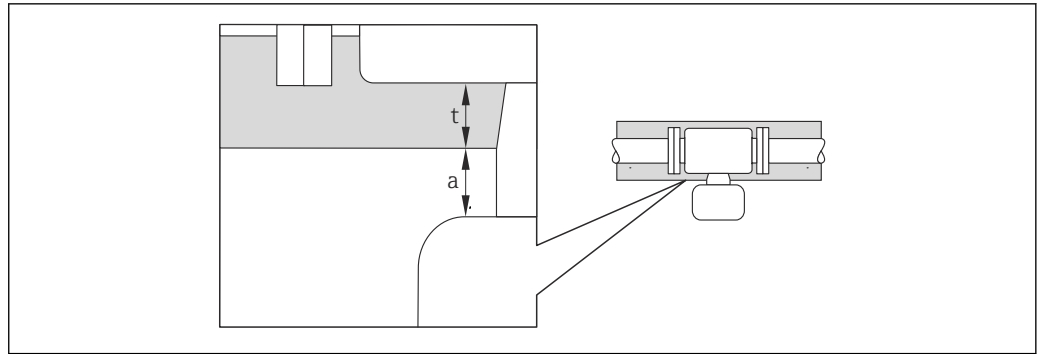

A0019919

*a* Minimum distance to insulation  
*t* Insulation thickness

The minimum distance between the transmitter housing and the insulation is 10 mm (0.39 in) so that the transmitter head remains completely exposed.

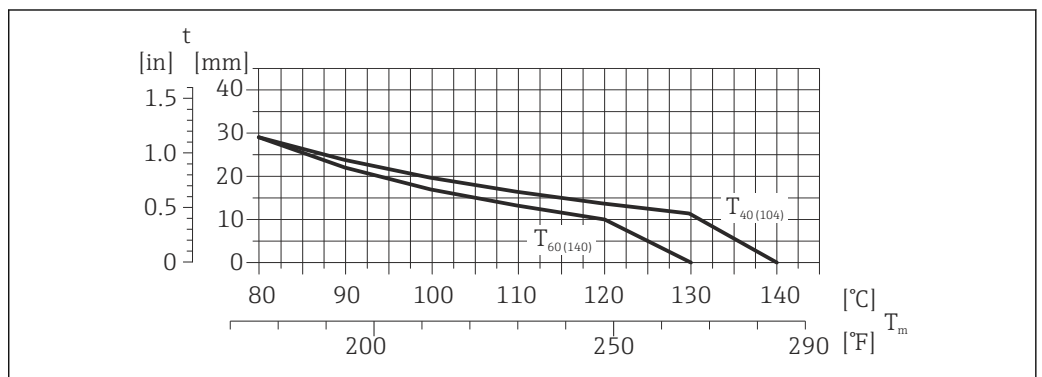

A0023173

5 Recommended insulation thicknesses depending on the medium and ambient temperature

- t* Insulation thickness
- $T_m$  Medium temperature
- $T_{40(104)}$  Insulation thickness with ambient temperature of  $T_a = 40^\circ\text{C}$  (104 °F)
- $T_{60(140)}$  Insulation thickness with ambient temperature of  $T_a = 60^\circ\text{C}$  (140 °F)

**NOTICE**

The insulation can also be thicker than the recommended insulation thickness.

Prerequisite:

- ▶ The temperature at the lower end of the transmitter housing does not exceed 80 °C (176 °F)
- ▶ Ensure that convection takes place on a sufficiently large scale at the transmitter neck.
- ▶ Ensure that a sufficiently large area of the housing support remains exposed. The uncovered part serves as a radiator and protects the electronics from overheating and excessive cooling.

**Heating**

**NOTICE**

Electronics can overheat due to elevated ambient temperature!

- ▶ Observe maximum permitted ambient temperature for the transmitter (→ 20).
- ▶ Depending on the fluid temperature, take the device orientation requirements into account .

### Heating options

If a fluid requires that no heat loss should occur at the sensor, users can avail of the following heating options:

- Electrical heating, e.g. with electric band heaters
- Via pipes carrying hot water or steam
- Via heating jackets

### Using an electrical trace heating system

If heating is regulated via phase angle control or pulse packages, magnetic fields can affect the measured values (= for values that are greater than the values approved by the EN standard (sine 30 A/m)).

For this reason, the sensor must be magnetically shielded: the housing can be shielded with tin plates or electric sheets without a privileged direction (e.g. V330-35A).

The sheet must have the following properties:

- Relative magnetic permeability  $\mu_r \geq 300$
- Plate thickness  $d \geq 0.35$  mm ( $d \geq 0.014$  in)

### Vibrations

The high oscillation frequency of the measuring tubes ensures that the correct operation of the measuring system is not influenced by plant vibrations.

## 6.1.3 Special mounting instructions

### Rupture disk

Make sure that the function and operation of the rupture disk is not impeded through the installation of the device. The position of the rupture disk is indicated on a sticker beside it. For additional information that is relevant to the process ( $\rightarrow$  106).

The existing connecting nozzles are not designed for a rinse or pressure monitoring function.

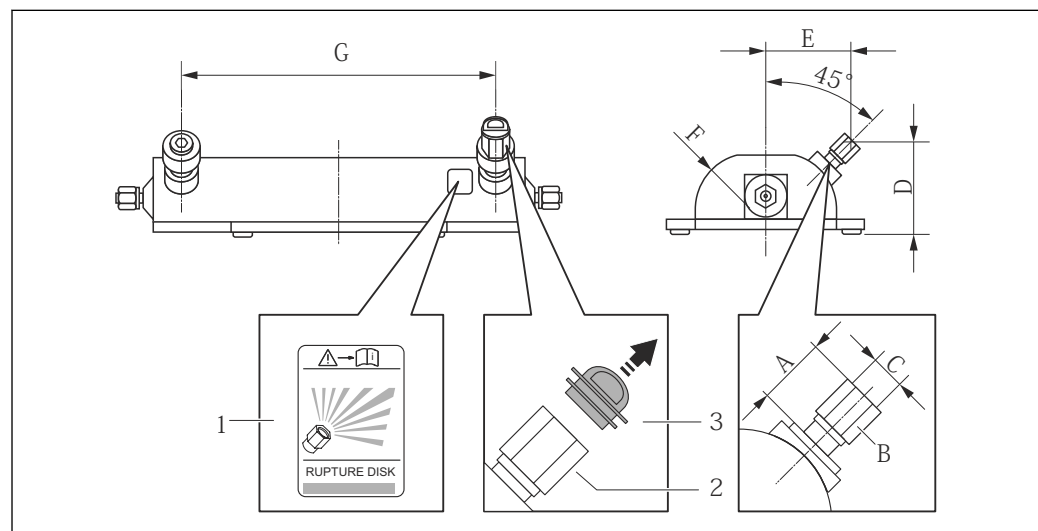

- 1 Rupture disk label
- 2 Rupture disk with 1/2" NPT internal thread with 1" width across flat
- 3 Transport protection

A0019676

*Dimensions in SI units*

DN	A	B	C	D	E	F	G
[mm]	[mm]	[in]	[in]	[mm]	[mm]	[mm]	[mm]
1	Approx. 42	AF 1	½ NPT	77.0	70.0	47.0	178
2	Approx. 42	AF 1	½ NPT	77.0	70.0	47.0	260
4	Approx. 42	AF 1	½ NPT	83.0	83.0	59.5	385

*Dimensions in US units*

DN	A	B	C	D	E	F	G
[in]	[in]	[in]	[in]	[in]	[in]	[in]	[in]
¼	Approx. 1.65	AF 1	½ NPT	3.0	2.8	1.85	7.01
½	Approx. 1.65	AF 1	½ NPT	3.0	2.8	1.85	10.24
¾	Approx. 1.65	AF 1	½ NPT	3.3	3.2	2.34	15.16

**⚠ WARNING****Limited functional reliability of the rupture disk.**

Danger to persons from escaping fluids!

- ▶ Do not remove the rupture disk.
- ▶ When using a rupture disk, do not use a heating jacket.
- ▶ Make sure that the function and operation of the rupture disk is not impeded through the installation of the device.
- ▶ Take precautions to prevent damage and danger to persons if the rupture disk is actuated.
- ▶ Observe information on the rupture disk sticker.

**Wall mounting****⚠ WARNING****Incorrect sensor mounting**

Risk of injury if measuring tube breaks

- ▶ The sensor should never be installed in a pipe in a way that it is freely suspended
- ▶ Using the base plate, mount the sensor directly on the floor, wall or ceiling.
- ▶ Support the sensor on a securely mounted support base (e.g. angle bracket).

The following mounting versions are recommended for the installation.

**Vertical**

- Mounted directly on a wall using the base plate, or
- Device supported on an angle bracket mounted on the wall

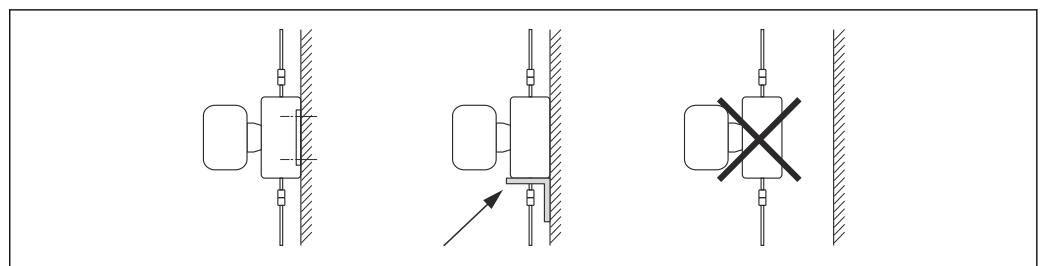

A0019631

### Horizontal

Device standing on a solid support base

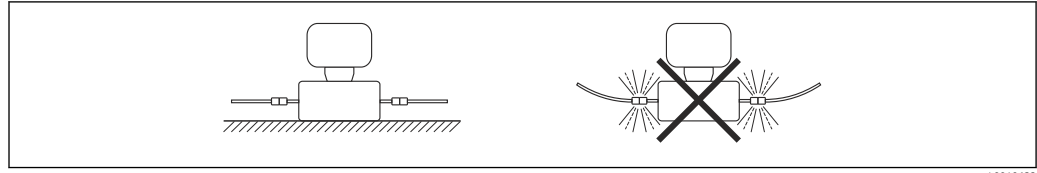

A0019632

### Post retainer

The post retainer mounting kit is used to secure the device to a pipe or post (order code for "Accessories", option PR).

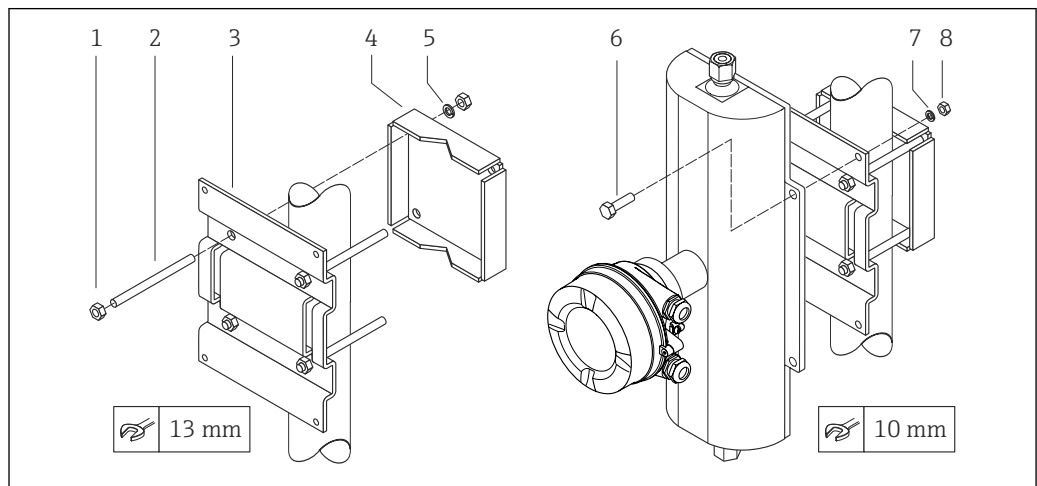

A0019746

#### 6 Post retainer mounting kit

- 1 8 x hexagonal nut M8 × 0.8
- 2 4 x threaded bolt M8 × 150
- 3 1 x post retaining plate
- 4 1 x post securing plate
- 5 4 x spring washer M8
- 6 4 x hexagon bolt M6 × 20
- 7 4 x spring washer M6
- 8 4 x hexagonal nut M6 × 0.8

### Zero point adjustment

All measuring devices are calibrated in accordance with state-of-the-art technology. Calibration takes place under reference conditions (→ 101). Therefore, a zero point adjustment in the field is generally not required.

Experience shows that zero point adjustment is advisable only in special cases:

- To achieve maximum measuring accuracy even with low flow rates
- Under extreme process or operating conditions (e.g. very high process temperatures or very high-viscosity fluids).



## 6.2 Mounting the measuring device

### 6.2.1 Required tools

**For sensor**

For flanges and other process connections: Corresponding mounting tools

### 6.2.2 Preparing the measuring device

1. Remove all remaining transport packaging.
2. Remove any protective covers or protective caps present from the sensor.
3. Remove stick-on label on the electronics compartment cover.

### 6.2.3 Mounting the measuring device

**⚠ WARNING**

**Danger due to improper process sealing!**

- ▶ Ensure that the inside diameters of the gaskets are greater than or equal to that of the process connections and piping.
- ▶ Ensure that the gaskets are clean and undamaged.
- ▶ Install the gaskets correctly.

1. Ensure that the direction of the arrow on the nameplate of the sensor matches the flow direction of the fluid.
2. Install the measuring device or turn the transmitter housing so that the cable entries do not point upwards.

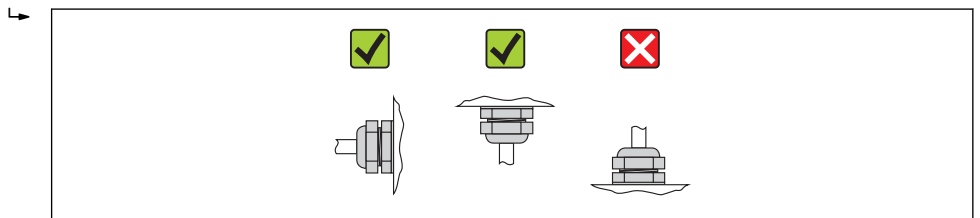

A0013964

## 6.3 Post-installation check

Is the device undamaged (visual inspection)?	<input type="checkbox"/>
Does the measuring device conform to the measuring point specifications? For example: <ul style="list-style-type: none"> <li>▪ Process temperature (→ 105)</li> <li>▪ Process pressure (refer to the chapter on "Pressure-temperature ratings" of the "Technical Information" document)</li> <li>▪ Ambient temperature (→ 20)</li> <li>▪ Measuring range (→ 96)</li> </ul>	<input type="checkbox"/>
Has the correct orientation for the sensor been selected ? <ul style="list-style-type: none"> <li>▪ According to sensor type</li> <li>▪ According to medium temperature</li> <li>▪ According to medium properties (outgassing, with entrained solids)</li> </ul>	<input type="checkbox"/>
Does the arrow on the sensor nameplate match the direction of flow of the fluid through the piping (→ 19)?	<input type="checkbox"/>
Are the measuring point identification and labeling correct (visual inspection)?	<input type="checkbox"/>

Is the device adequately protected from precipitation and direct sunlight?	<input type="checkbox"/>
Are the securing screw and securing clamp tightened securely?	<input type="checkbox"/>

## 7 Electrical connection

 The measuring device does not have an internal circuit breaker. For this reason, assign the measuring device a switch or power-circuit breaker so that the power supply line can be easily disconnected from the mains.

### 7.1 Connection conditions

#### 7.1.1 Required tools

- For cable entries: Use corresponding tools
- For securing clamp (on aluminum housing): Allen screw 3 mm
- For securing screw (for stainless steel housing): open-ended wrench 8 mm
- Wire stripper
- When using stranded cables: crimping tool for ferrule

#### 7.1.2 Requirements for connecting cable

The connecting cables provided by the customer must fulfill the following requirements.

##### Electrical safety

In accordance with applicable federal/national regulations.

##### Permitted temperature range

- $-40\text{ °C}$  ( $-40\text{ °F}$ ) to  $+80\text{ °C}$  ( $+176\text{ °F}$ )
- Minimum requirement: cable temperature range  $\geq$  ambient temperature  $+20\text{ K}$

##### Power supply cable

Standard installation cable is sufficient.

##### Signal cable

###### *Current output*

For 4-20 mA HART: Shielded cable recommended. Observe grounding concept of the plant.

###### *Pulse/frequency/switch output*

Standard installation cable is sufficient.

##### Cable diameter

- Cable glands supplied:  
M20  $\times$  1.5 with cable  $\phi$  6 to 12 mm (0.24 to 0.47 in)
- Spring terminals:  
Wire cross-sections 0.5 to 2.5 mm<sup>2</sup> (20 to 14 AWG)

### 7.1.3 Terminal assignment

#### Transmitter

Connection version 4-20 mA HART with pulse/frequency/switch output

Order code for "Output", option B

Depending on the housing version, the transmitters can be ordered with terminals or device plugs.

Order code for "Housing"	Connection methods available		Possible options for order code "Electrical connection"
	Outputs	Power supply	
Options A, B	Terminals	Terminals	<ul style="list-style-type: none"> <li>▪ Option A: coupling M20x1</li> <li>▪ Option B: thread M20x1</li> <li>▪ Option C: thread G ½"</li> <li>▪ Option D: thread NPT ½"</li> </ul>
Options A, B	Device plug	Terminals	<ul style="list-style-type: none"> <li>▪ Option L: plug M12x1 + thread NPT ½"</li> <li>▪ Option N: plug M12x1 + coupling M20</li> <li>▪ Option P: plug M12x1 + thread G ½"</li> <li>▪ Option U: plug M12x1 + thread M20</li> </ul>
Options A, B, C	Device plug	Device plug	Option Q: 2 x plug M12x1

Order code for "Housing":

- Option A: compact, coated aluminum
- Option B: compact, hygienic, stainless
- Option C: ultra compact, hygienic, stainless, M12 device plug

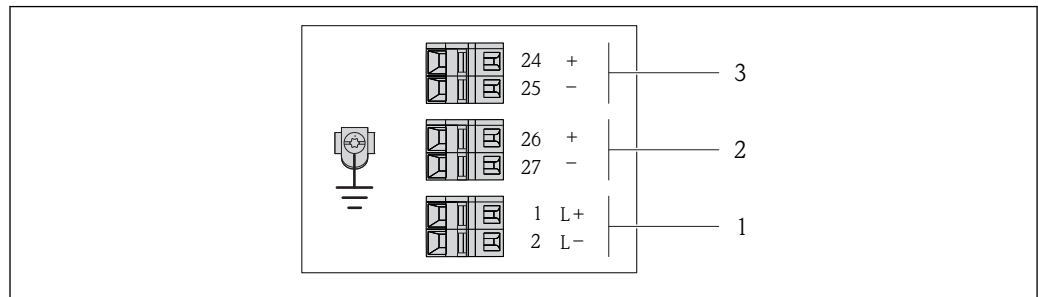

A0016888

7 Terminal assignment 4-20 mA HART with pulse/frequency/switch output

- 1 Power supply: DC 24 V
- 2 Output 1: 4-20 mA HART (active)
- 3 Output 2: pulse/frequency/switch output (passive)

Order code for "Output"	Terminal number					
	Power supply		Output 1		Output 2	
	2 (L-)	1 (L+)	27 (-)	26 (+)	25 (-)	24 (+)
Option B	DC 24 V		4-20 mA HART (active)		Pulse/frequency/switch output (passive)	

Order code for "Output":  
Option B: 4-20 mA HART with pulse/frequency/switch output

### 7.1.4 Pin assignment, device plug

#### 4-20 mA HART with pulse/frequency/switch output

Device plug for supply voltage (device side)

Pin	Assignment		Coding	Plug/socket
1	L+	DC24 V	A	Plug
2				
3				
4	L-	DC24 V		
5		Grounding/shielding		

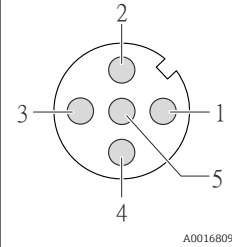

A0016809

Device plug for signal transmission (device side)

Pin	Assignment		Coding	Plug/socket
1	+	4-20 mA HART (active)	A	Socket
2	-	4-20 mA HART (active)		
3	+	Pulse/frequency/switch output (passive)		
4	-	Pulse/frequency/switch output (passive)		
5		Grounding/shielding		

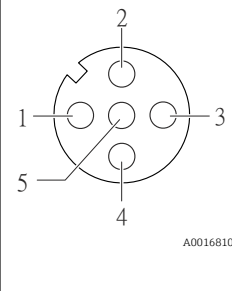

A0016810

### 7.1.5 Preparing the measuring device

1. Remove dummy plug if present.
2. **NOTICE!** Insufficient sealing of the housing! Operational reliability of the measuring device could be compromised. Use suitable cable glands corresponding to the degree of protection.  
If measuring device is delivered without cable glands:  
Provide suitable cable gland for corresponding connecting cable (→ 27).
3. If measuring device is delivered with cable glands:  
Observe cable specification (→ 27).

## 7.2 Connecting the measuring device

### NOTICE

#### Limitation of electrical safety due to incorrect connection!

- ▶ Have electrical connection work carried out by correspondingly trained specialists only.
- ▶ Observe applicable federal/national installation codes and regulations.
- ▶ Comply with local workplace safety regulations.
- ▶ For use in potentially explosive atmospheres, observe the information in the device-specific Ex documentation.

### 7.2.1 Connecting the transmitter

The connection of the transmitter depends on the following order codes:

- Housing version: compact or ultra-compact
- Connection version: device plug or terminals

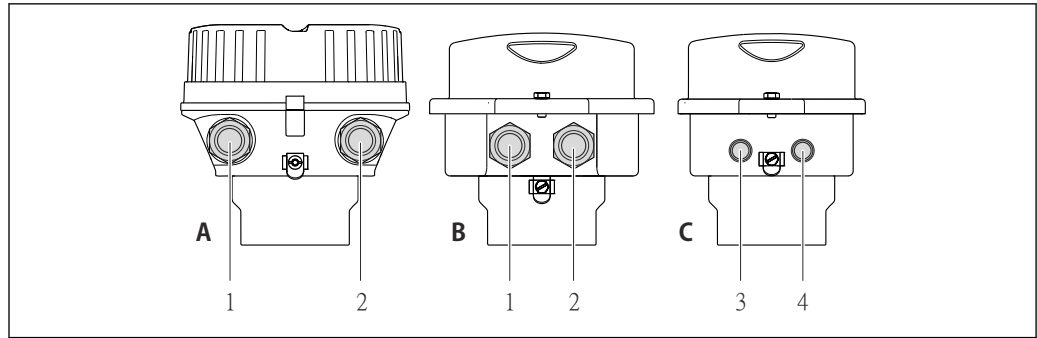

A0016924

8 Device versions and connection versions

- A Housing version: compact, aluminum coated
- B Housing version: compact hygienic, stainless
- 1 Cable entry or device plug for signal transmission
- 2 Cable entry or device plug for supply voltage
- C Housing version: ultra-compact hygienic, stainless, M12 device plug
- 3 Device plug for signal transmission
- 4 Device plug for supply voltage

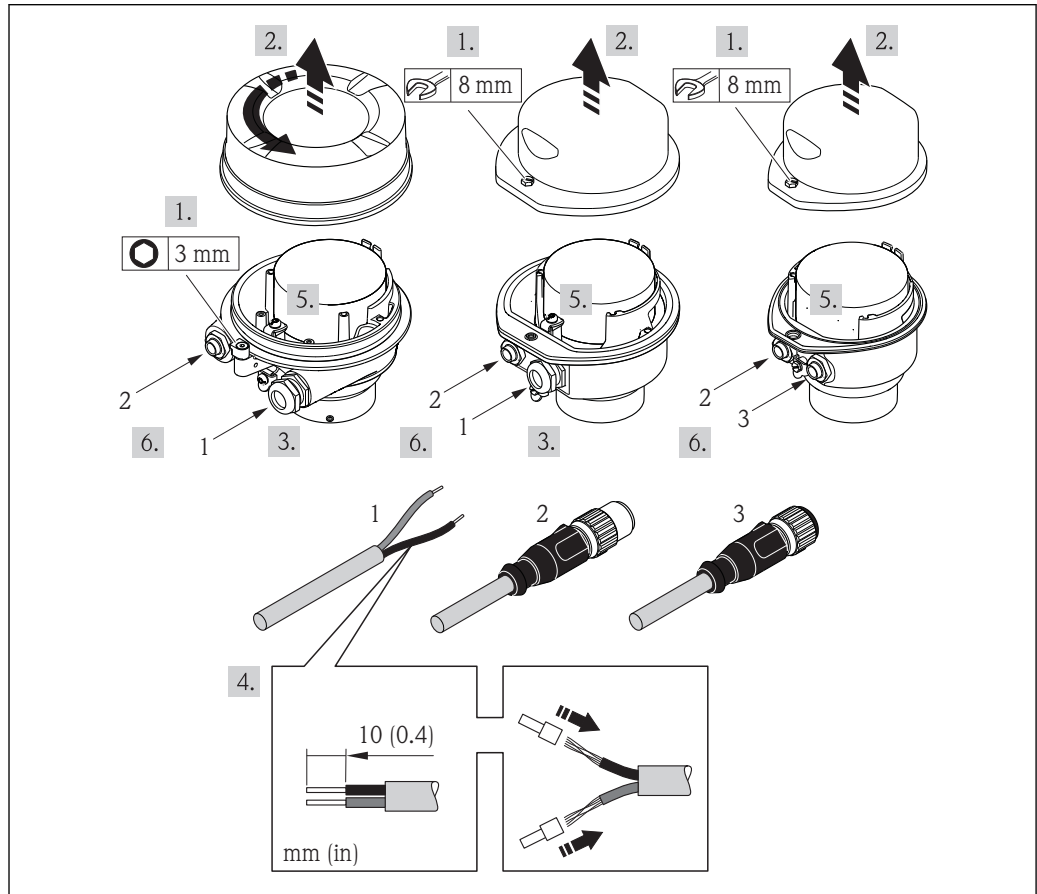

A0017844

9 Device versions with connection examples

- 1 Cable
- 2 Device plug for signal transmission
- 3 Device plug for supply voltage

For device version with device plug: only pay attention to Step 6.

- 1. Depending on the housing version, loosen the securing clamp or fixing screw of the housing cover.

2. Depending on the housing version, unscrew or open the housing cover and disconnect the local display from the main electronics module where necessary (→ ☰ 110).
3. Push the cable through the cable entry . To ensure tight sealing, do not remove the sealing ring from the cable entry.
4. Strip the cable and cable ends. In the case of stranded cables, also fit ferrules.
5. Connect the cable in accordance with the terminal assignment or the device plug pin assignment .
6. Depending on the device version: tighten the cable glands or plug in the device plug and tighten .
7. **WARNING!** Housing degree of protection may be voided due to insufficient sealing of the housing. Screw in the screw without using any lubricant. The threads on the cover are coated with a dry lubricant.  
Reverse the removal procedure to reassemble the transmitter.

### 7.3 Special connection instructions

#### 7.3.1 Connection examples

### 7.4 Ensuring the degree of protection

The measuring device fulfills all the requirements for the IP66/67 degree of protection, Type 4X enclosure.

To guarantee IP66/67 degree of protection, Type 4X enclosure, carry out the following steps after the electrical connection:

1. Check that the housing seals are clean and fitted correctly. Dry, clean or replace the seals if necessary.
2. Tighten all housing screws and screw covers.
3. Firmly tighten the cable glands.
4. To ensure that moisture does not enter the cable entry, route the cable so that it loops down before the cable entry ("water trap").

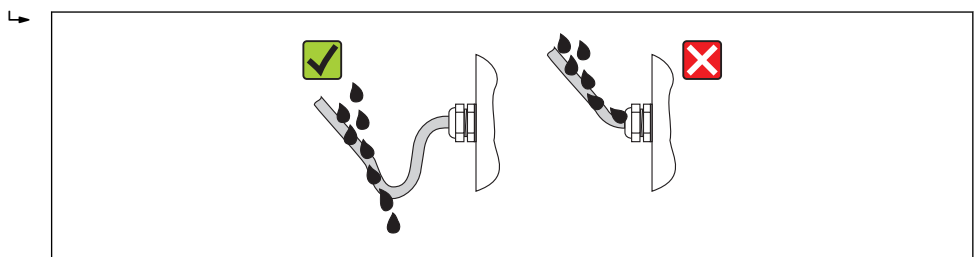



A0013960

5. Insert dummy plugs into unused cable entries.

### 7.5 Post-connection check

Are cables or the device undamaged (visual inspection)?	<input type="checkbox"/>
Do the cables comply with the requirements (→ ☰ 27)?	<input type="checkbox"/>
Do the cables have adequate strain relief?	<input type="checkbox"/>
Are all the cable glands installed, firmly tightened and leak-tight? Cable run with "water trap" (→ ☰ 31) ?	<input type="checkbox"/>

Depending on the device version: are all the device plugs firmly tightened (→  29)?	<input type="checkbox"/>
Does the supply voltage match the specifications on the transmitter nameplate (→  100)?	<input type="checkbox"/>
Is the terminal assignment or the pin assignment of the device plug correct?	<input type="checkbox"/>
If supply voltage is present, is the power LED on the electronics module of the transmitter lit green (→  11)?	<input type="checkbox"/>
Depending on the device version, is the securing clamp or fixing screw firmly tightened?	<input type="checkbox"/>



## 8 Operation options

### 8.1 Overview of operation options

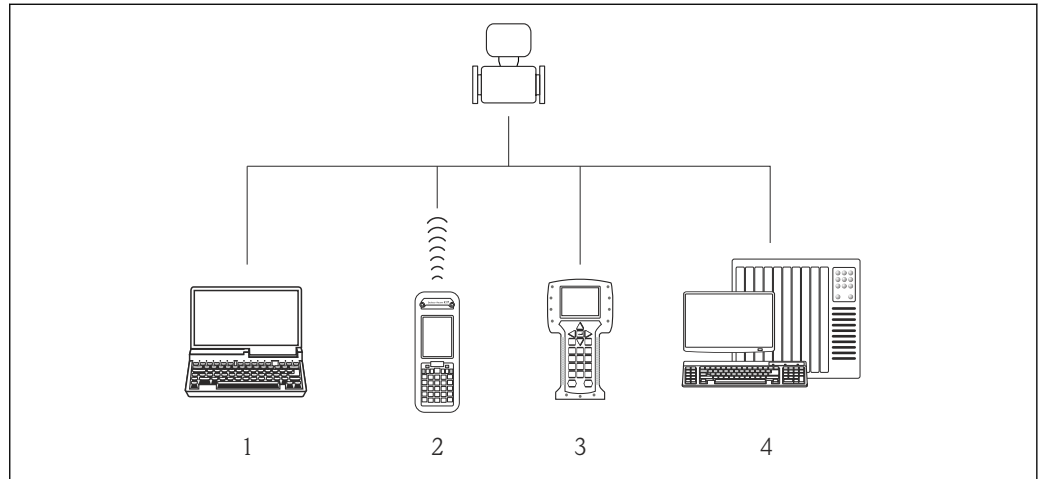



A0019598

- 1 Computer with Web browser (e.g. Internet Explorer) or with operating tool (e.g. FieldCare, AMS Device Manager, SIMATIC PDM)
- 2 Field Xpert SFX350 or SFX370
- 3 Field Communicator 475
- 4 Control system (e.g. PLC)

## 8.2 Structure and function of the operating menu

### 8.2.1 Structure of the operating menu

 For an overview of the operating menu with menus and parameters (→  115)

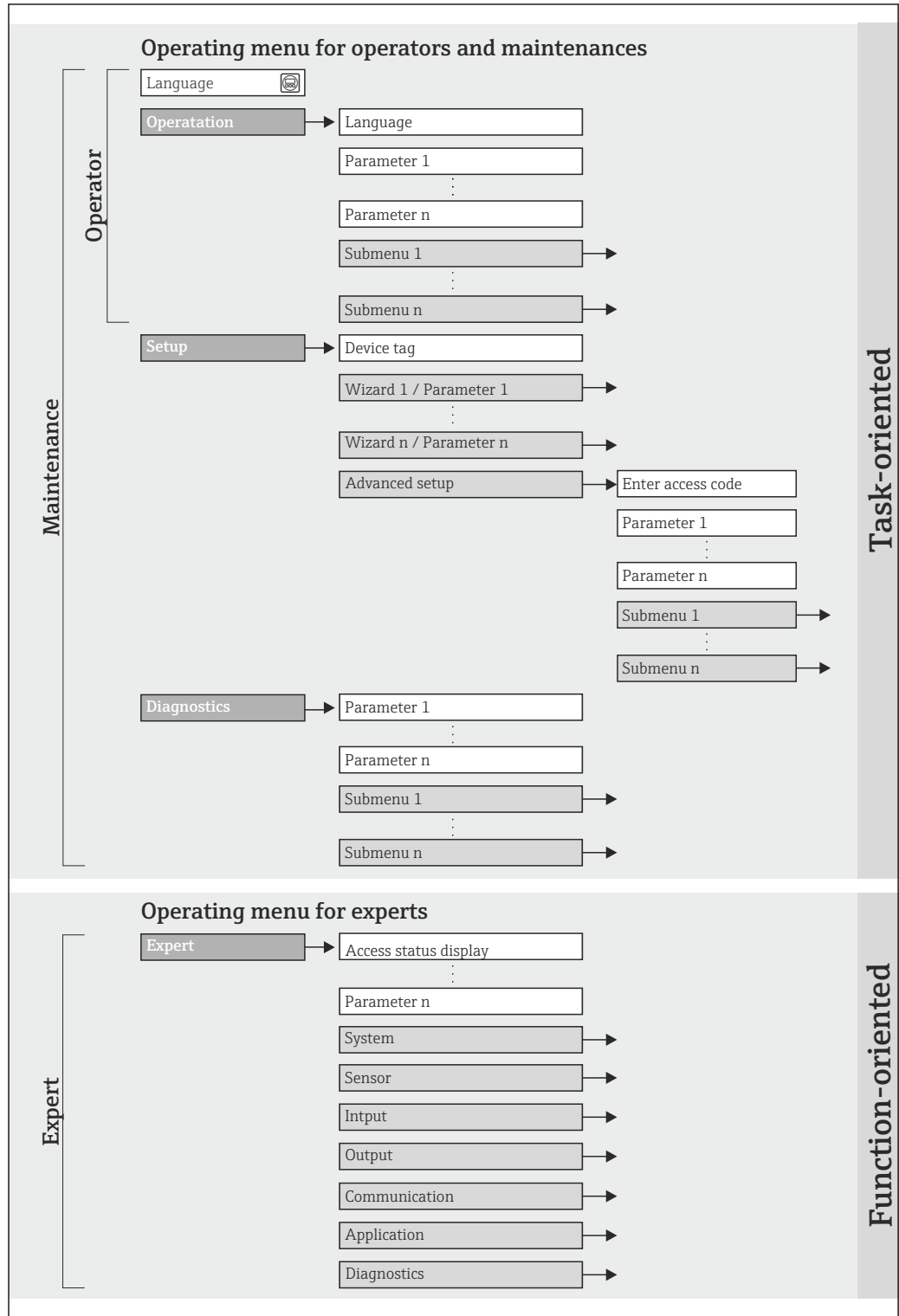

A0018237-EN

 10 Schematic structure of the operating menu

### 8.2.2 Operating philosophy

The individual parts of the operating menu are assigned to certain user roles. Each user role corresponds to typical tasks within the device lifecycle.

Menu		User role and tasks	Content/meaning
Language	task-oriented	<b>Role "Operator", "Maintenance"</b> Tasks during operation: <ul style="list-style-type: none"> <li>▪ Configuring the operational display</li> <li>▪ Reading measured values</li> </ul>	Defining the operating language
Operation			<ul style="list-style-type: none"> <li>▪ Configuring the operational display (e.g. display format, display contrast)</li> <li>▪ Resetting and controlling totalizers</li> </ul>
Setup		<b>"Maintenance" role</b> Commissioning: <ul style="list-style-type: none"> <li>▪ Configuration of the measurement</li> <li>▪ Configuration of the inputs and outputs</li> </ul>	<b>"Advanced setup" submenu:</b> <ul style="list-style-type: none"> <li>▪ For more customized configuration of the measurement (adaptation to special measuring conditions)</li> <li>▪ Configuration of totalizers</li> <li>▪ Administration (define access code, reset measuring device)</li> </ul>
Diagnostics		<b>"Maintenance" role</b> Fault elimination: <ul style="list-style-type: none"> <li>▪ Diagnostics and elimination of process and device errors</li> <li>▪ Measured value simulation</li> </ul>	Contains all parameters for error detection and analyzing process and device errors: <ul style="list-style-type: none"> <li>▪ <b>"Diagnostic list" submenu</b> Contains up to 5 currently pending diagnostic messages.</li> <li>▪ <b>"Event logbook" submenu</b> Contains up to 20 or 100 (order option "Extended HistoROM") event messages that have occurred.</li> <li>▪ <b>"Device information" submenu</b> Contains information for identifying the device.</li> <li>▪ <b>"Measured values" submenu</b> Contains all current measured values.</li> <li>▪ <b>"Data logging" submenu (order option "Extended HistoROM")</b> Storage and visualization of up to 1000 measured values</li> <li>▪ <b>"Heartbeat Technology" submenu</b> The functionality of the device is checked on demand and the verification results are documented.</li> <li>▪ <b>"Simulation" submenu</b> Is used to simulate measured values or output values.</li> </ul>
Expert	function-oriented	Tasks that require detailed knowledge of the function of the device: <ul style="list-style-type: none"> <li>▪ Commissioning measurements under difficult conditions</li> <li>▪ Optimal adaptation of the measurement to difficult conditions</li> <li>▪ Detailed configuration of the communication interface</li> <li>▪ Error diagnostics in difficult cases</li> </ul>	Contains all the parameters of the device and makes it possible to access these parameters directly using an access code. The structure of this menu is based on the function blocks of the device: <ul style="list-style-type: none"> <li>▪ <b>"System" submenu</b> Contains all higher-order device parameters that do not pertain either to measurement or the measured value communication.</li> <li>▪ <b>"Sensor" submenu</b> Configuration of the measurement.</li> <li>▪ <b>"Application" submenu</b> Configuration of the functions that go beyond the actual measurement (e.g. totalizer).</li> <li>▪ <b>"Diagnostics" submenu</b> Error detection and analysis of process and device errors and for device simulation and Heartbeat Technology.</li> </ul>



## 8.3 Access to the operating menu via the Web browser

### 8.3.1 Function range

Thanks to the integrated Web server the device can be operated and configured via a Web browser. In addition to the measured values, status information on the device is also displayed and allows the user to monitor the status of the device. Furthermore the device data can be managed and the network parameters can be configured.

### 8.3.2 Prerequisites

#### Hardware

Connecting cable	Standard Ethernet cable with RJ45 connector
Computer	RJ45 interface
Measuring device:	Web server must be enabled; factory setting: ON  For information on enabling the Web server (→  38)

#### Software of the computer

Web browsers supported	<ul style="list-style-type: none"> <li>▪ Microsoft Internet Explorer (min. 8.x)</li> <li>▪ Mozilla Firefox</li> <li>▪ Google chrome</li> </ul>
Recommended operating systems	<ul style="list-style-type: none"> <li>▪ Windows XP</li> <li>▪ Windows 7</li> </ul>
User rights for TCP/IP settings	User rights required for TCP/IP settings (e.g. for changes to IP address, subnet mask)
Computer configuration	<ul style="list-style-type: none"> <li>▪ JavaScript is enabled</li> <li>▪ If JavaScript cannot be enabled, enter http://XXX.XXX.X.XXX/basic.html in the address line of the Web browser, e.g. http://192.168.1.212/basic.html. A fully functional but simplified version of the operating menu structure starts in the Web browser.</li> </ul>

 When installing a new firmware version:  
 To enable correct data display, clear the temporary memory (cache) of the Web browser under **Internet options**.

### 8.3.3 Establishing a connection

#### Configuring the Internet protocol of the computer

The following information refers to the default Ethernet settings of the device.

IP address of the device: 192.168.1.212 (factory setting)

<b>IP address</b>	192.168.1.XXX; for XXX all numerical values except: 0, 212 and 255 → e.g. 192.168.1.213
<b>Subnet mask</b>	255.255.255.0
<b>Default gateway</b>	192.168.1.212 or leave cells empty

1. Switch on the measuring device and connect to the computer via the cable (→  40).
2. If a 2nd network card is not used: all the applications on the notebook should be closed, or all the applications that require the Internet or network, such as e-mail, SAP applications, Internet or Windows Explorer, i.e. close all open Internet browsers.
3. Configure the properties of the Internet protocol (TCP/IP) as defined in the table above.

#### Starting the Web browser

1. Start the Web browser on the computer.
2. Enter the IP address of the Web server in the address line of the Web browser: 192.168.1.212

The login page appears.

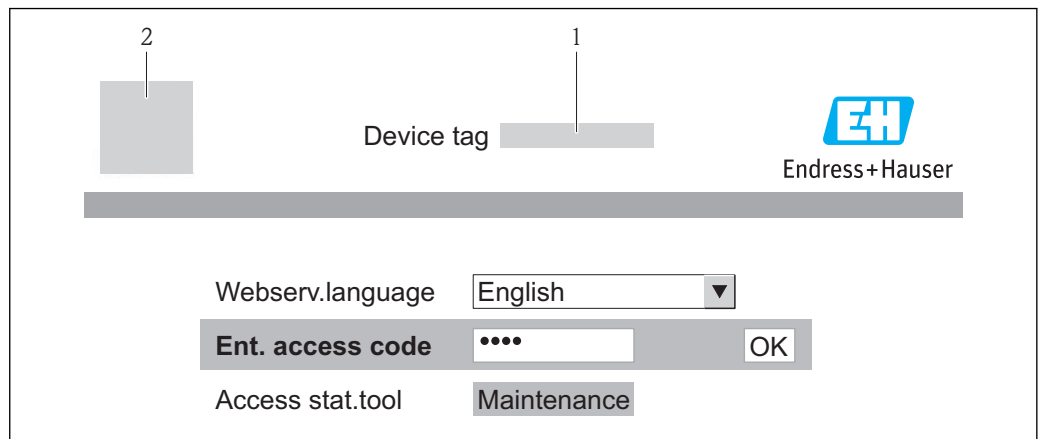

A0017362

- 1 Device tag (→ ⓘ 49)
- 2 Picture of device

**i** If a login page does not appear, or if the page is incomplete (→ ⓘ 79)

### 8.3.4 Logging on

1. Select the preferred operating language for the Web browser.
2. Enter the access code.
3. Press **OK** to confirm your entry.

<b>Access code</b>	0000 (factory setting); can be changed by customer (→ ⓘ 73)
--------------------	---

**i** If no action is performed for 10 minutes, the Web browser automatically returns to the login page.

### 8.3.5 User interface

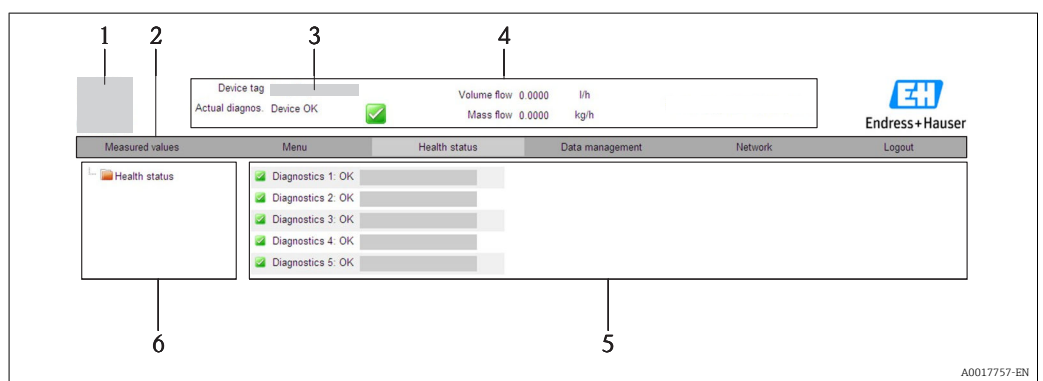

A0017757-EN

- 1 Picture of device
- 2 Function row with 6 functions
- 3 Device tag
- 4 Header
- 5 Working area
- 6 Navigation area

**Header**

The following information appears in the header:

- Device tag (→ 📄 49)
- Device status with status signal (→ 📄 81)
- Current measured values

**Function row**

Functions	Meaning
Measured values	The measured values of the device are displayed
Menu	Access to the operating menu structure of the device, same as for the operating tool
Device status	Displays the diagnostic messages currently pending, listed in order of priority
Data management	Data exchange between PC and measuring device: <ul style="list-style-type: none"> <li>- Upload the configuration from the device (XML format, create configuration back-up)</li> <li>- Save the configuration to the device (XML format, restore configuration)</li> <li>- Export the event list (.csv file)</li> <li>- Export parameter settings (.csv file, create documentation of the measuring point configuration)</li> <li>- Export the Heartbeat verification log (PDF file, only available with the "Heartbeat Verification" application package)</li> </ul>
Network configuration	Configuration and checking of all the parameters required for establishing the connection to the device: <ul style="list-style-type: none"> <li>■ Network settings (e.g. IP address, MAC address)</li> <li>■ Device information (e.g. serial number, firmware version)</li> </ul>
Logout	End the operation and call up the login page

**Navigation area**

If a function is selected in the function bar, the submenus of the function open in the navigation area. The user can now navigate through the menu structure.

**Working area**

Depending on the selected function and the related submenus, various actions can be performed in this area:

- Configuring parameters
- Reading measured values
- Calling up help text
- Starting an upload/download

**8.3.6 Disabling the Web server**

The Web server for the measuring device can enabled and disabled as required via the **Web server functionality** parameter.

**Navigation**

"Expert" menu → Communication → Web server

**Parameter overview with brief description**

Parameter	Description	Selection	Factory setting
Web server functionality	Switch the Web server on and off.	<ul style="list-style-type: none"> <li>■ Off</li> <li>■ On</li> </ul>	On

### Enabling the Web server

If the Web server is disabled it can only be re-enabled with the **Web server functionality** parameter via the following operating options:

Via "FieldCare" operating tool

### 8.3.7 Logging out

**i** Before logging out, perform a data backup via the **Data management** function (upload configuration from device) if necessary.

1. Select the **Logout** entry in the function row.  
↳ The home page with the Login box appears.
2. Close the Web browser.
3. Reset the modified properties of the Internet protocol (TCP/IP) if they are no longer needed (→ 36).

## 8.4 Access to the operating menu via the operating tool

### 8.4.1 Connecting the operating tool

#### Via HART protocol

This communication interface is present in the following device version:

Order code for "Output", option **B**: 4-20 mA HART, pulse/frequency/switch output

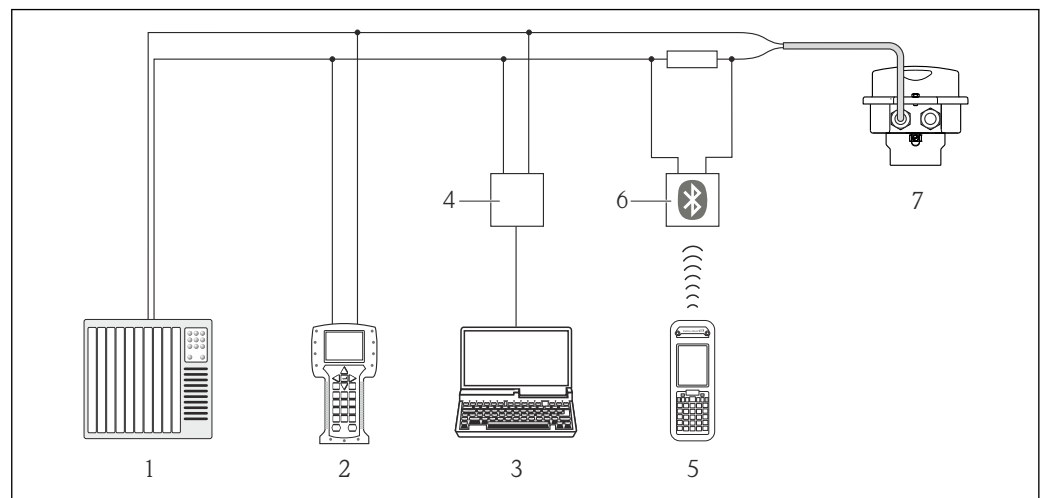

**11** Options for remote operation via HART protocol

- 1 Control system (e.g. PLC)
- 2 Field Communicator 475
- 3 Computer with operating tool (e.g. FieldCare, AMS Device Manager, SIMATIC PDM)
- 4 Commubox FXA195 (USB)
- 5 Field Xpert SFX350 or SFX370
- 6 VIATOR Bluetooth modem with connecting cable
- 7 Transmitter

### Via service interface (CDI-RJ45)

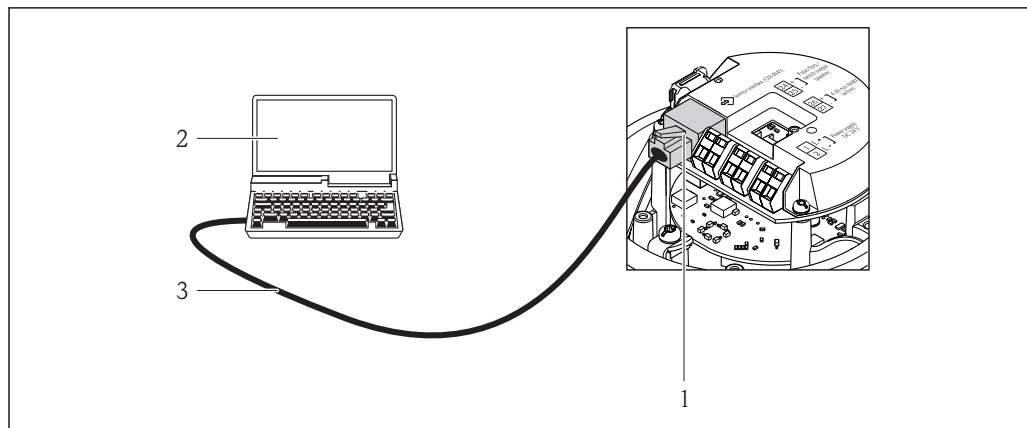

A0016926

 12 Connection for the order code for "Output", option B: 4-20 mA HART, pulse/frequency/switch output

- 1 Service interface (CDI -RJ45) of the measuring device with access to the integrated Web server
- 2 Computer with Web browser (e.g. Internet Explorer) for accessing the integrated device Web server or with "FieldCare" operating tool with COM DTM "CDI Communication TCP/IP"
- 3 Standard Ethernet connecting cable with RJ45 plug

## 8.4.2 Field Xpert SFX350, SFX370

### Function scope

Field Xpert SFX350 and Field Xpert SFX370 are mobile computers for commissioning and maintenance. They enable efficient device configuration and diagnostics for HART and FOUNDATION fieldbus devices in the **non-Ex area** (SFX350, SFX370) and the **Ex area** (SFX370).

 For details, see Operating Instructions BA01202S

### Source for device description files



See data (→  44)

## 8.4.3 FieldCare

### Function scope

FDT-based plant asset management tool from Endress+Hauser. It can configure all smart field devices in a system and helps you manage them. By using the status information, it is also a simple but effective way of checking their status and condition.

Access takes place via:

- HART protocol (→  39)
- Service interface CDI-RJ45 (→  40)

Typical functions:

- Configuring parameters of transmitters
- Loading and saving device data (upload/download)
- Documentation of the measuring point
- Visualization of the measured value memory (line recorder) and event logbook

 For details, see Operating Instructions BA00027S and BA00059S



### Source for device description files

See data (→  44)

### Establishing a connection

Via service interface (CDI-RJ45)

1. Start FieldCare and launch the project.
2. In the network: Add a device.
  - ↳ The **Add device** window opens.
3. Select the **CDI Communication TCP/IP** option from the list and press **OK** to confirm.
4. Right-click **CDI Communication TCP/IP** and select the **Add device** option in the context menu that opens.
5. Select the desired device from the list and press **OK** to confirm.
  - ↳ The **CDI Communication TCP/IP (Configuration)** window opens.
6. Enter the device address in the **IP address** field and press **Enter** to confirm:  
192.168.1.212 (factory setting); if the IP address is not known .
7. Establish the online connection to the device.



For details, see Operating Instructions BA00027S and BA00059S

User interface

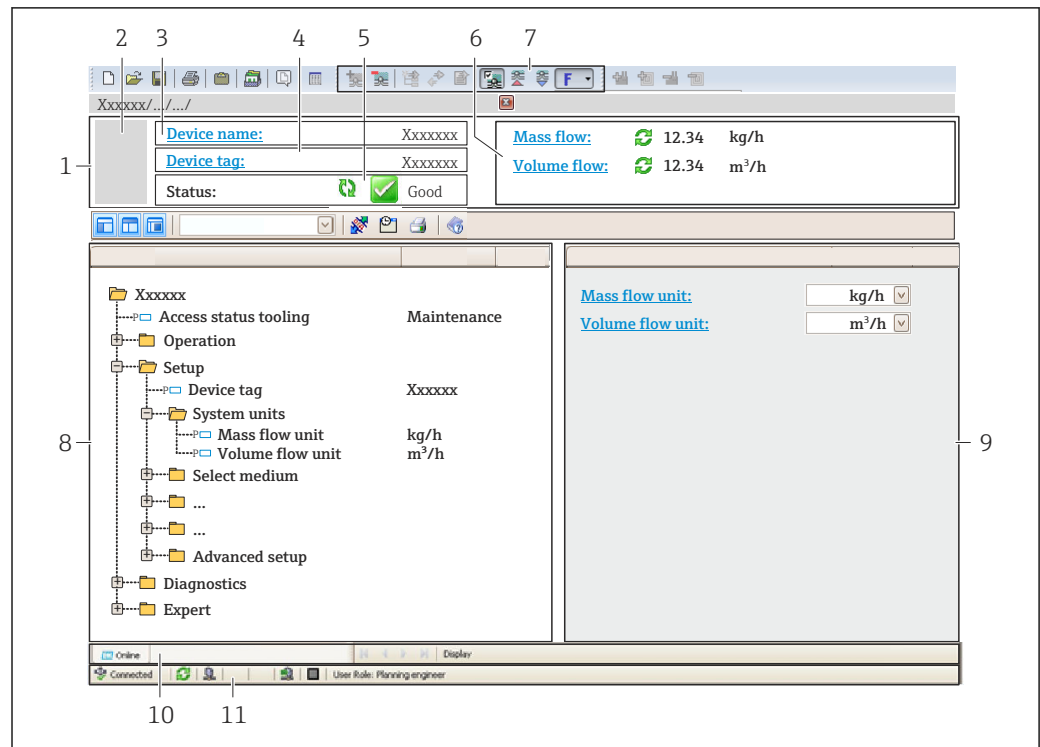

A0021051-EN

- 1 Header
- 2 Picture of device
- 3 Device name
- 4 Device tag (→ 49)
- 5 Status area with status signal (→ 81)
- 6 Display area for current measured values (→ 75)
- 7 Event list with additional functions such as save/load, events list and document creation
- 8 Navigation area with operating menu structure
- 9 Operating range
- 10 Range of action
- 11 Status area

### 8.4.4 AMS Device Manager

**Function scope**

Program from Emerson Process Management for operating and configuring measuring devices via HART protocol.

**Source for device description files**

See data (→ 44)

### 8.4.5 SIMATIC PDM

**Function scope**

SIMATIC PDM is a standardized, manufacturer-independent program from Siemens for the operation, configuration, maintenance and diagnosis of intelligent field devices via HART protocol.

**Source for device description files**

See data (→ 44)

## 8.4.6 Field Communicator 475

### Function scope

Industrial handheld terminal from Emerson Process Management for remote configuration and measured value display via HART protocol.

### Source for device description files

See data (→  44)

## 9 System integration

### 9.1 Overview of device description files

#### 9.1.1 Current version data for the device

Firmware version	01.01.zz	<ul style="list-style-type: none"> <li>▪ On the title page of the Operating instructions</li> <li>▪ On transmitter nameplate (→ 13)</li> <li>▪ Parameter <b>firmware version</b> Diagnostics → Device info → Firmware version</li> </ul>
Release date of firmware version	06.2014	---
Manufacturer ID	0x11	<b>Manufacturer ID</b> parameter Diagnostics → Device info → Manufacturer ID
Device type ID	0x4A	<b>Device type</b> parameter Diagnostics → Device info → Device type
HART protocol revision	7	---
Device revision	2	<ul style="list-style-type: none"> <li>▪ On transmitter nameplate (→ 13)</li> <li>▪ <b>Device revision</b> parameter Diagnostics → Device info → Device revision</li> </ul>

#### 9.1.2 Operating tools

The suitable device description file for the individual operating tools is listed in the table below, along with information on where the file can be acquired.

Operating tool via HART protocol	Sources for obtaining device descriptions
<ul style="list-style-type: none"> <li>▪ Field Xpert SFX350</li> <li>▪ Field Xpert SFX370</li> </ul>	Use update function of handheld terminal
FieldCare	<ul style="list-style-type: none"> <li>▪ <a href="http://www.endress.com">www.endress.com</a> → Download Area</li> <li>▪ CD-ROM (contact Endress+Hauser)</li> <li>▪ DVD (contact Endress+Hauser)</li> </ul>
AMS Device Manager (Emerson Process Management)	<a href="http://www.endress.com">www.endress.com</a> → Download Area
SIMATIC PDM (Siemens)	<a href="http://www.endress.com">www.endress.com</a> → Download Area
Field Communicator 475 (Emerson Process Management)	Use update function of handheld terminal

## 9.2 Measured variables via HART protocol

The following measured variables (HART device variables) are assigned to the dynamic variables at the factory:

Dynamic variables	Measured variables (HART device variables)
Primary dynamic variable (PV)	Mass flow
Secondary dynamic variable (SV)	Totalizer 1
Tertiary dynamic variable (TV)	Density
Quaternary dynamic variable (QV)	Temperature

The assignment of the measured variables to the dynamic variables can be modified and assigned as desired via local operation and the operating tool using the following parameters:

- Expert → Communication → HART output → Assign PV
- Expert → Communication → HART output → Assign SV
- Expert → Communication → HART output → Assign TV
- Expert → Communication → HART output → Assign QV

The following measured variables can be assigned to the dynamic variables:

#### **Measured variables for PV (primary dynamic variable)**

- Mass flow
- Volume flow
- Corrected volume flow
- Density
- Reference density
- Temperature

#### **Measured variables for SV, TV, QV (secondary, tertiary and quaternary dynamic variable)**

- Mass flow
- Volume flow
- Corrected volume flow
- Density
- Reference density
- Temperature
- Totalizer 1
- Totalizer 2
- Totalizer 3



The range of options increases if the measuring device has one or more application packages.

#### **Heartbeat Technology Application Package**

Additional measured variables are available with the Heartbeat Technology application package:

- Carrier pipe temperature
- Oscillation amplitude

#### **Device variables**

The device variables are permanently assigned. A maximum of 8 device variables can be transmitted:

- 0 = mass flow
- 1 = volume flow
- 2 = corrected volume flow
- 3 = density
- 4 = reference density
- 5 = temperature
- 6 = totalizer 1
- 7 = totalizer 2
- 8 = totalizer 3
- 9 = dynamic viscosity
- 10 = kinematic viscosity
- 11 = temp. compensated dynamic viscosity
- 12 = temp. compensated kinematic viscosity
- 13 = target mass flow
- 14 = carrier mass flow
- 15 = concentration

## 9.3 Other settings

### 9.3.1 Burst mode functionality in accordance with HART 7 Specification

#### Navigation

"Expert" menu → Communication → HART output → Burst configuration → Burst configuration 1 to 3

#### Structure of the submenu

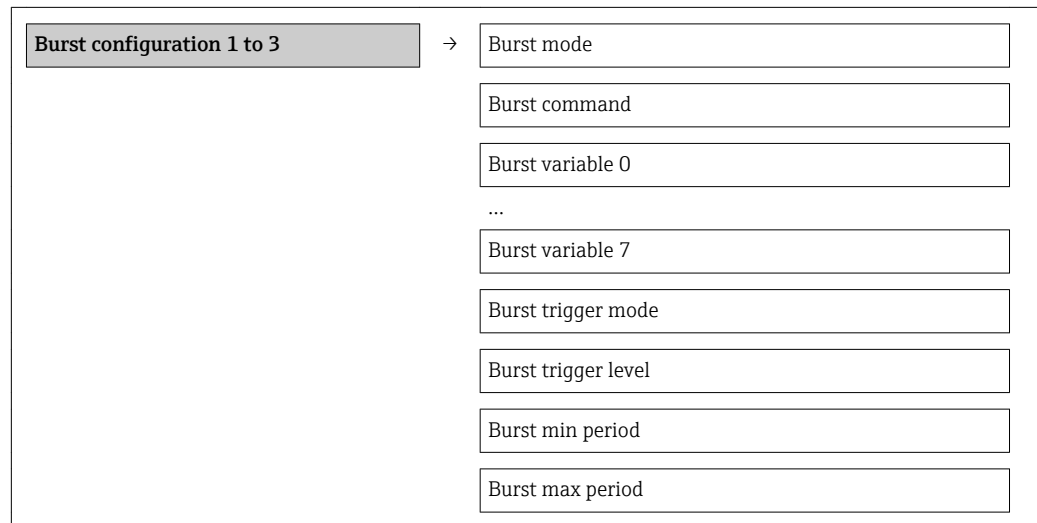

#### Parameter overview with brief description

Parameter	Description	Selection / User entry	Factory setting
Burst mode #	Activation of the HART burst mode for burst message X.  An external pressure or temperature sensor must also be in the Burst mode.	<ul style="list-style-type: none"> <li>▪ Off</li> <li>▪ On</li> </ul>	Off
Burst command #	Select the HART command that is sent to the HART master. <ul style="list-style-type: none"> <li>▪ <b>Command 1</b> option: Read out the primary variable.</li> <li>▪ <b>Command 2</b> option: Read out the current and the main measured value as a percentage.</li> <li>▪ <b>Command 3</b> option: Read out the dynamic HART variables and the current.</li> <li>▪ <b>Command 9</b> option: Read out the dynamic HART variables including the related status.</li> <li>▪ <b>Command 33</b> option: Read out the dynamic HART variables including the related unit.</li> <li>▪ <b>Command 48</b> option: Read out the complete device diagnostics.</li> </ul>	<ul style="list-style-type: none"> <li>▪ Command 1</li> <li>▪ Command 2</li> <li>▪ Command 3</li> <li>▪ Command 9</li> <li>▪ Command 33</li> <li>▪ Command 48</li> </ul>	Command 2

Parameter	Description	Selection / User entry	Factory setting
Burst variable 0	Assignment of the individual HART variables (PV, SV, TV, QV) and assignment of the process variables available in the device to the HART command.	<ul style="list-style-type: none"> <li>■ Mass flow</li> <li>■ Volume flow</li> <li>■ Corrected volume flow</li> <li>■ Target mass flow</li> <li>■ Carrier mass flow</li> <li>■ Density</li> <li>■ Reference density</li> <li>■ Concentration</li> <li>■ Dynamic viscosity</li> <li>■ Kinematic viscosity</li> <li>■ Temp. compensated dynamic viscosity</li> <li>■ Temp. compensated kinematic viscosity</li> <li>■ Temperature</li> <li>■ Totalizer 1</li> <li>■ Totalizer 2</li> <li>■ Totalizer 3</li> <li>■ Sensor integrity</li> <li>■ Pressure</li> <li>■ HART input</li> <li>■ Percent Of Range</li> <li>■ Measured current</li> <li>■ Primary variable (PV)</li> <li>■ Secondary variable (SV)</li> <li>■ Tertiary variable (TV)</li> <li>■ Quaternary variable (QV)</li> <li>■ Not used</li> </ul>	Volume flow
Burst variable 1	See burst variable 0.	See burst variable 0.	Not used
Burst variable 2	See burst variable 0.	See burst variable 0.	Not used
Burst variable 3	See burst variable 0.	See burst variable 0.	Not used
Burst variable 4	See burst variable 0.	See burst variable 0.	Not used
Burst variable 5	See burst variable 0.	See burst variable 0.	Not used
Burst variable 6	See burst variable 0.	See burst variable 0.	Not used
Burst variable 7	See burst variable 0.	See burst variable 0.	Not used
Burst trigger mode	<p>Use this function to select the event that triggers burst message X.</p> <ul style="list-style-type: none"> <li>■ <b>Continuous</b> option: The message is triggered in a time-controlled manner, at least observing the time interval defined in the <b>Burst min period</b> parameter.</li> <li>■ <b>Window</b> option: The message is triggered if the specified measured value has changed by the value in the <b>Burst trigger level</b> parameter.</li> <li>■ <b>Rising</b> option: The message is triggered if the specified measured value exceeds the value in the <b>Burst trigger level</b> parameter.</li> <li>■ <b>Falling</b> option: The message is triggered if the specified measured value drops below the value in the <b>Burst trigger level</b> parameter.</li> <li>■ <b>On change</b> option: The message is triggered if the measured value changes.</li> </ul>	<ul style="list-style-type: none"> <li>■ Continuous</li> <li>■ Window</li> <li>■ Rising</li> <li>■ Falling</li> <li>■ On change</li> </ul>	Continuous
Burst trigger level	<p>For entering the burst trigger value.</p> <p>Together with the option selected in the <b>Burst trigger mode</b> parameter the burst trigger value determines the time of burst message X.</p>	Positive floating-point number	2.0E-38

Parameter	Description	Selection / User entry	Factory setting
Min. update period	Use this function to enter the minimum time span between two burst commands of burst message X.	Positive integer	1 000 ms
Max. update period	Use this function to enter the maximum time span between two burst commands of burst message X.	Positive integer	2 000 ms



## 10 Commissioning

### 10.1 Function check

Before commissioning the device, make sure that the post-installation and post-connection checks have been performed.

- "Post-installation check" checklist (→  25)
- "Post-connection check" checklist (→  31)

### 10.2 Configuring the measuring device

The **Setup** menu with its submenus contains all the parameters needed for standard operation.

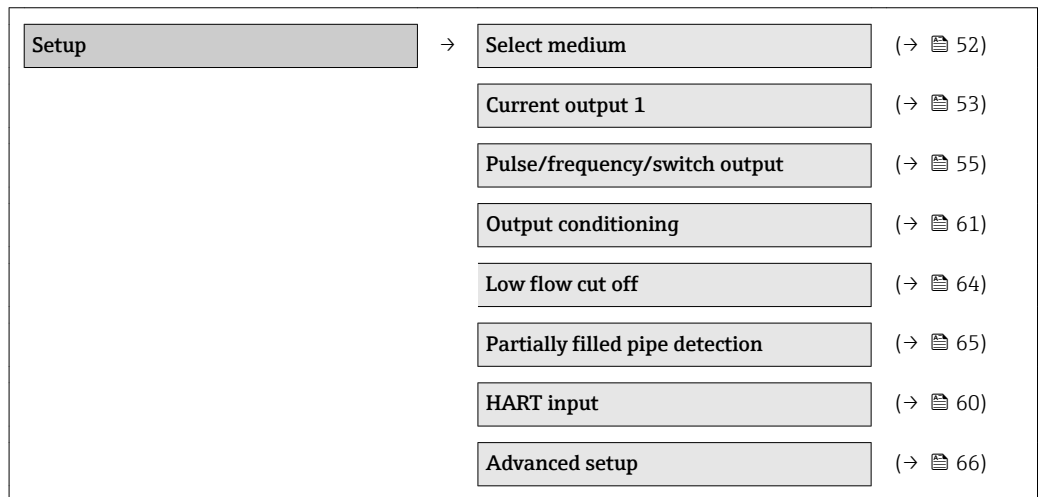

*Structure of the "Setup" menu*



#### 10.2.1 Defining the tag name

To enable fast identification of the measuring point within the system, you can enter a unique designation using the **Device tag** parameter and thus change the factory setting.

 The number of characters displayed depends on the characters used.

 For information on the tag name in the "FieldCare" operating tool (→  42)

#### Navigation

"Setup" menu → Device tag

#### Parameter overview with brief description

Parameter	Description	User entry	Factory setting
Device tag	Enter tag for measuring point.	Max. 32 characters, such as letters, numbers or special characters (e.g. @, %, /).	Promass

#### 10.2.2 Setting the system units

In the **System units** submenu the units of all the measured values can be set.

**Navigation**

"Setup" menu → Advanced setup → System units

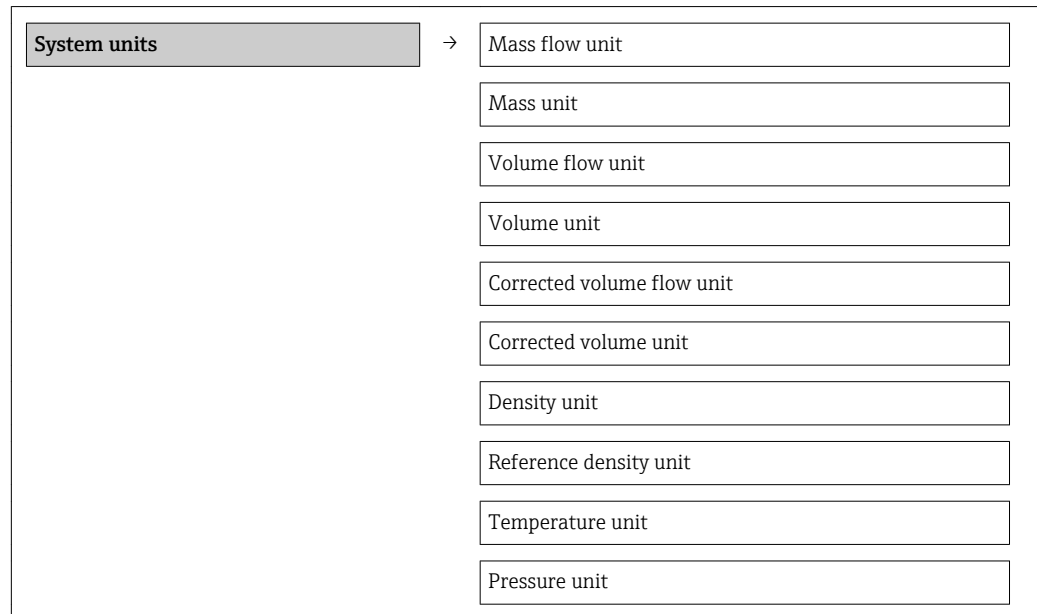
**Structure of the submenu****Parameter overview with brief description**

Parameter	Description	Selection	Factory setting
Mass flow unit	Select mass flow unit. <i>Result</i> The selected unit applies for: <ul style="list-style-type: none"> <li>▪ Output</li> <li>▪ Low flow cut off</li> <li>▪ Simulation process variable</li> </ul>	Unit choose list	Country-specific: <ul style="list-style-type: none"> <li>▪ kg/h</li> <li>▪ lb/min</li> </ul>
Mass unit	Select mass unit. <i>Result</i> The selected unit is taken from: <b>Mass flow unit</b> parameter	Unit choose list	Country-specific: <ul style="list-style-type: none"> <li>▪ kg</li> <li>▪ lb</li> </ul>
Volume flow unit	Select volume flow unit. <i>Result</i> The selected unit applies for: <ul style="list-style-type: none"> <li>▪ Output</li> <li>▪ Low flow cut off</li> <li>▪ Simulation process variable</li> </ul>	Unit choose list	Country-specific: <ul style="list-style-type: none"> <li>▪ l/h</li> <li>▪ gal/min (us)</li> </ul>
Volume unit	Select volume unit. <b>Result</b> The selected unit is taken from: <b>Volume flow unit</b> parameter	Unit choose list	Country-specific: <ul style="list-style-type: none"> <li>▪ l</li> <li>▪ gal (us)</li> </ul>
Corrected volume flow unit	Select corrected volume flow unit. <i>Result</i> The selected unit applies for: <ul style="list-style-type: none"> <li>▪ Output</li> <li>▪ Low flow cut off</li> <li>▪ Simulation process variable</li> </ul>	Unit choose list	Country-specific: <ul style="list-style-type: none"> <li>▪ NI/h</li> <li>▪ Sft<sup>3</sup>/h</li> </ul>

Parameter	Description	Selection	Factory setting
Corrected volume unit	Select corrected volume unit. <b>Result</b> The selected unit is taken from: <b>Corrected volume flow unit</b> parameter	Unit choose list	Country-specific: <ul style="list-style-type: none"> <li>▪ NI</li> <li>▪ Sft<sup>3</sup></li> </ul>
Density unit	Select density unit. <i>Result</i> The selected unit applies for: <ul style="list-style-type: none"> <li>▪ Output</li> <li>▪ Simulation process variable</li> <li>▪ Density adjustment (in <b>Expert</b> menu)</li> </ul>	Unit choose list	Country-specific: <ul style="list-style-type: none"> <li>▪ kg/l</li> <li>▪ lb/ft<sup>3</sup></li> </ul>
Reference density unit	Select reference density unit.	Unit choose list	kg/NI
Temperature unit	Select temperature unit. <i>Result</i> The selected unit applies for: <ul style="list-style-type: none"> <li>▪ Output</li> <li>▪ Reference temperature</li> <li>▪ Simulation process variable</li> </ul>	Unit choose list	Country-specific: <ul style="list-style-type: none"> <li>▪ °C (Celsius)</li> <li>▪ °F (Fahrenheit)</li> </ul>
Pressure unit	Select process pressure unit.	Unit choose list	Country-specific: <ul style="list-style-type: none"> <li>▪ bar</li> <li>▪ psi</li> </ul>

### 10.2.3 Selecting and setting the medium

The **Medium selection** submenu contains parameters that have to be configured for selecting and setting the medium.

#### Navigation

"Setup" menu → Select medium

Select medium	→	Select medium
		Select gas type
		Reference sound velocity
		Temperature coefficient sound velocity
		Pressure compensation
		Pressure value
		External pressure

#### Parameter overview with brief description

Parameter	Prerequisite	Description	Selection / User entry / User interface	Factory setting
Select medium	–	Select medium type.	Gas	Liquid
Select gas type	The following option is selected in the <b>Medium selection</b> parameter: Gas	Select measured gas type.	Gas type choose list	Methane CH <sub>4</sub>
Reference sound velocity	The following option is selected in the <b>Select gas type</b> parameter: Others	Enter sound velocity of gas at 0 °C (32 °F).	1 to 99 999.9999 m/s	0 m/s
Temperature coefficient sound velocity	The following option is selected in the <b>Select gas type</b> parameter: Others	Enter temperature coefficient for the gas sound velocity.	Positive floating-point number	0 (m/s)/K
Pressure compensation	The following option is selected in the <b>Medium selection</b> parameter: Gas	Select pressure compensation type.	<ul style="list-style-type: none"> <li>▪ Off</li> <li>▪ Fixed value</li> <li>▪ External value</li> </ul>	Off
Pressure value	The following option is selected in the <b>Pressure compensation</b> parameter: Fixed value	Enter process pressure to be used for pressure correction.	Positive floating-point number	0 bar
External pressure	The following option is selected in the <b>Pressure compensation</b> parameter: External value		Positive floating-point number	0 bar

### 10.2.4 Configuring the current output

The **"Current output 2" submenu** contains all the parameters that must be configured for the configuration of the current output.

#### Navigation

"Setup" menu → Current output 1 to 2

#### Structure of the submenu

<b>Current output 1 to 2</b>	→	Assign current output
		Current span
		4 mA value
		20 mA value
		Failure mode
		Failure current

## Parameter overview with brief description

Parameter	Description	Selection / User entry	Factory setting
Assign current output	Select process variable for current output.	<ul style="list-style-type: none"> <li>▪ Off</li> <li>▪ Mass flow</li> <li>▪ Volume flow</li> <li>▪ Corrected volume flow</li> <li>▪ Target mass flow</li> <li>▪ Carrier mass flow</li> <li>▪ Density</li> <li>▪ Reference density</li> <li>▪ Concentration</li> <li>▪ Dynamic viscosity</li> <li>▪ Kinematic viscosity</li> <li>▪ Temp. compensated dynamic viscosity</li> <li>▪ Temp. compensated kinematic viscosity</li> <li>▪ Temperature</li> <li>▪ Carrier pipe temperature</li> <li>▪ Electronic temperature</li> <li>▪ Oscillation frequency 0</li> <li>▪ Oscillation frequency 1</li> <li>▪ Oscillation amplitude 0</li> <li>▪ Oscillation amplitude 1</li> <li>▪ Frequency fluctuation 0</li> <li>▪ Frequency fluctuation 1</li> <li>▪ Oscillation damping 0</li> <li>▪ Oscillation damping 1</li> <li>▪ Tube damping fluctuation 0</li> <li>▪ Tube damping fluctuation 1</li> <li>▪ Signal asymmetry</li> <li>▪ Exciter current 0</li> <li>▪ Exciter current 1</li> <li>▪ Sensor integrity</li> </ul>	Mass flow
Mass flow unit	Select mass flow unit. <i>Result</i> The selected unit applies for: <ul style="list-style-type: none"> <li>▪ Output</li> <li>▪ Low flow cut off</li> <li>▪ Simulation process variable</li> </ul>	Unit choose list	Country-specific: <ul style="list-style-type: none"> <li>▪ kg/h</li> <li>▪ lb/min</li> </ul>
Volume flow unit	Select volume flow unit. <i>Result</i> The selected unit applies for: <ul style="list-style-type: none"> <li>▪ Output</li> <li>▪ Low flow cut off</li> <li>▪ Simulation process variable</li> </ul>	Unit choose list	Country-specific: <ul style="list-style-type: none"> <li>▪ l/h</li> <li>▪ gal/min (us)</li> </ul>
Current span	Select current range for process value output and upper/lower level for alarm signal.	<ul style="list-style-type: none"> <li>▪ 4...20 mA NAMUR</li> <li>▪ 4...20 mA US</li> <li>▪ 4...20 mA</li> <li>▪ 0...20 mA</li> <li>▪ Fixed current</li> </ul>	4...20 mA NAMUR
4 mA value	Enter 4 mA value.	Signed floating-point number	0 kg/h
20 mA value	Enter 20 mA value.	Signed floating-point number	2.5 kg/h
Failure mode	Define output behavior in alarm condition.	<ul style="list-style-type: none"> <li>▪ Min.</li> <li>▪ Max.</li> <li>▪ Last valid value</li> <li>▪ Actual value</li> <li>▪ Defined value</li> </ul>	Max.
Failure current	Enter current output value in alarm condition.	3.59 <sup>-3</sup> to 22.5 <sup>-3</sup> mA	22.5 mA

### 10.2.5 Configuring the pulse/frequency/switch output

The **Pulse/frequency/switch output 1** submenu contains all the parameters that must be configured for the configuration of the selected output type.

#### Pulse output

#### Navigation

"Setup" menu → Pulse/frequency/switch output

#### Structure of the submenu for the pulse output

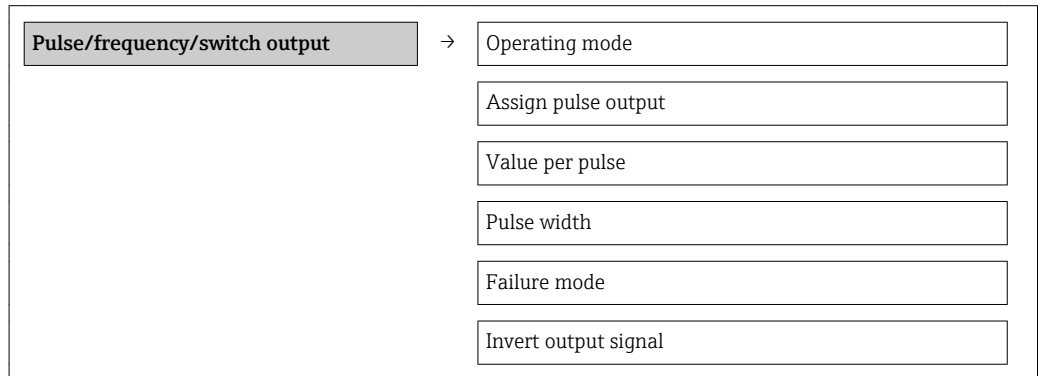

#### Parameter overview with brief description

Parameter	Description	Selection / User entry	Factory setting
Operating mode	Define the output as a pulse, frequency or switch output.	<ul style="list-style-type: none"> <li>■ Pulse</li> <li>■ Frequency</li> <li>■ Switch</li> </ul>	Pulse
Assign pulse output	Select process variable for pulse output.	<ul style="list-style-type: none"> <li>■ Off</li> <li>■ Mass flow</li> <li>■ Volume flow</li> <li>■ Corrected volume flow</li> <li>■ Target mass flow</li> <li>■ Carrier mass flow</li> </ul>	Off
Mass unit	Select mass unit. <i>Result</i> The selected unit is taken from: <b>Mass flow unit</b> parameter	Unit choose list	Country-specific: <ul style="list-style-type: none"> <li>■ kg</li> <li>■ lb</li> </ul>
Volume unit	Select volume unit. <b>Result</b> The selected unit is taken from: <b>Volume flow unit</b> parameter	Unit choose list	Country-specific: <ul style="list-style-type: none"> <li>■ l</li> <li>■ gal (us)</li> </ul>
Value per pulse	Enter measured value at which a pulse is output.	Signed floating-point number	0
Pulse width	Define time width of the output pulse.	0.05 to 2 000 ms	100 ms
Failure mode	Define output behavior in alarm condition.	<ul style="list-style-type: none"> <li>■ Actual value</li> <li>■ No pulses</li> </ul>	No pulses
Invert output signal	Invert the output signal.	<ul style="list-style-type: none"> <li>■ No</li> <li>■ Yes</li> </ul>	No

#### Frequency output

#### Navigation

"Setup" menu → Pulse/frequency/switch output

**Structure of the submenu for the frequency output**

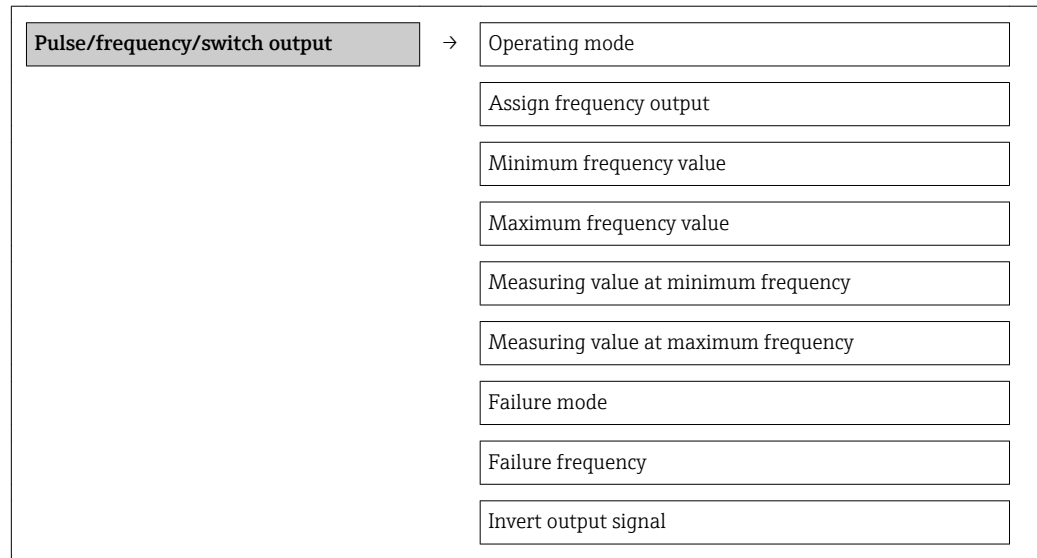

**Parameter overview with brief description**

Parameter	Description	Selection / User entry	Factory setting
Operating mode	Define the output as a pulse, frequency or switch output.	<ul style="list-style-type: none"> <li>▪ Pulse</li> <li>▪ Frequency</li> <li>▪ Switch</li> </ul>	Pulse
Assign frequency output	Select process variable for frequency output.	<ul style="list-style-type: none"> <li>▪ Off</li> <li>▪ Mass flow</li> <li>▪ Volume flow</li> <li>▪ Corrected volume flow</li> <li>▪ Target mass flow</li> <li>▪ Carrier mass flow</li> <li>▪ Density</li> <li>▪ Reference density</li> <li>▪ Concentration</li> <li>▪ Dynamic viscosity</li> <li>▪ Kinematic viscosity</li> <li>▪ Temp. compensated dynamic viscosity</li> <li>▪ Temp. compensated kinematic viscosity</li> <li>▪ Temperature</li> <li>▪ Carrier pipe temperature</li> <li>▪ Electronic temperature</li> <li>▪ Oscillation frequency 0</li> <li>▪ Oscillation frequency 1</li> <li>▪ Frequency fluctuation 0</li> <li>▪ Frequency fluctuation 1</li> <li>▪ Oscillation amplitude 0</li> <li>▪ Oscillation amplitude 1</li> <li>▪ Oscillation damping 0</li> <li>▪ Oscillation damping 1</li> <li>▪ Tube damping fluctuation 0</li> <li>▪ Tube damping fluctuation 1</li> <li>▪ Signal asymmetry</li> <li>▪ Exciter current 0</li> <li>▪ Exciter current 1</li> </ul>	Off



Parameter	Description	Selection / User entry	Factory setting
Mass flow unit	Select mass flow unit. <i>Result</i> The selected unit applies for: <ul style="list-style-type: none"> <li>■ Output</li> <li>■ Low flow cut off</li> <li>■ Simulation process variable</li> </ul>	Unit choose list	Country-specific: <ul style="list-style-type: none"> <li>■ kg/h</li> <li>■ lb/min</li> </ul>
Volume flow unit	Select volume flow unit. <i>Result</i> The selected unit applies for: <ul style="list-style-type: none"> <li>■ Output</li> <li>■ Low flow cut off</li> <li>■ Simulation process variable</li> </ul>	Unit choose list	Country-specific: <ul style="list-style-type: none"> <li>■ l/h</li> <li>■ gal/min (us)</li> </ul>
Minimum frequency value	Enter minimum frequency.	0.0 to 10 000.0 Hz	0.0 Hz
Maximum frequency value	Enter maximum frequency.	0.0 to 10 000.0 Hz	10 000.0 Hz
Measuring value at minimum frequency	Enter measured value for minimum frequency.	Signed floating-point number	0
Measuring value at maximum frequency	Enter measured value for maximum frequency.	Signed floating-point number	0
Failure mode	Define output behavior in alarm condition.	<ul style="list-style-type: none"> <li>■ Actual value</li> <li>■ Defined value</li> <li>■ 0 Hz</li> </ul>	0 Hz
Failure frequency	Enter frequency output value in alarm condition.	0.0 to 12 500.0 Hz	0.0 Hz
Invert output signal	Invert the output signal.	<ul style="list-style-type: none"> <li>■ No</li> <li>■ Yes</li> </ul>	No

### Switch output

#### Navigation

"Setup" menu → Pulse/frequency/switch output

#### Structure of the submenu for the switch output

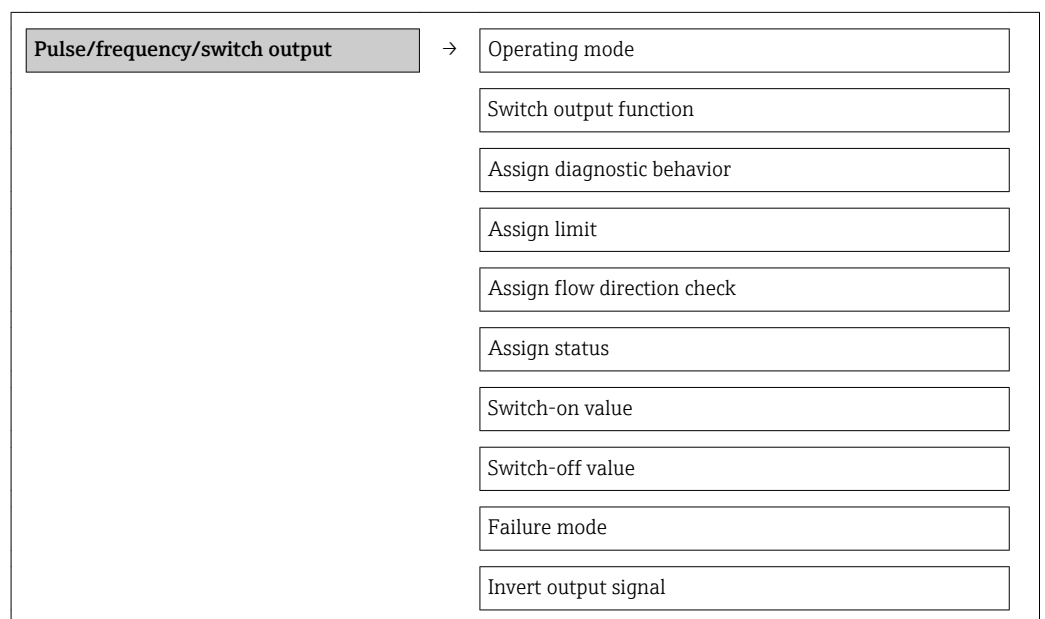

## Parameter overview with brief description

Parameter	Description	Selection / User entry	Factory setting
Operating mode	Define the output as a pulse, frequency or switch output.	<ul style="list-style-type: none"> <li>▪ Pulse</li> <li>▪ Frequency</li> <li>▪ Switch</li> </ul>	Pulse
Switch output function	Select function for switch output.	<ul style="list-style-type: none"> <li>▪ Off</li> <li>▪ On</li> <li>▪ Diagnostic behavior</li> <li>▪ Limit</li> <li>▪ Flow direction check</li> <li>▪ Status</li> </ul>	Off
Assign diagnostic behavior	Select diagnostic behavior for switch output.	<ul style="list-style-type: none"> <li>▪ Alarm</li> <li>▪ Alarm or warning</li> <li>▪ Warning</li> </ul>	Alarm
Assign limit	Select process variable for limit function.	<ul style="list-style-type: none"> <li>▪ Mass flow</li> <li>▪ Volume flow</li> <li>▪ Corrected volume flow</li> <li>▪ Target mass flow</li> <li>▪ Carrier mass flow</li> <li>▪ Density</li> <li>▪ Reference density</li> <li>▪ Dynamic viscosity</li> <li>▪ Concentration</li> <li>▪ Kinematic viscosity</li> <li>▪ Temp. compensated dynamic viscosity</li> <li>▪ Temp. compensated kinematic viscosity</li> <li>▪ Temperature</li> <li>▪ Totalizer 1</li> <li>▪ Totalizer 2</li> <li>▪ Totalizer 3</li> <li>▪ Measuring tube damping</li> </ul>	Mass flow
Assign flow direction check	Select process variable for flow direction monitoring.	<ul style="list-style-type: none"> <li>▪ Off</li> <li>▪ Volume flow</li> <li>▪ Mass flow</li> <li>▪ Corrected volume flow</li> </ul>	Mass flow
Assign status	Select device status for switch output.	<ul style="list-style-type: none"> <li>▪ Partially filled pipe detection</li> <li>▪ Low flow cut off</li> </ul>	Partially filled pipe detection
Mass flow unit	Select mass flow unit. <i>Result</i> The selected unit applies for: <ul style="list-style-type: none"> <li>▪ Output</li> <li>▪ Low flow cut off</li> <li>▪ Simulation process variable</li> </ul>	Unit choose list	Country-specific: <ul style="list-style-type: none"> <li>▪ kg/h</li> <li>▪ lb/min</li> </ul>
Volume flow unit	Select volume flow unit. <i>Result</i> The selected unit applies for: <ul style="list-style-type: none"> <li>▪ Output</li> <li>▪ Low flow cut off</li> <li>▪ Simulation process variable</li> </ul>	Unit choose list	Country-specific: <ul style="list-style-type: none"> <li>▪ l/h</li> <li>▪ gal/min (us)</li> </ul>
Unit totalizer	Select process variable totalizer unit.	Unit choose list	kg
Switch-on value	Enter measured value for the switch-on point.	Signed floating-point number	0 kg/h
Switch-off value	Enter measured value for the switch-off point.	Signed floating-point number	0 kg/h
Switch-on delay	Define delay for the switch-on of status output.	0.0 to 100.0 s	0.0 s

Parameter	Description	Selection / User entry	Factory setting
Switch-off delay	Define delay for the switch-off of status output.	0.0 to 100.0 s	0.0 s
Failure mode	Define output behavior in alarm condition.	<ul style="list-style-type: none"> <li>▪ Actual status</li> <li>▪ Open</li> <li>▪ Closed</li> </ul>	Open
Invert output signal	Invert the output signal.	<ul style="list-style-type: none"> <li>▪ No</li> <li>▪ Yes</li> </ul>	No

### 10.2.6 Configuring the local display

The **Display** wizard guides you systematically through all the parameters that can be configured for configuring the local display.

#### Navigation

"Setup" menu → Display

#### Structure of the wizard

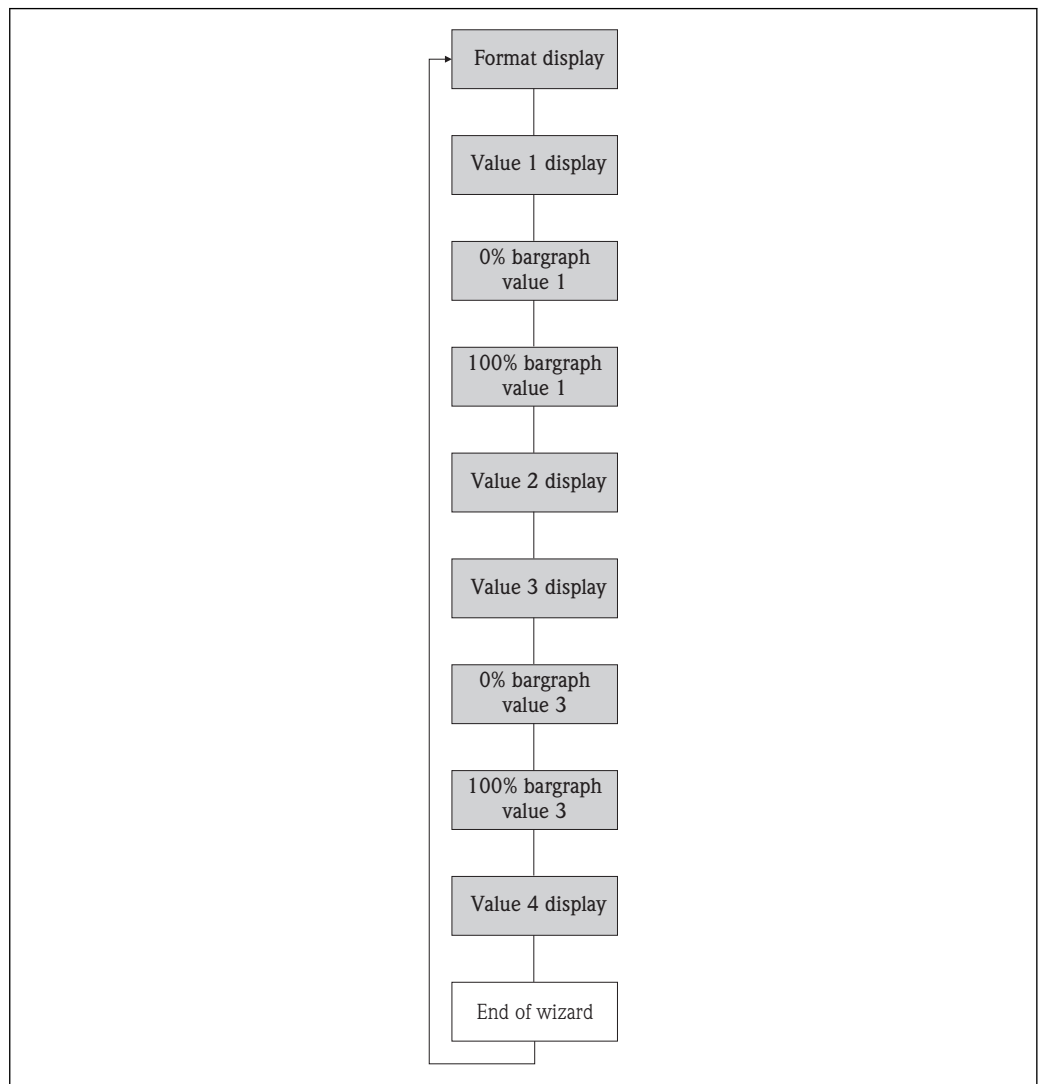

13 "Display" wizard in the "Setup" menu

A0013797-EN

### Parameter overview with brief description

Parameter	Description	Selection / User entry	Factory setting
Format display	Select how measured values are shown on the display.	<ul style="list-style-type: none"> <li>▪ 1 value, max. size</li> <li>▪ 1 bargraph + 1 value</li> <li>▪ 2 values</li> <li>▪ 1 value large + 2 values</li> <li>▪ 4 values</li> </ul>	1 value, max. size
Value 1 display	Select the measured value that is shown on the local display.	<ul style="list-style-type: none"> <li>▪ Mass flow</li> <li>▪ Volume flow</li> <li>▪ Corrected volume flow</li> <li>▪ Target mass flow</li> <li>▪ Carrier mass flow</li> <li>▪ Density</li> <li>▪ Reference density</li> <li>▪ Concentration</li> <li>▪ Dynamic viscosity</li> <li>▪ Kinematic viscosity</li> <li>▪ Temp. compensated dynamic viscosity</li> <li>▪ Temp. compensated kinematic viscosity</li> <li>▪ Temperature</li> <li>▪ Carrier pipe temperature</li> <li>▪ Electronic temperature</li> <li>▪ Oscillation frequency 0</li> <li>▪ Oscillation frequency 1</li> <li>▪ Oscillation amplitude 0</li> <li>▪ Oscillation amplitude 1</li> <li>▪ Frequency fluctuation 0</li> <li>▪ Frequency fluctuation 1</li> <li>▪ Oscillation damping 0</li> <li>▪ Oscillation damping 1</li> <li>▪ Tube damping fluctuation 0</li> <li>▪ Tube damping fluctuation 1</li> <li>▪ Signal asymmetry</li> <li>▪ Exciter current 0</li> <li>▪ Exciter current 1</li> <li>▪ Sensor integrity</li> <li>▪ None</li> <li>▪ Totalizer 1</li> <li>▪ Totalizer 2</li> <li>▪ Totalizer 3</li> <li>▪ Current output 1</li> </ul>	Mass flow
0% bargraph value 1	Enter 0% value for bar graph display.	Signed floating-point number	0 kg/h
100% bargraph value 1	Enter 100% value for bar graph display.	Signed floating-point number	2.5 kg/h
Value 2 display	Select the measured value that is shown on the local display.	Picklist (see 1st display value)	None
Value 3 display	Select the measured value that is shown on the local display.	Picklist (see 1st display value)	None
0% bargraph value 3	Enter 0% value for bar graph display.	Signed floating-point number	0
100% bargraph value 3	Enter 100% value for bar graph display.	Signed floating-point number	0
Value 4 display	Select the measured value that is shown on the local display.	Picklist (see 1st display value)	None

### 10.2.7 Configuring the HART input

The **HART input** submenu contains all the parameters that must be configured for the configuration of the HART input.

**Navigation**

"Expert" menu → Communication → HART input → Configuration

<b>HART input</b>	→	Capture mode
		Device ID
		Device type
		Manufacturer ID
		Burst command
		Slot number
		Timeout
		Failure mode
		Failure value

**Parameter overview with brief description**

Parameter	Description	Selection / User entry	Factory setting
Capture mode	Select capture mode via burst or master communication.	<ul style="list-style-type: none"> <li>■ Off</li> <li>■ Burst network</li> <li>■ Master network</li> </ul>	Off
Manufacturer ID	Enter manufacture ID of external device.	0 to 255	0
Device ID	Enter device ID of external device.	Positive integer	0
Device type	Enter device type of external device.	0 to 255	0
Burst command	Select command to read in external process variable.	<ul style="list-style-type: none"> <li>■ Command 1</li> <li>■ Command 3</li> <li>■ Command 9</li> <li>■ Command 33</li> </ul>	Command 1
Slot number	Define position of external process variable in burst command.	1 to 4	1
Timeout	Enter deadline for process variable of external device.  If the deadline is exceeded, diagnostic message <b>F410 data transmission</b> is output.	1 to 120 s	5 s
Failure mode	Define behavior if external process variable is missed.	<ul style="list-style-type: none"> <li>■ Alarm</li> <li>■ Last valid value</li> <li>■ Defined value</li> </ul>	Alarm
Failure value	Enter value to be used by the device if input value from external device is missing.	Signed floating-point number	0

**10.2.8 Configuring the output conditioning**

The **Output conditioning** wizard contains all the parameters that must be configured for the configuration of output conditioning.

**Navigation**

"Setup" menu → Output conditioning

### Structure of the submenu for output conditioning

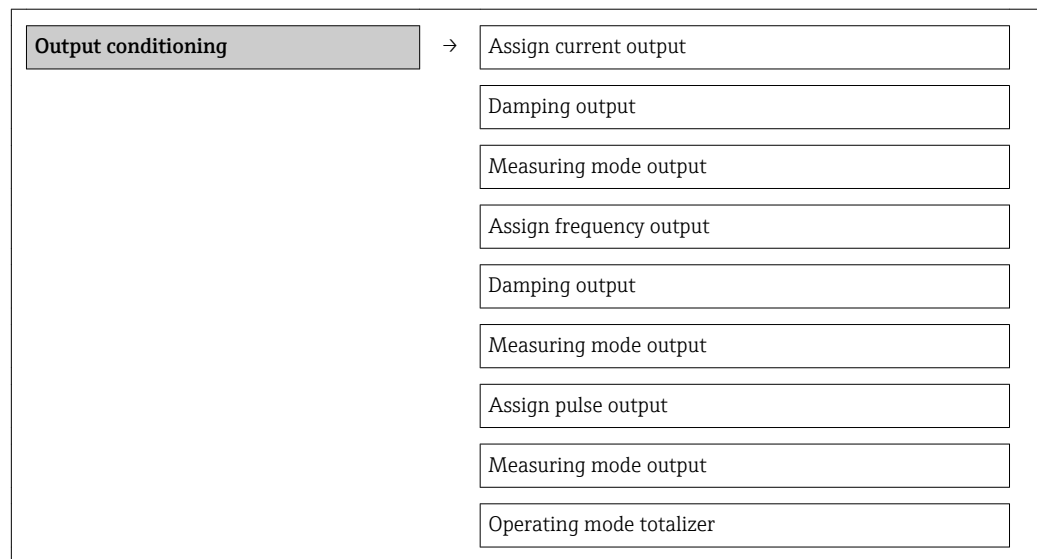

### Parameter overview with brief description

Parameter	Description	Selection / User entry	Factory setting
Assign current output	Select process variable for current output.	<ul style="list-style-type: none"> <li>▪ Off</li> <li>▪ Mass flow</li> <li>▪ Volume flow</li> <li>▪ Corrected volume flow</li> <li>▪ Target mass flow</li> <li>▪ Carrier mass flow</li> <li>▪ Density</li> <li>▪ Reference density</li> <li>▪ Concentration</li> <li>▪ Dynamic viscosity</li> <li>▪ Kinematic viscosity</li> <li>▪ Temp. compensated dynamic viscosity</li> <li>▪ Temp. compensated kinematic viscosity</li> <li>▪ Temperature</li> <li>▪ Carrier pipe temperature</li> <li>▪ Electronic temperature</li> <li>▪ Oscillation frequency 0</li> <li>▪ Oscillation frequency 1</li> <li>▪ Oscillation amplitude 0</li> <li>▪ Oscillation amplitude 1</li> <li>▪ Frequency fluctuation 0</li> <li>▪ Frequency fluctuation 1</li> <li>▪ Oscillation damping 0</li> <li>▪ Oscillation damping 1</li> <li>▪ Tube damping fluctuation 0</li> <li>▪ Tube damping fluctuation 1</li> <li>▪ Signal asymmetry</li> <li>▪ Exciter current 0</li> <li>▪ Exciter current 1</li> <li>▪ Sensor integrity</li> </ul>	Mass flow
Damping output #	Set reaction time for output signal to fluctuations in the measured value.	0 to 999.9 s	1 s
Measuring mode output #	Select measuring mode for output.	<ul style="list-style-type: none"> <li>▪ Forward flow</li> <li>▪ Forward/Reverse flow</li> <li>▪ Reverse flow compensation</li> </ul>	Forward flow

Parameter	Description	Selection / User entry	Factory setting
Assign frequency output	Select process variable for frequency output.	<ul style="list-style-type: none"> <li>■ Off</li> <li>■ Mass flow</li> <li>■ Volume flow</li> <li>■ Corrected volume flow</li> <li>■ Target mass flow</li> <li>■ Carrier mass flow</li> <li>■ Density</li> <li>■ Reference density</li> <li>■ Concentration</li> <li>■ Dynamic viscosity</li> <li>■ Kinematic viscosity</li> <li>■ Temp. compensated dynamic viscosity</li> <li>■ Temp. compensated kinematic viscosity</li> <li>■ Temperature</li> <li>■ Carrier pipe temperature</li> <li>■ Electronic temperature</li> <li>■ Oscillation frequency 0</li> <li>■ Oscillation frequency 1</li> <li>■ Frequency fluctuation 0</li> <li>■ Frequency fluctuation 1</li> <li>■ Oscillation amplitude 0</li> <li>■ Oscillation amplitude 1</li> <li>■ Oscillation damping 0</li> <li>■ Oscillation damping 1</li> <li>■ Tube damping fluctuation 0</li> <li>■ Tube damping fluctuation 1</li> <li>■ Signal asymmetry</li> <li>■ Exciter current 0</li> <li>■ Exciter current 1</li> </ul>	Off
Damping output #	Set reaction time for output signal to fluctuations in the measured value.	0 to 999.9 s	1 s
Measuring mode output #	Select measuring mode for output.	<ul style="list-style-type: none"> <li>■ Forward flow</li> <li>■ Forward/Reverse flow</li> <li>■ Reverse flow</li> <li>■ Reverse flow compensation</li> </ul>	Forward flow
Assign pulse output	Select process variable for pulse output.	<ul style="list-style-type: none"> <li>■ Off</li> <li>■ Mass flow</li> <li>■ Volume flow</li> <li>■ Corrected volume flow</li> <li>■ Target mass flow</li> <li>■ Carrier mass flow</li> </ul>	Off
Measuring mode output #	Select measuring mode for output.	<ul style="list-style-type: none"> <li>■ Forward flow</li> <li>■ Forward/Reverse flow</li> <li>■ Reverse flow</li> <li>■ Reverse flow compensation</li> </ul>	Forward flow
Operating mode totalizer #	Select totalizer calculation mode.	<ul style="list-style-type: none"> <li>■ Net flow total</li> <li>■ Forward flow total</li> <li>■ Reverse flow total</li> </ul>	Net flow total

## 10.2.9 Configuring the low flow cut off

The **Low flow cut off** submenu contains parameters that must be configured for the configuration of low flow cut off.

### Navigation

"Setup" menu → Low flow cut off

Low flow cut off	→	Assign process variable
		On value low flow cutoff
		Off value low flow cutoff
		Pressure shock suppression

### Parameter overview with brief description

Parameter	Prerequisite	Description	Selection / User entry	Factory setting
Assign process variable	–	Select process variable for low flow cut off.	<ul style="list-style-type: none"> <li>■ Off</li> <li>■ Mass flow</li> <li>■ Volume flow</li> <li>■ Corrected volume flow</li> </ul>	Mass flow
On value low flow cutoff	One of the following options is selected in the <b>Assign process variable</b> parameter: <ul style="list-style-type: none"> <li>■ Mass flow</li> <li>■ Volume flow</li> <li>■ Corrected volume flow</li> </ul>	Enter on value for low flow cut off.	Positive floating-point number	For liquids: depends on country and nominal diameter
Off value low flow cutoff	One of the following options is selected in the <b>Assign process variable</b> parameter: <ul style="list-style-type: none"> <li>■ Mass flow</li> <li>■ Volume flow</li> <li>■ Corrected volume flow</li> </ul>	Enter off value for low flow cut off.	0 to 100.0 %	50 %
Pressure shock suppression	One of the following options is selected in the <b>Assign process variable</b> parameter: <ul style="list-style-type: none"> <li>■ Mass flow</li> <li>■ Volume flow</li> <li>■ Corrected volume flow</li> </ul>	Enter time frame for signal suppression (= active pressure shock suppression).	0 to 100 s	0 s



### 10.2.10 Configuring the partial filled pipe detection

The **Partially filled pipe detection** submenu contains parameters that have to be set for configuring empty pipe detection.

#### Navigation

"Setup" menu → Partially filled pipe detection

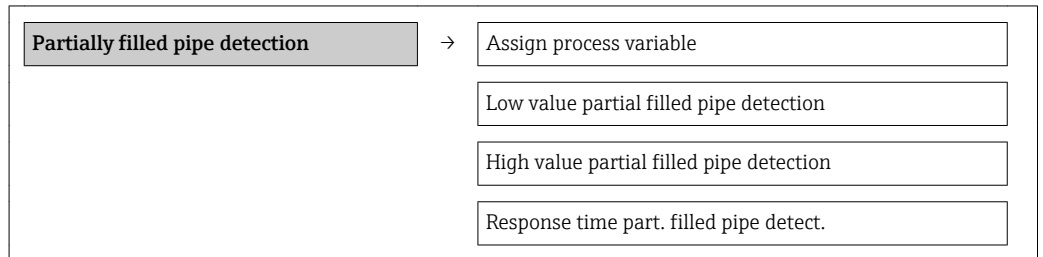

#### Parameter overview with brief description

Parameter	Prerequisite	Description	Selection / User entry	Factory setting
Assign process variable	–	Select process variable for partially filled pipe detection.	<ul style="list-style-type: none"> <li>▪ Off</li> <li>▪ Density</li> <li>▪ Reference density</li> </ul>	Off
Low value partial filled pipe detection	One of the following options is selected in the <b>Assign process variable</b> parameter: <ul style="list-style-type: none"> <li>▪ Density</li> <li>▪ Reference density</li> </ul>	Enter lower limit value for deactivating partialy filled pipe detection.	Signed floating-point number	Country-dependent: <ul style="list-style-type: none"> <li>▪ 0.2 kg/l</li> <li>▪ 12.5 lb/ft<sup>3</sup></li> </ul>
High value partial filled pipe detection	One of the following options is selected in the <b>Assign process variable</b> parameter: <ul style="list-style-type: none"> <li>▪ Density</li> <li>▪ Reference density</li> </ul>	Enter upper limit value for deactivating partialy filled pipe detection.	Signed floating-point number	Country-dependent: <ul style="list-style-type: none"> <li>▪ 6 kg/l</li> <li>▪ 374.6 lb/ft<sup>3</sup></li> </ul>
Response time part. filled pipe detect.	One of the following options is selected in the <b>Assign process variable</b> parameter: <ul style="list-style-type: none"> <li>▪ Density</li> <li>▪ Reference density</li> </ul>	Enter time before diagnostic message is displayed for partially filled pipe detection.	0 to 100 s	1 s

## 10.3 Advanced settings

The **Advanced setup** submenu with its submenus contains parameters for specific settings.

### Navigation

"Setup" menu → Advanced setup

### Overview of the parameters and submenus in the "Advanced setup" submenu:

*Taking the example of the Web browser*

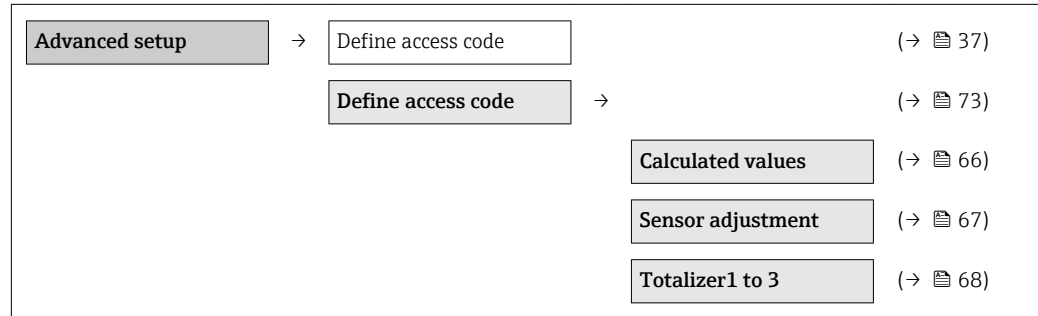

### 10.3.1 Calculated values

The **Calculated values** submenu contains parameters for calculating the corrected volume flow.

### Navigation

"Setup" menu → Advanced setup → Calculated values

*Structure of the submenu*

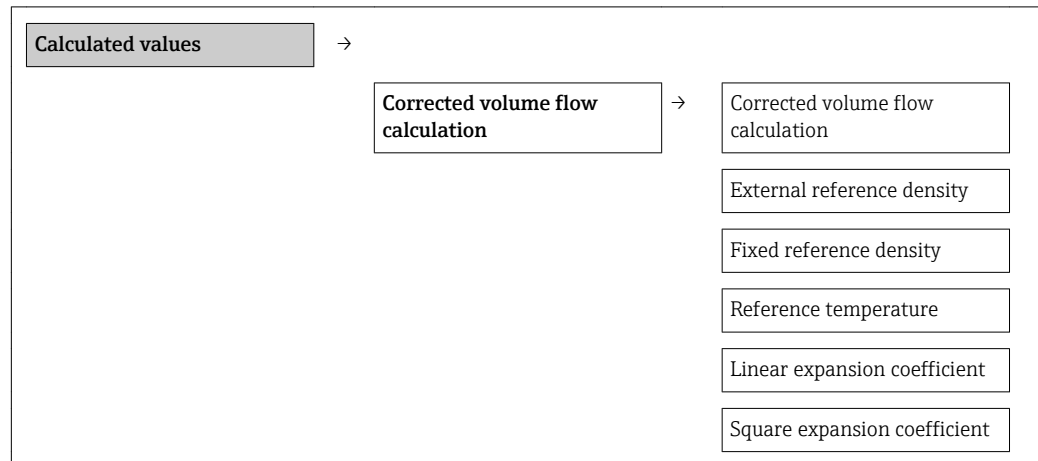

**Parameter overview with brief description**

Parameter	Prerequisite	Description	Selection / User entry	Factory setting
Corrected volume flow calculation	–	Select reference density for calculating the corrected volume flow.	<ul style="list-style-type: none"> <li>■ Fixed reference density</li> <li>■ Calculated reference density</li> <li>■ Reference density by API table 53</li> </ul>	Calculated reference density
External reference density	–	Shows external reference density.	Floating point number with sign	0 kg/Nl
Fixed reference density	The following option is selected in the <b>Corrected volume flow calculation</b> parameter: Fixed reference density	Enter fixed value for reference density.	Positive floating-point number	1 kg/Nl
Reference temperature	The following option is selected in the <b>Corrected volume flow calculation</b> parameter: Calculated reference density	Enter reference temperature for calculating the reference density.	–273.15 to 99999 °C	20 °C
Linear expansion coefficient	The following option is selected in the <b>Corrected volume flow calculation</b> parameter: Calculated reference density	Enter linear, medium-specific expansion coefficient for calculating the reference density.	Signed floating-point number	0.0
Square expansion coefficient	–	For media with a non-linear expansion pattern: enter the quadratic, medium-specific expansion coefficient for calculating the reference density.	Signed floating-point number	0.0

**10.3.2 Carrying out a sensor adjustment**

The **Sensor adjustment** submenu contains parameters that pertain to the functionality of the sensor.

**Navigation**

"Setup" menu → Advanced setup → Sensor adjustment

*Structure of the submenu*

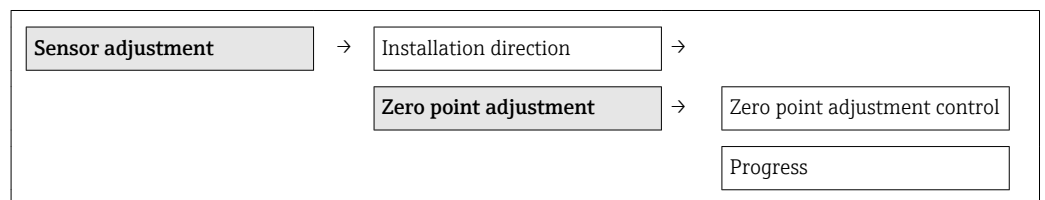

### Parameter overview with brief description

Parameter	Description	Selection / User interface	Factory setting
Installation direction	Set sign of flow direction to match the direction of the arrow on the sensor.	<ul style="list-style-type: none"> <li>▪ Flow in arrow direction</li> <li>▪ Flow against arrow direction</li> </ul>	Flow in arrow direction
Zero point adjustment control	Start zero point adjustment.	<ul style="list-style-type: none"> <li>▪ Cancel</li> <li>▪ Busy</li> <li>▪ Zero point adjust failure</li> <li>▪ Start</li> </ul>	Cancel
Progress	Shows the progress of the process.	0 to 100 %	0 %

### 10.3.3 Configuring the totalizer

In the "Totalizer 1 to 3" submenu the individual totalizers can be configured.

#### Navigation

"Setup" menu → Advanced setup → Totalizer 1 to 3

Totalizer 1 to 3	→	Assign process variable
		Unit totalizer
		Failure mode

### Parameter overview with brief description

Parameter	Description	Selection	Factory setting
Assign process variable	Select process variable for totalizer.	<ul style="list-style-type: none"> <li>▪ Off</li> <li>▪ Volume flow</li> <li>▪ Mass flow</li> <li>▪ Corrected volume flow</li> <li>▪ Target mass flow</li> <li>▪ Carrier mass flow</li> </ul>	Mass flow
Unit totalizer	Select process variable totalizer unit.	Unit choose list	kg
Totalizer operation mode	Select totalizer calculation mode.	<ul style="list-style-type: none"> <li>▪ Net flow total</li> <li>▪ Forward flow total</li> <li>▪ Reverse flow total</li> </ul>	Net flow total
Failure mode	Define totalizer behavior in alarm condition.	<ul style="list-style-type: none"> <li>▪ Stop</li> <li>▪ Actual value</li> <li>▪ Last valid value</li> </ul>	Stop

### 10.3.4 Carrying out additional display configurations

In the **"Display"** submenu you can set all the parameters involved in the configuration of the local display.

#### Navigation

"Setup" menu → Advanced setup → Display

#### Structure of the submenu

<b>Display</b>	→	Format display
		Value 1 display
		0% bargraph value 1
		100% bargraph value 1
		Decimal places 1
		Value 2 display
		Decimal places 2
		Value 3 display
		0% bargraph value 3
		100% bargraph value 3
		Decimal places 3
		Value 4 display
		Decimal places 4
		Display language
		Display interval
		Display damping
		Header
		Header text
		Separator
		Backlight

## Parameter overview with brief description

Parameter	Description	Selection / User entry	Factory setting
Format display	Select how measured values are shown on the display.	<ul style="list-style-type: none"> <li>▪ 1 value, max. size</li> <li>▪ 1 bargraph + 1 value</li> <li>▪ 2 values</li> <li>▪ 1 value large + 2 values</li> <li>▪ 4 values</li> </ul>	1 value, max. size
Value 1 display	Select the measured value that is shown on the local display.	<ul style="list-style-type: none"> <li>▪ Mass flow</li> <li>▪ Volume flow</li> <li>▪ Corrected volume flow</li> <li>▪ Target mass flow</li> <li>▪ Carrier mass flow</li> <li>▪ Density</li> <li>▪ Reference density</li> <li>▪ Concentration</li> <li>▪ Dynamic viscosity</li> <li>▪ Kinematic viscosity</li> <li>▪ Temp. compensated dynamic viscosity</li> <li>▪ Temp. compensated kinematic viscosity</li> <li>▪ Temperature</li> <li>▪ Carrier pipe temperature</li> <li>▪ Electronic temperature</li> <li>▪ Oscillation frequency 0</li> <li>▪ Oscillation frequency 1</li> <li>▪ Oscillation amplitude 0</li> <li>▪ Oscillation amplitude 1</li> <li>▪ Frequency fluctuation 0</li> <li>▪ Frequency fluctuation 1</li> <li>▪ Oscillation damping 0</li> <li>▪ Oscillation damping 1</li> <li>▪ Tube damping fluctuation 0</li> <li>▪ Tube damping fluctuation 1</li> <li>▪ Signal asymmetry</li> <li>▪ Exciter current 0</li> <li>▪ Exciter current 1</li> <li>▪ Sensor integrity</li> <li>▪ None</li> <li>▪ Totalizer 1</li> <li>▪ Totalizer 2</li> <li>▪ Totalizer 3</li> <li>▪ Current output 1</li> </ul>	Mass flow
0% bargraph value 1	Enter 0% value for bar graph display.	Signed floating-point number	0 kg/h
100% bargraph value 1	Enter 100% value for bar graph display.	Signed floating-point number	2.5 kg/h
Decimal places 1	Select the number of decimal places for the display value.	<ul style="list-style-type: none"> <li>▪ x</li> <li>▪ x.x</li> <li>▪ x.xx</li> <li>▪ x.xxx</li> <li>▪ x.xxxx</li> </ul>	x.xx
Value 2 display	Select the measured value that is shown on the local display.	Picklist (see 1st display value)	None
Decimal places 2	Select the number of decimal places for the display value.	<ul style="list-style-type: none"> <li>▪ x</li> <li>▪ x.x</li> <li>▪ x.xx</li> <li>▪ x.xxx</li> <li>▪ x.xxxx</li> </ul>	x.xx
Value 3 display	Select the measured value that is shown on the local display.	Picklist (see 1st display value)	None
0% bargraph value 3	Enter 0% value for bar graph display.	Signed floating-point number	0
100% bargraph value 3	Enter 100% value for bar graph display.	Signed floating-point number	0

Parameter	Description	Selection / User entry	Factory setting
Decimal places 3	Select the number of decimal places for the display value.	<ul style="list-style-type: none"> <li>■ x</li> <li>■ x.x</li> <li>■ x.xx</li> <li>■ x.xxx</li> <li>■ x.xxxx</li> </ul>	x.xx
Value 4 display	Select the measured value that is shown on the local display.	Picklist (see 1st display value)	None
Decimal places 4	Select the number of decimal places for the display value.	<ul style="list-style-type: none"> <li>■ x</li> <li>■ x.x</li> <li>■ x.xx</li> <li>■ x.xxx</li> <li>■ x.xxxx</li> </ul>	x.xx
Display language	Set display language.	<ul style="list-style-type: none"> <li>■ English</li> <li>■ Deutsch</li> <li>■ Français</li> <li>■ Español</li> <li>■ Italiano</li> <li>■ Nederlands</li> <li>■ Portuguesa</li> <li>■ Polski</li> <li>■ русский язык (Russian)</li> <li>■ Svenska</li> <li>■ Türkçe</li> <li>■ 中文 (Chinese)</li> <li>■ 日本語 (Japanese)</li> <li>■ 한국어 (Korean)</li> <li>■ العربية (Arabic)</li> <li>■ Bahasa Indonesia</li> <li>■ ภาษาไทย (Thai)</li> <li>■ tiếng Việt (Vietnamese)</li> <li>■ čeština (Czech)</li> </ul>	English (alternatively, the ordered language is preset in the device)
Display interval	Set time measured values are shown on display if display alternates between values.	1 to 10 s	5 s
Display damping	Set display reaction time to fluctuations in the measured value.	0.0 to 999.9 s	0.0 s
Header	Select header contents on local display.	<ul style="list-style-type: none"> <li>■ Device tag</li> <li>■ Free text</li> </ul>	Device tag
Header text	Enter display header text.		-----
Separator	Select decimal separator for displaying numerical values.	<ul style="list-style-type: none"> <li>■ .</li> <li>■ ,</li> </ul>	.
Backlight	Switch the local display backlight on and off.	<ul style="list-style-type: none"> <li>■ Disable</li> <li>■ Enable</li> </ul>	Enable

### 10.4 Simulation

The "**Simulation**" submenu enables you to simulate, without a real flow situation, various process variables in the process and the device alarm mode and to verify downstream signal chains (switching valves or closed-control loops).

#### Navigation

"Diagnostics" menu → Simulation

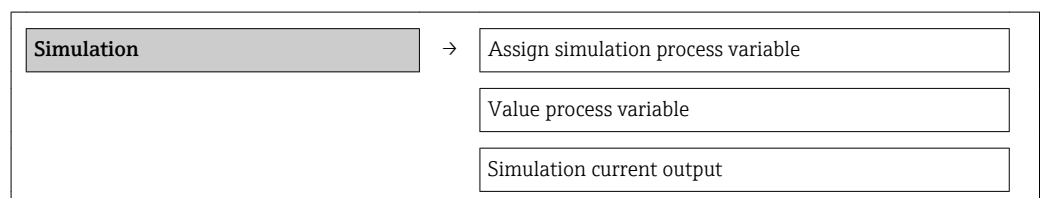

Value current output
Frequency simulation
Frequency value
Pulse simulation
Pulse value
Switch output simulation
Switch status
Simulation device alarm
Simulation diagnostic event

### Parameter overview with brief description



Parameter	Prerequisite	Description	Selection / User entry	Factory setting
Assign simulation process variable	–	Select a process variable for the simulation process that is activated.	<ul style="list-style-type: none"> <li>▪ Off</li> <li>▪ Mass flow</li> <li>▪ Volume flow</li> <li>▪ Corrected volume flow</li> <li>▪ Density</li> <li>▪ Reference density</li> <li>▪ Temperature</li> <li>▪ Dynamic viscosity</li> <li>▪ Kinematic viscosity</li> <li>▪ Temp. compensated dynamic viscosity</li> <li>▪ Temp. compensated kinematic viscosity</li> <li>▪ Concentration</li> <li>▪ Target mass flow</li> <li>▪ Carrier mass flow</li> </ul>	Off
Value process variable	A process variable is selected in the <b>Assign simulation process variable</b> parameter.	Enter the simulation value for the selected process variable.	Signed floating-point number	0
Simulation current output 1	–	Switch simulation of the current output on and off.	<ul style="list-style-type: none"> <li>▪ Off</li> <li>▪ On</li> </ul>	Off
Value current output 1	The <b>On</b> option is selected in the <b>Current output simulation</b> parameter.	Enter the current value for simulation.	$3.59^{-3}$ to $22.5^{-3}$ mA	3.59 mA
Frequency simulation 1	–	Switch simulation of the frequency output on and off.	<ul style="list-style-type: none"> <li>▪ Off</li> <li>▪ On</li> </ul>	Off
Frequency value 1	The <b>On</b> option is selected in the <b>Frequency output simulation</b> parameter.	Enter the frequency value for simulation.	0.0 to 12 500.0 Hz	0.0 Hz
Pulse simulation 1	The <b>Down-count. val.</b> option is selected in the <b>Simulation pulse output</b> parameter.	Switch simulation of the pulse output on and off.  If the <b>Fixed value</b> option is selected, the <b>Pulse width</b> parameter defines the pulse width of the pulses output.	<ul style="list-style-type: none"> <li>▪ Off</li> <li>▪ Fixed value</li> <li>▪ Down-counting value</li> </ul>	Off



Parameter	Prerequisite	Description	Selection / User entry	Factory setting
Pulse value 1	The <b>Down-count. val.</b> option is selected in the <b>Simulation pulse output</b> parameter.	Enter the number of pulses for simulation.	0 to 65535	0
Switch output simulation 1	–	Switch simulation of switch output on and off.	<ul style="list-style-type: none"> <li>■ Off</li> <li>■ On</li> </ul>	Off
Switch status 1	The <b>On</b> option is selected in the <b>Switch output simulation</b> parameter.	Select the status of the status output for the simulation.	<ul style="list-style-type: none"> <li>■ Open</li> <li>■ Closed</li> </ul>	Open
Simulation device alarm	–	Switch the device alarm on and off.	<ul style="list-style-type: none"> <li>■ Off</li> <li>■ On</li> </ul>	Off
Simulation diagnostic event	–	Switch simulation of the diagnostic event on and off.  For the simulation, you can choose from the diagnostic events of the category selected in the <b>Diagnostic event category</b> parameter.	<ul style="list-style-type: none"> <li>■ Off</li> <li>■ Picklist Diagnostic events (depends on the selected category)</li> </ul>	Off

## 10.5 Protecting settings from unauthorized access

The following options exist for protecting the configuration of the measuring device from unintentional modification after commissioning:

- Write protection via access code for Web browser (→  73)
- Write protection via write protection switch (→  74)

### 10.5.1 Write protection via access code

With the customer-specific access code, access to the measuring device via the Web browser is protected, as are the parameters for the measuring device configuration.

#### Navigation

"Setup" menu → Advanced setup → Administration → Define access code

*Structure of the submenu*

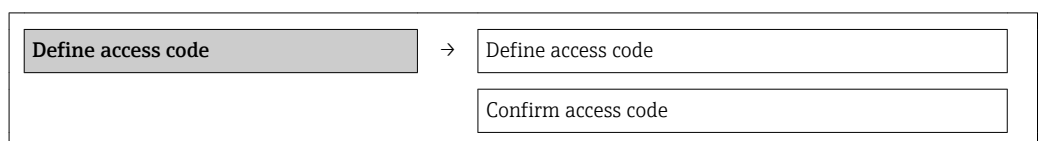

#### Defining the access code via the Web browser

1. Navigate to the **Enter access code** parameter.
2. Define a max. 4-digit numeric code as an access code.
3. Enter the access code again to confirm the code.
  - ↳ The Web browser switches to the login page.

 If no action is performed for 10 minutes, the Web browser automatically returns to the login page.

 The user role with which the user is currently logged on via the Web browser is indicated by the **Access status tooling** parameter. Navigation path: Operation → Access status tooling

## 10.5.2 Write protection via write protection switch

The write protection switch makes it possible to block write access to the entire operating menu with the exception of the following parameters:

- External pressure
- External temperature
- Reference density
- All parameters for configuring the totalizer

The parameter values are now read only and cannot be edited any more:

- Via service interface (CDI)
- Via HART protocol

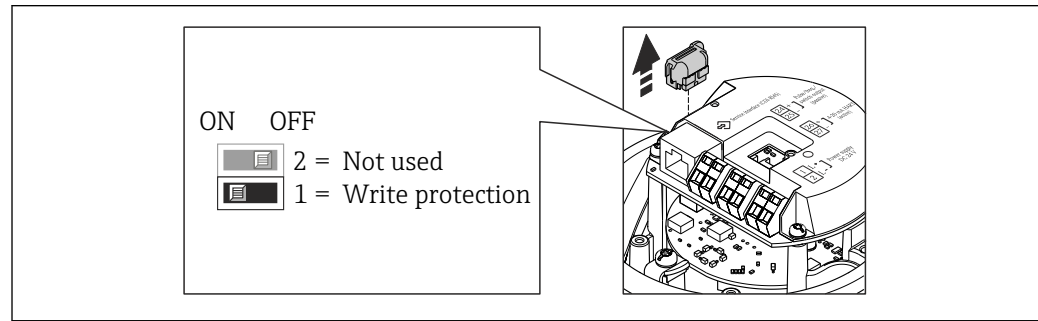

A0022571

1. Depending on the housing version, loosen the securing clamp or fixing screw of the housing cover.
2. Depending on the housing version, unscrew or open the housing cover and disconnect the local display from the main electronics module where necessary (→ ☰ 110).
3. Disconnect the T-DAT from the main electronics module.
4. Setting the write protection switch on the main electronics module to the ON position enables the hardware write protection. Setting the write protection switch on the main electronics module to the OFF position (factory setting) disables the hardware write protection.
  - ↳ If hardware write protection is enabled: the **Locking status** parameter displays the **Hardware locked** option (→ ☰ 75); if disabled, the **Locking status** parameter does not display any option (→ ☰ 75)
5. Reverse the removal procedure to reassemble the transmitter.

# 11 Operation

## 11.1 Reading device locking status

The write protection types that are currently active can be determined using the **Locking status** parameter.

### Navigation

"Operation" menu → Locking status

*Function scope of "Locking status" parameter*

Options	Description
Hardware locked	The locking switch (DIPswitch) for locking the hardware is activated on the main electronic module. This prevents write access to the parameters (→ 74).
Temporarily locked	Due to internal processing in the device (e.g. up-/downloading of data, reset), write access to the parameters is blocked for a short time. Once the internal processing has been completed, the parameters can be changed once again.

## 11.2 Configuring the display

- Basic settings for local display (→ 59)
- Advanced settings for local display (→ 69)

## 11.3 Reading measured values

Using the **Measured values** submenu, it is possible to read all the measured values.

"Diagnostics" menu → Measured values

### 11.3.1 Process variables

The **Process variables** submenu contains all the parameters needed to display the current measured values for every process variable.

### Navigation

"Diagnostics" menu → Measured values → Process variables

<b>Process variables</b>	Mass flow
	Volume flow
	Corrected volume flow
	Density
	Reference density
	Temperature
	Pressure value

**Parameter overview with brief description**

Parameter	Description	User interface
Mass flow	Displays the mass flow currently measured.	Signed floating-point number
Volume flow	Displays the calculated volume flow.	Signed floating-point number
Corrected volume flow	Displays the corrected volume flow currently calculated.	Signed floating-point number
Density	Displays the density currently measured.	Signed floating-point number
Reference density	Displays the reference density currently calculated.	Signed floating-point number
Temperature	Displays the temperature currently measured.	Signed floating-point number
Pressure value	Displays either a fixed or external pressure value.	Signed floating-point number

**11.3.2 Totalizer**

The "**Totalizer**" submenu contains all the parameters needed to display the current measured values for every totalizer.

**Navigation**

"Diagnostics" menu → Measured values → Totalizer

**Structure of the submenu**

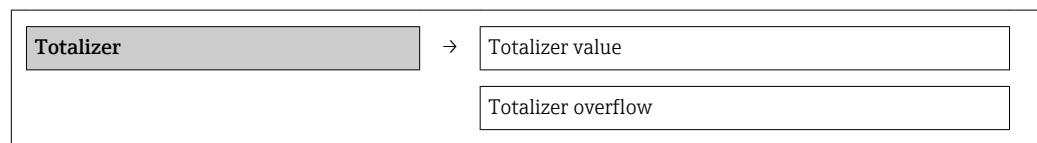

**Parameter overview with brief description**

Parameter	Prerequisite	Description	User interface	Factory setting
Totalizer value 1	In the <b>Assign process variable</b> parameter of <b>Totalizer 1 to 3</b> submenu one of the following options is selected: <ul style="list-style-type: none"> <li>▪ Volume flow</li> <li>▪ Mass flow</li> <li>▪ Corrected volume flow</li> </ul>	Displays the current totalizer counter value.	Signed floating-point number	0 kg
Totalizer overflow 1	In the <b>Assign process variable</b> parameter of <b>Totalizer 1 to 3</b> submenu one of the following options is selected: <ul style="list-style-type: none"> <li>▪ Volume flow</li> <li>▪ Mass flow</li> <li>▪ Corrected volume flow</li> </ul>	Displays the current totalizer overflow.	-32 000.0 to 32 000.0	0

**11.3.3 Output values**

The "**Output values**" submenu contains all the parameters needed to display the current measured values for every output.

**Navigation**

"Diagnostics" menu → Measured values → Output values

**Structure of the submenu**

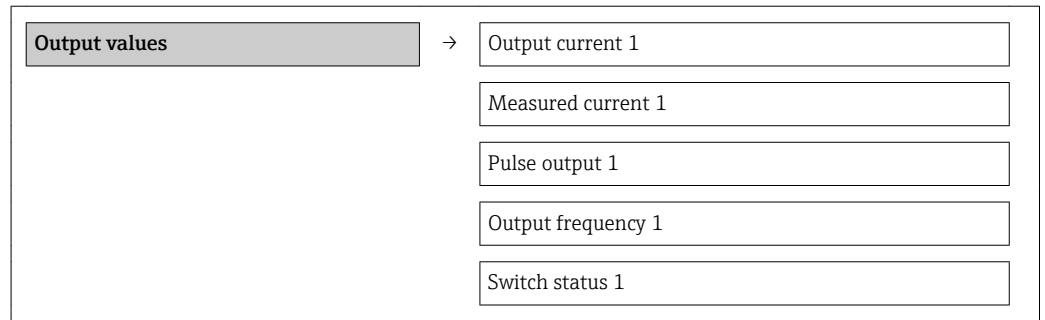

**Parameter overview with brief description**

Parameter	Description	User interface	Factory setting
Output current 1	Displays the current value currently calculated for the current output.	3.59 to 22.5 mA	3.59 mA
Measured current 1	Displays the current value currently measured for the current output.	0 to 30 mA	0 mA
Pulse output 1	Displays the value currently measured for the pulse output.	Positive floating-point number	0 Hz
Output frequency 1	Displays the value currently measured for the frequency output.	0.0 to 12 500.0 Hz	0.0 Hz
Switch status 1	Displays the current switch output status.	<ul style="list-style-type: none"> <li>■ Open</li> <li>■ Closed</li> </ul>	Open

## 11.4 Adapting the measuring device to the process conditions

The following are available for this purpose:

- Basic settings using the **Setup** menu(→ 📖 49)
- Advanced settings using the **Advanced setup** submenu(→ 📖 66)

## 11.5 Performing a totalizer reset

In the **Operation** submenu the totalizers are reset:

- Control Totalizer
- Reset all totalizers

*Function scope of "Control Totalizer " parameter*

Options	Description
Totalize	The totalizer is started.
Stop	Totalizing is stopped.
Reset + hold	The totaling process is stopped and the totalizer is reset to 0.
Preset + hold	The totaling process is stopped and the totalizer is set to its defined start value from the <b>Preset value</b> parameter.
Reset + totalize	The totalizer is reset to 0 and the totaling process is restarted.
Preset + totalize	The totalizer is set to the defined start value in <b>Preset value</b> parameter and the totaling process is restarted.

*Function scope of "Reset all totalizers" parameter*

Options	Description
Reset + totalize	Resets all totalizers to 0 and restarts the totaling process. This deletes all the flow values previously totalized.

**Navigation**

"Operation" menu → Operation

**Structure of the submenu**

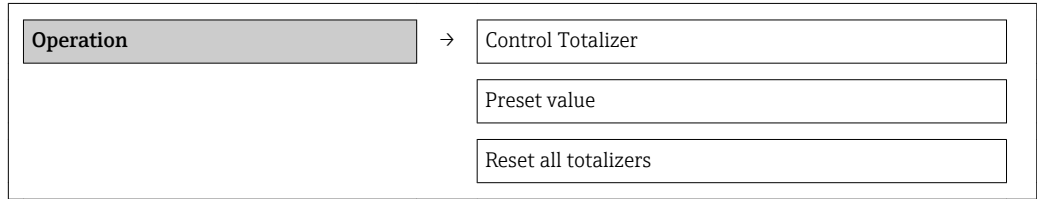

**Parameter overview with brief description**

Parameter	Description	Selection / User entry	Factory setting
Control Totalizer #	Control totalizer value.	<ul style="list-style-type: none"> <li>■ Totalize</li> <li>■ Reset + hold</li> <li>■ Preset + hold</li> <li>■ Reset + totalize</li> <li>■ Preset + totalize</li> </ul>	Totalize
Preset value #	Specify start value for totalizer.	Signed floating-point number	0 kg
Reset all totalizers	Reset all totalizers to 0 and start.	<ul style="list-style-type: none"> <li>■ Cancel</li> <li>■ Reset + totalize</li> </ul>	Cancel





## 12 Diagnostics and troubleshooting

### 12.1 General troubleshooting

*For output signals*

Problem	Possible causes	Remedy
Green power LED on the main electronics module of the transmitter is dark	Supply voltage does not match that specified on the nameplate.	Apply the correct supply voltage (→  29).
Device measures incorrectly.	Configuration error or device is operated outside the application.	1. Check and correct parameter configuration. 2. Observe limit values specified in the "Technical Data".

*For access*

Problem	Possible causes	Remedy
No write access to parameters	Hardware write protection enabled	Set the write protection switch on the main electronics module to the OFF position (→  74).
No connection via HART protocol	Missing or incorrectly installed communication resistor.	Install the communication resistor (250 Ω) correctly. Observe the maximum load (→  97).
No connection via HART protocol	Commubox <ul style="list-style-type: none"> <li>▪ Connected incorrectly</li> <li>▪ Configured incorrectly</li> <li>▪ Drivers not installed correctly</li> <li>▪ USB interface on computer configured incorrectly</li> </ul>	Observe the documentation for the Commubox.  FXA195 HART: Document "Technical Information" TI00404F
Not connecting to Web server	Incorrect setting for the Ethernet interface of the computer	1. Check the properties of the Internet protocol (TCP/IP) (→  36). 2. Check the network settings with the IT manager.
Not connecting to Web server	Web server disabled	Via the "FieldCare" operating tool check whether the Web server of the measuring device is enabled and enable it if necessary (→  38).
No or incomplete display of contents in the Web browser	<ul style="list-style-type: none"> <li>▪ JavaScript not enabled</li> <li>▪ JavaScript cannot be enabled</li> </ul>	1. Enable JavaScript. 2. Enter http://XXX.XXX.X.XXX/basic.html as the IP address.
Web browser frozen and operation no longer possible	Data transfer active	Wait until data transfer or current action is finished.
Web browser frozen and operation no longer possible	Connection lost	1. Check cable connection and power supply. 2. Refresh the Web browser and restart if necessary.
Content of Web browser incomplete or difficult to read	Not using optimum version of Web server.	1. Use the correct Web browser version (→  36). 2. Clear the Web browser cache and restart the Web browser.
Content of Web browser incomplete or difficult to read	Unsuitable view settings.	Change the font size/display ratio of the Web browser.

## 12.2 Diagnostic information via light emitting diodes

### 12.2.1 Transmitter

Various light emitting diodes (LEDs) on the main electronics module of the transmitter provide information on device status.

LED	Color	Meaning
Power	Off	Supply voltage is off or too low
	Green	Supply voltage is ok
Link/Activity	Orange	Link available but no activity
	Flashing orange	Activity present
Communication	Flashing white	HART communication is active.

## 12.3 Diagnostic information in FieldCare

### 12.3.1 Diagnostic options

Any faults detected by the measuring device are displayed on the home page of the operating tool once the connection has been established.

The screenshot shows the FieldCare software interface. At the top, there is a status bar with the following information: Device name: Xxxxxx, Device tag: Xxxxxx, Status signal: Function check (C). To the right of the status bar, there are two rows of data: Mass flow: 12.34 kg/h and Volume flow: 12.34 m³/h. Below the status bar is a tree view on the left with the following structure: Xxxxxx, Diagnostics 1: C485 Simu..., Remedy information: Deactivate..., Access status tooling: Maintenance, Operation, Setup, Diagnostics, Expert. The main panel on the right is titled 'Instrument health status' and contains a list of fault types: Failure (F), Function check (C), Out of specification (S), and Maintenance required (M). The Function check (C) section is expanded, showing 'Diagnostics 1' and 'Remedy information' with associated service IDs. Callouts 1, 2, and 3 point to the status signal, diagnostic information, and remedial measures respectively.

- 1 Status area with status signal
- 2 Diagnostic information (→ 81)
- 3 Remedial measures with Service ID





**i** Furthermore, diagnostic events that have occurred can be viewed in the **Diagnostics** menu:

- Via parameters (→ 85)
- Via submenu (→ 86)



### Status signals

The status signals provide information on the state and reliability of the device by categorizing the cause of the diagnostic information (diagnostic event).

Symbol	Meaning
 A0017271	<b>Failure</b> A device error has occurred. The measured value is no longer valid.
 A0017278	<b>Function check</b> The device is in service mode (e.g. during a simulation).
 A0017277	<b>Out of specification</b> The device is operated: <ul style="list-style-type: none"> <li>▪ Outside its technical specification limits (e.g. outside the process temperature range)</li> <li>▪ Outside of the configuration carried out by the user (e.g. maximum flow in parameter <b>20 mA value</b>)</li> </ul>
 A0017276	<b>Maintenance required</b> Maintenance is required. The measured value is still valid.

 The status signals are categorized in accordance with VDI/VDE 2650 and NAMUR Recommendation NE 107.

### Diagnostic information

The fault can be identified using the diagnostic information. The short text helps you by providing information about the fault.

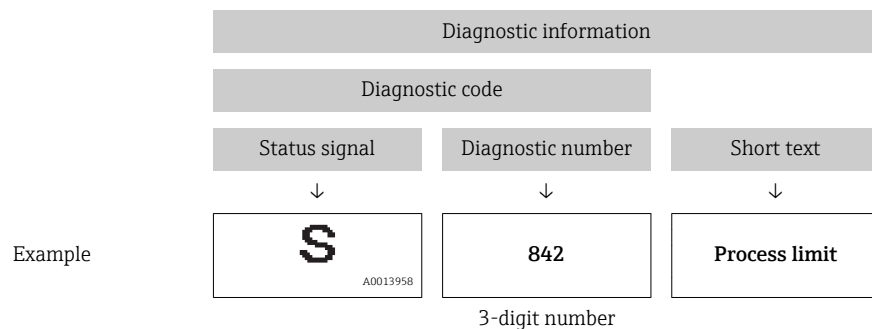

### 12.3.2 Calling up remedy information

Remedy information is provided for every diagnostic event to ensure that problems can be rectified quickly:

- On the home page  
Remedy information is displayed in a separate field below the diagnostics information.
- In the **Diagnostics** menu  
Remedy information can be called up in the working area of the user interface.

The user is in the **Diagnostics** menu.

1. Call up the desired parameter.
2. On the right in the working area, mouse over the parameter.
  - ↳ A tool tip with remedy information for the diagnostic event appears.

## 12.4 Adapting the diagnostic information

### 12.4.1 Adapting the diagnostic behavior

Each item of diagnostic information is assigned a specific diagnostic behavior at the factory. The user can change this assignment for certain diagnostics information in the **Diagnostic behavior** submenu .

"Expert" menu → System → Diagnostic handling → Diagnostic behavior

You can assign the following options to the diagnostic number as the diagnostic behavior:

Options	Description
Alarm	Measurement is interrupted. Signal outputs and totalizers assume the defined alarm condition. A diagnostic message is generated.
Warning	Measurement is resumed. The signal outputs and totalizers are not affected. A diagnostic message is generated.
Logbook entry only	The device continues to measure. The diagnostic message is entered in the Event logbook (events list) submenu only and is not displayed in alternation with the measured value display.
Off	The diagnostic event is ignored, and no diagnostic message is generated or entered.

### 12.4.2 Adapting the status signal

Each item of diagnostic information is assigned a specific status signal at the factory. The user can change this assignment for certain diagnostic information in the **Diagnostic event category** submenu .

"Expert" menu → Communication → Diagnostic event category



#### Available status signals

Configuration as per HART 7 Specification (Condensed Status), in accordance with NAMUR NE107.

Symbol	Meaning
<b>F</b> A0013956	<b>Failure</b> A device error has occurred. The measured value is no longer valid.
<b>C</b> A0013959	<b>Function check</b> The device is in service mode (e.g. during a simulation).
<b>S</b> A0013958	<b>Out of specification</b> The device is being operated: <ul style="list-style-type: none"> <li>▪ Outside its technical specification limits (e.g. outside the process temperature range)</li> <li>▪ Outside of the configuration carried out by the user (e.g. maximum flow in parameter 20 mA value)</li> </ul>
<b>M</b> A0013957	<b>Maintenance required</b> Maintenance is required. The measured value is still valid.
<b>N</b> A0023076	Has no effect on the condensed status.

## 12.5 Overview of diagnostic information

 The amount of diagnostic information and the number of measured variables affected increase if the measuring device has one or more application packages.

 In the case of some items of diagnostic information, the status signal and the diagnostic behavior can be changed. Adapt the diagnostic information (→  82)

Diagnostic number	Short text	Remedy instructions	Status signal [from the factory]	Diagnostic behavior [from the factory]
<b>Diagnostic of sensor</b>				
022	Sensor temperature	1.Change main electronic module 2.Change sensor	F	Alarm
046	Sensor limit exceeded	1. Inspect sensor 2. Check process condition	S	Alarm
062	Sensor connection	1.Change main electronic module 2.Change sensor	F	Alarm
082	Data storage	1. Check module connections 2. Contact service	F	Alarm
083	Memory content	1. Restart device 2. Contact service	F	Alarm
140	Sensor signal	1.Check or change main electronics 2.Change sensor	S	Alarm
144	Measuring error too high	1. Check or change sensor 2. Check process conditions	F	Alarm
190	Special event 1	Contact service	F	Alarm
191	Special event 5	Contact service	F	Alarm
192	Special event 9	Contact service	F	Alarm <sup>1)</sup>
<b>Diagnostic of electronic</b>				
201	Device failure	1. Restart device 2. Contact service	F	Alarm
242	Software incompatible	1. Check software 2. Flash or change main electronics module	F	Alarm
252	Modules incompatible	1. Check electronic modules 2. Change electronic modules	F	Alarm
262	Module connection	1. Check module connections 2. Change main electronics	F	Alarm
270	Main electronic failure	Change main electronic module	F	Alarm
271	Main electronic failure	1. Restart device 2. Change main electronic module	F	Alarm
272	Main electronic failure	1. Restart device 2. Contact service	F	Alarm
273	Main electronic failure	Change electronic	F	Alarm
274	Main electronic failure	Change electronic	S	Warning
283	Memory content	1. Reset device 2. Contact service	F	Alarm
302	Device verification active	Device verification active, please wait.	C	Warning
311	Electronic failure	1. Reset device 2. Contact service	F	Alarm
311	Electronic failure	1. Do not reset device 2. Contact service	M	Warning
375	I/O communication failed	1. Restart device 2. Change main electronic module	F	Alarm
382	Data storage	1. Insert DAT module 2. Change DAT module	F	Alarm

Diagnostic number	Short text	Remedy instructions	Status signal [from the factory]	Diagnostic behavior [from the factory]
383	Memory content	1. Restart device 2. Check or change DAT module 3. Contact service	F	Alarm
390	Special event 2	Contact service	F	Alarm
391	Special event 6	Contact service	F	Alarm
392	Special event 10	Contact service	F	Alarm <sup>1)</sup>
<b>Diagnostic of configuration</b>				
410	Data transfer	1. Check connection 2. Retry data transfer	F	Alarm
411	Up-/download active	Up-/download active, please wait	C	Warning
431	Trim 1	Carry out trim	C	Warning
437	Configuration incompatible	1. Restart device 2. Contact service	F	Alarm
438	Dataset	1. Check data set file 2. Check device configuration 3. Up- and download new configuration	M	Warning
441	Current output 1	1. Check process 2. Check current output settings	S	Warning <sup>1)</sup>
442	Frequency output	1. Check process 2. Check frequency output settings	S	Warning <sup>1)</sup>
443	Pulse output	1. Check process 2. Check pulse output settings	S	Warning <sup>1)</sup>
453	Flow override	Deactivate flow override	C	Warning
484	Simulation failure mode	Deactivate simulation	C	Alarm
485	Simulation measured variable	Deactivate simulation	C	Warning
491	Simulation current output 1	Deactivate simulation	C	Warning
492	Simulation frequency output	Deactivate simulation frequency output	C	Warning
493	Simulation pulse output	Deactivate simulation pulse output	C	Warning
494	Switch output simulation	Deactivate simulation switch output	C	Warning
495	Simulation diagnostic event	Deactivate simulation	C	Warning
537	Configuration	1. Check IP addresses in network 2. Change IP address	F	Warning
590	Special event 3	Contact service	F	Alarm
591	Special event 7	Contact service	F	Alarm
592	Special event 11	Contact service	F	Alarm <sup>1)</sup>
<b>Diagnostic of process</b>				
803	Current loop	1. Check wiring 2. Change I/O module	F	Alarm
830	Sensor temperature too high	Reduce ambient temp. around the sensor housing	S	Warning

Diagnostic number	Short text	Remedy instructions	Status signal [from the factory]	Diagnostic behavior [from the factory]
831	Sensor temperature too low	Increase ambient temp. around the sensor housing	S	Warning
832	Electronic temperature too high	Reduce ambient temperature	S	Warning <sup>1)</sup>
833	Electronic temperature too low	Increase ambient temperature	S	Warning <sup>1)</sup>
834	Process temperature too high	Reduce process temperature	S	Warning <sup>1)</sup>
835	Process temperature too low	Increase process temperature	S	Warning <sup>1)</sup>
842	Process limit	Low flow cut off active! 1. Check low flow cut off configuration	S	Warning
843	Process limit	Check process conditions	S	Warning
862	Partly filled pipe	1. Check for gas in process 2. Adjust detection limits	S	Warning
882	Input signal	1. Check input configuration 2. Check external device or process conditions	F	Alarm
910	Tubes not oscillating	1. Check electronic 2. Inspect sensor	F	Alarm
912	Medium inhomogeneous	1. Check process cond. 2. Increase system pressure	S	Warning
912	Inhomogeneous	1. Check process cond. 2. Increase system pressure	S	Warning
913	Medium unsuitable	1. Check process conditions 2. Check electronic modules or sensor	S	Alarm
944	Monitoring failed	Check process conditions for Heartbeat Monitoring	S	Warning
948	Tube damping too high	Check process conditions	S	Warning
990	Special event 4	Contact service	F	Alarm
991	Special event 8	Contact service	F	Alarm
992	Special event 12	Contact service	F	Alarm <sup>1)</sup>

1) Diagnostic status is changeable.

## 12.6 Pending diagnostic events

The **Diagnostics** menu allows the user to view the current diagnostic event and the previous diagnostic event separately.



To call up the measures to rectify a diagnostic event:

- Via Web browser
- Via "FieldCare" operating tool (→ 81)



Other pending diagnostic events can be displayed in the **Diagnostic list** submenu (→ 86)

### Navigation

"Diagnostics" menu

### Structure of the submenu

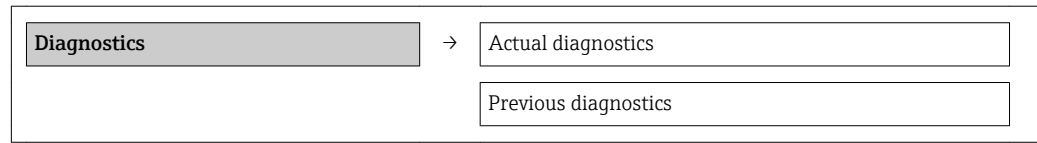

### Parameter overview with brief description

Parameter	Prerequisite	Description	User interface	Factory setting
Actual diagnostics	1 diagnostic event has occurred.	Displays the current diagnostic event along with the diagnostic information.  If two or more messages occur simultaneously, the message with the highest priority is shown on the display.	Symbol for diagnostic behavior, diagnostic code and short message.	–
Previous diagnostics	2 diagnostic events have already occurred.	Displays the diagnostic event that occurred prior to the current diagnostic event along with the diagnostic information.	Symbol for diagnostic behavior, diagnostic code and short message.	–

## 12.7 Diagnostic list

In the **Diagnostic list** submenu, up to 5 currently pending diagnostic events can be displayed along with the related diagnostic information. If more than 5 diagnostic events are pending, the events with the highest priority are shown on the display.

### Navigation path

**Diagnostics** menu → **Diagnostic list** submenu

 To call up the measures to rectify a diagnostic event:

- Via Web browser
- Via "FieldCare" operating tool (→  81)

## 12.8 Event logbook



### 12.8.1 Event history

A chronological overview of the event messages that have occurred is provided in the **Events list** submenu.



### Navigation path



"Diagnostics" menu → Event logbook → Events list

The event history includes entries for:

- Diagnostic events (→  82)
- Information events (→  87)

In addition to the operation time of its occurrence, each event is also assigned a symbol that indicates whether the event has occurred or is ended:

- Diagnostic event
  - : Event has occurred
  - : Event has ended
- Information event
  - : Event has occurred

-  To call up the measures to rectify a diagnostic event:
  - Via Web browser
  - Via "FieldCare" operating tool (→  81)

-  For filtering the displayed event messages (→  87)

### 12.8.2 Filtering the event logbook

Using the **Filter options** parameter, you can define which category of event messages is displayed in the **Events list** submenu.

#### Navigation path

"Diagnostics" menu → Event logbook → Filter options

#### Filter categories

- All
- Failure (F)
- Function check (C)
- Out of specification (S)
- Maintenance required (M)
- Information (I)

### 12.8.3 Overview of information events

Unlike a diagnostic event, an information event is displayed in the event logbook only and not in the diagnostic list.

Info number	Info name
I1000	----- (Device ok)
I1089	Power on
I1090	Configuration reset
I1091	Configuration changed
I1110	Write protection switch changed
I1111	Density adjust failure
I1137	Electronic changed
I1151	History reset
I1155	Reset electronic temperature
I1157	Memory error event list
I1185	Display backup done
I1186	Restore via display done
I1187	Settings downloaded with display
I1188	Display data cleared
I1189	Backup compared
I1209	Density adjustment ok
I1221	Zero point adjust failure
I1222	Zero point adjustment ok
I1256	Display: access status changed
I1264	Safety sequence aborted
I1278	I/O module reset detected
I1335	Firmware changed
I1361	Wrong web server login

Info number	Info name
I1397	Fieldbus: access status changed
I1398	CDI: access status changed
I1444	Device verification passed
I1445	Device verification failed
I1446	Device verification active
I1447	Record application reference data
I1448	Application reference data recorded
I1449	Recording application ref. data failed
I1450	Monitoring off
I1451	Monitoring on
I1457	Failed: Measured error verification
I1459	Failed: I/O module verification
I1460	Failed: Sensor integrity verification
I1461	Failed: Sensor verification
I1462	Failed: Sensor electronic module verific.

## 12.9 Resetting the measuring device

Using the **Device reset** parameter it is possible to reset the entire device configuration or some of the configuration to a defined state.

"Setup" menu → Advanced setup → Administration

*Function scope of "Device reset" parameter*

Options	Description
Cancel	No action is executed and the user exits the parameter.
To delivery settings	Every parameter for which a customer-specific default setting was ordered is reset to this customer-specific value. All other parameters are reset to the factory setting.  This option is not visible if no customer-specific settings have been ordered.
Restart device	The restart resets every parameter whose data are in the volatile memory (RAM) to the factory setting (e.g. measured value data). The device configuration remains unchanged.
History reset	Every parameter is reset to its factory setting.

## 12.10 Device information

The **Device information** submenu contains all the parameters that display different information for identifying the device.

### Navigation

"Diagnostics" menu → Device information

<b>Device information</b>	→	Device tag
		Serial number
		Firmware version



Device name
Order code
Extended order code 1
Extended order code 2
Extended order code 3
ENP version
Device revision
Device ID
Device type
Manufacturer ID
IP address
Subnet mask
Default gateway

### Parameter overview with brief description

Parameter	Description	User interface	Factory setting
Device tag	Enter tag for measuring point.	Max. 32 characters, such as letters, numbers or special characters (e.g. @, %, /)	Promass 100
Serial number	Displays the serial number of the measuring device.	Max. 11-digit character string comprising letters and numbers.	79AFF16000
Firmware version	Displays the device firmware version installed.	Character string with the following format: xx.yy.zz	01.01
Device name	Displays the name of the transmitter.	Character string composed of letters, numbers and certain punctuation marks.	Promass 100
Order code	Displays the device order code.	Character string composed of letters, numbers and certain punctuation marks	-
Extended order code 1	Displays the 1st part of the extended order code.	Character string	-
Extended order code 2	Displays the 2nd part of the extended order code.	Character string	-
Extended order code 3	Displays the 3rd part of the extended order code.	Character string	-
ENP version	Displays the version of the electronic nameplate.	Character string in the format xx.yy.zz	2.02.00
Device revision	Displays the device revision with which the device is registered with the HART Communication Foundation.	0 to 255	2
Device ID	Displays the device ID for identifying the device in a HART network.	Positive integer	6-digit hexadecimal number

Parameter	Description	User interface	Factory setting
Device type	Displays the device type with which the measuring device is registered with the HART Communication Foundation.	0 to 255	74
Manufacturer ID	Displays the manufacturer ID with which the measuring device is registered with the HART Communication Foundation.	0 to 255	17
IP address	Displays the IP address of the Web server of the measuring device.	4 octet: 0 to 255 (in the particular octet)	192.168.1.212
Subnet mask	Displays the subnet mask.	4 octet: 0 to 255 (in the particular octet)	255.255.255.0
Default gateway	Displays the default gateway.	4 octet: 0 to 255 (in the particular octet)	0.0.0.0

## 12.11 Firmware history

Release date	Firmware version	Order code for "Firmware version"	Firmware changes	Documentation type	Documentation
04.2013	01.00.00	Option 76	Original firmware	Operating Instructions	BA01187D/06/EN/01.13
06.2014	01.01.zz	Option 70	<ul style="list-style-type: none"> <li>▪ In accordance with HART 7 Specification</li> <li>▪ Integration of optional onsite display</li> <li>▪ New unit "Beer Barrel (BBL)"</li> <li>▪ Monitoring of measuring tube damping</li> <li>▪ Simulation of diagnostic events</li> <li>▪ External verification of the current and PFS output via the Heartbeat application package</li> <li>▪ Fixed value for simulation pulses</li> </ul>	Operating Instructions	BA01187D/06/EN/02.14

 Flashing the firmware to the current version or to the previous version is possible via the service interface (CDI) .

 For the compatibility of the firmware version with the previous version, the installed device description files and operating tools, observe the information about the device in the "Manufacturer's information" document.

 The manufacturer's information is available:

- In the Download Area of the Endress+Hauser Internet site: [www.endress.com](http://www.endress.com) → Download
- Specify the following details:
  - Product root, e.g. 8E1B
  - Text search: Manufacturer's information
  - Search range: documentation

## 13 Maintenance

### 13.1 Maintenance tasks

No special maintenance work is required.

#### 13.1.1 Exterior cleaning

When cleaning the exterior of measuring devices, always use cleaning agents that do not attack the surface of the housing or the seals.

#### 13.1.2 Interior cleaning

Observe the following points for CIP and SIP cleaning:

- Use only cleaning agents to which the process-wetted materials are adequately resistant.
- Observe the maximum permitted medium temperature for the measuring device (→  105).

### 13.2 Measuring and test equipment

Endress+Hauser offers a wide variety of measuring and test equipment, such as W@M or device tests.

 Your Endress+Hauser Sales Center can provide detailed information on the services.

 For a list of some of the measuring and test equipment, refer to the "Accessories" chapter of the "Technical Information" document for the device.

### 13.3 Endress+Hauser services

Endress+Hauser offers a wide variety of services for maintenance such as recalibration, maintenance service or device tests.

 Your Endress+Hauser Sales Center can provide detailed information on the services.

## 14 Repair

### 14.1 General notes

#### Repair and conversion concept

The Endress+Hauser repair and conversion concept provides for the following:

- The measuring devices have a modular design.
- Spare parts are grouped into logical kits with the associated Installation Instructions.
- Repairs are carried out by Endress+Hauser Service or by correspondingly trained customers.
- Certified devices can be converted into other certified devices by Endress+Hauser Service or at the factory only.

#### Notes for repair and conversion

For repair and modification of a measuring device, observe the following notes:

- Use only original Endress+Hauser spare parts.
- Carry out the repair according to the Installation Instructions.
- Observe the applicable standards, federal/national regulations, Ex documentation (XA) and certificates.
- Document every repair and each conversion and enter them into the *W@M* life cycle management database.

### 14.2 Spare parts



Measuring device serial number:

- Is located on the nameplate of the device.
- Can be read out via the **Serial number** parameter in the **Device information** submenu (→ 88).

### 14.3 Endress+Hauser services



Contact your Endress+Hauser Sales Center for information on services and spare parts.

### 14.4 Return

The measuring device must be returned if repairs or a factory calibration are required, or if the wrong measuring device has been ordered or delivered. According to legal regulations, Endress+Hauser, as an ISO-certified company, is required to follow certain procedures when handling returned products that are in contact with medium.

To ensure swift, safe and professional device returns, please read the return procedures and conditions on the Endress+Hauser website at

[www.services.endress.com/return-material](http://www.services.endress.com/return-material)

### 14.5 Disposal

#### 14.5.1 Removing the measuring device

1. Switch off the device.
2. **WARNING!** Danger to persons from process conditions. Beware of hazardous process conditions such as pressure in the measuring device, high temperatures or aggressive fluids.

Carry out the mounting and connection steps from the chapters "Mounting the measuring device" and "Connecting the measuring device" in the logically reverse sequence. Observe the safety instructions.

### 14.5.2 Disposing of the measuring device

**⚠ WARNING**

**Danger to personnel and environment from fluids that are hazardous to health.**

- ▶ Ensure that the measuring device and all cavities are free of fluid residues that are hazardous to health or the environment, e.g. substances that have permeated into crevices or diffused through plastic.

Observe the following notes during disposal:

- Observe valid federal/national regulations.
- Ensure proper separation and reuse of the device components.

## 15 Accessories







Various accessories, which can be ordered with the device or subsequently from Endress+Hauser, are available for the device. Detailed information on the order code in question is available from your local Endress+Hauser sales center or on the product page of the Endress+Hauser website: [www.endress.com](http://www.endress.com).

### 15.1 Device-specific accessories

#### 15.1.1 For the sensor

Accessories	Description
Heating jacket	<p>Is used to stabilize the temperature of the fluids in the sensor. Water, water vapor and other non-corrosive liquids are permitted for use as fluids. If using oil as a heating medium, please consult with Endress+Hauser. Heating jackets cannot be used with sensors fitted with a rupture disk.</p> <p> For details, see Operating Instructions BA00099D</p>



### 15.2 Communication-specific accessories

Accessories	Description
Commubox FXA195 HART	<p>For intrinsically safe HART communication with FieldCare via the USB interface.</p> <p> For details, see "Technical Information" TI00404F</p>
HART Loop Converter HMX50	<p>Is used to evaluate and convert dynamic HART process variables to analog current signals or limit values.</p> <p> For details, see "Technical Information" TI00429F and Operating Instructions BA00371F</p>
Wireless HART adapter SWA70	<p>Is used for the wireless connection of field devices. The WirelessHART adapter can be easily integrated into field devices and existing infrastructures, offers data protection and transmission safety and can be operated in parallel with other wireless networks with minimum cabling complexity.</p> <p> For details, see Operating Instructions BA00061S</p>
Fieldgate FXA320	<p>Gateway for the remote monitoring of connected 4-20 mA measuring devices via a Web browser.</p> <p> For details, see "Technical Information" TI00025S and Operating Instructions BA00053S</p>
Fieldgate FXA520	<p>Gateway for the remote diagnostics and remote configuration of connected HART measuring devices via a Web browser.</p> <p> For details, see "Technical Information" TI00025S and Operating Instructions BA00051S</p>
Field Xpert SFX350	<p>Field Xpert SFX350 is a mobile computer for commissioning and maintenance. It enables efficient device configuration and diagnostics for HART and FOUNDATION Fieldbus devices in the <b>non-Ex area</b>.</p> <p> For details, see Operating Instructions BA01202S</p>
Field Xpert SFX370	<p>Field Xpert SFX370 is a mobile computer for commissioning and maintenance. It enables efficient device configuration and diagnostics for HART and FOUNDATION Fieldbus devices in the <b>non-Ex area</b> and the <b>Ex area</b>.</p> <p> For details, see Operating Instructions BA01202S</p>

## 15.3 Service-specific accessories

Accessories	Description
Applicator	<p>Software for selecting and sizing Endress+Hauser measuring devices:</p> <ul style="list-style-type: none"> <li>Calculation of all the necessary data for identifying the optimum flowmeter: e.g. nominal diameter, pressure loss, accuracy or process connections.</li> <li>Graphic illustration of the calculation results</li> </ul> <p>Administration, documentation and access to all project-related data and parameters over the entire life cycle of a project.</p> <p>Applicator is available:</p> <ul style="list-style-type: none"> <li>Via the Internet: <a href="https://wapps.endress.com/applicator">https://wapps.endress.com/applicator</a></li> <li>On CD-ROM for local PC installation.</li> </ul>
W@M	<p>Life cycle management for your plant</p> <p>W@M supports you with a wide range of software applications over the entire process: from planning and procurement, to the installation, commissioning and operation of the measuring devices. All the relevant device information, such as the device status, spare parts and device-specific documentation, is available for every device over the entire life cycle.</p> <p>The application already contains the data of your Endress+Hauser device. Endress+Hauser also takes care of maintaining and updating the data records.</p> <p>W@M is available:</p> <ul style="list-style-type: none"> <li>Via the Internet: <a href="http://www.endress.com/lifecyclemanagement">www.endress.com/lifecyclemanagement</a></li> <li>On CD-ROM for local PC installation.</li> </ul>
FieldCare	<p>FDT-based plant asset management tool from Endress+Hauser.</p> <p>It can configure all smart field units in your system and helps you manage them. By using the status information, it is also a simple but effective way of checking their status and condition.</p> <p> For details, see Operating Instructions BA00027S and BA00059S</p>

## 15.4 System components

Accessories	Description
Memograph M graphic display recorder	<p>The Memograph M graphic display recorder provides information on all relevant measured variables. Measured values are recorded correctly, limit values are monitored and measuring points analyzed. The data are stored in the 256 MB internal memory and also on a SD card or USB stick.</p> <p> For details, see "Technical Information" TI00133R and Operating Instructions BA00247R</p>
iTEMP	<p>The temperature transmitters can be used in all applications and are suitable for the measurement of gases, steam and liquids. They can be used to read in the fluid temperature.</p> <p> For details, see "Fields of Activity", FA00006T</p>

## 16 Technical data

### 16.1 Application

The measuring device is suitable for flow measurement of liquids and gases only.

Depending on the version ordered, the measuring device can also measure potentially explosive, flammable, poisonous and oxidizing media.

To ensure that the device remains in proper operating condition for its service life, use the measuring device only for media against which the process-wetted materials are adequately resistant.

### 16.2 Function and system design

Measuring principle	Mass flow measurement based on the Coriolis measuring principle
Measuring system	One device version is available: compact version, transmitter and sensor form a mechanical unit. For information on the structure of the device (→  11)

### 16.3 Input

Measured variable	<b>Direct measured variables</b>
	<ul style="list-style-type: none"> <li>▪ Mass flow</li> <li>▪ Density</li> <li>▪ Temperature</li> </ul>
	<b>Calculated measured variables</b>
	<ul style="list-style-type: none"> <li>▪ Volume flow</li> <li>▪ Corrected volume flow</li> <li>▪ Reference density</li> </ul>

Measuring range	<b>Measuring ranges for liquids</b>			
	DN		Measuring range full scale values $\dot{m}_{\min(F)}$ to $\dot{m}_{\max(F)}$	
	[mm]	[in]	[kg/h]	[lb/min]
	1	1/24	0 to 20	0 to 0.735
	2	1/12	0 to 100	0 to 3.675
	4	1/8	0 to 450	0 to 16.54

#### Measuring ranges for gases

The full scale values depend on the density of the gas and can be calculated with the formula below:

$$\dot{m}_{\max(G)} = \dot{m}_{\max(F)} \cdot \rho_G : X$$

$\dot{m}_{\max(G)}$	Maximum full scale value for gas [kg/h]
$\dot{m}_{\max(F)}$	Maximum full scale value for liquid [kg/h]



$\dot{m}_{\max(G)} < \dot{m}_{\max(F)}$	$\dot{m}_{\max(G)}$ can never be greater than $\dot{m}_{\max(F)}$
$\rho_G$	Gas density in [kg/m <sup>3</sup> ] at operating conditions

	DN		x [kg/m <sup>3</sup> ]
	[mm]	[in]	
1		1/24	32
2		1/12	32
4		1/8	32

### Calculation example for gas

- Sensor: Promass A, DN 2
- Gas: Air with a density of 11.9 kg/m<sup>3</sup> (at 20 °C and 10 bar)
- Measuring range (liquid): 100 kg/h
- x = 32 kg/m<sup>3</sup> (for Promass A DN 2)

Maximum possible full scale value:

$$\dot{m}_{\max(G)} = \dot{m}_{\max(F)} \cdot \rho_G : x = 100 \text{ kg/h} \cdot 11.9 \text{ kg/m}^3 : 32 \text{ kg/m}^3 = 37.2 \text{ kg/h}$$

### Recommended measuring range

"Flow limit" section (→  106)

Operable flow range

Over 1000 : 1.

Flow rates above the preset full scale value are not overridden by the electronics unit, with the result that the totalizer values are registered correctly.

## 16.4 Output



Output signal

### Current output

Current output	4-20 mA HART (active)
Maximum output values	<ul style="list-style-type: none"> <li>■ DC 24 V (no flow)</li> <li>■ 22.5 mA</li> </ul>
Load	0 to 700 Ω
Resolution	0.38 μA
Damping	Adjustable: 0.07 to 999 s
Assignable measured variables	<ul style="list-style-type: none"> <li>■ Mass flow</li> <li>■ Volume flow</li> <li>■ Corrected volume flow</li> <li>■ Density</li> <li>■ Reference density</li> <li>■ Temperature</li> </ul> <p> The range of options increases if the measuring device has one or more application packages.</p>

### Pulse/frequency/switch output

Function	Can be set to pulse, frequency or switch output
Version	Passive, open collector

<b>Maximum input values</b>	<ul style="list-style-type: none"> <li>▪ DC 30 V</li> <li>▪ 25 mA</li> </ul>
<b>Voltage drop</b>	For 25 mA: ≤ DC 2 V
<b>Pulse output</b>	
<b>Pulse width</b>	Adjustable: 0.05 to 2 000 ms
<b>Maximum pulse rate</b>	10 000 Impulse/s
<b>Pulse value</b>	Adjustable
<b>Assignable measured variables</b>	<ul style="list-style-type: none"> <li>▪ Mass flow</li> <li>▪ Volume flow</li> <li>▪ Corrected volume flow</li> </ul>
<b>Frequency output</b>	
<b>Output frequency</b>	Adjustable: 0 to 10 000 Hz
<b>Damping</b>	Adjustable: 0 to 999 s
<b>Pulse/pause ratio</b>	1:1
<b>Assignable measured variables</b>	<ul style="list-style-type: none"> <li>▪ Mass flow</li> <li>▪ Volume flow</li> <li>▪ Corrected volume flow</li> <li>▪ Density</li> <li>▪ Reference density</li> <li>▪ Temperature</li> </ul> <p> The range of options increases if the measuring device has one or more application packages.</p>
<b>Switch output</b>	
<b>Switching behavior</b>	Binary, conductive or non-conductive
<b>Switching delay</b>	Adjustable: 0 to 100 s
<b>Number of switching cycles</b>	Unlimited
<b>Assignable functions</b>	<ul style="list-style-type: none"> <li>▪ Off</li> <li>▪ On</li> <li>▪ Diagnostic behavior</li> <li>▪ Limit value                             <ul style="list-style-type: none"> <li>- Mass flow</li> <li>- Volume flow</li> <li>- Corrected volume flow</li> <li>- Density</li> <li>- Reference density</li> <li>- Temperature</li> <li>- Totalizer 1-3</li> </ul> </li> <li>▪ Flow direction monitoring</li> <li>▪ Status                             <ul style="list-style-type: none"> <li>- Partially filled pipe detection</li> <li>- Low flow cut off</li> </ul> </li> </ul> <p> The range of options increases if the measuring device has one or more application packages.</p>

Signal on alarm

Depending on the interface, failure information is displayed as follows:

**Current output**

4-20 mA

<b>Failure mode</b>	Selectable (as per NAMUR recommendation NE 43): <ul style="list-style-type: none"> <li>▪ Minimum value: 3.6 mA</li> <li>▪ Maximum value: 22 mA</li> <li>▪ Defined value: 3.59 to 22.5 mA</li> <li>▪ Actual value</li> <li>▪ Last valid value</li> </ul>
---------------------	---

*HART*

<b>Device diagnostics</b>	Device condition can be read out via HART Command 48
---------------------------	--

**Pulse/frequency/switch output**

Pulse output	
<b>Failure mode</b>	Choose from: <ul style="list-style-type: none"> <li>■ Actual value</li> <li>■ No pulses</li> </ul>
Frequency output	
<b>Failure mode</b>	Choose from: <ul style="list-style-type: none"> <li>■ Actual value</li> <li>■ Defined value: 0 to 12 500 Hz</li> <li>■ 0 Hz</li> </ul>
Switch output	
<b>Failure mode</b>	Choose from: <ul style="list-style-type: none"> <li>■ Current status</li> <li>■ Open</li> <li>■ Closed</li> </ul>

**Local display**

<b>Plain text display</b>	With information on cause and remedial measures
<b>Backlight</b>	Red backlighting indicates a device error.

 Status signal as per NAMUR recommendation NE 107

**Operating tool**

- Via digital communication:
  - HART protocol
- Via service interface

<b>Plain text display</b>	With information on cause and remedial measures
---------------------------	---

**Web browser**

<b>Plain text display</b>	With information on cause and remedial measures
---------------------------	---

---

Low flow cut off	The switch points for low flow cut off are user-selectable.
------------------	---

---

Galvanic isolation	The following connections are galvanically isolated from each other: <ul style="list-style-type: none"> <li>■ Outputs</li> <li>■ Power supply</li> </ul>
--------------------	--

---

Protocol-specific data	<b>HART</b> <ul style="list-style-type: none"> <li>■ For information on the device description files (→  44)</li> <li>■ For information on the dynamic variables and measured variables (HART device variables) (→  44)</li> </ul>
------------------------	--

## 16.5 Power supply

Terminal assignment (→  28)

Pin assignment, device plug (→  29)

Supply voltage

### Transmitter

For device version with all communication types except Modbus RS485 intrinsically safe: DC 20 to 30 V

The power unit must be tested to ensure it meets safety requirements (e.g. PELV, SELV).

Power consumption

### Transmitter

Order code for "Output"	Maximum Power consumption
Option B: 4-20mA HART, pulse/frequency/switch output	3.5 W

Current consumption

### Transmitter

Order code for "Output"	Maximum Current consumption	Maximum switch-on current
Option B: 4-20mA HART, pul./freq./switch output	145 mA	18 A (<0.125 ms)

Power supply failure

- Totalizers stop at the last value measured.
- Depending on the device version, the configuration is retained in the device memory or in the plug-in memory (HistoROM DAT).
- Error messages (incl. total operated hours) are stored.

Electrical connection

(→  29)

Potential equalization

No special measures for potential equalization are required.

Terminals

### Transmitter

Spring terminals for wire cross-sections 0.5 to 2.5 mm<sup>2</sup> (20 to 14 AWG)

Cable entries

- Cable gland: M20 × 1.5 with cable  $\phi$ 6 to 12 mm (0.24 to 0.47 in)
- Thread for cable entry:
  - NPT 1/2"
  - G 1/2"
  - M20



Cable specification

(→  27)

## 16.6 Performance characteristics

Reference operating conditions

- Error limits based on ISO 11631
- Water with +15 to +45 °C (+59 to +113 °F) at 2 to 6 bar (29 to 87 psi)
- Specifications as per calibration protocol
- Accuracy based on accredited calibration rigs that are traced to ISO 17025.

 To obtain measured errors, use the *Applicator* sizing tool (→  113)

Maximum measured error o.r. = of reading; 1 g/cm<sup>3</sup> = 1 kg/l; T = medium temperature

### Base accuracy

#### Mass flow and volume flow (liquids)

±0.10 %

#### Mass flow (gases)

±0.50 % o.r.

 Design fundamentals (→  103)

### Density (liquids)

- Reference conditions: ±0.0005 g/cm<sup>3</sup>
- Standard density calibration: ±0.02 g/cm<sup>3</sup>  
(valid over the entire temperature range and density range )
- Wide-range density specification (order code for "Application package", option EF "Special density and concentration") : ±0.002 g/cm<sup>3</sup> (valid range for special density calibration: 0.0 to 2 g/cm<sup>3</sup>, +5 to +80 °C (+41 to +176 °F))

### Temperature

±0.5 °C ± 0.005 · T °C (±0.9 °F ± 0.003 · (T - 32) °F)

### Zero point stability

DN		Zero point stability	
[mm]	[in]	[kg/h]	[lb/min]
1	1/24	0.0010	0.000036
2	1/12	0.0050	0.00018
4	1/6	0.0225	0.0008

### Flow values

Flow values as turndown parameter depending on nominal diameter.

*SI units*

DN [mm]	1:1	1:10	1:20	1:50	1:100	1:500
	[kg/h]	[kg/h]	[kg/h]	[kg/h]	[kg/h]	[kg/h]
1	20	2	1	0.4	0.2	0.04
2	100	10	5	2	1	0.2
4	450	45	22.5	9	4.5	0.9

*US units*

DN	1:1	1:10	1:20	1:50	1:100	1:500
[inch]	[lb/min]	[lb/min]	[lb/min]	[lb/min]	[lb/min]	[lb/min]
1/24	0.735	0.074	0.037	0.015	0.007	0.001
1/12	3.675	0.368	0.184	0.074	0.037	0.007
1/8	16.54	1.654	0.827	0.331	0.165	0.033

**Accuracy of outputs**

o.r. = of reading; o.f.s. = of full scale value

 The output accuracy must be factored into the measured error if analog outputs are used, but can be ignored for fieldbus outputs (e.g. Modbus RS485, EtherNet/IP).

*Current output*

<b>Accuracy</b>	Max. $\pm 0.05$ % o.f.s. or $\pm 5$ $\mu$ A
-----------------	---

*Pulse/frequency output*

<b>Accuracy</b>	Max. $\pm 50$ ppm o.r.
-----------------	------------------------

Repeatability

o.r. = of reading;  $1 \text{ g/cm}^3 = 1 \text{ kg/l}$ ; T = medium temperature

**Base repeatability**

**Mass flow and volume flow (liquids)**

$\pm 0.05$  % o.r.

**Mass flow (gases)**

$\pm 0.25$  % o.r.

 Design fundamentals ([→](#)  103)

**Density (liquids)**

$\pm 0.00025 \text{ g/cm}^3$

**Temperature**

$\pm 0.25 \text{ }^\circ\text{C} \pm 0.0025 \cdot T \text{ }^\circ\text{C}$  ( $\pm 0.45 \text{ }^\circ\text{F} \pm 0.0015 \cdot (T - 32) \text{ }^\circ\text{F}$ )

Response time

The response time depends on the configuration (damping).

Influence of ambient temperature

o.r. = of reading; o.f.s. = of full scale value

**Current output**

<b>Temperature coefficient</b>	Max. $\pm 50$ ppm/ $^\circ\text{C}$ o.f.s. or $\pm 1$ $\mu\text{A}/^\circ\text{C}$
--------------------------------	--

**Pulse/frequency output**

<b>Temperature coefficient</b>	Max. $\pm 50$ ppm o.r. / $100 \text{ }^\circ\text{C}$
--------------------------------	---

Influence of medium temperature

**Mass flow and volume flow**

When there is a difference between the temperature for zero point adjustment and the process temperature, the typical measured error of the sensor is  $\pm 0.0002\%$  of the full scale value/ $^{\circ}\text{C}$  ( $\pm 0.0001\%$  of the full scale value/ $^{\circ}\text{F}$ ).

**Density**

When there is a difference between the density calibration temperature and the process temperature, the typical measured error of the sensor is  $\pm 0.00005\text{ g/cm}^3\text{ /}^{\circ}\text{C}$  ( $\pm 0.000025\text{ g/cm}^3\text{ /}^{\circ}\text{F}$ ). Field density calibration is possible.

**Wide-range density specification (special density calibration)**

If the process temperature is outside the valid range ( $\rightarrow$  101) the measured error is  $\pm 0.00005\text{ g/cm}^3\text{ /}^{\circ}\text{C}$  ( $\pm 0.000025\text{ g/cm}^3\text{ /}^{\circ}\text{F}$ )

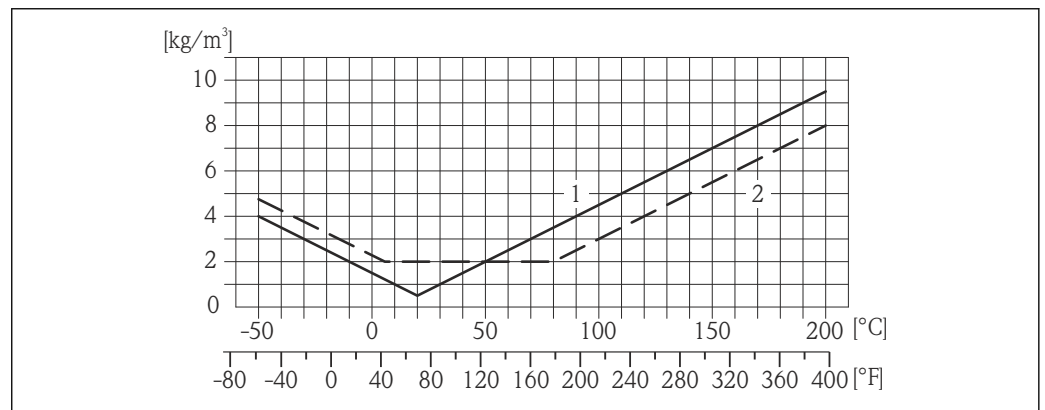

- 1 Field density calibration, for example at +20 °C (+68 °F)
- 2 Special density calibration

**Temperature**

$\pm 0.005 \cdot T\text{ }^{\circ}\text{C}$  ( $\pm 0.005 \cdot (T - 32)\text{ }^{\circ}\text{F}$ )

Influence of medium pressure

A difference between the calibration pressure and process pressure does not affect accuracy.

Design fundamentals

*o.r.* = of reading, *o.f.s.* = of full scale value

BaseAccu = base accuracy in % *o.r.*, BaseRepeat = base repeatability in % *o.r.*

MeasValue = measured value; ZeroPoint = zero point stability

*Calculation of the maximum measured error as a function of the flow rate*

Flow rate	Maximum measured error in % <i>o.r.</i>
$\geq \frac{\text{ZeroPoint}}{\text{BaseAccu}} \cdot 100$ <small>A0021332</small>	$\pm \text{BaseAccu}$ <small>A0021339</small>
$< \frac{\text{ZeroPoint}}{\text{BaseAccu}} \cdot 100$ <small>A0021333</small>	$\pm \frac{\text{ZeroPoint}}{\text{MeasValue}} \cdot 100$ <small>A0021334</small>

Calculation of the maximum repeatability as a function of the flow rate

Flow rate	Maximum repeatability in % o.r.
$\geq \frac{1/2 \cdot \text{ZeroPoint}}{\text{BaseRepeat}} \cdot 100$ <small>A0021335</small>	$\pm \text{BaseRepeat}$ <small>A0021340</small>
$< \frac{1/2 \cdot \text{ZeroPoint}}{\text{BaseRepeat}} \cdot 100$ <small>A0021336</small>	$\pm 1/2 \cdot \frac{\text{ZeroPoint}}{\text{MeasValue}} \cdot 100$ <small>A0021337</small>

Example for max. measured error

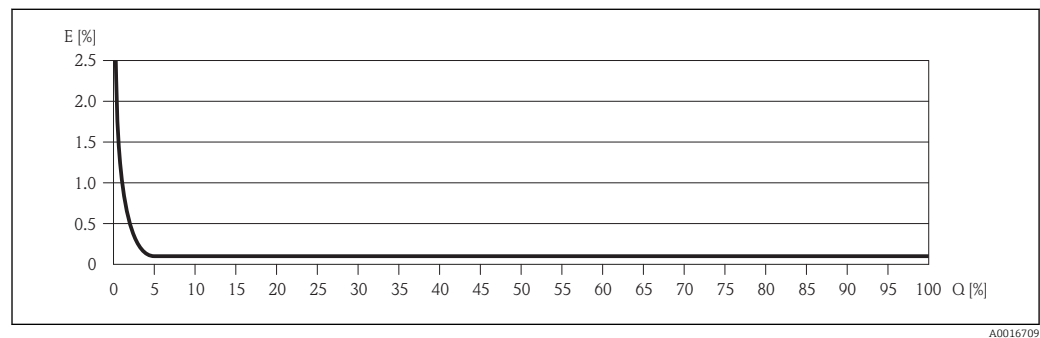

E Error: Maximum measured error as % o.r. (example)  
 Q Flow rate as %

Design fundamentals (→ 103)

## 16.7 Installation

"Mounting requirements" (→ 18)

## 16.8 Environment

Ambient temperature range (→ 20)

Storage temperature -50 to +60 °C (-58 to +140 °F) (Order code for "Test, certificate", option JM)

Climate class DIN EN 60068-2-38 (test Z/AD)

Degree of protection **Transmitter and sensor**

- As standard: IP66/67, type 4X enclosure
- With the order code for "Sensor options", option **CM**: IP69K can also be ordered
- When housing is open: IP20, type 1 enclosure
- Display module: IP20, type 1 enclosure

Shock resistance As per IEC/EN 60068-2-31

Vibration resistance Acceleration up to 1 g, 10 to 150 Hz, based on IEC/EN 60068-2-6



Interior cleaning	<ul style="list-style-type: none"> <li>■ Sterilization in place (SIP)</li> <li>■ Cleaning in place (CIP)</li> </ul>
Electromagnetic compatibility (EMC)	<ul style="list-style-type: none"> <li>■ As per IEC/EN 61326 and NAMUR Recommendation 21 (NE 21)</li> <li>■ Complies with emission limits for industry as per EN 55011 (Class A)</li> </ul> <p> For details refer to the Declaration of Conformity.</p>

## 16.9 Process

Medium temperature range	<p><b>Sensor</b></p> <ul style="list-style-type: none"> <li>■ -50 to +150 °C (-58 to +302 °F)</li> <li>■ -50 to +200 °C (-58 to +392 °F) with extended temperature (order code for "Measuring tube mat.", option SD, SE, SF, TH)</li> </ul> <p><b>Seals</b></p> <ul style="list-style-type: none"> <li>■ No internal seals</li> <li>■ For mounting sets with screwed-on connections: <ul style="list-style-type: none"> <li>- Viton: -15 to +200 °C (-5 to +392 °F)</li> <li>- EPDM: -40 to +160 °C (-40 to +320 °F)</li> <li>- Silicon: -60 to +200 °C (-76 to +392 °F)</li> <li>- Kalrez: -20 to +275 °C (-4 to +527 °F)</li> </ul> </li> </ul>
Density	0 to 5 000 kg/m <sup>3</sup> (0 to 312 lb/cf)
Pressure-temperature ratings	 An overview of the pressure-temperature ratings for the process connections is provided in the "Technical Information" document
Secondary containment pressure rating	The sensor housing is filled with dry nitrogen and protects the electronics and mechanics inside.

DN		Secondary containment nominal pressure (designed with a safety factor ≥ 4)		Secondary containment burst pressure	
[mm]	[in]	[bar]	[psi]	[bar]	[psi]
1	1/24	25	362	175	2535
2	1/12	25	362	155	2245
4	1/8	25	362	130	1885

 If there is a risk of measuring tube failure due to process characteristics, e.g. with corrosive process fluids, we recommend the use of sensors whose secondary containment is equipped with special pressure monitoring connections (order code for "Purge connection", option CH).

With the help of these connections, the fluid collected in the secondary containment can be bled off in the event of tube failure. This is especially important in high-pressure gas applications. These connections can also be used for gas purging (gas detection).

Do not open the purge connections unless the containment can be filled immediately with a dry, inert gas. Use only low gauge pressure to purge. Maximum pressure: 5 bar (72.5 psi).

If a device fitted with purge connections is connected to the purge system, the maximum nominal pressure is determined by the purge system itself or by the device, depending on which component has the lower nominal pressure.



If, on the other hand, the device is fitted with a rupture disk, the rupture disk is decisive for the maximum nominal pressure (→  106).

 For the dimensions and installation lengths of the device, see the "Technical Information" document, "Mechanical construction" section

---

#### Rupture disk

To increase the level of safety, a device version with a rupture disk with a triggering pressure of 10 to 15 bar (145 to 217.5 psi) can be used. Special mounting instructions: (→  22)

Rupture disks cannot be combined with the separately available heating jacket (→  94) (→  94).

---

#### Flow limit



Select the nominal diameter by optimizing between the required flow range and permissible pressure loss.

 For an overview of the measuring range full scale values, see the "Measuring range" section (→  96)

- The minimum recommended full scale value is approx. 1/20 of the maximum full scale value
- In most applications, 20 to 50 % of the maximum full scale value can be considered ideal
- Select a lower full scale value for abrasive substances (such as liquids with entrained solids): flow velocity < 1 m/s (< 3 ft/s).
- For gas measurement the following rules apply:
  - The flow velocity in the measuring tubes should not exceed half the sonic velocity (0.5 Mach).
  - The maximum mass flow depends on the density of the gas: formula (→  96)

---

#### Pressure loss

 To calculate the pressure loss, use the *Applicator* sizing tool (→  113)

## 16.10 Mechanical construction

### Design, dimensions



For the dimensions and installation lengths of the device, see the "Technical Information" document, "Mechanical construction" section

### Weight

#### Compact version

##### Weight in SI units

All values (weight) refer to devices with EN/DIN PN 40 flanges. Weight information in [kg].

DN [mm]	Weight [kg]
1	8
2	9
4	13

##### Weight in US units

All values (weight) refer to devices with EN/DIN PN 40 flanges. Weight information in [lbs].

DN [in]	Weight [lbs]
1/24	18
1/12	20
1/8	29

### Materials

#### Transmitter housing

- Order code for "Housing", option **A** "Compact, aluminum coated":  
Aluminum, AlSi10Mg, coated
- Order code for "Housing", option **B** "Compact, hygienic, stainless":  
Hygienic version, stainless steel 1.4301 (304)
- Order code for "Housing", option **C** "Ultra compact, hygienic, stainless":  
Hygienic version, stainless steel 1.4301 (304)

**Cable entries/cable glands**

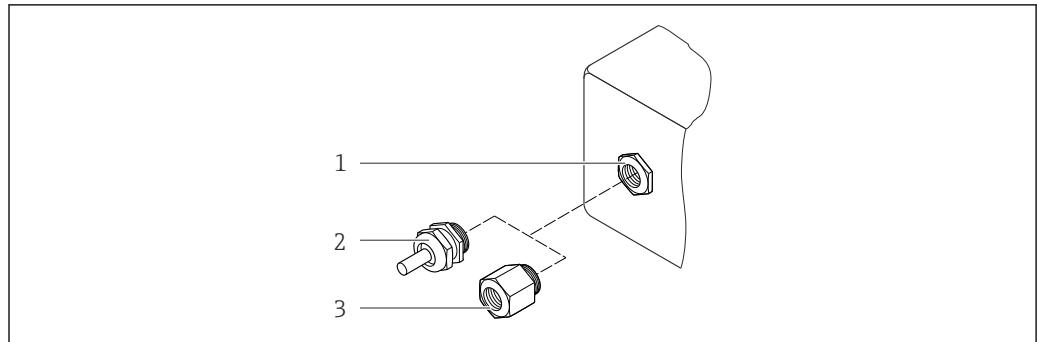

A0020640

14 Possible cable entries/cable glands

- 1 Cable entry in transmitter housing, wall-mount housing or connection housing with internal thread M20 x 1.5
- 2 Cable gland M20 x 1.5
- 3 Adapter for cable entry with internal thread G 1/2" or NPT 1/2"

Order code for "Housing", option A "Compact, coated aluminum"

The various cable entries are suitable for hazardous and non-hazardous areas.

Cable entry/cable gland	Material
Cable gland M20 x 1.5	Nickel-plated brass
Adapter for cable entry with internal thread G 1/2"	
Adapter for cable entry with internal thread NPT 1/2"	

Order code for "Housing", option B "Compact, hygienic, stainless"

The various cable entries are suitable for hazardous and non-hazardous areas.

Cable entry/cable gland	Material
Cable gland M20 x 1.5	Stainless steel, 1.4404 (316L)
Adapter for cable entry with internal thread G 1/2"	
Adapter for cable entry with internal thread NPT 1/2"	

**Device plug**

Electrical connection	Material
Plug M12x1	<ul style="list-style-type: none"> <li>▪ Socket: Stainless steel, 1.4404 (316L)</li> <li>▪ Contact housing: Polyamide</li> <li>▪ Contacts: Gold-plated brass</li> </ul>

**Sensor housing**

- Acid and alkali-resistant outer surface
- Stainless steel 1.4301 (304)

**Measuring tubes**

- Stainless steel, 1.4539 (904L); Alloy C22, 2.4602 (UNS N06022)
- Surface quality:
  - Not polished
  - $Ra_{max} = 0.8 \mu\text{m}$  (32  $\mu\text{in}$ )
  - $Ra_{max} = 0.4 \mu\text{m}$  (16  $\mu\text{in}$ )

**Process connections**

VCO coupling

- Stainless steel, 1.4539 (904L)
- Alloy C22, 2.4602 (UNS N06022)

Tri-Clamp

Stainless steel, 1.4539 (904L)

Mounting kit, flanges as per EN 1092-1 (DIN 2501), ASME B16.5, JIS B2220

- Stainless steel, 1.4539 (904L)
- Alloy C22, 2.4602 (UNS N06022)

Mounting kit, lap joint flanges as per EN 1092-1 (DIN 2501), ASME B16.5, JIS B2220



Stainless steel, 1.4404 (316/316L)

Mounting kit, SWAGELOK

Stainless steel, 1.4539 (904L)

Mounting kit, NPTF

- Stainless steel, 1.4539 (904L)
- Alloy C22

 List of all available process connections (→  109)

**Seals**



Welded process connections without internal seals

**Seals for mounting kit**

- Viton
- EPDM
- Silicone
- Kalrez

**Process connections**

- Flanges:
  - EN 1092-1 (DIN 2501)
  - EN 1092-1 (DIN 2512N)
  - ASME B16.5
  - JIS B2220
- VCO connections
- Tri-Clamp (OD tubes)
- Mounting sets
  - SWAGELOK
  - NPTF

 For information on the materials of the process connections (→  107)

**16.11 Operability****Local display**

The local display is only available with the following device version:  
Order code for "Display; Operation", option **B**: 4-line; via communication

**Display element**

- 4-line liquid crystal display with 16 characters per line.
- White background lighting; switches to red in event of device errors.
- Format for displaying measured variables and status variables can be individually configured.
- Permitted ambient temperature for the display: -20 to +60 °C (-4 to +140 °F). The readability of the display may be impaired at temperatures outside the temperature range.

**Disconnecting the local display from the main electronics module**

 In the case of the "Compact, aluminum coated" housing version, the local display must only be disconnected manually from the main electronics module. In the case of the "Compact, hygienic, stainless" and "Ultra compact, hygienic, stainless" housing versions, the local display is integrated in the housing cover and is disconnected from the main electronics module when the housing cover is opened.

*"Compact, aluminum coated" housing version*

The local display is plugged onto the main electronics module. The electronic connection between the local display and main electronics module is established via a connecting cable.

For some work performed on the measuring device (e.g. electrical connection), it is advisable to disconnect the local display from the main electronics module:

1. Press in the side latches of the local display.
2. Remove the local display from the main electronics module. Pay attention to the length of the connecting cable when doing so.

Once the work is completed, plug the local display back on.

---

**Remote operation****Via HART protocol**

This communication interface is present in the following device version:  
Order code for "Output", option B: 4-20 mA HART, pulse/frequency/switch output

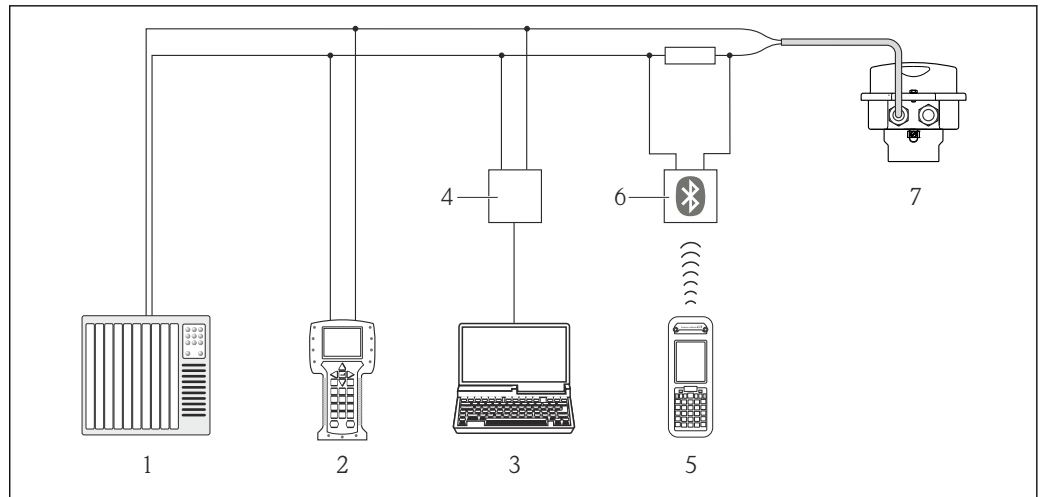

A0016948

15 Options for remote operation via HART protocol

- 1 Control system (e.g. PLC)
- 2 Field Communicator 475
- 3 Computer with operating tool (e.g. FieldCare, AMS Device Manager, SIMATIC PDM)
- 4 Commubox FXA195 (USB)
- 5 Field Xpert SFX350 or SFX370
- 6 VIATOR Bluetooth modem with connecting cable
- 7 Transmitter

Service interface

Service interface (CDI-RJ45)

HART

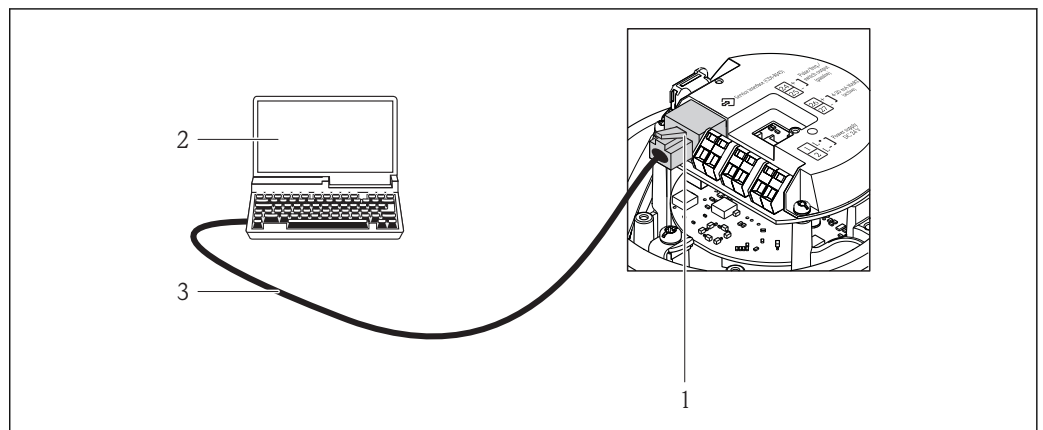

A0016926

16 Connection for the order code for "Output", option B: 4-20 mA HART, pulse/frequency/switch output

- 1 Service interface (CDI -RJ45) of the measuring device with access to the integrated Web server
- 2 Computer with Web browser (e.g. Internet Explorer) for accessing the integrated device Web server or with "FieldCare" operating tool with COM DTM "CDI Communication TCP/IP"
- 3 Standard Ethernet connecting cable with RJ45 plug

Languages

Can be operated in the following languages:

- Via "FieldCare" operating tool:  
English, German, French, Spanish, Italian, Chinese, Japanese
- Via Web browser  
English, German, French, Spanish, Italian, Dutch, Portuguese, Polish, Russian, Turkish, Chinese, Japanese, Bahasa (Indonesian), Vietnamese, Czech

## 16.12 Certificates and approvals

CE mark	<p>The measuring system is in conformity with the statutory requirements of the applicable EC Directives. These are listed in the corresponding EC Declaration of Conformity along with the standards applied.</p> <p>Endress+Hauser confirms successful testing of the device by affixing to it the CE mark.</p>
C-Tick symbol	<p>The measuring system meets the EMC requirements of the "Australian Communications and Media Authority (ACMA)".</p>
Ex approval	<p>The devices are certified for use in hazardous areas and the relevant safety instructions are provided in the separate "Safety Instructions" (XA) document. Reference is made to this document on the nameplate.</p>
Hygienic compatibility	<ul style="list-style-type: none"> <li>■ 3A approval</li> <li>■ EHEDG-tested</li> </ul>
Other standards and guidelines	<ul style="list-style-type: none"> <li>■ EN 60529 Degrees of protection provided by enclosures (IP code)</li> <li>■ IEC/EN 60068-2-6 Environmental influences: Test procedure - Test Fc: vibrate (sinusoidal).</li> <li>■ IEC/EN 60068-2-31 Environmental influences: Test procedure - Test Ec: shocks due to rough handling, primarily for devices.</li> <li>■ EN 61010-1 Safety requirements for electrical equipment for measurement, control and laboratory use</li> <li>■ IEC/EN 61326 Emission in accordance with Class A requirements. Electromagnetic compatibility (EMC requirements).</li> <li>■ NAMUR NE 21 Electromagnetic compatibility (EMC) of industrial process and laboratory control equipment</li> <li>■ NAMUR NE 32 Data retention in the event of a power failure in field and control instruments with microprocessors</li> <li>■ NAMUR NE 43 Standardization of the signal level for the breakdown information of digital transmitters with analog output signal.</li> <li>■ NAMUR NE 53 Software of field devices and signal-processing devices with digital electronics</li> <li>■ NAMUR NE 105 Specifications for integrating fieldbus devices in engineering tools for field devices</li> <li>■ NAMUR NE 107 Self-monitoring and diagnosis of field devices</li> <li>■ NAMUR NE 131 Requirements for field devices for standard applications</li> <li>■ NAMUR NE 132 Coriolis mass meter</li> </ul>



## 16.13 Application packages



Many different application packages are available to enhance the functionality of the device. Such packages might be needed to address safety aspects or specific application requirements.

The application packages can be ordered from Endress+Hauser either directly with the device or subsequently. Detailed information on the order code in question is available from your local Endress+Hauser sales center or on the product page of the Endress+Hauser website: [www.endress.com](http://www.endress.com).

Heartbeat Technology	Package	Description
	Heartbeat Verification +Monitoring	<p><b>Heartbeat Monitoring:</b> Continuously supplies monitoring data, which are characteristic of the measuring principle, for an external condition monitoring system. This makes it possible to:</p> <ul style="list-style-type: none"> <li>▪ Draw conclusions - using these data and other information - about the impact the measuring application has on the measuring performance over time.</li> <li>▪ Schedule servicing in time.</li> <li>▪ Monitor the product quality, e.g. gas pockets.</li> </ul> <p><b>Heartbeat Verification:</b> Makes it possible to check the device functionality on demand when the device is installed, without having to interrupt the process.</p> <ul style="list-style-type: none"> <li>▪ Access via onsite operation or other operating interfaces, such as FieldCare for instance.</li> <li>▪ Documentation of device functionality within the framework of manufacturer specifications, for proof testing for instance.</li> <li>▪ End-to-end, traceable documentation of the verification results, including report.</li> <li>▪ Makes it possible to extend calibration intervals in accordance with operator's risk assessment.</li> </ul>

Concentration	Package	Description
	Concentration measurement and special density	<p><b>Calculation and outputting of fluid concentrations</b> Many applications use density as a key measured value for monitoring quality or controlling processes. The device measures the density of the fluid as standard and makes this value available to the control system.</p> <p>The "Special Density" application package offers high-precision density measurement over a wide density and temperature range particularly for applications subject to varying process conditions.</p> <p>With the help of the "Concentration Measurement" application package, the measured density is used to calculate other process parameters:</p> <ul style="list-style-type: none"> <li>▪ Temperature-compensated density (reference density).</li> <li>▪ Percentage mass of the individual substances in a two-phase fluid. (Concentration in %).</li> <li>▪ Fluid concentration is output with special units ("Brix", "Baumé", "API, etc.) for standard applications.</li> </ul> <p>The measured values are output via the digital and analog outputs of the device.</p>

## 16.14 Accessories

 Overview of accessories available for order (→  94)

## 16.15 Documentation

-  For an overview of the scope of the associated Technical Documentation, refer to the following:
- The CD-ROM provided for the device (depending on the device version, the CD-ROM might not be part of the delivery!)
  - The *W@M Device Viewer* : Enter the serial number from the nameplate ([www.endress.com/deviceviewer](http://www.endress.com/deviceviewer))
  - The *Endress+Hauser Operations App*: Enter the serial number from the nameplate or scan the 2-D matrix code (QR code) on the nameplate.

### Standard documentation

#### Brief Operating Instructions

Measuring device	Documentation code
Promass A 100	KA01144D

#### Technical Information

Measuring device	Documentation code
Promass A 100	TI01104D

### Supplementary device-dependent documentation



#### Safety Instructions

Contents	Documentation code
ATEX/IECEX Ex i	XA00159D
ATEX/IECEX Ex nA	XA01029D
cCSAus IS	XA00160D
INMETRO Ex i	XA01219D
INMETRO Ex nA	XA01220D
NEPSI Ex i	XA01249D
NEPSI Ex nA	XA01262D

#### Special Documentation

Contents	Documentation code
Information on the Pressure Equipment Directive	SD00142D
Concentration Measurement	SD01152D
Heartbeat Technology	SD01153D

#### Installation Instructions

Contents	Documentation code
Installation Instructions for spare part sets	Specified for each individual accessory (→  94)   Overview of accessories available for order (→  94)

# 17 Appendix

## 17.1 Overview of the operating menu

The following tables provide an overview of the entire operating menu structure with menus and parameters. The page reference indicates where a description of the parameter can be found in the manual.

### 17.1.1 Main menu

<b>Main menu</b>	→	<b>Operation</b>	(→ 115)
		<b>Setup</b>	(→ 115)
		<b>Diagnostics</b>	(→ 120)
		<b>Expert</b>	(→ 123)



























### 17.1.2 "Operation" menu

<b>Operation</b>	→		
Display language			(→ 71)
Web server language			
Access status display			
Access status tooling			
Locking status			(→ 73)
		<b>Display</b>	→ (→ 59)
		Format display	(→ 60)
		Contrast display	
		Backlight	(→ 71)
		Display interval	(→ 71)
		<b>Totalizer handling</b>	→ (→ 77)
		Control Totalizer 1 to 3	(→ 78)
		Preset value 1 to 3	(→ 78)
		Reset all totalizers	(→ 77)

### 17.1.3 "Setup" menu

<b>Setup</b>	→		(→ 49)
--------------	---	--	--------

<b>Select medium</b>	→	(→ 52)
Select medium		(→ 52)
Select gas type		(→ 52)
Reference sound velocity		(→ 52)
Temperature coefficient sound velocity		(→ 52)
Pressure compensation		(→ 52)
Pressure value		(→ 52)
External pressure		(→ 52)
<b>Current output 1</b>	→	(→ 53)
Assign current output		(→ 54)
Current span		(→ 54)
4 mA value		(→ 54)
20 mA value		(→ 54)
Failure mode		(→ 54)
Failure current		(→ 54)
<b>Pulse/frequency/switch output</b>	→	(→ 55)
Operating mode		(→ 55)
Assign pulse output		(→ 55)
Assign frequency output		(→ 56)
Switch output function		(→ 58)
Assign diagnostic behavior		(→ 58)
Assign limit		(→ 58)
Assign flow direction check		(→ 58)
Assign status		(→ 58)
Value per pulse		(→ 55)
Pulse width		(→ 55)
Failure mode		(→ 55)
Minimum frequency value		(→ 57)
Maximum frequency value		(→ 57)

Measuring value at minimum frequency		(→  57)
Measuring value at maximum frequency		(→  57)
Failure mode		(→  57)
Failure frequency		(→  57)
Switch-on value		(→  58)
Switch-off value		(→  58)
Failure mode		(→  59)
Invert output signal		(→  55)
<b>Output conditioning</b>	→	(→  61)
Assign current output		(→  54)
Damping output 1		(→  62)
Measuring mode output 1		(→  62)
Assign pulse output		(→  55)
Measuring mode output 1		(→  63)
Operating mode totalizer 1...3		(→  63)
<b>Low flow cut off</b>	→	(→  64)
Assign process variable		(→  64)
On value low flow cutoff		(→  64)
Off value low flow cutoff		(→  64)
Pressure shock suppression		(→  64)
<b>Partially filled pipe detection</b>	→	(→  65)
Assign process variable		(→  65)
Low value partial filled pipe detection		(→  65)
High value partial filled pipe detection		(→  65)
Response time part. filled pipe detect.		(→  65)
<b>HART input</b>	→	(→  60)
Capture mode		(→  61)

Device ID		(→ 61)
Device type		(→ 61)
Manufacturer ID		(→ 61)
Burst command		(→ 61)
Slot number		(→ 61)
Timeout		(→ 61)
Failure mode		(→ 61)
Failure value		(→ 61)
<b>Advanced setup</b>	→	(→ 66)
Enter access code		(→ 73)
	<b>System units</b>	→ (→ 49)
	Mass flow unit	(→ 50)
	Mass unit	(→ 50)
	Volume flow unit	(→ 50)
	Volume unit	(→ 50)
	Corrected volume flow unit	(→ 50)
	Corrected volume unit	(→ 51)
	Density unit	(→ 51)
	Reference density unit	(→ 51)
	Temperature unit	(→ 51)
	Pressure unit	(→ 51)
	<b>Calculated values</b>	→ (→ 66)
		<b>Corrected volume flow calculation</b>
		→ (→ 66)
		Corrected volume flow calculation
		(→ 67)
		External reference density
		(→ 67)
		Fixed reference density
		(→ 67)
		Reference temperature
		(→ 67)
		Linear expansion coefficient
		(→ 67)
		Square expansion coefficient
		(→ 67)

<b>Sensor adjustment</b>	→	
Installation direction		(→ 68)
		<b>Zero point adjustment</b>
		→
		Zero point adjustment control
		(→ 68)
		Progress
		(→ 68)
<b>Totalizer 1 to 3</b>	→	(→ 68)
Assign process variable		(→ 68)
Unit totalizer		(→ 58)
Totalizer operation mode		(→ 68)
Failure mode		(→ 68)
<b>Display</b>	→	(→ 69)
Format display		(→ 60)
Value 1 display		(→ 60)
0% bargraph value 1		(→ 60)
100% bargraph value 1		(→ 60)
Decimal places 1		(→ 70)
Value 2 display		(→ 60)
Decimal places 2		(→ 70)
Value 3 display		(→ 60)
0% bargraph value 3		(→ 60)
100% bargraph value 3		(→ 60)
Decimal places 3		(→ 71)
Value 4 display		(→ 60)
Decimal places 4		(→ 71)
Display language		(→ 71)
Display interval		(→ 71)
Display damping		(→ 71)
Header		(→ 71)
Header text		(→ 71)
Separator		(→ 71)
Backlight		(→ 71)

	<b>Concentration</b> <sup>1)</sup>	→	(→ ⓘ 114)
	Concentration unit		
	User concentration text		
	User concentration factor		
	User concentration offset		
	A 0		
	A 1 to 4		
	B 1 to 3		
	<b>Heartbeat</b> <sup>2)</sup>	→	(→ ⓘ 114)
	Progress		
	Plant operator		
	Location		
		<b>Heartbeat Monitoring</b>	→
		Activate monitoring	
	<b>Administration</b>	→	(→ ⓘ 73)
	Define access code		(→ ⓘ 73)
	Device reset		(→ ⓘ 88)























1) Order code for "Application package", option ED "Concentration", see the Special Documentation for the device









2) Order code for "Application package", option EB "Heartbeat Verification and Monitoring", see Special Documentation for the device

### 17.1.4 "Diagnostics" menu

<b>Diagnostics</b> (→ ⓘ 120)	→	(→ ⓘ 79)
Actual diagnostics		(→ ⓘ 86)
Previous diagnostics		(→ ⓘ 86)
Operating time from restart		(→ ⓘ 86)
Operating time		(→ ⓘ 0 )
<b>Diagnostic list</b>	→	(→ ⓘ 86)
Diagnostics 1 to 5		(→ ⓘ 86)
<b>Event logbook</b>	→	(→ ⓘ 86)
Filter options		(→ ⓘ 87)
<b>Device information</b>	→	(→ ⓘ 88)
Device tag		(→ ⓘ 89)



Serial number		(→  89)
Firmware version		(→  89)
Device name		(→  89)
Order code		(→  89)
Extended order code 1 to 3		(→  89)
ENP version		(→  89)
Device revision		(→  89)
Device ID		(→  89)
Device type		(→  90)
Manufacturer ID		(→  90)
IP address		(→  90)
Subnet mask		(→  90)
Default gateway		(→  90)
<b>Measured values</b>	→	(→  75)
	<b>Process variables</b>	→ (→  75)
	Mass flow	(→  76)
	Volume flow	(→  76)
	Corrected volume flow	(→  76)
	Density	(→  76)
	Reference density	(→  76)
	Temperature	(→  76)
	Pressure value	(→  76)
	Dynamic viscosity	
	Kinematic viscosity	
	Temp. compensated dynamic viscosity	
	Temp. compensated kinematic viscosity	
	Concentration	
	Target mass flow	
	Carrier mass flow	
	<b>Totalizer 1 to 3</b>	→ (→  76)

	Totalizer value 1 to 3	(→  76)
	Totalizer overflow 1 to 3	(→  76)
	<b>Output values</b> →	(→  76)
	Output current	(→  77)
	Measured current	(→  77)
	Pulse output	(→  77)
	Output frequency	(→  77)
	Switch status	(→  77)
<b>Heartbeat <sup>1)</sup></b> →		(→  114)
	→ <b>Performing verification</b> →	
	Year	
	Month	
	Day	
	Hour	
	AM/PM	
	Minute	
	Verification mode	
	External device information	
	Start verification	
	Progress	
	Measured values	
	Output values	
	Status	
	Overall result	
	<b>Verification results</b> →	
	Date/time	
	Verification ID	
	Operating time	
	Overall result	
	Sensor	
	Sensor integrity	

	Sensor electronic module	
	I/O module	
	<b>Monitoring results</b> →	
	Sensor integrity	
	<b>Simulation</b> →	
	Assign simulation process variable	(→ 72)
	Value process variable	(→ 72)
	Simulation current output	(→ 72)
	Value current output	(→ 72)
	Frequency simulation	(→ 72)
	Frequency value	(→ 72)
	Pulse simulation	(→ 72)
	Pulse value	(→ 73)
	Switch output simulation	(→ 73)
	Switch status	(→ 73)
	Simulation device alarm	(→ 73)
	Simulation diagnostic event	(→ 73)

1) Order code for "Application package", option EB "Heartbeat Verification and Monitoring", see Special Documentation for the device

### 17.1.5 "Expert" menu

#### Overview "Expert" menu

<b>Expert</b> →	(→ 35)
Locking status (0004)	(→ 75)
Access status display (0091)	
Access status tooling	(→ 74)
Enter access code (0092)	(→ 73)
<b>System</b>	(→ 124)
<b>Sensor</b>	(→ 125)
<b>Output</b>	(→ 129)
<b>Communication</b>	(→ 131)

	<b>Application</b>	(→ 134)
	<b>Diagnostics</b>	(→ 134)

**"System" submenu**







<b>System</b>	→	
<b>Display</b>	→	(→ 69)
Display language (0104)		(→ 71)
Format display (0098)		(→ 60)
Value 1 display (0107)		(→ 60)
0% bargraph value 1 (0123)		(→ 60)
100% bargraph value 1 (0125)		(→ 60)
Decimal places 1 (0095)		(→ 70)
Value 2 display (0108)		(→ 60)
Decimal places 2 (0117)		(→ 70)
Value 3 display (0110)		(→ 60)
0% bargraph value 3 (0124)		(→ 60)
100% bargraph value 3 (0126)		(→ 60)
Decimal places 3 (0118)		(→ 71)
Value 4 display (0109)		(→ 60)
Decimal places 4 (0119)		(→ 71)
Display interval (0096)		(→ 71)
Display damping (0094)		(→ 71)
Header (0097)		(→ 71)
Header text (0112)		(→ 71)
Separator (0101)		(→ 71)
Backlight (0111)		(→ 71)
<b>Diagnostic handling</b>	→	(→ 79)
Alarm delay		
		<b>Diagnostic behavior</b>

	Assign behavior of diagnostic no. 044	
	Assign behavior of diagnostic no. 046	
	Assign behavior of diagnostic no. 144	
	Assign behavior of diagnostic no. 832	
	Assign behavior of diagnostic no. 833	
	Assign behavior of diagnostic no. 834	
	Assign behavior of diagnostic no. 835	
	Assign behavior of diagnostic no. 912	
	Assign behavior of diagnostic no. 913	
	Assign behavior of diagnostic no. 944	
	Assign behavior of diagnostic no. 192	
	Assign behavior of diagnostic no. 274	
	Assign behavior of diagnostic no. 835 (0678)	
	Assign behavior of diagnostic no. 392	
	Assign behavior of diagnostic no. 592	
	Assign behavior of diagnostic no. 992	
<b>Administration</b> →		(→ 📖 73)
Define access code		(→ 📖 73)
Device reset		(→ 📖 88)
Activate SW option		
Software option overview		

**"Sensor" submenu**

<b>Sensor</b> →
-----------------

<b>Measured values</b>	→	(→ 75)
<b>Process variables</b>	→	(→ 75)
Mass flow		(→ 76)
Volume flow		(→ 76)
Corrected volume flow		(→ 76)
Density		(→ 76)
Reference density		(→ 76)
Temperature		(→ 76)
Pressure value		(→ 76)
Concentration		
Target mass flow		
Carrier mass flow		
<b>Totalizer 1 to 3</b>	→	(→ 68)
Totalizer value 1 to 3		(→ 76)
Totalizer overflow 1 to 3		
<b>Output values</b>	→	(→ 76)
Output current (0361-1 to #)		(→ 77)
Measured current (0366-1 to #)		(→ 77)
Pulse output (0456)		(→ 77)
Output frequency (0471)		(→ 77)
Switch status (0461)		(→ 77)
<b>System units</b>	→	(→ 49)
Mass flow unit		(→ 50)
Mass unit		(→ 50)
Volume flow unit		(→ 50)
Volume unit		(→ 50)
Corrected volume flow unit		(→ 50)
Corrected volume unit		(→ 51)
Density unit		(→ 51)
Reference density unit		(→ 51)

Temperature unit		(→  51)
Pressure unit		(→  51)
Date/time format		
<b>User-specific units</b>	→	
	User mass text (0560)	
	User mass offset (0562)	
	User mass factor (0561)	
	User volume text (0567)	
	User volume offset (0569)	
	User volume factor (0568)	
	User corrected volume text (0592)	
	User corrected volume offset (0602)	
	User corrected volume factor (0590)	
	User density text (0570)	
	User density offset (0571)	
	User density factor (0572)	
	User pressure text (0581)	
	User pressure offset (0580)	
	User pressure factor (0579)	
<b>Process parameters</b>	→	(→  49)
Flow damping		
Density damping		
Temperature damping		
Flow override		
	<b>Low flow cut off</b>	(→  64)
	Assign process variable	(→  64)
	On value low flow cutoff	(→  64)

	Off value low flow cutoff	(→ 64)
	Pressure shock suppression	(→ 64)
	<b>Partially filled pipe detection</b> →	(→ 65)
	Assign process variable	(→ 65)
	Low value partial filled pipe detection	(→ 65)
	High value partial filled pipe detection	(→ 65)
	Response time part. filled pipe detect.	(→ 65)
	Maximum damping partial filled pipe det.	
<b>Measurement mode</b> →		(→ 52)
Select medium		(→ 52)
Select gas type		(→ 52)
Reference sound velocity		(→ 52)
Temperature coefficient sound velocity		(→ 52)
<b>External compensation</b> →		(→ 52)
Pressure compensation		(→ 52)
Pressure value		(→ 52)
External pressure		(→ 52)
External temperature		
<b>Calculated values</b> →		
	<b>Corrected volume flow calculation</b> →	
	Corrected volume flow calculation	(→ 67)
	External reference density	(→ 67)
	Fixed reference density	(→ 67)
	Reference temperature	(→ 67)
	Linear expansion coefficient	(→ 67)
	Square expansion coefficient	(→ 67)



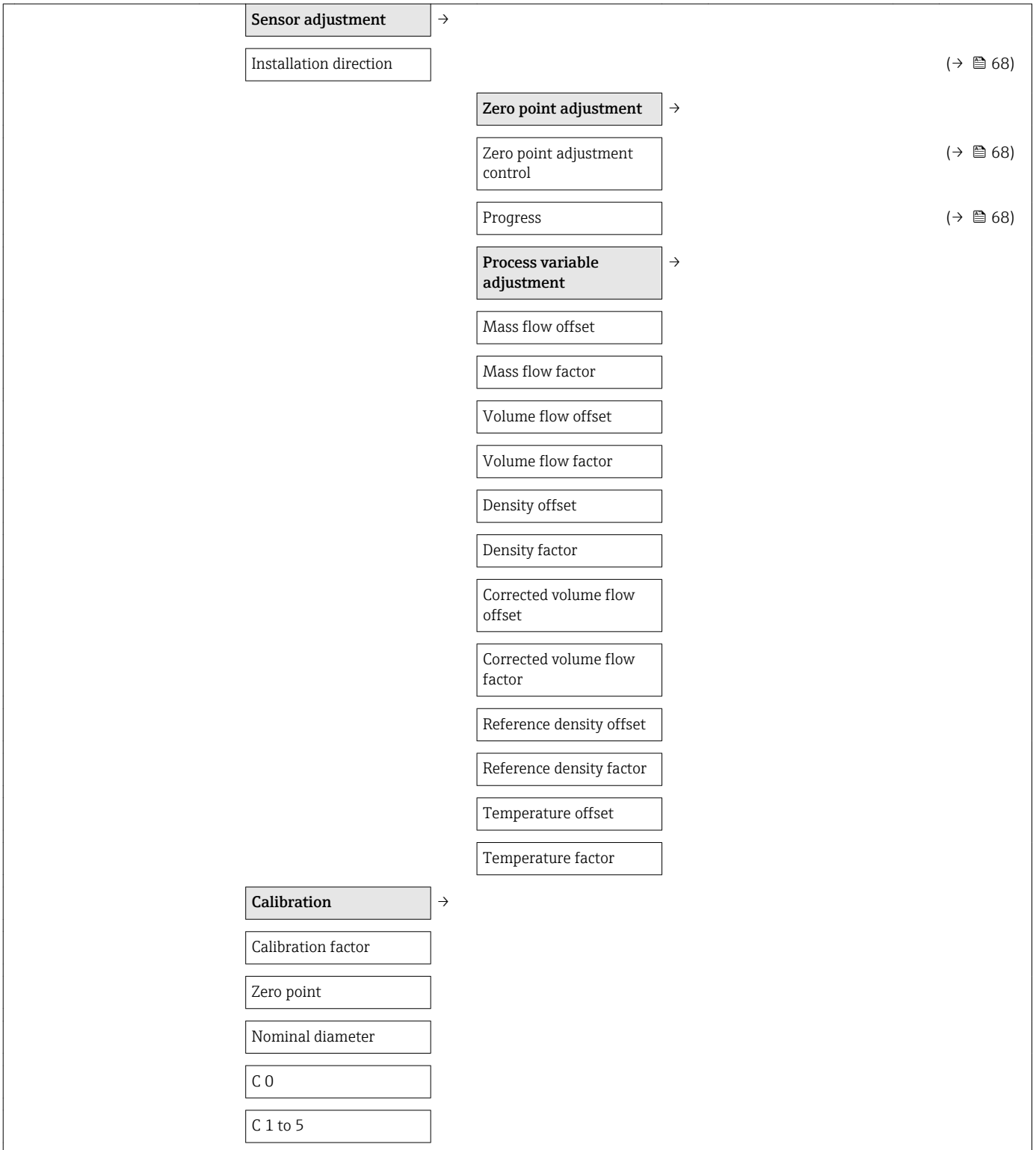



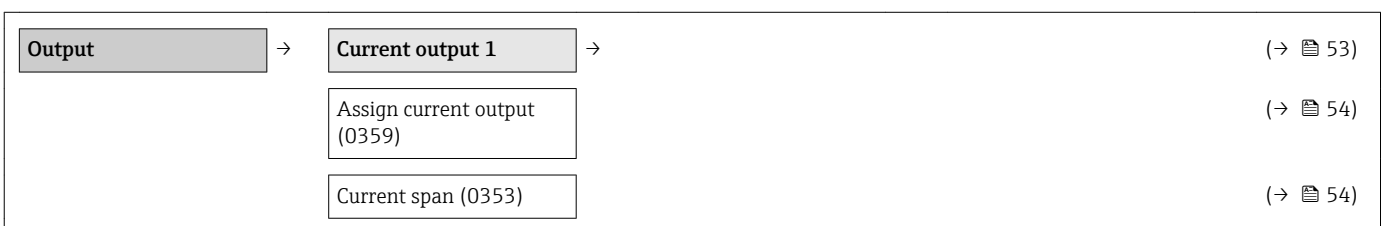









**"Output" submenu**



Fixed current (0365)	
0/4 mA value (0367)	(→ 54)
20 mA value (0372)	(→ 54)
Measuring mode (0351)	
Damping output (0363)	(→ 62)
Response time (0378)	
Failure mode (0364)	(→ 54)
Failure current (0352)	(→ 54)
Output current 1 (0361)	(→ 77)
Measured current 1 (0366)	(→ 77)
<b>Pulse/frequency/switch output 1</b>	(→ 55)
Operating mode (0469)	(→ 55)
Assign pulse output (0460)	(→ 55)
Value per pulse (0455)	(→ 55)
Pulse width (0452)	(→ 55)
Measuring mode (0351)	
Failure mode (0480)	(→ 55)
Pulse output 1 (0456)	(→ 77)
Assign frequency output (0478)	(→ 56)
Minimum frequency value (0453)	(→ 57)
Maximum frequency value (0454)	(→ 57)
Measuring value at minimum frequency (0476)	(→ 57)
Measuring value at maximum frequency (0475)	(→ 57)
Measuring mode (0479)	
Damping output	
Response time (0491)	
Failure mode (0451)	(→ 57)

Failure frequency (0474)	(→  57)
Output frequency 1 (0471)	(→  77)
Switch output function (0481)	(→  58)
Assign diagnostic behavior (0482)	(→  58)
Assign limit (0483)	(→  58)
Switch-on value (0466)	(→  58)
Switch-off value (0464)	(→  58)
Assign status (0485)	(→  58)
Switch-on delay (0467)	(→  58)
Switch-off delay (0465)	(→  59)
Failure mode (0486)	(→  59)
Switch status 1 (0461)	(→  77)
Invert output signal (0470)	(→  55)

**"Communication" submenu**

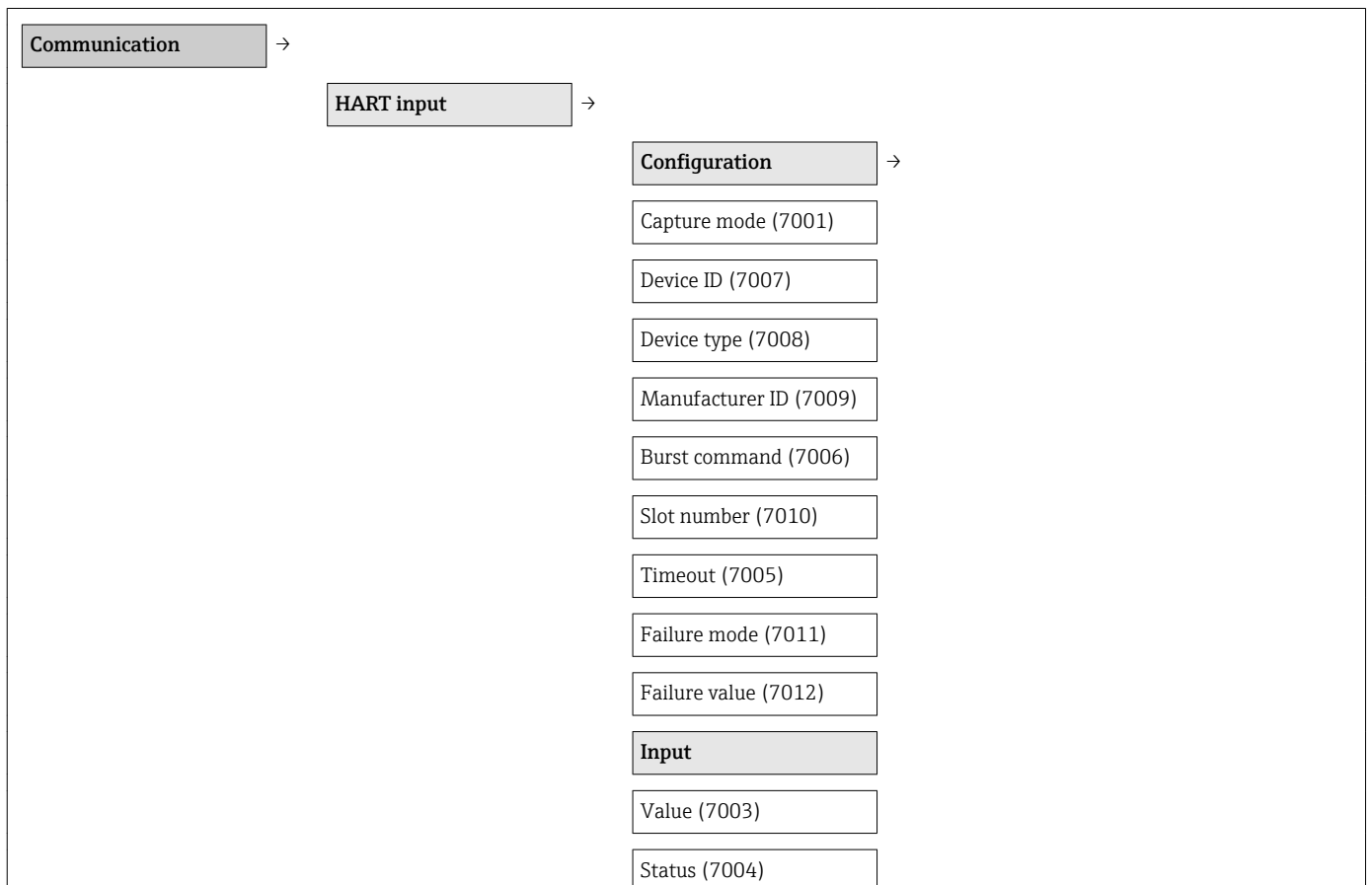

<b>HART output</b>	→	(→ 44)
<b>Configuration</b>	→	
HART short tag (0220)		
Device tag (0215)		
HART address (0219)		
No. of preambles (0217)		
<b>Burst configuration 1 to 3</b>	→	
Burst mode		
Burst command		
Burst device variable code 0...7		
Burst trigger mode		
Burst trigger level		
Min. update period		
Max. update period		
<b>Information</b>	→	(→ 88)
Device revision (0204)		(→ 89)
Device ID (0221)		(→ 89)
Device type (0222)		(→ 90)
Manufacturer ID (0223)		(→ 90)
HART revision (0205)		(→ 44)
HART descriptor (0212)		
HART message (0216)		
HART date code (0202)		
Hardware revision (0206)		
Software revision (0224)		
HART date code		
<b>Output</b>	→	(→ 44)
Assign PV (0234)		(→ 44)
Primary variable (PV) (0201)		(→ 44)
Assign SV (0235)		(→ 44)











	Secondary variable (SV) (0226)	(→ ⓘ 44)
	Assign TV (0236)	(→ ⓘ 44)
	Tertiary variable (TV) (0228)	(→ ⓘ 44)
	Assign QV (0237)	(→ ⓘ 44)
	Quaternary variable (QV) (0203)	(→ ⓘ 44)
<b>Web server</b> →		
Web server language		
MAC address		
IP address		
Subnet mask		
Default gateway		
Web server functionality		
<b>Diagnostic event category</b> →		
Event category 046		
Event category 140		
Event category 274		
Event category 441		
Event category 442		
Event category 443		
Event category 830		
Event category 831		
Event category 832		
Event category 833		
Event category 834		
Event category 835		
Event category 862		
Event category 912		
Event category 913		

**"Application" submenu**

<b>Application</b>	→	
Reset all totalizers (2806)		(→ ⓘ 78)
<b>Totalizer 1 to 3</b>	→	(→ ⓘ 68)
Assign process variable (0914)		(→ ⓘ 68)
Unit totalizer (0915)		(→ ⓘ 58)
Totalizer operation mode		(→ ⓘ 68)
Control Totalizer 1 to 3 (0912-1 to 3)		(→ ⓘ 78)
Preset value 1 to 3 (0913-1 to 3)		(→ ⓘ 78)
Failure mode (0901)		(→ ⓘ 68)
<b>Concentration</b>	→	
Concentration unit		
User concentration text		
User concentration factor		
User concentration offset		
A 0		
A 1 to 4		
B 1 to 3		

**"Diagnostics" submenu**

<b>Diagnostics</b>	→	(→ ⓘ 79)
Actual diagnostics (0691)		(→ ⓘ 86)
Timestamp		
Previous diagnostics (0690)		(→ ⓘ 86)
Timestamp		
Operating time from restart (0653)		(→ ⓘ 86)
Operating time (0652)		(→ ⓘ 86)
<b>Diagnostic list</b>	→	(→ ⓘ 86)

Diagnostics 1 to 5		(→  86)
<b>Event logbook</b>	→	(→  86)
Filter options (0705)		(→  87)
<b>Device information</b>	→	(→  88)
Device tag (0011)		(→  89)
Serial number (0009)		(→  89)
Firmware version (0010)		(→  89)
Device name (0013)		(→  89)
Order code (0008)		(→  89)
Extended order code 1 to 3 (0023-1 to 3)		(→  89)
Configuration counter		
ENP version (0012)		(→  89)
<b>Min/max values</b>	→	
Reset min/max values		
	<b>Electronic temperature</b>	→
	Minimum value	
	Maximum value	
	<b>Medium temperature</b>	→
	Minimum value	
	Maximum value	
	<b>Carrier pipe temperature</b>	→
	Minimum value	
	Maximum value	
	<b>Oscillation frequency</b>	→
	Minimum value	
	Maximum value	
	<b>Torsion oscillation frequency</b>	→
	Minimum value	
	Maximum value	
	<b>Oscillation amplitude</b>	→

	Minimum value	
	Maximum value	
	<b>Torsion oscillation amplitude</b>	→
	Minimum value	
	Maximum value	
	<b>Oscillation damping</b>	→
	Minimum value	
	Maximum value	
	<b>Torsion oscillation damping</b>	→
	Minimum value	
	Maximum value	
	<b>Signal asymmetry</b>	→
	Minimum value	
	Maximum value	
<b>Heartbeat <sup>1)</sup></b>		→
	Progress	
	Customer (2750)	
	Location (2751)	
	<b>Performing verification</b>	→
	Year (2846)	
	Month (2845)	
	Day (2842)	
	Hour (2843)	
	AM/PM (2813)	
	Minute (2844)	
	Start verification (12127)	
	Progress	
	Status	
	Overall result (12149)	
	<b>Verification results</b>	→
	Date/time (12142)	

(→ ⓘ 114)



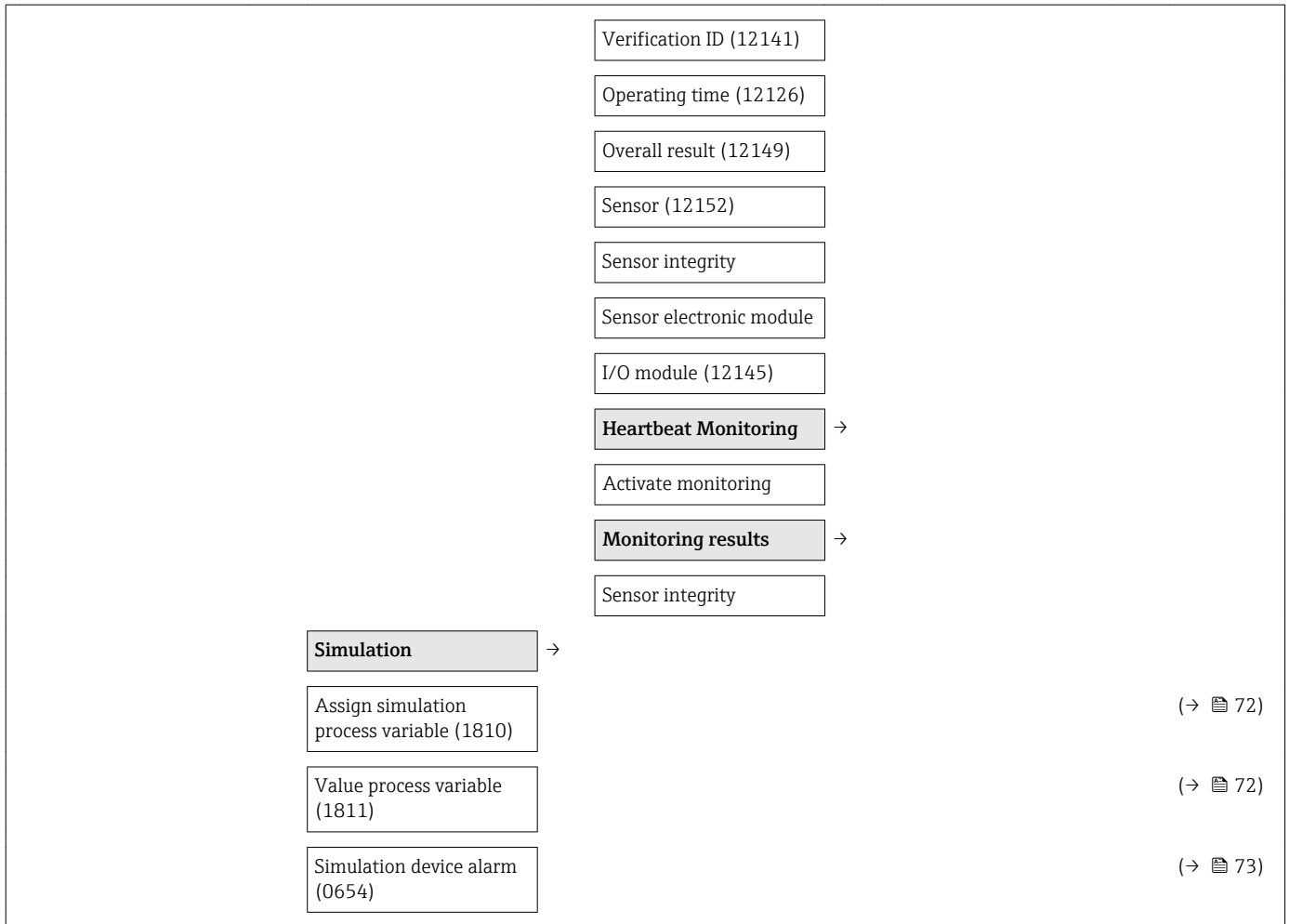

1) Order code for "Application package", option EB "Heartbeat Verification and Monitoring", see the Special Documentation for the device

# Index

## A

Accuracy	101
Adapting the diagnostic behavior	82
Adapting the status signal	82
Ambient temperature	
Influence	102
Ambient temperature range	20
AMS Device Manager	42
Function	42
Application	8, 96
Application packages	113
Applicator	96
Approvals	112

## C

C-Tick symbol	112
Cable entries	
Technical data	100
Cable entry	
Degree of protection	31
CE mark	9, 112
Certificates	112
Check	
Installation	25
Checklist	
Post-connection check	31
Post-installation check	25
Cleaning	
Cleaning in place (CIP)	91
Exterior cleaning	91
Interior cleaning	91
Sterilization in place (SIP)	91
Cleaning in place (CIP)	105
Climate class	104
Commissioning	49
Advanced settings	66
Configuring the measuring device	49
Communication-specific data	44
Connecting cable	27
Connecting the measuring device	29
Connection	
see Electrical connection	
Connection preparations	29
Connection tools	27
Current consumption	100

## D

Declaration of Conformity	9
Define access code	73
Degree of protection	31, 104
Density	105
Design	
Measuring device	11
Design fundamentals	
Maximum measured error	103
Repeatability	103

Designated use	8
Device components	11
Device description files	44
Device documentation	
Supplementary documentation	7
Device locking, status	75
Device name	
Sensor	14
Transmitter	13
Device repair	92
Device revision	44
Device type ID	44
Diagnostic information	
Design, description	81
FieldCare	80
Light emitting diodes	80
Overview	82
Remedial measures	82
Diagnostic list	86
DIP switch	
see Write protection switch	
Disabling write protection	73
Display	
Current diagnostic event	85
Previous diagnostic event	85
Display values	
For locking status	75
Disposal	92
Document	
Function	5
Symbols used	5
Document function	5
Down pipe	18

## E

Electrical connection	
Commubox FXA195	39, 110
Degree of protection	31
Field Communicator	39, 110
Handheld terminals	39, 110
Measuring device	27
Operating tools	39, 110
Via HART protocol	39, 110
Via service interface (CDI-RJ45)	40
Web server	40
Electromagnetic compatibility	105
Enabling write protection	73
Endress+Hauser services	
Maintenance	91
Repair	92
Error messages	
see Diagnostic messages	
Event history	86
Events list	86
Ex approval	112
Extended order code	

- Sensor . . . . . 14
- Transmitter . . . . . 13
- Exterior cleaning . . . . . 91
- F**
- Field Communicator
  - Function . . . . . 43
- Field Communicator 475 . . . . . 43
- Field of application
  - Residual risks . . . . . 9
- Field Xpert
  - Function . . . . . 40
- Field Xpert SFX350 . . . . . 40
- FieldCare . . . . . 40
  - Device description file . . . . . 44
  - Establishing a connection . . . . . 41
  - Function . . . . . 40
  - User interface . . . . . 42
- Filtering the event logbook . . . . . 87
- Firmware
  - Release date . . . . . 44
  - Version . . . . . 44
- Firmware history . . . . . 90
- Flow direction . . . . . 19, 25
- Flow limit . . . . . 106
- Function check . . . . . 49
- Function scope
  - AMS Device Manager . . . . . 42
  - Field Communicator . . . . . 43
  - Field Communicator 475 . . . . . 43
  - Field Xpert . . . . . 40
  - SIMATIC PDM . . . . . 42
- Functions
  - see Parameter
- G**
- Galvanic isolation . . . . . 99
- H**
- Hardware write protection . . . . . 74
- HART input
  - Settings . . . . . 60
- HART protocol
  - Device variables . . . . . 44
  - Measured variables . . . . . 44
- Hygienic compatibility . . . . . 112
- I**
- I/O electronics module . . . . . 11, 29
- Identifying the measuring device . . . . . 12
- Incoming acceptance . . . . . 12
- Influence
  - Ambient temperature . . . . . 102
  - Medium pressure . . . . . 103
  - Medium temperature . . . . . 103
- Information on the document . . . . . 5
- Inlet runs . . . . . 19
- Input . . . . . 96
- Inspection
  - Received goods . . . . . 12
- Inspection check
  - Connection . . . . . 31
- Installation . . . . . 18
- Installation conditions
  - Down pipe . . . . . 18
  - Mounting location . . . . . 18
  - Orientation . . . . . 19
  - Rupture disk . . . . . 22
  - Sensor heating . . . . . 21
  - System pressure . . . . . 20
  - Thermal insulation . . . . . 20
  - Vibrations . . . . . 22
- Installation dimensions . . . . . 19
- Interior cleaning . . . . . 91, 105
- L**
- Languages, operation options . . . . . 111
- Low flow cut off . . . . . 99
- M**
- Main electronics module . . . . . 11
- Maintenance tasks . . . . . 91
- Manufacturer ID . . . . . 44
- Manufacturing date . . . . . 13, 14
- Materials . . . . . 107
- Maximum measured error . . . . . 101
- Measured variables
  - see Process variables
- Measuring and test equipment . . . . . 91
- Measuring device
  - Configuring . . . . . 49
  - Conversion . . . . . 92
  - Design . . . . . 11
  - Disposal . . . . . 93
  - Integrating via HART protocol . . . . . 44
  - Mounting the sensor . . . . . 25
  - Preparing for electrical connection . . . . . 29
  - Preparing for mounting . . . . . 25
  - Removing . . . . . 92
  - Repair . . . . . 92
- Measuring principle . . . . . 96
- Measuring range
  - Calculation example for gas . . . . . 97
  - For gases . . . . . 96
  - For liquids . . . . . 96
- Measuring range, recommended . . . . . 106
- Measuring system . . . . . 96
- Media . . . . . 8
- Medium pressure
  - Influence . . . . . 103
- Medium temperature
  - Influence . . . . . 103
- menu
  - Diagnostics . . . . . 85
  - Operation . . . . . 75
  - Setup . . . . . 49
- Menus
  - For measuring device configuration . . . . . 49
  - For specific settings . . . . . 66

Mounting dimensions	
see Installation dimensions	
Mounting location . . . . .	18
Mounting preparations . . . . .	25
Mounting requirements	
Inlet and outlet runs . . . . .	19
Installation dimensions . . . . .	19
Mounting tools . . . . .	25
<b>N</b>	
Nameplate	
Sensor . . . . .	14
Transmitter . . . . .	13
Nominal pressure	
Secondary containment . . . . .	105
<b>O</b>	
Operable flow range . . . . .	97
Operating menu	
Menus, submenus . . . . .	34
Overview of menus with parameters . . . . .	115
Structure . . . . .	34
Submenus and user roles . . . . .	35
Operating philosophy . . . . .	35
Operation . . . . .	75
Operation options . . . . .	33
Operational safety . . . . .	9
Order code . . . . .	13, 14
Orientation (vertical, horizontal) . . . . .	19
Outlet runs . . . . .	19
Output . . . . .	97
Output signal . . . . .	97
Overview	
Operating menu . . . . .	115
<b>P</b>	
Packaging disposal . . . . .	17
Parameter settings	
Burst configuration 1 to 3 (submenu) . . . . .	46
Calculated values (submenu) . . . . .	66
Configuration (submenu) . . . . .	60
Current output 1 to 2 (wizard) . . . . .	53
Device information (submenu) . . . . .	88
Diagnostics (menu) . . . . .	85
Display (submenu) . . . . .	69
Display (wizard) . . . . .	59
Low flow cut off (wizard) . . . . .	64
Operation (submenu) . . . . .	77
Output conditioning (wizard) . . . . .	61
Output values (submenu) . . . . .	76
Partially filled pipe detection (wizard) . . . . .	65
Process variables (submenu) . . . . .	75
Pulse/frequency/switch output (wizard) . . . . .	55, 57
Select medium (submenu) . . . . .	52
Sensor adjustment (submenu) . . . . .	67
Setup (menu) . . . . .	49
Simulation (submenu) . . . . .	71
System units (submenu) . . . . .	49
Totalizer (submenu) . . . . .	76
Totalizer 1 to 3 (submenu) . . . . .	68
Web server (submenu) . . . . .	38
Performance characteristics . . . . .	101
Post-connection check (checklist) . . . . .	31
Post-installation check . . . . .	49
Post-installation check (checklist) . . . . .	25
Potential equalization . . . . .	100
Power consumption . . . . .	100
Power supply failure . . . . .	100
Pressure loss . . . . .	106
Pressure-temperature ratings . . . . .	105
Process connections . . . . .	109
Process variables	
Calculated . . . . .	96
Measured . . . . .	96
Product safety . . . . .	9
Protecting parameter settings . . . . .	73
<b>R</b>	
Reading measured values . . . . .	75
Recalibration . . . . .	91
Reference operating conditions . . . . .	101
Registered trademarks . . . . .	7
Remote operation . . . . .	110
Repair . . . . .	92
Notes . . . . .	92
Repair of a device . . . . .	92
Repeatability . . . . .	102
Replacement	
Device components . . . . .	92
Requirements for personnel . . . . .	8
Response time . . . . .	102
Returning devices . . . . .	92
Rupture disk	
Safety instructions . . . . .	22
Triggering pressure . . . . .	106
<b>S</b>	
Safety . . . . .	8
Seals	
Medium temperature range . . . . .	105
Sensor	
Medium temperature range . . . . .	105
Mounting . . . . .	25
Sensor heating . . . . .	21
Serial number . . . . .	13, 14
Service interface (CDI-RJ45) . . . . .	111
Settings	
Adapting the measuring device to the process conditions . . . . .	77
Advanced display configurations . . . . .	69
Current output . . . . .	53
Device reset . . . . .	88
Device tag . . . . .	49
HART input . . . . .	60
Local display . . . . .	59
Low flow cut off . . . . .	64
Medium . . . . .	52
Output conditioning . . . . .	61

- Partial filled pipe detection . . . . . 65
  - Pulse/frequency/switch output . . . . . 55
  - Resetting the totalizer . . . . . 77
  - Sensor adjustment . . . . . 67
  - Simulation . . . . . 71
  - System units . . . . . 49
  - Totalizer . . . . . 68
  - Totalizer reset . . . . . 77
  - Shock resistance . . . . . 104
  - Signal on alarm . . . . . 98
  - SIMATIC PDM . . . . . 42
    - Function . . . . . 42
  - Software release . . . . . 44
  - Spare part . . . . . 92
  - Spare parts . . . . . 92
  - Special connection instructions . . . . . 31
  - Standards and guidelines . . . . . 112
  - Status signals . . . . . 81
  - Sterilization in place (SIP) . . . . . 105
  - Storage conditions . . . . . 16
  - Storage temperature . . . . . 16
  - Structure
    - Operating menu . . . . . 34
    - submenu
      - Advanced setup . . . . . 66
      - Burst configuration 1 to 3 . . . . . 46
      - Calculated values . . . . . 66
      - Configuration . . . . . 60
      - Device information . . . . . 88
      - Display . . . . . 69
      - Operation . . . . . 77
      - Output values . . . . . 76
      - Process variables . . . . . 75
      - Select medium . . . . . 52
      - Sensor adjustment . . . . . 67
      - Simulation . . . . . 71
      - System units . . . . . 49
      - Totalizer . . . . . 76
      - Totalizer 1 to 3 . . . . . 68
      - Web server . . . . . 38
  - Submenu
    - Define access code . . . . . 73
    - Events list . . . . . 86
    - Overview . . . . . 35
    - Process variables . . . . . 66
  - Supply voltage . . . . . 100
  - System design
    - Measuring system . . . . . 96
      - see Measuring device design
  - System integration . . . . . 44
  - System pressure . . . . . 20
- T**
- Technical data, overview . . . . . 96
  - Temperature range
    - Medium temperature . . . . . 105
    - Storage temperature . . . . . 16
  - Terminal assignment . . . . . 28, 29
  - Terminals . . . . . 100
  - Thermal insulation . . . . . 20
  - Tools
    - Electrical connection . . . . . 27
    - Installation . . . . . 25
    - Transport . . . . . 16
  - Transmitter
    - Connecting the signal cables . . . . . 29
  - Transporting the measuring device . . . . . 16
  - Troubleshooting
    - General . . . . . 79
- U**
- Use of the measuring device
    - Borderline cases . . . . . 8
    - Incorrect use . . . . . 8
      - see Designated use
  - User roles . . . . . 35
- V**
- Version data for the device . . . . . 44
  - Vibration resistance . . . . . 104
  - Vibrations . . . . . 22
- W**
- W@M . . . . . 91, 92
  - W@M Device Viewer . . . . . 12, 92
  - Weight
    - SI units . . . . . 107
    - Transport (notes) . . . . . 16
    - US units . . . . . 107
  - wizard
    - Current output 1 to 2 . . . . . 53
    - Define access code . . . . . 73
    - Display . . . . . 59
    - Low flow cut off . . . . . 64
    - Output conditioning . . . . . 61
    - Partially filled pipe detection . . . . . 65
    - Pulse/frequency/switch output . . . . . 55, 57
  - Workplace safety . . . . . 9
  - Write protection
    - Via access code . . . . . 73
    - Via write protection switch . . . . . 74
  - Write protection switch . . . . . 74

[www.addresses.endress.com](http://www.addresses.endress.com)

---