

Operating Instructions

Micropilot FMR50

HART

Free space radar

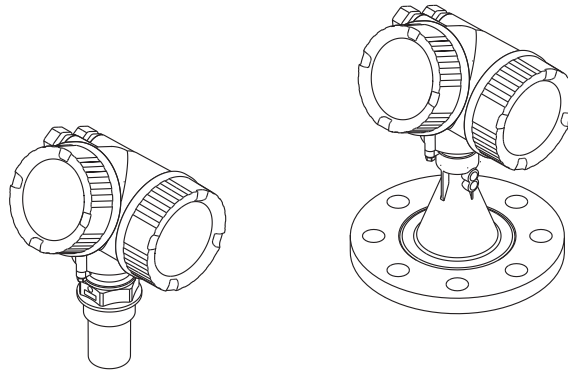

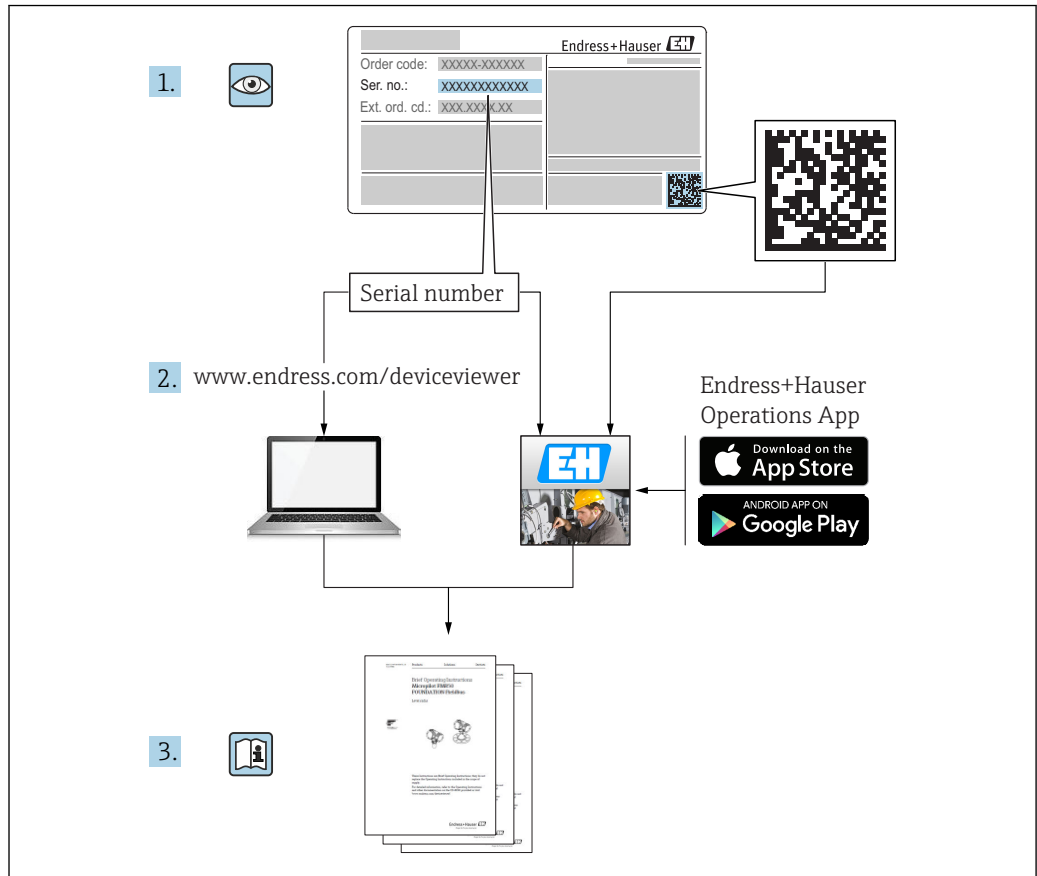

A0023555

Table of contents

1	Important document information	5		
1.1	Document function	5		
1.2	Symbols	5		
1.2.1	Safety symbols	5		
1.2.2	Electrical symbols	5		
1.2.3	Tool symbols	6		
1.2.4	Symbols for certain types of information	6		
1.2.5	Symbols in graphics	6		
1.2.6	Symbols at the device	7		
1.3	Additional documentation	7		
1.3.1	Safety Instructions (XA)	7		
2	Basic safety instructions	10		
2.1	Requirements for the personnel	10		
2.2	Designated use	10		
2.3	Workplace safety	11		
2.4	Operational safety	11		
2.5	Product safety	11		
2.5.1	CE mark	11		
2.5.2	EAC conformity	11		
3	Product description	12		
3.1	Product design	12		
3.1.1	Micropilot FMR50	12		
3.1.2	Electronics housing	13		
3.2	Registered trademarks	14		
4	Incoming acceptance and product identification	15		
4.1	Incoming acceptance	15		
4.2	Product identification	15		
4.2.1	Nameplate	16		
5	Storage, Transport	17		
5.1	Storage conditions	17		
5.2	Transport product to the measuring point	17		
6	Installation	18		
6.1	Installation conditions	18		
6.1.1	Mounting position	18		
6.1.2	Vessel installations	19		
6.1.3	Reduction of interference echoes	19		
6.1.4	Measurement in a plastic vessel	20		
6.1.5	Optimization options	20		
6.1.6	Beam angle	21		
6.2	Measuring conditions	22		
6.3	Installation in vessel (free space)	23		
6.3.1	Horn antenna encapsulated (FMR50)	23		
6.3.2	Horn antenna with slip-on flange (FMR50)	24		
6.3.3	Horn antenna with mounting bracket (FMR50)	26		
6.3.4	Measurement from the outside through plastic walls (FMR50/FMR51)	26		
6.4	Installation in stilling well	27		
6.4.1	Recommendations for the stilling well	27		
6.4.2	Examples for the construction of stilling wells	28		
6.5	Installation in bypass	29		
6.5.1	Recommendations for the bypass pipe	29		
6.5.2	Example for the construction of a bypass	30		
6.6	Vessels with heat insulation	31		
6.7	Turning the transmitter housing	31		
6.8	Turning the display module	32		
6.9	Post-installation check	32		
7	Electrical connection	33		
7.1	Connection conditions	33		
7.1.1	Terminal assignment	33		
7.1.2	Cable specification	38		
7.1.3	Device plug connectors	39		
7.1.4	Supply voltage	40		
7.1.5	Overvoltage protection	42		
7.2	Connecting the device	42		
7.2.1	Pluggable spring-force terminals	43		
7.3	Post-connection check	44		
8	Operation options	45		
8.1	Overview	45		
8.1.1	Local operation	45		
8.1.2	Operation with remote display and operating module FHX50	46		
8.1.3	Remote operation	46		
8.2	Structure and function of the operating menu	48		
8.2.1	Structure of the operating menu	48		
8.2.2	User roles and related access authorization	49		
8.2.3	Write protection via access code	50		
8.2.4	Disabling write protection via access code	51		
8.2.5	Deactivation of the write protection via access code	51		
8.2.6	Write protection via write protection switch	52		
8.2.7	Enabling and disabling the keypad lock	54		

8.3	Display and operating module	55	14	Repairs	83
8.3.1	Display appearance	55	14.1	General information on repairs	83
8.3.2	Operating elements	58	14.1.1	Repair concept	83
8.3.3	Entering numbers and text	59	14.1.2	Repairs to Ex-approved devices	83
8.3.4	Opening the context menu	61	14.1.3	Replacement of an electronics module	83
8.3.5	Envelope curve on the display and operating module	62	14.1.4	Replacement of a device	83
9	System integration via HART protocol	63	14.2	Spare parts	84
9.1	Overview of the Device Description files (DD)	63	14.3	Return	84
9.2	Measured values via HART protocol	63	14.4	Disposal	84
10	Commissioning via wizard	64	15	Accessories	85
11	Commissioning via operating menu	65	15.1	Device-specific accessories	85
11.1	Installation and function check	65	15.1.1	Weather protection cover	85
11.2	Setting the operating language	65	15.1.2	Mounting nut G1-1/2	85
11.3	Configuration of a level measurement	66	15.1.3	Variable flange seal for FMR50/ FMR56	86
11.4	Recording the reference curve	68	15.1.4	Mounting bracket for wall or ceiling mounting of FMR50/FMR56	87
11.5	Configuration of the on-site display	69	15.1.5	Installation bracket for FMR50	88
11.5.1	Factory settings of the on-site display	69	15.1.6	Remote display FHX50	89
11.5.2	Adjustment of the on-site display	69	15.1.7	Overvoltage protection	90
11.6	Configuration of the current outputs	69	15.2	Communication-specific accessories	91
11.6.1	Factory setting of the current outputs	69	15.3	Service-specific accessories	92
11.6.2	Adjustment of the current outputs	69	15.4	System components	92
11.7	Configuration management	70	16	Operating menu	93
11.8	Protection of the settings against unauthorized changes	71	16.1	Overview of the operating menu (display module)	93
12	Diagnostics and troubleshooting	72	16.2	Overview of the operating menu (operating tool)	100
12.1	General trouble shooting	72	16.3	"Setup" menu	106
12.1.1	General errors	72	16.3.1	"Mapping" wizard	114
12.1.2	Parametrization errors	72	16.3.2	"Advanced setup" submenu	116
12.2	Diagnostic information on local display	74	16.4	"Diagnostics" menu	160
12.2.1	Diagnostic message	74	16.4.1	"Diagnostic list" submenu	162
12.2.2	Calling up remedial measures	76	16.4.2	"Event logbook" submenu	163
12.3	Diagnostic event in the operating tool	77	16.4.3	"Device information" submenu	164
12.4	Diagnostic list	77	16.4.4	"Measured values" submenu	167
12.5	Overview of diagnostic events	78	16.4.5	"Data logging" submenu	169
12.6	Event logbook	79	16.4.6	"Simulation" submenu	172
12.6.1	Event history	79	16.4.7	"Device check" submenu	177
12.6.2	Filtering the event logbook	80	16.4.8	"Heartbeat" submenu	179
12.6.3	Overview of information events	80	Index	180	
12.7	Firmware history	81			
13	Maintenance	82			
13.1	Exterior cleaning	82			
13.2	Replacing seals	82			





1 Important document information

1.1 Document function







These Operating Instructions contain all the information that is required in various phases of the life cycle of the device: from product identification, incoming acceptance and storage, to mounting, connection, operation and commissioning through to troubleshooting, maintenance and disposal.

1.2 Symbols





1.2.1 Safety symbols

Symbol	Meaning
	DANGER! This symbol alerts you to a dangerous situation. Failure to avoid this situation will result in serious or fatal injury.
	WARNING! This symbol alerts you to a dangerous situation. Failure to avoid this situation can result in serious or fatal injury.
	CAUTION! This symbol alerts you to a dangerous situation. Failure to avoid this situation can result in minor or medium injury.
	NOTE! This symbol contains information on procedures and other facts which do not result in personal injury.





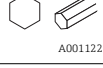







1.2.2 Electrical symbols

Symbol	Meaning
	Direct current
	Alternating current
	Direct current and alternating current
	Ground connection A grounded terminal which, as far as the operator is concerned, is grounded via a grounding system.
	Protective ground connection A terminal which must be connected to ground prior to establishing any other connections.
	Equipotential connection A connection that has to be connected to the plant grounding system: This may be a potential equalization line or a star grounding system depending on national or company codes of practice.

1.2.3 Tool symbols



Symbol	Meaning
 A0013442	Torx screwdriver
 A0011220	Flat blade screwdriver
 A0011219	Cross-head screwdriver
 A0011221	Allen key
 A0011222	Hexagon wrench

1.2.4 Symbols for certain types of information

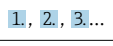

Symbol	Meaning
	Permitted Procedures, processes or actions that are permitted.
	Preferred Procedures, processes or actions that are preferred.
	Forbidden Procedures, processes or actions that are forbidden.
	Tip Indicates additional information.
	Reference to documentation
	Reference to page
	Reference to graphic
	Notice or individual step to be observed
	Series of steps
	Result of a step
	Help in the event of a problem
	Visual inspection

1.2.5 Symbols in graphics

Symbol	Meaning
1, 2, 3 ...	Item numbers
	Series of steps
A, B, C, ...	Views
A-A, B-B, C-C, ...	Sections

Symbol	Meaning
	Hazardous area Indicates a hazardous area.
	Safe area (non-hazardous area) Indicates the non-hazardous area.

1.2.6 Symbols at the device

Symbol	Meaning
	Safety instructions Observe the safety instructions contained in the associated Operating Instructions.
	Temperature resistance of the connection cables Specifies the minimum value of the temperature resistance of the connection cables.

1.3 Additional documentation

Document	Purpose and content of the document
Technical Information TI01039F (FMR50)	Planning aid for your device The document contains all the technical data on the device and provides an overview of the accessories and other products that can be ordered for the device.
Brief Operating Instructions KA01099F (FMR50, HART)	Guide that takes you quickly to the 1st measured value The Brief Operating Instructions contain all the essential information from incoming acceptance to initial commissioning.
Description of Device Parameters GP01014F (FMR5x, HART)	Reference for your parameters The document provides a detailed explanation of each individual parameter in the operating menu. The description is aimed at those who work with the device over the entire life cycle and perform specific configurations.
Special documentation SD01087F	Functional Safety Manual The document is part of the Operating Instructions and serves as a reference for application-specific parameters and notes.
Special documentation SD01870F	Manual for Heartbeat Verification and Heartbeat Monitoring The document contains descriptions of the additional parameters and technical data which are available with the Heartbeat Verification and Heartbeat Monitoring application packages.

 For an overview of the scope of the associated Technical Documentation, refer to the following:

- The *W@M Device Viewer* : Enter the serial number from the nameplate (www.endress.com/deviceviewer)
- The *Endress+Hauser Operations App*: Enter the serial number from the nameplate or scan the 2-D matrix code (QR code) on the nameplate.

1.3.1 Safety Instructions (XA)

Depending on the approval, the following Safety Instructions (XA) are supplied with the device. They are an integral part of the Operating Instructions.

Feature 010	Approval	Available for	Feature 020 "Power Supply; Output"				
			A ¹⁾	B ²⁾	C ³⁾	E ⁴⁾ /G ⁵⁾	K ⁶⁾ /L ⁷⁾
BA	ATEX: II 1 G Ex ia IIC T6-T1 Ga	FMR50	XA00677F	XA00677F	XA00677F	XA00685F	-
BB	ATEX: II 1/2 G Ex ia IIC T6-T1 Ga/Gb	FMR50	XA00677F	XA00677F	XA00677F	XA00685F	-

Feature 010	Approval	Available for	Feature 020 "Power Supply; Output"				
			A ¹⁾	B ²⁾	C ³⁾	E ⁴⁾ /G ⁵⁾	K ⁶⁾ /L ⁷⁾
BC	ATEX: II 1/2 G Ex d [ia] IIC T6-T1 Ga/Gb	FMR50	XA00680F	XA00680F	XA00680F	XA00688F	XA00680F
BG	ATEX: II 3 G Ex nA IIC T6-T1 Gc	FMR50	XA00679F	XA00679F	XA00679F	XA00687F	XA00679F
BH	ATEX: II 3 G Ex ic IIC T6-T1 Gc	FMR50	XA00679F	XA00679F	XA00679F	XA00687F	XA00679F
B2	ATEX: II 1/2 G Ex ia IIC T6-T1 Ga/Gb ATEX: II 1/2 D Ex ia IIIC Txx°C Da/Db	FMR50	XA00683F	XA00683F	XA00683F	XA00691F	-
B3	ATEX: II 1/2 G Ex d [ia] IIC T6-T1 Ga/Gb ATEX: II 1/2 D Ex ta IIIC Txx°C Da/Db	FMR50	XA00684F	XA00684F	XA00684F	XA00692F	XA00684F
B4	ATEX: II 1/2 G Ex ia IIC T6-T1 Ga/Gb ATEX: II 1/2 G Ex d [ia] IIC T6-T1 Ga/Gb	FMR50	XA00681F	XA00681F	XA00681F	XA00689F	-
CB	CSA C/US XP Cl.I Div.1 Gr.A-D	FMR50	XA01112F	XA01112F	XA01112F	XA01114F	-
CC	CSA C/US XP Cl.I Div.1 Gr.A-D	FMR50	XA01113F	XA01113F	XA01113F	XA01115F	XA01113F
C2	CSA C/US IS Cl.I,II,III Div.1 Gr.A-G, NI Cl.1 Div.2, Ex ia	FMR50	XA01112F	XA01112F	XA01112F	XA01114F	-
C3	CSA C/US XP Cl.I,II,III Div.1 Gr.A-G, NI Cl.1 Div.2, Ex d	FMR50	XA01113F	XA01113F	XA01113F	XA01115F	XA01113F
FA	FM IS Cl.I Div.1 Gr.A-D	FMR50	XA01116F	XA01116F	XA01116F	XA01118F	-
FB	FM IS Cl.I,II,III Div.1 Gr.A-G, AEx ia, NI Cl.1 Div.2	FMR50	XA01116F	XA01116F	XA01116F	XA01118F	-
FC	FM XP Cl.I Div.1 Gr.A-D	FMR50	XA01117F	XA01117F	XA01117F	XA01119F	XA01117F
FD	FM XP Cl.I,II,III Div.1 Gr.A-G, AEx d, NI Cl.1 Div.2	FMR50	XA01117F	XA01117F	XA01117F	XA01119F	XA01117F
IA	IECEX: Ex ia IIC T6-T1 Ga	FMR50	XA00677F	XA00677F	XA00677F	XA00685F	-
IB	IECEX: Ex ia IIC T6-T1 Ga/Gb	FMR50	XA00677F	XA00677F	XA00677F	XA00685F	-
IC	IECEX: Ex d [ia] IIC T6-T1 Ga/Gb	FMR50	XA00680F	XA00680F	XA00680F	XA00688F	XA00680F
IG	IECEX: Ex nA IIC T6-T1 Gc	FMR50	XA00679F	XA00679F	XA00679F	XA00687F	XA00679F
IH	IECEX: Ex ic IIC T6-T1 Gc	FMR50	XA00679F	XA00679F	XA00679F	XA00687F	XA00679F
I2	IECEX: Ex ia IIC T6-T1 Ga/Gb IECEX: Ex ia IIIC Txx°C Da/Db	FMR50	XA00683F	XA00683F	XA00683F	XA00691F	-
I3	IECEX: Ex d [ia] IIC T6-T1 Ga/Gb IEXEx: Ex ta IIIC Txx°C Da/Db	FMR50	XA00684F	XA00684F	XA00684F	XA00692F	XA00684F
I4	IECEX: Ex ia IIC T6-T1 Ga/Gb IECEX: Ex d [ia] IIC T6-T1 Ga/Gb	FMR50	XA00681F	XA00681F	XA00681F	XA00689F	-
KA	KC Ex ia IIC T6 Ga	FMR50	XA01045F	XA01045F	XA01045F	XA01047F	-
KB	KC Ex ia IIC T6 Ga/Gb	FMR50	XA01045F	XA01045F	XA01045F	XA01047F	-
KC	KC Ex d[ia] IIC T6	FMR50	XA01046F	XA01046F	XA01046F	XA01048F	XA01046F
MA	INMETRO: Ex ia IIC T6 Ga	FMR50	XA01286F	XA01287F	XA01288F	XA01296F	-
MC	INMETRO: Ex d[ia] IIC T6 Ga/Gb	FMR50	XA01292F	XA01292F	XA01293F	XA01298F	XA01294F
MH	INMETRO: Ex ic IIC T6 Gc	FMR50	XA01289F	XA01290F	XA01291F	XA01297F	-
NA	NEPSI Ex ia IIC T6 Ga	FMR50	XA01199F	XA01199F	XA01199F	XA01208F	-
NB	NEPSI Ex ia IIC T6 Ga/Gb	FMR50	XA01199F	XA01199F	XA01199F	XA01208F	-
NC	NEPSI Ex d[ia] IIC T6 Ga/Gb	FMR50	XA01202F	XA01202F	XA01202F	XA01211F	XA01202F
NG	NEPSI Ex nA II T6 Gc	FMR50	XA01201F	XA01201F	XA01201F	XA01210F	XA01201F
NH	NEPSI Ex ic IIC T6 Gc	FMR50	XA01201F	XA01201F	XA01201F	XA01210F	XA01201F
N2	NEPSI Ex ia IIC T6 Ga/Gb, Ex iaD 20/21 T85... 90oC	FMR50	XA01205F	XA01205F	XA01205F	XA01214F	-

Feature 010	Approval	Available for	Feature 020 "Power Supply; Output"				
			A ¹⁾	B ²⁾	C ³⁾	E ^{4)/G⁵⁾}	K ^{6)/L⁷⁾}
N3	NEPSI Ex d [ia] IIC T6 Ga/Gb, DIP A20/21 T85...90°C IP66	FMR50	XA01206F	XA01206F	XA01206F	XA01215F	XA01206F
8A	FM/CSA IS+XP Cl.I,II,III Div.1 Gr.A-G	FMR50	<ul style="list-style-type: none"> ■ XA01112F ■ XA01113F ■ XA01116F ■ XA01117F 	<ul style="list-style-type: none"> ■ XA01112F ■ XA01113F ■ XA01116F ■ XA01117F 	<ul style="list-style-type: none"> ■ XA01112F ■ XA01113F ■ XA01116F ■ XA01117F 	<ul style="list-style-type: none"> ■ XA01114F ■ XA01115F ■ XA01118F ■ XA01119F 	-

- 1) 2-wire; 4-20mA HART
- 2) 2-wire; 4-20mA HART, switch output
- 3) 2-wire; 4-20mA HART, 4-20mA
- 4) 2-wire; FOUNDATION Fieldbus, switch output
- 5) 2-wire; PROFIBUS PA, switch output
- 6) 4-wire 90-253VAC; 4-20mA HART
- 7) 4-wire 10.4-48VDC; 4-20mA HART

 For certified devices the relevant Safety Instructions (XA) are indicated on the nameplate.

If the device is prepared for the remote display FHX50 (product structure: feature 030: "Display, Operation", option L or M), the Ex marking of some certificates changes according to the following table¹⁾:

Feature 010 ("Approval")	Feature 030 ("Display, Operation")	Ex marking
BG	L or M	ATEX II 3G Ex nA [ia Ga] IIC T6-T1 Gc
BH	L or M	ATEX II 3G Ex ic [ia Ga] IIC T6-T1 Gc
B3	L or M	ATEX II 1/2G Ex d [ia] IIC T6-T1 Ga/Gb, ATEX II 1/2D Ex ta [ia Db] IIIC Txx°C Da/Db
IG	L or M	IECEX Ex nA [ia Ga] IIC T6-T1 Gc
IH	L or M	IECEX Ex ic [ia Ga] IIC T6-T1 Gc
I3	L or M	IECEX Ex d [ia] IIC T6-T1 Ga/Gb, IECEX Ex ta [ia Db] IIIC Txx°C Da/Db
MH	L or M	Ex ic [ia Ga] IIC T6 Gc
NG	L or M	NEPSI Ex nA [ia Ga] IIC T6-T1 Gc
NH	L or M	NEPSI Ex ic [ia Ga] IIC T6-T1 Gc
N3	L or M	NEPSI Ex d [ia] IIC T6-T1 Ga/Gb, DIP A20/21 [ia D] TA, Txx°C IP6X

1) The marking of certificates not mentioned in this table are not affected by the FHX50.

2 Basic safety instructions

2.1 Requirements for the personnel

The personnel for installation, commissioning, diagnostics and maintenance must fulfill the following requirements:

- ▶ Trained, qualified specialists must have a relevant qualification for this specific function and task.
- ▶ Are authorized by the plant owner/operator.
- ▶ Are familiar with federal/national regulations.
- ▶ Before starting work, read and understand the instructions in the manual and supplementary documentation as well as the certificates (depending on the application).
- ▶ Follow instructions and comply with basic conditions.

The operating personnel must fulfill the following requirements:

- ▶ Are instructed and authorized according to the requirements of the task by the facility's owner-operator.
- ▶ Follow the instructions in this manual.

2.2 Designated use

Application and measured materials

The measuring device described in these Operating Instructions is intended for the continuous, contactless level measurement of liquids, pastes and sludge. The device can also be freely mounted outside closed metal vessels (e.g. above basins, open channels or open piles) because of its operating frequency of about 26 GHz, a maximum radiated pulsed power of 5.7 mW and an average power output of 0.015 mW (for the version with advanced dynamics: maximum pulse power: 23.3 mW; average power: 0.076 mW). Operation is completely harmless to humans and animals.

Observing the limit values specified in the "Technical data" and listed in the Operating Instructions and supplementary documentation, the measuring device may be used for the following measurements only:

- ▶ Measured process variables: level, distance, signal strength
- ▶ Calculated process variables: Volume or mass in arbitrarily shaped vessels; flow through measuring weirs or flumes (calculated from the level by the linearization functionality)

To ensure that the measuring device remains in proper condition for the operation time:

- ▶ Use the measuring device only for measured materials against which the process-wetted materials are adequately resistant.
- ▶ Observe the limit values in "Technical data".

Incorrect use

The manufacturer is not liable for damage caused by improper or non-designated use.

Verification for borderline cases:

- ▶ For special measured materials and cleaning agents, Endress+Hauser is glad to provide assistance in verifying the corrosion resistance of wetted materials, but does not accept any warranty or liability.

Residual risk

The electronics housing and its built-in components such as display module, main electronics module and I/O electronics module may heat to 80 °C (176 °F) during operation through heat transfer from the process as well as power dissipation within the electronics. During operation the sensor may assume a temperature near the temperature of the measured material.

Danger of burns due to heated surfaces!

- ▶ For high process temperatures: Install protection against contact in order to prevent burns.

2.3 Workplace safety

For work on and with the device:

- ▶ Wear the required personal protective equipment according to federal/national regulations.

2.4 Operational safety

Risk of injury.

- ▶ Operate the device in proper technical condition and fail-safe condition only.
- ▶ The operator is responsible for interference-free operation of the device.

Conversions to the device

Unauthorized modifications to the device are not permitted and can lead to unforeseeable dangers.

- ▶ If, despite this, modifications are required, consult with the manufacturer.

Repair

To ensure continued operational safety and reliability,

- ▶ Carry out repairs on the device only if they are expressly permitted.
- ▶ Observe federal/national regulations pertaining to repair of an electrical device.
- ▶ Use original spare parts and accessories from the manufacturer only.

Hazardous area

To eliminate a danger for persons or for the facility when the device is used in the hazardous area (e.g. explosion protection, pressure vessel safety):

- ▶ Based on the nameplate, check whether the ordered device is permitted for the intended use in the hazardous area.
- ▶ Observe the specifications in the separate supplementary documentation that is an integral part of these Instructions.

2.5 Product safety

This measuring device is designed in accordance with good engineering practice to meet state-of-the-art safety requirements, has been tested, and left the factory in a condition in which it is safe to operate. It meets general safety standards and legal requirements.

2.5.1 CE mark

The measuring system meets the legal requirements of the applicable EC guidelines. These are listed in the corresponding EC Declaration of Conformity together with the standards applied.

Endress+Hauser confirms successful testing of the device by affixing to it the CE mark.

2.5.2 EAC conformity

The measuring system meets the legal requirements of the applicable EAC guidelines. These are listed in the corresponding EAC Declaration of Conformity together with the standards applied.

Endress+Hauser confirms successful testing of the device by affixing to it the EAC mark.

3 Product description

3.1 Product design

3.1.1 Micropilot FMR50

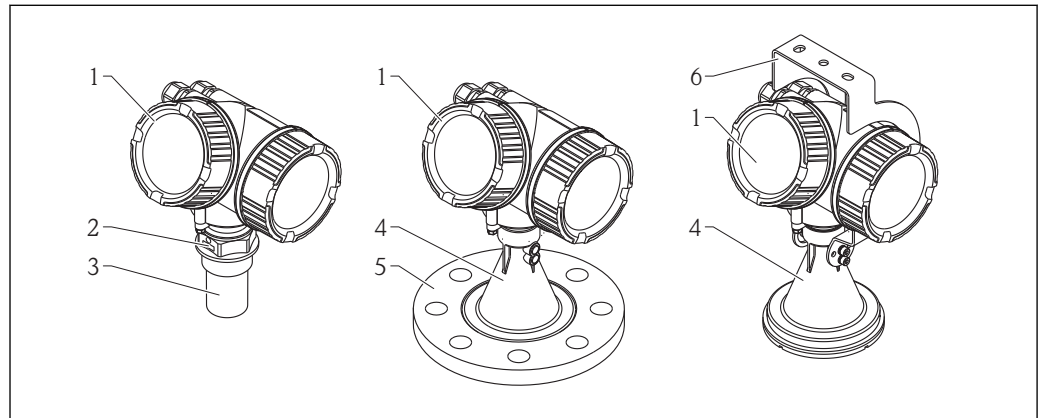

A0016784

 1 Design of the Micropilot FMR50 (26 GHz)

- 1 Electronics housing
- 2 Process connection (Thread)
- 3 Horn antenna 40 mm (1-1/2 in), PVDF encapsulated
- 4 Horn antenna 80mm/100 mm (3in/4 in), PP cladded
- 5 Slip-on flange
- 6 Mounting bracket

3.1.2 Electronics housing

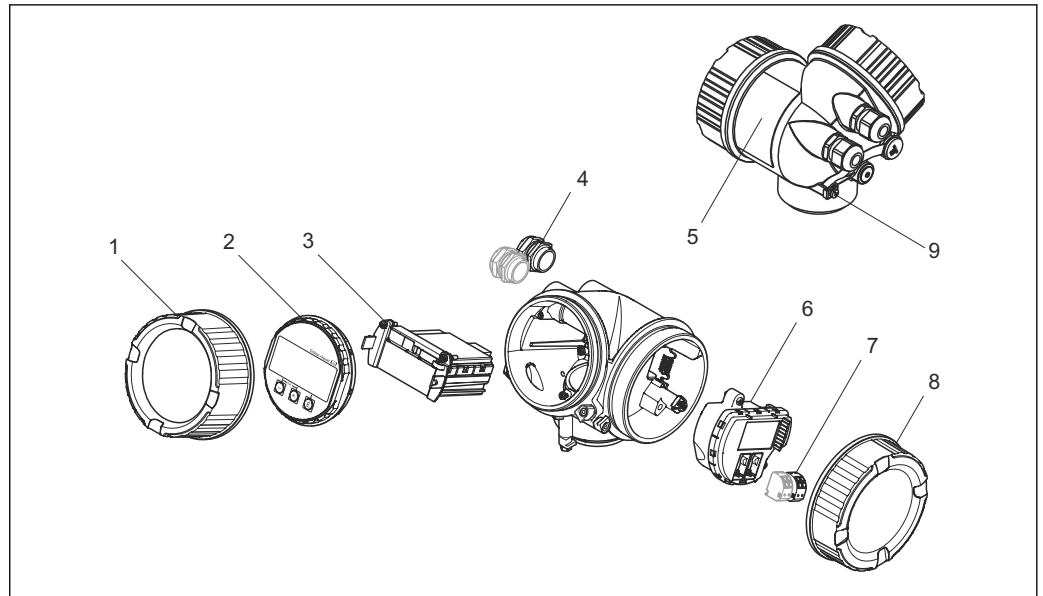

A0012422

2 Design of the electronics housing

- 1 Electronics compartment cover
- 2 Display module
- 3 Main electronics module
- 4 Cable glands (1 or 2, depending on instrument version)
- 5 Nameplate
- 6 I/O electronics module
- 7 Terminals (pluggable spring terminals)
- 8 Connection compartment cover
- 9 Grounding terminal

3.2 Registered trademarks

HART®

Registered trademark of the FieldComm Group, Austin, USA

KALREZ®, VITON®

Registered trademark of DuPont Performance Elastomers L.L.C., Wilmington, USA

TEFLON®

Registered trademark of E.I. DuPont de Nemours & Co., Wilmington, USA

TRI CLAMP®

Registered trademark of Alfa Laval Inc., Kenosha, USA

4 Incoming acceptance and product identification

4.1 Incoming acceptance

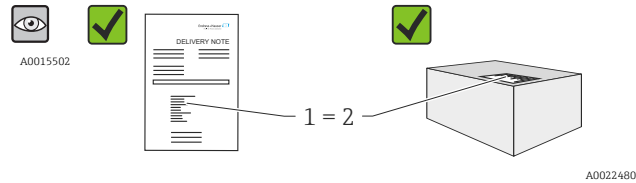

Are the order codes on the delivery note (1) and the product sticker (2) identical?

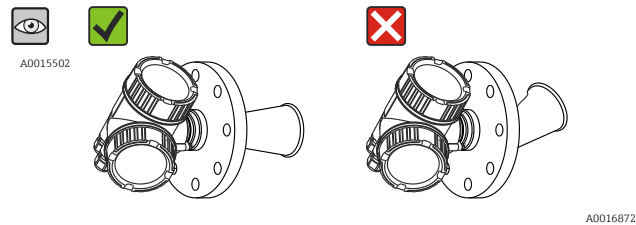
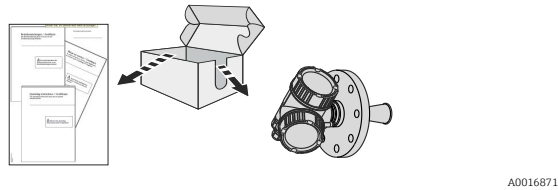

Are the goods undamaged?

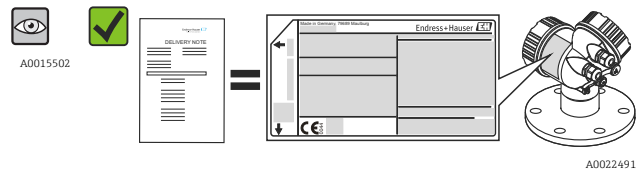

Do the nameplate data match the ordering information on the delivery note?

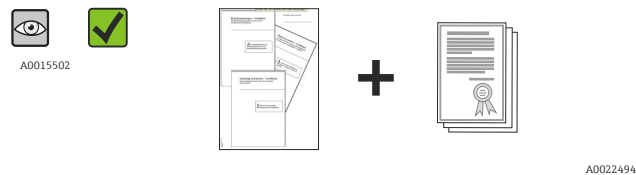

Is the DVD with the operating tool present?
If required (see nameplate): Are the Safety Instructions (XA) present?

 If one of these conditions is not satisfied, contact your Endress+Hauser Sales Center.

4.2 Product identification

The following options are available for identification of the measuring device:

- Nameplate specifications
- Extended order code with breakdown of the device features on the delivery note
- Enter serial numbers from nameplates in *W@M Device Viewer* (www.endress.com/deviceviewer): All information about the measuring device is displayed.
- Enter the serial number from the nameplates into the *Endress+Hauser Operations App* or scan the 2-D matrix code (QR code) on the nameplate with the *Endress+Hauser Operations App*: all the information for the measuring device is displayed.

For an overview of the scope of the associated Technical Documentation, refer to the following:

- The *W@M Device Viewer*: Enter the serial number from the nameplate (www.endress.com/deviceviewer)
- The *Endress+Hauser Operations App*: Enter the serial number from the nameplate or scan the 2-D matrix code (QR code) on the nameplate.

4.2.1 Nameplate

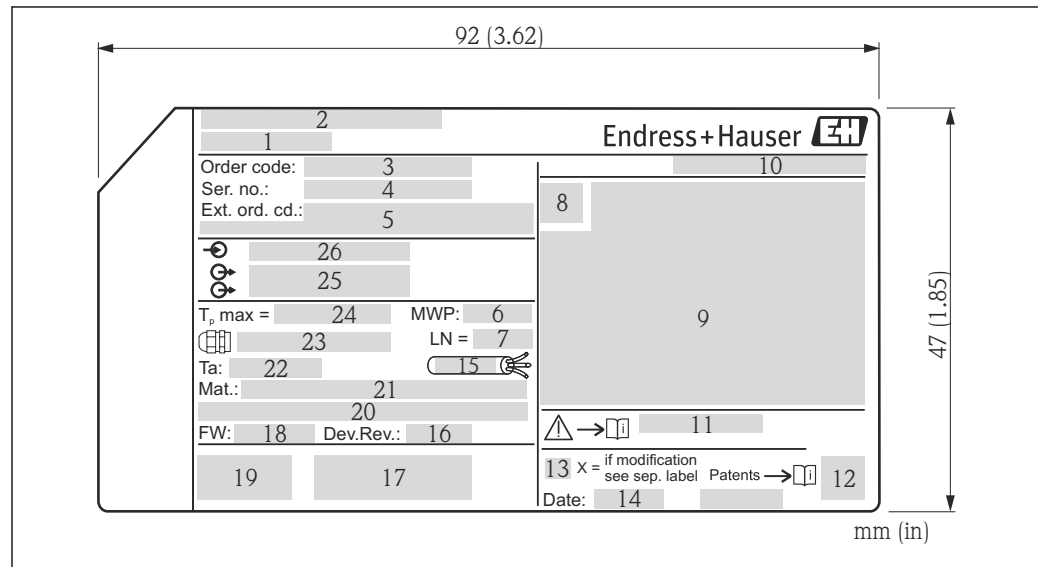

A0019444

3 Nameplate of the Micropilot

- 1 Device name
- 2 Address of manufacturer
- 3 Order code
- 4 Serial number (Ser. no.)
- 5 Extended order code (Ext. ord. cd.)
- 6 Process pressure
- 7 Antenna length (only for FMR51 with antenna extension)
- 8 Certificate symbol
- 9 Certificate and approval relevant data
- 10 Degree of protection: e.g. IP, NEMA
- 11 Document number of the Safety Instructions: e.g. XA, ZD, ZE
- 12 Data Matrix Code
- 13 Modification mark
- 14 Manufacturing date: year-month
- 15 Temperature resistance of the cable
- 16 Geräterevision (Dev.Rev.)
- 17 Additional information about the device version (certificates, approvals, communication): e.g. SIL, PROFIBUS
- 18 Firmware version (FW)
- 19 CE mark, C-Tick
- 20 Profibus PA: Profil-Version; FOUNDATION Fieldbus: Device ID
- 21 Material in contact with process
- 22 Permitted ambient temperature (T_a)
- 23 Size of the thread of the cable glands
- 24 Maximum process temperature
- 25 Signal outputs
- 26 Operating voltage

i Only 33 digits of the extended order code can be indicated on the nameplate. If the extended order code exceeds 33 digits, the rest will not be shown. However, the complete extended order code can be viewed in the operating menu of the device:
Extended order code 1 to 3 parameter

5 Storage, Transport

5.1 Storage conditions

- Permitted storage temperature: -40 to +80 °C (-40 to +176 °F)
- Use the original packaging.

5.2 Transport product to the measuring point

NOTICE

Housing or antenna horn may be damaged or break away.

Risk of injury!

- ▶ Transport the measuring device to the measuring point in its original packaging or at the process connection.
- ▶ Do not fasten lifting devices (hoisting slings, lifting eyes etc.) at the housing or the antenna horn but at the process connection. Take into account the mass center of the device in order to avoid unintended tilting.
- ▶ Comply with the safety instructions, transport conditions for devices over 18kg (39.6lbs) (IEC61010).

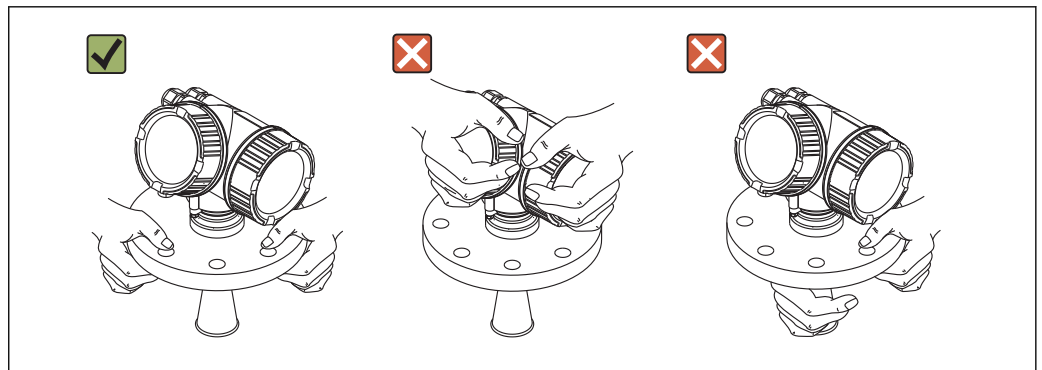

A0016875

6 Installation

6.1 Installation conditions

6.1.1 Mounting position

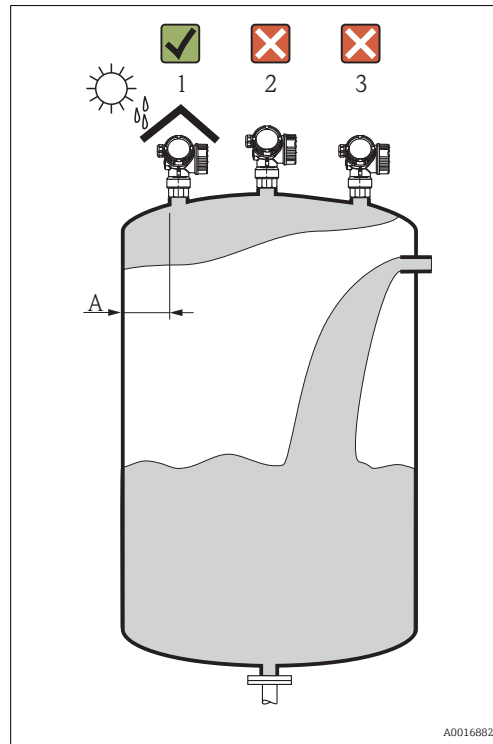

- Recommended distance **A** from wall to outer edge of nozzle: $\sim 1/6$ of tank diameter. Nevertheless the device should not be installed closer than 15 cm (5.91 in) to the tank wall.
- Not in the center (2), as interference can cause signal loss.
- Not above the fill stream (3).
- It is recommended to use a weather protection cover (1) in order to protect the device from direct sun or rain.

6.1.2 Vessel installations

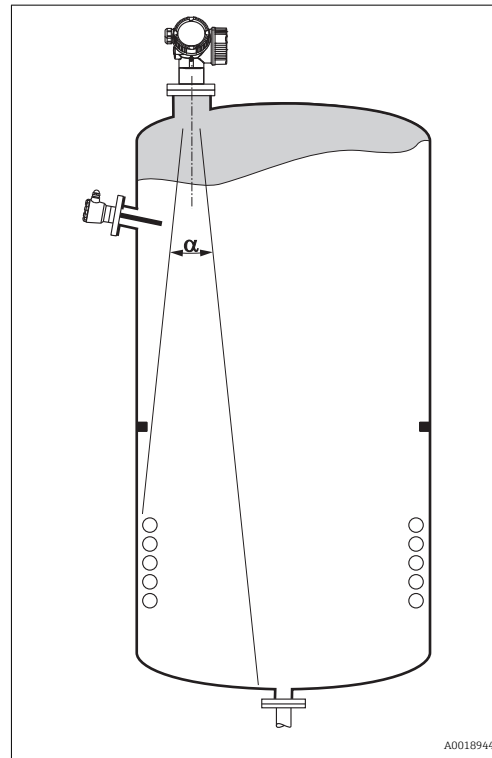

Avoid any installations (point level switches, temperature sensors, braces, vacuum rings, heating coils, baffles etc.) inside the signal beam. Take into account the beam angle \rightarrow 21.

6.1.3 Reduction of interference echoes

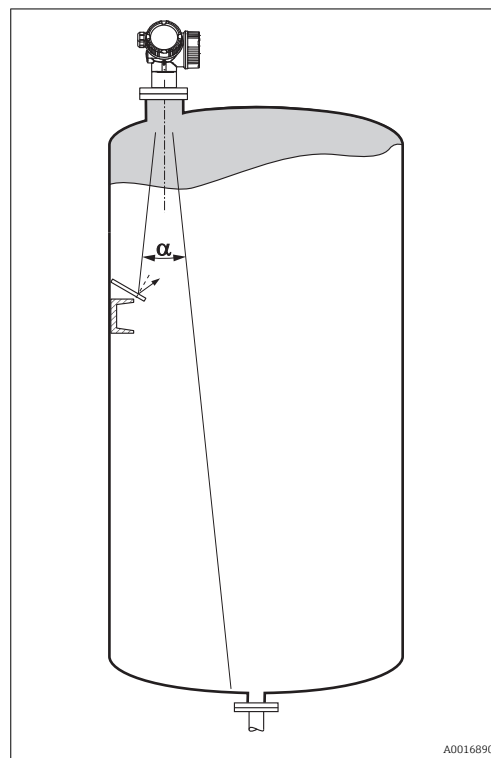

Metallic screens mounted at a slope spread the radar signal and can, therefore, reduce interference echoes.

6.1.4 Measurement in a plastic vessel

If the outer wall of the vessel is made of a non-conductive material (e.g. GRP), microwaves can also be reflected off interfering installations outside the vessel (e.g. metallic pipes (1), ladders (2), grates (3), ...). Therefore, there should be no such interfering installations in the signal beam. Please contact Endress+Hauser for further information.

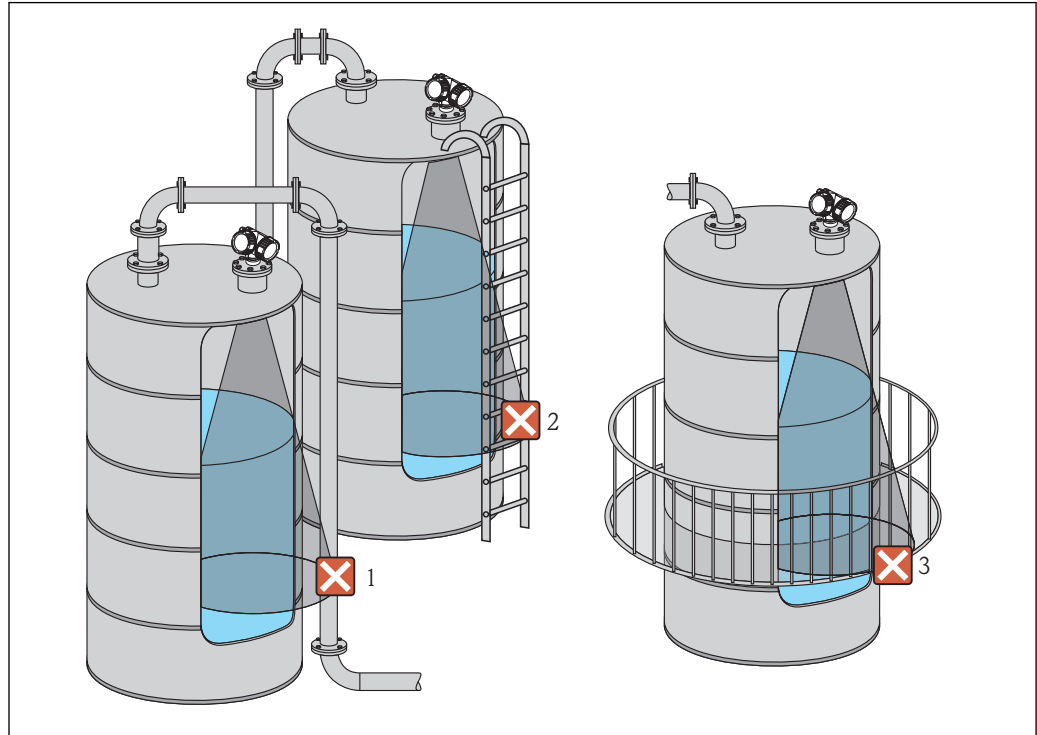

A0017123

6.1.5 Optimization options

- Antenna size
The bigger the antenna, the smaller the beam angle α and the fewer interference echoes
→ [21](#).
- Mapping
The measurement can be optimized by means of electronic suppression of interference echoes.
See the **Confirm distance** parameter (→ [110](#)) for details.
- Antenna alignment
Take into account the marker on the flange or threaded connection → [23](#)
→ [24](#).
- Stilling well
A stilling well can be applied to avoid interferences → [27](#).
- Metallic screens mounted at a slope
They spread the radar signals and can, therefore, reduce interference echoes.

6.1.6 Beam angle

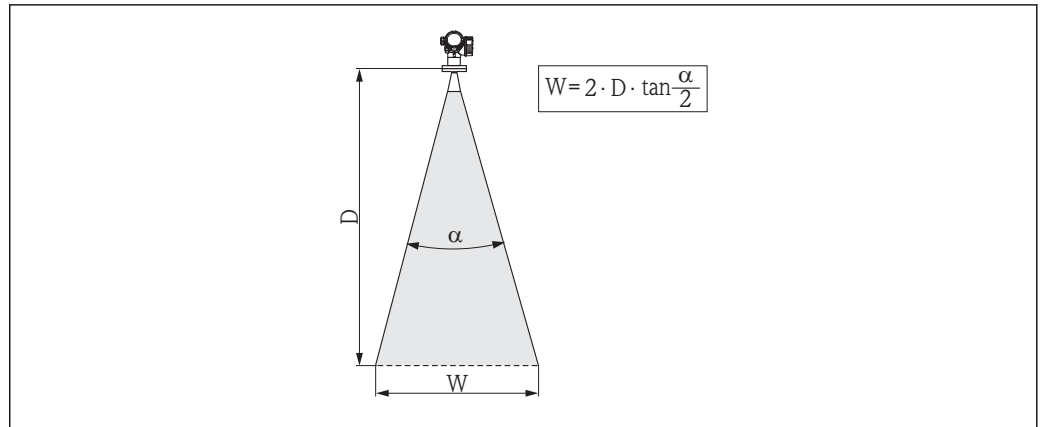

A0016891

4 Relationship between beam angle α , distance D and beamwidth diameter W

The beam angle is defined as the angle α where the energy density of the radar waves reaches half the value of the maximum energy density (3-dB-width). Microwaves are also emitted outside the signal beam and can be reflected off interfering installations.

Beam diameter W as a function of beam angle α and measuring distance D :

FMR50			
Antenna size	40 mm (1½ in)	80 mm (3 in)	100 mm (4 in)
Beam angle α	23°	10°	8°
Measuring distance (D)	Beamwidth diameter W		
3 m (9.8 ft)	1.22 m (4 ft)	0.53 m (1.7 ft)	0.42 m (1.4 ft)
6 m (20 ft)	2.44 m (8 ft)	1.05 m (3.4 ft)	0.84 m (2.8 ft)
9 m (30 ft)	3.66 m (12 ft)	1.58 m (5.2 ft)	1.26 m (4.1 ft)
12 m (39 ft)	4.88 m (16 ft)	2.1 m (6.9 ft)	1.68 m (5.5 ft)
15 m (49 ft)	6.1 m (20 ft)	2.63 m (8.6 ft)	2.10 m (6.9 ft)
20 m (66 ft)	8.14 m (27 ft)	3.50 m (11 ft)	2.80 m (9.2 ft)
25 m (82 ft)	10.17 m (33 ft)	4.37 m (14 ft)	3.50 m (11 ft)
30 m (98 ft)	-	5.25 m (17 ft)	4.20 m (14 ft)
35 m (115 ft)	-	6.12 m (20 ft)	4.89 m (16 ft)
40 m (131 ft)	-	7.00 m (23 ft)	5.59 m (18 ft)

6.2 Measuring conditions

- In case of **boiling surfaces, bubbling** or tendency for **foaming** use FMR53 or FMR54. Depending on its consistence, foam can either absorb microwaves or reflect them off the foam surface. Measurement is possible under certain conditions. For FMR50, FMR51 and FMR52, the additional option "Advanced dynamics" is recommended in these cases (feature 540: "Application Package", option EM).
- In case of heavy **steam development** or **condensate**, the maximum measuring range of FMR50, FMR51 and FMR52 may decrease depending on density, temperature and composition of the steam → use FMR53 or FMR54.
- For the measurement of absorbing gases such as **ammonia NH₃** or some **fluorocarbons**²⁾, please use Levelflex or Micropilot FMR54 in a stilling well.
- The measuring range begins, where the beam hits the tank bottom. Particularly with dish bottoms or conical outlets the level cannot be detected below this point.
- In stilling well applications, the electromagnetic waves do not propagate completely outside the tube. It must be taken into account that the accuracy may be reduced in the area **C**. In order to guarantee the required accuracy in these cases, it is recommended to position the zero-point at a distance **C** above the end of the tube (see figure).
- In case of media with a low dielectric constant ($\epsilon_r = 1.5$ to 4)³⁾ the tank bottom can be visible through the medium at low levels (low height **C**). Reduced accuracy has to be expected in this range. If this is not acceptable, we recommend positioning the zero point at a distance **C** (see figure) above the tank bottom in these applications.
- In principle it is possible to measure up to the tip of the antenna with FMR51, FMR53 and FMR54. However, due to considerations regarding corrosion and build-up, the end of the measuring range should not be chosen any closer than **A** (see figure) to the tip of the antenna.
- When using FMR54 with planar antenna, especially for media with low dielectric constants, the end of the measuring range should not be closer than **A: 1 m (3.28 ft)** to the flange.
- The smallest possible measuring range **B** depends on the antenna version (see figure).
- The tank height should be at least **H** (see table).

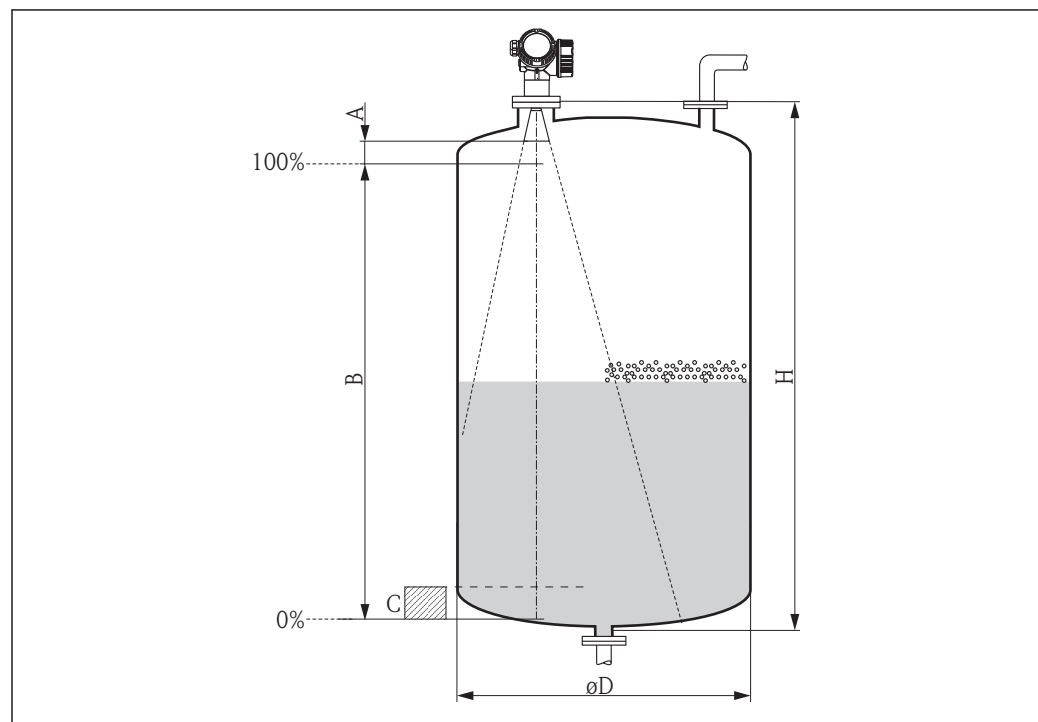

A0018872

2) Affected compounds are e.g. R134a, R227, Dymel 152a.

3) Dielectric constants of important media commonly used in various industries are summarized in the DC manual (CP01076F) and in the Endress+Hauser "DC Values App" (available for Android and iOS).

Device	A [mm (in)]	B [m (ft)]	C [mm (in)]	H [m (ft)]
FMR50	150 (5.91)	> 0.2 (0.7)	50 to 250 (1.97 to 9.84)	> 0.3 (1.0)

6.3 Installation in vessel (free space)

6.3.1 Horn antenna encapsulated (FMR50)

Alignment

- Align the antenna vertically to the product surface.
- A marking at the threaded connection enables alignment of the antenna. This marking must be aligned towards the tank wall as well as possible.

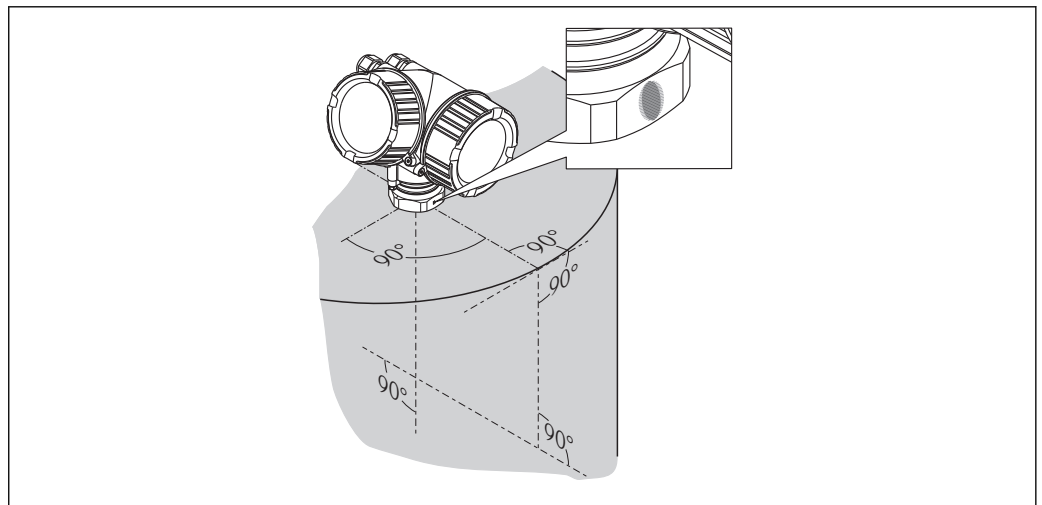

A0019434

- i** Depending on the device version the marking may be a circle or two short parallel lines.

Nozzle mounting

For optimum measurement, the tip of the antenna should extend below the nozzle. This is achieved by a nozzle height up to $H_{max} = 60 \text{ mm (2.36 in)}$.

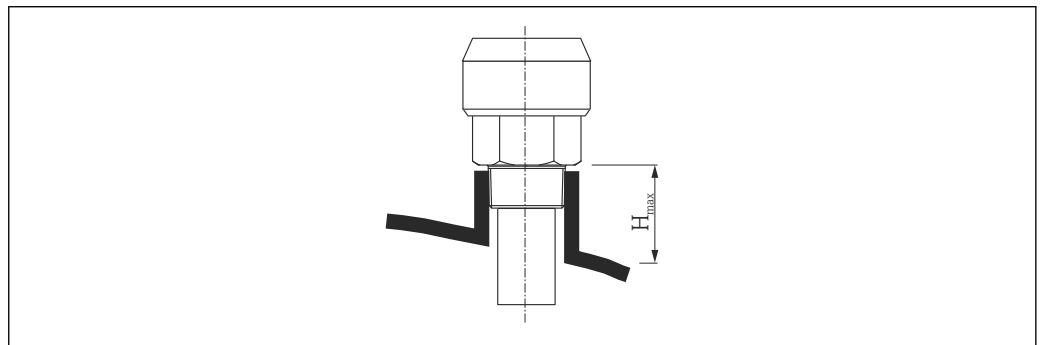

A0016806

- 5** Nozzle height for horn antenna, encapsulated (FMR50); $H_{max} = 60 \text{ mm (2.36 in)}$

Conditions for longer nozzles

If the medium has good reflective properties, higher nozzles can be accepted. In this case the maximum nozzle height, H_{max} , is dependent on the nozzle diameter, D :

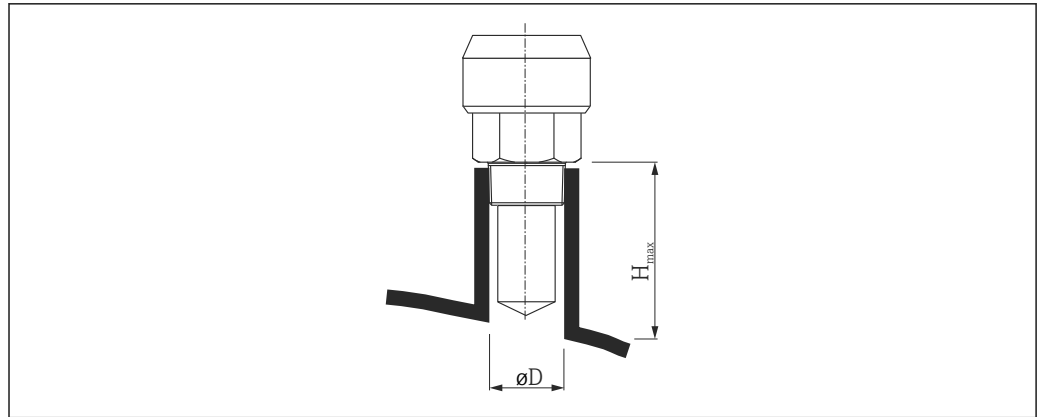

A0023612

Nozzle diameter D	Maximum nozzle height H_{max}
40 mm (1.5 in)	200 mm (7.9 in)
50 mm (2 in)	250 mm (9.9 in)
80 mm (3 in)	300 mm (11.8 in)
100 mm (4 in)	400 mm (15.8 in)
150 mm (6 in)	500 mm (19.7 in)

- i** If the antenna doesn't extend below the nozzle, observe the following:
- The nozzle end must be smooth and free of burrs. If possible its edge should be rounded.
 - An interference echo suppression must be performed.
 - Please contact Endress+Hauser for applications with higher nozzles than those indicated in the table.

Threaded connection

- Tighten with the hexagonal nut only.
- Tool : 50 mm hexagonal wrench
- Maximum permissible torque: 35 Nm (26 lbf ft)

6.3.2 Horn antenna with slip-on flange (FMR50)

Alignment

- i** When using the Micropilot with a slip-on flange in explosion-hazardous areas, strictly observe all specifications in the relevant Safety Instructions (XA).
- Align the antenna vertically to the product surface.
Optionally, a variable flange seal, which is available as an accessory, can be used for alignment (see Technical Information BA01048F, chapter "Accessories").
 - A marking at the feedthrough enables alignment of the antenna. This marking must be aligned towards the tank wall as well as possible.

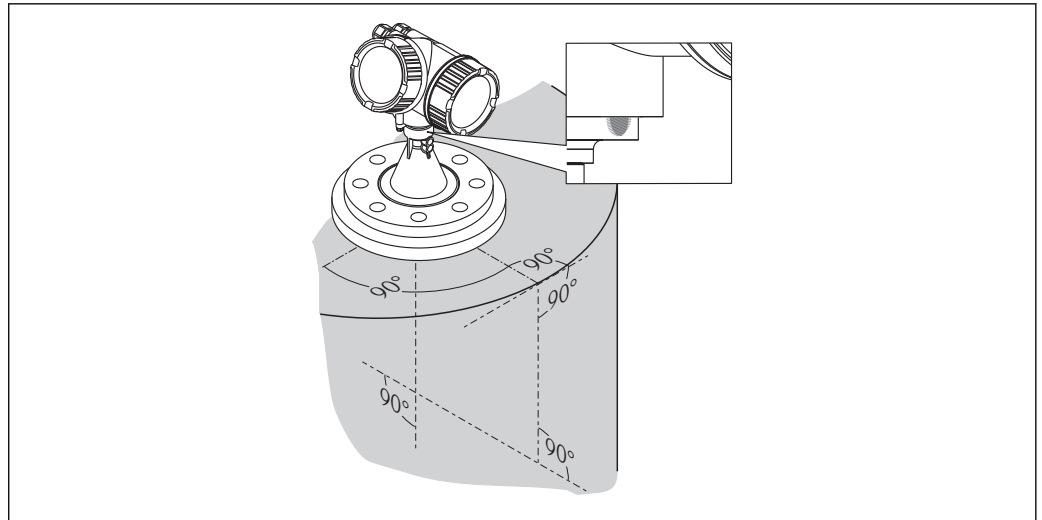

A0019439

i Depending on the device version the marking may be a circle or two short parallel lines.

Nozzle mounting

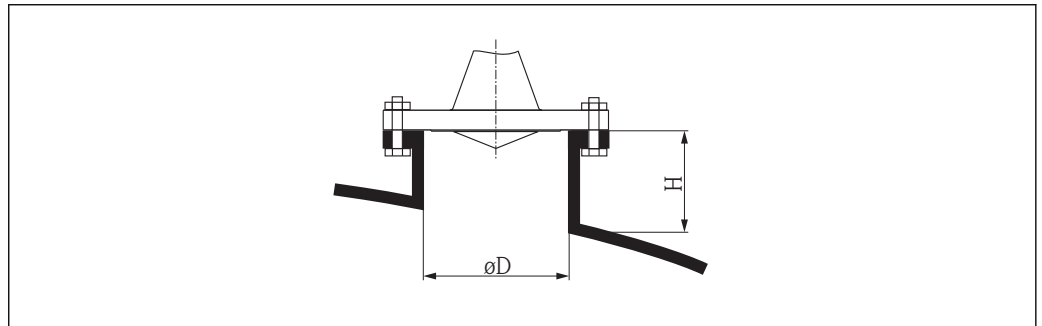

A0016868

6 Nozzle height and diameter for horn antenna with slip-on flange

Nozzle diameter D	Maximum nozzle height H_{max}
80 mm (3 in)	300 mm (11.8 in)
100 mm (4 in)	400 mm (15.8 in)
150 mm (6 in)	500 mm (19.7 in)

6.3.3 Horn antenna with mounting bracket (FMR50)

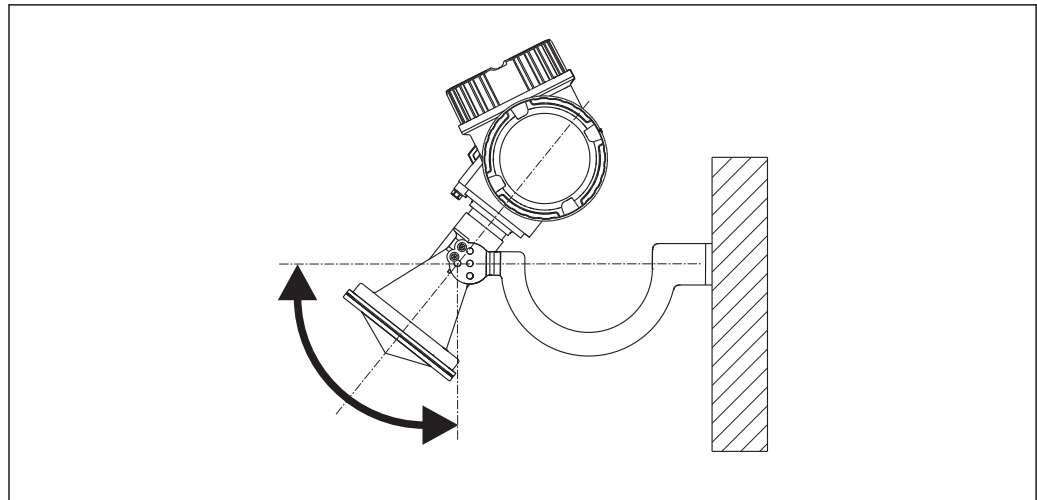

7 Installation of the horn antenna with mounting bracket

Align the antenna vertically to the product surface using the mounting bracket.

NOTICE

The mounting bracket has no conductive connection to the transmitter housing.

Danger of electrostatic charge

- ▶ Connect the mounting bracket to the local potential equalization system.

6.3.4 Measurement from the outside through plastic walls (FMR50/FMR51)

- Dielectric constant of the medium: $\epsilon_r > 10$
- If possible, use an antenna 100 mm (4 in).
- The distance from the lower edge of the antenna to the tank ceiling should be about 100 mm (4 in).
- If possible, avoid mounting locations where condensation or build-up might occur.
- In case of outdoor mounting, the space between antenna and vessel has to be protected from the elements.
- Do not mount any potential reflectors (e.g. pipes) outside the tank in the signal beam.

Suitable thickness of the tank ceiling:

Penetrated material	PE	PTFE	PP	Perspex
DK / ϵ_r	2.3	2.1	2.3	3.1
Optimum thickness ¹⁾	3.8 mm (0.15 in)	4.0 mm (0.16 in)	3.8 mm (0.15 in)	3.3 mm (0.13 in)

1) Other possible values for the thickness are multiples of the values listed (e.g. for PE: 7,6 mm (0.3 in), 11,4 mm (0.45 in))

6.4 Installation in stilling well

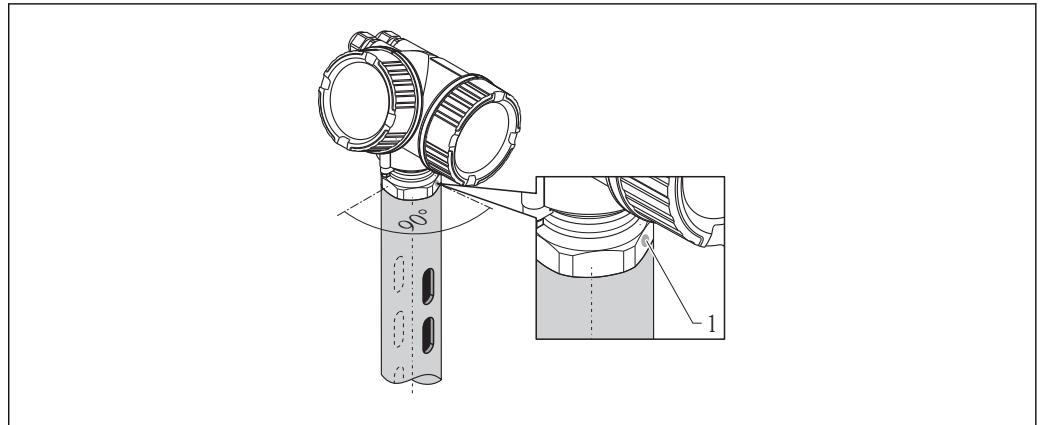

A0016841

8 Installation in stilling well

1 Marking for antenna alignment

- For horn antenna: Align the marking towards the slots of the stilling well.
- Measurements can be performed through an open full bore ball valve without any problems.
- After mounting, the housing can be turned 350° in order to facilitate access to the display and the terminal compartment → 31.

6.4.1 Recommendations for the stilling well

- Metal (no enamel coating; plastic on request).
- Constant diameter.
- Diameter of stilling well not larger than antenna diameter.
- Diameter difference between horn antenna and inner diameter of the stilling well as small as possible.
- Weld seam as smooth as possible and on the same axis as the slots.
- Slots offset 180° (not 90°).
- Slot width or diameter of holes max. 1/10 of pipe diameter, de-burred. Length and number do not have any influence on the measurement.
- Select horn antenna as big as possible. For intermediate sizes (e.g. 180 mm (7 in)) select next larger antenna and adapt it mechanically (for horn antennas)
- At any transition (i.e. when using a ball valve or mending pipe segments), no gap may be left exceeding 1 mm (0.04 in).
- The stilling well must be smooth on the inside (average roughness $R_z \leq 6.3 \mu\text{m}$ (248 μin)). Use extruded or parallel welded metal pipe. An extension of the pipe is possible with welded flanges or pipe sleeves. Flange and pipe have to be properly aligned at the inside.
- Do not weld through the pipe wall. The inside of the stilling well must remain smooth. In case of unintentional welding through the pipe, the weld seam and any unevenness on the inside need to be carefully removed and smoothed. Otherwise, strong interference echoes will be generated and material build-up will be promoted.
- In the case of smaller nominal widths flanges must be welded to the pipe such that they allow for a correct orientation (marker aligned toward slots).

6.4.2 Examples for the construction of stilling wells

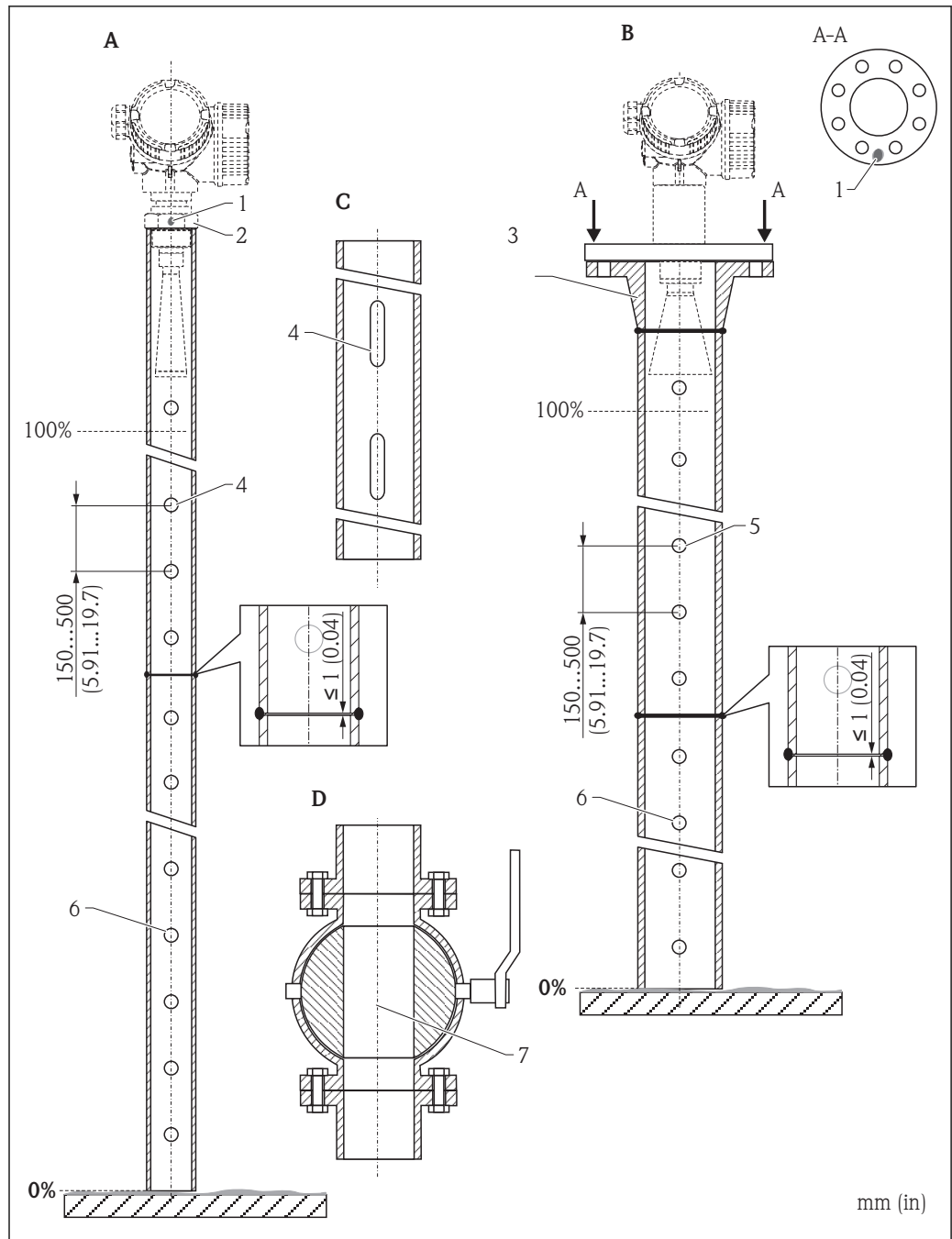

A0019009

- A Micropilot FMR50/FMR51: Horn 40mm(1½")
- B Micropilot FMR50/FMR51/FMR52/FMR54: Horn 80mm(3")
- C Stilling well with slots
- D Full bore ball valve
- 1 Marking for axial alignment
- 2 Threaded connection
- 3 e.g. welding neck flange DIN2633
- 4 ϕ hole max. 1/10 ϕ stilling well
- 5 ϕ hole max. 1/10 ϕ stilling well; single sided or drilled through
- 6 Inside of holes deburred
- 7 Diameter of opening of ball valve must always be equivalent to pipe diameter; avoid edges and constrictions.

6.5 Installation in bypass

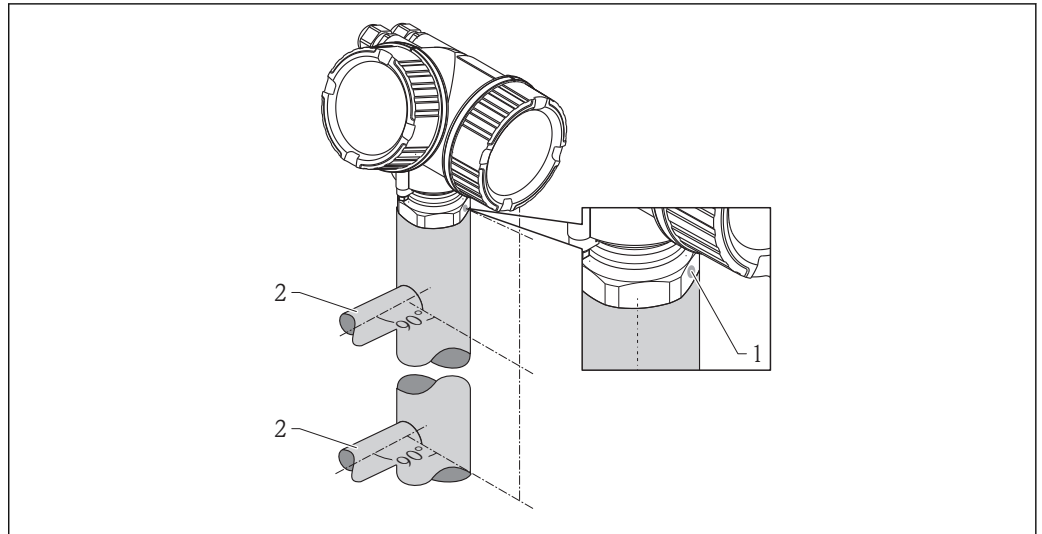

A0019446

9 Installation in bypass

- 1 Marking for antenna alignment
2 Tank connectors

- Align the marker perpendicular (90°) to the tank connectors.
- Measurements can be performed through an open full bore ball valve without any problems.
- After mounting, the housing can be turned 350° in order to facilitate access to the display and the terminal compartment → 31.

6.5.1 Recommendations for the bypass pipe

- Metal (no plastic or enamel coating).
- Constant diameter.
- Select horn antenna as big as possible. For intermediate sizes (e.g. 95 mm (3.5 in)) select next larger antenna and adapt it mechanically (for horn antennas).
- Diameter difference between horn antenna and inner diameter of the bypass as small as possible.
- At any transition (i.e. when using a ball valve or mending pipe segments), no gap may be created exceeding 1 mm (0.04 in).
- In the area of the tank connections (~ ±20 cm (7.87 in)) a reduced accuracy of the measurement has to be expected.

6.5.2 Example for the construction of a bypass

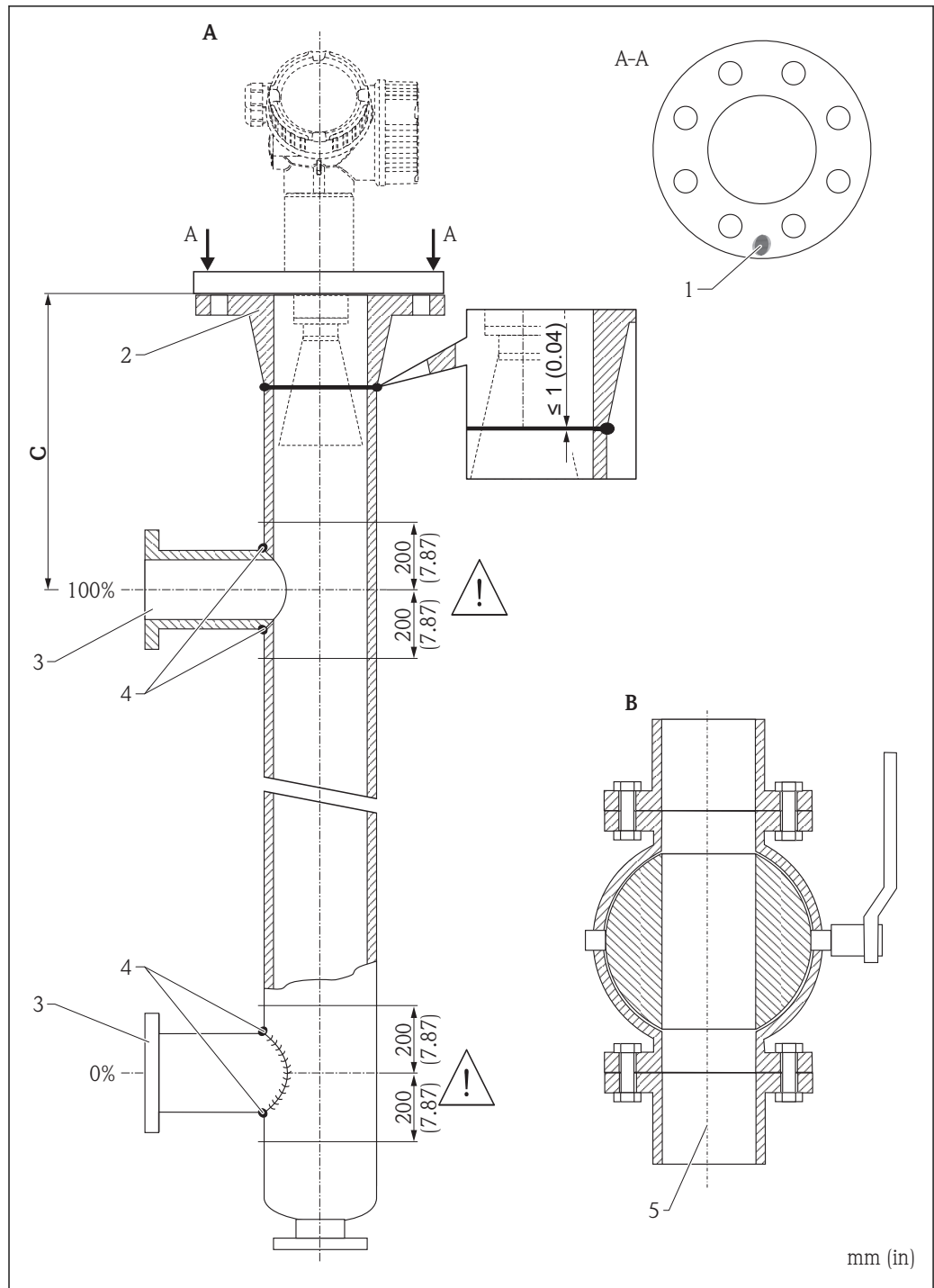

- A Micropilot FMR50/FMR51/FMR52/FMR54: Horn 80mm(3")
- B Full bore ball valve
- C Minimum distance to upper connection pipe: 400 mm (15,7 in)
- 1 Marking for axial alignment
- 2 e.g. welding neck flange DIN2633
- 3 Diameter of the connection pipes as small as possible
- 4 Do not weld through the pipe wall; the inside of the bypass must remain smooth.
- 5 Diameter of opening of ball valve must always be equivalent to pipe diameter. Avoid edges and constrictions.

6.6 Vessels with heat insulation

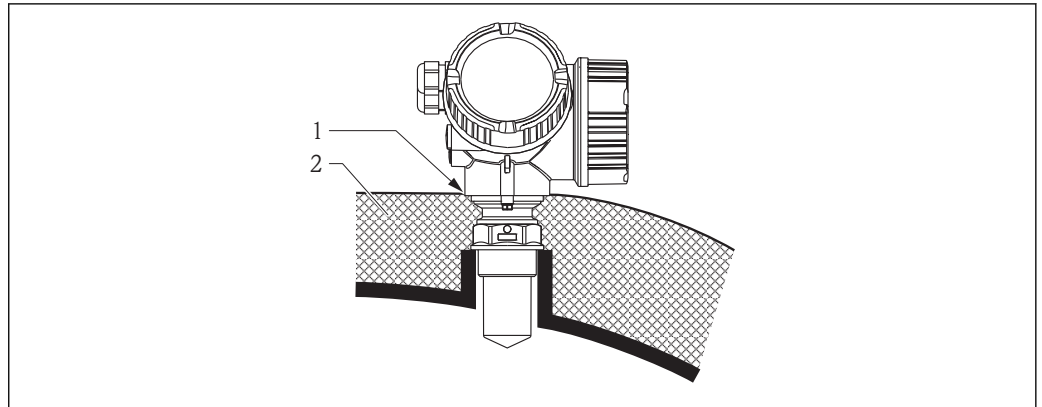

A0019141

If process temperatures are high, the device must be included in normal tank insulation to prevent the electronics heating up as a result of heat radiation or convection. The insulation may not exceed beyond the neck of the housing.

6.7 Turning the transmitter housing

To provide easier access to the connection compartment or display module, the transmitter housing can be turned:

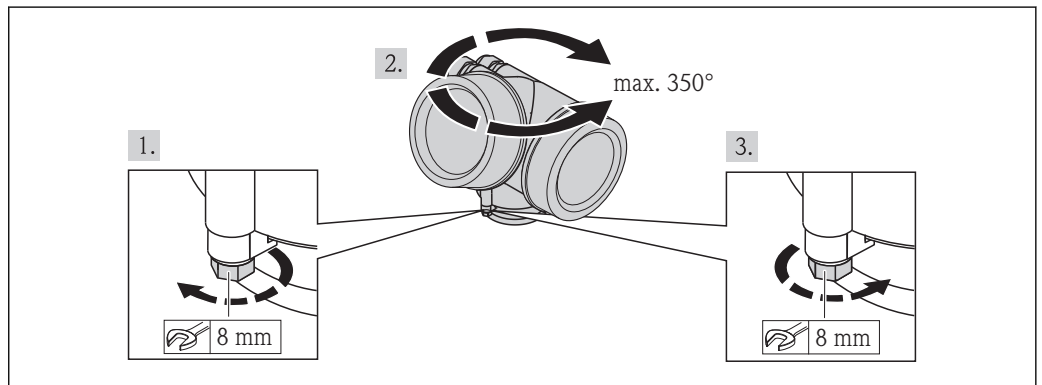

A0013713

1. Unscrew the securing screw using an open-ended wrench.
2. Rotate the housing in the desired direction.
3. Tighten the securing screw (1,5 Nm for plastics housing; 2,5 Nm for aluminium or stainless steel housing).

6.8 Turning the display module

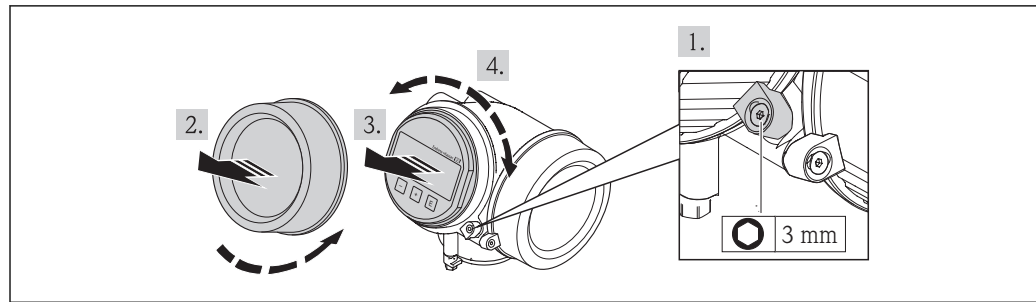

A0013905

1. If present: Loosen the screw of the securing clamp of the electronics compartment cover using an Allen key and turn the clamp 90° counterclockwise.
2. Unscrew cover of the electronics compartment from the transmitter housing.
3. Pull out the display module with a gentle rotation movement.
4. Rotate the display module into the desired position: Max. $8 \times 45^\circ$ in each direction.
5. Feed the spiral cable into the gap between the housing and main electronics module and plug the display module into the electronics compartment until it engages.
6. Screw the cover of the electronics compartment firmly back onto the transmitter housing.
7. Tighten the securing clamp again using the Allen key (Torque: 2.5 Nm).

6.9 Post-installation check

<input type="checkbox"/>	Is the device undamaged (visual inspection)?
<input type="checkbox"/>	Does the device conform to the measuring point specifications? For example: <ul style="list-style-type: none"> ▪ Process temperature ▪ Process pressure (refer to the chapter on "Material load curves" of the "Technical Information" document) ▪ Ambient temperature range ▪ Measuring range
<input type="checkbox"/>	Are the measuring point identification and labeling correct (visual inspection)?
<input type="checkbox"/>	Is the device adequately protected from precipitation and direct sunlight?
<input type="checkbox"/>	Are the securing screw and securing clamp tightened securely?

7 Electrical connection

7.1 Connection conditions

7.1.1 Terminal assignment

2-wire: 4-20mA HART

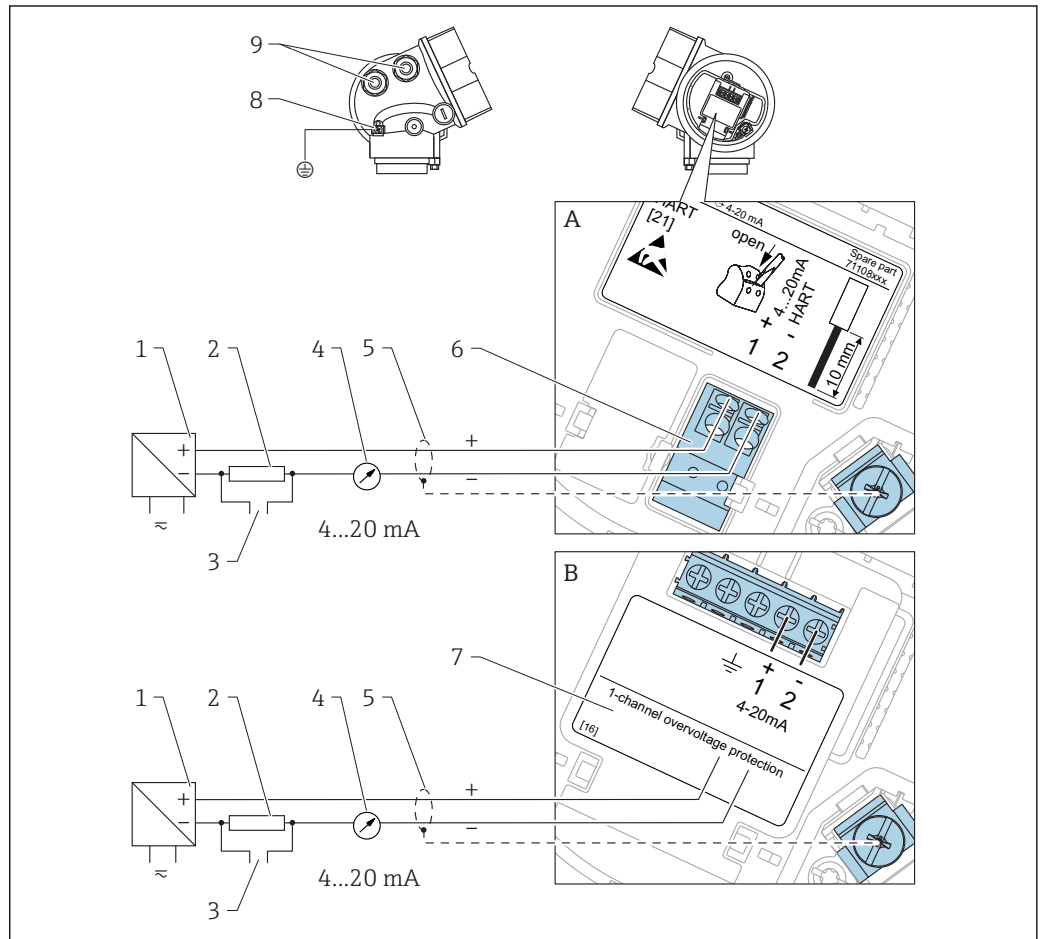

A0011294

10 Terminal assignment 2-wire; 4-20mA HART

A Without integrated overvoltage protection

B With integrated overvoltage protection

1 Active barrier with power supply (e.g. RN221N): Observe terminal voltage

2 HART communication resistor ($\geq 250 \Omega$): Observe maximum load

3 Connection for Commubox FXA195 or FieldXpert SFX350/SFX370 (via VIATOR Bluetooth modem)

4 Analog display device: Observe maximum load

5 Cable screen; observe cable specification

6 4-20mA HART (passive): Terminals 1 and 2

7 Overvoltage protection module

8 Terminal for potential equalization line

9 Cable entry

2-wire: 4-20mA HART, switch output

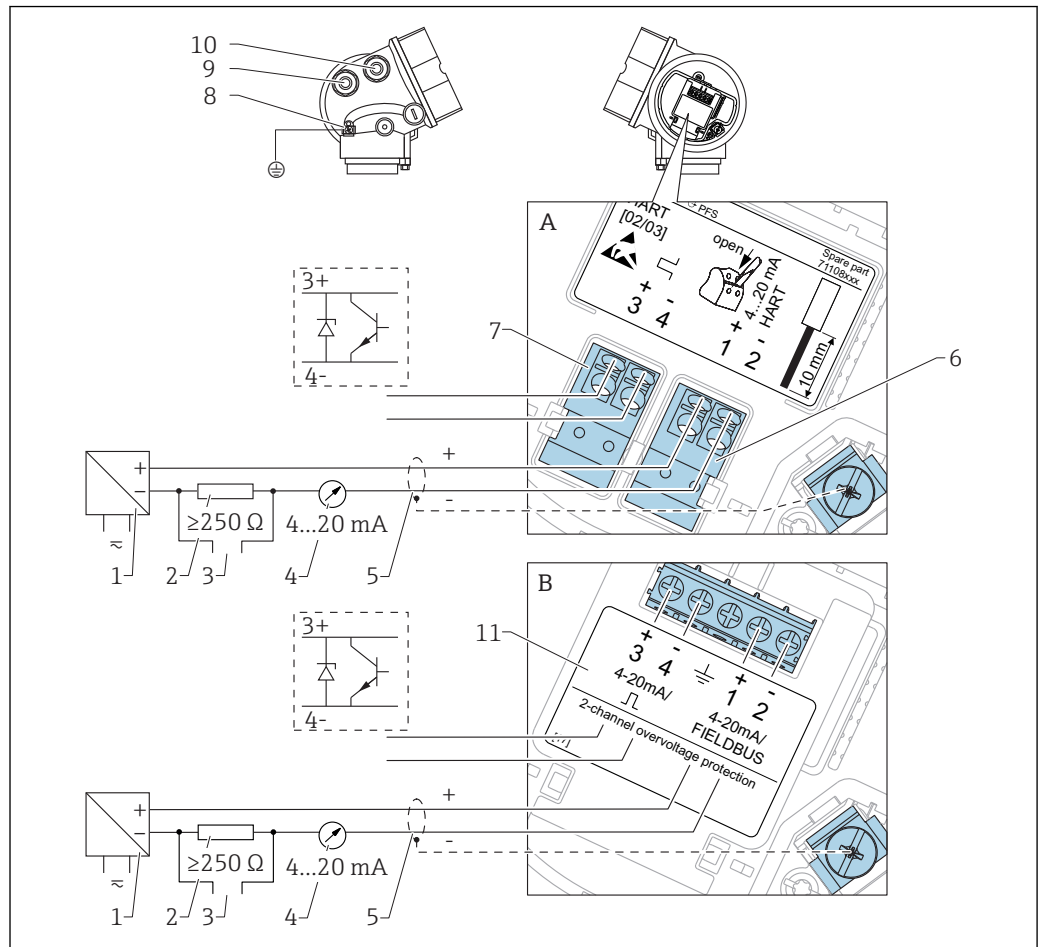

A0013759

11 Terminal assignment 2-wire; 4-20mA HART, switch output

- A Without integrated overvoltage protection
- B With integrated overvoltage protection
- 1 Active barrier with power supply (e.g. RN221N): Observe terminal voltage
- 2 HART communication resistor ($\geq 250 \Omega$): Observe maximum load
- 3 Connection for Commubox FXA195 or FieldXpert SFX350/SFX370 (via VIATOR Bluetooth modem)
- 4 Analog display device: Observe maximum load
- 5 Cable screen; observe cable specification
- 6 4-20mA HART (passive): Terminals 1 and 2
- 7 Switch output (open collector): Terminals 3 and 4
- 8 Terminal for potential equalization line
- 9 Cable entry for 4-20mA HART line
- 10 Cable entry for switch output line
- 11 Overvoltage protection module

2-wire: 4-20mA HART, 4-20mA

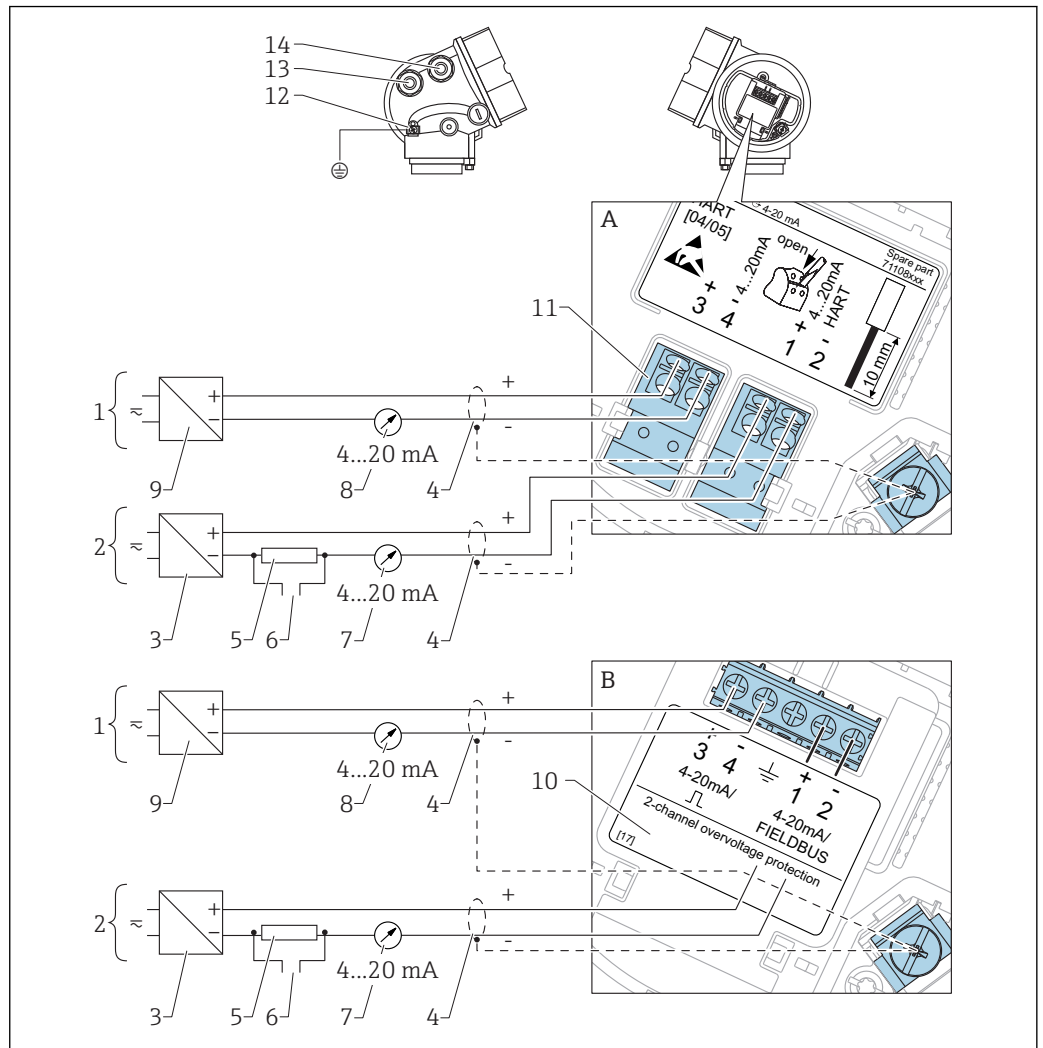

A0013923

12 Terminal assignment 2-wire, 4-20 mA HART, 4...20mA

A Without integrated overvoltage protection

B With integrated overvoltage protection

1 Connection current output 2

2 Connection current output 1

3 Supply voltage for current output 1 (e.g. RN221N); Observe terminal voltage

4 Cable screen; observe cable specification

5 HART communication resistor ($\geq 250 \Omega$); Observe maximum load

6 Connection for Commubox FXA195 or FieldXpert SFX350/SFX370 (via VIATOR Bluetooth modem)

7 Analog display device ; observe maximum load

8 Analog display device ; observe maximum load

9 Supply voltage for current output 2 (e.g. RN221N); Observe terminal voltage

10 Overvoltage protection module

11 Current output 2: Terminals 3 and 4

12 Terminal for the potential equalization line

13 Cable entry for current output 1

14 Cable entry for current output 2

i This version is also suited for single-channel operation. In this case, current output 1 (terminals 1 and 2) must be used.

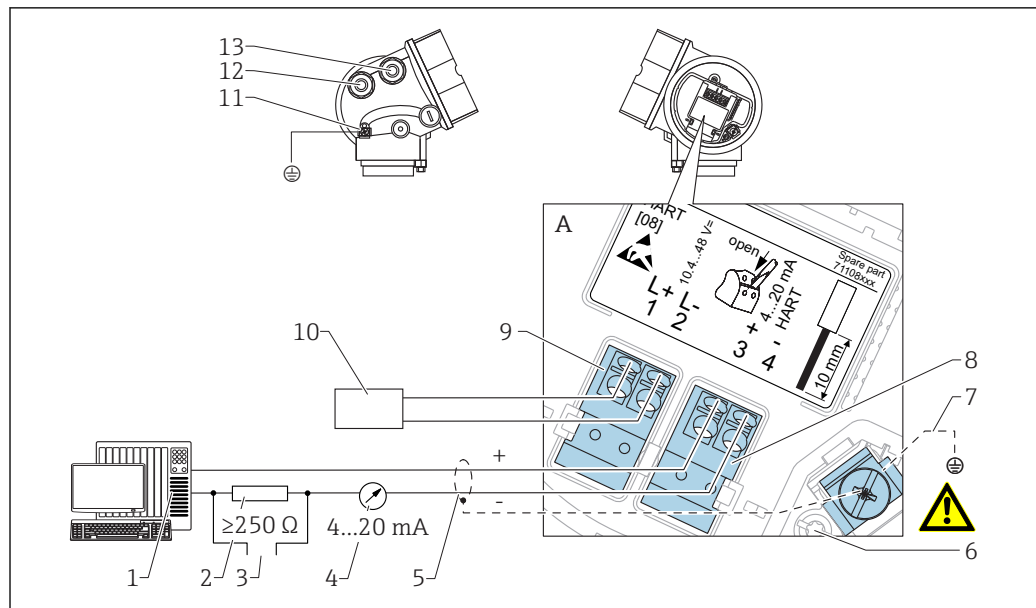
4-wire: 4-20mA HART (10.4 to 48 V_{DC})

A0011340

13 Terminal assignment 4-wire; 4-20mA HART (10.4 to 48 V_{DC})

- 1 Evaluation unit, e.g. PLC
- 2 HART communication resistor ($\geq 250 \Omega$): Observe maximum load
- 3 Connection for Commubox FXA195 or FieldXpert SFX350/SFX370 (via VIATOR Bluetooth modem)
- 4 Analog display device: Observe maximum load
- 5 Signal cable including screening (if required), observe cable specification
- 6 Protective connection; do not disconnect!
- 7 Protective earth, observe cable specification
- 8 4...20mA HART (active): Terminals 3 and 4
- 9 Supply voltage: Terminals 1 and 2
- 10 Supply voltage: Observe terminal voltage, observe cable specification
- 11 Terminal for potential equalization
- 12 Cable entry for signal line
- 13 Cable entry for power supply

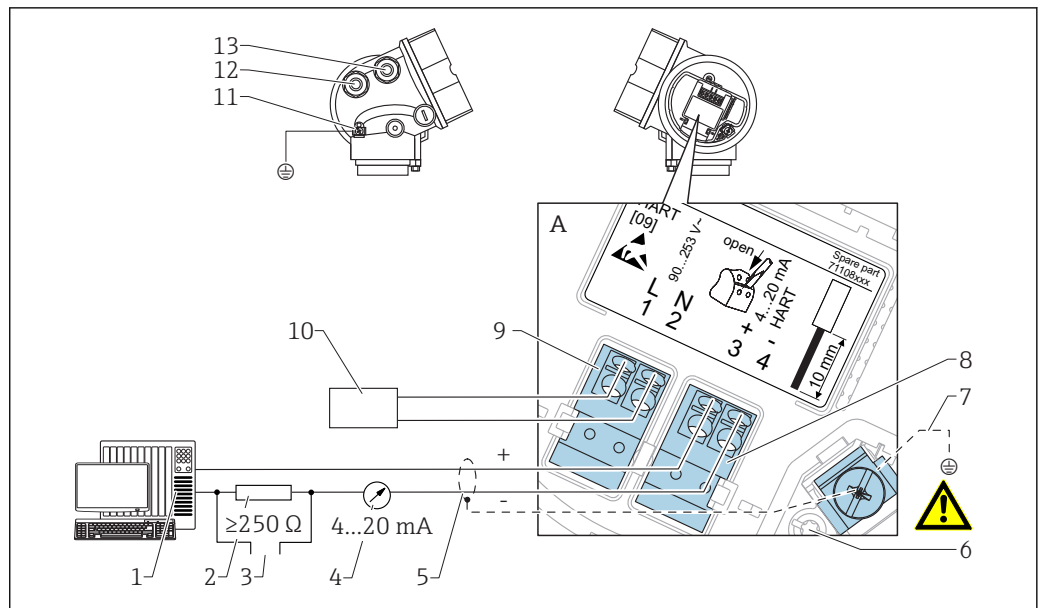
4-wire: 4-20mA HART (90 to 253 V_{AC})

14 Terminal assignment 4-wire; 4-20mA HART (90 to 253 V_{AC})

- 1 Evaluation unit, e.g. PLC
- 2 HART communication resistor ($\geq 250 \Omega$): Observe maximum load
- 3 Connection for Commubox FXA195 or FieldXpert SFX350/SFX370 (via VIATOR Bluetooth modem)
- 4 Analog display device: Observe maximum load
- 5 Signal cable including screening (if required), observe cable specification
- 6 Protective connection; do not disconnect!
- 7 Protective earth, observe cable specification
- 8 4...20mA HART (active): Terminals 3 and 4
- 9 Supply voltage: Terminals 1 and 2
- 10 Supply voltage: Observe terminal voltage, observe cable specification
- 11 Terminal for potential equalization
- 12 Cable entry for signal line
- 13 Cable entry for power supply

CAUTION

To ensure electrical safety:

- ▶ Do not disconnect the protective connection (6).
- ▶ Disconnect the supply voltage before disconnecting the protective earth (7).

- i** Connect protective earth to the internal ground terminal (7) before connecting the supply voltage. If necessary, connect the potential matching line to the external ground terminal (11).
- i** In order to ensure electromagnetic compatibility (EMC): Do not only ground the device via the protective earth conductor of the supply cable. Instead, the functional grounding must also be connected to the process connection (flange or threaded connection) or to the external ground terminal.
- i** An easily accessible power switch must be installed in the proximity of the device. The power switch must be marked as a disconnecter for the device (IEC/EN61010).

Connection examples for the switch output

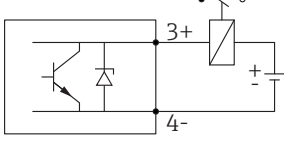
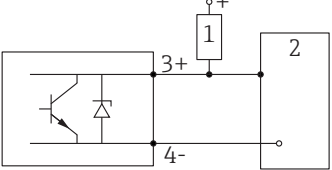
 <p>15 Connection of a relay</p> <p>Suitable relays (examples):</p> <ul style="list-style-type: none"> ▪ Solid-state relay: Phoenix Contact OV-24DC/480AC/5 with mounting rail connector UMK-1 OM-R/AMS ▪ Electromechanical relay: Phoenix Contact PLC-RSC-12DC/21 	 <p>16 Connection of a digital input</p> <p>1 Pull-up resistor 2 Digital input</p>
--	--

i For optimum interference immunity we recommend to connect an external resistor (internal resistance of the relay or Pull-up resistor) of $< 1\ 000\ \Omega$.

7.1.2 Cable specification

▪ Devices without integrated overvoltage protection

Pluggable spring-force terminals for wire cross-sections 0.5 to $2.5\ \text{mm}^2$ (20 to 14 AWG)

▪ Devices with integrated overvoltage protection

Screw terminals for wire cross-sections 0.2 to $2.5\ \text{mm}^2$ (24 to 14 AWG)

- For ambient temperature $T_U \geq 60\ ^\circ\text{C}$ ($140\ ^\circ\text{F}$): use cable for temperature $T_U + 20\ \text{K}$.

HART

- A normal device cable suffices if only the analog signal is used.
- A shielded cable is recommended if using the HART protocol. Observe grounding concept of the plant.
- For 4-wire devices: Standard device cable is sufficient for the power line.

7.1.3 Device plug connectors

i For the versions with fieldbus plug connector (M12 or 7/8"), the signal line can be connected without opening the housing.

Pin assignment of the M12 plug connector

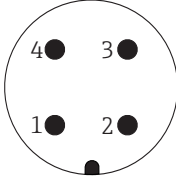
 <p style="text-align: right; font-size: small;">A0011175</p>	Pin	Meaning
	1	Signal +
	2	not connected
	3	Signal -
	4	Ground

Pin assignment of the 7/8" plug connector

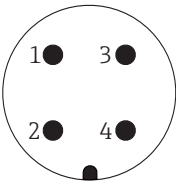
 <p style="text-align: right; font-size: small;">A0011176</p>	Pin	Meaning
	1	Signal -
	2	Signal +
	3	Not connected
	4	Screen

7.1.4 Supply voltage

2-wire, 4-20mA HART, passive

"Power Supply, Output" ¹⁾	"Approval" ²⁾	Terminal voltage U at the device	Maximum load R, depending on the supply voltage U ₀ at the supply unit
A: 2-wire; 4-20mA HART	<ul style="list-style-type: none"> ■ Non-Ex ■ Ex nA ■ Ex ic ■ CSA GP 	10.4 to 35 V ³⁾	<p style="text-align: right; font-size: small;">A0017140</p>
	Ex ia / IS	10.4 to 30 V ³⁾	
	<ul style="list-style-type: none"> ■ Ex d(ia) / XP ■ Ex ic(ia) ■ Ex nA(ia) ■ Ex ta / DIP 	12 to 35 V ⁴⁾	<p style="text-align: right; font-size: small;">A0019136</p>
	Ex ia + Ex d(ia) / IS + XP	12 to 30 V ⁴⁾	

- 1) Feature 020 of the product structure
- 2) Feature 010 of the product structure
- 3) For ambient temperatures $T_a \leq -20\text{ °C}$ (-4 °F) a minimum voltage of 15 V is required for the startup of the device at the MIN error current (3,6 mA). The startup current can be parametrized. If the device is operated with a fixed current $I \geq 5,5\text{ mA}$ (HART multidrop mode), a voltage of $U \geq 10,4\text{ V}$ is sufficient throughout the entire range of ambient temperatures.
- 4) For ambient temperatures $T_a \leq -20\text{ °C}$ (-4 °F) a minimum voltage of 16 V is required for the startup of the device at the MIN error current (3.6 mA).

"Power Supply, Output" ¹⁾	"Approval" ²⁾	Terminal voltage U at the device	Maximum load R, depending on the supply voltage U ₀ at the supply unit
B: 2-wire; 4-20 mA HART, switch output	<ul style="list-style-type: none"> ■ Non-Ex ■ Ex nA ■ Ex nA(ia) ■ Ex ic ■ Ex ic(ia) ■ Ex d(ia) / XP ■ Ex ta / DIP ■ CSA GP 	12 to 35 V ³⁾	<p style="text-align: right; font-size: small;">A0019136</p>
	<ul style="list-style-type: none"> ■ Ex ia / IS ■ Ex ia + Ex d(ia) / IS + XP 	12 to 30 V ³⁾	

- 1) Feature 020 of the product structure
- 2) Feature 010 of the product structure
- 3) For ambient temperatures $T_a \leq -30\text{ °C}$ (-22 °F) a minimum voltage of 16 V is required for the startup of the device at the MIN error current (3.6 mA).

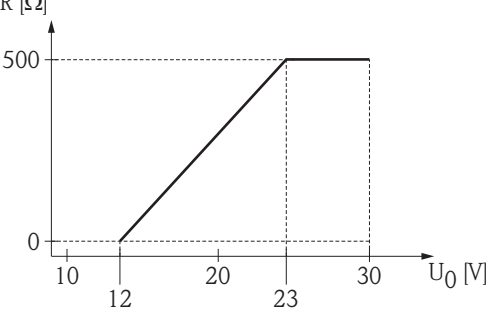
"Power Supply, Output" ¹⁾	"Approval" ²⁾	Terminal voltage U at the device	Maximum load R, depending on the supply voltage U ₀ at the supply unit
C: 2-wire; 4-20mA HART, 4-20mA	any	12 to 30 V ³⁾	 <p>The graph plots Maximum load R [Ω] on the y-axis (0 to 500) against supply voltage U₀ [V] on the x-axis (10 to 30). The load is 0 Ω for U₀ < 12 V. It increases linearly from 0 Ω at 12 V to 500 Ω at 23 V. It remains constant at 500 Ω for U₀ between 23 V and 30 V.</p>

- 1) Feature 020 of the product structure
- 2) Feature 010 of the product structure
- 3) For ambient temperatures T_a ≤ -30 °C (-22 °F) a minimum voltage of 16 V is required for the startup of the device at the MIN error current (3.6 mA).

Polarity reversal protection	Yes
Admissible residual ripple at f = 0 to 100 Hz	U _{SS} < 1 V
Admissible residual ripple at f = 100 to 10000 Hz	U _{SS} < 10 mV

4-wire, 4-20mA HART, active

"Power supply; Output" ¹⁾	Terminal voltage	Maximum load R_{\max}
K: 4-wire 90-253VAC; 4-20mA HART	90 to 253 V _{AC} (50 to 60 Hz), overvoltage category II	500 Ω
L: 4-wire 10,4-48VDC; 4-20mA HART	10.4 to 48 V _{DC}	

1) Feature 020 of the product structure

7.1.5 Overvoltage protection

If the measuring device is used for level measurement in flammable liquids which requires the use of overvoltage protection according to DIN EN 60079-14, standard for test procedures 60060-1 (10 kA, pulse 8/20 μ s), overvoltage protection has to be ensured by an integrated or external overvoltage protection module.

Integrated overvoltage protection

An integrated overvoltage protection module is available for 2-wire HART as well as PROFIBUS PA and FOUNDATION Fieldbus devices.

Product structure: Feature 610 "Accessory mounted", option NA "Overvoltage protection".

Technical data	
Resistance per channel	2 \times 0.5 Ω max.
Threshold DC voltage	400 to 700 V
Threshold impulse voltage	< 800 V
Capacitance at 1 MHz	< 1.5 pF
Nominal arrest impulse voltage (8/20 μ s)	10 kA

External overvoltage protection

HAW562 or HAW569 from Endress+Hauser are suited as external overvoltage protection.



For detailed information please refer to the following documents:

- HAW562: TI01012K
- HAW569: TI01013K

7.2 Connecting the device**⚠ WARNING****Explosion hazard!**

- ▶ Comply with the relevant national standards.
- ▶ Observe the specifications in the Safety Instructions (XA).
- ▶ Only use the specified cable glands.
- ▶ Check whether the supply voltage matches the specifications on the nameplate.
- ▶ Before connecting the device: Switch the supply voltage off.
- ▶ Before switching on the supply voltage: Connect the potential bonding line to the exterior ground terminal.

Required tools and accessories:

- For instruments with safety pin for the lid: AF 3 Allen key
- Wire stripping pliers
- When using stranded wires: Wire end sleeves.

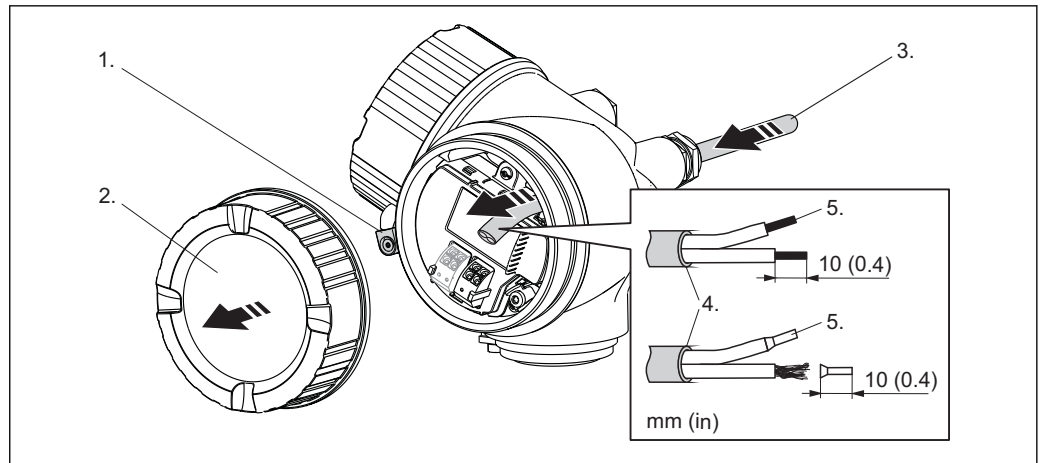

A0012619

1. Loosen the screw of the securing clamp of the connection compartment cover and turn the clamp 90° counterclockwise.
2. Unscrew the connection compartment cover.
3. Push the cable through the cable entry. To ensure tight sealing, do not remove the sealing ring from the cable entry.
4. Strip the cable.
5. Strip the cable ends 10 mm (0.4 in). For stranded cables, also attach wire end ferrules.
6. Firmly tighten the cable glands.
- 7.

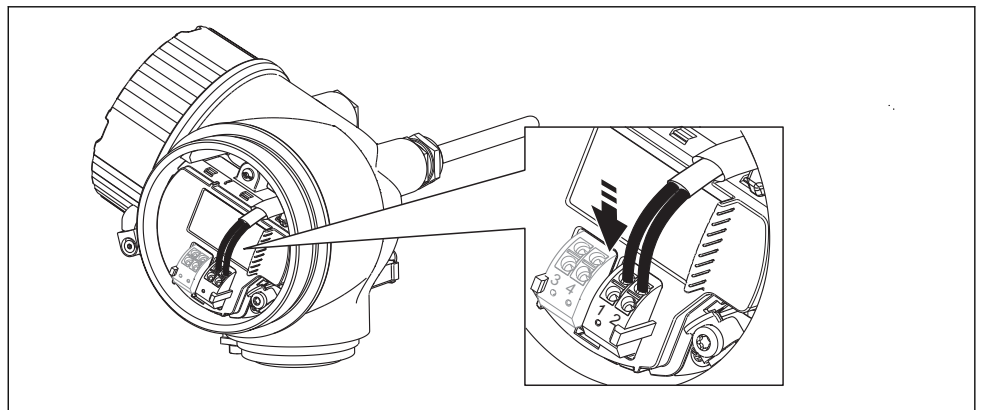

A0013837

Connect the cable in accordance with the terminal assignment → 33.

8. When using screened cable: Connect the cable screen to the ground terminal.
9. Screw the cover onto the connection compartment.
10. For instruments with safety pin for the lid: Adjust the safety pin so that its edge is over the edge of the display lid. Tighten the safety pin.

7.2.1 Pluggable spring-force terminals

Instruments without integrated overvoltage protection have pluggable spring-force terminals. Rigid conductors or flexible conductors with cable sleeve can directly be inserted and are contacted automatically.

To remove cables from the terminal: Press on the groove between the terminals using a flat-tip screwdriver ≤ 3 mm (0.12 inch) while pulling the cables out of the terminals.

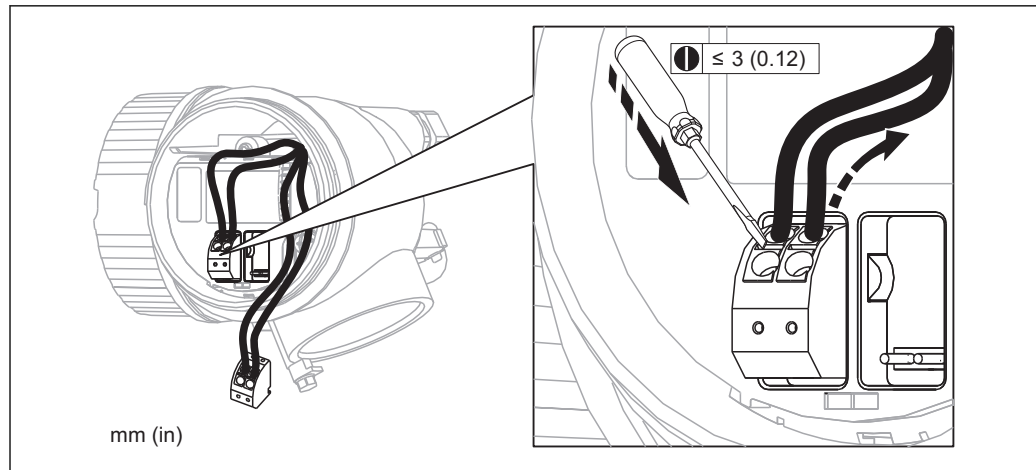

7.3 Post-connection check

<input type="radio"/>	Are cables or the device undamaged (visual inspection)?
<input type="radio"/>	Do the cables comply with the requirements?
<input type="radio"/>	Do the cables have adequate strain relief?
<input type="radio"/>	Are all cable glands installed, firmly tightened and correctly sealed?
<input type="radio"/>	Does the supply voltage match the specifications on the transmitter nameplate?
<input type="radio"/>	Is the terminal assignment correct → 33?
<input type="radio"/>	If required: Is the protective earth connected correctly ?
<input type="radio"/>	If supply voltage is present: Is the device ready for operation and do values appear on the display module?
<input type="radio"/>	Are all housing covers installed and firmly tightened?
<input type="radio"/>	Is the securing clamp tightened correctly?

8 Operation options

8.1 Overview

8.1.1 Local operation

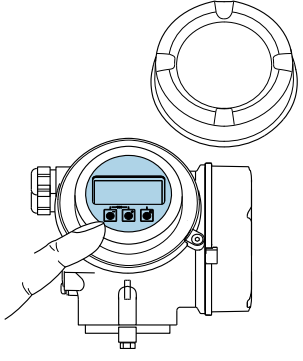
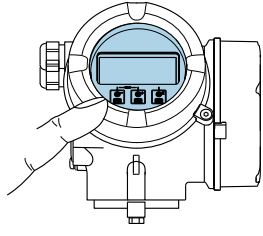
Operation with	Pushbuttons	Touch Control
Order code for "Display; Operation"	Option C "SD02"	Option E "SD"
		
Display elements	4-line display	4-line display white background lighting; switches to red in event of device error
	Format for displaying measured variables and status variables can be individually configured	
	Permitted ambient temperature for the display: -20 to +70 °C (-4 to +158 °F) The readability of the display may be impaired at temperatures outside the temperature range.	
Operating elements	local operation with 3 push buttons (⊕, ⊖, ⊞)	external operation via touch control; 3 optical keys: ⊕, ⊖, ⊞
	Operating elements also accessible in various hazardous areas	
Additional functionality	Data backup function The device configuration can be saved in the display module.	
	Data comparison function The device configuration saved in the display module can be compared to the current device configuration.	
	Data transfer function The transmitter configuration can be transmitted to another device using the display module.	

8.1.2 Operation with remote display and operating module FHX50

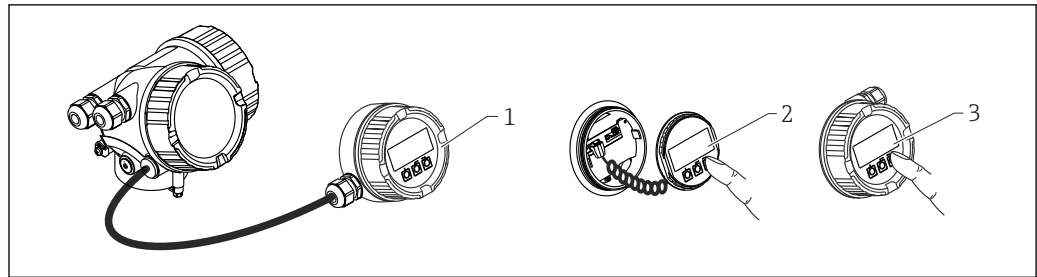

A0013137

17 FHX50 operating options

- 1 Housing of the remote display and operating module FHX50
- 2 Display and operating module SD02, push buttons; cover must be removed
- 3 Display and operating module SD03, optical keys; can be operated through the glass of the cover

8.1.3 Remote operation

Via HART protocol

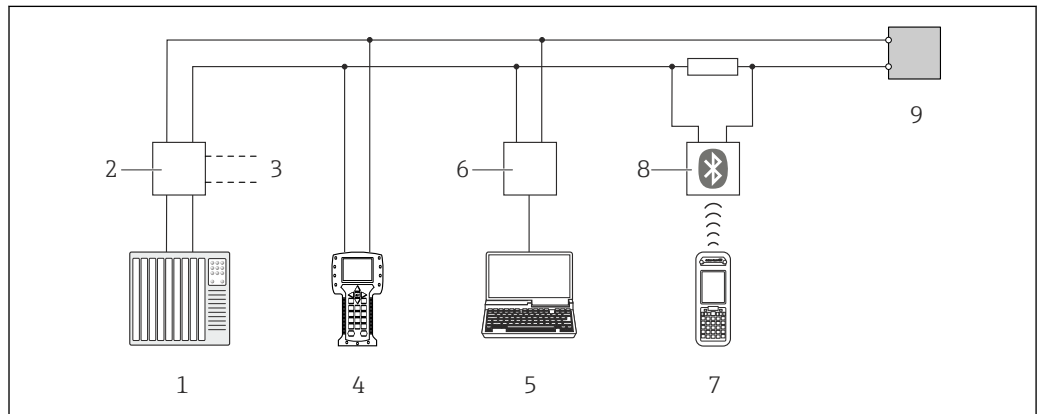

A0013764

18 Options for remote operation via HART protocol

- 1 PLC (programmable logic controller)
- 2 Transmitter power supply unit, e.g. RN221N (with communication resistor)
- 3 Connection for Commubox FXA191, FXA195 and Field Communicator 375, 475
- 4 Field Communicator 475
- 5 Computer with operating tool (e.g. FieldCare, AMS Device Manager, SIMATIC PDM)
- 6 Commubox FXA191 (RS232) or FXA195 (USB)
- 7 Field Xpert SFX350/SFX370
- 8 VIATOR Bluetooth modem with connecting cable
- 9 Transmitter

Via service interface (CDI)

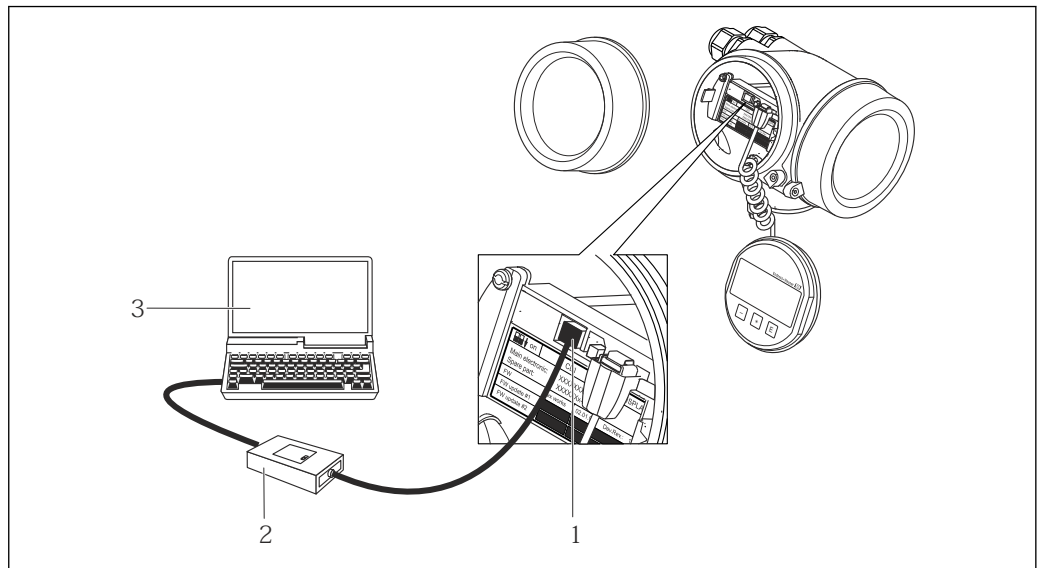

A0014019

- 1 Service interface (CDI) of the measuring device (= Endress+Hauser Common Data Interface)
- 2 Commubox FXA291
- 3 Computer with "FieldCare" operating tool

8.2 Structure and function of the operating menu

8.2.1 Structure of the operating menu

Menu	Submenu / parameter	Meaning
	Language ¹⁾	Defines the operating language of the on-site display.
Setup	Parameter 1 ... Parameter N	When all these parameters have been assigned appropriate values, the measured should be completely configured in a standard application.
	Advanced setup	Contains further submenus and parameters: <ul style="list-style-type: none"> ▪ to adapt the device to special measuring conditions. ▪ to process the measured value (scaling, linearization). ▪ to configure the signal output.
Diagnostics	Diagnostic list	Contains up to 5 currently active error messages.
	Event logbook ²⁾	Contains the last 20 messages (which are no longer active).
	Device information	Contains information needed to identify the device.
	Measured values	Contains all current measured values.
	Data logging	Contains the history of the individual measuring values.
	Simulation	Used to simulate measured values or output values.
	Device check	Contains all parameters needed to check the measurement capability of the device.
	Heartbeat ³⁾	Contains all wizards for the Heartbeat Verification and Heartbeat Monitoring application packages.
Expert ⁴⁾ Contains all parameters of the device (including those which are already contained in one of the above submenus). This menu is organized according to the function blocks of the device. The parameter of the Expert menu are described in: GPO1014F (HART)	System	Contains all general device parameters which do not affect the measurement or the communication interface.
	Sensor	Contains all parameters needed to configure the measurement.
	Output	<ul style="list-style-type: none"> ▪ Contains all parameters needed to configure the current output. ▪ Contains all parameters needed to configure the switch output (PFS).
	Communication	Contains all parameters needed to configure the digital communication interface.
	Diagnostics	Contains all parameters needed to detect and analyze operational errors.

- 1) In case of operation via operating tools (e.g. FieldCare), the "Language" parameter is located at "Setup → Advanced setup → Display"
- 2) only available with local operation
- 3) only available for operation via DeviceCare or FieldCare
- 4) On entering the "Expert" menu, an access code is always requested. If a customer specific access code has not been defined, "0000" has to be entered.

8.2.2 User roles and related access authorization

The two user roles **Operator** and **Maintenance** have different write access to the parameters if a device-specific access code has been defined. This protects the device configuration via the local display from unauthorized access →  50.

Access authorization to parameters

User role	Read access		Write access	
	Without access code (from the factory)	With access code	Without access code (from the factory)	With access code
Operator	✓	✓	✓	--
Maintenance	✓	✓	✓	✓

If an incorrect access code is entered, the user obtains the access rights of the **Operator** role.

 The user role with which the user is currently logged on is indicated by the **Access status display** parameter (for display operation) or **Access status tooling** parameter (for tool operation).

8.2.3 Write protection via access code

Using the device-specific access code, the parameters for the measuring device configuration are write-protected and their values can no longer be changed via local operation.

Define access code via local display

1. Navigate to: Setup → Advanced setup → Administration → Define access code → Define access code
2. Define a max. 4-digit numeric code as an access code.
3. Repeat the same code in **Confirm access code** parameter.
 - ↳ The -symbol appears in front of all write-protected parameters.



Define access code via operating tool (e.g. FieldCare)

1. Navigate to: Setup → Advanced setup → Administration → Define access code
2. Define a max. 4-digit numeric code as an access code.
 - ↳ Write protection is active.



Parameters that can always be changed

The write protection does not include certain parameters that do not affect the measurement. Despite the defined access code, they can always be modified, even if the other parameters are locked.



If no key is pressed for 10 minutes in the navigation and editing mode, the device automatically locks the write-protected parameters. If the user goes from the navigation and editing mode back to the measured value display mode, the device automatically locks the write-protected parameters after 60 s.

-  If write access is activated via access code, it can be also be deactivated only via the access code →  51.
- In the "Description of Device Parameters" documents, each write-protected parameter is identified with the -symbol.

8.2.4 Disabling write protection via access code

If the -symbol appears on the local display in front of a parameter, the parameter is write-protected by a device-specific access code and its value cannot be changed at the moment using the local display →  50.

The locking of the write access via local operation can be disabled by entering the device-specific access code.

1. After you press , the input prompt for the access code appears.
2. Enter the access code.
 - ↳ The -symbol in front of the parameters disappears; all previously write-protected parameters are now re-enabled.

8.2.5 Deactivation of the write protection via access code

Via local display

1. Navigate to Setup → Advanced setup → Administration → Define access code → Define access code
2. Enter **0000**.
3. Repeat **0000** in **Confirm access code** parameter.
 - ↳ The write protection is deactivated. Parameters can be changed without entering an access code.

Via operating tool (e.g. FieldCare)

1. Navigate to Setup → Advanced setup → Administration → Define access code
2. Enter **0000**.
 - ↳ The write protection is deactivated. Parameters can be changed without entering an access code.

8.2.6 Write protection via write protection switch

Unlike parameter write protection via a user-specific access code, this allows write access to the entire operating menu - except for the **"Contrast display" parameter** - to be locked.

The parameter values are now read only and cannot be edited any more (exception **"Contrast display" parameter**):

- Via local display
- Via service interface (CDI)
- Via HART protocol

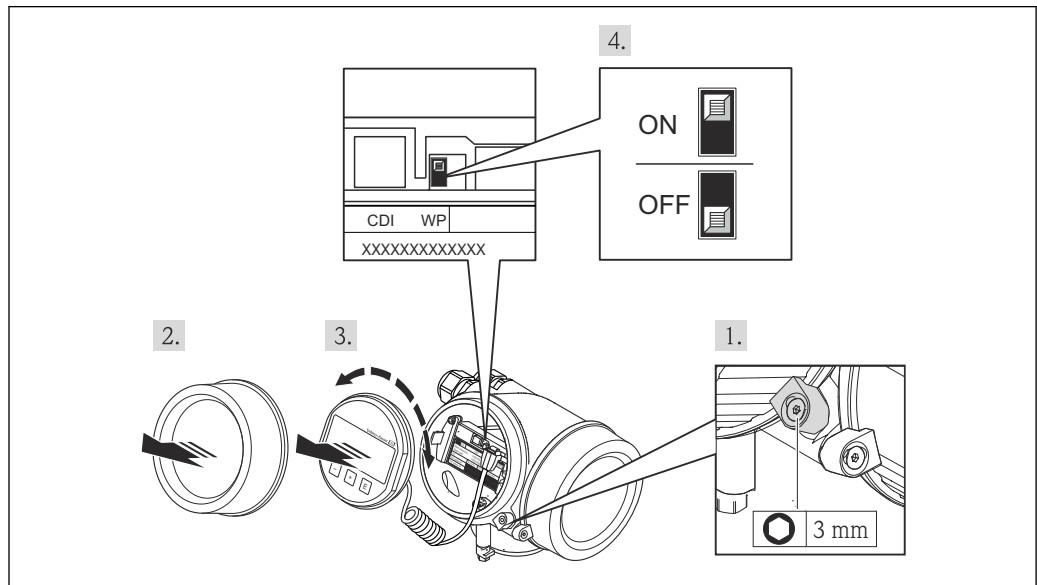

A0026157

1. Loosen the securing clamp.
2. Unscrew the housing cover.
3. Pull out the display module with a gentle rotation movement. To make it easier to access the lock switch, attach the display module to the edge of the electronics compartment.
 - ↳ Display module is attached to the edge of the electronics compartment.

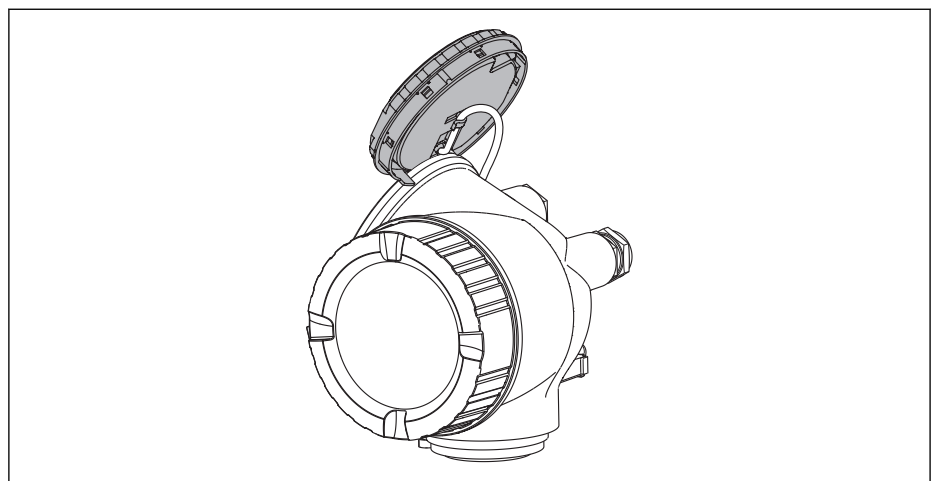

A0013909

4. Installing the lock switch (WP) on the main electronics module in the **ON** position enables the hardware write protection. Installing the lock switch (WP) on the main electronics module in the **OFF** position (factory setting) disables the hardware write protection.
 - ↳ If the hardware write protection is enabled: The **Hardware locked** option is displayed in the **Locking status** parameter. In addition to this, the -symbol appears in the header of the measured value display and in the navigation view in front of the parameters.

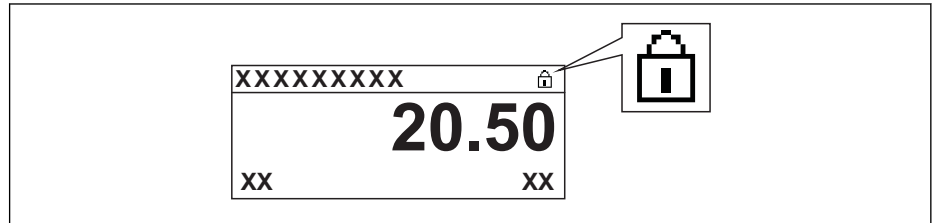

A0015870

If the hardware write protection is disabled: No option is displayed in the **Locking status** parameter. The -symbol disappears in the header of the measured value display and in the navigation view in front of the parameters.

5. Feed the spiral cable into the gap between the housing and main electronics module and plug the display module into the electronics compartment in the desired direction until it engages.
6. Screw the electronics compartment cover closed and tighten the securing clamp.

8.2.7 Enabling and disabling the keypad lock

The keypad lock allows to disable access to the entire operating menu via local operation. Thus navigating through the operating menu or modifying the values of individual parameters is no longer possible. Only the measured values on the measured value display can be read off.

The keylock is enabled and disabled via a context menu.

Enabling the keylock

For the SD03 display:

The keylock is automatically activated:

- If the device has not been operated via the display for > 1 minute.
- After a restart of the device.

To activate the keylock manually:

1. The device is in the measured value display.
Press  for at least 2 seconds.
↳ A context menu appears.
2. Select **Keylock on** from the context menu.
↳ The keylock is enabled.

 When attempting to access the operating menu while the keylock is enabled, the **Keylock on** message appears.

Disabling the keylock

1. The keylock is enabled.
Press  for at least 2 seconds.
↳ A context menu appears.
2. Select **Keylock off** from the context menu.
↳ The keylock is disabled.

8.3 Display and operating module

8.3.1 Display appearance

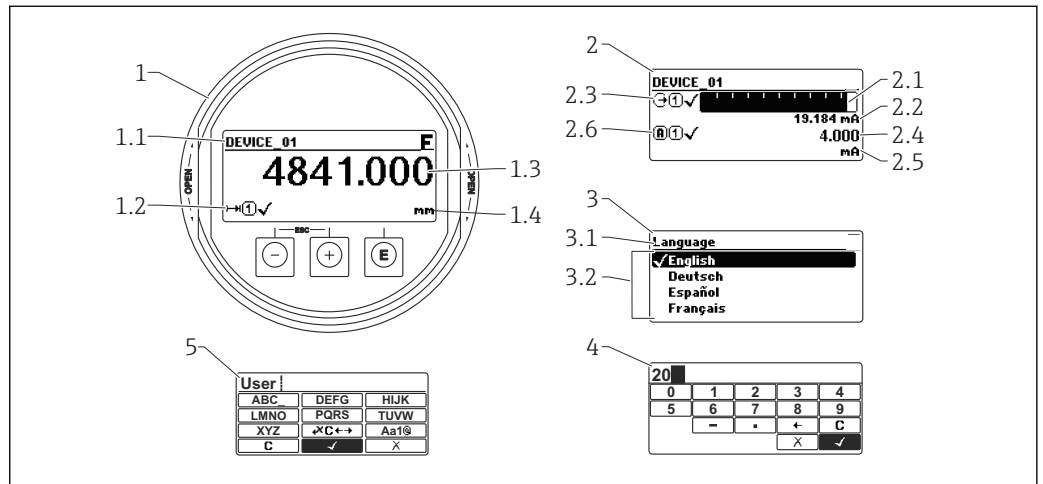





A0012635

19 Appearance of the display and operation module for on-site operation

- 1 Measured value display (1 value max. size)
- 1.1 Header containing tag and error symbol (if an error is active)
- 1.2 Measured value symbols
- 1.3 Measured value
- 1.4 Unit
- 2 Measured value display (1 bargraph + 1 value)
- 2.1 Bargraph for measured value 1
- 2.2 Measured value 1 (including unit)
- 2.3 Measured value symbols for measured value 1
- 2.4 Measured value 2
- 2.5 Unit for measured value 2
- 2.6 Measured value symbols for measured value 2
- 3 Representation of a parameter (here: a parameter with selection list)
- 3.1 Header containing parameter name and error symbol (if an error is active)
- 3.2 Selection list; marks the current parameter value.
- 4 Input matrix for numbers
- 5 Input matrix for alphanumeric and special characters



Display symbols for the submenus

Symbol	Meaning
 A0011975	Display/operation Is displayed: <ul style="list-style-type: none"> in the main menu next to the selection "Display/operation" in the header, if you are in the "Display/operation" menu
 A0011974	Setup Is displayed: <ul style="list-style-type: none"> in the main menu next to the selection "Setup" in the header, if you are in the "Setup" menu
 A0011976	Expert Is displayed: <ul style="list-style-type: none"> in the main menu next to the selection "Expert" in the header, if you are in the "Expert" menu
 A0011977	Diagnostics Is displayed: <ul style="list-style-type: none"> in the main menu next to the selection "Diagnostics" in the header, if you are in the "Diagnostics" menu











Status signals

F A0013956	"Failure" A device error is present. The measured value is no longer valid.
C A0013959	"Function check" The device is in service mode (e.g. during a simulation).
S A0013958	"Out of specification" The device is operated: <ul style="list-style-type: none"> Outside of its technical specifications (e.g. during startup or a cleaning) Outside of the configuration carried out by the user (e.g. level outside configured span)
M A0013957	"Maintenance required" Maintenance is required. The measured value is still valid.







Display symbols for the locking state

Symbol	Meaning
 A0011978	Display parameter Marks display-only parameters which can not be edited.
 A0011979	Device locked <ul style="list-style-type: none"> In front of a parameter name: The device is locked via software and/or hardware. In the header of the measured value screen: The device is locked via hardware.

Measured value symbols

Symbol	Meaning
Measured values	
 A0011995	Level
 A0011996	Distance
 A0011998	Current output
 A0011999	Measured current
 A0012106	Terminal voltage
 A0012104	Temperature of the electronics or the sensor
Measuring channels	
 A0012000	Measuring channel 1
 A0012107	Measuring channel 2
Status of the measured value	
 A0012102	Status "Alarm" The measurement is interrupted. The output assumes the defined alarm value. A diagnostic message is generated.
 A0012103	Status "Warning" The device continues measuring. A diagnostic message is generated.

8.3.2 Operating elements

Key	Meaning
 A0013969	<p>Minus key</p> <p><i>For menu, submenu</i> Moves the selection bar upwards in a picklist.</p> <p><i>For text and numeric editor</i> In the input mask, moves the selection bar to the left (backwards).</p>
 A0013970	<p>Plus key</p> <p><i>For menu, submenu</i> Moves the selection bar downwards in a picklist.</p> <p><i>For text and numeric editor</i> In the input mask, moves the selection bar to the right (forwards).</p>
 A0013952	<p>Enter key</p> <p><i>For measured value display</i></p> <ul style="list-style-type: none"> ▪ Pressing the key briefly opens the operating menu. ▪ Pressing the key for 2 s opens the context menu. <p><i>For menu, submenu</i></p> <ul style="list-style-type: none"> ▪ Pressing the key briefly Opens the selected menu, submenu or parameter. ▪ Pressing the key for 2 s for parameter: If present, opens the help text for the function of the parameter. <p><i>For text and numeric editor</i></p> <ul style="list-style-type: none"> ▪ Pressing the key briefly <ul style="list-style-type: none"> - Opens the selected group. - Carries out the selected action. ▪ Pressing the key for 2 s confirms the edited parameter value.
 A0013971	<p>Escape key combination (press keys simultaneously)</p> <p><i>For menu, submenu</i></p> <ul style="list-style-type: none"> ▪ Pressing the key briefly <ul style="list-style-type: none"> - Exits the current menu level and takes you to the next higher level. - If help text is open, closes the help text of the parameter. ▪ Pressing the key for 2 s returns you to the measured value display ("home position"). <p><i>For text and numeric editor</i> Closes the text or numeric editor without applying changes.</p>
 A0013953	<p>Minus/Enter key combination (press and hold down the keys simultaneously)</p> <p>Reduces the contrast (brighter setting).</p>
 A0013954	<p>Plus/Enter key combination (press and hold down the keys simultaneously)</p> <p>Increases the contrast (darker setting).</p>
 A0013955	<p>Minus/Plus/Enter key combination (press and hold down the keys simultaneously)</p> <p><i>For measured value display</i> Enables or disables the keypad lock.</p>

8.3.3 Entering numbers and text

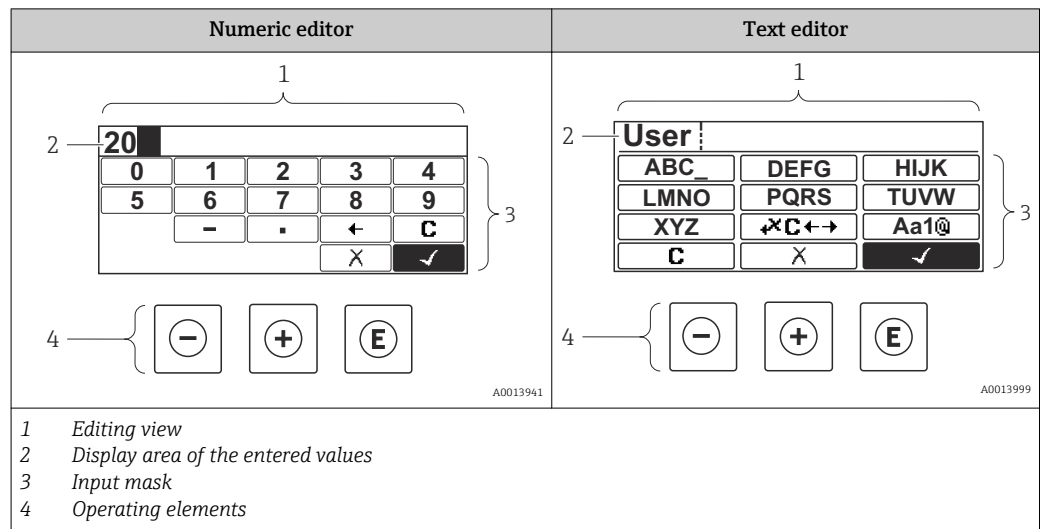

Input mask









The following input symbols are available in the input mask of the numeric and text editor:

Numeric editor symbols

Symbol	Meaning
	Selection of numbers from 0 to 9.
	Inserts decimal separator at the input position.
	Inserts minus sign at the input position.
	Confirms selection.
	Moves the input position one position to the left.
	Exits the input without applying the changes.
	Clears all entered characters.

Text editor symbols

Symbol	Meaning
	Selection of letters from A to Z
	Toggle <ul style="list-style-type: none"> Between upper-case and lower-case letters For entering numbers For entering special characters

 <small>A0013985</small>	Confirms selection.
 <small>A0013987</small>	Switches to the selection of the correction tools.
 <small>A0013986</small>	Exits the input without applying the changes.
 <small>A0014040</small>	Clears all entered characters.
Correction symbols under 	
 <small>A0013989</small>	Clears all entered characters.
 <small>A0013991</small>	Moves the input position one position to the right.
 <small>A0013990</small>	Moves the input position one position to the left.
 <small>A0013988</small>	Deletes one character immediately to the left of the input position.

8.3.4 Opening the context menu

Using the context menu, the user can call up the following menus quickly and directly from the operational display:

- Setup
- Conf. backup disp.
- Simulation



Calling up and closing the context menu

The user is in the operational display.

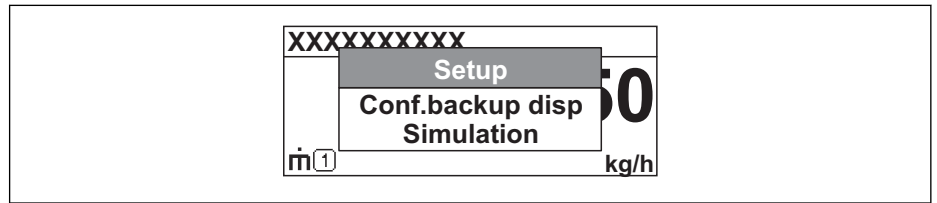

1. Press  for 2 s.
 - ↳ The context menu opens.



A0014003-EN

2. Press  +  simultaneously.
 - ↳ The context menu is closed and the operational display appears.

Calling up the menu via the context menu

1. Open the context menu.
2. Press  to navigate to the desired menu.
3. Press  to confirm the selection.
 - ↳ The selected menu opens.

8.3.5 Envelope curve on the display and operating module

In order to assess the measuring signal, the envelope curve and - if a mapping has been recorded - the mapping curve can be displayed:

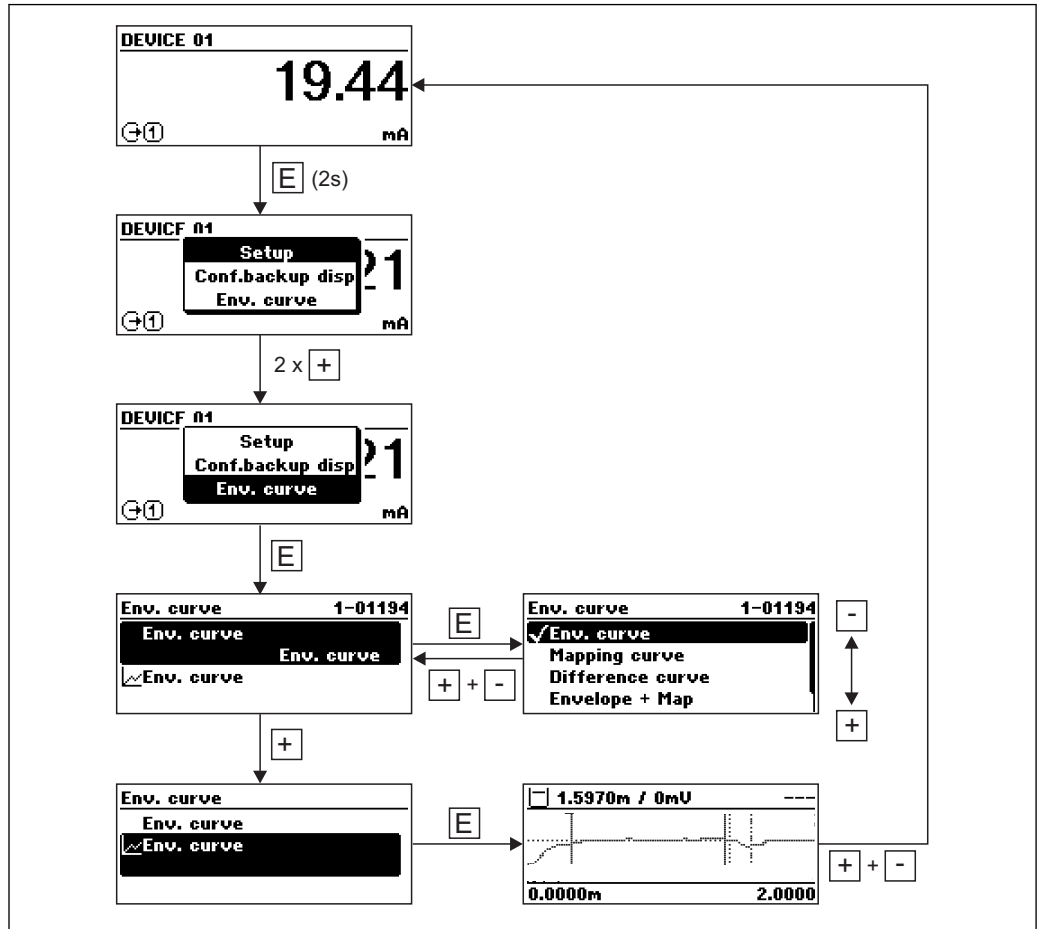

A0014277

9 System integration via HART protocol





9.1 Overview of the Device Description files (DD)

Manufacturer ID	0x11
Device type	0x1128
HART specification	7.0
DD files	For information and files see: <ul style="list-style-type: none"> ▪ www.endress.com ▪ www.hartcomm.org

9.2 Measured values via HART protocol

On delivery the following measuring values are assigned to the HART device variables:

Device variable	Measuring value
Primary variable (PV)	Level linearized
Secondary variable (SV)	Unfiltered distance
Tertiary variable (TV)	Absolute echo amplitude
Quaternary variable (QV)	Relative echo amplitude

-  The allocation of the device variables can be changed in the operating menu:
Expert → Communication → Output
-  In a HART multidrop loop only one device may use the output current for signal transmission. For all other devices the following must be set:
 - **Current span** (→  140) = **Fixed current**
 - **Fixed current** (→  140) = **4 mA**

10 Commissioning via wizard

A wizard guiding the user through the initial setup is available in FieldCare and DeviceCare.

1. Connect the device to FieldCare or DeviceCare → 46.
2. Open the device in FieldCare or DeviceCare.
 - ↳ The dashboard (home page) of the device appears:

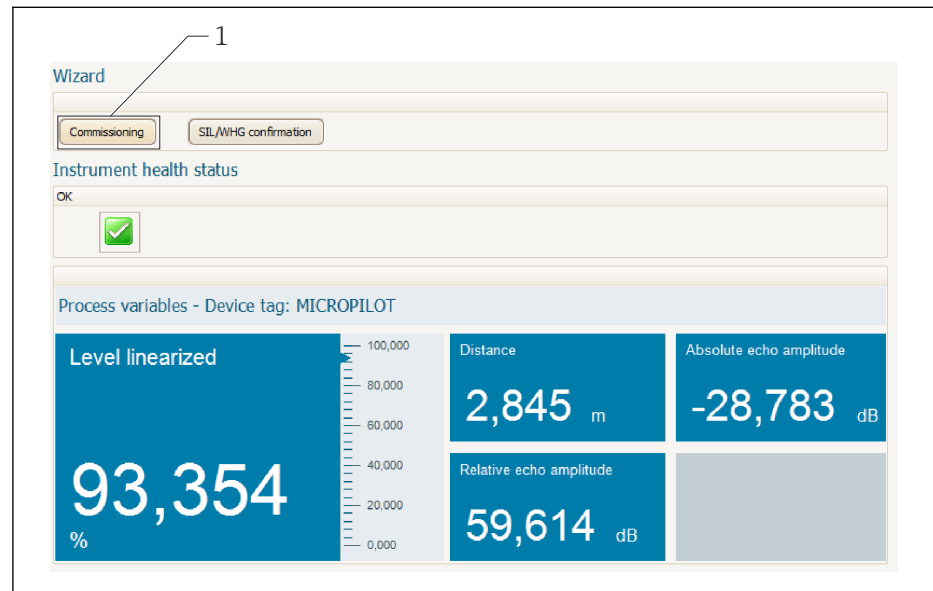

A0027720

1 "Commissioning" button calls up the wizard.

3. Click on "Commissioning" to call up the wizard.
 4. Enter or select the appropriate value for each parameter. These values are immediately written to the device.
 5. Click "Next" to switch to the next page.
 6. After finishing the last page, click "End of sequence" to close the wizard.
- i** If the wizard is cancelled before all necessary parameters have been set, the device may be in an undefined state. A reset to the default settings is recommended in this case.

11 Commissioning via operating menu

11.1 Installation and function check

Make sure that all final checks have been completed before you start up your measuring point:

- Checklist "Post-installation check" → 32
- Checklist "Post-connection check" → 44

11.2 Setting the operating language

Factory setting: English or ordered local language

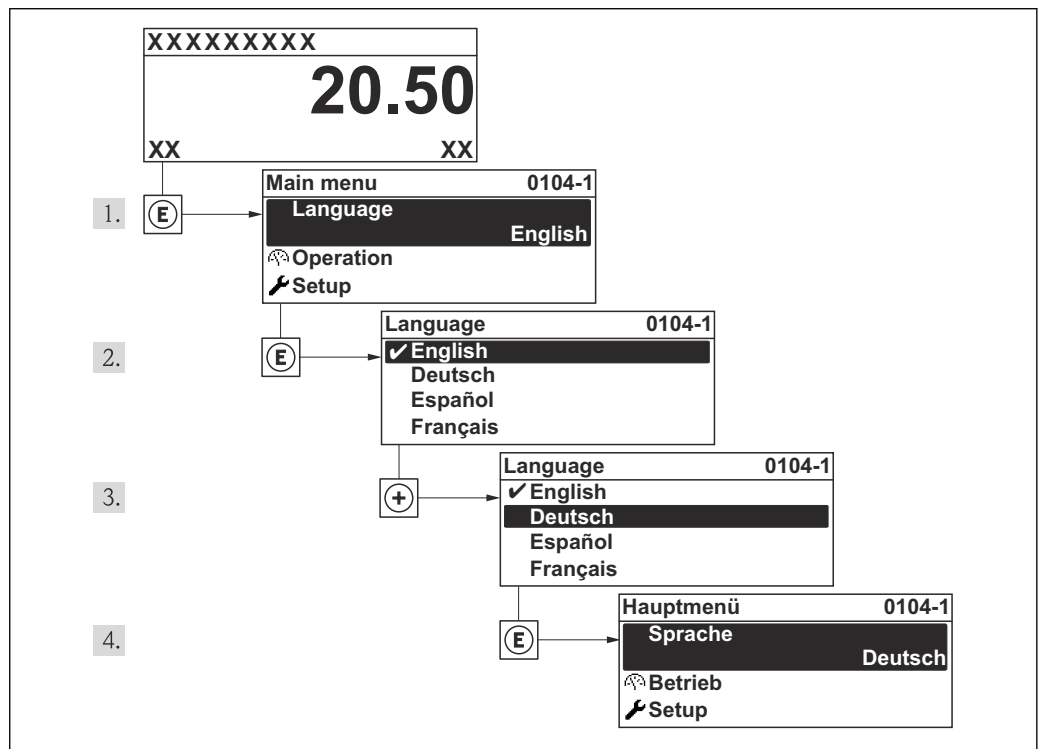

20 Using the example of the local display

A0013996

11.3 Configuration of a level measurement

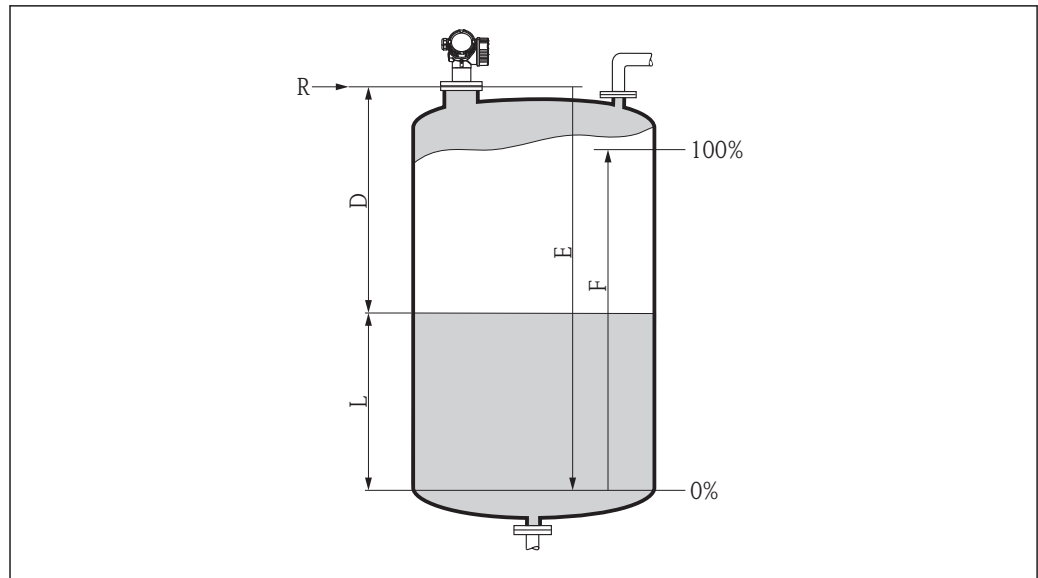



A0016933

21 Configuration parameters for level measurements in liquids

- R Reference point of the measurement
- D Distance
- L Level
- E Empty calibration (= zero)
- F Full calibration (= span)

1. Navigate to: Setup → Device tag
 - ↳ Enter device tag.
2. Navigate to: Setup → Distance unit
 - ↳ Select distance unit.
3. Navigate to: Setup → Tank type
 - ↳ Select tank type.
4. For **Tank type** parameter = Bypass / pipe:
 - Navigate to: Setup → Tube diameter
 - ↳ Enter the diameter of the stilling well or bypass.
5. Navigate to: Setup → Medium group
 - ↳ Specify medium group: (**Water based (DC >= 4)** or **Others**)
6. Navigate to: Setup → Empty calibration
 - ↳ Enter empty distance E (Distance from reference point R to the 0% level) ⁴⁾.
7. Navigate to: Setup → Full calibration
 - ↳ Enter full distance F (Distance from the 0% to the 100% level).
8. Navigate to: Setup → Level
 - ↳ Indicates the measured level L.
9. Navigate to: Setup → Distance
 - ↳ Indicates the measured distance from the reference point R to the level L.
10. Navigate to: Setup → Signal quality
 - ↳ Indicates the quality of the evaluated level echo.

4) If, for example, the measuring range covers only an upper part of the tank ($E \ll$ tank height), it is mandatory to enter the actual tank height into the "Setup → Advanced Setup → Level → Tank/silo height" parameter.

11. When operating via local display:
Navigate to: Setup → Mapping → Confirm distance
 - ↳ Compare distance indicated on the display to real distance in order to start the recording of an interference echo map.
 12. When operating via operating tool:
Navigate to: Setup → Confirm distance
 - ↳ Compare distance indicated on the display to real distance in order to start the recording of an interference echo map.
 13. Navigate to: Setup → Advanced setup → Level → Level unit
 - ↳ Select level unit: %, m, mm, ft, in (Factory setting: %)
-  The response time of the device is preset by the **Tank type** parameter (→  106). More detailed settings are possible in the **Advanced setup** submenu.

11.4 Recording the reference curve

After the configuration of the measurement it is recommended to record the current envelope curve as a reference curve. The reference curve can be used later on in the process for diagnostic purposes. To record the reference curve use the **Save reference curve** parameter.

Navigation in the menu

Expert → Diagnostics → Envelope diagnostics → Save reference curve

Meaning of the options

- No
No action
- Yes
The current envelope curve is saved as reference curve.

 In devices which have been delivered with software version 01.00.zz, this submenu is only visible for the "Service" user role.

 The reference curve can only be displayed in the envelope curve diagram of FieldCare after it has been loaded from the device into FieldCare. This is performed by the "Load Reference Curve" function in FieldCare.



 22 The "Load Reference Curve" function

11.5 Configuration of the on-site display

11.5.1 Factory settings of the on-site display

Parameter	Factory setting
Format display	1 value, max. size
Value 1 display	Level linearized
Value 2 display	None
Value 3 display	None
Value 4 display	None

11.5.2 Adjustment of the on-site display

The on-site display can be adjusted in the following submenu:
Setup → Advanced setup → Display

11.6 Configuration of the current outputs

11.6.1 Factory setting of the current outputs

Current output	Allocated measuring value	4mA value	20mA value
1	Level linearized	0% or the corresponding linearized value	100% or the corresponding linearized value
2 ¹⁾	Distance	0	Empty calibration

1) for devices with 2 current outputs

11.6.2 Adjustment of the current outputs

The current outputs can be adjusted in the following menus:

Basic settings

Setup → Advanced setup → Current output 1 to 2

Advanced settings

Expert → Output 1 to 2 → Current output 1 to 2

See "Description of Device Parameters", GP01014F

11.7 Configuration management

After commissioning, you can save the current device configuration, copy it to another measuring point or restore the previous device configuration. You can do so using the **Configuration management** parameter and its options.

Navigation path in the operating menu

Setup → Advanced setup → Configuration backup display → Configuration management

Meaning of the options

■ Cancel

No action is executed and the user exits the parameter.

■ Execute backup

A backup copy of the current device configuration in the HistoROM (built-in in the device) is saved to the display module of the device. The backup copy comprises the transmitter and sensor data of the device.

■ Restore

The last backup copy of the device configuration is copied from the display module to the HistoROM of the device. The backup copy comprises the transmitter and sensor data of the device.

■ Duplicate

The transmitter configuration is duplicated to another device using the transmitter display module. The following parameters, which characterize the individual measuring point are **not** included in the transmitted configuration:

- HART date code
- HART short tag
- HART message
- HART descriptor
- HART address
- Device tag
- Medium type



■ Compare

The device configuration saved in the display module is compared to the current device configuration of the HistoROM. The result of this comparison is displayed in the **Comparison result** parameter.

■ Clear backup data

The backup copy of the device configuration is deleted from the display module of the device.



 While this action is in progress, the configuration cannot be edited via the local display and a message on the processing status appears on the display.

 If an existing backup is restored to a different device using the **Restore** option, it may occur that some device functionalities are no longer available. In some cases even a device reset →  157 will not restore the original status.

In order to transmit a configuration to a different device, the **Duplicate** option should always be used.

11.8 Protection of the settings against unauthorized changes







There are two ways to protect the settings against unauthorized changes:

- Via parameter settings (software locking) →  50
- Via locking switch (hardware locking) →  52







12 Diagnostics and troubleshooting

12.1 General trouble shooting

12.1.1 General errors

Error	Possible cause	Remedial action
Device does not respond.	Supply voltage does not match the value indicated on the nameplate.	Connect the correct voltage.
	The polarity of the supply voltage is wrong.	Correct the polarity.
	The cables do not contact the terminals properly.	Ensure electrical contact between the cable and the terminal.
Values on the display invisible	Contrast setting is too weak or too strong.	<ul style="list-style-type: none"> ▪ Increase contrast by pressing  and  simultaneously. ▪ Decrease contrast by pressing  and  simultaneously.
	The plug of the display cable is not connected correctly.	Connect the plug correctly.
	Display is defective.	Replace display.
"Communication error" is indicated on the display when starting the device or connecting the display	Electromagnetic interference	Check grounding of the device.
	Broken display cable or display plug.	Exchange display.
Output current < 3.6 mA	Signal cable connection incorrect.	Check connection.
	Electronics is defective.	Replace electronics.
HART communication does not function.	Communication resistor missing or incorrectly installed.	Install the communication resistor (250 Ω) correctly →  33.
	Commubox connected incorrectly.	Connect Commubox correctly →  46.
	Commubox not switched to HART mode.	Set the selection switch of the Commubox to the HART position.
CDI communication does not work.	Wrong setting of the COM port on the computer.	Check the setting of the COM port on the computer and change it if necessary.
Device measures incorrectly.	Parametrization error	Check and adjust parameterization.

12.1.2 Parametrization errors

Error	Possible cause	Remdy
Measured value incorrect	If measured distance (Setup → Distance) matches the real distance: Calibration error	<ul style="list-style-type: none"> ▪ Check and adjust Empty calibration parameter (→  108) if necessary. ▪ Check and adjust Full calibration parameter (→  108) if necessary. ▪ Check and adjust linearization if necessary (Linearization submenu (→  124)).
	For measurements in bypasses / stilling well: <ul style="list-style-type: none"> ▪ Wrong tank type ▪ Wrong tube diameter 	<ul style="list-style-type: none"> ▪ Select Tank type (→  106) = Bypass / pipe. ▪ Enter correct diameter in Tube diameter parameter (→  107).
	Enter correct diameter in	Enter correct value in Level correction parameter (→  121).

Error	Possible cause	Remedy
	If measured distance (Setup → Distance) does not match the real distance: Interference echo	Carry out tank mapping (Confirm distance parameter (→ ☰ 110)).
No change of measured value on filling / emptying	Interference echo from installations, nozzle or build-up on the antenna.	<ul style="list-style-type: none"> ▪ Carry out tank mapping (Confirm distance parameter (→ ☰ 110)). ▪ If necessary, clean antenna ▪ If necessary, select better mounting position
If the surface is not calm (e.g. filling, emptying, agitator running), the measured value jumps sporadically to a higher level	Signal is weakened by the rough surface - the interference echoes are sometimes stronger.	<ul style="list-style-type: none"> ▪ Carry out tank mapping (Confirm distance parameter (→ ☰ 110)). ▪ Select Tank type (→ ☰ 106) = Process vessel with agitator. ▪ Increase integration time (Expert → Sensor → Distance → Integration time) ▪ Optimize orientation of the antenna ▪ If necessary, select a better mounting position and/or larger antenna.
During filling/emptying the measured value jumps downwards	Multiple echoes	<ul style="list-style-type: none"> ▪ Check Tank type parameter (→ ☰ 106). ▪ If possible, do not select central installation position. ▪ If appropriate, use a stilling well.
Error message F941 or S941 "Echo lost"	Level echo is too weak.	<ul style="list-style-type: none"> ▪ Check Medium group parameter (→ ☰ 107). ▪ If necessary, select a more detailed setting in Medium property parameter (→ ☰ 118). ▪ Optimize alignment of antenna ▪ If necessary, select a better installation position and/or larger antenna.
	Level echo suppressed.	Delete mapping and record it again.
Device displays a level when the tank is empty.	Interference echo	Carry out mapping over entire measuring range when the tank is empty (Confirm distance parameter (→ ☰ 110)).
Wrong slope of the level in the entire measuring range	Wrong tank type selected.	Set Tank type parameter (→ ☰ 106) correctly.

12.2 Diagnostic information on local display

12.2.1 Diagnostic message

Faults detected by the self-monitoring system of the measuring device are displayed as a diagnostic message in alternation with the measured value display.

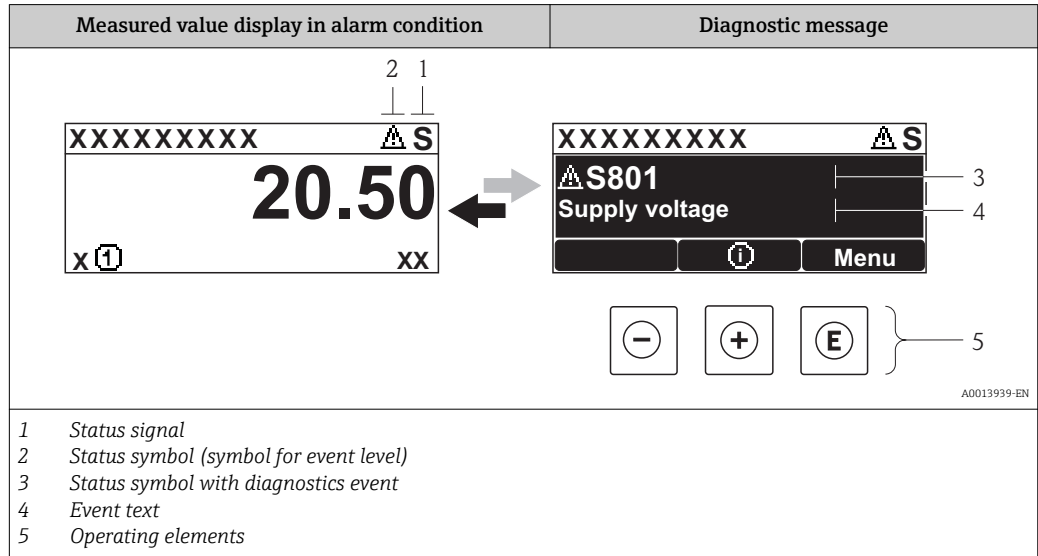

Status signals

F <small>A0013956</small>	"Failure" A device error is present. The measured value is no longer valid.
C <small>A0013959</small>	"Function check" The device is in service mode (e.g. during a simulation).
S <small>A0013958</small>	"Out of specification" The device is operated: <ul style="list-style-type: none"> ▪ Outside of its technical specifications (e.g. during startup or a cleaning) ▪ Outside of the configuration carried out by the user (e.g. level outside configured span)
M <small>A0013957</small>	"Maintenance required" Maintenance is required. The measured value is still valid.

Status symbol (symbol for event level)



 <small>A0013961</small>	"Alarm" status The measurement is interrupted. The signal outputs take on the defined alarm condition. A diagnostic message is generated.
 <small>A0013962</small>	"Warning" status The device continues to measure. A diagnostic message is generated.

Diagnostics event and event text

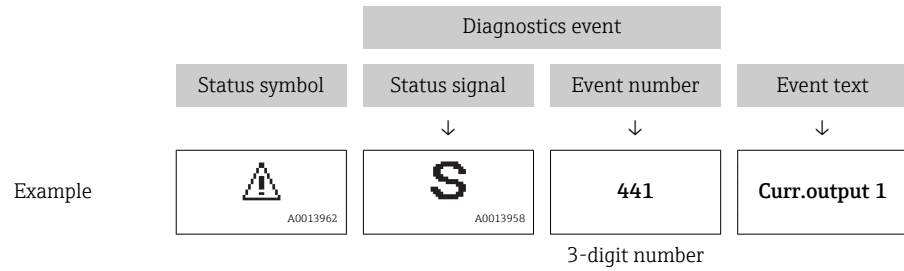

The fault can be identified using the diagnostics event. The event text helps you by providing information about the fault. In addition, the corresponding symbol is displayed before the diagnostics event.



If two or more diagnostic messages are pending simultaneously, only the message with the highest priority is shown. Additional pending diagnostic messages can be shown in **Diagnostic list** submenu (→  162).

-  Past diagnostic messages that are no longer pending are shown as follows:
 - On the local display:
 - in **Event logbook** submenu (→  163)
 - In FieldCare:
 - via the "Event List /HistoROM" function.

Operating elements

Operating functions in menu, submenu	
 <small>A0013970</small>	Plus key Opens the message about the remedial measures.
 <small>A0013952</small>	Enter key Opens the operating menu.

12.2.2 Calling up remedial measures

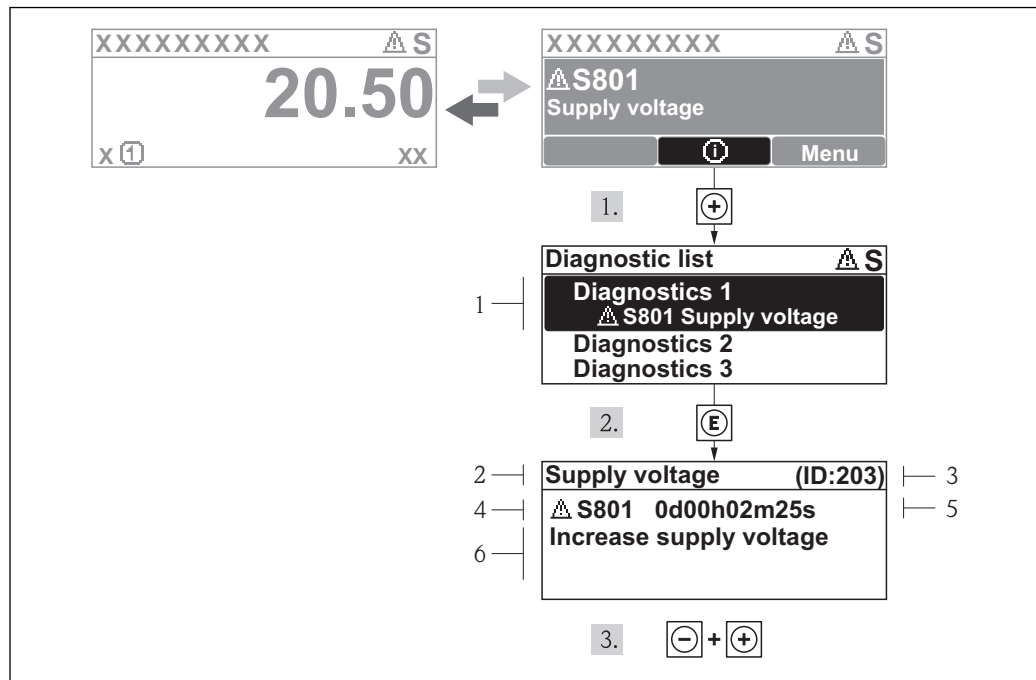

A0013940-EN

23 Message for remedial measures

- 1 Diagnostic information
- 2 Short text
- 3 Service ID
- 4 Diagnostic behavior with diagnostic code
- 5 Operation time of occurrence
- 6 Remedial measures

The user is in the diagnostic message.

1. Press \oplus (i symbol).
 - ↳ **Diagnostic list** submenu opens.
2. Select the desired diagnostic event with \oplus or \ominus and press E .
 - ↳ The message for the remedial measures for the selected diagnostic event opens.
3. Press $\ominus + \oplus$ simultaneously.
 - ↳ The message for the remedial measures closes.

The user is in the **Diagnostics** menu at an entry for a diagnostics event, e.g. in **Diagnostic list** submenu or in **Previous diagnostics**.

1. Press E .
 - ↳ The message for the remedial measures for the selected diagnostic event opens.
2. Press $\ominus + \oplus$ simultaneously.
 - ↳ The message for the remedial measures closes.

12.3 Diagnostic event in the operating tool

If a diagnostic event is present in the device, the status signal appears in the top left status in the operating tool along with the corresponding symbol for event level in accordance with NAMUR NE 107:

- Failure (F)
- Function check (C)
- Out of specification (S)
- Maintenance required (M)

Calling up remedial measures

1. Navigate to the **Diagnostics** menu.
 - ↳ In the **Actual diagnostics** parameter, the diagnostic event is shown with event text.
2. On the right in the display range, hover the cursor over the **Actual diagnostics** parameter.
 - ↳ A tool tip with remedial measures for the diagnostic event appears.



12.4 Diagnostic list

In the Diagnostic list submenu, up to 5 currently pending diagnostic messages can be displayed. If more than 5 messages are pending, the messages with the highest priority are shown on the display.

Navigation path

Diagnostics → Diagnostic list

Calling up and closing the remedial measures

1. Press .
- ↳ The message for the remedial measures for the selected diagnostic event opens.
2. Press  +  simultaneously.
- ↳ The message about the remedial measures closes.

12.5 Overview of diagnostic events

Diagnostic number	Short text	Remedy instructions	Status signal [from the factory]	Diagnostic behavior [from the factory]
Diagnostic of electronic				
242	Software incompatible	1. Check software 2. Flash or change main electronics module	F	Alarm
252	Modules incompatible	1. Check electronic modules 2. Change I/O or main electronic module	F	Alarm
261	Electronic modules	1. Restart device 2. Check electronic modules 3. Change I/O Modul or main electronics	F	Alarm
262	Module connection	1. Check module connections 2. Change electronic modules	F	Alarm
270	Main electronic failure	Change main electronic module	F	Alarm
271	Main electronic failure	1. Restart device 2. Change main electronic module	F	Alarm
272	Main electronic failure	1. Restart device 2. Contact service	F	Alarm
273	Main electronic failure	1. Emergency operation via display 2. Change main electronics	F	Alarm
275	I/O module failure	Change I/O module	F	Alarm
276	I/O module failure	1. Restart device 2. Change I/O module	F	Alarm
282	Data storage	1. Restart device 2. Contact service	F	Alarm
283	Memory content	1. Transfer data or reset device 2. Contact service	F	Alarm
311	Electronic failure	1. Transfer data or reset device 2. Contact service	F	Alarm
311	Electronic failure	Maintenance required! 1. Do not perform reset 2. Contact service	M	Warning
Diagnostic of configuration				
410	Data transfer	1. Check connection 2. Retry data transfer	F	Alarm
411	Up-/download active	Up-/download active, please wait	C	Warning
431	Trim 1 to 2	Carry out trim	C	Warning
435	Linearization	Check linearization table	F	Alarm
437	Configuration incompatible	1. Restart device 2. Contact service	F	Alarm
438	Dataset	1. Check data set file 2. Check device configuration 3. Up- and download new configuration	M	Warning
441	Current output 1 to 2	1. Check process 2. Check current output settings	S	Warning
484	Simulation failure mode	Deactivate simulation	C	Alarm

Diagnostic number	Short text	Remedy instructions	Status signal [from the factory]	Diagnostic behavior [from the factory]
485	Simulation measured value	Deactivate simulation	C	Warning
491	Simulation current output 1 to 2	Deactivate simulation	C	Warning
494	Switch output simulation	Deactivate simulation switch output	C	Warning
495	Simulation diagnostic event	Deactivate simulation	C	Warning
585	Simulation distance	Deactivate simulation	C	Warning
586	Record map	Recording of mapping please wait	C	Warning
Diagnostic of process				
801	Energy too low	Increase supply voltage	S	Warning
803	Current loop	1. Check wiring 2. Change I/O module	F	Alarm
825	Operating temperature	1. Check ambient temperature 2. Check process temperature	S	Warning
825	Operating temperature		F	Alarm
921	Change of reference	1. Check reference configuration 2. Check pressure 3. Check sensor	S	Warning
941	Echo lost	Check parameter 'DC value'	S	Warning
941	Echo lost		F	Alarm
942	In safety distance	1. Check level 2. Check safety distance 3. Reset self holding	S	Warning
942	In safety distance		S	Alarm
943	In blocking distance	Reduced accuracy Check level	S	Warning
950	Advanced diagnostic 1 to 2 occurred	Maintain your diagnostic event	M	Warning ¹⁾

1) Diagnostic behavior can be changed.

12.6 Event logbook

12.6.1 Event history

A chronological overview of the event messages that have occurred is provided in the **Event list** submenu⁵⁾.

Navigation path

Diagnostics → Event logbook → Event list



A maximum of 100 event messages can be displayed in chronological order.

The event history includes entries for:



- Diagnostic events
- Information events

5) This submenu is only available for operation via local display. In the case of operation via FieldCare, the event list can be displayed with the "Event List / HistoROM" functionality of FieldCare.

In addition to the operation time of its occurrence, each event is also assigned a symbol that indicates whether the event has occurred or is ended:

- Diagnostic event
 - : Event has occurred
 - : Event has ended
- Information event
 - : Event has occurred

Calling up and closing the remedial measures

1. Press .
 - ↳ The message for the remedial measures for the selected diagnostic event opens.
2. Press  +  simultaneously.
 - ↳ The message about the remedial measures closes.

12.6.2 Filtering the event logbook

Using the **Filter options** parameter, you can define which category of event messages is displayed in the **Event list** submenu angezeigt werden.

Navigation path

Diagnostics → Event logbook → Filter options

Filter categories

- All
- Failure (F)
- Function check (C)
- Out of specification (S)
- Maintenance required (M)
- Information

12.6.3 Overview of information events

Info number	Info name
I1000	----- (Device ok)
I1089	Power on
I1090	Configuration reset
I1091	Configuration changed
I1092	Trend data deleted
I1110	Write protection switch changed
I1137	Electronic changed
I1151	History reset
I1154	Reset terminal voltage min/max
I1155	Reset electronic temperature
I1156	Memory error trend
I1157	Memory error event list
I1184	Display connected
I1185	Display backup done
I1186	Restore via display done
I1187	Settings downloaded with display
I1188	Display data cleared

Info number	Info name
I1189	Backup compared
I1256	Display: access status changed
I1264	Safety sequence aborted
I1335	Firmware changed
I1397	Fieldbus: access status changed
I1398	CDI: access status changed

12.7 Firmware history

Date	Firmware version	Modifications	Documentation (FMR50, HART)		
			Operating Instructions	Description of Parameters	Technical Information
12.2012	01.00.zz	Original software	BA01045F/00/EN/01.12	GP01014F/00/EN/01.12	TI01039F/00/EN/01.12
02.2015	01.01.zz	<ul style="list-style-type: none"> ■ additional languages ■ HistoROM functionality enhanced ■ Improvements and bugfixes 	BA01045F/00/ENE/03.14	GP01014F/00/EN/04.14	TI01039F/00/EN/05.14
04.2016	01.02.zz	Update to HART 7	BA01045F/00/EN/04.16 BA01045F/00/EN/05.16 ¹⁾	GP01014F/00/EN/05.16	TI01039F/00/EN/06.16 TI01039F/00/EN/07.16 ¹⁾

1) contains information on the Heartbeat wizards which are available in the latest DTM version for DeviceCare and FieldCare.

 The firmware version can explicitly be ordered via the product structure. In this way it is possible to ensure compatibility of the firmware version with an existing or planned system integration.

13 Maintenance

The measuring device requires no special maintenance.

13.1 Exterior cleaning

When exterior-cleaning the device, always use cleaning agents that do not attack the surface of the housing and the seals.

13.2 Replacing seals

The process seals of the sensors (at the process connection) must be replaced periodically, particularly if molded seals (aseptic construction) are used. The period between changes depends on the frequency of cleaning cycles and on the temperature of the measured substance and the cleaning temperature.

14 Repairs

14.1 General information on repairs

14.1.1 Repair concept

The Endress+Hauser repair concept assumes that the devices have a modular design and that repairs can be done by the Endress+Hauser service or specially trained customers.

Spare parts are contained in suitable kits. They contain the related replacement instructions.

For more information on service and spare parts, contact the Service Department at Endress+Hauser.

14.1.2 Repairs to Ex-approved devices

When carrying out repairs to Ex-approved devices, please note the following:

- Repairs to Ex-approved devices may only be carried out by trained personnel or by the Endress+Hauser Service.
- Comply with the prevailing standards, national Ex-area regulations, safety instructions (XA) and certificates.
- Only use original spare parts from Endress+Hauser.
- When ordering a spare part, please note the device designation on the nameplate. Only replace parts with identical parts.
- Carry out repairs according to the instructions. On completion of repairs, carry out the specified routine test on the device.
- Only Endress+Hauser Service may convert a certified device into a different certified variant.
- Document all repair work and conversions.

14.1.3 Replacement of an electronics module

If an electronics module has been replaced, it is not necessary to perform a new basic setup as the calibration parameters are stored in the HistoROM which is located in the housing. However, after exchanging the main electronics module it may be necessary to record a new mapping (interference echo suppression).

14.1.4 Replacement of a device

After a complete device or electronic module has been replaced, the parameters can be downloaded into the instrument again in one of the following ways:

- Via the display module
Condition: The configuration of the old device has been saved in the display module
→  154.
- Via FieldCare
Condition: The configuration of the old device has been saved to the computer via FieldCare.

You can continue to measure without carrying out a new setup. Only a linearization and a tank map (interference echo suppression) have to be recorded again.

14.2 Spare parts

- A few interchangeable measuring device components are identified by a spare part nameplate. This contains information about the spare part.
- The connection compartment cover of the device contains a spare part nameplate that includes the following information:
 - A list of the most important spare parts for the measuring device, including their ordering information.
 - The URL for the *W@M Device Viewer* (www.endress.com/deviceviewer): There, all spare parts for the measuring device are listed, including the order code, and can be ordered. If available, the corresponding Installation Instructions can also be downloaded there.

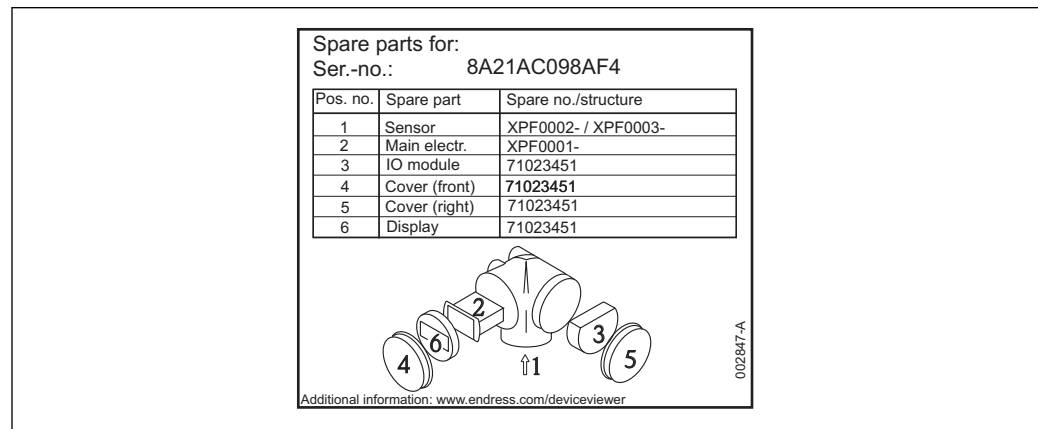

24 Example for spare part nameplate in connection compartment cover

- i** Measuring device serial number:
 - Is located on the device and spare part nameplate.
 - Can be read out via the "Serial number" parameter in the "Device information" submenu.

14.3 Return

The measuring device must be returned if it is need of repair or a factory calibration, or if the wrong measuring device has been delivered or ordered. Legal specifications require Endress+Hauser, as an ISO-certified company, to follow certain procedures when handling products that are in contact with the medium.

To ensure safe, swift and professional device returns, please refer to the procedure and conditions for returning devices provided on the Endress+Hauser website at <http://www.endress.com/support/return-material>

14.4 Disposal

Observe the following notes during disposal:

- Observe valid federal/national regulations.
- Ensure proper separation and reuse of the device components.

15 Accessories

15.1 Device-specific accessories

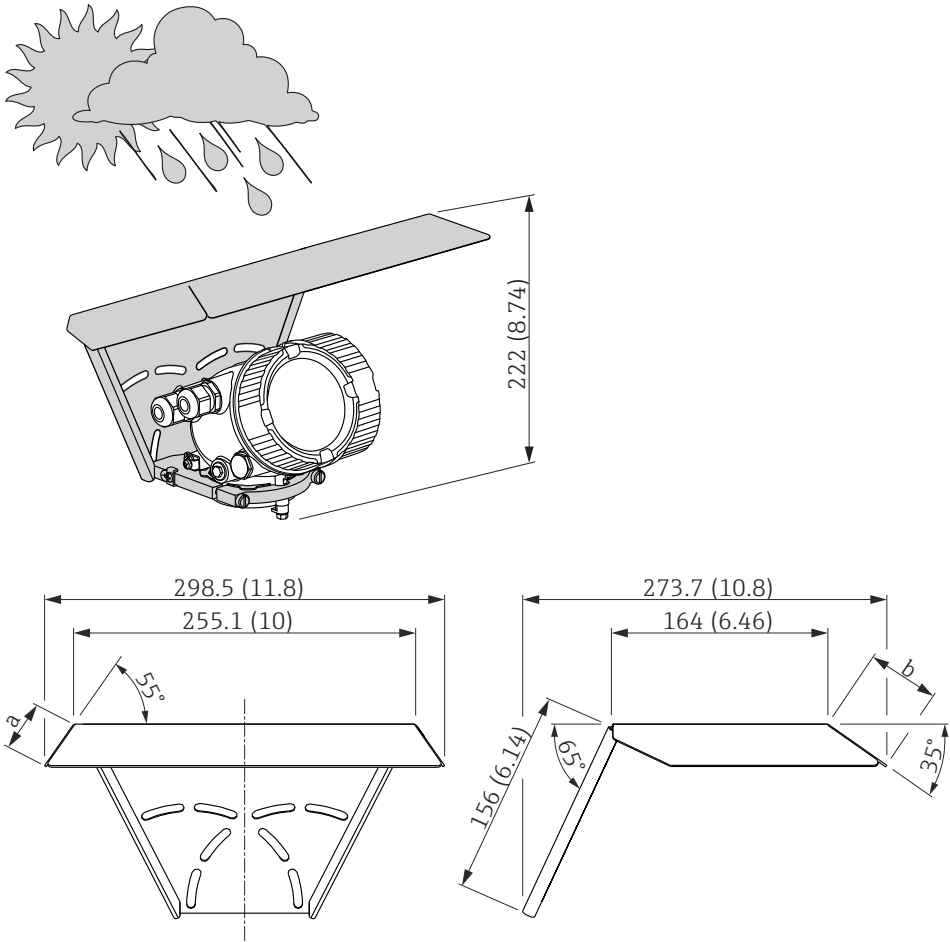

15.1.1 Weather protection cover

Accessory	Description
Weather protection cover	 <p data-bbox="416 1503 925 1529">☑ 25 Weather protection cover; Dimensions: mm (in)</p> <p data-bbox="416 1541 622 1592">a 37,8 mm (1,5 in) b 54 mm (2,1 in)</p> <p data-bbox="416 1621 1492 1697">i The weather protection cover can be ordered together with the device (product structure, feature 620 "Accessory Enclosed", option PB "Weather Protection Cover"). Alternatively, it can be separately ordered as an accessory; order code 71162242.</p>

15.1.2 Mounting nut G1-1/2

Accessory	Description
Mounting nut G1-1/2	<p data-bbox="416 1877 1061 1984">Drawing in preparation For FMR50 with with 40mm/1-1/2" horn antenna and G1-1/2" thread Material: PC Order code: 52014146</p>

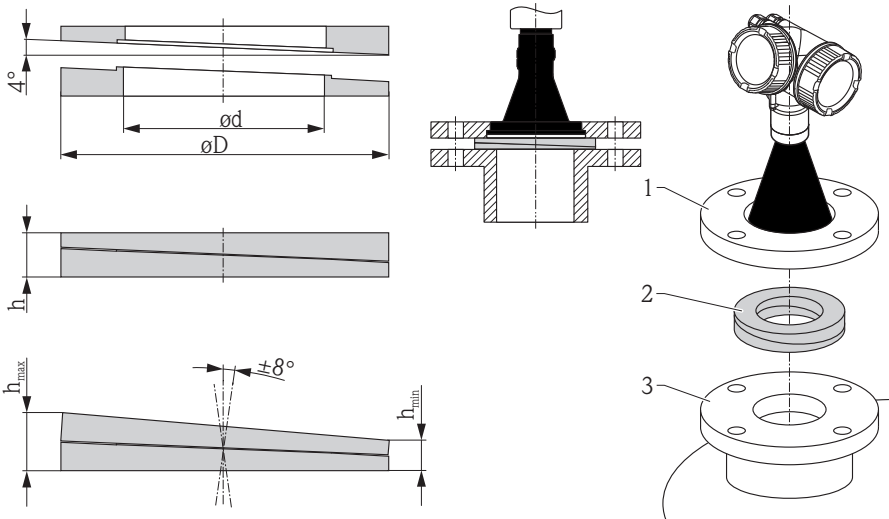
15.1.3 Variable flange seal for FMR50/FMR56

Accessory	Description		
Variable flange seal for FMR50/FMR56	<div style="display: flex; justify-content: space-around;">  </div> <p style="text-align: right; font-size: small;">A0018871</p> <p> 1 UNI slip-on flange 2 Variable flange seal 3 Nozzle </p> <p>  The material and process conditions of the adjustable flange seal must fit the process properties (temperature, pressure, resistance). </p>		
Technical data: DN/JIS version			
Order code	71074263	71074264	71074265
Compatible with	DN80 PN10/40	DN100 PN10/16	<ul style="list-style-type: none"> ■ DN150 PN10/16 ■ JIS 10K 150A
Length of screws	100 mm (3.9 in)	100 mm (3.9 in)	110 mm (4.3 in)
Size of screws	M14	M14	M18
Material	EPDM		
Process pressure	-0.1 to 0.1 bar (-1.45 to 1.45 psi)		
Process temperature	-40 to +80 °C (-40 to +176 °F)		
D	142 mm (5.59 in)	162 mm (6.38 in)	218 mm (8.58 in)
d	89 mm (3.5 in)	115 mm (4.53 in)	169 mm (6.65 in)
h	22 mm (0.87 in)	23.5 mm (0.93 in)	26.5 mm (1.04 in)
h _{min}	14 mm (0.55 in)	14 mm (0.55 in)	14 mm (0.55 in)
h _{max}	30 mm (1.18 in)	33 mm (1.3 in)	39 mm (1.45 in)

Accessory	Description		
	Technical data: ASME/JIS version		
Order code	71249070	71249072	71249073
Compatible with	<ul style="list-style-type: none"> ■ ASME 3" 150lbs ■ JIS 80A 10K 	ASME 4" 150lbs	ASME 6" 150lbs
Length of screws	100 mm (3.9 in)	100 mm (3.9 in)	110 mm (4.3 in)
Recommended screw size	M14	M14	M18
Material	EPDM		
Process pressure	-0.1 to 0.1 bar (-1.45 to 1.45 psi)		
Process temperature	-40 to +80 °C (-40 to +176 °F)		
D	133 mm (5.2 in)	171 mm (6.7 in)	219 mm (8.6 in)
d	89 mm (3.5 in)	115 mm (4.53 in)	168 mm (6.6 in)
h	22 mm (0.87 in)	23.5 mm (0.93 in)	26.5 mm (1.04 in)
h _{min}	14 mm (0.55 in)	14 mm (0.55 in)	14 mm (0.55 in)
h _{max}	30 mm (1.18 in)	33 mm (1.3 in)	39 mm (1.45 in)

15.1.4 Mounting bracket for wall or ceiling mounting of FMR50/FMR56

Accessory	Description
Mounting bracket for wall or ceiling mounting of FMR50/FMR56	<div style="display: flex; align-items: flex-start;"> <div style="margin-right: 20px;"> <p>A</p> </div> <div style="margin-right: 20px;"> <p>B</p> </div> <div> </div> </div> <p>☑ 26 Mounting bracket for FMR50/FMR56 with horn antenna</p> <p>A Mounting at ceiling B Mounting at wall</p> <ul style="list-style-type: none"> ■ Material: <ul style="list-style-type: none"> - Mounting bracket: 304 (1.4301) - Screws: A2 - Nordlock washer: A4 ■ Order code: 71162776

A0017746

15.1.5 Installation bracket for FMR50

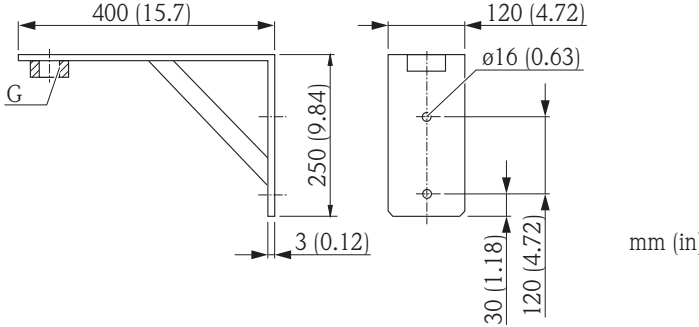
Accessory	Description
Installation bracket for FMR50	<div style="display: flex; align-items: center;">  <div style="margin-left: 20px;"> <p>mm (in)</p> </div> </div> <p style="text-align: right; font-size: small;">A0019206</p> <ul style="list-style-type: none"> ▪ Material: 316Ti (1.4571) ▪ Suited for antenna version ¹⁾: BM: Horn 40mm (1½"), PVDF encapsulated, -40...130°C (-40...266°F) ▪ Suited for process connection ²⁾: <ul style="list-style-type: none"> - GGF: Thread ISO228 G1½, PVDF - RGF: Thread ANSI MNPT1½, PVDF ▪ Order code: 942669-0000 <p>i The mounting bracket has no conductive connection to the transmitter housing. Danger of electrostatic charging. Connect the mounting bracket to the local potential equalization system.</p>

1) Feature 070 of the product structure

2) Feature 100 of the product structure

15.1.6 Remote display FHX50

Accessories	Description
Remote display FHX50	<div style="text-align: center;"> </div> <p style="text-align: right; font-size: small;">A0019128</p> <ul style="list-style-type: none"> ▪ Material: <ul style="list-style-type: none"> - Plastic PBT - 316L/1.4404 ▪ Degree of protection: IP68 / NEMA 6P and IP66 / NEMA 4x ▪ Suitable for display modules: <ul style="list-style-type: none"> - SD02 (push buttons) - SD03 (touch control) ▪ Connecting cable: <ul style="list-style-type: none"> - Cable supplied with device up to 30 m (98 ft) - Standard cable supplied by customer up to 60 m (196 ft) ▪ Ambient temperature range: -40 to 80 °C (-40 to 176 °F) ▪ Ambient temperature range (option): -50 to 80 °C (-58 to 176 °F) ¹⁾ <p> i ▪ If the remote display should be used, order the device version "Prepared for display FHX50" (feature 030, version L or M). For the FHX50, you must select option A: "Prepared for display FHX50" under feature 050 "Measuring device version". </p> <p> i ▪ If the device version "Prepared for display FHX50" was not originally ordered and a FHX50 display is to be retrofitted, you must select version B "Not prepared for display FHX50" under feature 050: "Measuring device version" when ordering the FHX50. In this case, a retrofit kit for the device is supplied with the FHX50. The kit can be used to prepare the device so that the FHX50 can be used. </p> <p> i Use of the FHX50 may be restricted for transmitters with an approval. A device can only be retrofitted with the FHX50 if the option L or M ("Prepared for FHX50") is listed under <i>Basic specifications</i>, item 4 "Display, operation" in the Safety Instructions (XA) for the device. Also pay attention to the Safety Instructions (XA) of the FHX50. </p> <p> i Retrofitting is not possible on transmitters with: <ul style="list-style-type: none"> ▪ An approval for use in areas with flammable dust (dust ignition-proof approval) ▪ Ex nA type of protection </p> <p> i For details, see document SD01007F. </p>

1) This range is valid if option JN "Ambient temperature transmitter -50 °C (-58 °F)" has been selected in ordering feature 580 "Test, Certificate". If the temperature is permanently below -40 °C (-40 °F), failure rates may be increased.

15.1.7 Overvoltage protection

Accessory	Description
Overvoltage protection for 2-wire-devices OVP10 (1 channel) OVP20 (2 channel)	<div data-bbox="327 324 715 660" style="text-align: center;"> </div> <div data-bbox="1380 667 1437 683" style="text-align: right; font-size: small;">A0021734</div> <p>Technical data</p> <ul style="list-style-type: none"> ▪ Resistance per channel: $2 * 0.5 \Omega_{max}$ ▪ Threshold DC voltage: 400 to 700 V ▪ Threshold impulse voltage: < 800 V ▪ Capacitance at 1 MHz: < 1.5 pF ▪ Nominal arrest impulse voltage (8/20 μs): 10 kA ▪ Suited for wire cross-sections: 0.2 to 2.5 mm² (24 to 14 AWG) <p>i Ordering with device The overvoltage protection module is preferably ordered with the device. See product structure, feature 610 "Accessory mounted", option NA "Overvoltage protection". Separate ordering of the module is only necessary if a device is to be retrofitted with the overvoltage protection.</p> <p>i Order code for retrofitting</p> <ul style="list-style-type: none"> ▪ For 1-channel devices (feature 020, option A) OVP10: 71128617 ▪ For 2-channel devices (feature 020, option B, C, E or G) OVP20 : 71128619 <p>Housing lid for retrofitting In order to keep the necessary safety distances, the housing lid needs to be replaced if the device is retrofitted with the overvoltage protection. Depending on the housing type, the order code of the suitable lid is as follows:</p> <ul style="list-style-type: none"> ▪ GT18 housing: Lid 71185516 ▪ GT19 housing: Lid 71185518 ▪ GT20 housing: Lid 71185516 <p>i Restrictions for retrofitting Depending on the approval of the transmitter the usage of the OVP module may be restricted. A device may only be retrofitted with an OVP module if the option NA (overvoltage protection) is quoted under <i>Optional Specifications</i> in the Safety Instructions (XA) pertaining to the device.</p> <p>i For details refer to SD01090F.</p>

15.2 Communication-specific accessories

Accessory	Description
Commubox FXA195 HART	For intrinsically safe HART communication with FieldCare via the USB interface.  For details refer to Technical Information TI00404F

Accessory	Description
Commubox FXA291	Connects Endress+Hauser field devices with CDI interface (= Endress+Hauser Common Data Interface) to the USB interface of a computer. Order code: 51516983  For details refer to Technical Information TI00405C

Accessory	Description
HART Loop Converter HMX50	Evaluates the dynamic HART variables and converts them to analog current signals or limit values. Order code: 71063562  For details refer to Technical Information TI00429F and Operating Instructions BA00371F

Accessory	Description
WirelessHART Adapter SWA70	Connects field devices to a WirelessHART network. The WirelessHART adapter can be mounted directly at a HART device and is easily integrated into an existing HART network. It ensures safe data transmission and can be operated in parallel with other wireless networks.  For details refer to Operating Instructions BA00061S

Accessory	Description
Fieldgate FXA320	Gateway for remote monitoring of connected 4-20mA measuring devices via web browser.  For details refer to Technical Information TI00025S and Operating Instructions BA00053S

Accessory	Description
Fieldgate FXA520	Gateway for remote diagnosis and parametrization of connected HART measuring devices via web browser.  For details refer to Technical Information TI00025S and Operating Instructions BA00051S



Accessory	Description
Field Xpert SFX350	Field Xpert SFX350 is a mobile computer for commissioning and maintenance. It enables efficient device configuration and diagnostics for HART and FOUNDATION fieldbus devices in the non-Ex area .  For details, see Operating Instructions BA01202S

Accessory	Description
Field Xpert SFX370	Field Xpert SFX370 is a mobile computer for commissioning and maintenance. It enables efficient device configuration and diagnostics for HART and FOUNDATION fieldbus devices in the non-Ex area and the Ex area .  For details, see Operating Instructions BA01202S

15.3 Service-specific accessories

Accessory	Description
FieldCare / DeviceCare	Endress+Hauser's FDT-based Plant Asset Management tool. Helps to configure and maintain all field devices of your plant. By supplying status information it also supports the diagnosis of the devices.  For details refer to Operating Instructions BA00027S and BA00059S.





















15.4 System components

























Accessory	Description
Graphic Data Manager Memograph M	The graphic data manager Memograph M provides information on all the relevant process variables. Measured values are recorded correctly, limit values are monitored and measuring points analyzed. The data are stored in the 256 MB internal memory and also on an SD card or USB stick.  For details refer to Technical Information TI00133R and Operating Instructions BA00247R
RN221N	Active barrier with power supply for safe separation of 4 to 20 mA current circuits. Provides bi-directional HART transmission.  For details refer to Technical Information TI00073R and Operating Instructions BA00202R
RNS221	Transmitter supply for 2-wire sensors or transmitters exclusively for non-Ex areas. Provides bi-directional communication using the HART communication sockets.  For details refer to Technical Information TI00081R and Operating Instructions KA00110R

16 Operating menu

16.1 Overview of the operating menu (display module)

Navigation  Operating menu























Language	→  148
Setup	→  106
Device tag	→  106
Distance unit	→  106
Tank type	→  106
Tube diameter	→  107
Medium group	→  107
Empty calibration	→  108
Full calibration	→  108
Level	→  109
Distance	→  109
Signal quality	→  110
Mapping	→  114
Confirm distance	→  114
Mapping end point	→  114
Record map	→  114
Distance	→  114
Prepare recording map	→  114
Advanced setup	→  116
Locking status	→  116
Access status display	→  117

Enter access code	→  117
► Level	→  118
Medium type	→  118
Medium property	→  118
Max. filling speed liquid	→  119
Max. draining speed liquid	→  119
Advanced process conditions	→  119
Level unit	→  120
Blocking distance	→  121
Level correction	→  121
Tank/silo height	→  122
► Linearization	→  124
Linearization type	→  126
Unit after linearization	→  127
Free text	→  128
Maximum value	→  129
Diameter	→  129
Intermediate height	→  129
Table mode	→  130
► Edit table	
Level	→  131
Customer value	→  132
Activate table	→  132
► Safety settings	→  134
Output echo lost	→  134

Value echo lost	→ 134
Ramp at echo lost	→ 135
Blocking distance	→ 121
► SIL/WHG confirmation	→ 137
► Deactivate SIL/WHG	→ 138
Reset write protection	→ 138
Code incorrect	→ 138
► Current output 1 to 2	→ 139
Assign current output	→ 139
Current span	→ 140
Fixed current	→ 140
Damping output	→ 141
Failure mode	→ 141
Failure current	→ 142
Output current 1 to 2	→ 142
► Switch output	→ 143
Switch output function	→ 143
Assign status	→ 143
Assign limit	→ 144
Assign diagnostic behavior	→ 144
Switch-on value	→ 144
Switch-on delay	→ 146
Switch-off value	→ 146
Switch-off delay	→ 146
Failure mode	→ 147

Switch status	→ 147
Invert output signal	→ 147
► Display	→ 148
Language	→ 148
Format display	→ 148
Value 1 to 4 display	→ 150
Decimal places 1 to 4	→ 150
Display interval	→ 150
Display damping	→ 151
Header	→ 151
Header text	→ 152
Separator	→ 152
Number format	→ 152
Decimal places menu	→ 152
Backlight	→ 153
Contrast display	→ 153
► Configuration backup display	→ 154
Operating time	→ 154
Last backup	→ 154

Configuration management	→ 154
Comparison result	→ 155
▶ Administration	→ 157
▶ Define access code	→ 159
Define access code	→ 159
Confirm access code	→ 159
Device reset	→ 157
🔍 Diagnostics	→ 160
Actual diagnostics	→ 160
Previous diagnostics	→ 160
Operating time from restart	→ 161
Operating time	→ 154
▶ Diagnostic list	→ 162
Diagnostics 1 to 5	→ 162
▶ Event logbook	→ 163
Filter options	→ 163
▶ Event list	→ 163
▶ Device information	→ 164
Device tag	→ 164
Serial number	→ 164
Firmware version	→ 164
Device name	→ 164
Order code	→ 165
Extended order code 1 to 3	→ 165
Device revision	→ 165

Device ID	→  165
Device type	→  166
Manufacturer ID	→  166
► Measured values	→  167
Distance	→  109
Level linearized	→  128
Output current 1 to 2	→  142
Measured current 1	→  168
Terminal voltage 1	→  168
Electronic temperature	→  168
► Data logging	→  169
Assign channel 1 to 4	→  169
Logging interval	→  169
Clear logging data	→  170
► Display channel 1 to 4	→  171
► Simulation	→  173
Assign measurement variable	→  174
Value process variable	→  174
Simulation current output 1 to 2	→  174
Value current output 1 to 2	→  175
Switch output simulation	→  175
Switch status	→  175
Simulation device alarm	→  176

Diagnostic event category	
Simulation diagnostic event	
▶ Device check	→ 177
Start device check	→ 177
Result device check	→ 177
Last check time	→ 177
Level signal	→ 178

























16.2 Overview of the operating menu (operating tool)

Navigation



























Operating menu

Setup	→ 106
Device tag	→ 106
Distance unit	→ 106
Tank type	→ 106
Tube diameter	→ 107
Medium group	→ 107
Empty calibration	→ 108
Full calibration	→ 108
Level	→ 109
Distance	→ 109
Signal quality	→ 110
Confirm distance	→ 110
Present mapping	→ 112
Mapping end point	→ 112
Record map	→ 112
▶ Advanced setup	→ 116
Locking status	→ 116
Access status tooling	→ 116
Enter access code	→ 117
▶ Level	→ 118
Medium type	→ 118
Medium property	→ 118
Max. filling speed liquid	→ 119

Max. draining speed liquid	→  119
Advanced process conditions	→  119
Level unit	→  120
Blocking distance	→  121
Level correction	→  121
Tank/silo height	→  122
► Linearization	→  124
Linearization type	→  126
Unit after linearization	→  127
Free text	→  128
Level linearized	→  128
Maximum value	→  129
Diameter	→  129
Intermediate height	→  129
Table mode	→  130
Table number	→  131
Level	→  131
Level	→  132
Customer value	→  132
Activate table	→  132
► Safety settings	→  134
Output echo lost	→  134
Value echo lost	→  134
Ramp at echo lost	→  135
Blocking distance	→  121





▶ SIL/WHG confirmation	→ 137
▶ Deactivate SIL/WHG	→ 138
Reset write protection	→ 138
Code incorrect	→ 138
▶ Current output 1 to 2	→ 139
Assign current output	→ 139
Current span	→ 140
Fixed current	→ 140
Damping output	→ 141
Failure mode	→ 141
Failure current	→ 142
Output current 1 to 2	→ 142
▶ Switch output	→ 143
Switch output function	→ 143
Assign status	→ 143
Assign limit	→ 144
Assign diagnostic behavior	→ 144
Switch-on value	→ 144
Switch-on delay	→ 146
Switch-off value	→ 146
Switch-off delay	→ 146
Failure mode	→ 147
Switch status	→ 147
Invert output signal	→ 147

▶ Display	→ 148
Language	→ 148
Format display	→ 148
Value 1 to 4 display	→ 150
Decimal places 1 to 4	→ 150
Display interval	→ 150
Display damping	→ 151
Header	→ 151
Header text	→ 152
Separator	→ 152
Number format	→ 152
Decimal places menu	→ 152
Backlight	→ 153
Contrast display	→ 153
▶ Configuration backup display	→ 154
Operating time	→ 154
Last backup	→ 154
Configuration management	→ 154
Backup state	→ 155
Comparison result	→ 155
▶ Administration	→ 157
Define access code	→ 159
Device reset	→ 157
🔧 Diagnostics	→ 160
Actual diagnostics	→ 160

Timestamp	→  160
Previous diagnostics	→  160
Timestamp	→  161
Operating time from restart	→  161
Operating time	→  154
▶ Diagnostic list	→  162
Diagnostics 1 to 5	→  162
Timestamp 1 to 5	→  162
▶ Device information	→  164
Device tag	→  164
Serial number	→  164
Firmware version	→  164
Device name	→  164
Order code	→  165
Extended order code 1 to 3	→  165
Device revision	→  165
Device ID	→  165
Device type	→  166
Manufacturer ID	→  166
▶ Measured values	→  167
Distance	→  109
Level linearized	→  128
Output current 1 to 2	→  142
Measured current 1	→  168



Terminal voltage 1	→ 168
Electronic temperature	→ 168
► Data logging	→ 169
Assign channel 1 to 4	→ 169
Logging interval	→ 169
Clear logging data	→ 170
► Simulation	→ 173
Assign measurement variable	→ 174
Value process variable	→ 174
Simulation current output 1 to 2	→ 174
Value current output 1 to 2	→ 175
Switch output simulation	→ 175
Switch status	→ 175
Simulation device alarm	→ 176
Simulation diagnostic event	
► Device check	→ 177
Start device check	→ 177
Result device check	→ 177
Last check time	→ 177
Level signal	→ 178
► Heartbeat	→ 179

16.3 "Setup" menu

-   : Marks the navigation path to the parameter via the display and operating module.
-  : Marks the navigation path to the parameter via an operating tool (e.g. FieldCare).
-  : Marks parameters which can be locked via the software locking →  50.

Navigation   Setup



Device tag 

Navigation   Setup → Device tag

Description Enter the name for the measuring point.

Factory setting FMR5x

Distance unit 

Navigation   Setup → Distance unit



Description Select distance unit.

Selection

<i>SI units</i>	<i>US units</i>
<ul style="list-style-type: none"> ▪ mm ▪ m 	<ul style="list-style-type: none"> ▪ ft ▪ in

Factory setting m

Tank type 

Navigation   Setup → Tank type

Prerequisite **Medium type** (→  118) = **Liquid**

Description Select tank type.

Selection

- Bypass / pipe
- Stilling well
- Workbench test
- Open channel
- Sphere
- Storage vessel

- Process vessel standard
- Process vessel with agitator
- Wave guide antenna

Factory setting Depending on the antenna

Additional information Depending on the antenna some of the options mentioned above may not be available or there may be additional options.

Tube diameter 

Navigation   Setup → Tube diameter

Prerequisite **Tank type** (→  106) = **Bypass / pipe**

Description Specify diameter of bypass or stilling well.

User entry 0 to 9.999 m

Factory setting 0 m

Medium group 



Navigation   Setup → Medium group

Prerequisite **Medium type** (→  118) = **Liquid**

Description Select medium group.

- Selection**
- Others
 - Water based (DC >= 4)

Factory setting Others

Additional information This parameter roughly specifies the dielectric constant (DC) of the medium. For a more detailed definition of the DC use the **Medium property** parameter (→  118).
The **Medium group** parameter presets the **Medium property** parameter (→  118) as follows:

Medium group	Medium property (→  118)
Others	Unknown
Water based (DC >= 4)	DC 4 ... 7

 The **Medium property** parameter can be changed at a later point of time. However, when doing so, the **Medium group** parameter retains its value. Only the **Medium property** parameter is relevant for the signal evaluation.

 The measuring range may be reduced for small dielectric constants. For details refer to the Technical Information (TI) of the respective device.

Empty calibration
**Navigation**

Setup → Empty calibr.

Description

Specify the distance E between the process connection and the minimum level (0%). This defines the starting point of the measuring range.

User entry

Depending on the antenna

Factory setting

Depending on the antenna

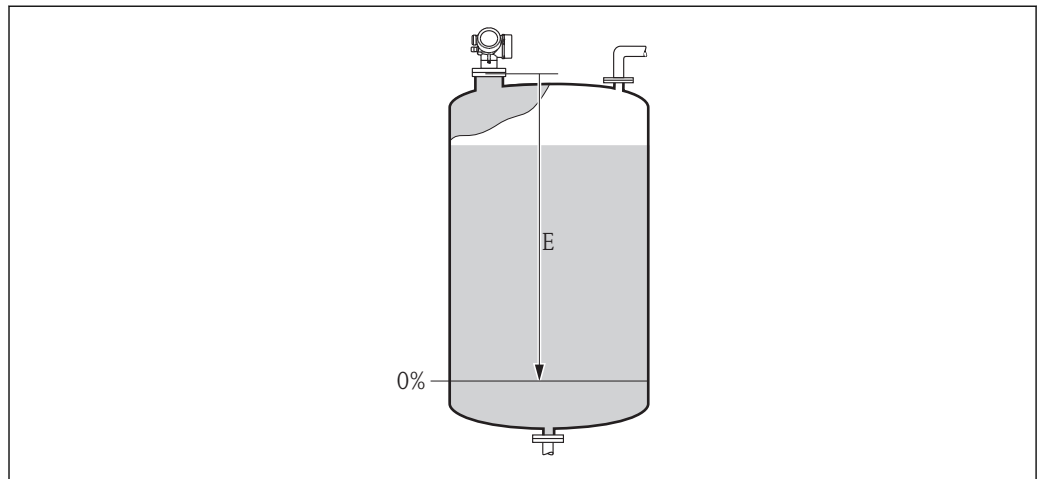
Additional information

A0019466

27 Empty calibration (E) for level measurements in liquids

The measuring range starts at the point at which the radar beam hits the tank or silo bottom. In the case of dished boiler ends or conical outlets levels below this point can not be measured.

Full calibration
**Navigation**

Setup → Full calibr.

Description

Specify the distance F between the minimum level (0%) and the maximum level (100%).

User entry

Depending on the antenna

Factory setting

Depending on the antenna

Additional information

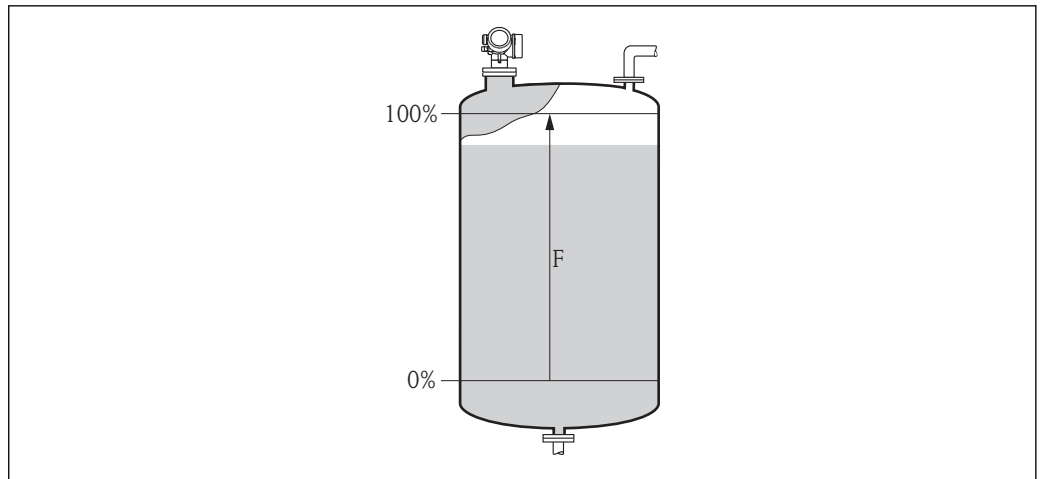

A0019487

28 Full calibration (F) for level measurements in liquids

Level

Navigation

Setup → Level

Description

Displays measured level L (before linearization).

Additional information

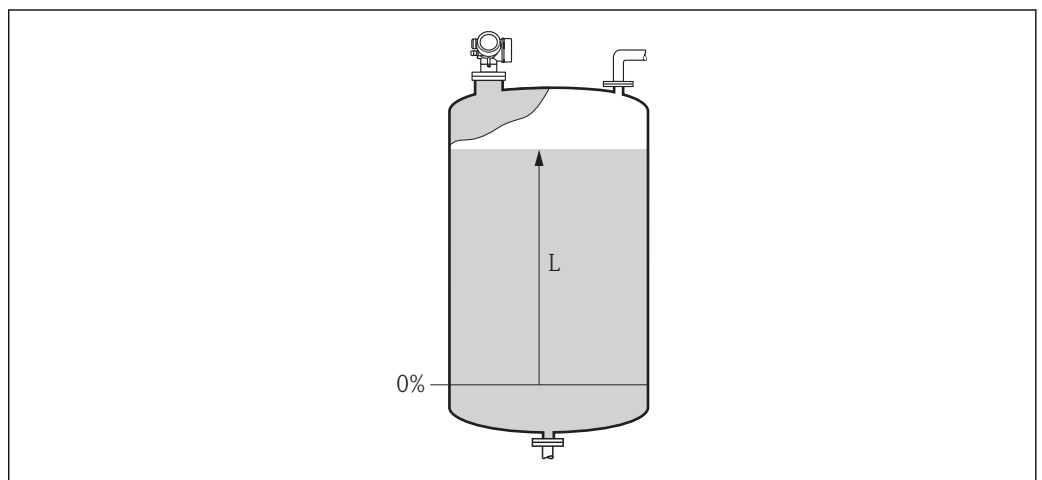

A0019482

29 Level in case of liquid measurements

i The unit is defined in the **Level unit** parameter (→ 120).

Distance

Navigation

Setup → Distance

Description

Displays the measured distance D between the reference point (lower edge of the flange or threaded connection) and the level.

Additional information

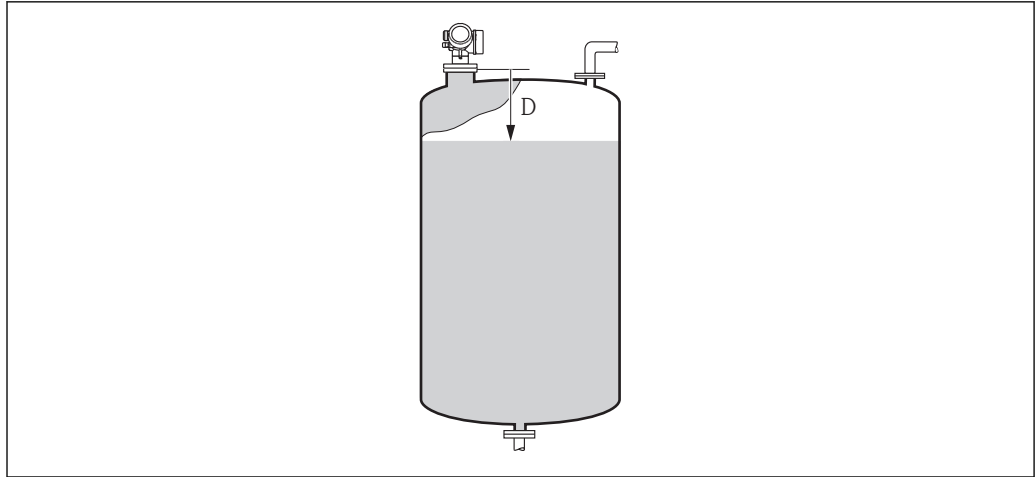

A0019485

30 Distance for liquid measurements

The unit is defined in the **Distance unit** parameter (→ 106).

Signal quality

Navigation

Setup → Signal quality

Description

Displays the signal quality of the level echo.

Additional information

Meaning of the display options

- **Strong**
The evaluated echo exceeds the threshold by at least 10 dB.
- **Medium**
The evaluated echo exceeds the threshold by at least 5 dB.
- **Weak**
The evaluated echo exceeds the threshold by less than 5 dB.
- **No signal**
The device does not find a usable echo.

The signal quality indicated in this parameter always refers to the currently evaluated echo: either the level echo or the tank bottom echo. To differentiate between these two, the quality of the tank bottom echo is always displayed in brackets.

In case of a lost echo (**Signal quality = No signal**) the device generates the following error message:

- F941, for **Output echo lost** (→ 134) = **Alarm**.
- S941, if another option has been selected in **Output echo lost** (→ 134).

Confirm distance

Navigation

Setup → Confirm distance

Description

Specify, whether the measured distance matches the real distance.
Depending on the selection the device automatically sets the range of mapping.

Selection

- Manual map
- Distance ok
- Distance unknown
- Distance too small *
- Distance too big *
- Tank empty
- Factory map

Factory setting

Distance unknown

Additional information**Meaning of the options**

- **Manual map**

To be selected if the range of mapping is to be defined manually in the **Mapping end point** parameter (→  112). In this case it is not necessary to confirm the distance.

- **Distance ok**

To be selected if the measured distance matches the actual distance. The device performs a mapping.

- **Distance unknown**

To be selected if the actual distance is unknown. A mapping can not be performed in this case.

- **Distance too small**

To be selected if the measured distance is smaller than the actual distance. The device searches for the next echo and returns to the **Confirm distance** parameter. The distance is recalculated and displayed. The comparison must be repeated until the displayed distance matches the actual distance. After this, the recording of the map can be started by selecting **Distance ok**.

- **Distance too big** ⁶⁾

To be selected if the measured distance exceeds the actual distance. The device adjusts the signal evaluation and returns to the **Confirm distance** parameter. The distance is recalculated and displayed. The comparison must be repeated until the displayed distance matches the actual distance. After this, the recording of the map can be started by selecting **Distance ok**.

- **Tank empty**

To be selected if the tank is completely empty. The device records a mapping covering the complete measuring range as defined by the **Tank/silo height** parameter (→  122). By default, **Tank/silo height** = **Empty calibration**.

Take into account that in case of conical outlets, for example, a measurement is only possible up to the point at which the radar hits the bottom of the tank or silo. If the **Tank empty** option is used, **Empty calibration** (→  108) and **Tank/silo height** may not reach below this point as otherwise the empty signal is suppressed.

- **Factory map**

To be selected if the present mapping curve (if one exists) is to be deleted. The device returns to the **Confirm distance** parameter and a new mapping can be recorded.



When operating via the display module, the measured distance is displayed together with this parameter for reference purposes.



If the teaching procedure with the **Distance too small** option or the **Distance too big** option is quit before the distance has been confirmed, a map is **not** recorded and the teaching procedure is reset after 60 s.





* Visibility depends on order options or device settings

6) Only available for "Expert → Sensor → Echo tracking → **Evaluation mode** parameter" = "Short time history" or "Long time history"



Present mapping

Navigation	 Setup → Present mapping
Description	Indicates up to which distance a mapping has already been recorded.

Mapping end point

Navigation	 Setup → Map. end point
Prerequisite	Confirm distance (→  110) = Manual map or Distance too small
Description	Specify new end of the mapping.
User entry	0.1 to 999 999.9 m
Factory setting	0.1 m
Additional information	<p>This parameter defines up to which distance the new mapping is to be recorded. The distance is measured from the reference point, i.e. from the lower edge of the mounting flange or the threaded connection.</p> <p> For reference purposes the Present mapping parameter (→  112) is displayed together with this parameter. It indicates up to which distance a mapping has already been recorded.</p>

Record map

Navigation	 Setup → Record map
Prerequisite	Confirm distance (→  110) = Manual map or Distance too small
Description	Start recording of the map.
Selection	<ul style="list-style-type: none"> ■ No ■ Record map ■ Overlay map ■ Factory map ■ Delete partial map
Factory setting	No

Additional information**Meaning of the options****■ No**

The map is not recorded.

■ Record map

The map is recorded. After the recording is completed, the new measured distance and the new mapping range appear on the display. When operating via the local display, these values must be confirmed by pressing .

■ Overlay map

The new mapping curve is generated by overlaying the old and the current envelope curves.



■ Factory map

The factory map stored in the ROM of the device is used.

■ Delete partial map

The mapping curve is deleted up to **Mapping end point** (→  112).

16.3.1 "Mapping" wizard

 The **Mapping** wizard is only available when operating via the local display. When operating via an operating tool, all parameters concerning the mapping are located directly in the **Setup** menu (→  106).

 In the **Mapping** wizard two parameters are displayed simultaneously on the display module at any one time. The upper parameter can be edited, whereas the lower parameter is displayed for reference purposes only.

Navigation  Setup → Mapping

Confirm distance

Navigation  Setup → Mapping → Confirm distance

Description →  110

Mapping end point

Navigation  Setup → Mapping → Map. end point

Description →  112

Record map

Navigation  Setup → Mapping → Record map

Description →  112

Distance

Navigation  Setup → Mapping → Distance

Description →  109

Prepare recording map

Navigation  Setup → Mapping → Prepare rec. map

Description Indicates the progress of the recording of the map.





User interface

- Init. recording
- In progress
- Finished





16.3.2 "Advanced setup" submenu

Navigation  Setup → Advanced setup







Locking status

Navigation	  Setup → Advanced setup → Locking status
Description	Indicates the write protection with the highest priority that is currently active.
User interface	<ul style="list-style-type: none"> ▪ Hardware locked ▪ SIL locked ▪ WHG locked ▪ Temporarily locked
Additional information	<p>Meaning and priorities of the types of write protection</p> <ul style="list-style-type: none"> ▪ Hardware locked (priority 1) The DIP switch for hardware locking is activated on the main electronics module. This locks write access to the parameters. ▪ SIL locked (priority 2) The SIL mode is activated. Writing access to the relevant parameters is denied. ▪ WHG locked (priority 3) The WHG mode is activated. Writing access to the relevant parameters is denied. ▪ Temporarily locked (priority 4) Write access to the parameters is temporarily locked on account of internal processes in progress in the device (e.g. data upload/download, reset etc.). The parameters can be modified as soon as the processes are complete. <p> On the display module, the -symbol appears in front of parameters that cannot be modified since they are write-protected.</p>







Access status tooling

Navigation	 Setup → Advanced setup → Access stat.tool
Description	Indicates access authorization to parameters via operating tool (e.g. FieldCare).
User interface	<ul style="list-style-type: none"> ▪ Operator ▪ Maintenance ▪ Service
Additional information	<p> The access authorization can be changed via the Enter access code parameter (→  117).</p> <p> If additional write protection is active, this restricts the current access authorization even further. The write protection status can be viewed via the Locking status parameter (→  116).</p>

Access status display

Navigation	 Setup → Advanced setup → Access stat.disp
Prerequisite	The device has a local display.
Description	Indicates access authorization to parameters via local display.
User interface	<ul style="list-style-type: none"> ▪ Operator ▪ Maintenance ▪ Service
Additional information	<p> If a  symbol appears in front of a parameter, the parameter cannot be changed via the local display with the current access authorization.</p> <p> The access authorization can be changed via the Enter access code parameter (→  117).</p> <p> If additional write protection is active, this restricts the current access authorization even further. The write protection status can be viewed via the Locking status parameter (→  116).</p>

Enter access code

Navigation	  Setup → Advanced setup → Ent. access code
Description	Enter access code to disable write protection of parameters.
User entry	0 to 9999
Additional information	<ul style="list-style-type: none"> ▪ For local operation, the customer-specific access code, which has been defined in the Define access code parameter (→  157), has to be entered. ▪ If an incorrect access code is entered, the user retains his current access authorization. ▪ The write protection affects all parameters marked with the -symbol in this document. On the local display, the -symbol in front of a parameter indicates that the parameter is write-protected. ▪ If no key is pressed for 10 min, or the user switches from the navigation and editing mode back to the measured value display mode, the device automatically locks the write-protected parameters after another 60 s. <p> Please contact your Endress+Hauser Sales Center if you lose your access code.</p>

"Level" submenu

Navigation  Setup → Advanced setup → Level

Medium type 

Navigation  Setup → Advanced setup → Level → Medium type

Description Specify type of medium.

User interface

- Liquid
- Solid

Factory setting FMR50, FMR51, FMR52, FMR53, FMR54: **Liquid**

Additional information  This parameter determines the value of several other parameters and strongly influences the complete signal evaluation. Therefore, it is strongly recommended **not to change** the factory setting.



Medium property 

Navigation  Setup → Advanced setup → Level → Medium property



Description Specify relative dielectric constant ϵ_r of the medium.

Selection

- Unknown
- DC 1.4 ... 1.6
- DC 1.6 ... 1.9
- DC 1.9 ... 2.5
- DC 2.5 ... 4
- DC 4 ... 7
- DC 7 ... 15
- DC > 15

Factory setting Dependent on **Medium type** (→  118) and **Medium group** (→  107).

Additional information *Dependency on "Medium type" and "Medium group"*





Medium type (→  118)	Medium group (→  107)	Medium property
Solid		Unknown
Liquid	Water based (DC >= 4)	DC 4 ... 7
	Others	Unknown

 For dielectric constants (DC values) of many media commonly used in various industries refer to:

- the Endress+Hauser DC manual (CP01076F)
- the Endress+Hauser "DC Values App" (available for Android and iOS)







Max. filling speed liquid



Navigation	 Setup → Advanced setup → Level → Max. fill liquid
Prerequisite	Medium type (→  118) = Liquid
Description	Select expected maximum filling speed.
Selection	<ul style="list-style-type: none"> ■ Slow < 1cm (0,4in) /min ■ Medium < 10cm (4in) /min ■ Standard < 1m (40in) /min ■ Fast < 2m (80in) /min ■ Very fast > 2m (80in) /min ■ No filter / test
Factory setting	Depending on the Tank type parameter (→  106)
Additional information	Max. filling speed liquid is preset by Tank type (→  106). It can, however, be adjusted to the process in the vessel at any time. If Tank type (→  106) is changed again at a later point of time, it may be necessary to repeat the fine adjustment.

Max. draining speed liquid





Navigation	 Setup → Advanced setup → Level → Max drain liquid
Prerequisite	Medium type (→  118) = Liquid
Description	Select expected maximum draining speed.
Selection	<ul style="list-style-type: none"> ■ Slow < 1cm (0,4in) /min ■ Medium < 10cm (4in) /min ■ Standard < 1m (40in) /min ■ Fast < 2m (80in) /min ■ Very fast > 2m (80in) /min ■ No filter / test
Factory setting	Depending on the Tank type parameter (→  106)
Additional information	Max. draining speed liquid (→  119) is preset by Tank type (→  106). It can, however, be adjusted to the process in the vessel at any time. If Tank type (→  106) is changed again at a later point of time, it may be necessary to repeat the fine adjustment.





Advanced process conditions



Navigation	 Setup → Advanced setup → Level → Adv. conditions
Description	Specify additional process conditions (if required).

Selection	<ul style="list-style-type: none"> ■ Foam (>5cm/0,16ft) ■ Changing DC values ■ Small tanks (< 1m/3ft)
Factory setting	None
Additional information	<p><i>"Foam (>5cm/0,16ft)" option</i></p> <p>This option makes sure that no tank history is used which has been recorded while foam was present at the surface and thus is no reliable map of the tank property. To achieve this, the setting Evaluation mode = Long time history is deactivated.</p> <p> The Foam (>5cm/0,16ft) option is only available for liquid applications (FMR50, FMR51, FMR52, FMR53, FMR54).</p> <p><i>"Changing DC values" option</i></p> <p>A tank history which has been recorded with Evaluation mode = Long time history is only valid for a fixed dielectric constant. The Changing DC values option disables the setting Evaluation mode = Long time history and thus avoids wrong measuring values in the case of a changing dielectric constant.</p> <p> The Changing DC values option is only available for liquid applications (FMR50, FMR51, FMR52, FMR53, FMR54).</p> <p><i>"Small tanks (< 1m/3ft)" option</i></p> <p>This option provides a simple possibility to reduce the echo width of the sensor module. This enables an improved detection of superimposed echos - especially in the near field. Internally, all parameters related to the echo width are adjusted by this option.</p> <p> The Small tanks (< 1m/3ft) option is only available for liquid measurements with 26 GHz HF module (FMR50, FMR51, FMR52).</p>

Level unit

Navigation	  Setup → Advanced setup → Level → Level unit	
Description	Select level unit.	
Selection	<i>SI units</i> <ul style="list-style-type: none"> ■ % ■ m ■ mm 	<i>US units</i> <ul style="list-style-type: none"> ■ ft ■ in
Factory setting	%	
Additional information	<p>The level unit may differ from the distance unit defined in the Distance unit parameter (→  106):</p> <ul style="list-style-type: none"> ■ The unit defined in the Distance unit parameter is used for the basic calibration (Empty calibration (→  108) and Full calibration (→  108)). ■ The unit defined in the Level unit parameter is used to display the (nonlinearized) level. 	

Blocking distance

Navigation	Setup → Advanced setup → Level → Blocking dist.
Description	Specify blocking distance BD.
User entry	0 to 200 m
Factory setting	FMR50, FMR51, FMR53, FMR54: antenna length
Additional information	<p>Signals in the blocking distance are only evaluated if they have been outside the blocking distance when the device was switched on and move into the blocking distance due to a level change during operation. Signals which are already in the blocking distance when the device is switched on, are ignored.</p> <p> This behavior is only valid if the following two conditions are met:</p> <ul style="list-style-type: none"> ▪ Expert → Sensor → Echo tracking → Evaluation mode = Short time history or Long time history) ▪ Expert → Sensor → Gas phase comp. → GPC mode= On, Without correction or External correction <p>If one of these conditions is not met, signals in the blocking distance will always be ignored.</p> <p> If required, a different behavior for signals in the blocking distance can be defined by the Endress+Hauser service.</p>

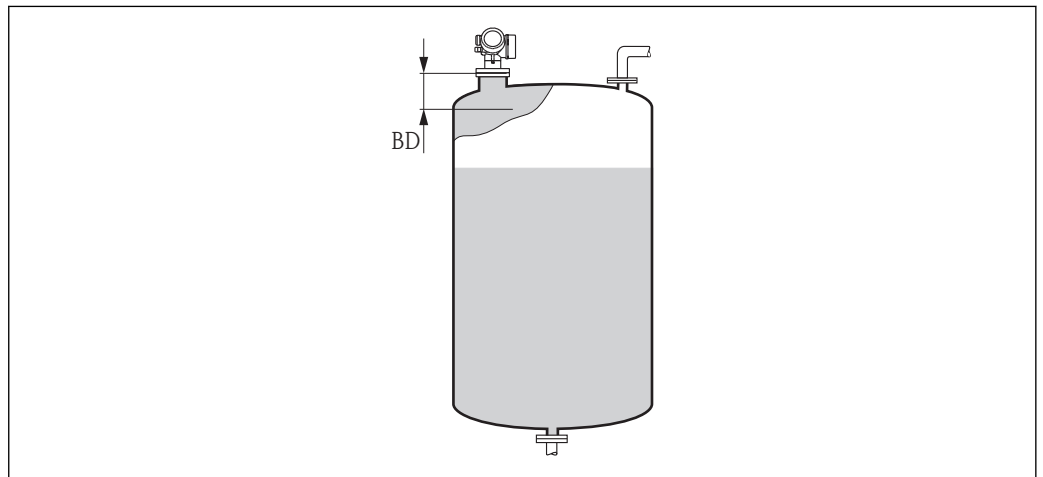

A0019492

31 Blocking distance (BD) for liquid measurements

Level correction

Navigation	Setup → Advanced setup → Level → Level correction
Description	Specify level correction (if required).
User entry	-200 000.0 to 200 000.0 %
Factory setting	0.0 %

Additional information The value specified in this parameter is added to the measured level (before linearization).

Tank/silo height 🔗

Navigation 🏠📄 Setup → Advanced setup → Level → Tank/silo height

Description Specify total height of the tank or silo as measured from the process connection.

User entry -999.9999 to 999.9999 m

Factory setting **Empty calibration** (→ 📄 108)

Additional information If the parametrized measuring range (**Empty calibration** (→ 📄 108)) differs significantly from the tank or silo height, it is recommended to enter the tank or silo height. Example: Continuous level monitoring in the upper third of a tank or silo.

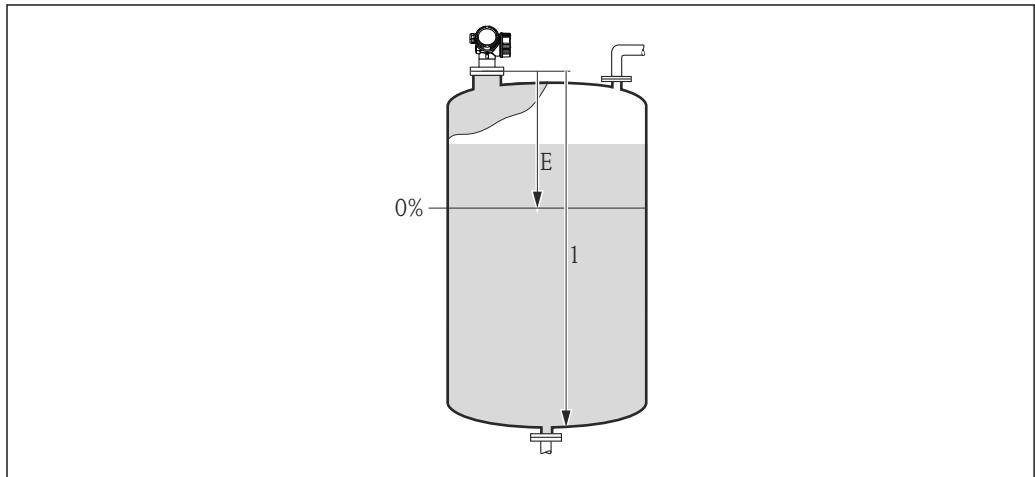

A0019867

📄 32 "Tank/silo height" parameter (→ 📄 122) for measurements in liquids

E Empty calibration (→ 📄 108)

1 Tank/silo height (→ 📄 122)

i For tanks with conical outlet, **Tank/silo height** should not be changed as in this type of applications **Empty calibration** (→ 📄 108) is usually **not** \ll the tank or silo height.

"Linearization" submenu

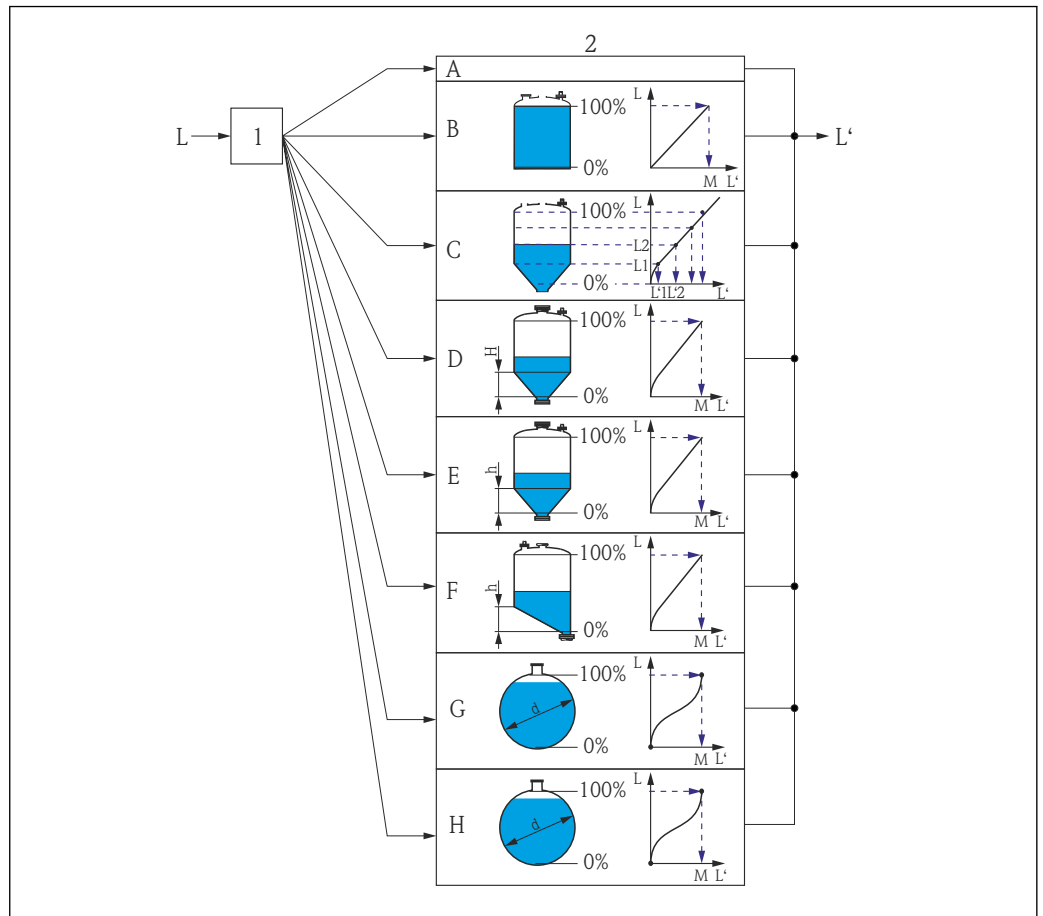











A0019648

33 Linearization: Transformation of the level and (if relevant) the interface height into a volume or weight; the transformation is dependent on the shape of the vessel.

- 1 Selection of linearization type and unit
- 2 Configuration of the linearization
- A Linearization type (→ 126) = None
- B Linearization type (→ 126) = Linear
- C Linearization type (→ 126) = Table
- D Linearization type (→ 126) = Pyramid bottom
- E Linearization type (→ 126) = Conical bottom
- F Linearization type (→ 126) = Angled bottom
- G Linearization type (→ 126) = Horizontal cylinder
- H Linearization type (→ 126) = Sphere
- L Level before linearization (measured in distance units)
- L' Level linearized (→ 128) (corresponds to volume or weight)
- M Maximum value (→ 129)
- d Diameter (→ 129)
- h Intermediate height (→ 129)













Structure of the submenu on the display module

Navigation  Setup → Advanced setup → Linearization

► Linearization	
Linearization type	→  126
Unit after linearization	→  127
Free text	→  128
Maximum value	→  129
Diameter	→  129
Intermediate height	→  129
Table mode	→  130
► Edit table	
Level	→  131
Customer value	→  132
Activate table	→  132

Structure of the submenu in an operating tool (e.g. FieldCare)

Navigation  Setup → Advanced setup → Linearization

► Linearization	
Linearization type	→  126
Unit after linearization	→  127
Free text	→  128
Level linearized	→  128
Maximum value	→  129
Diameter	→  129
Intermediate height	→  129
Table mode	→  130
Table number	→  131
Level	→  131
Level	→  132
Customer value	→  132
Activate table	→  132

Description of parameters

Navigation  Setup → Advanced setup → Linearization

Linearization type 

Navigation  Setup → Advanced setup → Linearization → Lineariz. type

Description Select linearization type.

- Selection**
- None
 - Linear
 - Table
 - Pyramid bottom
 - Conical bottom
 - Angled bottom
 - Horizontal cylinder
 - Sphere

Factory setting None

Additional information

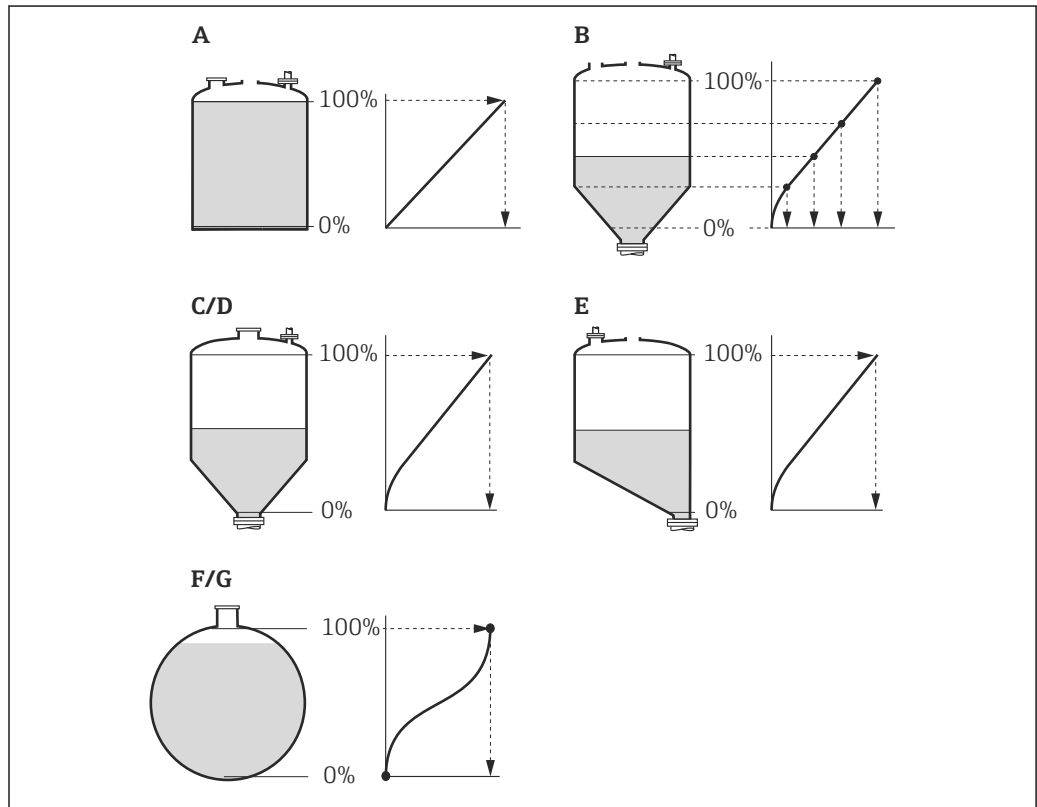

A0021476

 34 *Linearization types*



- A *None*
- B *Table*
- C *Pyramid bottom*
- D *Conical bottom*
- E *Angled bottom*
- F *Sphere*
- G *Horizontal cylinder*

Meaning of the options■ **None**

The level is transmitted in the level unit without linearization.





■ **Linear**

The output value (volume/weight) is directly proportional to the level L. This is valid, for example, for vertical cylinders. The following additional parameters have to be specified:

- **Unit after linearization** (→  127)
- **Maximum value** (→  129): Maximum volume or weight



■ **Table**

The relationship between the measured level L and the output value (volume/weight) is given by a linearization table consisting of up to 32 pairs of values "level - volume" or "level - weight", respectively. The following additional parameters have to be specified:

- **Unit after linearization** (→  127)
- **Table mode** (→  130)
- For each table point: **Level** (→  131)
- For each table point: **Customer value** (→  132)
- **Activate table** (→  132)



■ **Pyramid bottom**

The output value corresponds to the volume or weight in a silo with pyramid bottom. The following additional parameters have to be specified:

- **Unit after linearization** (→  127)
- **Maximum value** (→  129): Maximum volume or weight
- **Intermediate height** (→  129): The height of the pyramid



■ **Conical bottom**

The output value corresponds to the volume or weight in a tank with conical bottom. The following additional parameters have to be specified:

- **Unit after linearization** (→  127)
- **Maximum value** (→  129): Maximum volume or weight
- **Intermediate height** (→  129): The height of the conical part of the tank



■ **Angled bottom**

The output value corresponds to the volume or weight in a silo with an angled bottom. The following additional parameters have to be specified:

- **Unit after linearization** (→  127)
- **Maximum value** (→  129): Maximum volume or weight
- **Intermediate height** (→  129): Height of the angled bottom



■ **Horizontal cylinder**

The output value corresponds to the volume or weight in a horizontal cylinder. The following additional parameters have to be specified:



- **Unit after linearization** (→  127)
- **Maximum value** (→  129): Maximum volume or weight
- **Diameter** (→  129)

■ **Sphere**

The output value corresponds to the volume or weight in a spherical tank. The following additional parameters have to be specified:

- **Unit after linearization** (→  127)
- **Maximum value** (→  129): Maximum volume or weight
- **Diameter** (→  129)

Unit after linearization**Navigation**

  Setup → Advanced setup → Linearization → Unit lineariz.

Prerequisite

Linearization type (→  126) ≠ None



Description

Select unit of the linearized value.



Selection	<i>SI units</i> <ul style="list-style-type: none"> ■ STon ■ t ■ kg ■ cm³ ■ dm³ ■ m³ ■ hl ■ l ■ % <i>Custom-specific units</i> Free text	<i>US units</i> <ul style="list-style-type: none"> ■ lb ■ UsGal ■ ft³ 	<i>Imperial units</i> impGal
------------------	---	---	---------------------------------

Factory setting %

Additional information The selected unit is only used to be indicated on the display. The measured value is **not** transformed according to the selected unit.

 It is also possible to configure a distance-to-distance linearization, i.e. a transformation from the level unit to a different distance unit. To do so, select the **Linear** linearization mode. In order to define the new level unit, select the **Free text** option in the **Unit after linearization** parameter and enter the required unit into the **Free text** parameter (→  128).

Free text 

Navigation   Setup → Advanced setup → Linearization → Free text

Prerequisite **Unit after linearization** (→  127) = **Free text**

Description Enter unit symbol.

User entry Up to 32 alphanumerical characters (letters, numbers, special characters)

Factory setting Free text

Level linearized



Navigation  Setup → Advanced setup → Linearization → Level linearized

Description Displays linearized level.

Additional information  The unit is defined by the **Unit after linearization** parameter →  127.



Maximum value



Navigation	 Setup → Advanced setup → Linearization → Maximum value
Prerequisite	Linearization type (→  126) has one of the following values: <ul style="list-style-type: none"> ■ Linear ■ Pyramid bottom ■ Conical bottom ■ Angled bottom ■ Horizontal cylinder ■ Sphere
Description	Specify the maximum content of the vessel (100%) measured in the units after linearization.
User entry	-50 000.0 to 50 000.0 %
Factory setting	100.0 %



Diameter



Navigation	 Setup → Advanced setup → Linearization → Diameter
Prerequisite	Linearization type (→  126) has one of the following values: <ul style="list-style-type: none"> ■ Horizontal cylinder ■ Sphere
Description	Specify tank diameter.
User entry	0 to 9 999.999 m
Factory setting	2 m
Additional information	The unit is defined in the Distance unit parameter (→  106).

Intermediate height



Navigation	 Setup → Advanced setup → Linearization → Intermed. height
Prerequisite	Linearization type (→  126) has one of the following values: <ul style="list-style-type: none"> ■ Pyramid bottom ■ Conical bottom ■ Angled bottom
Description	Specify intermediate height H.
User entry	0 to 200 m
Factory setting	0 m

Additional information

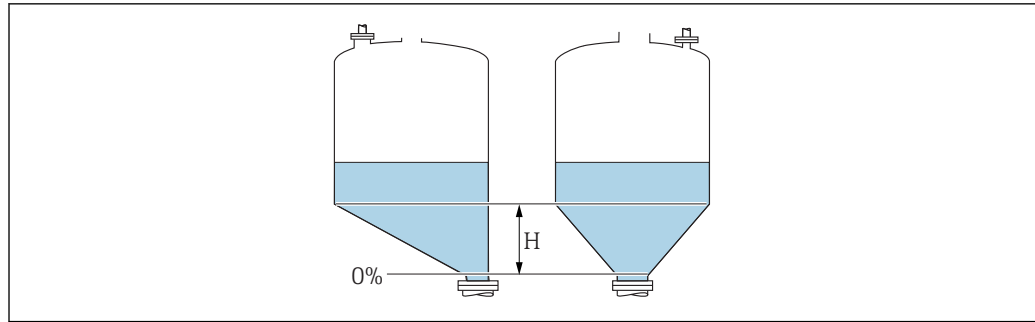

A0013264

H Intermediate height

The unit is defined in the **Distance unit** parameter (→ [106](#)).

Table mode



Navigation

Setup → Advanced setup → Linearization → Table mode

Prerequisite

Linearization type (→ [126](#)) = Table

Description

Select editing mode of the linearization table.

Selection

- Manual
- Semiautomatic *
- Clear table
- Sort table

Factory setting

Manual

Additional information



Meaning of the options

- **Manual**
The level and the associated linearized value are entered manually for each linearization point.
- **Semiautomatic**
The level is measured by the device for each linearization point. The associated linearized value is entered manually.
- **Clear table**
Deletes the existing linearization table.
- **Sort table**
Rearranges the linearization points into an ascending order.

* Visibility depends on order options or device settings



Conditions the linearization table must meet:



- The table may consist of up to 32 pairs of values "Level - Linearized Value".
- The table must be monotonic (monotonically increasing or decreasing).
- The first linearization point must refer to the minimum level.
- The last linearization point must refer to the maximum level.

 Before entering a linearization table, the values for **Empty calibration** (→  108) and **Full calibration** (→  108) must be set correctly.

If values of the table need to be changed after the full or empty calibration have been changed, a correct evaluation is only ensured if the existing table is deleted and the complete table is entered again. To do so delete the existing table (**Table mode** (→  130) = **Clear table**). Then enter a new table.

How to enter the table

- Via FieldCare
The table points can be entered via the **Table number** (→  131), **Level** (→  131) and **Customer value** (→  132) parameters. As an alternative, the graphic table editor may be used: Device Operation → Device Functions → Additional Functions → Linearization (Online/Offline)
- Via local display
Select the **Edit table** submenu to call up the graphic table editor. The table is displayed and can be edited line by line.

 The factory setting for the level unit is "%". If you want to enter the linearization table in physical units, you must select the appropriate unit in the **Level unit** parameter (→  120) beforehand.











 If a decreasing table is entered, the values for 20 mA and 4 mA of the current output are interchanged. That means: 20 mA refers to the lowest level, whereas 4 mA refers to the highest level. If required, the current output can be inverted in the **Measuring mode** parameter.

Table number		
Navigation	 Setup → Advanced setup → Linearization → Table number	
Prerequisite	Linearization type (→  126) = Table	
Description	Select table point you are going to enter or change.	
User entry	1 to 32	
Factory setting	1	



Level (Manual)		
Navigation	 Setup → Advanced setup → Linearization → Level	
Prerequisite	<ul style="list-style-type: none"> ▪ Linearization type (→  126) = Table ▪ Table mode (→  130) = Manual 	

Description	Enter level value of the table point (value before linearization).
User entry	Signed floating-point number
Factory setting	0 %



Level (Semiautomatic)

Navigation	 Setup → Advanced setup → Linearization → Level
Prerequisite	<ul style="list-style-type: none"> ▪ Linearization type (→  126) = Table ▪ Table mode (→  130) = Semiautomatic
Description	Displays measured level (value before linearization). This value is transmitted to the table.

Customer value

Navigation	 Setup → Advanced setup → Linearization → Customer value
Prerequisite	Linearization type (→  126) = Table
Description	Enter linearized value for the table point.
User entry	Signed floating-point number
Factory setting	0 %

Activate table

Navigation	  Setup → Advanced setup → Linearization → Activate table
Prerequisite	Linearization type (→  126) = Table
Description	Activate (enable) or deactivate (disable) the linearization table.
Selection	<ul style="list-style-type: none"> ▪ Disable ▪ Enable
Factory setting	Disable

Additional information**Meaning of the options****■ Disable**

The measured level is not linearized.

If **Linearization type** (→  **126**) = **Table** at the same time, the device issues error message F435.

■ Enable

The measured level is linearized according to the table.



When editing the table, the **Activate table** parameter is automatically reset to **Disable** and must be reset to **Enable** after the table has been entered.

"Safety settings" submenu

Navigation  Setup → Advanced setup → Safety sett.

Output echo lost **Navigation**

 Setup → Advanced setup → Safety sett. → Output echo lost

Description

Define the behavior of the output signal in case of a lost echo.



Selection

- Last valid value
- Ramp at echo lost
- Value echo lost
- Alarm

Factory setting

Last valid value

Additional information**Meaning of the options**

- **Last valid value**
The last valid value is kept in the case of a lost echo.
- **Ramp at echo lost**
In the case of a lost echo the output value is continuously shifted towards 0% or 100%.
The slope of the ramp is defined in the **Ramp at echo lost** parameter (→  135).
- **Value echo lost**
In the case of a lost echo the output assumes the value defined in the **Value echo lost** parameter (→  134).
- **Alarm**
In the case of a lost echo the device generates an alarm; see the **Failure mode** parameter (→  141)

Value echo lost **Navigation**

 Setup → Advanced setup → Safety sett. → Value echo lost

Prerequisite

Output echo lost (→  134) = **Value echo lost**

Description

Define output value in case of a lost echo.

User entry



0 to 200 000.0 %

Factory setting

0.0 %

Additional information

Use the unit which has been defined for the measured value output:

- without linearization: **Level unit** (→  120)
- with linearization: **Unit after linearization** (→  127)

Ramp at echo lost

Navigation Setup → Advanced setup → Safety sett. → Ramp echo lost

Prerequisite **Output echo lost (→ 134) = Ramp at echo lost**

Description Define the slope of the ramp in the case of a lost echo.

User entry Signed floating-point number

Factory setting 0.0 %/min

Additional information

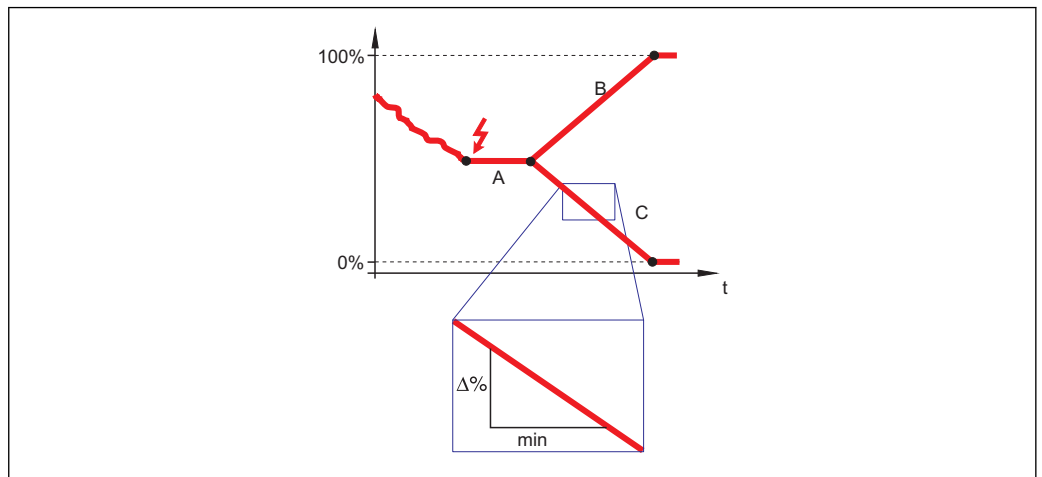

A0013269

- A *Delay time echo lost*
 B *Ramp at echo lost (→ 135) (positive value)*
 C *Ramp at echo lost (→ 135) (negative value)*

- The unit for the slope of the ramp is "percentage of the measuring range per minute" (%/min).
- For a negative slope of the ramp: The measured value is continuously decreased until it reaches 0%.
- For a positive slope of the ramp: The measured value is continuously increased until it reaches 100%.

Blocking distance

Navigation Setup → Advanced setup → Safety sett. → Blocking dist.

Description Specify blocking distance BD.

User entry 0 to 200 m

Factory setting FMR50, FMR51, FMR53, FMR54: antenna length

Additional information Signals in the blocking distance are only evaluated if they have been outside the blocking distance when the device was switched on and move into the blocking distance due to a

level change during operation. Signals which are already in the blocking distance when the device is switched on, are ignored.

- i** This behavior is only valid if the following two conditions are met:
- Expert → Sensor → Echo tracking → Evaluation mode = **Short time history** or **Long time history**)
 - Expert → Sensor → Gas phase comp. → GPC mode= **On, Without correction** or **External correction**

If one of these conditions is not met, signals in the blocking distance will always be ignored.

- i** If required, a different behavior for signals in the blocking distance can be defined by the Endress+Hauser service.

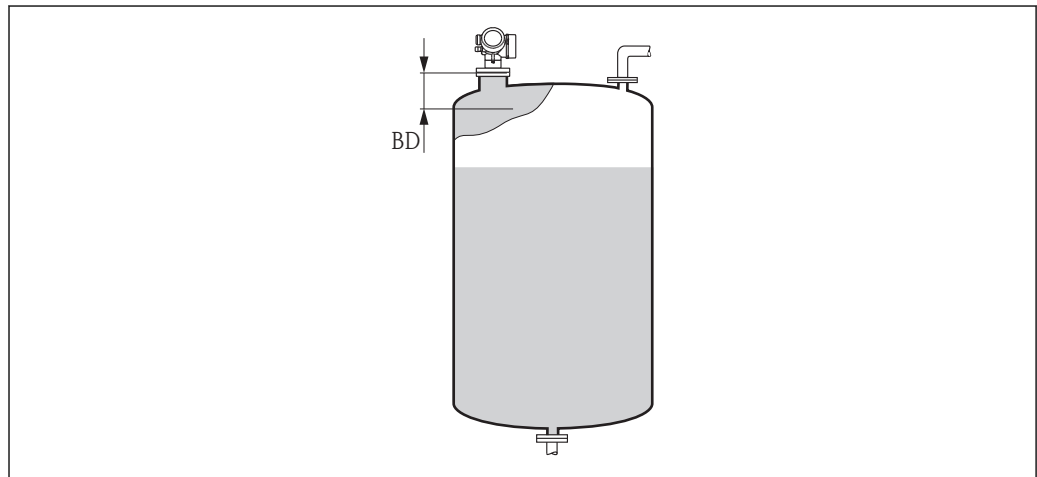

A0019492

35 Blocking distance (BD) for liquid measurements

"SIL/WHG confirmation" wizard

The **SIL/WHG confirmation** wizard is only available for devices with SIL or WHG approval (Feature 590: "Additional Approval", option LA: "SIL" or LC: "WHG overflow prevention") which are currently **not** in the SIL- or WHG-locked state.

The **SIL/WHG confirmation** wizard is required to lock the device according to SIL or WHG. For details refer to the "Functional Safety Manual" of the respective device, which describes the locking procedure and the parameters of the sequence.

Navigation



Setup → Advanced setup → SIL/WHG confirm.

"Deactivate SIL/WHG" wizard

Navigation  Setup → Advanced setup → Deactiv. SIL/WHG



Reset write protection



Navigation	 Setup → Advanced setup → Deactiv. SIL/WHG → Res. write prot.
Description	Enter unlocking code.
User entry	0 to 65 535
Factory setting	0

Code incorrect

Navigation	 Setup → Advanced setup → Deactiv. SIL/WHG → Code incorrect
Description	Indicates that a wrong unlocking code has been entered. Select procedure.
Selection	<ul style="list-style-type: none"> ■ Reenter code ■ Abort sequence
Factory setting	Reenter code

"Current output 1 to 2" submenu

 The **Current output 2** submenu (→  139) is only available for devices with two current outputs.

Navigation   Setup → Advanced setup → Curr.output 1 to 2

Assign current output 1 to 2 

Navigation   Setup → Advanced setup → Curr.output 1 to 2 → Assign curr.



Description Select process variable for current output.

- Selection**
- Level linearized
 - Distance
 - Electronic temperature
 - Relative echo amplitude
 - Analog output adv. diagnostics 1
 - Analog output adv. diagnostics 2
 - Area of incoupling

- Factory setting**
- Current output 1: Level linearized
 - Current output 2 ⁷⁾: Relative echo amplitude

Additional information *Definition of the current range for the process variables*

Process variable	4 mA value	20 mA value
Level linearized	0 % ¹⁾ or the associated linearized value	100 % ²⁾ or the associated linearized value
Distance	0 (i.e. level is at the reference point)	Empty calibration (→  108) (i.e. level is at 0 %)
Electronic temperature	-50 °C (-58 °F)	100 °C (212 °F)
Relative echo amplitude	0 dB	150 dB
Analog output adv. diagnostics 1/2	depending on the parametrization of the Advanced Diagnostics	
Area of incoupling	0	100

- 1) the 0% level is defined by **Empty calibration** parameter (→  108)
- 2) The 100% level is defined by **Full calibration** parameter (→  108)

 It may be necessary to adjust the 4mA and 20mA values to the application (especially in the case of the **Analog output adv. diagnostics 1/2** and **Area of incoupling** options).

This can be done by the following parameters:

- Expert → Output → Curr.output 1 to 2 → Turn down
- Expert → Output → Curr.output 1 to 2 → 4 mA value
- Expert → Output → Curr.output 1 to 2 → 20 mA value

7) only for devices with two current outputs

Current span



Navigation Setup → Advanced setup → Curr.output 1 to 2 → Current span

Description Select current range for process variable and alarm signal.

- Selection**
- 4...20 mA
 - 4...20 mA NAMUR
 - 4...20 mA US
 - Fixed current

Factory setting 4...20 mA NAMUR

Additional information *Meaning of the options*

Option	Current range for process variable	Lower alarm signal level	Upper alarm signal level
4...20 mA	4 to 20.5 mA	< 3.6 mA	> 21.95 mA
4...20 mA NAMUR	3.8 to 20.5 mA	< 3.6 mA	> 21.95 mA
4...20 mA US	3.9 to 20.8 mA	< 3.6 mA	> 21.95 mA
Fixed current	Constant current, defined in the Fixed current parameter (→ 140).		

- In the case of an error, the output current assumes the value defined in the **Failure mode** parameter (→ 141).
 - If the measured value is out of the measuring range, diagnostic message **Current output** is issued.
- In a HART multidrop loop only one device can use the analog current to transmit a signal. For all other devices one must set:
 - **Current span = Fixed current**
 - **Fixed current (→ 140) = 4 mA**

Fixed current



Navigation Setup → Advanced setup → Curr.output 1 to 2 → Fixed current

Prerequisite **Current span (→ 140) = Fixed current**

Description Define constant value of the current.

User entry 4 to 22.5 mA

Factory setting 4 mA

Damping output

Navigation	Setup → Advanced setup → Curr.output 1 to 2 → Damping out.
Description	Define time constant τ for the damping of the output current.
User entry	0.0 to 999.9 s
Factory setting	0.0 s
Additional information	Fluctuations of the measured value affect the output current with an exponential delay, the time constant τ of which is defined in this parameter. With a small time constant the output reacts immediately to changes of the measured value. With a big time constant the reaction of the output is more delayed. For $\tau = 0$ (factory setting) there is no damping.

Failure mode

Navigation	Setup → Advanced setup → Curr.output 1 to 2 → Failure mode
Prerequisite	Current span (→ 140) ≠ Fixed current
Description	Select behavior of the output current in case of an error.
Selection	<ul style="list-style-type: none"> ■ Min. ■ Max. ■ Last valid value ■ Actual value ■ Defined value
Factory setting	Max.
Additional information	<p>Meaning of the options</p> <ul style="list-style-type: none"> ■ Min. The current output adopts the value of the lower alarm level according to the Current span parameter (→ 140). ■ Max. The current output adopts the value of the upper alarm level according to the Current span parameter (→ 140). ■ Last valid value The current remains constant at the last value it had before the error occurred. ■ Actual value The output current follows the actual measured value; the error is ignored. ■ Defined value The output current assumes the value defined in the Failure current parameter (→ 142). <p> The error behavior of other output channels is not influenced by these settings but is defined in separate parameters.</p>

Failure current**Navigation**

Setup → Advanced setup → Curr.output 1 to 2 → Failure current

Prerequisite**Failure mode (→ 141) = Defined value****Description**

Enter current output value in alarm condition.

User entry

3.59 to 22.5 mA

Factory setting

22.5 mA

Output current 1 to 2**Navigation**

Setup → Advanced setup → Curr.output 1 to 2 → Output curr. 1 to 2







Description

Displays calculated output current.



"Switch output" submenu

Navigation  Setup → Advanced setup → Switch output

Switch output function

Navigation	 Setup → Advanced setup → Switch output → Switch out funct
Description	Select function for switch output.
Selection	<ul style="list-style-type: none"> ■ Off ■ On ■ Diagnostic behavior ■ Limit ■ Digital Output
Factory setting	Off
Additional information	<p>Meaning of the options</p> <ul style="list-style-type: none"> ■ Off The output is always open (non-conductive). ■ On The output is always closed (conductive). ■ Diagnostic behavior The output is normally closed and is only opened if a diagnostic event is present. The Assign diagnostic behavior parameter (→  144) determines for which type of event the output is opened. ■ Limit The output is normally closed and is only opened if a measured variable exceeds or falls below a defined limit. The limit values are defined by the following parameters: <ul style="list-style-type: none"> – Assign limit (→  144) – Switch-on value (→  144) – Switch-off value (→  146) ■ Digital Output The switching state of the output tracks the output value of a DI function block. The function block is selected in the Assign status parameter (→  143). <p> The Off and On options can be used to simulate the switch output.</p>



Assign status

Navigation	 Setup → Advanced setup → Switch output → Assign status
Prerequisite	Switch output function (→  143) = Digital Output
Description	Select device status for switch output.
Selection	<ul style="list-style-type: none"> ■ Off ■ Digital output AD 1 ■ Digital output AD 2

Factory setting Off

Additional information The **Digital output AD 1** and **Digital output AD 2** options refer to the Advanced Diagnostic Blocks. A switch signal generated in these blocks can be transmitted via the switch output.

Assign limit

Navigation   Setup → Advanced setup → Switch output → Assign limit

Prerequisite **Switch output function (→  143) = Limit**

Description Select process variable for limit monitoring.

Selection

- Off
- Level linearized
- Distance
- Terminal voltage
- Electronic temperature
- Relative echo amplitude
- Area of incoupling

Factory setting Off

Assign diagnostic behavior

Navigation   Setup → Advanced setup → Switch output → Assign diag. beh

Prerequisite **Switch output function (→  143) = Diagnostic behavior**

Description Select diagnostic behavior for switch output.

Selection

- Alarm
- Alarm or warning
- Warning

Factory setting Alarm

Switch-on value

Navigation   Setup → Advanced setup → Switch output → Switch-on value

Prerequisite **Switch output function (→  143) = Limit**

Description Enter measured value for the switch-on point.

User entry Signed floating-point number

Factory setting 0

Additional information The switching behavior depends on the relative position of the **Switch-on value** and **Switch-off value** parameters:

Switch-on value > Switch-off value

- The output is closed if the measured value is larger than **Switch-on value**.
- The output is opened if the measured value is smaller than **Switch-off value**.

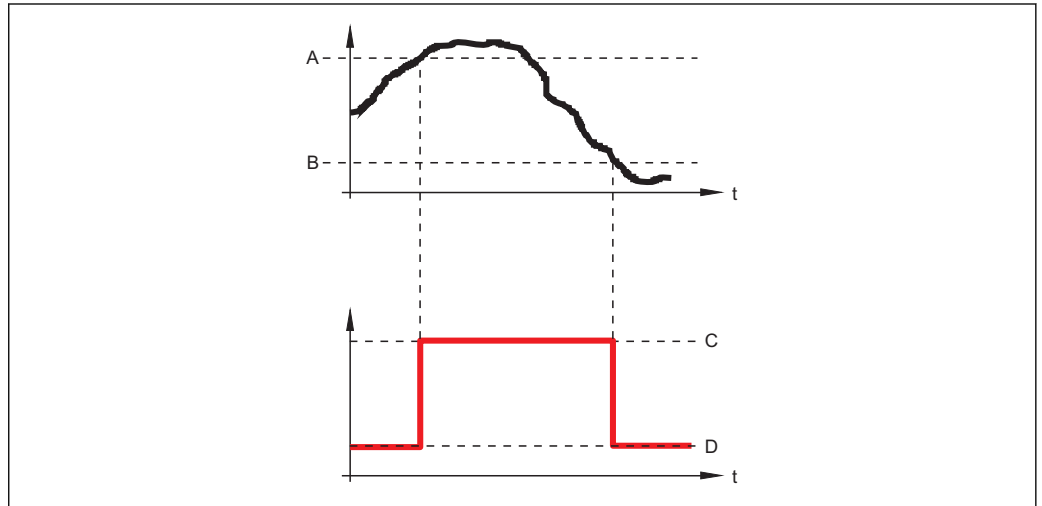

A0015585

- A Switch-on value
- B Switch-off value
- C Output closed (conductive)
- D Output opened (non-conductive)

Switch-on value < Switch-off value

- The output is closed if the measured value is smaller than **Switch-on value**.
- The output is opened if the measured value is larger than **Switch-off value**.

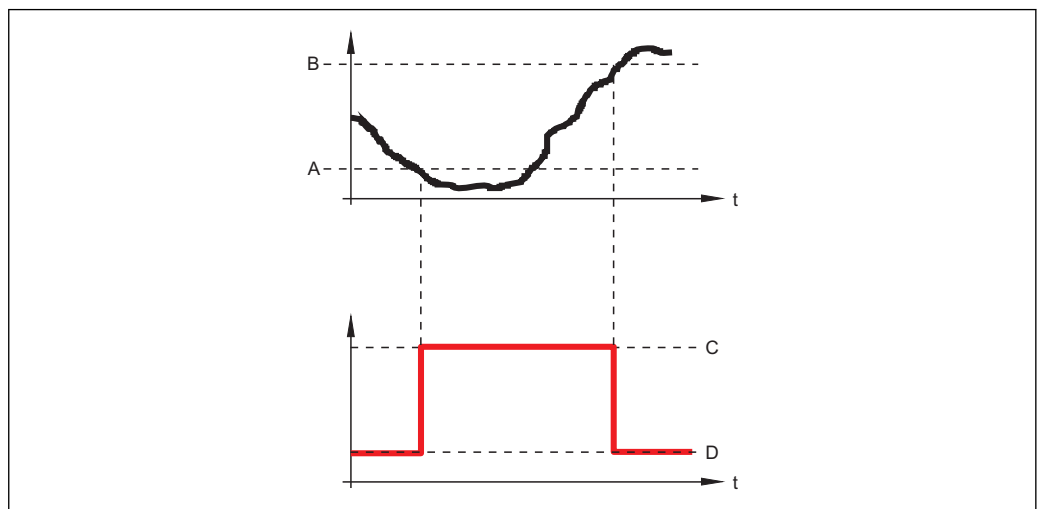

A0015586

- A Switch-on value
- B Switch-off value
- C Output closed (conductive)
- D Output opened (non-conductive)

Switch-on delay

Navigation	Setup → Advanced setup → Switch output → Switch-on delay
Prerequisite	<ul style="list-style-type: none"> ▪ Switch output function (→ 143) = Limit ▪ Assign limit (→ 144) ≠ Off
Description	Define switch-on delay.
User entry	0.0 to 100.0 s
Factory setting	0.0 s

Switch-off value

Navigation	Setup → Advanced setup → Switch output → Switch-off value
Prerequisite	Switch output function (→ 143) = Limit
Description	Enter measured value for the switch-off point.
User entry	Signed floating-point number
Factory setting	0
Additional information	The switching behavior depends on the relative position of the Switch-on value and Switch-off value parameters; description: see the Switch-on value parameter (→ 144).

Switch-off delay

Navigation	Setup → Advanced setup → Switch output → Switch-off delay
Prerequisite	<ul style="list-style-type: none"> ▪ Switch output function (→ 143) = Limit ▪ Assign limit (→ 144) ≠ Off
Description	Define switch-off delay.
User entry	0.0 to 100.0 s
Factory setting	0.0 s

Failure mode

Navigation	Setup → Advanced setup → Switch output → Failure mode
Description	Define output behavior in alarm condition.
Selection	<ul style="list-style-type: none"> ▪ Actual status ▪ Open ▪ Closed
Factory setting	Open

Switch status

Navigation	Setup → Advanced setup → Switch output → Switch status
Description	Displays the current state of the switch output.

Invert output signal



Navigation	Setup → Advanced setup → Switch output → Invert outp.sig.
Description	Specify whether the output signal is to be inverted.
Selection	<ul style="list-style-type: none"> ▪ No ▪ Yes
Factory setting	No
Additional information	<p>Meaning of the options</p> <ul style="list-style-type: none"> ▪ No The behavior of the switch output is as described above. ▪ Yes The states Open and Closed are inverted as compared to the description above.

"Display" submenu

 The **Display** submenu is only visible if a display module is connected to the device.

Navigation  Setup → Advanced setup → Display

Language**Navigation**

 Setup → Advanced setup → Display → Language

Description

Set display language.

Selection

- English
- Deutsch *
- Français *
- Español *
- Italiano *
- Nederlands *
- Portuguesa *
- Polski *
- русский язык (Russian) *
- Svenska *
- Türkçe *
- 中文 (Chinese) *
- 日本語 (Japanese) *
- 한국어 (Korean) *
- Bahasa Indonesia *
- tiếng Việt (Vietnamese) *
- čeština (Czech) *

Factory setting

The language selected in feature 500 of the product structure.
If no language has been selected: **English**

Format display**Navigation**

 Setup → Advanced setup → Display → Format display

Description

Select how measured values are shown on the display.

Selection

- 1 value, max. size
- 1 bargraph + 1 value
- 2 values
- 1 value large + 2 values
- 4 values

Factory setting

1 value, max. size

* Visibility depends on order options or device settings

Additional information

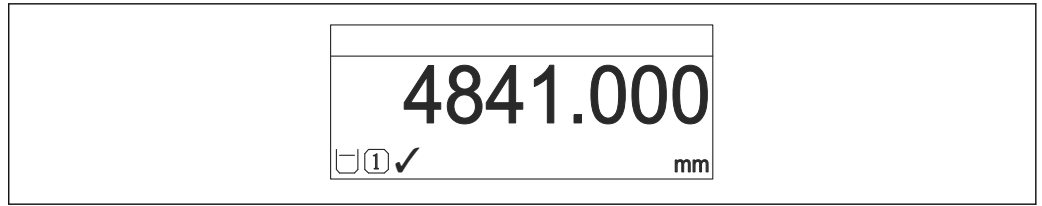

A0019963

36 "Format display" = "1 value, max. size"

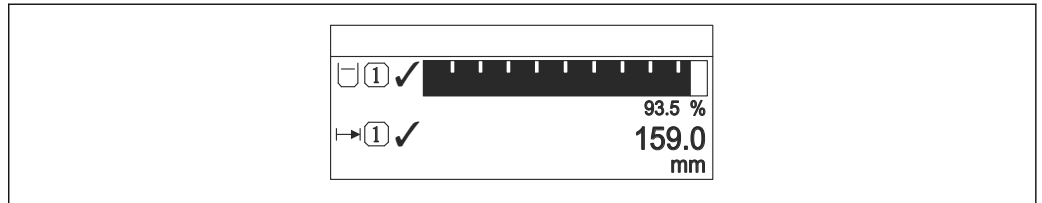

A0019964

37 "Format display" = "1 bargraph + 1 value"

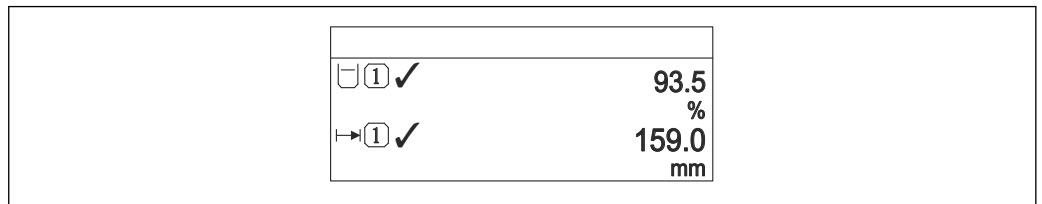

A0019965

38 "Format display" = "2 values"

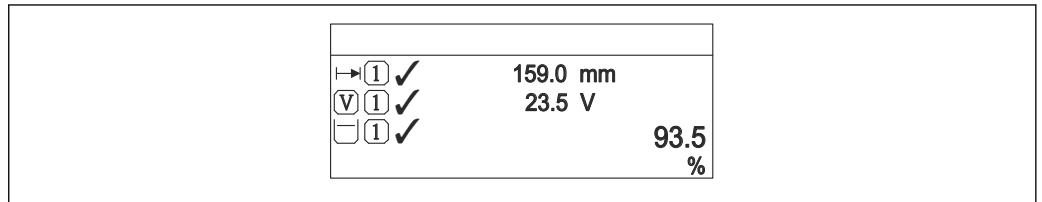

A0019966

39 "Format display" = "1 value large + 2 values"

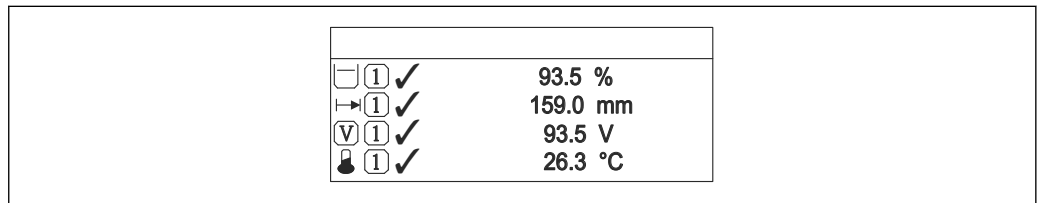

A0019968

40 "Format display" = "4 values"

- i
■
The Value 1 to 4 display → 150 parameters specify which measured values are shown on the display and in which order.
- If more measured values are specified than the current display mode permits, the values alternate on the device display. The display time until the next change is configured in the **Display interval** parameter (→ 150).

Value 1 to 4 display

Navigation	Setup → Advanced setup → Display → Value 1 display
Description	Select the measured value that is shown on the local display.
Selection	<ul style="list-style-type: none"> ■ None ⁸⁾ ■ Level linearized ■ Distance ■ Current output 1 ⁹⁾ ■ Measured current ■ Current output 2 ■ Terminal voltage ■ Electronic temperature ■ Absolute echo amplitude ■ Relative echo amplitude ■ Analog output adv. diagnostics 1 ■ Analog output adv. diagnostics 2 ■ Area of incoupling
Factory setting	<ul style="list-style-type: none"> ■ Value 1 display: Level linearized ■ Value 2 display: None ■ Value 3 display: None ■ Value 4 display: None

Decimal places 1 to 4

Navigation	Setup → Advanced setup → Display → Decimal places 1
Description	Select the number of decimal places for the display value.
Selection	<ul style="list-style-type: none"> ■ x ■ x.x ■ x.xx ■ x.xxx ■ x.xxxx
Factory setting	x.xx
Additional information	The setting does not affect the measuring or computational accuracy of the device.

Display interval

Navigation	Setup → Advanced setup → Display → Display interval
Description	Set time measured values are shown on display if display alternates between values.

8) can not be selected for the 'Value 1 display' parameter.

9) Visibility depends on order options or device settings

User entry	1 to 10 s
Factory setting	5 s
Additional information	This parameter is only relevant if the number of selected measuring values exceeds the number of values the selected display format can display simultaneously.

Display damping



Navigation	Setup → Advanced setup → Display → Display damping
Description	Define display reaction time to fluctuations in the measured value.
User entry	0.0 to 999.9 s
Factory setting	0.0 s

Header



Navigation	Setup → Advanced setup → Display → Header
Description	Select header contents on local display.
Selection	<ul style="list-style-type: none"> ■ Device tag ■ Free text
Factory setting	Device tag

Additional information

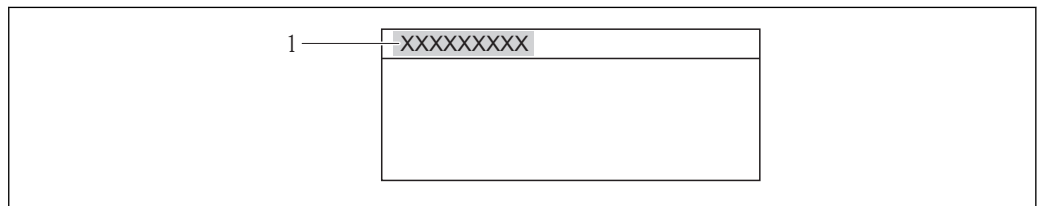



A0013375

1 Position of the header text on the display



Meaning of the options

- **Device tag**
Is defined in the **Device tag** parameter (→ 106).
- **Free text**
Is defined in the **Header text** parameter (→ 152).



Header text



Navigation	  Setup → Advanced setup → Display → Header text
Prerequisite	Header (→  151) = Free text
Description	Enter display header text.
Factory setting	-----
Additional information	The number of characters which can be displayed depends on the characters used.



Separator



Navigation	  Setup → Advanced setup → Display → Separator
Description	Select decimal separator for displaying numerical values.
Selection	<ul style="list-style-type: none"> ▪ . ▪ ,
Factory setting	.

Number format





Navigation	  Setup → Advanced setup → Display → Number format
Description	Choose number format for the display.
Selection	<ul style="list-style-type: none"> ▪ Decimal ▪ ft-in-1/16"
Factory setting	Decimal
Additional information	The ft-in-1/16" option is only valid for distance units.

Decimal places menu









Navigation	  Setup → Advanced setup → Display → Dec. places menu
Description	Select number of decimal places for the representation of numbers within the operating menu.

Selection	<ul style="list-style-type: none"> ■ X ■ X.X ■ X.XX ■ X.XXX ■ X.XXXX
Factory setting	x.xxxx
Additional information	<ul style="list-style-type: none"> ■ Is only valid for numbers in the operating menu (e.g. Empty calibration, Full calibration), but not for the measured value display. The number of decimal places for the measured value display is defined in the Decimal places 1 to 4 →  150 parameters. ■ The setting does not affect the accuracy of the measurement or the calculations.

Backlight

Navigation	  Setup → Advanced setup → Display → Backlight
Prerequisite	The device has the SD03 local display (with optical keys).
Description	Switch the local display backlight on and off.
Selection	<ul style="list-style-type: none"> ■ Disable ■ Enable
Factory setting	Disable
Additional information	<p>Meaning of the options</p> <ul style="list-style-type: none"> ■ Disable Switches the backlight off. ■ Enable Switches the backlight on. <p> Regardless of the setting in this parameter the backlight may be automatically switched off by the device if the supply voltage is too low.</p>

Contrast display

Navigation	  Setup → Advanced setup → Display → Contrast display
Description	Adjust local display contrast setting to ambient conditions (e.g. lighting or reading angle).
User entry	20 to 80 %
Factory setting	Dependent on the display.
Additional information	<p> Setting the contrast via push-buttons:</p> <ul style="list-style-type: none"> ■ Darker: press the  and  buttons simultaneously. ■ Brighter: press the  and  buttons simultaneously.

"Configuration backup display" submenu

 This submenu is only visible if a display module is connected to the device.

The configuration of the device can be saved to the display module at a certain point of time (backup). The saved configuration can be restored to the device if required, e.g. in order to bring the device back into a defined state. The configuration can also be transferred to a different device of the same type using the display module.

Navigation  Setup → Advanced setup → Conf.backup disp

Operating time

Navigation	 Setup → Advanced setup → Conf.backup disp → Operating time
Description	Indicates how long the device has been in operation.
User interface	Days (d), hours (h), minutes (m), seconds (s)
Additional information	<i>Maximum time</i> 9999 d (≈ 27 years)

Last backup

Navigation	 Setup → Advanced setup → Conf.backup disp → Last backup
Description	Indicates when the last data backup was saved to the display module.
User interface	Days (d), hours (h), minutes (m), seconds (s)



Configuration management



Navigation	 Setup → Advanced setup → Conf.backup disp → Config. managem.
Description	Select action for managing the device data in the display module.
Selection	<ul style="list-style-type: none"> ■ Cancel ■ Execute backup ■ Restore ■ Duplicate ■ Compare ■ Clear backup data
Factory setting	Cancel

Additional information

Meaning of the options

- **Cancel**
No action is executed and the user exits the parameter.
 - **Execute backup**
A backup copy of the current device configuration in the HistoROM (built-in in the device) is saved to the display module of the device.
 - **Restore**
The last backup copy of the device configuration is copied from the display module to the HistoROM of the device.
 - **Duplicate**
The transmitter configuration is duplicated to another device using the transmitter display module. The following parameters, which characterize the individual measuring point are **not** included in the transmitted configuration:
 - HART date code
 - HART short tag
 - HART message
 - HART descriptor
 - HART address
 - Device tag
 - Medium type
 - **Compare**
The device configuration saved in the display module is compared to the current device configuration of the HistoROM. The result of this comparison is displayed in the **Comparison result** parameter (→  155).
 - **Clear backup data**
The backup copy of the device configuration is deleted from the display module of the device.
-  While this action is in progress, the configuration cannot be edited via the local display and a message on the processing status appears on the display.
-  If an existing backup is restored to a different device using the **Restore** option, it may occur that some device functionalities are no longer available. In some cases even a device reset will not restore the original status.
- In order to transmit a configuration to a different device, the **Duplicate** option should always be used.

Backup state

Navigation



 Setup → Advanced setup → Conf.backup disp → Backup state

Description

Displays which backup action is currently in progress.

Comparison result

Navigation

  Setup → Advanced setup → Conf.backup disp → Compar. result

Description

Displays the comparison result between the device and the display.

Additional information**Meaning of the display options****■ Settings identical**

The current device configuration of the HistoROM is identical to the backup copy in the display module.

■ Settings not identical

The current device configuration of the HistoROM is not identical to the backup copy in the display module.

■ No backup available

There is no backup copy of the device configuration of the HistoROM in the display module.

■ Backup settings corrupt

The current device configuration of the HistoROM is corrupt or not compatible with the backup copy in the display module.

■ Check not done

The device configuration of the HistoROM has not yet been compared to the backup copy in the display module.

■ Dataset incompatible

The data sets are incompatible and can not be compared.





To start the comparison, set **Configuration management** (→  154) = **Compare**.













If the transmitter configuration has been duplicated from a different device by **Configuration management** (→  154) = **Duplicate**, the new device configuration in the HistoROM is only partially identical to the configuration stored in the display module: Sensor specific properties (e.g. the mapping curve) are not duplicated. Thus, the result of the comparison will be **Settings not identical**.



"Administration" submenu

Navigation  Setup → Advanced setup → Administration

Define access code 

Navigation	 Setup → Advanced setup → Administration → Def. access code
Description	Define release code for write access to parameters.
User entry	0 to 9999
Factory setting	0
Additional information	<p> If the factory setting is not changed or 0 is defined as the access code, the parameters are not write-protected and the configuration data of the device can then always be modified. The user is logged on in the <i>Maintenance</i> role.</p> <p> The write protection affects all parameters marked with the  symbol in this document. On the local display, the  symbol in front of a parameter indicates that the parameter is write-protected.</p> <p> Once the access code has been defined, write-protected parameters can only be modified if the access code is entered in the Enter access code parameter (→  117).</p> <p> Please contact your Endress+Hauser Sales Center if you lose your access code.</p> <p> For display operation: The new access code is only valid after it has been confirmed in the Confirm access code parameter (→  159).</p>

Device reset 

Navigation	  Setup → Advanced setup → Administration → Device reset
Description	Select to which state the device is to be reset.
Selection	<ul style="list-style-type: none"> ■ Cancel ■ To factory defaults ■ To delivery settings ■ Of customer settings ■ To transducer defaults ■ Restart device
Factory setting	Cancel

Additional information**Meaning of the options****■ Cancel**

No action

■ To factory defaults

All parameters are reset to the order-code specific factory setting.

■ To delivery settings

All parameters are reset to the delivery setting. The delivery setting may differ from the factory default if customer specific settings have been ordered.

This option is only visible if customer specific settings have been ordered.

■ Of customer settings

All customer parameters are reset to their factory setting. Service parameters, however, remain unchanged.

■ To transducer defaults

Every measurement-related parameter is reset to its factory setting. Service parameters and communication-related parameters, however, remain unchanged.

■ Restart device

The restart resets every parameter which is stored in the volatile memory (RAM) to the factory setting (e.g. measured value data). The device configuration remains unchanged.

"Define access code" wizard

 The **Define access code** wizard is only available when operating via the local display. When operating via an operating tool, the **Define access code** parameter is located directly in the **Administration** submenu. The **Confirm access code** parameter is not available for operation via operating tool.

Navigation  Setup → Advanced setup → Administration → Def. access code

Define access code 

Navigation  Setup → Advanced setup → Administration → Def. access code → Def. access code

Description →  157

Confirm access code 

Navigation  Setup → Advanced setup → Administration → Def. access code → Confirm code

Description Confirm the entered access code.





User entry 0 to 9999

Factory setting 0



16.4 "Diagnostics" menu

Navigation  Diagnostics



Actual diagnostics

Navigation	 Diagnostics → Actual diagnos.
Description	Displays current diagnostic message.
Additional information	<p>The display consists of:</p> <ul style="list-style-type: none"> ▪ Symbol for event behavior ▪ Code for diagnostic behavior ▪ Operating time of occurrence ▪ Event text <p> If several messages are active at the same time, the messages with the highest priority is displayed.</p> <p> Information on what is causing the message, and remedy measures, can be viewed via the  symbol on the display.</p>



Timestamp

Navigation	 Diagnostics → Timestamp
Description	Displays timestamp for the Actual diagnostics parameter (→  160).
User interface	Days (d), hours (h), minutes (m), seconds (s)



Previous diagnostics

Navigation	 Diagnostics → Prev.diagnostics
Description	Displays the last diagnostic message which has been active before the current message.
Additional information	<p>The display consists of:</p> <ul style="list-style-type: none"> ▪ Symbol for event behavior ▪ Code for diagnostic behavior ▪ Operating time of occurrence ▪ Event text <p> The condition displayed may still apply. Information on what is causing the message, and remedy measures, can be viewed via the  symbol on the display.</p>



Timestamp

Navigation	 Diagnostics → Timestamp
Description	Displays timestamp for the Previous diagnostics parameter (→  160).
User interface	Days (d), hours (h), minutes (m), seconds (s)

Operating time from restart

Navigation	  Diagnostics → Time fr. restart
Description	Displays the time the device has been in operation since the last device restart.
User interface	Days (d), hours (h), minutes (m), seconds (s)

Operating time

Navigation	  Diagnostics → Operating time
Description	Indicates how long the device has been in operation.
User interface	Days (d), hours (h), minutes (m), seconds (s)
Additional information	<i>Maximum time</i> 9 999 d (≈ 27 years)

16.4.1 "Diagnostic list" submenu

Navigation  Diagnostics → Diagnostic list

Diagnostics 1 to 5

Navigation  Diagnostics → Diagnostic list → Diagnostics 1 to 5

Description Display the current diagnostics messages with the highest to fifth-highest priority.

Additional information The display consists of:

- Symbol for event behavior
- Code for diagnostic behavior
- Operating time of occurrence
- Event text

Timestamp 1 to 5

Navigation  Diagnostics → Diagnostic list → Timestamp

Description Displays timestamp for the **Diagnostics 1 to 5** parameter (→  162).



User interface Days (d), hours (h), minutes (m), seconds (s)

16.4.2 "Event logbook" submenu

 The **Event logbook** submenu is only available when operating via the local display. When operating via FieldCare, the event list can be displayed in the FieldCare function "Event List / HistoROM".

Navigation  Diagnostics → Event logbook



Filter options



Navigation	 Diagnostics → Event logbook → Filter options
Description	Select category (status signal) whose event messages are displayed in the events list.
Selection	<ul style="list-style-type: none"> ▪ All ▪ Failure (F) ▪ Function check (C) ▪ Out of specification (S) ▪ Maintenance required (M) ▪ Information (I)
Factory setting	All
Additional information	 <ul style="list-style-type: none"> ▪ This parameter is only used for operation via the local display. ▪ The status signals are categorized according to NAMUR NE 107.

"Event list" submenu

The **Event list** submenu displays the history of past events of the category selected in the **Filter options** parameter (→  163). A maximum of 100 events are displayed in chronological order.

The following symbols indicate whether an event has occurred or has ended:

- : Event has occurred
- : Event has ended

 Information on what is causing the message, and remedy instructions, can be viewed via the -button.

Display format

- For event messages in category I: information event, event text, "recording event" symbol and time the event occurred
- For event messages in category F, M, C, S (status signal): diagnostics event, event text, "recording event" symbol and time the event occurred

Navigation  Diagnostics → Event logbook → Event list

16.4.3 "Device information" submenu

Navigation  Diagnostics → Device info

Device tag

Navigation  Diagnostics → Device info → Device tag

Description Enter the name for the measuring point.

Factory setting FMR5x

Serial number

Navigation  Diagnostics → Device info → Serial number

Description Displays serial number of the device.

Additional information



Uses of the serial number

- To identify the device quickly, e.g. when contacting Endress+Hauser.
- To obtain specific information on the device using the Device Viewer:
www.endress.com/deviceviewer



The serial number is also indicated on the nameplate.

Firmware version

Navigation  Diagnostics → Device info → Firmware version

Description Indicates the installed Firmware version.

User interface xx.yy.zz

Additional information













For firmware versions differing only in the last two digits ("zz") there is no difference concerning functionality or operation.

Device name

Navigation  Diagnostics → Device info → Device name

Description Displays device name.

Order code		
Navigation	  Diagnostics → Device info → Order code	
Description	Displays order code of the device.	
Additional information	The order code is generated from the extended order code, which defines all device features of the product structure. In contrast, the device features can not be read directly from the order code.	
Extended order code 1 to 3		
Navigation	  Diagnostics → Device info → Ext. order cd. 1 to 3	
Description	Displays the three parts of the extended order code.	
Additional information	The extended order code indicates the version of all the features of the product structure and thus uniquely identifies the device.	
Device revision		
Navigation	  Diagnostics → Device info → Device revision	
Description	Displays the device revision registered for this device at the HART Communication Foundation.	
Additional information	The device revision is used to allocate the correct Device Description file (DD) to the device.	
Device ID		
Navigation	  Diagnostics → Device info → Device ID	
Description	Displays Device ID.	
Additional information	In addition to the Device type and Manufacturer ID, the Device ID is part of the unique device identification (Unique ID) which characterizes each HART device unambiguously.	

Device type

Navigation Diagnostics → Device info → Device type**Description**

Displays the device type with which the device is registered with the the HART Communication Foundation.

Additional information

The device type is needed to allocate the correct Device Description file (DD) to the device.

Manufacturer ID

Navigation Diagnostics → Device info → Manufacturer ID**Description**

Displays the manufactured ID with which the device is registered with the HART Communication Foundation.

16.4.4 "Measured values" submenu

Navigation  Diagnostics → Measured val.

Distance

Navigation  Diagnostics → Measured val. → Distance

Description Displays the measured distance D between the reference point (lower edge of the flange or threaded connection) and the level.

Additional information

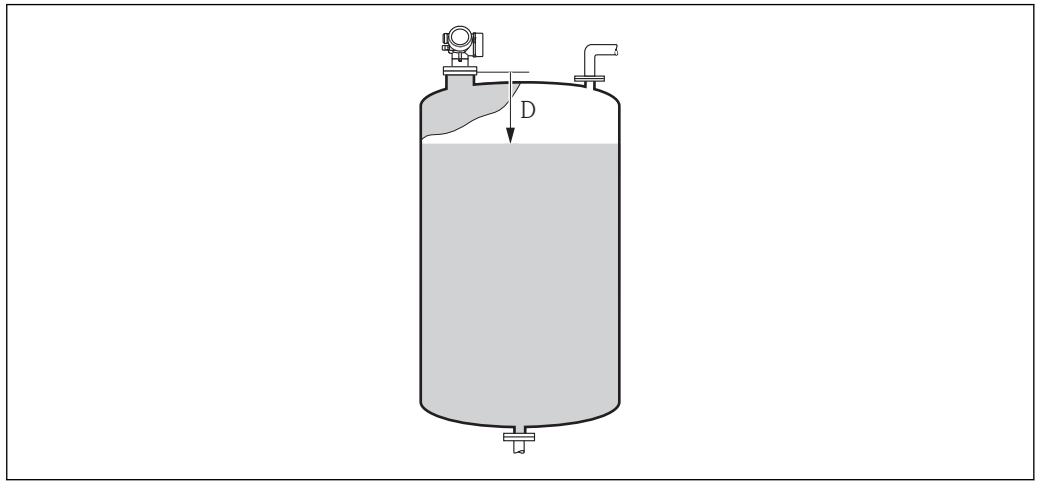

A0019483

 41 *Distance for liquid measurements*

 The unit is defined in the **Distance unit** parameter (→  106).

Level linearized

Navigation  Diagnostics → Measured val. → Level linearized

Description Displays linearized level.

Additional information  The unit is defined by the **Unit after linearization** parameter →  127.

Output current 1 to 2

Navigation  Diagnostics → Measured val. → Output curr. 1 to 2

Description Displays calculated output current.

Measured current 1

Navigation	 Diagnostics → Measured val. → Measur. curr. 1
Prerequisite	Only available for current output 1
Description	Displays the measured value of the output current.

Terminal voltage 1

Navigation	 Diagnostics → Measured val. → Terminal volt. 1
Description	Displays terminal voltage at the current output.



Electronic temperature

Navigation	 Diagnostics → Measured val. → Electronic temp.
Description	Displays the current temperature of the electronics.
Additional information	The unit is defined in the Temperature unit parameter.

16.4.5 "Data logging" submenu

Navigation   Diagnostics → Data logging

Assign channel 1 to 4

Navigation   Diagnostics → Data logging → Assign chan. 1 to 4

Description Allocate a process variable to the respective data logging channel.

Selection

- Off
- Level linearized
- Distance
- Current output 1
- Measured current
- Current output 2 *
- Terminal voltage
- Electronic temperature
- Absolute echo amplitude
- Relative echo amplitude
- Area of incoupling
- Analog output adv. diagnostics 1
- Analog output adv. diagnostics 2

Factory setting Off

Additional information A total of 1000 measured values can be logged. This means:

- 1000 data points if 1 logging channel is used
- 500 data points if 2 logging channels are used
- 333 data points if 3 logging channels are used
- 250 data points if 4 logging channels are used

If the maximum number of data points is reached, the oldest data points in the data log are cyclically overwritten in such a way that the last 1000, 500, 333 or 250 measured values are always in the log (ring memory principle).

 The logged data are deleted if a new option is selected in this parameter.

Logging interval

Navigation   Diagnostics → Data logging → Logging interval

Description Define logging interval t_{\log} .

User entry 1.0 to 3 600.0 s

Factory setting 30.0 s

* Visibility depends on order options or device settings

Additional information

This parameter defines the interval between the individual data points in the data log, and thus the maximum loggable process time T_{\log} :

- If 1 logging channel is used: $T_{\log} = 1000 \cdot t_{\log}$
- If 2 logging channels are used: $T_{\log} = 500 \cdot t_{\log}$
- If 3 logging channels are used: $T_{\log} = 333 \cdot t_{\log}$
- If 4 logging channels are used: $T_{\log} = 250 \cdot t_{\log}$

Once this time elapses, the oldest data points in the data log are cyclically overwritten such that a time of T_{\log} always remains in the memory (ring memory principle).



The logged data are deleted if this parameter is changed.

*Example***When using 1 logging channel**

- $T_{\log} = 1000 \cdot 1 \text{ s} = 1000 \text{ s} \approx 16.5 \text{ min}$
- $T_{\log} = 1000 \cdot 10 \text{ s} = 10000 \text{ s} \approx 2.75 \text{ h}$
- $T_{\log} = 1000 \cdot 80 \text{ s} = 80000 \text{ s} \approx 22 \text{ h}$
- $T_{\log} = 1000 \cdot 3600 \text{ s} = 3600000 \text{ s} \approx 41 \text{ d}$

Clear logging data**Navigation**

Diagnostics → Data logging → Clear logging

Description

Initiate a deletion of the complete logging memory.

Selection

- Cancel
- Clear data

Factory setting

Cancel

"Display channel 1 to 4" submenu

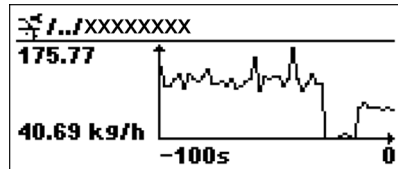

i The **Display channel 1 to 4** submenus are only available for operation via the local display. When operating via FieldCare, the logging diagram can be displayed in the FieldCare function "Event List / HistoROM" .

The **Display channel 1 to 4** submenus invoke a diagram of the logging history of the respective channel.



- x-axis: depending on the number of selected channels, 250 to 1000 measured values of a process variable are displayed.
- y-axis: covers the approximate measured value span and constantly adapts this to the measurement.







i To return to the operating menu, press **+** and **-** simultaneously.

Navigation   Diagnostics → Data logging → Displ.channel 1 to 4

16.4.6 "Simulation" submenu







The **Simulation** submenu is used to simulate specific measuring values or other conditions. This helps to check the correct configuration of the device and connected control units.

Conditions which can be simulated

Condition to be simulated	Associated parameters
Specific value of a process variable	<ul style="list-style-type: none"> ▪ Assign measurement variable (→  174) ▪ Value process variable (→  174)
Specific value of the output current	<ul style="list-style-type: none"> ▪ Simulation current output (→  174) ▪ Value current output (→  175)
Specific state of the switch output	<ul style="list-style-type: none"> ▪ Switch output simulation (→  175) ▪ Switch status (→  175)
Existence of an alarm	Simulation device alarm (→  176)

Structure of the submenu



Navigation  Expert → Diagnostics → Simulation

► Simulation	
Assign measurement variable	→  174
Value process variable	→  174
Simulation current output 1 to 2	→  174
Value current output 1 to 2	→  175
Switch output simulation	→  175
Switch status	→  175
Simulation device alarm	→  176



Description of parameters

Navigation  Expert → Diagnostics → Simulation

Assign measurement variable

Navigation	 Expert → Diagnostics → Simulation → Assign meas.var.
Description	Select process variable to be simulated.
Selection	<ul style="list-style-type: none"> ▪ Off ▪ Level ▪ Level linearized
Factory setting	Off
Additional information	<ul style="list-style-type: none"> ▪ The value of the variable to be simulated is defined in the Value process variable parameter (→  174). ▪ If Assign measurement variable ≠ Off, a simulation is active. This is indicated by a diagnostic message of the <i>Function check (C)</i> category.

Value process variable



Navigation	 Expert → Diagnostics → Simulation → Value proc. var.
Prerequisite	Assign measurement variable (→  174) ≠ Off
Description	Specify value of the process value being simulated.
User entry	Signed floating-point number
Factory setting	0
Additional information	Downstream measured value processing and the signal output use this simulation value. In this way, users can verify whether the measuring device has been configured correctly.

Simulation current output 1 to 2

Navigation	 Expert → Diagnostics → Simulation → Sim.curr.out. 1 to 2
Description	Switch the simulation of the current output on or off.
Selection	<ul style="list-style-type: none"> ▪ Off ▪ On
Factory setting	Off

Additional information An active simulation is indicated by a diagnostic message of the *Function check (C)* category.

Value current output 1 to 2

Navigation   Expert → Diagnostics → Simulation → Value curr.out 1 to 2

Prerequisite **Simulation current output (→  174) = On**

Description Enter current value for the simulation

User entry 3.59 to 22.5 mA

Factory setting 3.59 mA

Additional information The current output assumes the value specified in this parameter. In this way, users can verify the correct adjustment of the current output and the correct function of connected control units.

Switch output simulation

Navigation   Expert → Diagnostics → Simulation → Switch sim.



Description Switch the simulation of the switch output on or off.

Selection

- Off
- On

Factory setting Off

Switch status

Navigation   Expert → Diagnostics → Simulation → Switch status

Prerequisite **Switch output simulation (→  175) = On**

Description Define the switch state to be simulated.

Selection

- Open
- Closed

Factory setting Open

Additional information The switch status assumes the value defined in this parameter. This helps to check correct operation of connected control units.

Simulation device alarm

**Navigation** Expert → Diagnostics → Simulation → Sim. alarm**Description**

Switch alarm simulation on or off.

Selection

- Off
- On

Factory setting

Off

Additional information



When selecting the **On** option, the device generates an alarm. This helps to check the correct output behavior of the device in the case of an alarm.

An active simulation is indicated by the diagnostic message  **C484 Simulation failure mode**.



16.4.7 "Device check" submenu

Navigation   Diagnostics → Device check



Start device check

Navigation	  Diagnostics → Device check → Start dev. check
Description	Start a device check.
Selection	<ul style="list-style-type: none"> ■ No ■ Yes
Factory setting	No
Additional information	In the case of a lost echo a device check can not be performed.

Result device check

Navigation	  Diagnostics → Device check → Result dev.check
Description	Displays the result of the device check.
Additional information	<p>Meaning of the display options</p> <ul style="list-style-type: none"> ■ Installation ok Measurement possible without restrictions. ■ Accuracy reduced A measurement is possible. However, the measuring accuracy may be reduced due to the signal amplitudes. ■ Measurement capability reduced A measurement is currently possible. However, there is the risk of an echo loss. Check the mounting position of the device and the dielectric constant of the medium. ■ Check not done No device check has been performed.

Last check time

Navigation	  Diagnostics → Device check → Last check time
Description	Displays the operating time at which the last device check has been performed.

Level signal

Navigation Diagnostics → Device check → Level signal**Prerequisite**

Device check has been performed.

Description

Displays result of the device check for the level signal.

User interface

- Check not done
- Check not OK
- Check OK

Additional informationFor **Level signal = Check not OK**: Check the mounting position of the device and the dielectric constant of the medium.

16.4.8 "Heartbeat" submenu

 The **Heartbeat** submenu is only available via **FieldCare** or **DeviceCare**. It contains the wizards which are part of the **Heartbeat Verification** and **Heartbeat Monitoring** application packages.

Detailed description

SD01871F

Navigation  Diagnostics → Heartbeat

Index

A

Access authorization to parameters	
Read access	49
Write access	49
Access code	49
Incorrect input	49
Access status display (Parameter)	117
Access status tooling (Parameter)	116
Accessories	
Communication specific	91
Device specific	85
Service specific	92
Activate table (Parameter)	132
Actual diagnostics (Parameter)	160
Administration (Submenu)	157
Advanced process conditions (Parameter)	119
Advanced setup (Submenu)	116
Application	10
Residual risk	10
Assign channel 1 to 4 (Parameter)	169
Assign current output (Parameter)	139
Assign diagnostic behavior (Parameter)	144
Assign limit (Parameter)	144
Assign measurement variable (Parameter)	174
Assign status (Parameter)	143

B

Backlight (Parameter)	153
Backup state (Parameter)	155
Blocking distance (Parameter)	121, 135

C

CE mark	11
Cleaning	82
Clear logging data (Parameter)	170
Code incorrect (Parameter)	138
Comparison result (Parameter)	155
Configuration backup display (Submenu)	154
Configuration management (Parameter)	154
Configuration of a level measurement	66
Confirm access code (Parameter)	159
Confirm distance (Parameter)	110, 114
Context menu	61
Contrast display (Parameter)	153
Current output 1 to 2 (Submenu)	139
Current span (Parameter)	140
Customer value (Parameter)	132

D

Damping output (Parameter)	141
Data logging (Submenu)	169
DD	63
Deactivate SIL/WHG (Wizard)	138
Decimal places 1 (Parameter)	150
Decimal places menu (Parameter)	152
Declaration of Conformity	11

Define access code	50
Define access code (Parameter)	157, 159
Define access code (Wizard)	159
Designated use	10
Device check (Submenu)	177
Device Descriptions	63
Device ID (Parameter)	165
Device information (Submenu)	164
Device name (Parameter)	164
Device replacement	83
Device reset (Parameter)	157
Device revision (Parameter)	165
Device tag (Parameter)	106, 164
Device type (Parameter)	166
Diagnostic event	
In the operating tool	77
Diagnostic events	74
Diagnostic list	77
Diagnostic list (Submenu)	162
Diagnostic message	74
Diagnostics	
Symbols	74
Diagnostics (Menu)	160
Diagnostics 1 to 5 (Parameter)	162
Diagnostics event	75
Diameter (Parameter)	129
DIP switch	
see Write protection switch	
Display (Submenu)	148
Display and operating module FHX50	46
Display channel 1 to 4 (Submenu)	171
Display damping (Parameter)	151
Display interval (Parameter)	150
Display module	55
Display symbols for submenus	56
Display symbols for the locking state	56
Disposal	84
Distance (Parameter)	109, 114, 167
Distance unit (Parameter)	106
Document	
Function	5
Document function	5
E	
Electrical connection	
Commubox FXA291	47
Operating tools	
Via service interface (CDI)	47
Electronic temperature (Parameter)	168
Electronics housing	
Design	13
Turning	
see Turning the transmitter housing	
Empty calibration (Parameter)	108
Enter access code (Parameter)	117
Envelope curve display	62

- Event history 79
- Event level
 Explanation 74
 Symbols 74
- Event list (Submenu) 163
- Event logbook (Submenu) 163
- Event text 75
- Events list 79
- Extended order code 1 to 3 (Parameter) 165
- Exterior cleaning 82
- F**
- Failure current (Parameter) 142
- Failure mode (Parameter) 141, 147
- FHX50 46
- Filter options (Parameter) 163
- Filtering the event logbook 80
- Firmware version (Parameter) 164
- Fixed current (Parameter) 140
- Format display (Parameter) 148
- Free text (Parameter) 128
- Full calibration (Parameter) 108
- FV (HART device variable) 63
- H**
- Hardware write protection 52
- HART device variables 63
- HART integration 63
- HART protocol 46
- Header (Parameter) 151
- Header text (Parameter) 152
- Heartbeat (Submenu) 179
- Housing
 Design 13
- I**
- Input mask 59
- Intermediate height (Parameter) 129
- Invert output signal (Parameter) 147
- K**
- Keypad lock
 Disabling 54
 Switch-on 54
- L**
- Language (Parameter) 148
- Last backup (Parameter) 154
- Last check time (Parameter) 177
- Level (Parameter) 109, 131, 132
- Level (Submenu) 118
- Level correction (Parameter) 121
- Level linearized (Parameter) 128, 167
- Level measurement configuration 66
- Level signal (Parameter) 178
- Level unit (Parameter) 120
- Linearization (Submenu) 124, 125, 126
- Linearization type (Parameter) 126
- Local display 45
 see Diagnostics message
- see In alarm condition
- Locking status (Parameter) 116
- Logging interval (Parameter) 169
- M**
- Maintenance 82
- Manage device configuration 70
- Manufacturer ID (Parameter) 166
- Mapping (Wizard) 114
- Mapping end point (Parameter) 112, 114
- Max. draining speed liquid (Parameter) 119
- Max. filling speed liquid (Parameter) 119
- Maximum value (Parameter) 129
- Measured current 1 (Parameter) 168
- Measured materials 10
- Measured value symbols 57
- Measured values (Submenu) 167
- Medium group (Parameter) 107
- Medium property (Parameter) 118
- Medium type (Parameter) 118
- Menu
 Diagnostics 160
 Setup 106
- N**
- Number format (Parameter) 152
- O**
- Operating elements
 Diagnostics message 75
- Operating module 55
- Operating time (Parameter) 154, 161
- Operating time from restart (Parameter) 161
- Operational safety 11
- Order code (Parameter) 165
- Output current 1 to 2 (Parameter) 142, 167
- Output echo lost (Parameter) 134
- Overvoltage protection
 General information 42
- P**
- Prepare recording map (Parameter) 114
- Present mapping (Parameter) 112
- Previous diagnostics (Parameter) 160
- Product safety 11
- PV (HART device variable) 63
- R**
- Ramp at echo lost (Parameter) 135
- Read access 49
- Record map (Parameter) 112, 114
- Registered trademarks 14
- Remedial measures
 Calling up 76
 Closing 76
- Remote operation 46
- Repair concept 83
- Replacing a device 83
- Requirements for personnel 10
- Reset write protection (Parameter) 138

Result device check (Parameter) 177
 Return 84

S

Safety instructions
 Basic 10

Safety Instructions (XA) 7

Safety settings (Submenu) 134

Separator (Parameter) 152

Serial number (Parameter) 164

Setting the operating language 65

Settings
 Manage device configuration 70
 Operating language 65

Setup (Menu) 106

Signal quality (Parameter) 110

SIL/WHG confirmation (Wizard) 137

Simulation (Submenu) 173, 174

Simulation current output 1 to 2 (Parameter) 174

Simulation device alarm (Parameter) 176

Spare parts 84
 Nameplate 84

Start device check (Parameter) 177

Status signals 56, 74

Submenu
 Administration 157
 Advanced setup 116
 Configuration backup display 154
 Current output 1 to 2 139
 Data logging 169
 Device check 177
 Device information 164
 Diagnostic list 162
 Display 148
 Display channel 1 to 4 171
 Event list 163
 Event logbook 163
 Events list 79
 Heartbeat 179
 Level 118
 Linearization 124, 125, 126
 Measured values 167
 Safety settings 134
 Simulation 173, 174
 Switch output 143

SV (HART device variable) 63

Switch output (Submenu) 143

Switch output function (Parameter) 143

Switch output simulation (Parameter) 175

Switch status (Parameter) 147, 175

Switch-off delay (Parameter) 146

Switch-off value (Parameter) 146

Switch-on delay (Parameter) 146

Switch-on value (Parameter) 144

Symbols
 For correction 59
 In the text and numeric editor 59

System components 92

T

Table mode (Parameter) 130

Table number (Parameter) 131

Tank type (Parameter) 106

Tank/silo height (Parameter) 122

Terminal voltage 1 (Parameter) 168

Timestamp (Parameter) 160, 161, 162

Transmitter
 Turning the display module 32
 Turning the housing 31

Transmitter housing
 Turning 31

Trouble shooting 72

Tube diameter (Parameter) 107

Turning the display module 32

TV (HART device variable) 63

U

Unit after linearization (Parameter) 127

V

Value 1 display (Parameter) 150

Value current output 1 to 2 (Parameter) 175

Value echo lost (Parameter) 134

Value process variable (Parameter) 174

W

W@M Device Viewer 84

Wizard
 Deactivate SIL/WHG 138
 Define access code 159
 Mapping 114
 SIL/WHG confirmation 137

Workplace safety 11

Write access 49

Write protection
 Via access code 50
 Via write protection switch 52

Write protection switch 52



www.addresses.endress.com
