

Operating Instructions

Micropilot FMR56, FMR57

HART

Free space radar

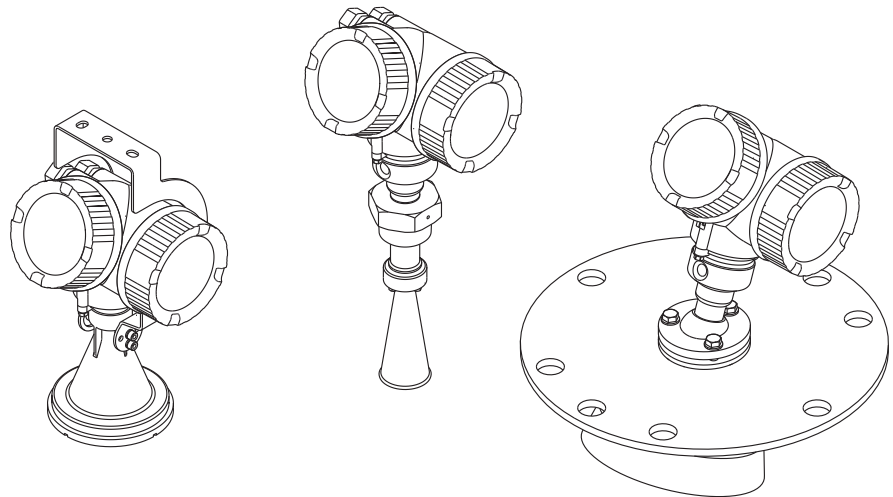

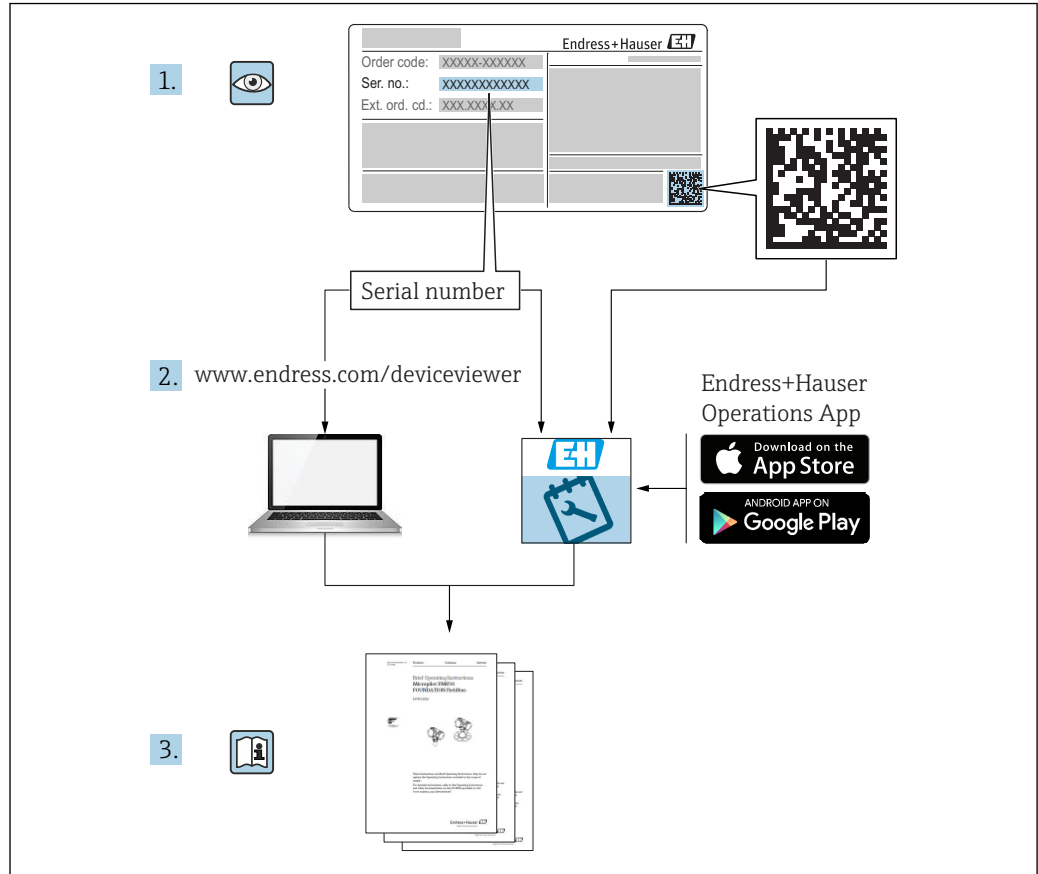

A0023555

Table of contents

1	Wichtige Hinweise zum Dokument	5	6.3	Installation in vessel (free space)	26
1.1	Document function	5	6.3.1	Horn antenna with slip-on flange (FMR56)	26
1.2	Symbols	5	6.3.2	Horn antenna with mounting bracket (FMR56)	28
1.2.1	Safety symbols	5	6.3.3	Horn antenna (FMR57)	28
1.2.2	Electrical symbols	5	6.3.4	Parabolic antenna (FMR57)	29
1.2.3	Tool symbols	5	6.3.5	Alignment device for FMR57	32
1.2.4	Symbols for certain types of information	6	6.3.6	Integrated air purge connection for FMR57	33
1.2.5	Symbols in graphics	6	6.4	Container with heat insulation	33
1.2.6	Symbols at the device	7	6.5	Turning the transmitter housing	34
1.3	Additional documentation	7	6.6	Turning the display	34
1.4	Terms and abbreviations	8	6.6.1	Opening cover	34
1.5	Registered trademarks	9	6.6.2	Turning the display module	35
			6.6.3	Closing electronics compartment cover	35
2	Basic safety instructions	10	6.7	Post-installation check	35
2.1	Requirements for the personnel	10	7	Electrical connection	36
2.2	Designated use	10	7.1	Connection conditions	36
2.3	Workplace safety	11	7.1.1	Terminal assignment	36
2.4	Operational safety	11	7.1.2	Cable specification	42
2.5	Product safety	11	7.1.3	Device plug connectors	43
2.5.1	CE mark	11	7.1.4	Supply voltage	44
2.5.2	EAC conformity	12	7.1.5	Overvoltage protection	46
2.6	Safety Instructions (XA)	12	7.2	Connecting the measuring device	46
3	Product description	15	7.2.1	Opening connection compartment cover	47
3.1	Product design	15	7.2.2	Connecting	47
3.1.1	Micropilot FMR56	15	7.2.3	Plug-in spring-force terminals	48
3.1.2	Micropilot FMR57	15	7.2.4	Closing connection compartment cover	48
3.1.3	Electronics housing	16	7.3	Post-connection check	49
4	Incoming acceptance and product identification	17	8	Operation options	50
4.1	Incoming acceptance	17	8.1	Overview	50
4.2	Product identification	17	8.1.1	Local operation	50
4.2.1	Nameplate	18	8.1.2	Operation with remote display and operating module FHX50	51
5	Storage, Transport	19	8.1.3	Operation via Bluetooth® wireless technology	52
5.1	Storage conditions	19	8.1.4	Remote operation	53
5.2	Transport product to the measuring point	19	8.2	Structure and function of the operating menu	54
6	Installation	20	8.2.1	Structure of the operating menu	54
6.1	Installation conditions	20	8.2.2	User roles and related access authorization	56
6.1.1	Mounting position	20	8.2.3	Data access - Security	56
6.1.2	Vessel installations	21	8.3	Display and operating module	61
6.1.3	Reduction of interference echoes	22	8.3.1	Display appearance	61
6.1.4	Measurement in a plastic vessel	22	8.3.2	Operating elements	64
6.1.5	Optimization options	23	8.3.3	Entering numbers and text	65
6.1.6	Beam angle	24	8.3.4	Opening the context menu	67
6.2	Measuring conditions	25			

8.3.5	Envelope curve on the display and operating module	68	15	Repairs	95
9	System integration via HART protocol	69	15.1	General information on repairs	95
9.1	Overview of the Device Description files (DD)	69	15.1.1	Repair concept	95
9.2	Measured values via HART protocol	69	15.1.2	Repairs to Ex-approved devices	95
10	Commissioning via SmartBlue (app)	70	15.1.3	Replacement of an electronics module	95
10.1	Requirements	70	15.1.4	Replacement of a device	95
10.2	Commissioning	70	15.2	Spare parts	96
11	Commissioning via wizard	74	15.3	Return	96
12	Commissioning via operating menu	75	15.4	Disposal	96
12.1	Installation and function check	75	16	Accessories	97
12.2	Setting the operating language	75	16.1	Device-specific accessories	97
12.3	Configuration of a level measurement	76	16.1.1	Weather protection cover	97
12.4	Recording the reference curve	78	16.1.2	Variable flange seal for FMR50/ FMR56	98
12.5	Configuration of the on-site display	79	16.1.3	Mounting bracket for wall or ceiling mounting of FMR50/FMR56	99
12.5.1	Factory settings of the on-site display	79	16.1.4	Remote display FHX50	100
12.5.2	Adjustment of the on-site display ...	79	16.1.5	Horn protection for horn antenna ..	101
12.6	Configuration of the current outputs	79	16.1.6	Overvoltage protection	102
12.6.1	Factory setting of the current outputs	79	16.1.7	Bluetooth module for HART devices	103
12.6.2	Adjustment of the current outputs ...	79	16.2	Communication-specific accessories	104
12.7	Configuration management	80	16.3	Service-specific accessories	105
12.8	Protection of the settings against unauthorized changes	81	16.4	System components	106
13	Diagnostics and troubleshooting ...	82	17	Operating menu	107
13.1	General trouble shooting	82	17.1	Overview of the operating menu (SmartBlue)	107
13.1.1	General errors	82	17.2	Overview of the operating menu (display module)	112
13.1.2	Error - SmartBlue operation	83	17.3	Overview of the operating menu (operating tool)	119
13.1.3	Parametrization errors	83	17.4	"Setup" menu	125
13.2	Diagnostic information on local display	85	17.4.1	"Mapping" wizard	133
13.2.1	Diagnostic message	85	17.4.2	"Advanced setup" submenu	135
13.2.2	Calling up remedial measures	87	17.5	"Diagnostics" menu	178
13.3	Diagnostic event in the operating tool	88	17.5.1	"Diagnostic list" submenu	180
13.4	Diagnostic list	89	17.5.2	"Event logbook" submenu	181
13.5	Overview of diagnostic events	90	17.5.3	"Device information" submenu	182
13.6	Event logbook	91	17.5.4	"Measured values" submenu	185
13.6.1	Event history	91	17.5.5	"Data logging" submenu	187
13.6.2	Filtering the event logbook	92	17.5.6	"Simulation" submenu	190
13.6.3	Overview of information events	92	17.5.7	"Device check" submenu	195
13.7	Firmware history	93	17.5.8	"Heartbeat" submenu	197
14	Maintenance	94	Index	198	
14.1	Exterior cleaning	94			
14.2	Replacing seals	94			





1 Wichtige Hinweise zum Dokument

1.1 Document function





These Operating Instructions contain all the information that is required in various phases of the life cycle of the device: from product identification, incoming acceptance and storage, to mounting, connection, operation and commissioning through to troubleshooting, maintenance and disposal.

1.2 Symbols



1.2.1 Safety symbols



Symbol	Meaning
	DANGER! This symbol alerts you to a dangerous situation. Failure to avoid this situation will result in serious or fatal injury.
	WARNING! This symbol alerts you to a dangerous situation. Failure to avoid this situation can result in serious or fatal injury.
	CAUTION! This symbol alerts you to a dangerous situation. Failure to avoid this situation can result in minor or medium injury.
	NOTE! This symbol contains information on procedures and other facts which do not result in personal injury.

1.2.2 Electrical symbols





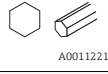







Symbol	Meaning
	Direct current
	Alternating current
	Direct current and alternating current
	Ground connection A grounded terminal which, as far as the operator is concerned, is grounded via a grounding system.
	Protective Earth (PE) A terminal which must be connected to ground prior to establishing any other connections. The ground terminals are situated inside and outside the device: <ul style="list-style-type: none"> ▪ Inner ground terminal: Connects the protective earth to the mains supply. ▪ Outer ground terminal: Connects the device to the plant grounding system.

1.2.3 Tool symbols



Symbol	Meaning
	Torx screwdriver
	Flat blade screwdriver

Symbol	Meaning
 A0011219	Cross-head screwdriver
 A0011221	Allen key
 A0011222	Hexagon wrench

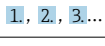

1.2.4 Symbols for certain types of information

Symbol	Meaning
	Permitted Procedures, processes or actions that are permitted.
	Preferred Procedures, processes or actions that are preferred.
	Forbidden Procedures, processes or actions that are forbidden.
	Tip Indicates additional information.
	Reference to documentation.
	Reference to page.
	Reference to graphic.
	Notice or individual step to be observed.
	Series of steps.
	Result of a step.
	Help in the event of a problem.
	Visual inspection.

1.2.5 Symbols in graphics

Symbol	Meaning
1, 2, 3 ...	Item numbers
	Series of steps
A, B, C, ...	Views
A-A, B-B, C-C, ...	Sections
	Hazardous area Indicates a hazardous area.
	Safe area (non-hazardous area) Indicates the non-hazardous area.

1.2.6 Symbols at the device

Symbol	Meaning
	Safety instructions Observe the safety instructions contained in the associated Operating Instructions.
	Temperature resistance of the connection cables Specifies the minimum value of the temperature resistance of the connection cables.

1.3 Additional documentation

Document	Purpose and content of the document
Technical Information TI01042F (FMR56, FMR57)	Planning aid for your device The document contains all the technical data on the device and provides an overview of the accessories and other products that can be ordered for the device.
Brief Operating Instructions KA01102F (FMR56/FMR57, HART)	Guide that takes you quickly to the 1st measured value The Brief Operating Instructions contain all the essential information from incoming acceptance to initial commissioning.
Description of Device Parameters GP01014F (FMR5x, HART)	Reference for your parameters The document provides a detailed explanation of each individual parameter in the operating menu. The description is aimed at those who work with the device over the entire life cycle and perform specific configurations.
Special documentation SD01087F	Functional Safety Manual The document is part of the Operating Instructions and serves as a reference for application-specific parameters and notes.
Special documentation SD01870F	Manual for Heartbeat Verification and Heartbeat Monitoring The document contains descriptions of the additional parameters and technical data which are available with the Heartbeat Verification and Heartbeat Monitoring application packages.

-  For an overview of the scope of the associated Technical Documentation, refer to the following:
- The *W@M Device Viewer* : Enter the serial number from the nameplate (www.endress.com/deviceviewer)
 - The *Endress+Hauser Operations App*: Enter the serial number from the nameplate or scan the 2-D matrix code (QR code) on the nameplate.

1.4 Terms and abbreviations

Term/abbreviation	Explanation
BA	Document type "Operating Instructions"
KA	Document type "Brief Operating Instructions"
TI	Document type "Technical Information"
SD	Document type "Special Documentation"
XA	Document type "Safety Instructions"
PN	Nominal pressure
MWP	Maximum Working Pressure The MWP can also be found on the nameplate.
ToF	Time of Flight
FieldCare	Scalable software tool for device configuration and integrated plant asset management solutions
DeviceCare	Universal configuration software for Endress+Hauser HART, PROFIBUS, FOUNDATION Fieldbus and Ethernet field devices
DTM	Device Type Manager
DD	Device Description for HART communication protocol
ϵ_r (DC value)	Relative dielectric constant
Operating tool	The term "operating tool" is used in place of the following operating software: <ul style="list-style-type: none"> ▪ FieldCare / DeviceCare, for operation via HART communication and PC ▪ SmartBlue (app), for operation using an Android or iOS smartphone or tablet.
BD	Blocking Distance; no signals are analyzed within the BD.
PLC	Programmable Logic Controller
CDI	Common Data Interface
PFS	Pulse Frequency Status (Switching output)

1.5 Registered trademarks

HART®

Registered trademark of the FieldComm Group, Austin, USA

Bluetooth®

The Bluetooth® word mark and logos are registered trademarks owned by the Bluetooth SIG, Inc. and any use of such marks by Endress+Hauser is under license. Other trademarks and trade names are those of their respective owners.

Apple®

Apple, the Apple logo, iPhone, and iPod touch are trademarks of Apple Inc., registered in the U.S. and other countries. App Store is a service mark of Apple Inc.

Android®

Android, Google Play and the Google Play logo are trademarks of Google Inc.

KALREZ®, VITON®

Registered trademark of DuPont Performance Elastomers L.L.C., Wilmington, USA

TEFLON®

Registered trademark of E.I. DuPont de Nemours & Co., Wilmington, USA

TRI CLAMP®

Registered trademark of Alfa Laval Inc., Kenosha, USA

2 Basic safety instructions

2.1 Requirements for the personnel

The personnel for installation, commissioning, diagnostics and maintenance must fulfill the following requirements:

- ▶ Trained, qualified specialists must have a relevant qualification for this specific function and task.
- ▶ Are authorized by the plant owner/operator.
- ▶ Are familiar with federal/national regulations.
- ▶ Before starting work, read and understand the instructions in the manual and supplementary documentation as well as the certificates (depending on the application).
- ▶ Follow instructions and comply with basic conditions.

The operating personnel must fulfill the following requirements:

- ▶ Are instructed and authorized according to the requirements of the task by the facility's owner-operator.
- ▶ Follow the instructions in this manual.

2.2 Designated use

Application and measured materials

The measuring device described in these Operating Instructions is intended for the continuous, contactless level measurement of mainly bulk solids. The device can also be freely mounted outside closed metal vessels (e.g. above basins, open channels or open piles) because of its operating frequency of about 26 GHz, a maximum radiated pulsed power of 23.3 mW and an average power output of 0.076 mW. Operation is completely harmless to humans and animals.

Observing the limit values specified in the "Technical data" and listed in the Operating Instructions and supplementary documentation, the measuring device may be used for the following measurements only:

- ▶ Measured process variables: level, distance, signal strength
- ▶ Calculated process variables: Volume or mass in arbitrarily shaped vessels; flow through measuring weirs or flumes (calculated from the level by the linearization functionality)

To ensure that the measuring device remains in proper condition for the operation time:

- ▶ Use the measuring device only for measured materials against which the process-wetted materials are adequately resistant.
- ▶ Observe the limit values in "Technical data".

Incorrect use

The manufacturer is not liable for damage caused by improper or non-designated use.

Verification for borderline cases:

- ▶ For special measured materials and cleaning agents, Endress+Hauser is glad to provide assistance in verifying the corrosion resistance of wetted materials, but does not accept any warranty or liability.

Residual risk

The electronics housing and its built-in components such as display module, main electronics module and I/O electronics module may heat to 80 °C (176 °F) during operation through heat transfer from the process as well as power dissipation within the electronics. During operation the sensor may assume a temperature near the temperature of the measured material.

Danger of burns due to heated surfaces!

- ▶ For high process temperatures: Install protection against contact in order to prevent burns.

2.3 Workplace safety

For work on and with the device:

- ▶ Wear the required personal protective equipment according to federal/national regulations.

2.4 Operational safety

Risk of injury.

- ▶ Operate the device in proper technical condition and fail-safe condition only.
- ▶ The operator is responsible for interference-free operation of the device.

Conversions to the device

Unauthorized modifications to the device are not permitted and can lead to unforeseeable dangers.

- ▶ If, despite this, modifications are required, consult with the manufacturer.

Repair

To ensure continued operational safety and reliability,

- ▶ Carry out repairs on the device only if they are expressly permitted.
- ▶ Observe federal/national regulations pertaining to repair of an electrical device.
- ▶ Use original spare parts and accessories from the manufacturer only.

Hazardous area

To eliminate a danger for persons or for the facility when the device is used in the hazardous area (e.g. explosion protection, pressure vessel safety):

- ▶ Based on the nameplate, check whether the ordered device is permitted for the intended use in the hazardous area.
- ▶ Observe the specifications in the separate supplementary documentation that is an integral part of these Instructions.

2.5 Product safety

This measuring device is designed in accordance with good engineering practice to meet state-of-the-art safety requirements, has been tested, and left the factory in a condition in which it is safe to operate. It meets general safety standards and legal requirements.

NOTICE

Loss of degree of protection by opening of the device in humid environments

- ▶ If the device is opened in a humid environment, the degree of protection indicated on the nameplate is no longer valid. This may also impair the safe operation of the device.

2.5.1 CE mark

The measuring system meets the legal requirements of the applicable EC guidelines. These are listed in the corresponding EC Declaration of Conformity together with the standards applied.

Endress+Hauser confirms successful testing of the device by affixing to it the CE mark.

2.5.2 EAC conformity

The measuring system meets the legal requirements of the applicable EAC guidelines. These are listed in the corresponding EAC Declaration of Conformity together with the standards applied.

Endress+Hauser confirms successful testing of the device by affixing to it the EAC mark.

2.6 Safety Instructions (XA)

Depending on the approval, the following Safety Instructions (XA) are supplied with the device. They are an integral part of the Operating Instructions.

Feature 010	Approval	Available for	Feature 020 "Power Supply; Output"				
			A ¹⁾	B ²⁾	C ³⁾	E ^{4)/G⁵⁾}	K ^{6)/L⁷⁾}
BA	ATEX: II 1 G Ex ia IIC T6-T1 Ga	<ul style="list-style-type: none"> ■ FMR56 ■ FMR57 	XA00677F	XA00677F	XA00677F	XA00685F	-
BB	ATEX: II 1/2 G Ex ia IIC T6-T1 Ga/Gb	<ul style="list-style-type: none"> ■ FMR56 ■ FMR57 	XA00677F	XA00677F	XA00677F	XA00685F	-
BC	ATEX: II 1/2 G Ex d [ia] IIC T6-T1 Ga/Gb	<ul style="list-style-type: none"> ■ FMR56 ■ FMR57 	XA00680F	XA00680F	XA00680F	XA00688F	XA00680F
BD	ATEX: II 1/2/3 G Ex ic [ia Ga] IIC T6-T1 Ga/Gb/Gc	FMR57	XA00678F	XA00678F	XA00678F	XA00686F	XA00678F
BE	ATEX: II 1 D Ex ta IIIC T ₅₀₀ xx°C Da	<ul style="list-style-type: none"> ■ FMR56 ■ FMR57 	XA00682F	XA00682F	XA00682F	XA00690F	XA00682F
BF	ATEX: II 1/2 D Ex ta IIIC Txx°C Da/Db	<ul style="list-style-type: none"> ■ FMR56 ■ FMR57 	XA00682F	XA00682F	XA00682F	XA00690F	XA00682F
BG	ATEX: II 3 G Ex nA IIC T6-T1 Gc	<ul style="list-style-type: none"> ■ FMR56 ■ FMR57 	XA00679F	XA00679F	XA00679F	XA00687F	XA00679F
BH	ATEX: II 3 G Ex ic IIC T6-T1 Gc	<ul style="list-style-type: none"> ■ FMR56 ■ FMR57 	XA00679F	XA00679F	XA00679F	XA00687F	XA00679F
BL	ATEX: II 1/2/3 G Ex nA [ia Ga] IIC T6-T1 Ga/Gb/Gc	FMR57	XA00678F	XA00678F	XA00678F	XA00686F	XA00678F
B2	ATEX: II 1/2 G Ex ia IIC T6-T1 Ga/Gb ATEX: II 1/2 D Ex ia IIIC Txx°C Da/Db	<ul style="list-style-type: none"> ■ FMR56 ■ FMR57 	XA00683F	XA00683F	XA00683F	XA00691F	-
B3	ATEX: II 1/2 G Ex d [ia] IIC T6-T1 Ga/Gb ATEX: II 1/2 D Ex ta IIIC Txx°C Da/Db	<ul style="list-style-type: none"> ■ FMR56 ■ FMR57 	XA00684F	XA00684F	XA00684F	XA00692F	XA00684F
CD	CSA C/US DIP Cl.I,II,III Div.1 Gr.E-G	<ul style="list-style-type: none"> ■ FMR56 ■ FMR57 	XA01113F	XA01113F	XA01113F	XA01115F	XA01113F
C2	CSA C/US IS Cl.I,II,III Div.1 Gr.A-G, NI Cl.1 Div.2, Ex ia	<ul style="list-style-type: none"> ■ FMR56 ■ FMR57 	XA01112F	XA01112F	XA01112F	XA01114F	-
C3	CSA C/US XP Cl.I,II,III Div.1 Gr.A-G, NI Cl.1 Div.2, Ex d	<ul style="list-style-type: none"> ■ FMR56 ■ FMR57 	XA01113F	XA01113F	XA01113F	XA01115F	XA01113F
FA	FM IS Cl.I Div.1 Gr.A-D	FMR56	XA01116F	XA01116F	XA01116F	XA01118F	-
FB	FM IS Cl.I,II,III Div.1 Gr.A-G, AEx ia, NI Cl.1 Div.2	<ul style="list-style-type: none"> ■ FMR56 ■ FMR57 	XA01116F	XA01116F	XA01116F	XA01118F	-
FC	FM XP Cl.I Div.1 Gr.A-D	FMR56	XA01117F	XA01117F	XA01117F	XA01119F	XA01117F
FD	FM XP Cl.I,II,III Div.1 Gr.A-G, AEx d, NI Cl.1 Div.2	<ul style="list-style-type: none"> ■ FMR56 ■ FMR57 	XA01117F	XA01117F	XA01117F	XA01119F	XA01117F
FE	FM DIP Cl.I,II,III Div.1 Gr.E-G	<ul style="list-style-type: none"> ■ FMR56 ■ FMR57 	XA01117F	XA01117F	XA01117F	XA01119F	XA01117F
IA	IECEx: Ex ia IIC T6-T1 Ga	<ul style="list-style-type: none"> ■ FMR56 ■ FMR57 	XA00677F	XA00677F	XA00677F	XA00685F	-

Feature 010	Approval	Available for	Feature 020 "Power Supply; Output"				
			A ¹⁾	B ²⁾	C ³⁾	E ^{4)/G⁵⁾}	K ^{6)/L⁷⁾}
IB	IECEEx: Ex ia IIC T6-T1 Ga/Gb	<ul style="list-style-type: none"> ▪ FMR56 ▪ FMR57 	XA00677F	XA00677F	XA00677F	XA00685F	-
IC	IECEEx: Ex d [ia] IIC T6-T1 Ga/Gb	<ul style="list-style-type: none"> ▪ FMR56 ▪ FMR57 	XA00680F	XA00680F	XA00680F	XA00688F	XA00680F
ID	IECEEx: Ex ic [ia Ga] IIC T6-T1 Ga/Gb/Gc	FMR57	XA00678F	XA00678F	XA00678F	XA00686F	XA00678F
IE	IECEEx: Ex ta IIIC T ₅₀₀ xx°C Da	<ul style="list-style-type: none"> ▪ FMR56 ▪ FMR57 	XA00682F	XA00682F	XA00682F	XA00690F	XA00682F
IF	IECEEx: Ex ta IIIC Txx°C Da/Db	<ul style="list-style-type: none"> ▪ FMR56 ▪ FMR57 	XA00682F	XA00682F	XA00682F	XA00690F	XA00682F
IG	IECEEx: Ex nA IIC T6-T1 Gc	<ul style="list-style-type: none"> ▪ FMR56 ▪ FMR57 	XA00679F	XA00679F	XA00679F	XA00687F	XA00679F
IH	IECEEx: Ex ic IIC T6-T1 Gc	<ul style="list-style-type: none"> ▪ FMR56 ▪ FMR57 	XA00679F	XA00679F	XA00679F	XA00687F	XA00679F
IL	IECEEx: Ex nA [ia Ga] IIC T6-T1 Ga/Gb/Gc	FMR57	XA00678F	XA00678F	XA00678F	XA00686F	XA00678F
I2	IECEEx: Ex ia IIC T6-T1 Ga/Gb IECEEx: Ex ia IIIC Txx°C Da/Db	<ul style="list-style-type: none"> ▪ FMR56 ▪ FMR57 	XA00683F	XA00683F	XA00683F	XA00691F	-
I3	IECEEx: Ex d [ia] IIC T6-T1 Ga/Gb IEXEx: Ex ta IIIC Txx°C Da/Db	<ul style="list-style-type: none"> ▪ FMR56 ▪ FMR57 	XA00684F	XA00684F	XA00684F	XA00692F	XA00684F
JF	JPN Ex d [ia] IIC T3 Ga/Gb	FMR57	XA01717F	XA01717F	-	-	-
KA	KC Ex ia IIC T6 Ga	<ul style="list-style-type: none"> ▪ FMR56 ▪ FMR57 	XA01045F	XA01045F	XA01045F	XA01047F	-
KB	KC Ex ia IIC T6 Ga/Gb	<ul style="list-style-type: none"> ▪ FMR56 ▪ FMR57 	XA01045F	XA01045F	XA01045F	XA01047F	-
KC	KC Ex d[ia] IIC T6	<ul style="list-style-type: none"> ▪ FMR56 ▪ FMR57 	XA01046F	XA01046F	XA01046F	XA01048F	XA01046F
MA	INMETRO: Ex ia IIC T6 Ga	<ul style="list-style-type: none"> ▪ FMR56 ▪ FMR57 	XA01286F	XA01287F	XA01288F	XA01296F	-
ME	INMETRO: Ex t IIIC Da	<ul style="list-style-type: none"> ▪ FMR56 ▪ FMR57 	XA01295F	XA01295F	XA01295F	XA01299F	XA01295F
MH	INMETRO: Ex ic IIC T6 Gc	<ul style="list-style-type: none"> ▪ FMR56 ▪ FMR57 	XA01289F	XA01290F	XA01291F	XA01297F	-
NA	NEPSI Ex ia IIC T6 Ga	<ul style="list-style-type: none"> ▪ FMR56 ▪ FMR57 	XA01199F	XA01199F	XA01199F	XA01208F	-
NB	NEPSI Ex ia IIC T6 Ga/Gb	<ul style="list-style-type: none"> ▪ FMR56 ▪ FMR57 	XA01199F	XA01199F	XA01199F	XA01208F	-
NC	NEPSI Ex d[ia] IIC T6 Ga/Gb	<ul style="list-style-type: none"> ▪ FMR56 ▪ FMR57 	XA01202F	XA01202F	XA01202F	XA01211F	XA01202F
NF	NEPSI DIP A20/21 T85...90oC IP66	<ul style="list-style-type: none"> ▪ FMR56 ▪ FMR57 	XA01204F	XA01204F	XA01204F	XA01213F	XA01204F
NG	NEPSI Ex nA II T6 Gc	<ul style="list-style-type: none"> ▪ FMR56 ▪ FMR57 	XA01201F	XA01201F	XA01201F	XA01210F	XA01201F
NH	NEPSI Ex ic IIC T6 Gc	<ul style="list-style-type: none"> ▪ FMR56 ▪ FMR57 	XA01201F	XA01201F	XA01201F	XA01210F	XA01201F
N2	NEPSI Ex ia IIC T6 Ga/Gb, Ex iaD 20/21 T85...90oC	<ul style="list-style-type: none"> ▪ FMR56 ▪ FMR57 	XA01205F	XA01205F	XA01205F	XA01214F	-

Feature 010	Approval	Available for	Feature 020 "Power Supply; Output"				
			A ¹⁾	B ²⁾	C ³⁾	E ⁴⁾ /G ⁵⁾	K ⁶⁾ /L ⁷⁾
N3	NEPSI Ex d[ia] IIC T6 Ga/Gb, DIP A20/21 T85...90oC IP66	<ul style="list-style-type: none"> ■ FMR56 ■ FMR57 	XA01206F	XA01206F	XA01206F	XA01215F	XA01206F
8A	FM/CSA IS+XP Cl.I,II,III Div.1 Gr.A-G	<ul style="list-style-type: none"> ■ FMR56 ■ FMR57 	<ul style="list-style-type: none"> ■ XA01112F ■ XA01113F ■ XA01116F ■ XA01117F 	<ul style="list-style-type: none"> ■ XA01112F ■ XA01113F ■ XA01116F ■ XA01117F 	<ul style="list-style-type: none"> ■ XA01112F ■ XA01113F ■ XA01116F ■ XA01117F 	<ul style="list-style-type: none"> ■ XA01114F ■ XA01115F ■ XA01118F ■ XA01119F 	-

- 1) 2-wire; 4-20mA HART
- 2) 2-wire; 4-20mA HART, switch output
- 3) 2-wire; 4-20mA HART, 4-20mA
- 4) 2-wire; FOUNDATION Fieldbus, switch output
- 5) 2-wire; PROFIBUS PA, switch output
- 6) 4-wire 90-253VAC; 4-20mA HART
- 7) 4-wire 10.4-48VDC; 4-20mA HART

 For certified devices the relevant Safety Instructions (XA) are indicated on the nameplate.

If the device is prepared for the remote display FHX50 (product structure: feature 030: Display, Operation", option L or M), the Ex marking of some certificates changes according to the following table¹⁾:

Feature 010 ("Approval")	Feature 030 ("Display, Operation")	Ex marking
BE	L, M or N	ATEX II 1D Ex ta [ia] IIIC T ₅₀₀ xx°C Da
BF	L, M or N	ATEX II 1/2 D Ex ta [ia Db] IIIC Txx°C Da/Db
BG	L, M or N	ATEX II 3G Ex nA [ia Ga] IIC T6-T1 Gc
BH	L, M or N	ATEX II 3G Ex ic [ia Ga] IIC T6-T1 Gc
B3	L, M or N	ATEX II 1/2G Ex d [ia] IIC T6-T1 Ga/Gb, ATEX II 1/2D Ex ta [ia Db] IIIC Txx°C Da/Db
IE	L, M or N	IECEX Ex ta [ia] IIIC T ₅₀₀ xx°C Da
IF	L, M or N	IECEX ta [ia Db] IIIC Txx°C Da/Db
IG	L, M or N	IECEX Ex nA [ia Ga] IIC T6-T1 Gc
IH	L, M or N	IECEX Ex ic [ia Ga] IIC T6-T1 Gc
I3	L, M or N	IECEX Ex d [ia] IIC T6-T1 Ga/Gb, IECEX Ex ta [ia Db] IIIC Txx°C Da/Db
ME	L, M or N	Ex ta [ia] IIIC T ₅₀₀ xx°C Da
MH	L, M or N	Ex ic [ia Ga] IIC T6 Gc
NF	L, M or N	NEPSI DIP A20/21 [ia D] TA, Txx°C IP6X
NG	L, M or N	NEPSI Ex nA [ia Ga] IIC T6-T1 Gc
NH	L, M or N	NEPSI Ex ic [ia Ga] IIC T6-T1 Gc
N3	L, M or N	NEPSI Ex d [ia] IIC T6-T1 Ga/Gb, DIP A20/21 [ia D] TA, Txx°C IP6X

1) The marking of certificates not mentioned in this table are not affected by the FHX50.

3 Product description

3.1 Product design

3.1.1 Micropilot FMR56

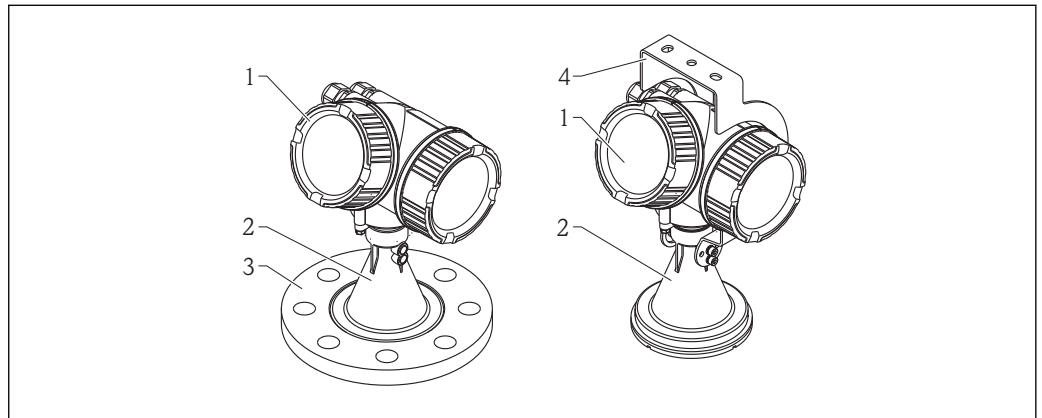

A0016791

1 Design of the Micropilot FMR56 (26 GHz)

- 1 Electronics housing
- 2 Horn 80mm/100 mm (3in/4in), PP clad
- 3 Flange
- 4 Mounting bracket

3.1.2 Micropilot FMR57

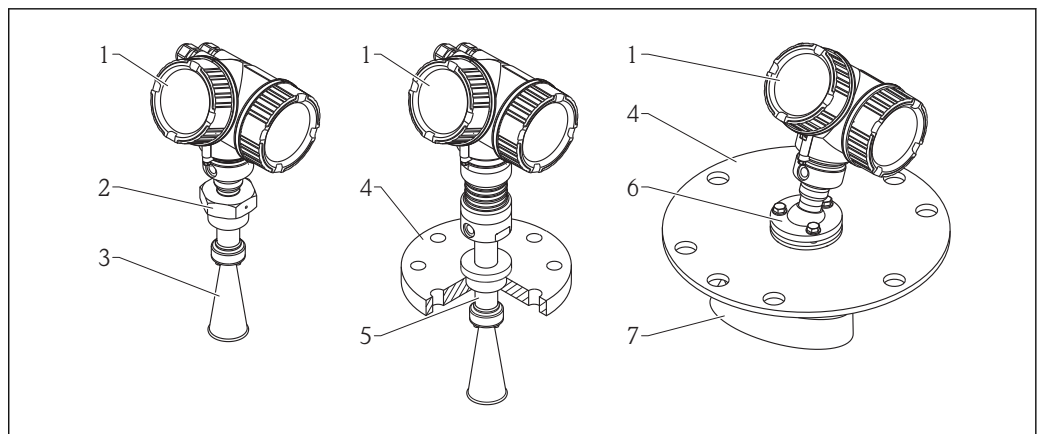

A0016807

2 Design of the Micropilot FMR57 (26 GHz)

- 1 Electronics housing
- 2 Process connection (Thread)
- 3 Horn antenna
- 4 Flange
- 5 Antenna extension
- 6 Alignment device
- 7 Parabolic antenna

3.1.3 Electronics housing

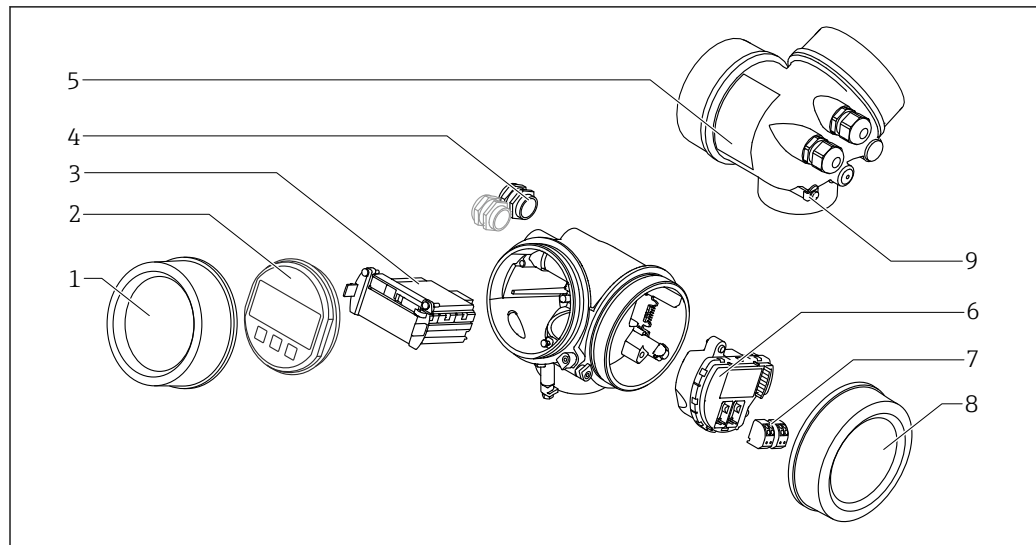

A0012422

3 Design of the electronics housing

- 1 Electronics compartment cover
- 2 Display module
- 3 Main electronics module
- 4 Cable glands (1 or 2, depending on instrument version)
- 5 Nameplate
- 6 I/O electronics module
- 7 Terminals (pluggable spring terminals)
- 8 Connection compartment cover
- 9 Grounding terminal

4 Incoming acceptance and product identification

4.1 Incoming acceptance

Upon receipt of the goods check the following:

- Are the order codes on the delivery note and the product sticker identical?
- Are the goods undamaged?
- Do the nameplate data match the ordering information on the delivery note?
- Is the DVD with the operating tool present?
If required (see nameplate): Are the Safety Instructions (XA) present?



If one of these conditions is not satisfied, contact your Endress+Hauser Sales Center.

4.2 Product identification

The following options are available for identification of the measuring device:

- Nameplate specifications
- Extended order code with breakdown of the device features on the delivery note
- Enter serial numbers from nameplates in *W@M Device Viewer* (www.endress.com/deviceviewer): All information about the measuring device is displayed.
- Enter the serial number from the nameplates into the *Endress+Hauser Operations App* or scan the 2-D matrix code (QR code) on the nameplate with the *Endress+Hauser Operations App*: all the information for the measuring device is displayed.

For an overview of the scope of the associated Technical Documentation, refer to the following:

- The *W@M Device Viewer*: Enter the serial number from the nameplate (www.endress.com/deviceviewer)
- The *Endress+Hauser Operations App*: Enter the serial number from the nameplate or scan the 2-D matrix code (QR code) on the nameplate.

4.2.1 Nameplate

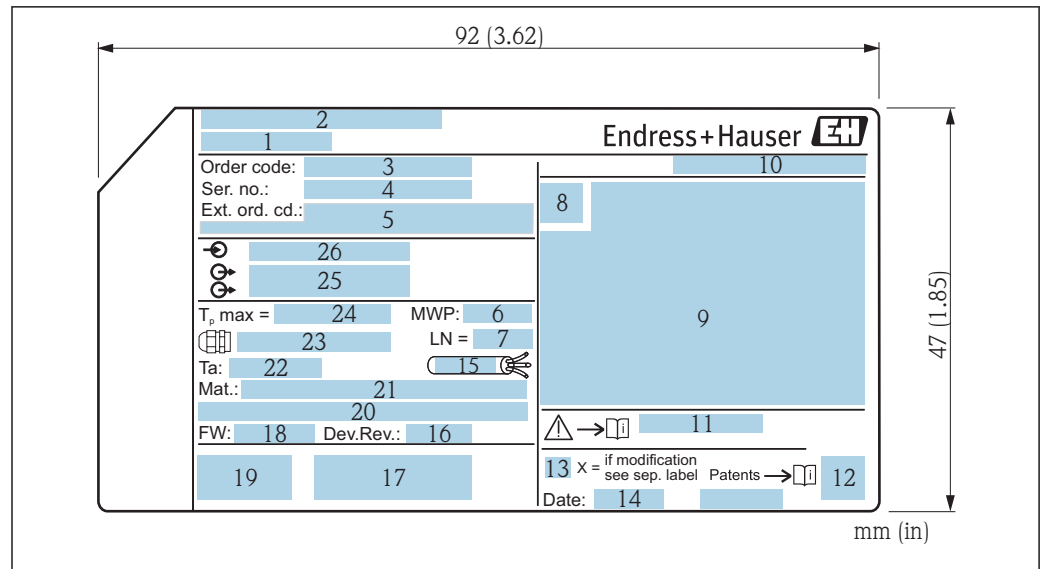

A0019444

4 Nameplate of the Micropilot

- 1 Device name
- 2 Address of manufacturer
- 3 Order code
- 4 Serial number (Ser. no.)
- 5 Extended order code (Ext. ord. cd.)
- 6 Process pressure
- 7 Antenna length (only for FMR51 with antenna extension)
- 8 Certificate symbol
- 9 Certificate and approval relevant data
- 10 Degree of protection: e.g. IP, NEMA
- 11 Document number of the Safety Instructions: e.g. XA, ZD, ZE
- 12 Data Matrix Code
- 13 Modification mark
- 14 Manufacturing date: year-month
- 15 Temperature resistance of the cable
- 16 Device revision
- 17 Additional information about the device version (certificates, approvals, communication): e.g. SIL, PROFIBUS
- 18 Firmware version (FW)
- 19 CE mark, C-Tick
- 20 Profibus PA: Profil-Version; FOUNDATION Fieldbus: Device ID
- 21 Material in contact with process
- 22 Permitted ambient temperature (T_a)
- 23 Size of the thread of the cable glands
- 24 Maximum process temperature
- 25 Signal outputs
- 26 Operating voltage

i Only 33 digits of the extended order code can be indicated on the nameplate. If the extended order code exceeds 33 digits, the rest will not be shown. However, the complete extended order code can be viewed in the operating menu of the device: **Extended order code 1 to 3** parameter

5 Storage, Transport

5.1 Storage conditions

- Permitted storage temperature: -40 to +80 °C (-40 to +176 °F)
- Use the original packaging.

5.2 Transport product to the measuring point

NOTICE

Housing or antenna horn may be damaged or break away.

Risk of injury!

- ▶ Transport the measuring device to the measuring point in its original packaging or at the process connection.
- ▶ Do not fasten lifting devices (hoisting slings, lifting eyes etc.) at the housing or the antenna horn but at the process connection. Take into account the mass center of the device in order to avoid unintended tilting.
- ▶ Comply with the safety instructions, transport conditions for devices over 18kg (39.6lbs) (IEC61010).

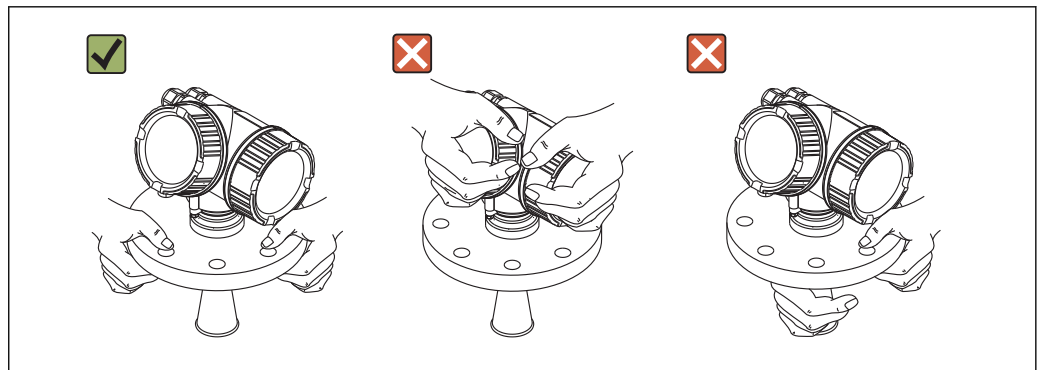

A0016875

6 Installation

6.1 Installation conditions

6.1.1 Mounting position

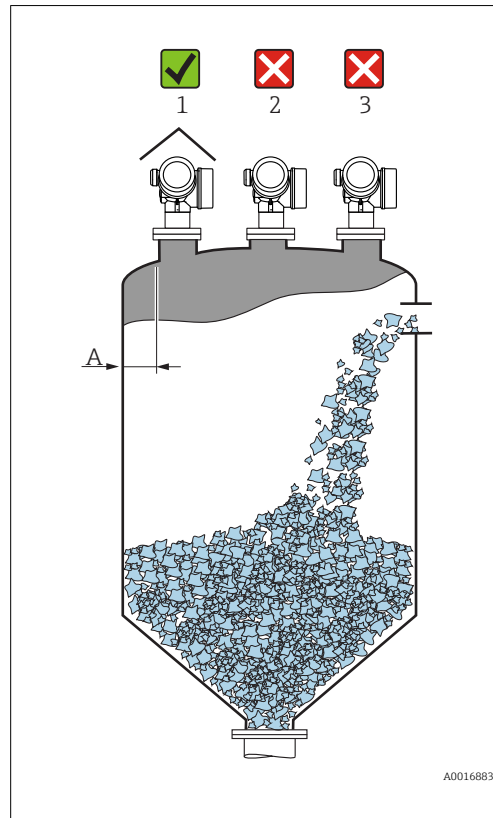

- Recommended distance **A** from wall to outer edge of nozzle: $\sim 1/6$ of vessel diameter. Nevertheless the device should not be installed closer than 20 cm (7.87 in) to the vessel wall. If the wall of the vessel is not smooth (corrugated metal, welding seams, irregularities etc.) the distance from the wall should be kept as large as possible. If necessary, use an alignment device to prevent interference reflections from the wall (Verweisziel existiert nicht, aber @y.link.required='true').
- Not in the center (2), as interference can cause signal loss.
- Not above the fill stream (3).
- It is recommended to use a weather protection cover (1) in order to protect the device from direct sun or rain.
- In extremely dusty applications, the integrated air purge connection can prevent clogging of the antenna (Verweisziel existiert nicht, aber @y.link.required='true').

6.1.2 Vessel installations

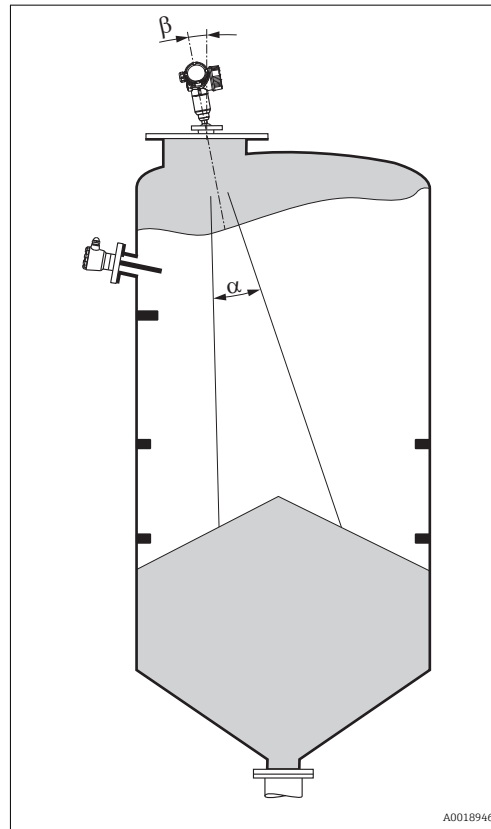

Avoid any installations (limit switches, temperature sensors, braces etc.) inside the signal beam. Take into account the beam angle .

6.1.3 Reduction of interference echoes

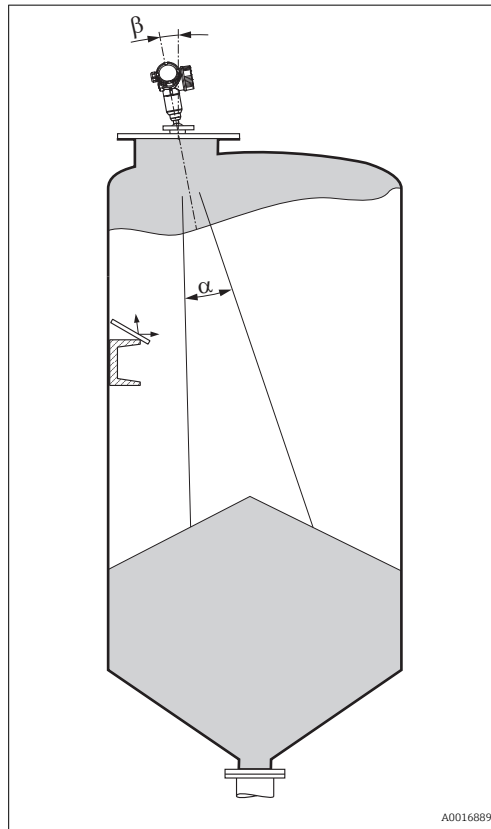

Metallic screens mounted at a slope spread the radar signal and can, therefore, reduce interference echoes.

6.1.4 Measurement in a plastic vessel

If the outer wall of the vessel is made of a non-conductive material (e.g. GRP), microwaves can also be reflected off interfering installations outside the vessel (e.g. metallic pipes (1), ladders (2), grates (3), ...). Therefore, there should be no such interfering installations in the signal beam. Please contact Endress+Hauser for further information.

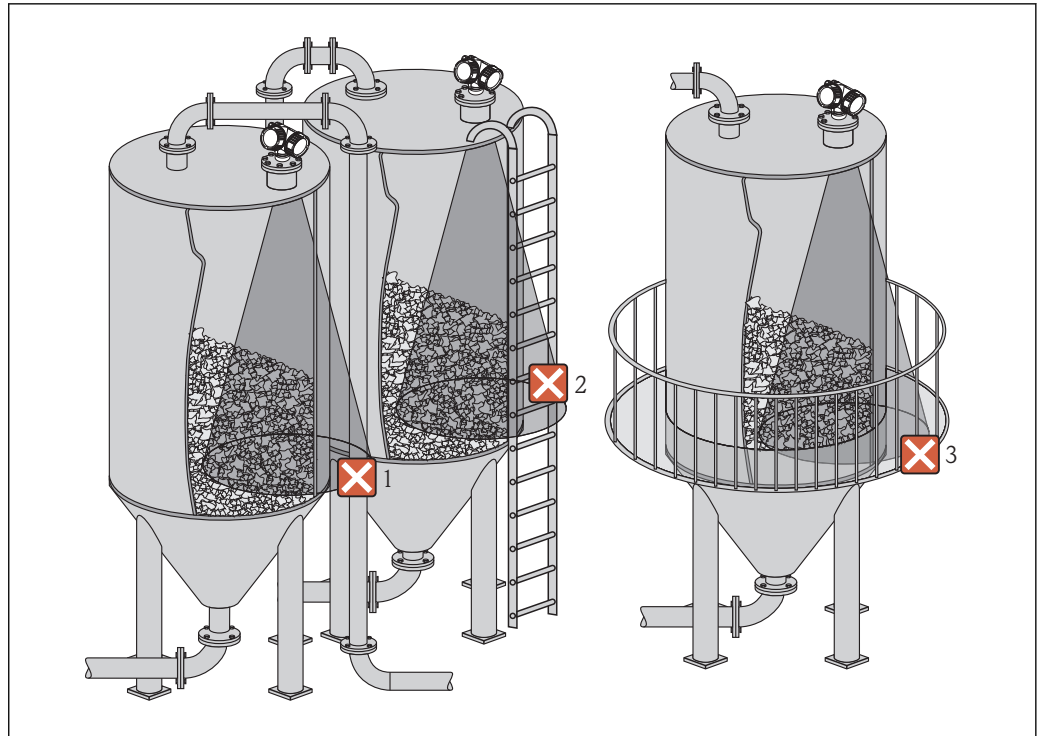

A0017125

6.1.5 Optimization options

- **Antenna size**
The bigger the antenna, the smaller the beam angle α and the fewer interference echoes
→ 24.
- **Mapping**
The measurement can be optimized by means of electronic suppression of interference echoes.
See the **Confirm distance** parameter (→ 130) for details.
- **Antenna alignment**
Take into account the marker on the flange or threaded connection .
- **Metallic screens mounted at a slope**
They spread the radar signals and can, therefore, reduce interference echoes.
- **Variable flange seal (FMR56)**
Using the variable flange seal, the device can be aligned in the direction of the product surface. For details refer to Operating Instructions BA01048F, chapter "Accessories".
- **Alignment device for FMR57**
In FMR57 with alignment device, the sensor can be optimally aimed within the vessel and thus interference echoes can be avoided. The maximum angle β is $\pm 15^\circ$.
In particular, sensor alignment serves to:
 - prevent interference reflections
 - extend the maximum possible measuring range in conical outlets

6.1.6 Beam angle

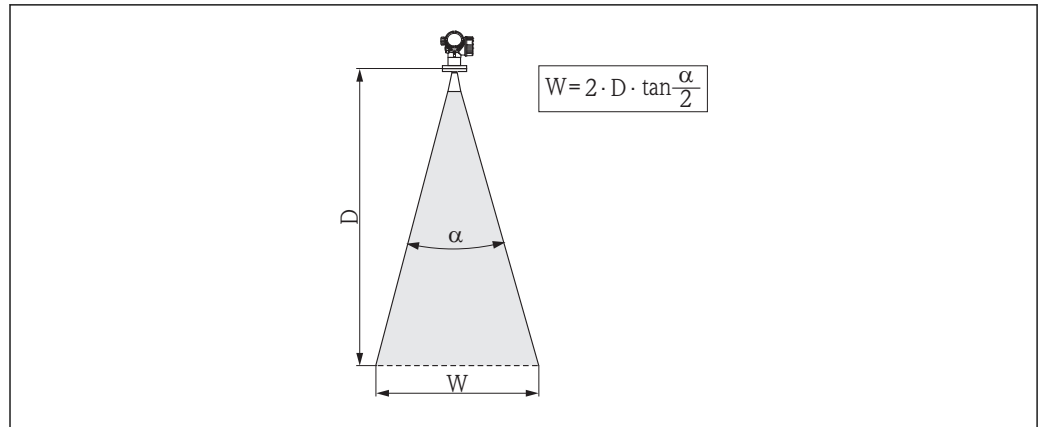

5 Relationship between beam angle α , distance D and beamwidth diameter W

The beam angle is defined as the angle α where the energy density of the radar waves reaches half the value of the maximum energy density (3-dB-width). Microwaves are also emitted outside the signal beam and can be reflected off interfering installations.

Beam diameter W as a function of beam angle α and measuring distance D :

FMR56		
Antenna size	80 mm (3 in)	100 mm (4 in)
Beam angle α	10°	8°
Measuring distance (D)	Beamwidth diameter (W)	
3 m (9.8 ft)	0.53 m (1.7 ft)	0.42 m (1.4 ft)
6 m (20 ft)	1.05 m (3.4 ft)	0.84 m (2.8 ft)
9 m (30 ft)	1.58 m (5.2 ft)	1.26 m (4.1 ft)
12 m (39 ft)	2.1 m (6.9 ft)	1.68 m (5.5 ft)
15 m (49 ft)	2.63 m (8.6 ft)	2.10 m (6.9 ft)
20 m (66 ft)	3.50 m (11 ft)	2.80 m (9.2 ft)
25 m (82 ft)	4.37 m (14 ft)	3.50 m (11 ft)
30 m (98 ft)	5.25 m (17 ft)	4.20 m (14 ft)

FMR57 - Horn antenna		
Antenna size	80 mm (3 in)	100 mm (4 in)
Beam angle α	10°	8°
Measuring distance (D)	Beamwidth diameter W	
5 m (16 ft)	0.87 m (2.9 ft)	0.7 m (2.3 ft)
10 m (33 ft)	1.75 m (5.7 ft)	1.4 m (4.6 ft)
15 m (49 ft)	2.62 m (8.6 ft)	2.1 m (6.9 ft)
20 m (66 ft)	3.50 m (11 ft)	2.80 m (9.2 ft)
30 m (98 ft)	5.25 m (17 ft)	4.20 m (14 ft)
40 m (131 ft)	7.00 m (23 ft)	5.59 m (18 ft)
50 m (164 ft)	8.75 m (29 ft)	6.99 m (23 ft)

FMR57 - Parabolic antenna		
Antenna size	200 mm (8 in)	250 mm (10 in)
Beam angle α	4°	3,5°
Measuring distance (D)	Beamwidth diameter W	
5 m (16 ft)	0.35 m (1.1 ft)	0.30 m (1 ft)
10 m (33 ft)	0.70 m (2.3 ft)	0.61 m (2 ft)
15 m (49 ft)	1.05 m (3.4 ft)	0.92 m (3 ft)
20 m (66 ft)	1.40 m (4.6 ft)	1.22 m (4 ft)
30 m (98 ft)	2.10 m (6.9 ft)	1.83 m (6 ft)
40 m (131 ft)	2.79 m (9.2 ft)	2.44 m (8 ft)
50 m (164 ft)	3.50 m (11 ft)	3.06 m (10 ft)
60 m (197 ft)	4.19 m (14 ft)	3.70 m (12 ft)
70 m (230 ft)	4.90 m (16 ft)	4.28 m (14 ft)

6.2 Measuring conditions

- The measuring range begins, where the beam hits the bottom. Particularly with conical outlets the level cannot be detected below this point. The maximum measuring range can be increased in such applications by using an alignment device .
- In case of media with a low dielectric constant ($\epsilon_r = 1.5$ to 2.5)²⁾, the bottom can be visible through the medium at low levels. In order to guarantee the required accuracy in these cases, it is recommended to position the zero-point at a distance **C** above the bottom (see figure).
- In principle it is possible to measure up to the tip of the antenna with Micropilot. However, due to considerations regarding abrasion and build-up and depending on the orientation of the product surface (angle of repose), the end of the measuring range should be at a distance of **A** (see figure) from the tip of the antenna. If required, and if some conditions (high DC value, flat angle of repose) are met, shorter distances can be achieved.

2) Dielectric constants of important media commonly used in various industries are summarized in the DC manual (CP01076F) and in the Endress+Hauser "DC Values App" (available for Android and iOS).

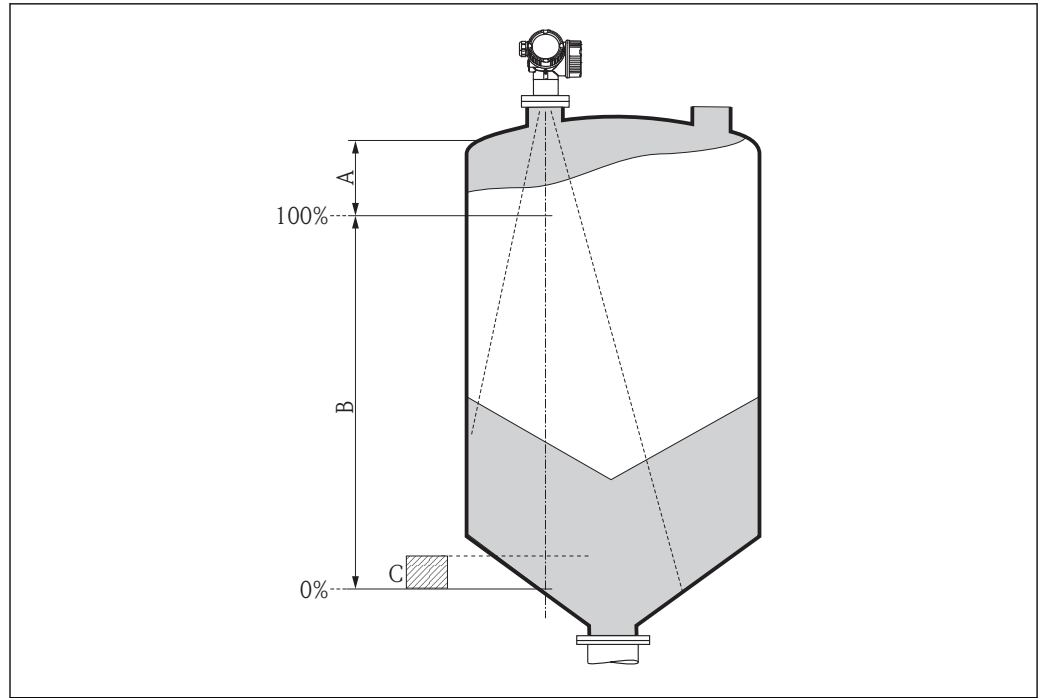

A0016916

Device	A [mm (in)]	C [mm (in)]
FMR56	400(15.7)	50 to 150(1.97 to 5.91)
FMR57		

6.3 Installation in vessel (free space)

6.3.1 Horn antenna with slip-on flange (FMR56)

Alignment

i When using the Micropilot with a slip-on flange in explosion-hazardous areas, strictly observe all specifications in the relevant Safety Instructions (XA).

- Align the antenna vertically to the product surface.
Optionally, a variable flange seal, which is available as an accessory, can be used for alignment (see Technical Information BA01048F, chapter "Accessories").
- A marking at the boss enables alignment of the antenna. This marking must be aligned towards the tank wall as well as possible.

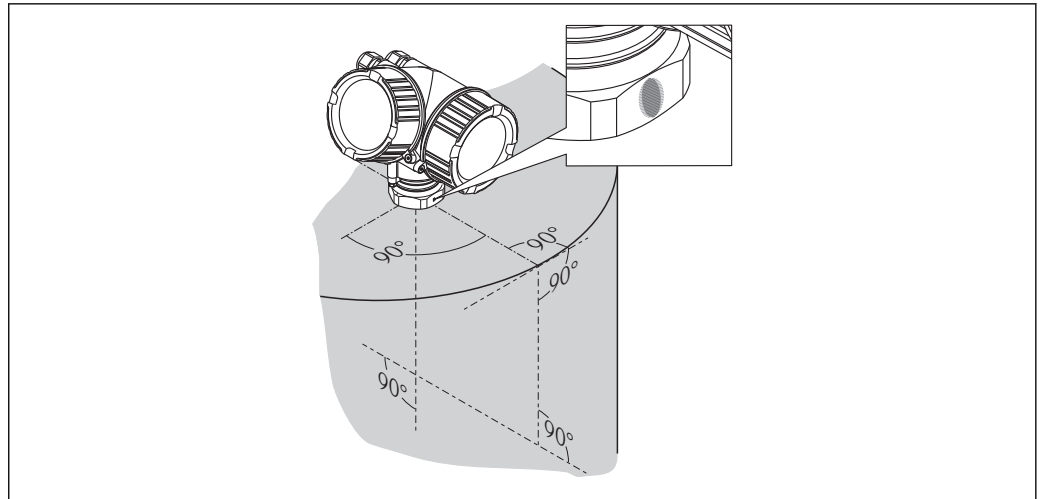

A0019434

i Depending on the device version the marking may be a circle or two short parallel lines.

Nozzle mounting

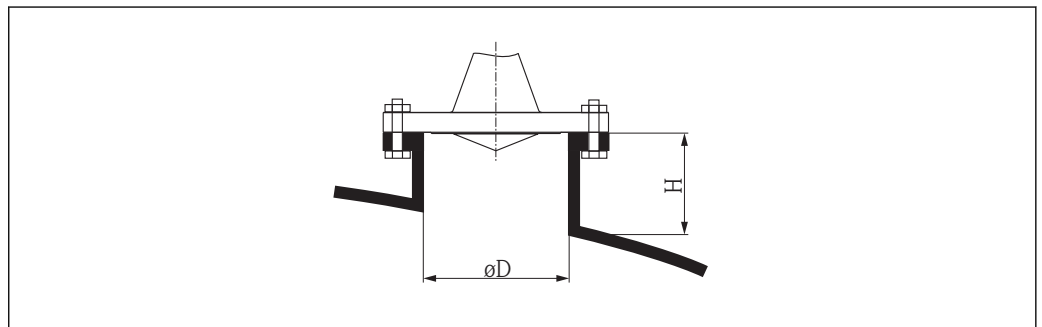



A0016868

6 Nozzle height and diameter for horn antenna with slip-on flange

Nozzle diameter D	Maximum nozzle height H_{max}
80 mm (3 in)	300 mm (11.8 in)
100 mm (4 in)	400 mm (15.8 in)
150 mm (6 in)	500 mm (19.7 in)

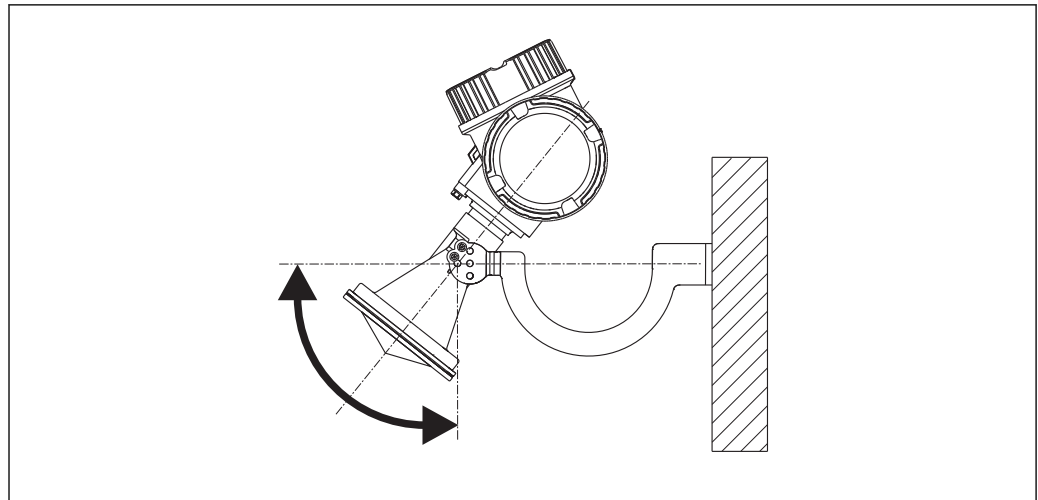
6.3.2 Horn antenna with mounting bracket (FMR56)



 7 Installation of the horn antenna with mounting bracket

A0016865

Align the antenna vertically to the product surface using the mounting bracket.

NOTICE

The mounting bracket has no conductive connection to the transmitter housing.

Danger of electrostatic charge

- ▶ Connect the mounting bracket to the local potential equalization system.

6.3.3 Horn antenna (FMR57)

Alignment

- Ideally, the horn antenna should be installed vertically. To avoid interference reflections or for optimum alignment within the vessel, the Micropilot with optional alignment device can be inclined by 15° in all directions.
- A marking at the boss enables alignment of the antenna. This marking must be aligned towards the tank wall as well as possible.

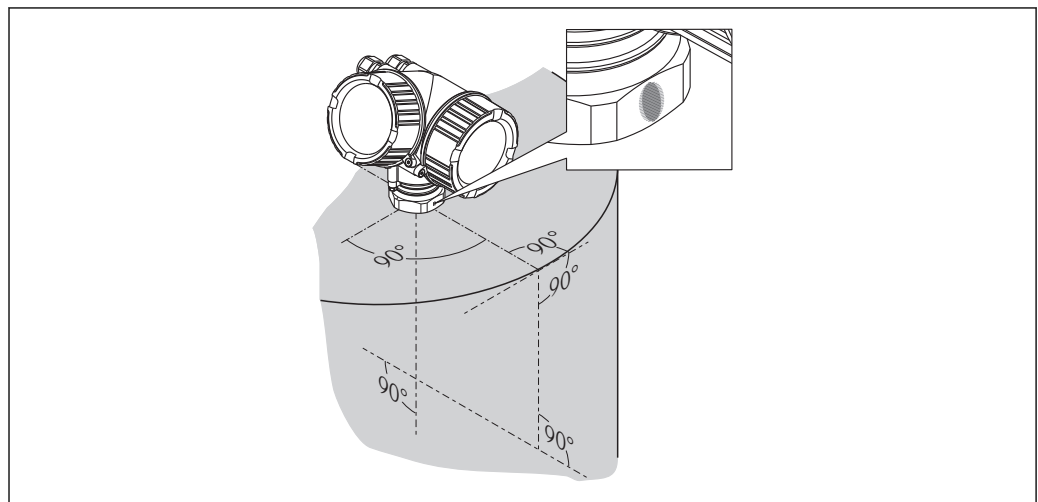

A0019434

 Depending on the device version the marking may be a circle or two short parallel lines.

Nozzle mounting

The horn antenna should protrude from the nozzle. If this is not possible for mechanical reasons, larger nozzle heights can be accepted.

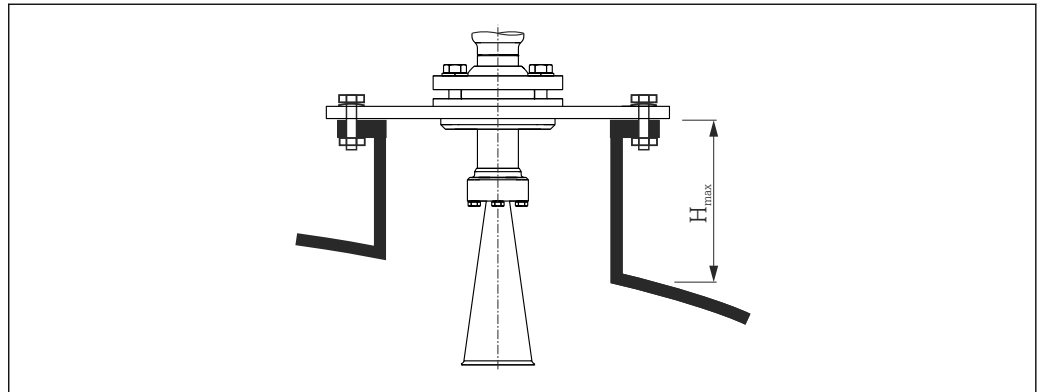

A0016825

 8 Nozzle height for the horn antenna (FMR57)

Antenna ¹⁾	Maximum nozzle height H_{max} ²⁾
BC: Horn 80mm/3"	260 mm (10.2 in)
BD: Horn 100mm/4"	480 mm (18.9 in)

- 1) Feature 070 of the product structure
 2) valid for antennas without antenna extension

 Please contact Endress+Hauser for applications with higher nozzle.

Threaded connection

 For devices with a threaded connection it may be necessary - depending on the antenna size - to unmount the horn before fastening the device and to mount it again afterwards.

- Tighten with the hexagonal nut only.
- Tool : 60 mm hexagonal wrench
- Maximum permissible torque: 60 Nm (44 lbf ft)

6.3.4 Parabolic antenna (FMR57)

Alignment

Ideally, the parabolic antenna should be installed vertically. To avoid interference reflections or for optimum alignment within the vessel, the Micropilot with optional alignment device can be swiveled by 15° in all directions .

Nozzle mounting

- Case 1: Ideally, the parabolic antenna should protrude from the nozzle (1). Particularly when using the alignment device, please ensure that the parabolic reflector is protruding from the nozzle/roof so as not to inhibit alignment.
- Case 2: For applications with higher nozzle it may be necessary to install the parabolic antenna completely in the nozzle (2).

The maximum height of the nozzle (H_{max}) to the parabolic mirror should not exceed 500 mm (19.7 in). Interfering edges within the nozzle should be avoided.

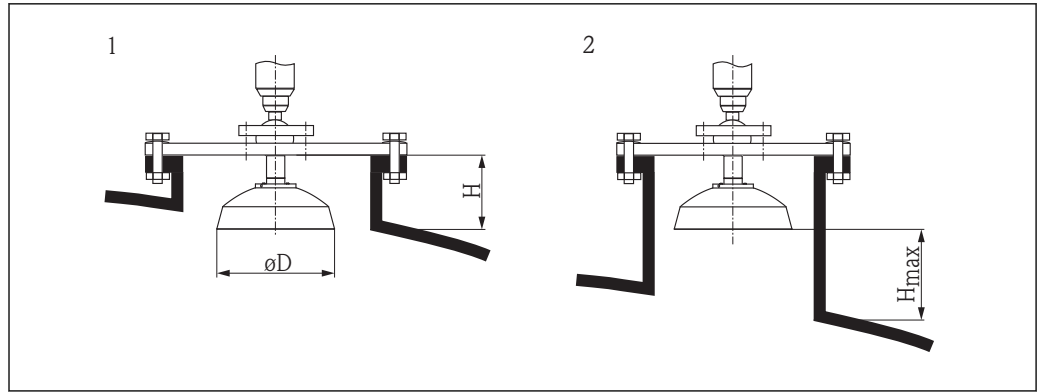

A0016827

9 Nozzle mounting of Micropilot FMR57 with parabolic antenna

- 1 Antenna protrudes from the nozzle
- 2 Antenna completely within the nozzle

Antenna ¹⁾	Antenna diameter D	Nozzle height H for case 1	Maximum nozzle height H_{max} for case 2
FA: Parabol 200mm/8"	173 mm (6.81 in)	< 50 mm (1.97 in)	500 mm (19.7 in)
FB: Parabol 250mm/10"	236 mm (9.29 in)	< 50 mm (1.97 in)	500 mm (19.7 in)

1) Feature 070 of the product structure

Examples for installation with small flange

If the flange is smaller than the parabolic reflector, the device can be mounted in one of the following ways:

- Standard installation (Verweisziel existiert nicht, aber @y.link.required=true)
This requires dismantling of the parabolic reflector.
- Installation with hinged flange (Verweisziel existiert nicht, aber @y.link.required=true)

Standard installation

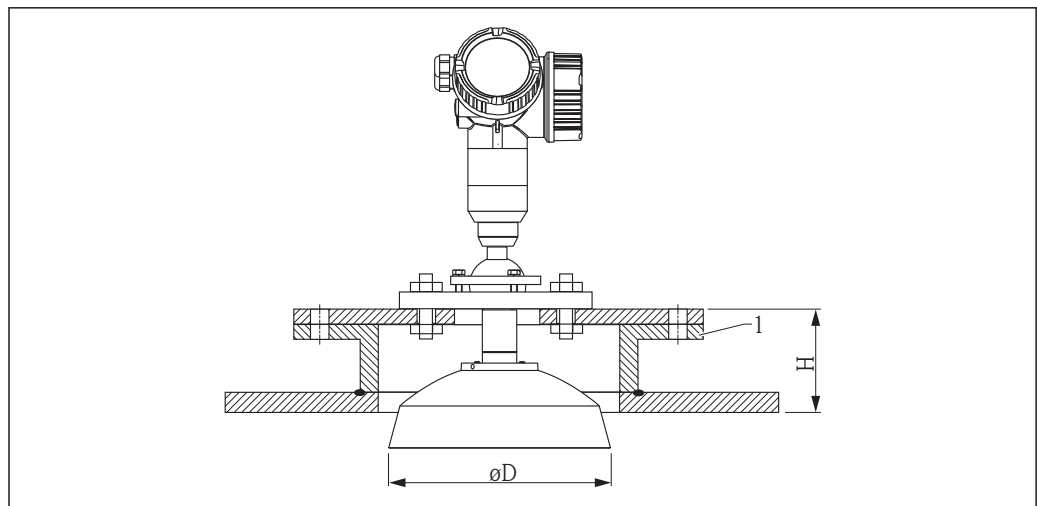

A0018874

1 Nozzle

Antenna size	ϕD	H ¹⁾
200 mm (8 in)	173 mm (6.81 in)	< 50 mm (1.96 in)
250 mm (10 in)	236 mm (9.29 in)	< 50 mm (1.96 in)

1) without antenna extension

Installation with hinged flange

 At hinged flanges, the length of the antenna must be taken into account.

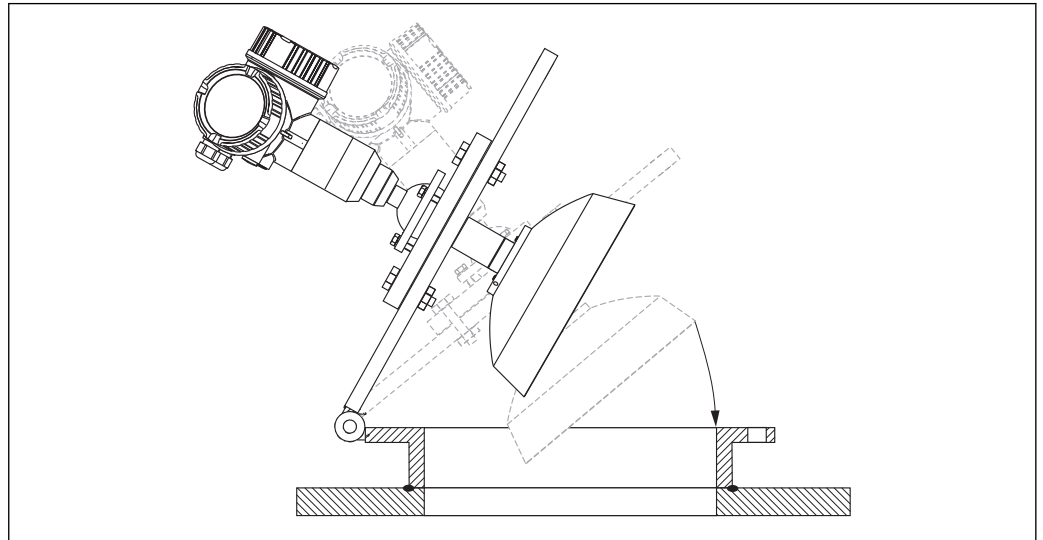

Dismantling the parabolic reflector

For installation in a nozzle, the parabolic reflector can be dismantled:

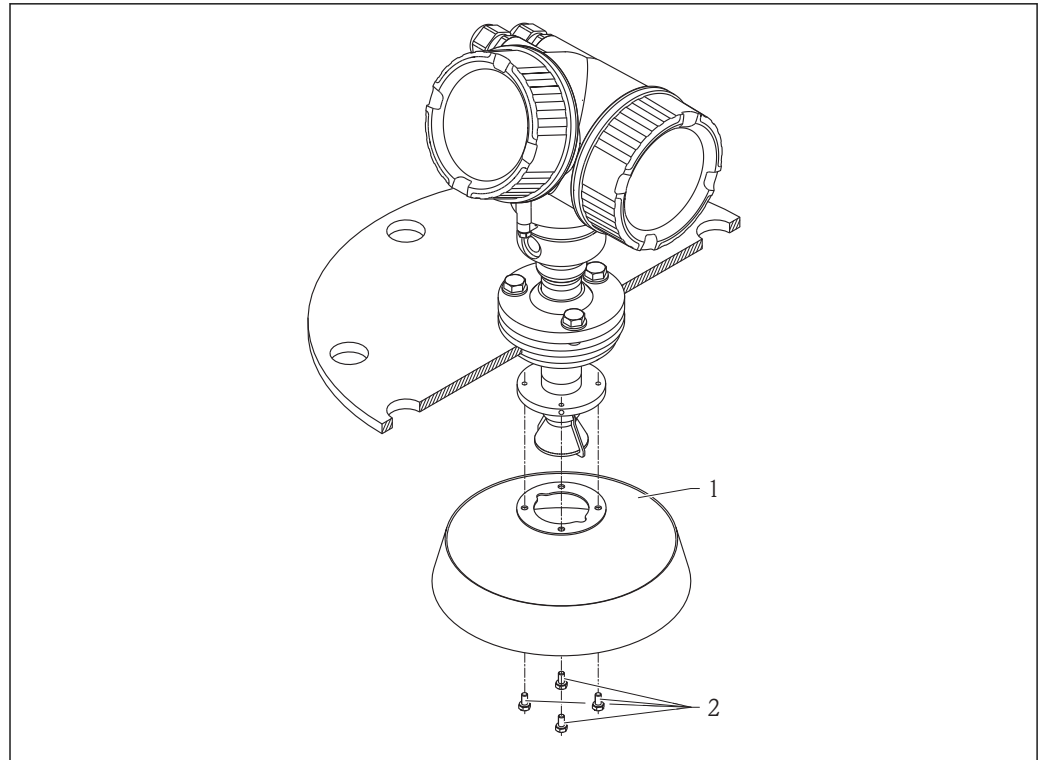

A0018877

- 1 Parabolic reflector
2 4 bolts; torque: 3 Nm (2,2 lbf ft)

6.3.5 Alignment device for FMR57

Using the alignment device it is possible to tilt the antenna axis by up to 15° in all directions. The alignment device is used for the optimum alignment of the radar beam with the bulk solids surface.

Product structure: Feature 100 "Process connection", options XCJ, XEJ, XFJ

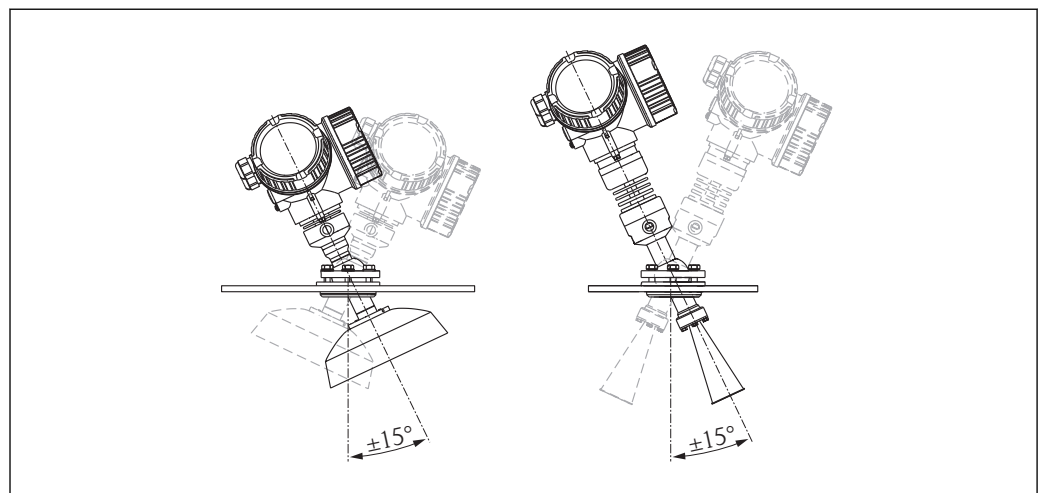

A0016931

10 Micropilot FMR57 with alignment device

Align antenna axis:

1. Loosen screws.
2. Align antenna axis (up to. $\pm 15^\circ$ in all directions).
3. Tighten screws with 15 Nm (11 lbf ft).

6.3.6 Integrated air purge connection for FMR57

In extremely dusty applications, the integrated air purge connection can prevent clogging of the antenna. Pulsed operation is recommended.

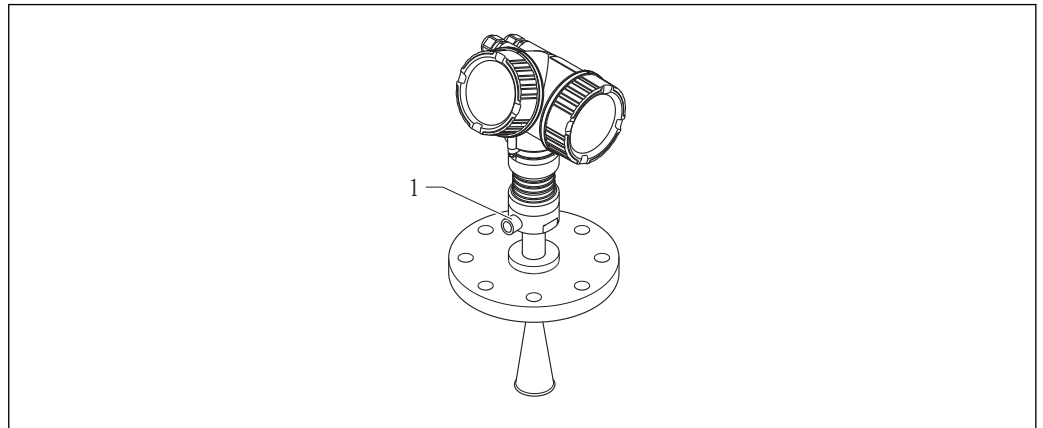

A0016932

 11 Micropilot FMR57 with air purge connection

1 Air purge connection NPT $\frac{1}{4}$ or G $\frac{1}{4}$

Pressure range of the purge air

- Pulsed operation:
max. 6 bar (87 psi)
- Permanent operation:
200 to 500 mbar (3 to 7.25 psi)

Connection of the purge air

- Tools:
 - 13mm (G 1/4) open-end wrench
 - 14 mm (NPT) open-end wrench
 - 17 mm (NPT "adapter") open-end wrench
- min. torque: 6 Nm (4.4 lbf ft)
- max. torque: 7 Nm (5.2 lbf ft)

 Make sure to use dry purge air.

 In general, air purging should only be used as much as necessary, since too much air purging may cause mechanical damage (abrasion).

6.4 Container with heat insulation

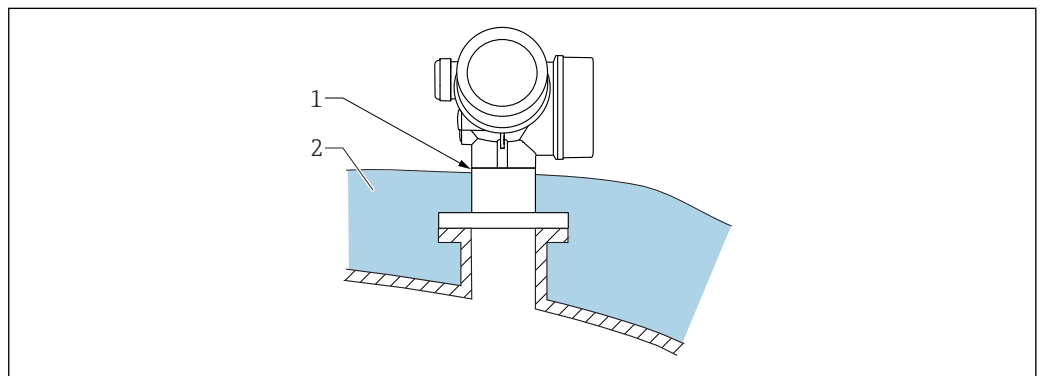

A0032207

If process temperatures are high, the device should be included in the usual container insulation system (2) to prevent the electronics from heating as a result of thermal radiation or convection. The insulation should not be higher than the neck of the device (1).

6.5 Turning the transmitter housing

To provide easier access to the connection compartment or display module, the transmitter housing can be turned:

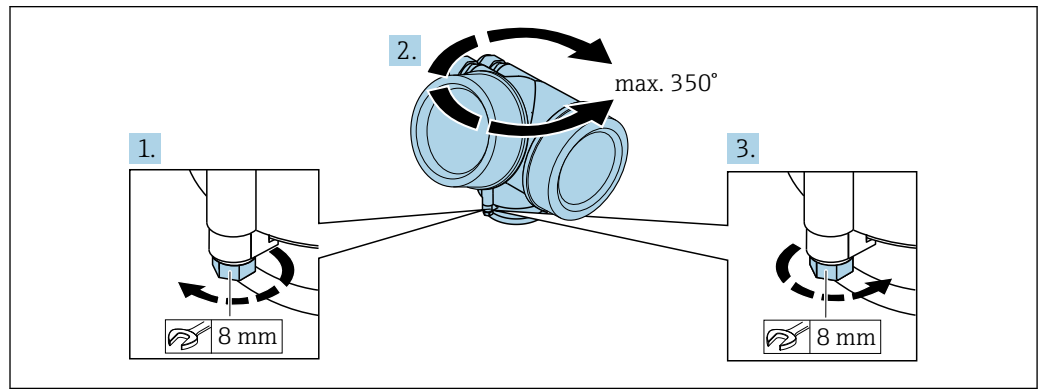

A0032242

1. Unscrew the securing screw using an open-ended wrench.
2. Rotate the housing in the desired direction.
3. Tighten the securing screw (1.5 Nm for plastic housing; 2.5 Nm for aluminum or stainless steel housing).

6.6 Turning the display

6.6.1 Opening cover

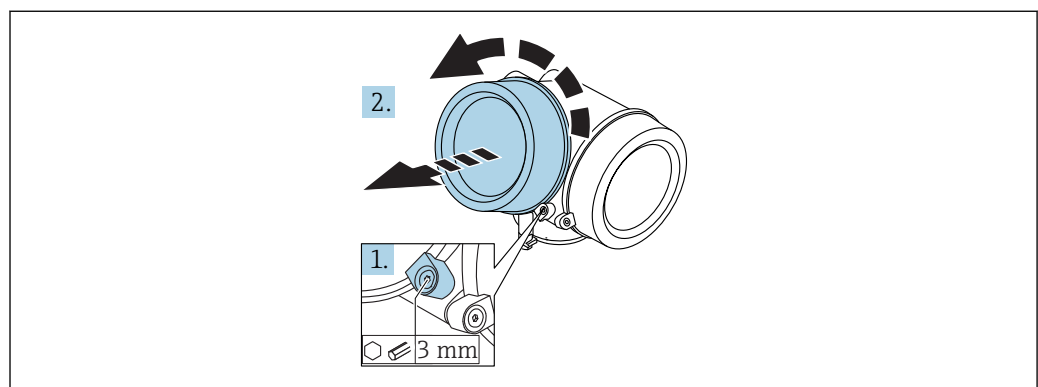

A0021430

1. Loosen the screw of the securing clamp of the electronics compartment cover using an Allen key (3 mm) and turn the clamp 90 ° counterclockwise.
2. Unscrew cover and check lid gasket, replace if necessary.

6.6.2 Turning the display module

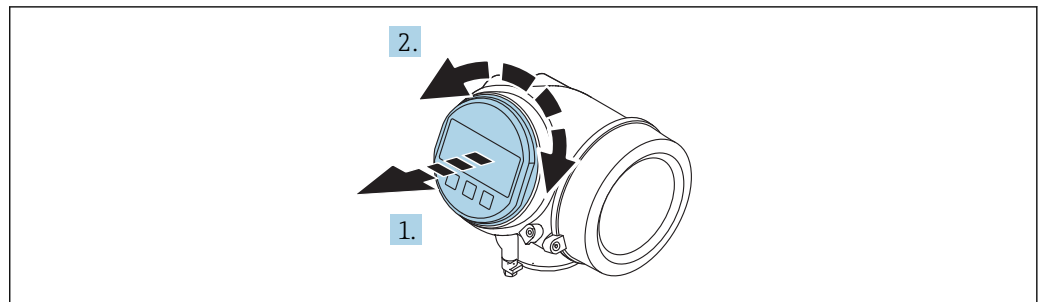

A0036401

1. Pull out the display module with a gentle rotational movement.
2. Rotate the display module to the desired position: max. $8 \times 45^\circ$ in each direction.
3. Feed the coiled cable into the gap between the housing and main electronics module and plug the display module into the electronics compartment until it engages.

6.6.3 Closing electronics compartment cover

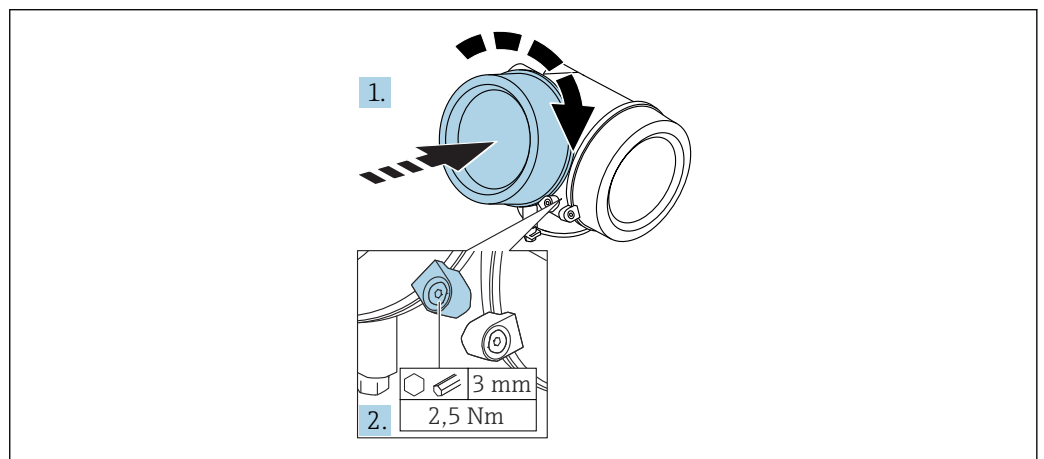

A0021451

1. Screw back firmly electronics compartment cover.
2. Turning securing clamp 90° clockwise and tighten the clamp with 2.5 Nm using the Allen key (3 mm).

6.7 Post-installation check

<input type="checkbox"/>	Is the device undamaged (visual inspection)?
<input type="checkbox"/>	Does the device conform to the measuring point specifications? For example: <ul style="list-style-type: none"> ▪ Process temperature ▪ Process pressure (refer to the chapter on "Material load curves" of the "Technical Information" document) ▪ Ambient temperature range ▪ Measuring range
<input type="checkbox"/>	Are the measuring point identification and labeling correct (visual inspection)?
<input type="checkbox"/>	Is the device adequately protected from precipitation and direct sunlight?
<input type="checkbox"/>	Are the securing screw and securing clamp tightened securely?

7 Electrical connection

7.1 Connection conditions

7.1.1 Terminal assignment

Terminal assignment 2-wire: 4-20 mA HART

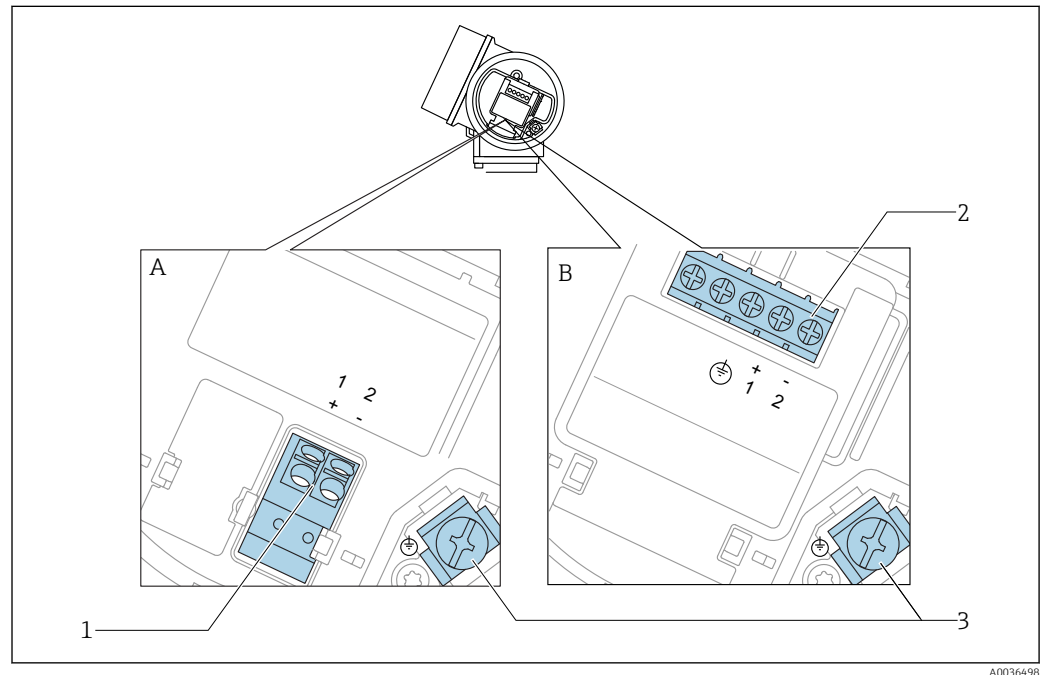

12 Terminal assignment 2-wire: 4-20 mA HART

A Without integrated overvoltage protection

B With integrated overvoltage protection

1 Connection 4-20 mA HART passive: terminals 1 and 2, without integrated overvoltage protection

2 Connection 4-20 mA HART passive: terminals 1 and 2, with integrated overvoltage protection

3 Terminal for cable screen

Block diagram 2-wire: 4-20 mA HART

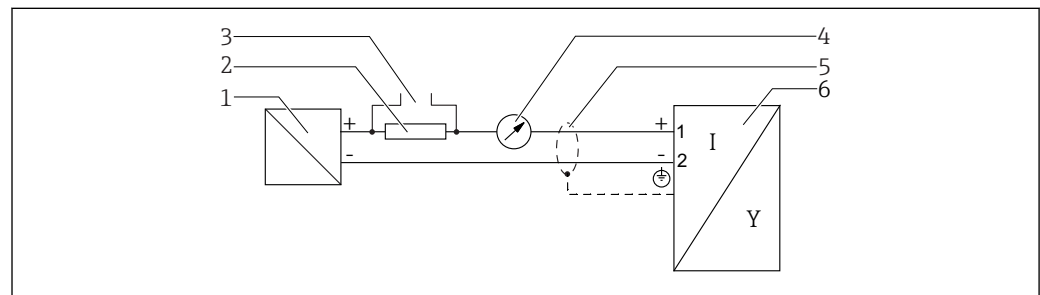

13 Block diagram 2-wire: 4-20 mA HART

1 Active barrier with power supply (e.g. RN221N); observe terminal voltage

2 HART communication resistor ($\geq 250 \Omega$); observe maximum load

3 Connection for Commubox FXA195 or FieldXpert SFX350/SFX370 (via VIATOR Bluetooth modem)

4 Analog display device; observe maximum load

5 Cable screen; observe cable specification

6 Measuring device

Terminal assignment 2-wire: 4-20 mA HART, switch output

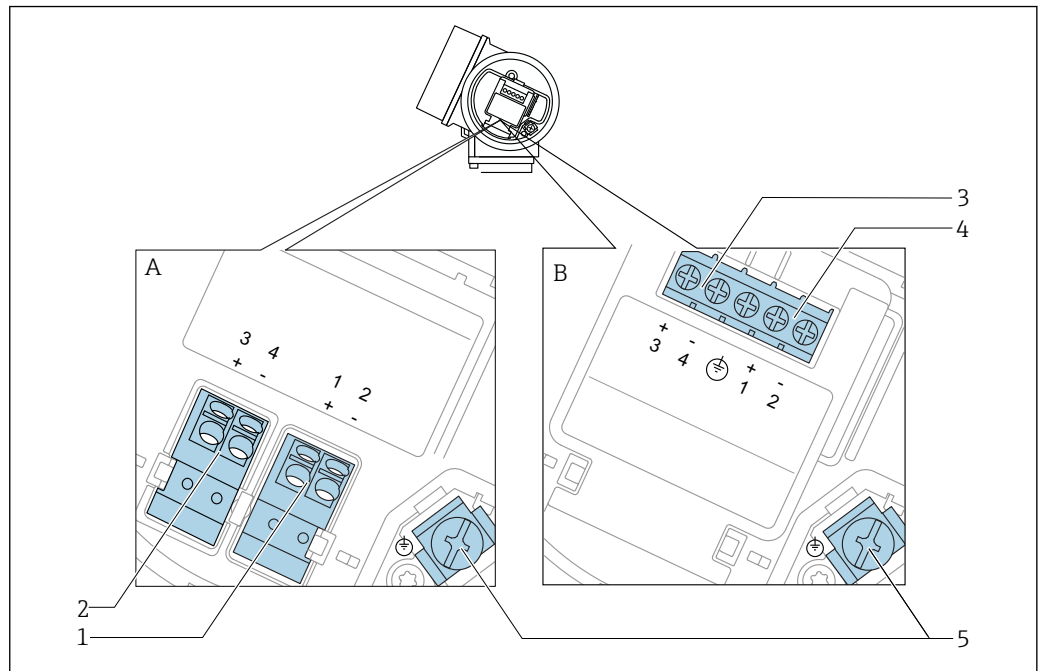

A0036500

14 Terminal assignment 2-wire: 4-20 mA HART, switch output

A Without integrated overvoltage protection

B With integrated overvoltage protection

1 Connection 4-20 mA HART passive: terminals 1 and 2, without integrated overvoltage protection

2 Connection switch output (Open Collector): terminals 3 and 4, without integrated overvoltage protection

3 Connection switch output (Open Collector): terminals 3 and 4, with integrated overvoltage protection

4 Connection 4-20 mA HART passive: terminals 1 and 2, with integrated overvoltage protection

5 Terminal for cable screen

Block diagram 2-wire: 4-20 mA HART, switch output

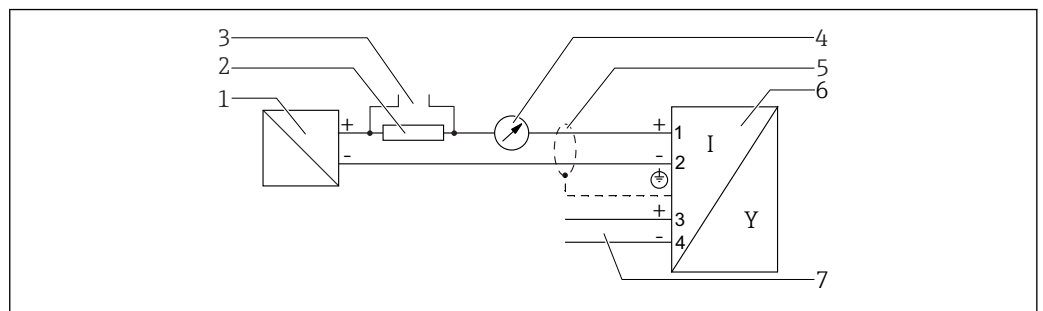

A0036501

15 Block diagram 2-wire: 4-20 mA HART, switch output

1 Active barrier with power supply (e.g. RN221N); observe terminal voltage

2 HART communication resistor ($\geq 250 \Omega$); observe maximum load

3 Connection for Commubox FXA195 or FieldXpert SFX350/SFX370 (via VIATOR Bluetooth modem)

4 Analog display device; observe maximum load

5 Cable screen; observe cable specification

6 Measuring device

7 Switch output (Open Collector)

Terminal assignment 2-wire: 4-20 mA HART, 4-20 mA

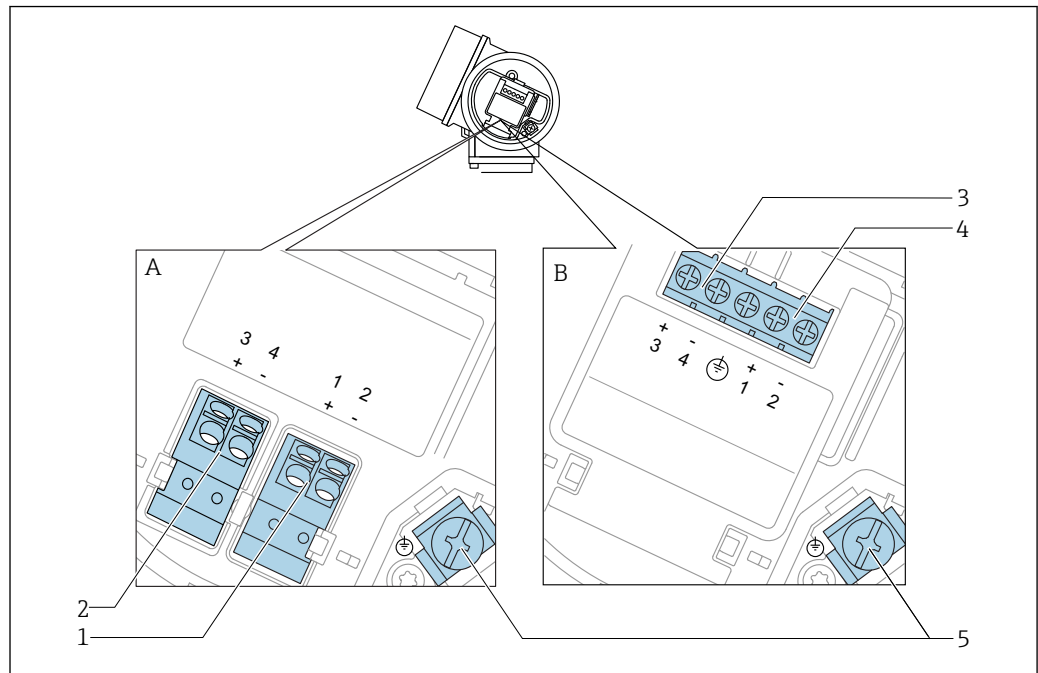

A0036500

16 Terminal assignment 2-wire: 4-20 mA HART, 4-20 mA

A Without integrated overvoltage protection

B With integrated overvoltage protection

1 Connection current output 1, 4-20 mA HART passive: terminals 1 and 2, without integrated overvoltage protection

2 Connection current output 2, 4-20 mA: terminals 3 and 4, without integrated overvoltage protection

3 Connection current output 2, 4-20 mA: terminals 3 and 4, with integrated overvoltage protection

4 Connection current output 1, 4-20 mA HART passive: terminals 1 and 2, with integrated overvoltage protection

5 Terminal for cable screen

Block diagram 2-wire: 4-20 mA HART, 4-20 mA

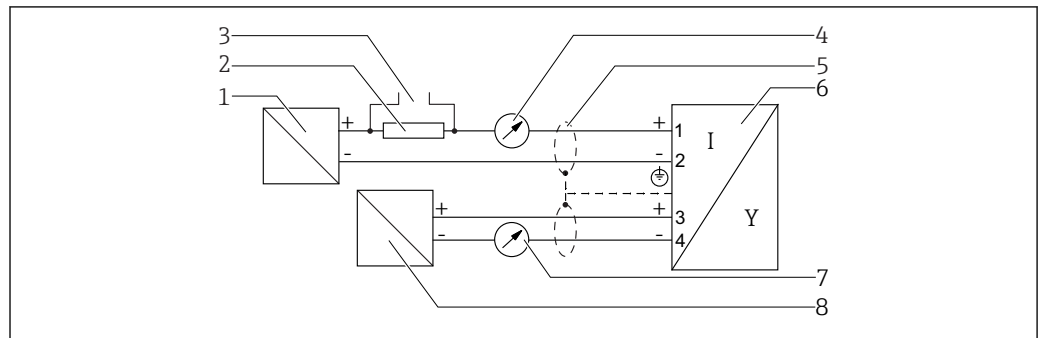

A0036502

17 Block diagram 2-wire: 4-20 mA HART, 4-20 mA

1 Active barrier with power supply (e.g. RN221N); observe terminal voltage

2 HART communication resistor ($\geq 250 \Omega$); observe maximum load

3 Connection for Commubox FXA195 or FieldXpert SFX350/SFX370 (via VIATOR Bluetooth modem)

4 Analog display device; observe maximum load

5 Cable screen; observe cable specification

6 Measuring device

7 Analog display device; observe maximum load

8 Active barrier with power supply (e.g. RN221N), current output 2; observe terminal voltage

Terminal assignment 4-wire: 4-20 mA HART (10.4 to 48 V_{DC})

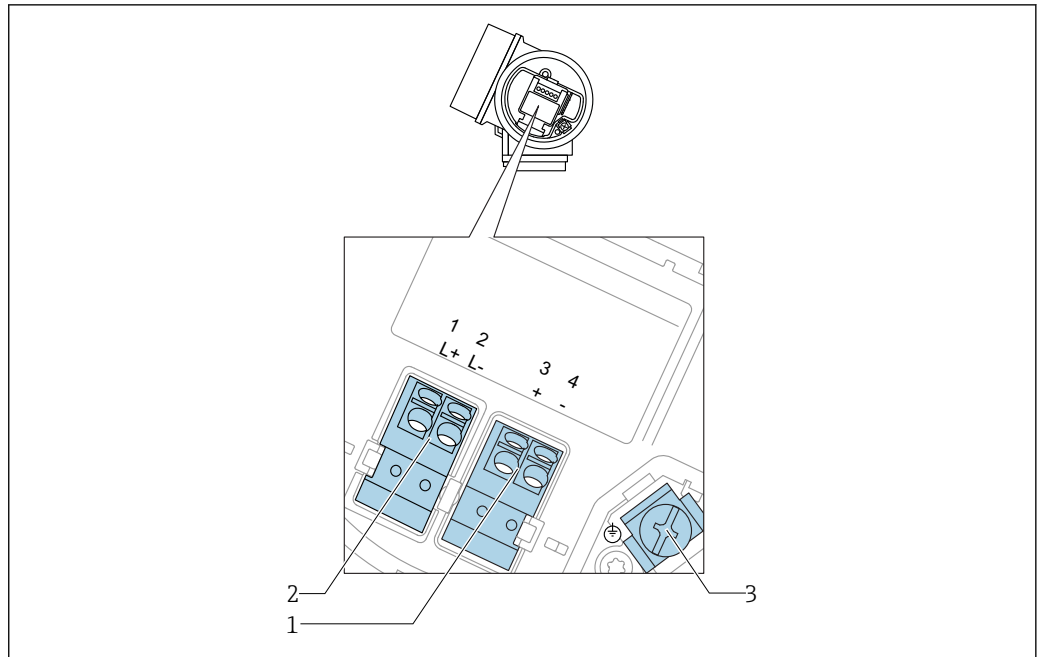

A0036516

18 Terminal assignment 4-wire: 4-20 mA HART (10.4 to 48 V_{DC})

- 1 Connection 4-20 mA HART (active): terminals 3 and 4
- 2 Connection supply voltage: terminals 1 and 2
- 3 Terminal for cable screen

Block diagram 4-wire: 4-20 mA HART (10.4 to 48 V_{DC})

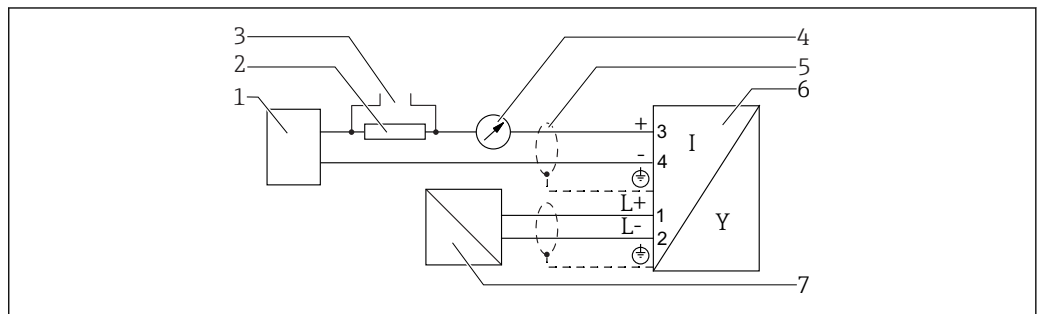

A0036526

19 Block diagram 4-wire: 4-20 mA HART (10.4 to 48 V_{DC})

- 1 Evaluation unit, e.g. PLC
- 2 HART communication resistor ($\geq 250 \Omega$); observe maximum load
- 3 Connection for Commubox FXA195 or FieldXpert SFX350/SFX370 (via VIATOR Bluetooth modem)
- 4 Analog display device; observe maximum load
- 5 Cable screen; observe cable specification
- 6 Measuring device
- 7 Supply voltage; observe terminal voltage, observe cable specification

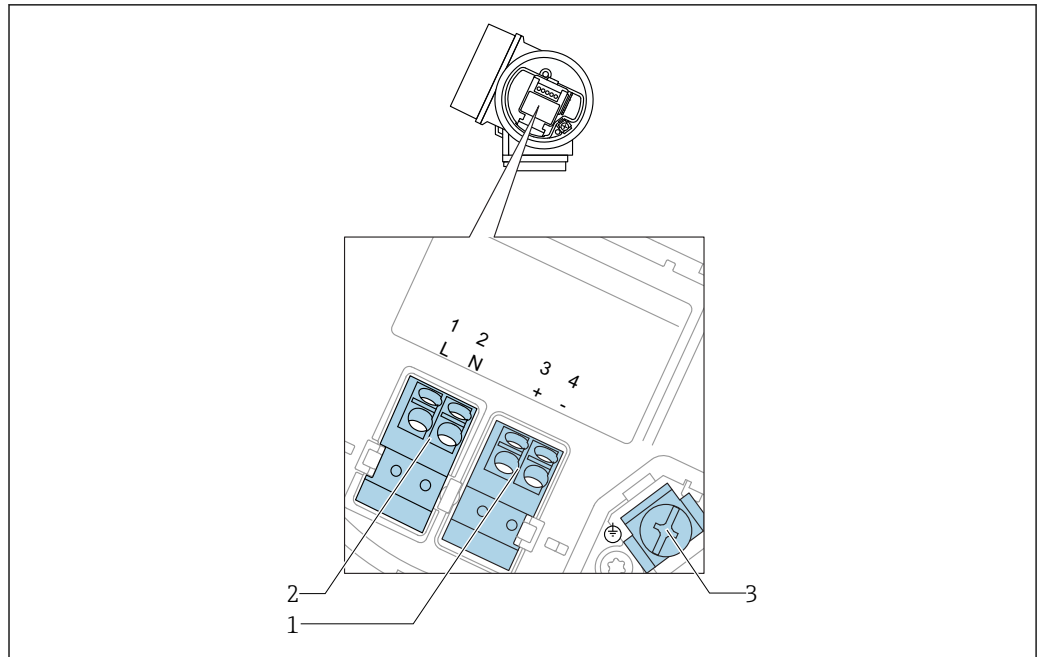
Terminal assignment 4-wire: 4-20 mA HART (90 to 253 V_{AC})



A0036519

 20 Terminal assignment 4-wire: 4-20 mA HART (90 to 253 V_{AC})

- 1 Connection 4-20 mA HART (active): terminals 3 and 4
- 2 Connection supply voltage: terminals 1 and 2
- 3 Terminal for cable screen

⚠ CAUTION**To ensure electrical safety:**

- ▶ Do not disconnect the protective connection.
- ▶ Disconnect the supply voltage before disconnecting the protective earth.

-  Connect protective earth to the internal ground terminal (3) before connecting the supply voltage. If necessary, connect the potential matching line to the external ground terminal.
-  In order to ensure electromagnetic compatibility (EMC): Do **not** only ground the device via the protective earth conductor of the supply cable. Instead, the functional grounding must also be connected to the process connection (flange or threaded connection) or to the external ground terminal.
-  An easily accessible power switch must be installed in the proximity of the device. The power switch must be marked as a disconnector for the device (IEC/EN61010).

Block diagram 4-wire: 4-20 mA HART (90 to 253 V_{AC})

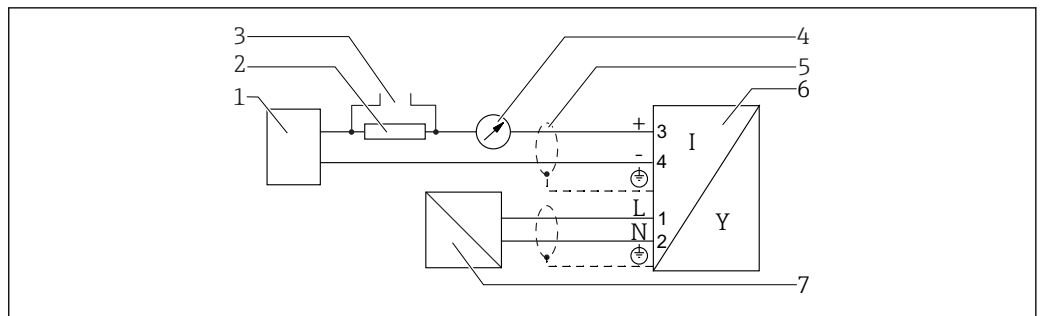

A0036527

21 Block diagram 4-wire: 4-20 mA HART (90 to 253 V_{AC})

- 1 Evaluation unit, e.g. PLC
- 2 HART communication resistor ($\geq 250 \Omega$); observe maximum load
- 3 Connection for Commubox FXA195 or FieldXpert SFX350/SFX370 (via VIATOR Bluetooth modem)
- 4 Analog display device; observe maximum load
- 5 Cable scree; observe cable specification
- 6 Measuring device
- 7 Supply voltage; observe terminal voltage, observe cable specification

Connection examples for the switch output

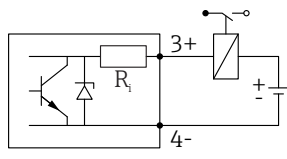
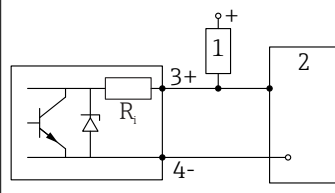
 <p>22 Connection of a relay</p> <p>Suitable relays (examples):</p> <ul style="list-style-type: none"> ▪ Solid-state relay: Phoenix Contact OV-24DC/480AC/5 with mounting rail connector UMK-1 OM-R/AMS ▪ Electromechanical relay: Phoenix Contact PLC-RSC-12DC/21 	 <p>23 Connection of a digital input</p> <p>1 Pull-up resistor 2 Digital input</p>
--	--

i For optimum interference immunity we recommend to connect an external resistor (internal resistance of the relay or Pull-up resistor) of $< 1\,000\ \Omega$.

7.1.2 Cable specification

▪ Devices without integrated overvoltage protection

Pluggable spring-force terminals for wire cross-sections 0.5 to 2.5 mm² (20 to 14 AWG)

▪ Devices with integrated overvoltage protection

Screw terminals for wire cross-sections 0.2 to 2.5 mm² (24 to 14 AWG)

- For ambient temperature $T_U \geq 60\ ^\circ\text{C}$ (140 °F): use cable for temperature $T_U + 20\ \text{K}$.

HART

- A normal device cable suffices if only the analog signal is used.
- A shielded cable is recommended if using the HART protocol. Observe grounding concept of the plant.
- For 4-wire devices: Standard device cable is sufficient for the power line.

7.1.3 Device plug connectors

i For the versions with fieldbus plug connector (M12 or 7/8"), the signal line can be connected without opening the housing.

Pin assignment of the M12 plug connector

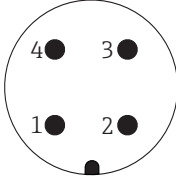
 <p style="text-align: right; font-size: small;">A0011175</p>	Pin	Meaning
	1	Signal +
	2	not connected
	3	Signal -
	4	Ground

Pin assignment of the 7/8" plug connector

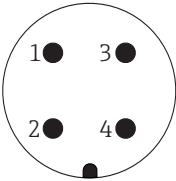
 <p style="text-align: right; font-size: small;">A0011176</p>	Pin	Meaning
	1	Signal -
	2	Signal +
	3	Not connected
	4	Screen

7.1.4 Supply voltage

2-wire, 4-20mA HART, passive

"Power Supply, Output" ¹⁾	"Approval" ²⁾	Terminal voltage U at the device	Maximum load R, depending on the supply voltage U ₀ at the supply unit
A: 2-wire; 4-20mA HART	<ul style="list-style-type: none"> ■ Non-Ex ■ Ex nA ■ Ex ic ■ CSA GP 	10.4 to 35 V ^{3) 4) 5)}	
	Ex ia / IS	10.4 to 30 V ^{3) 4) 5)}	
	<ul style="list-style-type: none"> ■ Ex d(ia) / XP ■ Ex ic(ia) ■ Ex nA(ia) ■ Ex ta / DIP 	13 to 35 V ^{5) 6)}	
Ex ia + Ex d(ia) / IS + XP	13 to 30 V ^{5) 6)}		

- 1) Feature 020 of the product structure
- 2) Feature 010 of the product structure
- 3) For ambient temperatures T_a ≤ -20 °C (-4 °F) a minimum voltage of 15 V is required for the startup of the device at the minimum error current (3,6 mA). The startup current can be parametrized. If the device is operated with a fixed current I ≥ 5,5 mA (HART multidrop mode), a voltage of U ≥ 10,4 V is sufficient throughout the entire range of ambient temperatures.
- 4) In the current simulation mode a voltage U ≥ 12.5 V is required.
- 5) If the Bluetooth modem is used, the minimum supply voltage increases by 3 V.
- 6) For ambient temperatures T_a ≤ -20 °C (-4 °F) a minimum voltage of 16 V is required for the startup of the device at the minimum error current (3.6 mA).

"Power Supply, Output" ¹⁾	"Approval" ²⁾	Terminal voltage U at the device	Maximum load R, depending on the supply voltage U ₀ at the supply unit
B: 2-wire; 4-20 mA HART, switch output	<ul style="list-style-type: none"> ■ Non-Ex ■ Ex nA ■ Ex nA(ia) ■ Ex ic ■ Ex ic(ia) ■ Ex d(ia) / XP ■ Ex ta / DIP ■ CSA GP 	13 to 35 V ^{3) 4)}	
	<ul style="list-style-type: none"> ■ Ex ia / IS ■ Ex ia + Ex d(ia) / IS + XP 	13 to 30 V ^{3) 4)}	

- 1) Feature 020 of the product structure
- 2) Feature 010 of the product structure
- 3) For ambient temperatures T_a ≤ -30 °C (-22 °F) a minimum voltage of 16 V is required for the startup of the device at the minimum error current (3.6 mA).
- 4) If the Bluetooth modem is used, the minimum supply voltage increases by 3 V.

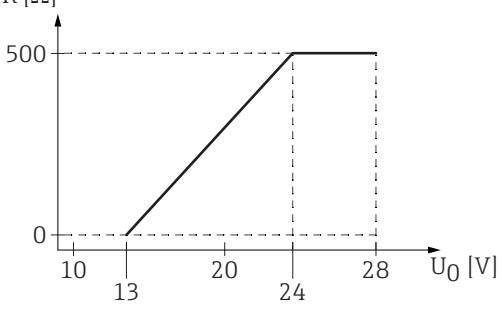
"Power Supply, Output" ¹⁾	"Approval" ²⁾	Terminal voltage U at the device	Maximum load R, depending on the supply voltage U ₀ at the supply unit
C: 2-wire; 4-20mA HART, 4-20mA	any	13 to 28 V ^{3) 4)}	 <p>The graph plots Maximum load R [Ω] on the y-axis (0 to 500) against supply voltage U₀ [V] on the x-axis (10 to 28). The load is zero for U₀ < 13 V. It starts at 13 V and increases linearly to 500 Ω at 24 V. From 24 V to 28 V, the load remains constant at 500 Ω.</p>

A0034841

- 1) Feature 020 of the product structure
- 2) Feature 010 of the product structure
- 3) For ambient temperatures T_a ≤ -30 °C (-22 °F) a minimum voltage of 16 V is required for the startup of the device at the minimum error current (3.6 mA).
- 4) If the Bluetooth modem is used, the minimum supply voltage increases by 3 V.

Polarity reversal protection	Yes
Admissible residual ripple at f = 0 to 100 Hz	U _{SS} < 1 V
Admissible residual ripple at f = 100 to 10000 Hz	U _{SS} < 10 mV

4-wire, 4-20mA HART, active

"Power supply; Output" ¹⁾	Terminal voltage	Maximum load R_{max}
K: 4-wire 90-253VAC; 4-20mA HART	90 to 253 V _{AC} (50 to 60 Hz), overvoltage category II	500 Ω
L: 4-wire 10,4-48VDC; 4-20mA HART	10.4 to 48 V _{DC}	

1) Feature 020 of the product structure

7.1.5 Overvoltage protection

If the measuring device is used for level measurement in flammable liquids which requires the use of overvoltage protection according to DIN EN 60079-14, standard for test procedures 60060-1 (10 kA, pulse 8/20 μs), an overvoltage protection module has to be installed.

Integrated overvoltage protection module

An integrated overvoltage protection module is available for 2-wire HART as well as PROFIBUS PA and FOUNDATION Fieldbus devices.

Product structure: Feature 610 "Accessory mounted", option NA "Overvoltage protection".

Technical data	
Resistance per channel	2 × 0.5 Ω max.
Threshold DC voltage	400 to 700 V
Threshold impulse voltage	< 800 V
Capacitance at 1 MHz	< 1.5 pF
Nominal arrest impulse voltage (8/20 μs)	10 kA

External overvoltage protection module

HAW562 or HAW569 from Endress+Hauser are suited as external overvoltage protection.

7.2 Connecting the measuring device**⚠ WARNING****Risk of explosion!**

- ▶ Observe applicable national standards.
- ▶ Comply with the specifications in the Safety Instructions (XA).
- ▶ Use specified cable glands only.
- ▶ Check to ensure that the power supply matches the information on the nameplate.
- ▶ Switch off the power supply before connecting the device.
- ▶ Connect the potential matching line to the outer ground terminal before applying the power supply.

Required tools/accessories:

- For devices with a cover lock: Allen key AF3
- Wire stripper
- When using stranded cables: One ferrule for every wire to be connected.

7.2.1 Opening connection compartment cover

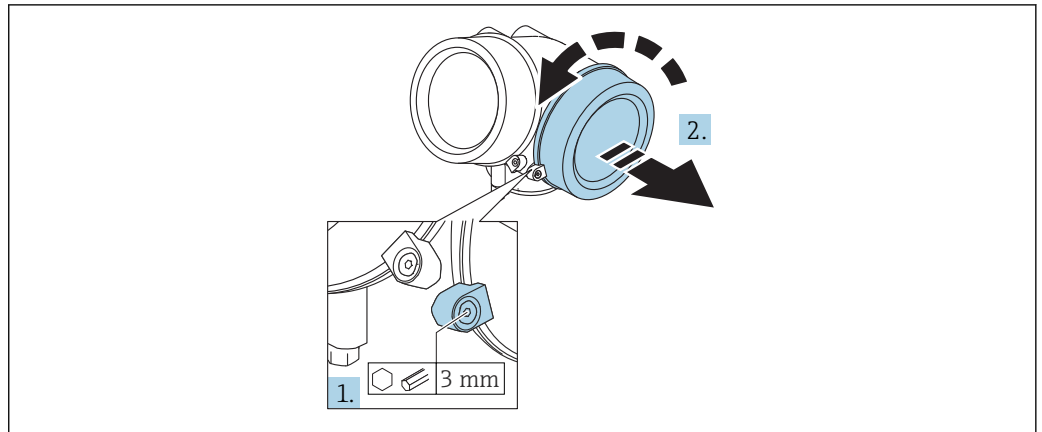

A0021490

1. Loosen the screw of the securing clamp of the connection compartment cover using an Allen key (3 mm) and turn the clamp 90° clockwise.
2. Afterwards unscrew connection compartment cover and check lid gasket, replace if necessary.

7.2.2 Connecting

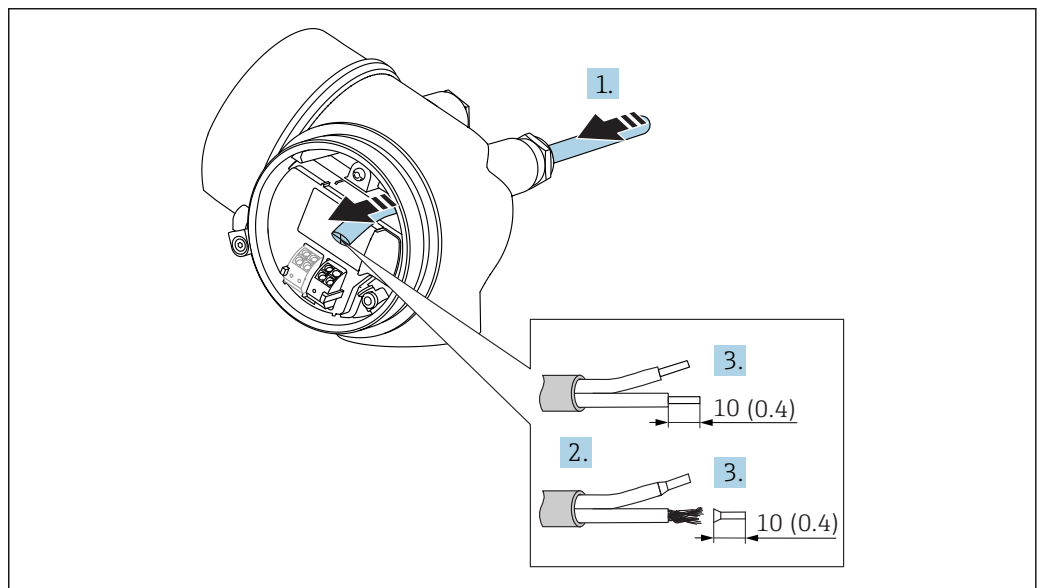

A0036418

24 Dimensions: mm (in)

1. Push the cable through the cable entry . To ensure tight sealing, do not remove the sealing ring from the cable entry.
2. Remove the cable sheath.
3. Strip the cable ends over a length of 10 mm (0.4 in). In the case of stranded cables, also fit ferrules.
4. Firmly tighten the cable glands.

5. Connect the cable in accordance with the terminal assignment.

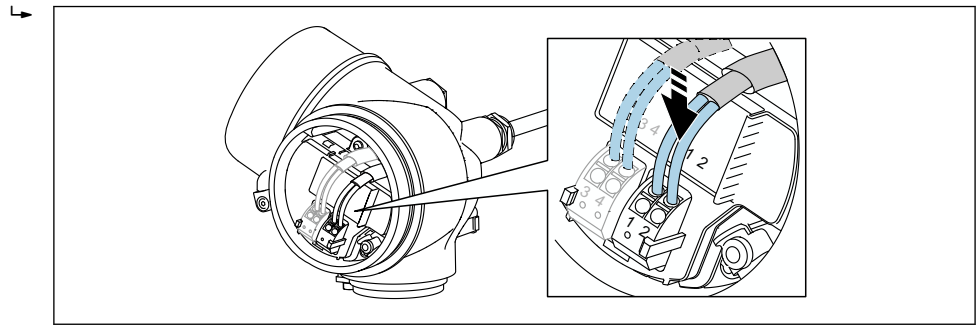

A0034682

6. If using shielded cables: Connect the cable shield to the ground terminal.

7.2.3 Plug-in spring-force terminals

In the case of devices without integrated overvoltage protection, electrical connection is via plug-in spring-force terminals. Rigid conductors or flexible conductors with ferrules can be inserted directly into the terminal without using the lever, and create a contact automatically.

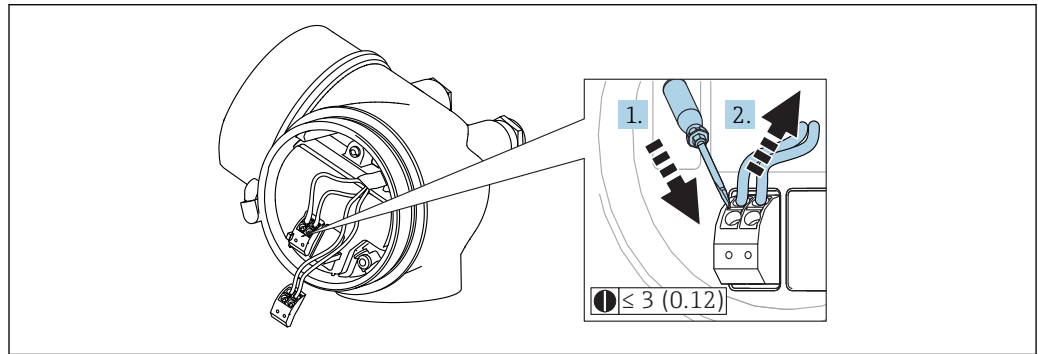

A0013661

25 Dimensions: mm (in)

To remove cables from the terminal:

1. Using a flat-blade screwdriver ≤ 3 mm, press down on the slot between the two terminal holes
2. while simultaneously pulling the cable end out of the terminal.

7.2.4 Closing connection compartment cover

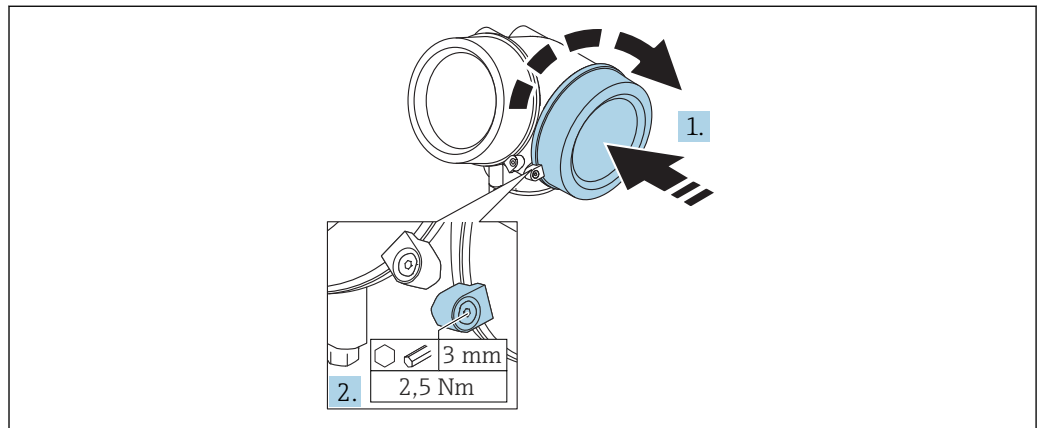

A0021491

1. Screw back firmly connection compartment cover.
2. Turning securing clamp 90 ° counterclockwise and tighten the clamp with 2.5 Nm (1.84 lbf ft) again using the Allen key (3 mm).

7.3 Post-connection check

<input type="checkbox"/>	Is the device or cable undamaged (visual check)?
<input type="checkbox"/>	Do the cables comply with the requirements ?
<input type="checkbox"/>	Do the cables have adequate strain relief?
<input type="checkbox"/>	Are all cable glands installed, securely tightened and leak-tight?
<input type="checkbox"/>	Does the supply voltage match the specifications on the nameplate?
<input type="checkbox"/>	Is the terminal assignment correct?
<input type="checkbox"/>	If required: Has protective ground connection been established ?
<input type="checkbox"/>	If supply voltage is present, is the device ready for operation and do values appear on the display module?
<input type="checkbox"/>	Are all housing covers installed and securely tightened?
<input type="checkbox"/>	Is the securing clamp tightened correctly?

8 Operation options

8.1 Overview

8.1.1 Local operation

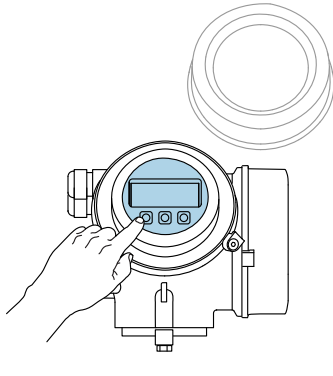
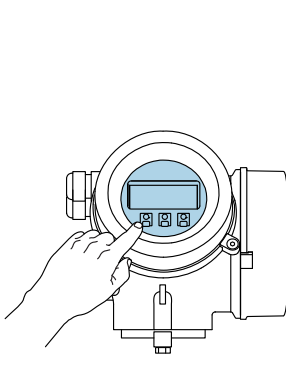
Operation with	<i>Pushbuttons</i>	<i>Touch Control</i>
Order code for "Display; Operation"	Option C "SD02"	Option E "SD03"
	 A line drawing of the Micropilot FMR56 device with its top cover removed. A hand is shown pressing one of the three physical pushbuttons on the front panel. The device has a 4-line display and various connection points. A reference code A0036312 is visible at the bottom right of the diagram.	 A line drawing of the Micropilot FMR57 device with its top cover removed. A hand is shown touching the front panel of the device. The device has a 4-line display and various connection points. A reference code A0036313 is visible at the bottom right of the diagram.
Display elements	4-line display	4-line display white background lighting; switches to red in event of device error
	Format for displaying measured variables and status variables can be individually configured	
	Permitted ambient temperature for the display: -20 to +70 °C (-4 to +158 °F) The readability of the display may be impaired at temperatures outside the temperature range.	
Operating elements	local operation with 3 push buttons (⊕, ⊖, ⊞)	external operation via touch control; 3 optical keys: ⊕, ⊖, ⊞
	Operating elements also accessible in various hazardous areas	
Additional functionality	Data backup function The device configuration can be saved in the display module.	
	Data comparison function The device configuration saved in the display module can be compared to the current device configuration.	
	Data transfer function The transmitter configuration can be transmitted to another device using the display module.	

8.1.2 Operation with remote display and operating module FHX50

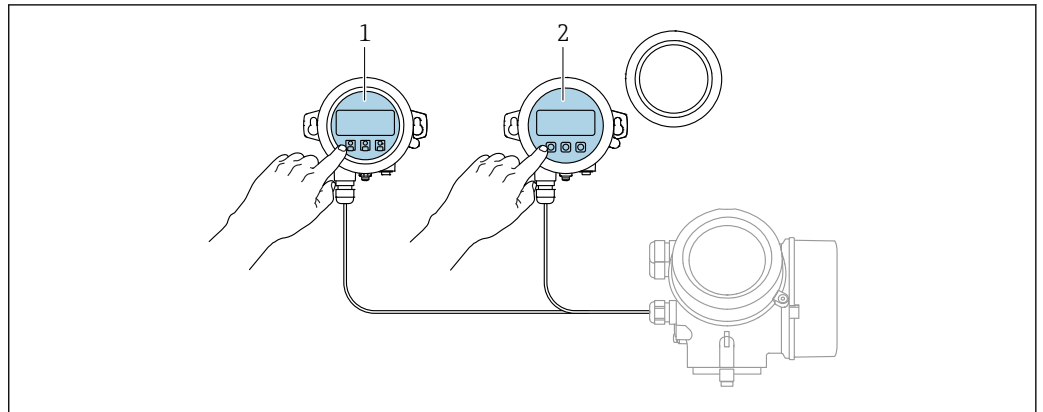

A0036314

26 FHX50 operating options

- 1 Display and operating module SD03, optical keys; can be operated through the glass of the cover
- 2 Display and operating module SD02, push buttons; cover must be removed

8.1.3 Operation via Bluetooth® wireless technology

Requirements

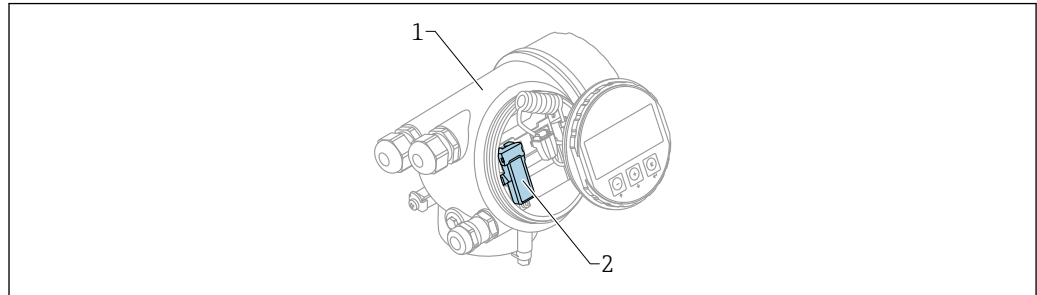

A0036790

27 Device with Bluetooth module

- 1 Electronics housing of the device
- 2 Bluetooth module

This operation option is only available for devices with Bluetooth module. There are the following options:

- The device has been ordered with a Bluetooth module:
Feature 610 "Accessory Mounted", option NF "Bluetooth"
- The Bluetooth module has been ordered as an accessory (ordering number: 71377355) and has been mounted. See Special Documentation SD02252F.

Operation via SmartBlue (app)

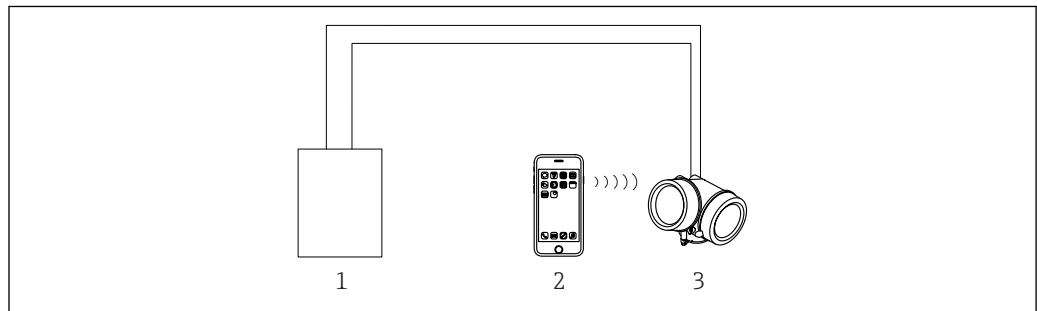

A0034939

28 Operation via SmartBlue (app)

- 1 Transmitter power supply unit
- 2 Smartphone / tablet with SmartBlue (app)
- 3 Transmitter with Bluetooth module

8.1.4 Remote operation

Via HART protocol

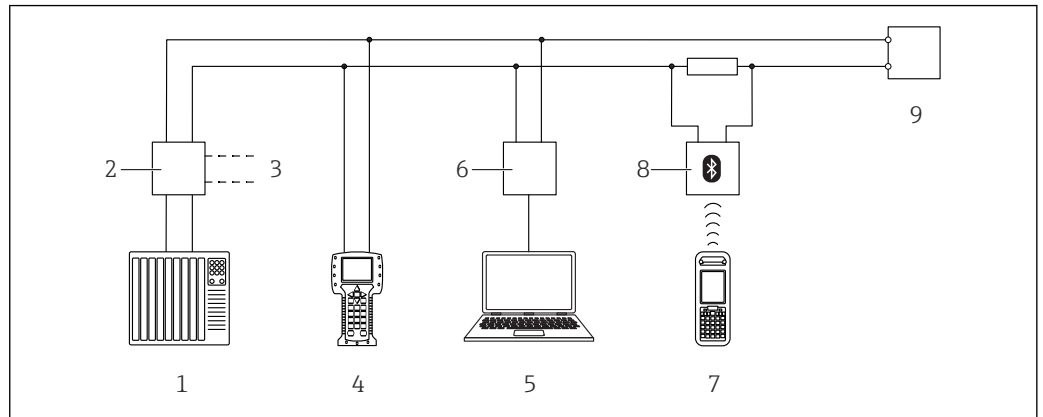

29 Options for remote operation via HART protocol

- 1 PLC (Programmable Logic Controller)
- 2 Transmitter power supply unit, e.g. RN221N (with communication resistor)
- 3 Connection for Commubox FXA191, FXA195 and Field Communicator 375, 475
- 4 Field Communicator 475
- 5 Computer with operating tool (e.g. DeviceCare/FieldCare, AMS Device Manager, SIMATIC PDM)
- 6 Commubox FXA191 (RS232) or FXA195 (USB)
- 7 Field Xpert SFX350/SFX370
- 8 VIATOR Bluetooth modem with connecting cable
- 9 Transmitter

DeviceCare/FieldCare via service interface (CDI)

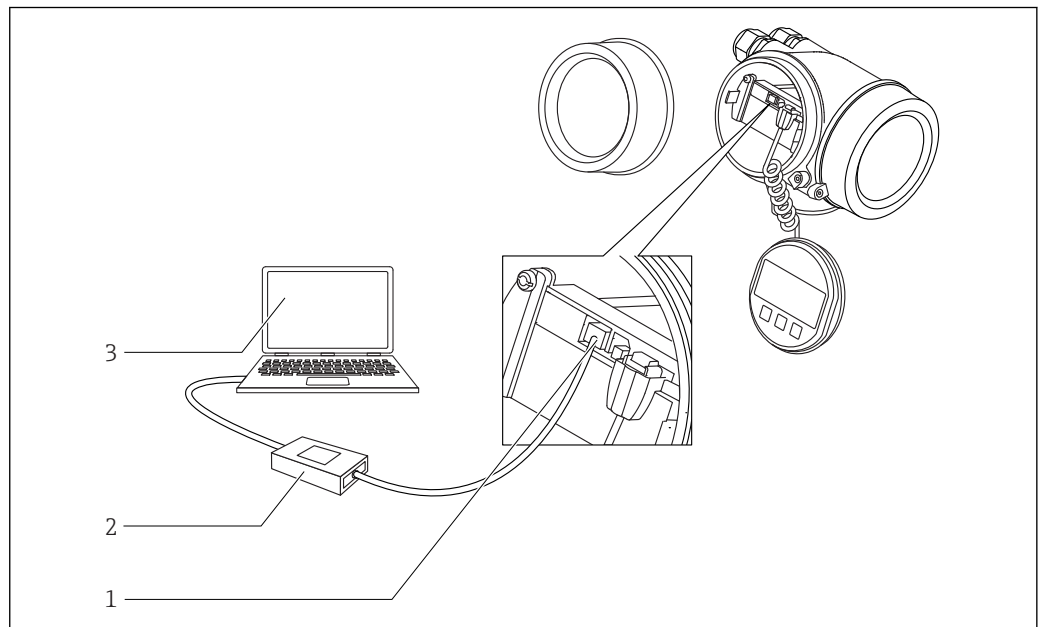

30 DeviceCare/FieldCare via service interface (CDI)

- 1 Service interface (CDI) of the instrument (= Endress+Hauser Common Data Interface)
- 2 Commubox FXA291
- 3 Computer with DeviceCare/FieldCare operating tool

8.2 Structure and function of the operating menu

8.2.1 Structure of the operating menu

Menu	Submenu / parameter	Meaning
	Language ¹⁾	Defines the operating language of the on-site display
Commissioning ²⁾		Launches the interactive wizard for guided commissioning. Additional settings generally do not need to be made in the other menus when the wizard is finished.
Setup	Parameter 1 ... Parameter N	Once values have been set for these parameters, the measurement should generally be completely configured.
	Advanced setup	Contains additional submenus and parameters: <ul style="list-style-type: none"> ▪ to adapt the device to special measuring conditions. ▪ to process the measured value (scaling, linearization). ▪ to configure the signal output.
Diagnostics	Diagnostic list	Contains up to 5 currently active error messages.
	Event logbook ³⁾	Contains the last 20 messages (which are no longer active).
	Device information	Contains information for identifying the device.
	Measured values	Contains all current measured values.
	Data logging	Contains the history of the individual measuring values.
	Simulation	Is used to simulate measured values or output values.
	Device check	Contains all parameters needed to check the measurement capability of the device.
Expert ⁵⁾ Contains all parameters of the device (including those that are already in one of the other menus). This menu is organized according to the function blocks of the device. The parameters of the Expert menu are described in: GPO1014F (HART)	System	Contains all higher-order device parameters that do not concern the measurement or measured value communication.
	Sensor	Contains all parameters needed to configure the measurement.
	Output	<ul style="list-style-type: none"> ▪ Contains all parameters needed to configure the current output. ▪ Contains all parameters needed to configure the switch output (PFS).

Menu	Submenu / parameter	Meaning
	Communication	Contains all parameters needed to configure the digital communication interface.
	Diagnostics	Contains all parameters needed to detect and analyze operational errors.

- 1) If operating via operating tools (e.g. FieldCare), the "Language" parameter is located under "Setup → Advanced setup → Display"
- 2) Only if operating via an FDT/DTM system
- 3) only available with local operation
- 4) only available if operating via DeviceCare or FieldCare
- 5) On entering the "Expert" menu, an access code is always requested. If a customer specific access code has not been defined, "0000" has to be entered.

8.2.2 User roles and related access authorization

The two user roles **Operator** and **Maintenance** have different write access to the parameters if a device-specific access code has been defined. This protects the device configuration via the local display from unauthorized access →  56.

Access authorization to parameters

User role	Read access		Write access	
	Without access code (from the factory)	With access code	Without access code (from the factory)	With access code
Operator	✓	✓	✓	--
Maintenance	✓	✓	✓	✓

If an incorrect access code is entered, the user obtains the access rights of the **Operator** role.

 The user role with which the user is currently logged on is indicated by the **Access status display** parameter (for display operation) or **Access status tooling** parameter (for tool operation).

8.2.3 Data access - Security

Write protection via access code

Using the device-specific access code, the parameters for the measuring device configuration are write-protected and their values can no longer be changed via local operation.

Define access code via local display

1. Navigate to: Setup → Advanced setup → Administration → Define access code → Define access code
2. Define a max. 4-digit numeric code as an access code.
3. Repeat the same code in **Confirm access code** parameter.
 - ↳ The -symbol appears in front of all write-protected parameters.



Define access code via operating tool (e.g. FieldCare)

1. Navigate to: Setup → Advanced setup → Administration → Define access code
2. Define a max. 4-digit numeric code as an access code.
 - ↳ Write protection is active.



Parameters that can always be changed

The write protection does not include certain parameters that do not affect the measurement. Despite the defined access code, they can always be modified, even if the other parameters are locked.



The device automatically locks the write-protected parameters again if a key is not pressed for 10 minutes in the navigation and editing view. The device locks the write-protected parameters automatically after 60 s if the user skips back to the measured value display mode from the navigation and editing view.

-  If write access is activated via access code, it can be also be deactivated only via the access code →  57.
- In the "Description of Device Parameters" documents, each write-protected parameter is identified with the -symbol.

Disabling write protection via access code

If the -symbol appears on the local display in front of a parameter, the parameter is write-protected by a device-specific access code and its value cannot be changed at the moment using the local display →  56.

The locking of the write access via local operation can be disabled by entering the device-specific access code.

1. After you press , the input prompt for the access code appears.
2. Enter the access code.
 - ↳ The -symbol in front of the parameters disappears; all previously write-protected parameters are now re-enabled.

Deactivation of the write protection via access code

Via local display

1. Navigate to: Setup → Advanced setup → Administration → Define access code → Define access code
2. Enter **0000**.
3. Repeat **0000** in **Confirm access code** parameter.
 - ↳ The write protection is deactivated. Parameters can be changed without entering an access code.

Via an operating tool (e.g. FieldCare)

1. Navigate to: Setup → Advanced setup → Administration → Define access code
2. Enter **0000**.
 - ↳ The write protection is deactivated. Parameters can be changed without entering an access code.

Write protection via write protection switch

Unlike parameter write protection via a user-specific access code, this allows write access to the entire operating menu - except for the **"Contrast display" parameter** - to be locked.

The parameter values are now read only and cannot be edited any more (exception **"Contrast display" parameter**):

- Via local display
- Via service interface (CDI)
- Via HART protocol

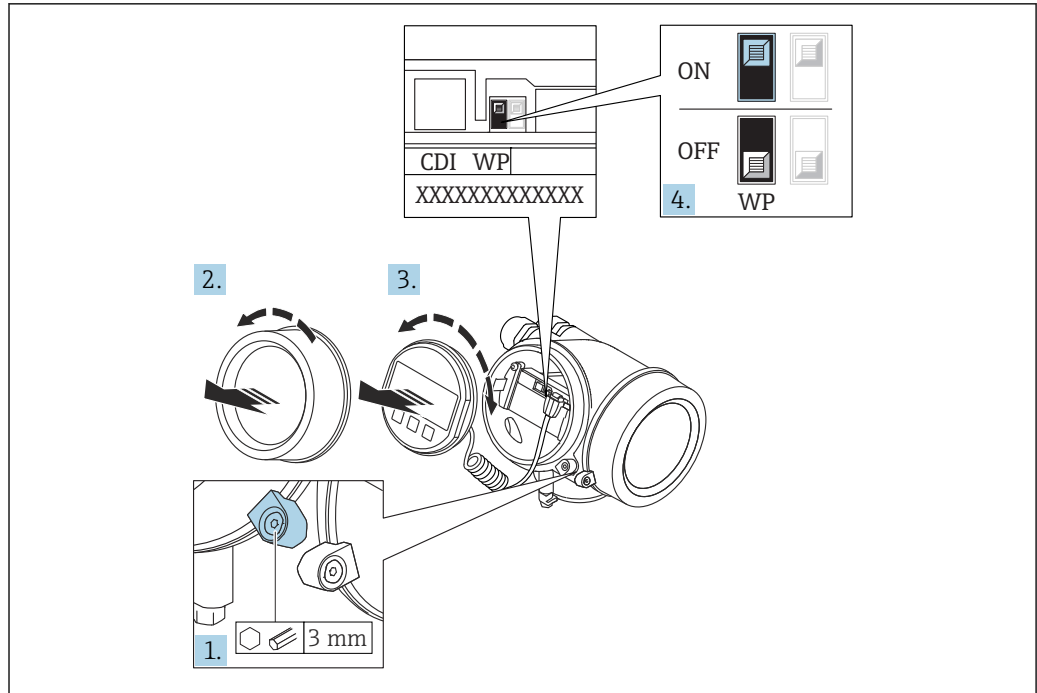

A0026157

1. Loosen the securing clamp.
2. Unscrew the electronics compartment cover.
3. Pull out the display module with a gentle rotational movement. To make it easier to access the lock switch, attach the display module to the edge of the electronics compartment.

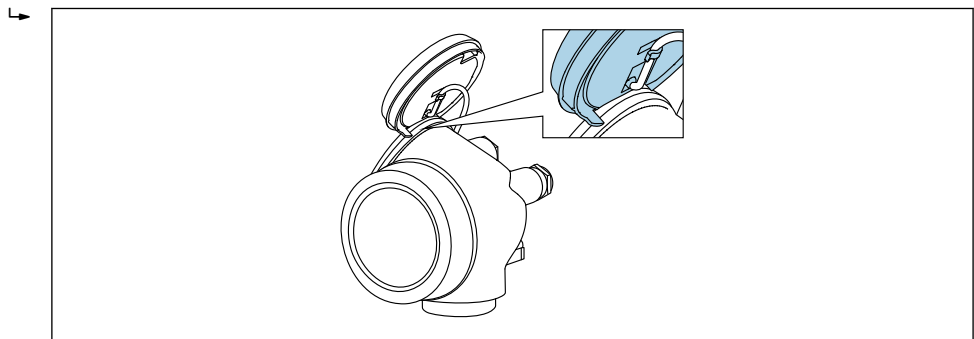

A0036086

4. Setting the write protection switch (WP) on the main electronics module to the **ON** position enables hardware write protection. Setting the write protection switch (WP) on the main electronics module to the **OFF** position (factory setting) disables hardware write protection.
 - ↳ If the hardware write protection is enabled: The **Hardware locked** option is displayed in the **Locking status** parameter. In addition, on the local display the -symbol appears in front of the parameters in the header of the operational display and in the navigation view.

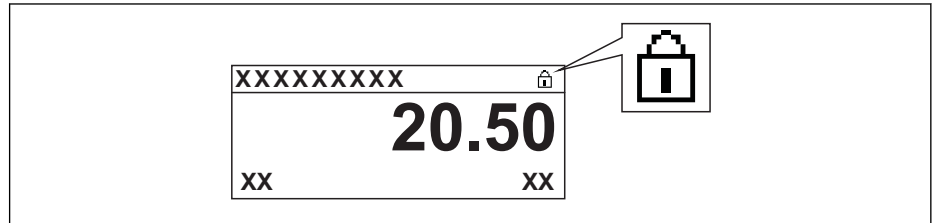

A0015870

If the hardware write protection is disabled: No option is displayed in the **Locking status** parameter. On the local display, the -symbol disappears from in front of the parameters in the header of the operational display and in the navigation view.

5. Feed the cable into the gap between the housing and main electronics module and plug the display module into the electronics compartment in the desired direction until it engages.
6. Reverse the removal procedure to reassemble the transmitter.

Enabling and disabling the keypad lock

The keypad lock makes it possible to block access to the entire operating menu via local operation. As a result, it is no longer possible to navigate through the operating menu or change the values of individual parameters. Users can only read the measured values on the operational display.

The keypad lock is switched on and off via the context menu.

Switching on the keypad lock

For the SD03 display only

The keypad lock is switched on automatically:

- If the device has not been operated via the display for > 1 minute.
- Each time the device is restarted.

To activate the keylock manually:

1. The device is in the measured value display.
Press  for at least 2 seconds.
↳ A context menu appears.
2. In the context menu select the **Keylock on** option.
↳ The keypad lock is switched on.

 If the user attempts to access the operating menu while the keypad lock is active, the message **Keylock on** appears.

Switching off the keypad lock

1. The keypad lock is switched on.
Press  for at least 2 seconds.
↳ A context menu appears.
2. In the context menu select the **Keylock off** option.
↳ The keypad lock is switched off.

Bluetooth® wireless technology

Signal transmission via Bluetooth® wireless technology uses a cryptographic technique tested by the Fraunhofer Institute

- The device is not visible via *Bluetooth*® wireless technology without the SmartBlue app
- Only one point-to-point connection between **one** sensor and **one** smartphone or tablet is established

8.3 Display and operating module

8.3.1 Display appearance

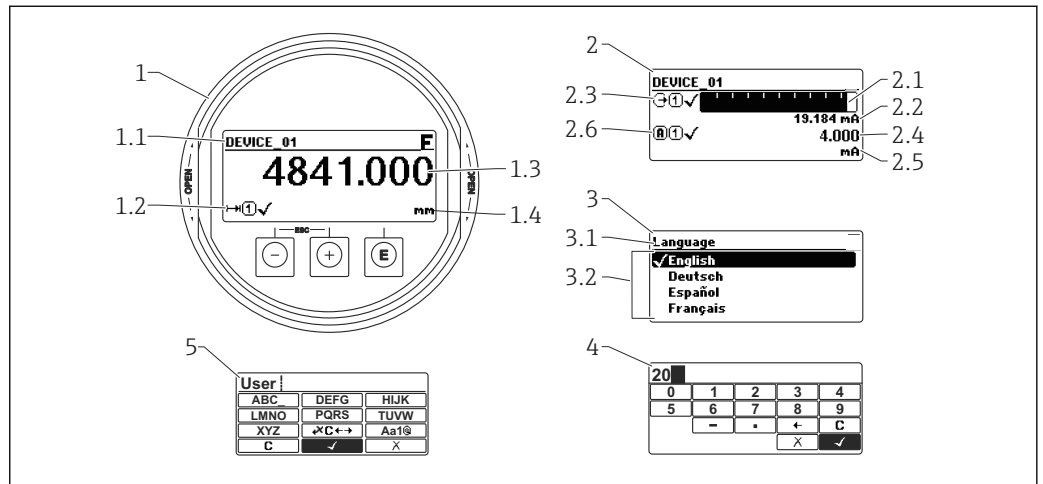





A0012635

31 Appearance of the display and operation module for on-site operation

- 1 Measured value display (1 value max. size)
- 1.1 Header containing tag and error symbol (if an error is active)
- 1.2 Measured value symbols
- 1.3 Measured value
- 1.4 Unit
- 2 Measured value display (1 bargraph + 1 value)
- 2.1 Bargraph for measured value 1
- 2.2 Measured value 1 (including unit)
- 2.3 Measured value symbols for measured value 1
- 2.4 Measured value 2
- 2.5 Unit for measured value 2
- 2.6 Measured value symbols for measured value 2
- 3 Representation of a parameter (here: a parameter with selection list)
- 3.1 Header containing parameter name and error symbol (if an error is active)
- 3.2 Selection list; marks the current parameter value.
- 4 Input matrix for numbers
- 5 Input matrix for alphanumeric and special characters



Display symbols for the submenus

Symbol	Meaning
 <small>A0018367</small>	Display/operation Is displayed: <ul style="list-style-type: none"> in the main menu next to the selection "Display/operation" in the header, if you are in the "Display/operation" menu
 <small>A0018364</small>	Setup Is displayed: <ul style="list-style-type: none"> in the main menu next to the selection "Setup" in the header, if you are in the "Setup" menu
 <small>A0018365</small>	Expert Is displayed: <ul style="list-style-type: none"> in the main menu next to the selection "Expert" in the header, if you are in the "Expert" menu
 <small>A0018366</small>	Diagnostics Is displayed: <ul style="list-style-type: none"> in the main menu next to the selection "Diagnostics" in the header, if you are in the "Diagnostics" menu











Status signals

F <small>A0032902</small>	"Failure" A device error is present. The measured value is no longer valid.
C <small>A0032903</small>	"Function check" The device is in service mode (e.g. during a simulation).
S <small>A0032904</small>	"Out of specification" The device is operated: <ul style="list-style-type: none"> Outside of its technical specifications (e.g. during startup or a cleaning) Outside of the configuration carried out by the user (e.g. level outside configured span)
M <small>A0032905</small>	"Maintenance required" Maintenance is required. The measured value is still valid.







Display symbols for the locking state

Symbol	Meaning
 <small>A0013148</small>	Display parameter Marks display-only parameters which can not be edited.
 <small>A0013150</small>	Device locked <ul style="list-style-type: none"> In front of a parameter name: The device is locked via software and/or hardware. In the header of the measured value screen: The device is locked via hardware.

Measured value symbols

Symbol	Meaning
Measured values	
 A0032892	Level
 A0032893	Distance
 A0032908	Current output
 A0032894	Measured current
 A0032895	Terminal voltage
 A0032896	Temperature of the electronics or the sensor
Measuring channels	
 A0032897	Measuring channel 1
 A0032898	Measuring channel 2
Status of the measured value	
 A0018361	Status "Alarm" The measurement is interrupted. The output assumes the defined alarm value. A diagnostic message is generated.
 A0018360	Status "Warning" The device continues measuring. A diagnostic message is generated.

8.3.2 Operating elements

Key	Meaning
 <small>A0018330</small>	<p>Minus key</p> <p><i>For menu, submenu</i> Moves the selection bar upwards in a picklist.</p> <p><i>For text and numeric editor</i> In the input mask, moves the selection bar to the left (backwards).</p>
 <small>A0018329</small>	<p>Plus key</p> <p><i>For menu, submenu</i> Moves the selection bar downwards in a picklist.</p> <p><i>For text and numeric editor</i> In the input mask, moves the selection bar to the right (forwards).</p>
 <small>A0018328</small>	<p>Enter key</p> <p><i>For measured value display</i></p> <ul style="list-style-type: none"> ▪ Pressing the key briefly opens the operating menu. ▪ Pressing the key for 2 s opens the context menu. <p><i>For menu, submenu</i></p> <ul style="list-style-type: none"> ▪ Pressing the key briefly Opens the selected menu, submenu or parameter. ▪ Pressing the key for 2 s for parameter: If present, opens the help text for the function of the parameter. <p><i>For text and numeric editor</i></p> <ul style="list-style-type: none"> ▪ Pressing the key briefly <ul style="list-style-type: none"> - Opens the selected group. - Carries out the selected action. ▪ Pressing the key for 2 s confirms the edited parameter value.
 <small>A0032909</small>	<p>Escape key combination (press keys simultaneously)</p> <p><i>For menu, submenu</i></p> <ul style="list-style-type: none"> ▪ Pressing the key briefly <ul style="list-style-type: none"> - Exits the current menu level and takes you to the next higher level. - If help text is open, closes the help text of the parameter. ▪ Pressing the key for 2 s returns you to the measured value display ("home position"). <p><i>For text and numeric editor</i> Closes the text or numeric editor without applying changes.</p>
 <small>A0032910</small>	<p>Minus/Enter key combination (press and hold down the keys simultaneously)</p> <p>Reduces the contrast (brighter setting).</p>
 <small>A0032911</small>	<p>Plus/Enter key combination (press and hold down the keys simultaneously)</p> <p>Increases the contrast (darker setting).</p>



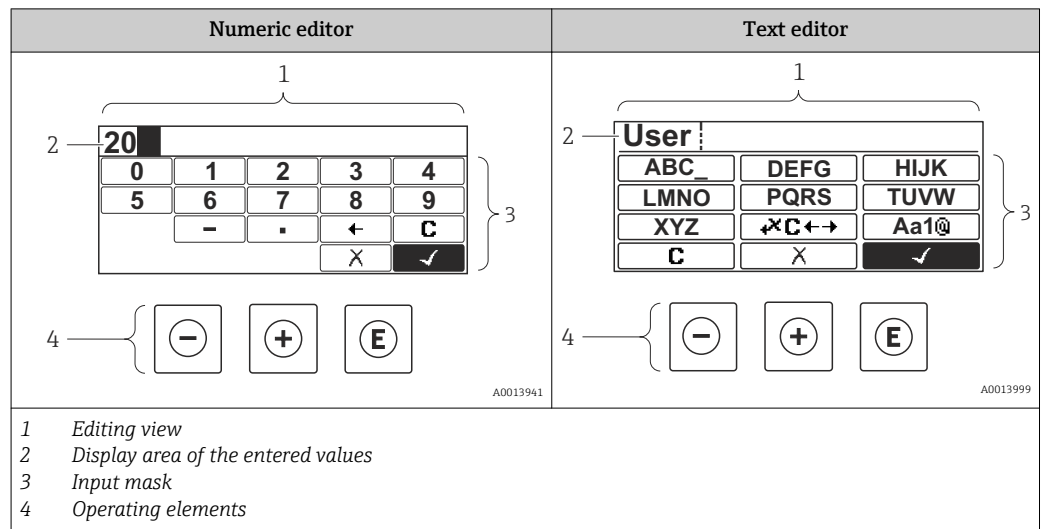



8.3.3 Entering numbers and text



Input mask





The following input symbols are available in the input mask of the numeric and text editor:

Numeric editor symbols

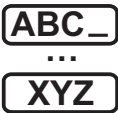
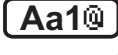



Symbol	Meaning
 <small>A0013998</small>	Selection of numbers from 0 to 9.
 <small>A0016619</small>	Inserts decimal separator at the input position.
 <small>A0016620</small>	Inserts minus sign at the input position.
 <small>A0013985</small>	Confirms selection.
 <small>A0016621</small>	Moves the input position one position to the left.
 <small>A0013986</small>	Exits the input without applying the changes.
 <small>A0014040</small>	Clears all entered characters.

Text editor symbols

Symbol	Meaning
 <small>A0013997</small>	Selection of letters from A to Z
 <small>A0013981</small>	Toggle <ul style="list-style-type: none"> Between upper-case and lower-case letters For entering numbers For entering special characters

 <small>A0013985</small>	Confirms selection.
 <small>A0013987</small>	Switches to the selection of the correction tools.
 <small>A0013986</small>	Exits the input without applying the changes.
 <small>A0014040</small>	Clears all entered characters.

Correction symbols under 

Symbol	Meaning
 <small>A0032907</small>	Clears all entered characters.
 <small>A0018324</small>	Moves the input position one position to the right.
 <small>A0018326</small>	Moves the input position one position to the left.
 <small>A0032906</small>	Deletes one character immediately to the left of the input position.

8.3.4 Opening the context menu

Using the context menu, the user can call up the following menus quickly and directly from the operational display:

- Setup
- Conf. backup disp.
- Env. curve
- Keylock on



Opening and closing the context menu

The user is in the operational display.

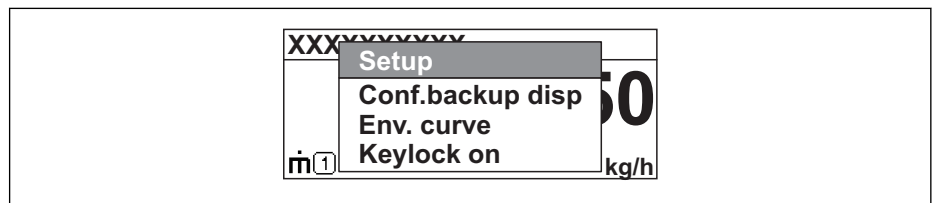

1. Press  for 2 s.
 - ↳ The context menu opens.



A0033110-EN

2. Press  +  simultaneously.
 - ↳ The context menu is closed and the operational display appears.

Calling up the menu via the context menu

1. Open the context menu.
2. Press  to navigate to the desired menu.
3. Press  to confirm the selection.
 - ↳ The selected menu opens.

8.3.5 Envelope curve on the display and operating module

In order to assess the measuring signal, the envelope curve and - if a mapping has been recorded - the mapping curve can be displayed:

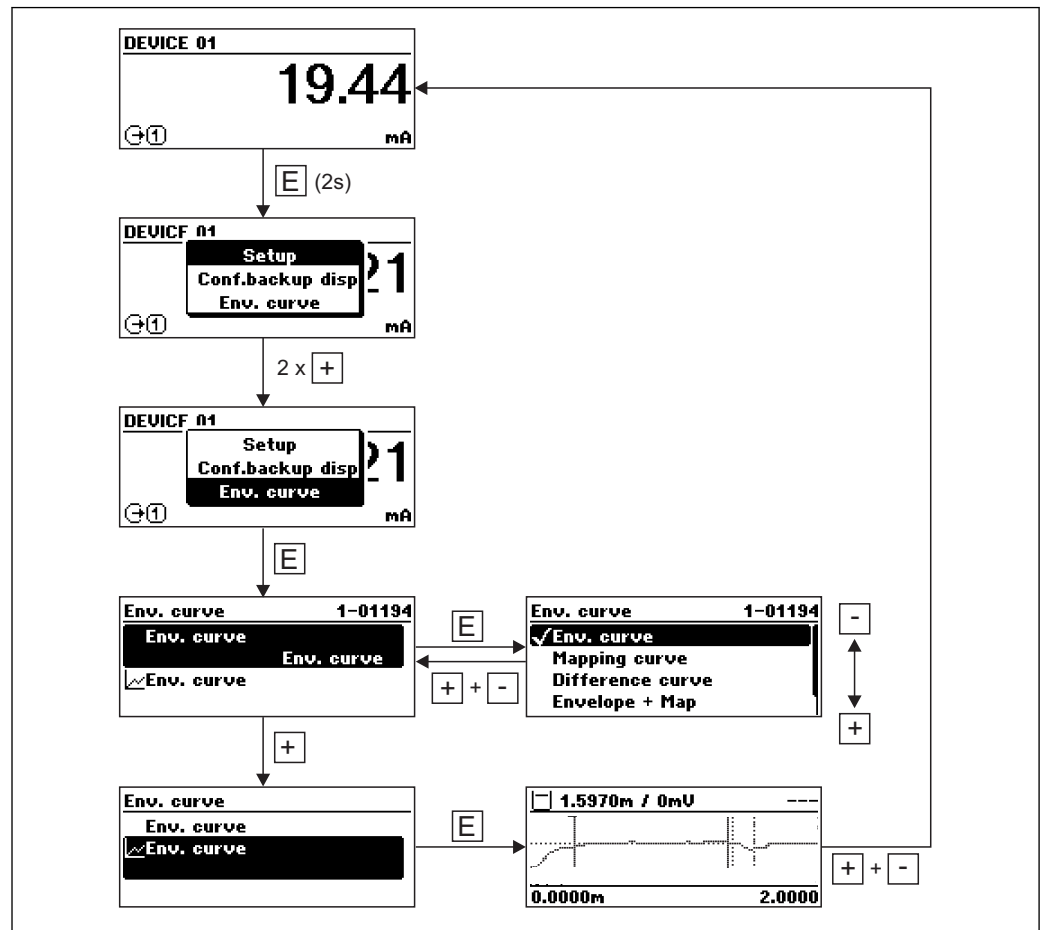

A0014277

9 System integration via HART protocol





9.1 Overview of the Device Description files (DD)

Manufacturer ID	0x11
Device type	0x1128
HART specification	7.0
DD files	For information and files see: <ul style="list-style-type: none"> ▪ www.endress.com ▪ www.fieldcommgroup.org

9.2 Measured values via HART protocol

On delivery the following measuring values are assigned to the HART device variables:

Device variable	Measuring value
Primary variable (PV)	Level linearized
Secondary variable (SV)	Unfiltered distance
Tertiary variable (TV)	Absolute echo amplitude
Quaternary variable (QV)	Relative echo amplitude

-  The allocation of the device variables can be changed in the operating menu:
Expert → Communication → Output
-  In a HART multidrop loop only one device may use the output current for signal transmission. For all other devices the following must be set:
 - **Current span** (→  157) = **Fixed current**
 - **Fixed current** (→  157) = **4 mA**

10 Commissioning via SmartBlue (app)

10.1 Requirements

Device requirements

Commissioning via SmartBlue is only possible if the device has a Bluetooth module.

System requirements SmartBlue

SmartBlue is available as download for Android devices from the Google Play Store and for iOS devices from the iTunes Store.

- iOS devices:
 - iPhone 4S or higher from iOS9.0; iPad2 or higher from iOS9.0; iPod Touch 5th generation or higher from iOS9.0
- Devices with Android:
 - from Android 4.4 KitKat and *Bluetooth*® 4.0

Initial password

The ID of the Bluetooth module serves as the initial password used to establish the first connection to the device. It can be found:

- on the information sheet which is supplied with the device. This serial number specific sheet is also stored in *W@M*.
- on the nameplate of the Bluetooth module.

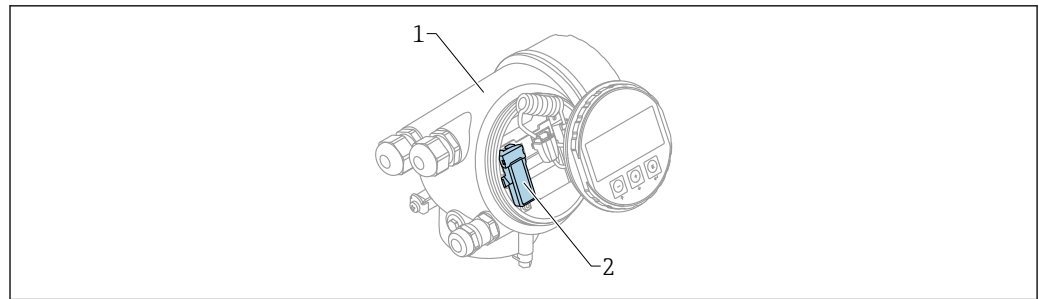

A0036790

32 Device with Bluetooth module

1 Electronics housing of the device

2 Nameplate of the Bluetooth module; the ID on this nameplate serves as initial password.

- i** All login data (including the password changed by the user) are not stored in the device but in the Bluetooth module. This must be taken into account when the module is removed from one device and inserted into a different device.

10.2 Commissioning

Download and install SmartBlue

1. To download the app, scan the QR code or enter "SmartBlue" in the search field

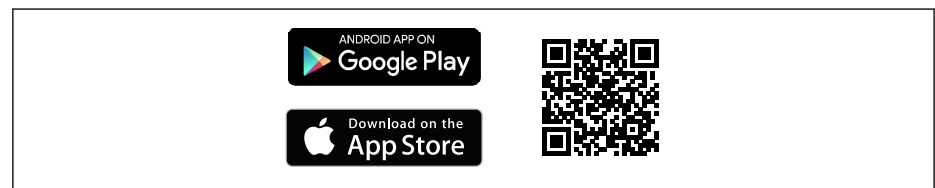

A0033202

33 Download link

2. Start SmartBlue



A0029747

34 SmartBlue pictogram

3. Select device from displayed livelist (available devices only)

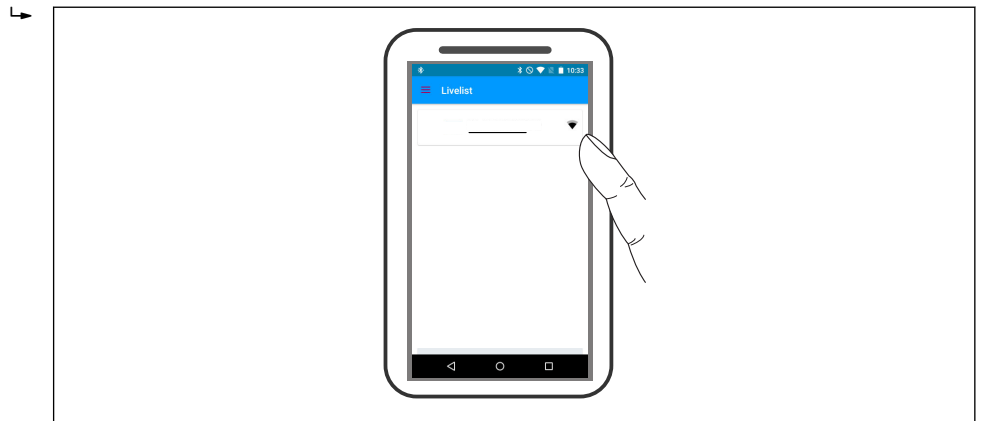

A0029502

35 Livelist

i Only one point-to-point connection can be established between **one** sensor and **one** smartphone or tablet.

4. Perform login

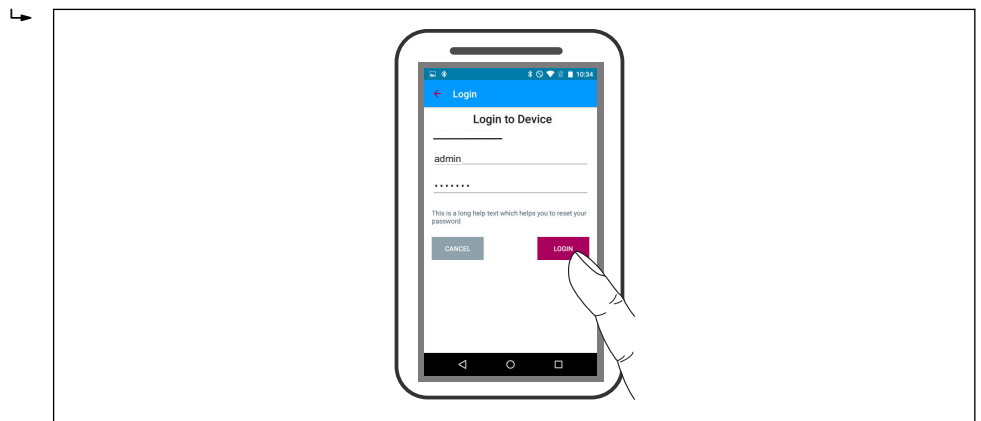

A0029503

36 Login

5. Enter user name -> admin
6. Enter initial password -> ID of the Bluetooth module
7. Change the password after logging in for the first time

8. By wiping from the side, additional information (e.g. main menu) can be dragged into the image

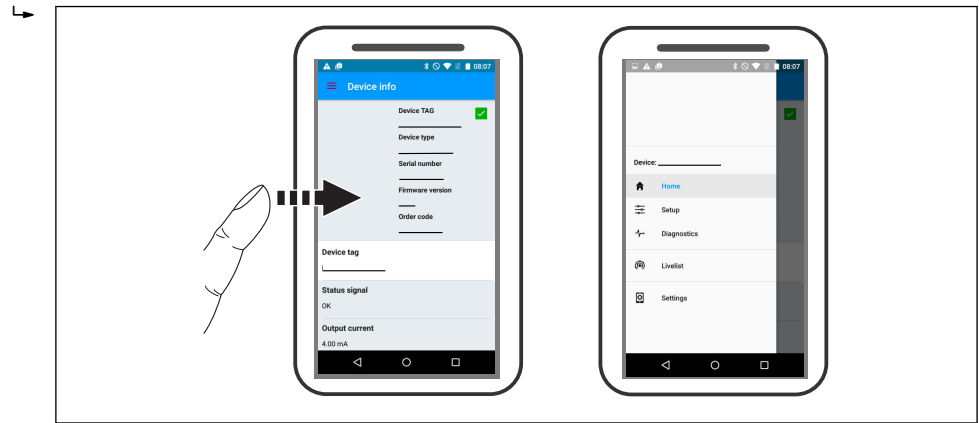

A0029504

37 Main menu

i Envelope curves can be displayed and recorded

Additionally to the envelope curve, the following values are displayed:

- D = Distance
- L = Level
- A = Absolute amplitude
- In the case of screenshots, the displayed section (zoom function) is saved
- In video sequences, always the whole area without zoom function is saved

It is also possible to send envelope curves (video sequences) using the relevant smartphone or tablet functions.



A0029486

38 Envelope curve display (example) in SmartBlue; Android view

- 1 Record video
- 2 Create screenshot
- 3 Navigation to mapping menu
- 4 Start / stop video recording
- 5 Move time on time axis

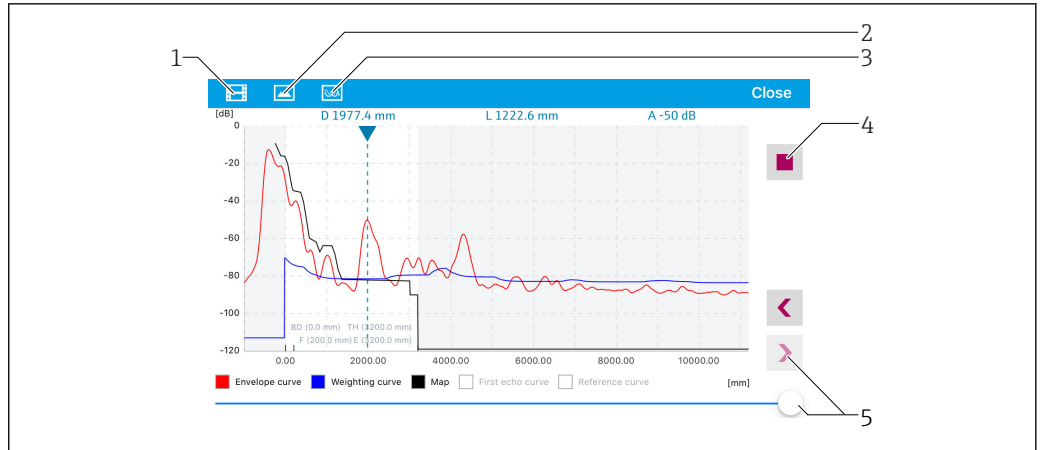

A0029487

39 Envelope curve display (example) in SmartBlue; IoS view

- 1 Record video
- 2 Create screenshot
- 3 Navigation to mapping menu
- 4 Start / stop video recording
- 5 Move time on time axis

11 Commissioning via wizard

A wizard guiding the user through the initial setup is available in FieldCare and DeviceCare ³⁾.

1. Connect the device to FieldCare or DeviceCare →  53.
2. Open the device in FieldCare or DeviceCare.
 - ↳ The dashboard (home page) of the device appears:

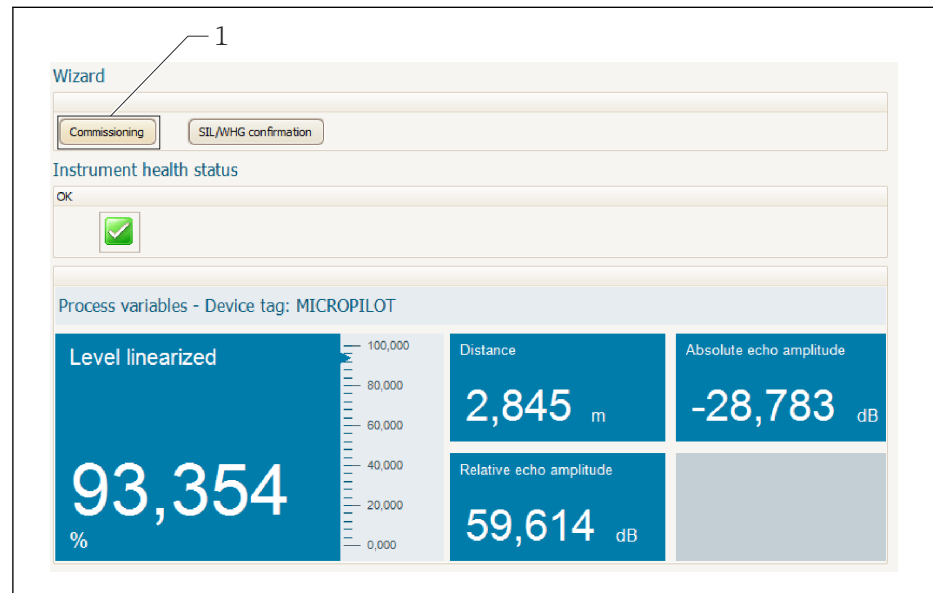

A0027720

1 "Commissioning" button calls up the wizard.

3. Click on "Commissioning" to call up the wizard.
 4. Enter or select the appropriate value for each parameter. These values are immediately written to the device.
 5. Click "Next" to switch to the next page.
 6. After finishing the last page, click "End of sequence" to close the wizard.
-  If the wizard is cancelled before all necessary parameters have been set, the device may be in an undefined state. A reset to the default settings is recommended in this case.

3) DeviceCare is available for download at www.software-products.endress.com. The download requires a registration in the Endress+Hauser software portal.

12 Commissioning via operating menu

12.1 Installation and function check

Make sure that all final checks have been completed before you start up your measuring point:

- Checklist "Post-installation check" → 35
- Checklist "Post-connection check" → 49

12.2 Setting the operating language

Factory setting: English or ordered local language

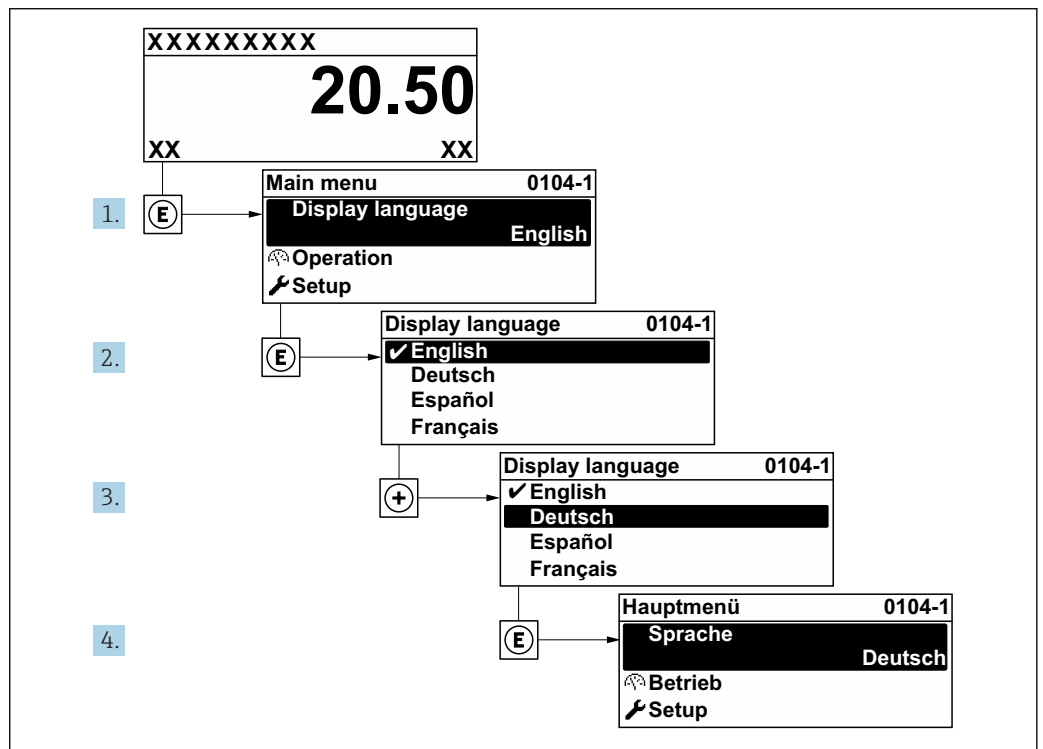

40 Using the example of the local display

A0029420

12.3 Configuration of a level measurement

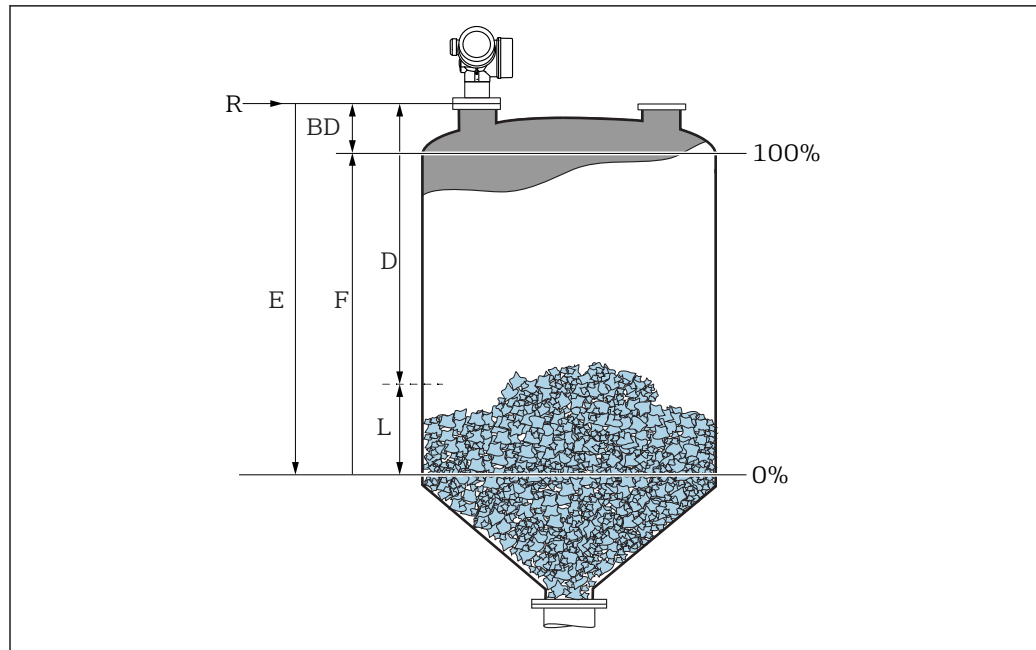

41 Configuration parameters for level measurements in bulk solids

R Reference point of the measurement
 D Distance
 L Level
 E Empty calibration (= zero)
 F Full calibration (= span)

1. Navigate to: Setup → Device tag
 ↳ Enter device tag.
2. Navigate to: Setup → Distance unit
 ↳ Select distance unit.
3. Navigate to: Setup → Bin type
 ↳ Select bin type.
4. Navigate to: Setup → Max. filling speed solid
 ↳ Enter maximum expected filling speed.
5. Navigate to: Setup → Max. draining speed solid
 ↳ Enter maximum expected draining speed.
6. Navigate to: Setup → Empty calibration
 ↳ Enter empty distance E (Distance from reference point R to the 0% level) ⁴⁾.
7. Navigate to: Setup → Full calibration
 ↳ Enter full distance F (Distance from the 0% to the 100% level).
8. Navigate to: Setup → Level
 ↳ Indicates the measured level L.
9. Navigate to: Setup → Distance
 ↳ Indicates the measured distance from the reference point R to the level L.
10. Navigate to: Setup → Signal quality
 ↳ Indicates the quality of the evaluated level echo.

4) If, for example, the measuring range covers only an upper part of the tank ($E \ll$ tank height), it is mandatory to enter the actual tank height into the "Setup → Advanced Setup → Level → Tank/silo height" parameter.

11. When operating via local display:
Navigate to: Setup → Mapping → Confirm distance
 - ↳ Compare distance indicated on the display to real distance in order to start the recording of an interference echo map.
 12. When operating via operating tool:
Navigate to: Setup → Confirm distance
 - ↳ Compare distance indicated on the display to real distance in order to start the recording of an interference echo map.
 13. Navigate to: Setup → Advanced setup → Level → Level unit
 - ↳ Select level unit: %, m, mm, ft, in (Factory setting: %)
-  It is strongly recommended to adjust the maximum filling and draining speed to the actual process.

12.4 Recording the reference curve

After the configuration of the measurement it is recommended to record the current envelope curve as a reference curve. The reference curve can be used later on in the process for diagnostic purposes. To record the reference curve use the **Save reference curve** parameter.

Navigation in the menu

Expert → Diagnostics → Envelope diagnostics → Save reference curve

Meaning of the options

- No
No action
- Yes
The current envelope curve is saved as reference curve.

 In devices which have been delivered with software version 01.00.zz, this submenu is only visible for the "Service" user role.

 The reference curve can only be displayed in the envelope curve diagram of FieldCare after it has been loaded from the device into FieldCare. This is performed by the "Load Reference Curve" function in FieldCare.

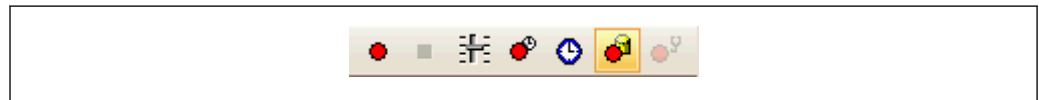

 42 The "Load Reference Curve" function

12.5 Configuration of the on-site display

12.5.1 Factory settings of the on-site display

Parameter	Factory setting
Format display	1 value, max. size
Value 1 display	Level linearized
Value 2 display	None
Value 3 display	None
Value 4 display	None

12.5.2 Adjustment of the on-site display

The on-site display can be adjusted in the following submenu:
Setup → Advanced setup → Display

12.6 Configuration of the current outputs

12.6.1 Factory setting of the current outputs

Current output	Allocated measuring value	4mA value	20mA value
1	Level linearized	0% or the corresponding linearized value	100% or the corresponding linearized value
2 ¹⁾	Distance	0	Empty calibration

1) for devices with 2 current outputs

12.6.2 Adjustment of the current outputs

The current outputs can be adjusted in the following menus:

Basic settings

Setup → Advanced setup → Current output 1 to 2

Advanced settings

Expert → Output 1 to 2 → Current output 1 to 2

See "Description of Device Parameters", GP01014F

12.7 Configuration management

After commissioning, you can save the current device configuration, copy it to another measuring point or restore the previous device configuration. You can do so using the **Configuration management** parameter and its options.

Navigation path in the operating menu

Setup → Advanced setup → Configuration backup display → Configuration management

Meaning of the options

- **Cancel**

No action is executed and the user exits the parameter.

- **Execute backup**

A backup copy of the current device configuration in the HistoROM (built-in in the device) is saved to the display module of the device. The backup copy comprises the transmitter and sensor data of the device.

- **Restore**

The last backup copy of the device configuration is copied from the display module to the HistoROM of the device. The backup copy comprises the transmitter and sensor data of the device.

- **Duplicate**

The transmitter configuration is duplicated to another device using the transmitter display module. The following parameters, which characterize the individual measuring point are **not** included in the transmitted configuration:

- HART date code
- HART short tag
- HART message
- HART descriptor
- HART address
- Device tag
- Medium type

- **Compare**



The device configuration saved in the display module is compared to the current device configuration of the HistoROM. The result of this comparison is displayed in the

Comparison result parameter.

- **Clear backup data**

The backup copy of the device configuration is deleted from the display module of the device.



 While this action is in progress, the configuration cannot be edited via the local display and a message on the processing status appears on the display.

 If an existing backup is restored to a different device using the **Restore** option, it may occur that some device functionalities are no longer available. In some cases even a device reset →  175 will not restore the original status..

In order to transmit a configuration to a different device, the **Duplicate** option should always be used.

12.8 Protection of the settings against unauthorized changes

There are two ways to protect the settings against unauthorized changes:

- Via parameter settings (software locking) →  56
- Via locking switch (hardware locking) →  57

13 Diagnostics and troubleshooting

13.1 General trouble shooting

13.1.1 General errors

Error	Possible cause	Remedial action
Device does not respond.	Supply voltage does not match the value indicated on the nameplate.	Connect the correct voltage.
	The polarity of the supply voltage is wrong.	Correct the polarity.
	The cables do not contact the terminals properly.	Ensure electrical contact between the cable and the terminal.
Values on the display invisible	Contrast setting is too weak or too strong.	<ul style="list-style-type: none"> ▪ Increase contrast by pressing \oplus and \boxminus simultaneously. ▪ Decrease contrast by pressing \ominus and \boxminus simultaneously.
	The plug of the display cable is not connected correctly.	Connect the plug correctly.
	Display is defective.	Replace display.
"Communication error" is indicated on the display when starting the device or connecting the display	Electromagnetic interference	Check grounding of the device.
	Broken display cable or display plug.	Replace display.
Duplicating of the parameters from one device to another via the display doesn't work. Only the "Save" and "Abort" options are available.	Display with backup is not recognized if no data backup has been performed at the device before.	Connect display (with the backup) and restart the device.
Output current <3.6 mA	Signal cable connection incorrect.	Check connection.
	Electronics is defective.	Replace electronics.
HART communication does not function.	Communication resistor missing or incorrectly installed.	Install the communication resistor(250 Ω) correctly.
	Commubox connected incorrectly.	Connect Commubox correctly.
	Commubox not switched to HART mode.	Set the selection switch of the Commubox to the HART position.
CDI communication does not work.	Wrong setting of the COM port on the computer.	Check the setting of the COM port on the computer and change it if necessary.
Device measures incorrectly.	Parametrization error	Check and adjust parameterization.
Device not accessible via SmartBlue	No Bluetooth connection	Enable Bluetooth function on smartphone or tablet.
	Device already linked to another smartphone / tablet	Disconnect device from smartphone/tablet.
	Bluetooth module not connected.	Connect Bluetooth module (see SD02252F).
Login via SmartBlue not possible	Device is being put into operation for the first time	Enter initial password (ID of the Bluetooth module) and change.
Device cannot be operated via SmartBlue	Incorrect password entered	Enter correct password
	Password forgotten	Contact Endress+Hauser Service (www.addresses.endress.com)

13.1.2 Error - SmartBlue operation

Error	Possible cause	Solution
Device is not visible in the live list	No Bluetooth connection	Enable Bluetooth® function on smartphone or tablet
		Bluetooth® function of sensor disabled, perform recovery sequence
Device is not visible in the live list	The device is already connected with another smartphone/tablet	Only one point-to-point connection is established between a sensor and a smartphone or tablet
Device is visible in the live list but cannot be accessed via SmartBlue	Android end device	Is the location function enabled for the app, was it approved the first time?
		GPS or positioning function must be activated for certain Android versions in conjunction with Bluetooth®
		Activate GPS - close the app fully and restart - enable the positioning function for the app
Device is visible in the live list but cannot be accessed via SmartBlue	Apple end device	Log in as standard Enter user name "admin" Enter initial password (ID of the Bluetooth module) paying attention to lower/upper case
Login via SmartBlue not possible	Device is being put into operation for the first time	Enter initial password (ID of the Bluetooth module) and change; paying attention to lower/upper case
Device cannot be operated via SmartBlue	Incorrect password entered	Enter correct password
Device cannot be operated via SmartBlue	Password forgotten	Contact the Endress+Hauser Service department (www.addresses.endress.com)

13.1.3 Parametrization errors

Error	Possible cause	Remedy
Measured value incorrect	If measured distance (Setup → Distance) matches the real distance: Calibration error	<ul style="list-style-type: none"> ▪ Check and adjust Empty calibration parameter (→ ☰ 127) if necessary. ▪ Check and adjust Full calibration parameter (→ ☰ 128) if necessary. ▪ Check and adjust linearization if necessary (Linearization submenu (→ ☰ 142)).
	Wrong level correction	Enter correct value in Level correction parameter (→ ☰ 139).
	If measured distance (Setup → Distance) does not match the real distance: Interference echo	Carry out tank mapping (Confirm distance parameter (→ ☰ 130)).
No change of measured value on filling / emptying	Interference echo from installations, nozzle or build-up on the antenna.	<ul style="list-style-type: none"> ▪ Carry out tank mapping (Confirm distance parameter (→ ☰ 130)). ▪ If possible, align antenna in the direction of the solid surface in order to prevent interference echoes. ▪ If necessary, clean antenna (purge air). ▪ If necessary, select a better mounting position and/or larger antenna.

Error	Possible cause	Remedy
During filling/emptying or measurement, the measured value jumps sporadically to a higher level.	Signal is weakened (e.g. by fluidisation of the surface, extreme dust formation) - the interference echoes are sometimes stronger. Strong build-up, filling stream in path of beam.	<ul style="list-style-type: none"> ▪ Carry out tank mapping (Confirm distance parameter (→ ☰ 130)). ▪ Increase integration time (Expert → Sensor → Distance → Integration time) ▪ Optimize alignment of antenna ▪ If necessary, select a better mounting position and/or larger antenna. ▪ If necessary, clean antenna (purge air).
Error message F941 or S941 "Echo lost"	Level echo is too weak. Possible causes: <ul style="list-style-type: none"> ▪ Fluidisation of the surface ▪ Extreme dust formation ▪ Angle or repose 	<ul style="list-style-type: none"> ▪ Optimize alignment of antenna ▪ If necessary, select a better mounting position and/or larger antenna.
Measured values jumps to higher levels and remains there.	<ul style="list-style-type: none"> ▪ Build-up at container ▪ Build-up at antenna ▪ Strong condensate formation at antenna 	<ul style="list-style-type: none"> ▪ Periodic cleaning ▪ Carry out tank mapping (Confirm distance parameter (→ ☰ 130)). ▪ Increase integration time (Expert → Sensor → Distance → Integration time) ▪ Optimize alignment of antenna ▪ If necessary, select a better mounting position and/or larger antenna.
Device displays a level when the tank is empty.	Interference echo	Carry out mapping over entire measuring range when the silo is empty (Confirm distance parameter (→ ☰ 130)).
Wrong slope of the level throughout the complete measuring range	Bin property or process properties incorrect	<ul style="list-style-type: none"> ▪ Select the correct option in Bin type parameter (→ ☰ 125). ▪ Enter the actual values in Max. filling speed solid (→ ☰ 126) and Max. draining speed solid (→ ☰ 126).

13.2 Diagnostic information on local display

13.2.1 Diagnostic message

Faults detected by the self-monitoring system of the measuring device are displayed as a diagnostic message in alternation with the measured value display.

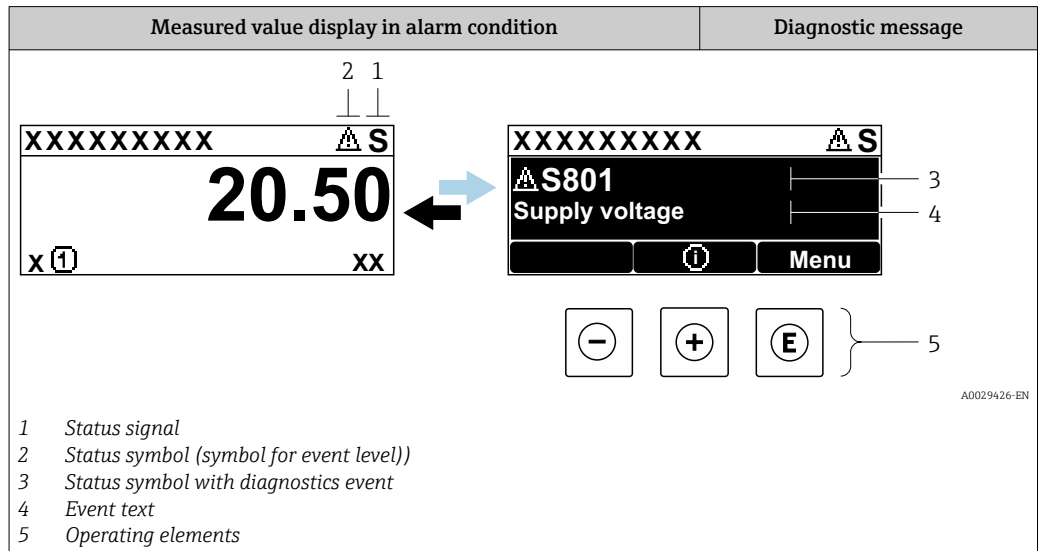

Status signals

F <small>A0032902</small>	"Failure (F)" option A device error is present. The measured value is no longer valid.
C <small>A0032903</small>	"Function check (C)" option The device is in service mode (e.g. during a simulation).
S <small>A0032904</small>	"Out of specification (S)" option The device is operated: <ul style="list-style-type: none"> ▪ Outside of its technical specifications (e.g. during startup or a cleaning) ▪ Outside of the configuration carried out by the user (e.g. level outside configured span)
M <small>A0032905</small>	"Maintenance required (M)" option Maintenance is required. The measured value is still valid.

Status symbol (symbol for event level)

⊗	"Alarm" status The measurement is interrupted. The signal outputs take on the defined alarm condition. A diagnostic message is generated.
⚠	"Warning" status The device continues to measure. A diagnostic message is generated.

Diagnostics event and event text

The fault can be identified using the diagnostics event. The event text helps you by providing information about the fault. In addition, the corresponding symbol is displayed before the diagnostics event.

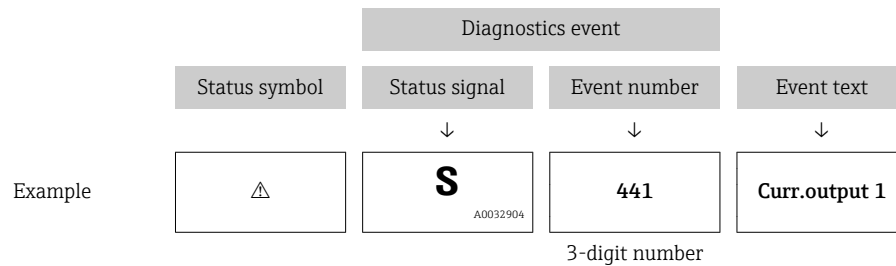

If two or more diagnostic messages are pending simultaneously, only the message with the highest priority is shown. Additional pending diagnostic messages can be shown in the **Diagnostic list** submenu.

-  Past diagnostic messages that are no longer pending are shown as follows:
- On the local display:
in the **Event logbook** submenu
 - In FieldCare:
via the "Event List /HistoROM" function.

Operating elements

Operating functions in menu, submenu	
	Plus key Opens the message about the remedial measures.
	Enter key Opens the operating menu.

13.2.2 Calling up remedial measures

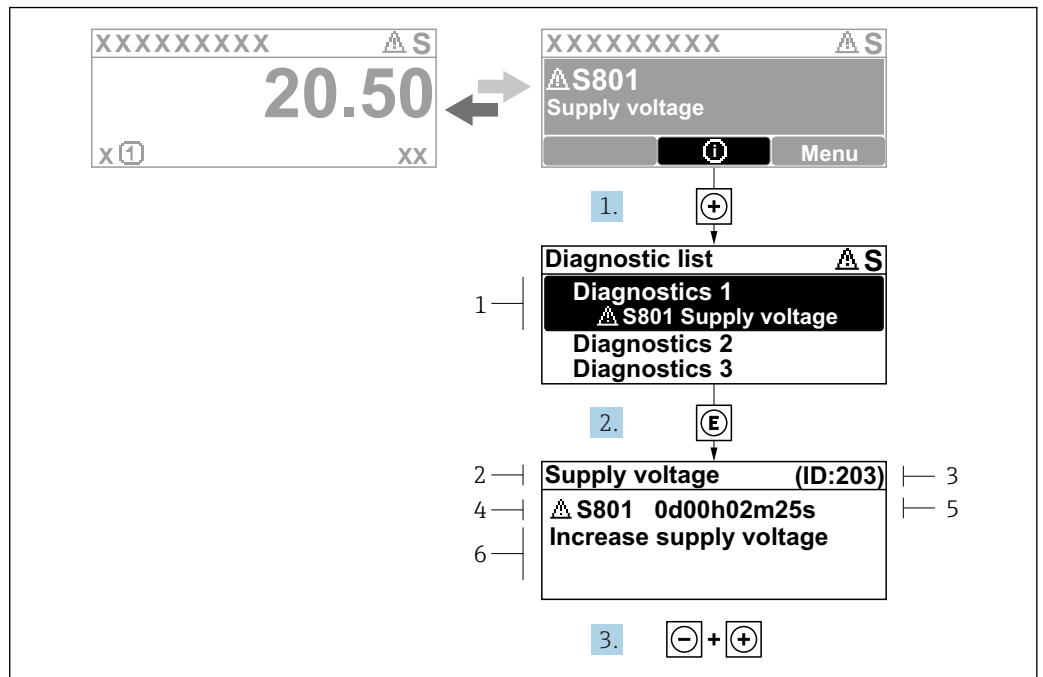

43 Message for remedial measures

A0029431-EN

- 1 Diagnostic information
- 2 Short text
- 3 Service ID
- 4 Diagnostic behavior with diagnostic code
- 5 Operation time of occurrence
- 6 Remedial measures

The user is in the diagnostic message.

1. Press **Ⓢ** (**Ⓢ**-Symbol).
↳ **Diagnostic list** submenu opens.
2. Select the desired diagnostic event with **+** or **-** and press **E**.
↳ The message for the remedial measures for the selected diagnostic event opens.
3. Press **-** + **+** simultaneously.
↳ The message for the remedial measures closes.

The user is in the **Diagnostics** menu at an entry for a diagnostics event, e.g. in **Diagnostic list** submenu or in **Previous diagnostics**.

1. Press **E**.
↳ The message for the remedial measures for the selected diagnostic event opens.
2. Press **-** + **+** simultaneously.
↳ The message for the remedial measures closes.

13.3 Diagnostic event in the operating tool

If a diagnostic event is present in the device, the status signal appears in the top left status in the operating tool along with the corresponding symbol for event level in accordance with NAMUR NE 107:

- Failure (F)
- Function check (C)
- Out of specification (S)
- Maintenance required (M)

A: Via the operating menu

1. Navigate to the **Diagnostics** menu.
 - ↳ In the **Actual diagnostics** parameter, the diagnostic event is shown with event text.
2. On the right in the display range, hover the cursor over the **Actual diagnostics** parameter.

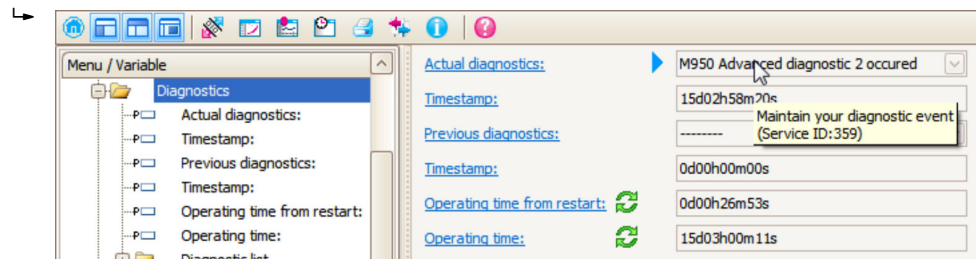

A tool tip with remedial measures for the diagnostic event appears.

B: Via the "Create documentation" function

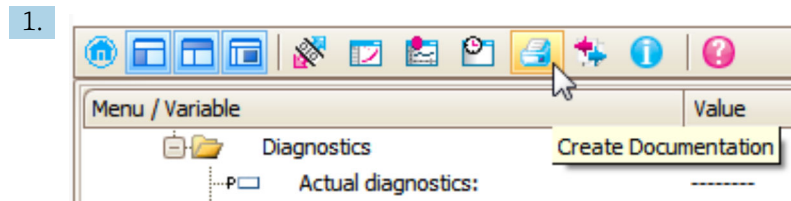

Select the "Create documentation" function.

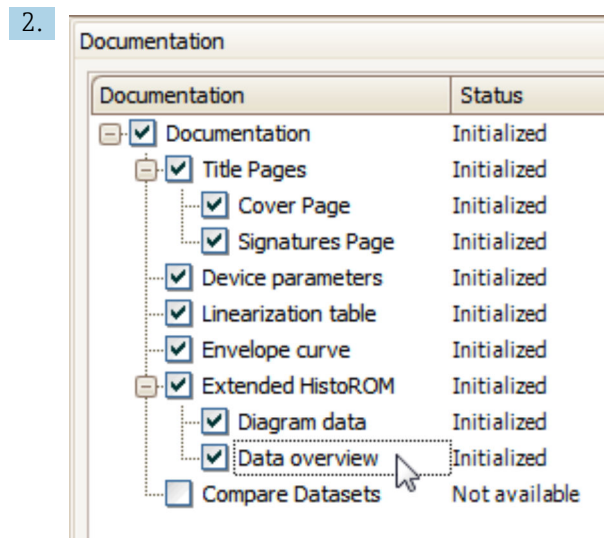

Make sure "Data overview" is marked.

3. Click "Save as ..." and save a PDF of the protocol.
 - ↳ The protocol contains the diagnostic messages and remedy information.

C: Via the "Eventlist / Extended HistoROM" function

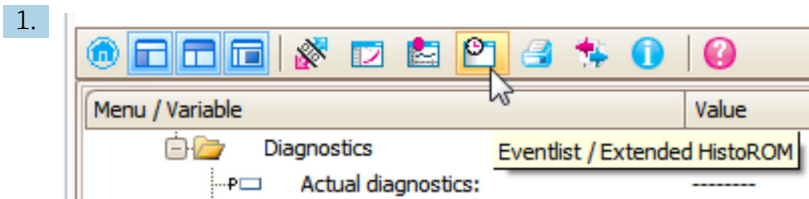

Select the "Eventlist / Extended HistoROM" function.

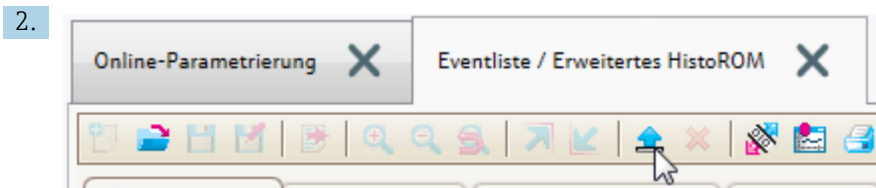

Select the "Load Eventlist" function.

- ↳ The list of events, including remedy information, is shown in the "Data overview" window.

13.4 Diagnostic list

In the **Diagnostic list** submenu submenu, up to 5 currently pending diagnostic messages can be displayed. If more than 5 messages are pending, the messages with the highest priority are shown on the display.

Navigation path

Diagnostics → Diagnostic list

Calling up and closing the remedial measures

1. Press \square .
 - ↳ The message for the remedial measures for the selected diagnostic event opens.
2. Press \square + \boxplus simultaneously.
 - ↳ The message about the remedial measures closes.

13.5 Overview of diagnostic events

Diagnostic number	Short text	Remedy instructions	Status signal [from the factory]	Diagnostic behavior [from the factory]
Diagnostic of electronic				
242	Software incompatible	1. Check software 2. Flash or change main electronics module	F	Alarm
252	Modules incompatible	1. Check if correct electronic modul is plugged 2. Replace electronic module	F	Alarm
261	Electronic modules	1. Restart device 2. Check electronic modules 3. Change I/O Modul or main electronics	F	Alarm
262	Module connection	1. Check module connections 2. Change electronic modules	F	Alarm
270	Main electronic failure	Change main electronic module	F	Alarm
271	Main electronic failure	1. Restart device 2. Change main electronic module	F	Alarm
272	Main electronic failure	1. Restart device 2. Contact service	F	Alarm
273	Main electronic failure	1. Emergency operation via display 2. Change main electronics	F	Alarm
275	I/O module defective	Change I/O module	F	Alarm
276	I/O module faulty	1. Restart device 2. Change I/O module	F	Alarm
276	I/O module faulty		F	Alarm
282	Data storage	1. Restart device 2. Contact service	F	Alarm
283	Memory content	1. Transfer data or reset device 2. Contact service	F	Alarm
311	Electronic failure	Maintenance required! 1. Do not perform reset 2. Contact service	M	Warning
Diagnostic of configuration				
410	Data transfer	1. Check connection 2. Retry data transfer	F	Alarm
411	Up-/download active	Up-/download active, please wait	C	Warning
412	Processing download	Download active, please wait	C	Warning
431	Trim 1 to 2	Carry out trim	C	Warning
435	Linearization	Check linearization table	F	Alarm
437	Configuration incompatible	1. Restart device 2. Contact service	F	Alarm
438	Dataset	1. Check data set file 2. Check device configuration 3. Up- and download new configuration	M	Warning
441	Current output 1 to 2	1. Check process 2. Check current output settings	S	Warning
484	Failure mode simulation	Deactivate simulation	C	Alarm

Diagnostic number	Short text	Remedy instructions	Status signal [from the factory]	Diagnostic behavior [from the factory]
485	Simulation measured value	Deactivate simulation	C	Warning
491	Current output 1 to 2 simulation	Deactivate simulation	C	Warning
494	Switch output simulation	Deactivate simulation switch output	C	Warning
495	Diagnostic event simulation	Deactivate simulation	C	Warning
585	Simulation distance	Deactivate simulation	C	Warning
586	Record map	Recording of mapping please wait	C	Warning
Diagnostic of process				
801	Energy too low	Increase supply voltage	S	Warning
803	Current loop	1. Check wiring 2. Change I/O module	F	Alarm
825	Operating temperature	1. Check ambient temperature 2. Check process temperature	S	Warning
825	Operating temperature		F	Alarm
921	Change of reference	1. Check reference configuration 2. Check pressure 3. Check sensor	S	Warning
941	Echo lost	Check parameter 'DC value'	F	Alarm ¹⁾
942	In safety distance	1. Check level 2. Check safety distance 3. Reset self holding	S	Alarm ¹⁾
943	In blocking distance	Reduced accuracy Check level	S	Warning
950	Advanced diagnostic 1 to 2 occurred	Maintain your diagnostic event	M	Warning ¹⁾

1) Diagnostic behavior can be changed.

13.6 Event logbook

13.6.1 Event history

A chronological overview of the event messages that have occurred is provided in the **Event list** submenu ⁵⁾.

Navigation path

Diagnostics → Event logbook → Event list

A maximum of 100 event messages can be displayed in chronological order.

Die Ereignishistorie umfasst Einträge zu:



- Diagnostic events
- Information events

5) This submenu is only available for operation via local display. In the case of operation via FieldCare, the event list can be displayed with the "Event List / HistoROM" functionality of FieldCare.

In addition to the operation time of its occurrence, each event is also assigned a symbol that indicates whether the event has occurred or is ended:

- Diagnostic event
 - ☺: Event has occurred
 - ☹: Event has ended
- Information event
 - ☺: Event has occurred

Calling up and closing the remedial measures

1. Press 
 - ↳ The message for the remedial measures for the selected diagnostic event opens.
2. Press  +  simultaneously.
 - ↳ The message about the remedial measures closes.

13.6.2 Filtering the event logbook

Using the **Filter options** parameter, you can define which category of event messages is displayed in the **Event list** submenu.

Navigation path

Diagnostics → Event logbook → Filter options

Filter categories

- All
- Failure (F)
- Function check (C)
- Out of specification (S)
- Maintenance required (M)
- Information

13.6.3 Overview of information events

Info number	Info name
I1000	----- (Device ok)
I1089	Power on
I1090	Configuration reset
I1091	Configuration changed
I1092	HistoROM backup deleted
I1110	Write protection switch changed
I1137	Electronic changed
I1151	History reset
I1154	Reset terminal voltage min/max
I1155	Reset electronic temperature
I1156	Memory error trend
I1157	Memory error event list
I1184	Display connected
I1185	Display backup done
I1186	Restore via display done
I1187	Settings downloaded with display
I1188	Display data cleared

Info number	Info name
I1189	Backup compared
I1256	Display: access status changed
I1264	Safety sequence aborted
I1335	Firmware changed
I1397	Fieldbus: access status changed
I1398	CDI: access status changed
I1512	Download started
I1513	Download finished
I1514	Upload started
I1515	Upload finished
I1554	Safety sequence started
I1555	Safety sequence confirmed
I1556	Safety mode off

13.7 Firmware history

Date	Firmware version	Modifications	Documentation (FMR56/FMR57, HART)		
			Operating Instructions	Description of Parameters	Technical Information
12.2012	01.00.zz	Original software	BA01048F/00/EN/01.12	GP01014F/00/EN/01.12	TI01042F/00/EN/01.12
02.2015	01.01.zz	<ul style="list-style-type: none"> ▪ additional languages ▪ HistoROM functionality enhanced ▪ Improvements and bugfixes 	BA01048F/00/EN/03.14	GP01014F/00/EN/04.14	TI01042F/00/EN/05.14
04.2016	01.02.zz	Update to HART 7	BA01048F/00/EN/04.16 BA01048F/00/EN/05.16 ¹⁾ BA01048F/00/EN/07.18 ²⁾	GP01014F/00/EN/05.16	TI01042F/00/EN/06.16 TI01042F/00/EN/07.16 ¹⁾ TI01042F/00/EN/09.18 ²⁾

- 1) Contains information on the Heartbeat wizards which are available in the latest DTM version for DeviceCare and FieldCare.
- 2) Contains information on the Bluetooth interface.

 The firmware version can explicitly be ordered via the product structure. In this way it is possible to ensure compatibility of the firmware version with an existing or planned system integration.

14 Maintenance

The measuring device requires no special maintenance.

14.1 Exterior cleaning

When exterior-cleaning the device, always use cleaning agents that do not attack the surface of the housing and the seals.

14.2 Replacing seals

The process seals of the sensors (at the process connection) must be replaced periodically, particularly if molded seals (aseptic construction) are used. The period between changes depends on the frequency of cleaning cycles and on the temperature of the measured substance and the cleaning temperature.

15 Repairs

15.1 General information on repairs

15.1.1 Repair concept

The Endress+Hauser repair concept assumes that the devices have a modular design and that repairs can be done by the Endress+Hauser service or specially trained customers.

Spare parts are contained in suitable kits. They contain the related replacement instructions.

For more information on service and spare parts, contact the Service Department at Endress+Hauser.

15.1.2 Repairs to Ex-approved devices

When carrying out repairs to Ex-approved devices, please note the following:

- Repairs to Ex-approved devices may only be carried out by trained personnel or by the Endress+Hauser Service.
- Comply with the prevailing standards, national Ex-area regulations, safety instructions (XA) and certificates.
- Only use original spare parts from Endress+Hauser.
- When ordering a spare part, please note the device designation on the nameplate. Only replace parts with identical parts.
- Carry out repairs according to the instructions. On completion of repairs, carry out the specified routine test on the device.
- Only Endress+Hauser Service may convert a certified device into a different certified variant.
- Document all repair work and conversions.

15.1.3 Replacement of an electronics module

If an electronics module has been replaced, it is not necessary to perform a new basic setup as the calibration parameters are stored in the HistoROM which is located in the housing. However, after exchanging the main electronics module it may be necessary to record a new mapping (interference echo suppression).

15.1.4 Replacement of a device

After a complete device or electronic module has been replaced, the parameters can be downloaded into the instrument again in one of the following ways:

- Via the display module
Condition: The configuration of the old device has been saved in the display module
→  172.
- Via FieldCare
Condition: The configuration of the old device has been saved to the computer via FieldCare.

You can continue to measure without carrying out a new setup. Only a linearization and a tank map (interference echo suppression) have to be recorded again.

15.2 Spare parts

- A few interchangeable measuring device components are identified by a spare part nameplate. This contains information about the spare part.
- The connection compartment cover of the device contains a spare part nameplate that includes the following information:
 - A list of the most important spare parts for the measuring device, including their ordering information.
 - The URL for the *W@M Device Viewer* (www.endress.com/deviceviewer): There, all spare parts for the measuring device are listed, including the order code, and can be ordered. If available, the corresponding Installation Instructions can also be downloaded there.

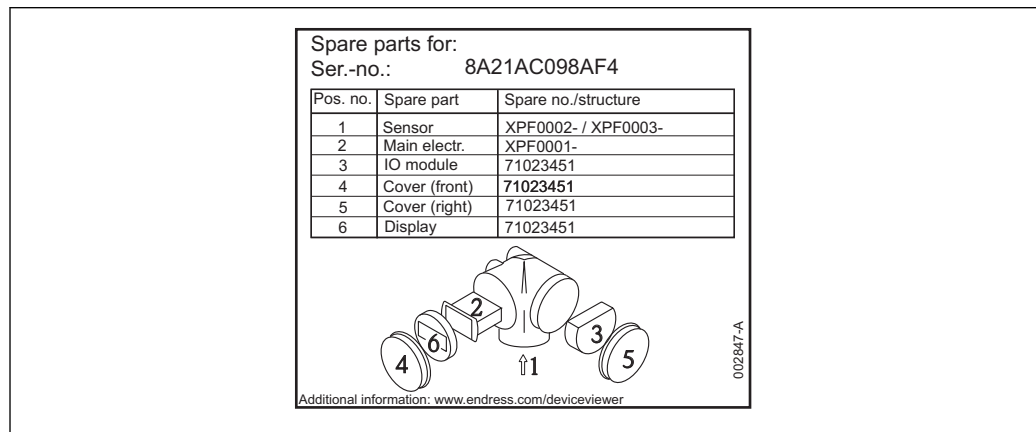

44 Example for spare part nameplate in connection compartment cover

- i** Measuring device serial number:
 - Is located on the device and spare part nameplate.
 - Can be read out via the "Serial number" parameter in the "Device information" submenu.

15.3 Return

The measuring device must be returned if it is need of repair or a factory calibration, or if the wrong measuring device has been delivered or ordered. Legal specifications require Endress+Hauser, as an ISO-certified company, to follow certain procedures when handling products that are in contact with the medium.

To ensure safe, swift and professional device returns, please refer to the procedure and conditions for returning devices provided on the Endress+Hauser website at <http://www.endress.com/support/return-material>

15.4 Disposal



Observe the following notes during disposal:

- Observe valid federal/national regulations.
- Ensure proper separation and reuse of the device components.

16 Accessories

16.1 Device-specific accessories

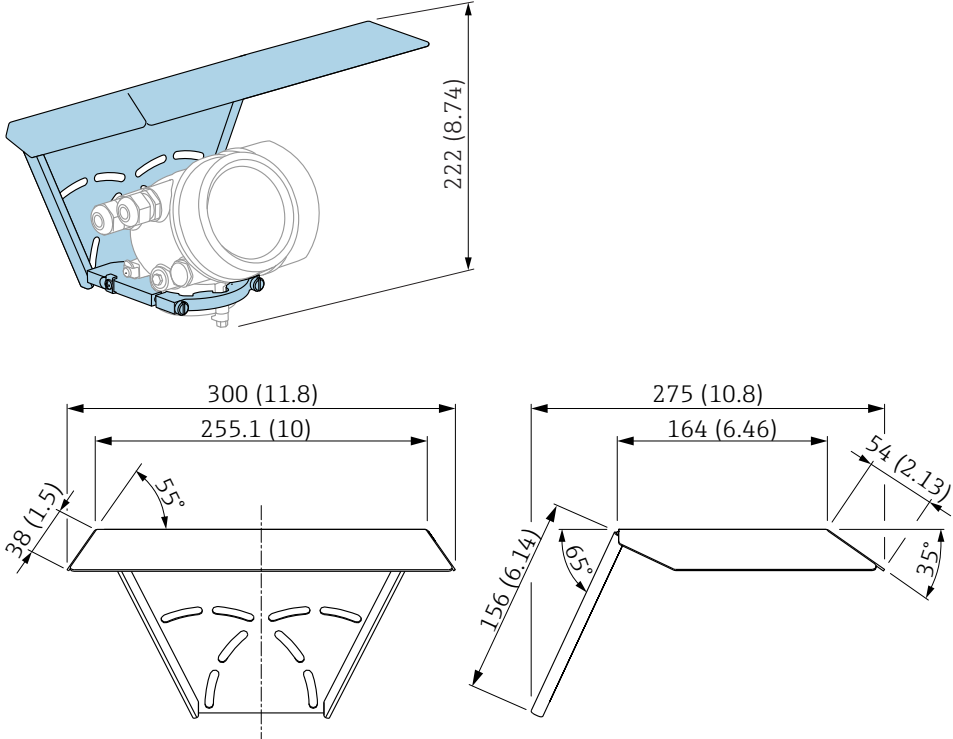
16.1.1 Weather protection cover

Accessory	Description
Weather protection cover	 <p data-bbox="1476 869 1528 882">A0015466</p> <p data-bbox="1476 1279 1528 1292">A0015472</p> <p data-bbox="416 1305 925 1330">☑ 45 Weather protection cover; Dimensions: mm (in)</p> <p data-bbox="416 1359 1492 1435">  The weather protection cover can be ordered together with the device (product structure, feature 620 "Accessory Enclosed", option PB "Weather Protection Cover"). Alternatively, it can be separately ordered as an accessory; order code 71162242. </p>

16.1.2 Variable flange seal for FMR50/FMR56

Accessory	Description		
Variable flange seal for FMR50/FMR56	<div style="display: flex; justify-content: space-around;"> </div> <p style="text-align: right; font-size: small;">A0018871</p> <ol style="list-style-type: none"> 1 UNI slip-on flange 2 Variable flange seal 3 Nozzle <p>i The material and process conditions of the adjustable flange seal must fit the process properties (temperature, pressure, resistance).</p> <p>i For FMR56: The variable flange seal can also be ordered together with the device (product structure: feature 620 "Accessory Enclosed", options PL, PM, PN, PO, PQ, PR).</p>		
Technical data: DN/JIS version			
Order code	71074263	71074264	71074265
Compatible with	DN80 PN10/40	DN100 PN10/16	<ul style="list-style-type: none"> ■ DN150 PN10/16 ■ JIS 10K 150A
Length of screws	100 mm (3.9 in)	100 mm (3.9 in)	110 mm (4.3 in)
Size of screws	M14	M14	M18
Material	EPDM		
Process pressure	-0.1 to 0.1 bar (-1.45 to 1.45 psi)		
Process temperature	-40 to +80 °C (-40 to +176 °F)		
D	142 mm (5.59 in)	162 mm (6.38 in)	218 mm (8.58 in)
d	89 mm (3.5 in)	115 mm (4.53 in)	169 mm (6.65 in)
h	22 mm (0.87 in)	23.5 mm (0.93 in)	26.5 mm (1.04 in)
h _{min}	14 mm (0.55 in)	14 mm (0.55 in)	14 mm (0.55 in)
h _{max}	30 mm (1.18 in)	33 mm (1.3 in)	39 mm (1.45 in)

Accessory	Description			
	Technical data: ASME/JIS version			
Order code	71249070	71249072	71249073	
Compatible with	<ul style="list-style-type: none"> ■ ASME 3" 150lbs ■ JIS 80A 10K 	ASME 4" 150lbs	ASME 6" 150lbs	
Length of screws	100 mm (3.9 in)	100 mm (3.9 in)	110 mm (4.3 in)	
Recommended screw size	M14	M14	M18	
Material	EPDM			
Process pressure	-0.1 to 0.1 bar (-1.45 to 1.45 psi)			
Process temperature	-40 to +80 °C (-40 to +176 °F)			
D	133 mm (5.2 in)	171 mm (6.7 in)	219 mm (8.6 in)	
d	89 mm (3.5 in)	115 mm (4.53 in)	168 mm (6.6 in)	
h	22 mm (0.87 in)	23.5 mm (0.93 in)	26.5 mm (1.04 in)	
h _{min}	14 mm (0.55 in)	14 mm (0.55 in)	14 mm (0.55 in)	
h _{max}	30 mm (1.18 in)	33 mm (1.3 in)	39 mm (1.45 in)	

16.1.3 Mounting bracket for wall or ceiling mounting of FMR50/FMR56

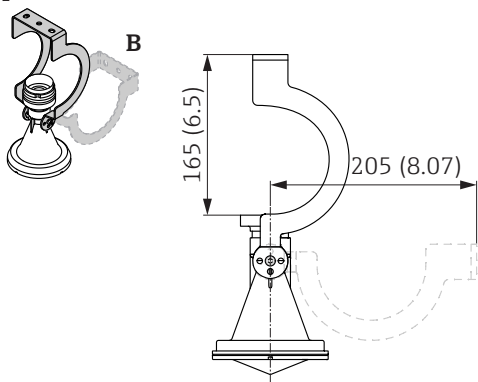
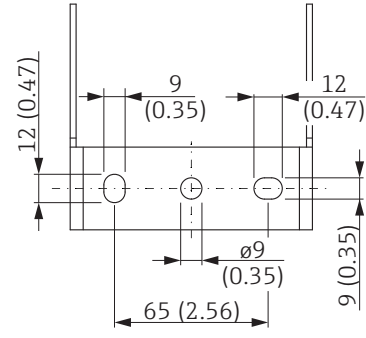
Accessory	Description
Mounting bracket for wall or ceiling mounting of FMR50/FMR56	<div style="display: flex; align-items: flex-start;"> <div style="margin-right: 20px;"> <p>A</p>  <p>B</p>  </div> <div style="margin-top: 10px;"> <p>■ 46 Mounting bracket for FMR50/FMR56 with horn antenna</p> <p>A Mounting at ceiling B Mounting at wall</p> <p>■ Material:</p> <ul style="list-style-type: none"> - Mounting bracket: 304 (1.4301) - Screws: A2 - Nordlock washer: A4 <p>■ Order code: 71162776</p> </div> </div>



A0017746

16.1.4 Remote display FHX50

Accessories	Description
Remote display FHX50	<div data-bbox="327 324 1204 772" style="text-align: center;"> </div> <p style="text-align: right; font-size: small;">A0019128</p> <ul style="list-style-type: none"> ▪ Material: <ul style="list-style-type: none"> – Plastic PBT – 316L/1.4404 – Aluminum ▪ Degree of protection: IP68 / NEMA 6P and IP66 / NEMA 4x ▪ Suitable for display modules: <ul style="list-style-type: none"> – SD02 (push buttons) – SD03 (touch control) ▪ Connecting cable: <ul style="list-style-type: none"> – Cable supplied with device up to 30 m (98 ft) – Standard cable supplied by customer up to 60 m (196 ft) ▪ Ambient temperature range: –40 to 80 °C (–40 to 176 °F) ▪ Ambient temperature range (option): –50 to 80 °C (–58 to 176 °F) ¹⁾ <p> i ▪ If the remote display should be used, order the device version "Prepared for display FHX50" (feature 030, version L, M or N). For the FHX50, you must select option A: "Prepared for display FHX50" under feature 050 "Measuring device version". </p> <p> i ▪ If the device version "Prepared for display FHX50" was not originally ordered and a FHX50 display is to be retrofitted, you must select version B "Not prepared for display FHX50" under feature 050: "Measuring device version" when ordering the FHX50. In this case, a retrofit kit for the device is supplied with the FHX50. The kit can be used to prepare the device so that the FHX50 can be used. </p> <p> i Use of the FHX50 may be restricted for transmitters with an approval. A device can only be retrofitted with the FHX50 if the option L, M or N ("Prepared for FHX50") is listed under <i>Basic specifications</i>, item 4 "Display, operation" in the Safety Instructions (XA) for the device. Also pay attention to the Safety Instructions (XA) of the FHX50. </p> <p> i Retrofitting is not possible on transmitters with: <ul style="list-style-type: none"> ▪ An approval for use in areas with flammable dust (dust ignition-proof approval) ▪ Ex nA type of protection </p> <p> i For details, see document SD01007F. </p>

1) This range is valid if option JN "Ambient temperature transmitter –50 °C (–58 °F)" has been selected in ordering feature 580 "Test, Certificate". If the temperature is permanently below –40 °C (–40 °F), failure rates may be increased.

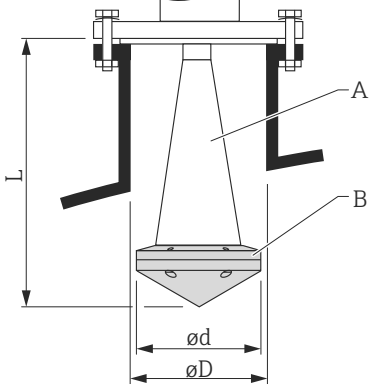
16.1.5 Horn protection for horn antenna

Accessory	Description
Horn protection for 80 mm (3 in) or 100 mm (4 in) horn antenna	<div style="text-align: center;">  </div> <p style="text-align: right; font-size: small;">A0019143</p> <p>A Horn antenna of the Micropilot (not supplied with the horn protection) B Horn protection ød Diameter of horn protection (see table below) ØD Minimum nozzle diameter (see table below) L Length of antenna with horn protection (see table below)</p> <p>For details please refer to the Mounting Instructions SD01084F.</p> <p>Process conditions</p> <ul style="list-style-type: none"> ▪ Maximum vessel pressure: 0.5 bar (7.252 psi) ▪ Maximum process temperature: 130 °C (266 °F) <p> Danger of explosion Avoid electrostatic charging of the horn protection.</p>

Horn protection for FMR57

Antenna ¹⁾	Order code horn protection	Dimensions antenna + horn protection		
		L	Ød	ØD
BC: Horn 80mm/3"	71105890	238 mm (9.4 in)	96 mm (3.78 in)	≥ DN100
BD: Horn 100mm/4"	71105889	450 mm (17.7 in)	116 mm (4.57 in)	≥ DN150

1) Feature 070 of the product structure

 The horn protection can also be ordered together with the device. Product structure: Feature 610 "Accessory Mounted", option OW "Horn protection, PTFE".

16.1.6 Overvoltage protection

Accessory	Description
Overvoltage protection for 2-wire-devices OVP10 (1 channel) OVP20 (2 channel)	<div data-bbox="327 324 715 660" data-label="Image"> </div> <div data-bbox="1380 667 1436 683" data-label="Text"> <p>A0021734</p> </div> <p>Technical data</p> <ul style="list-style-type: none"> ▪ Resistance per channel: $2 * 0.5 \Omega_{max}$ ▪ Threshold DC voltage: 400 to 700 V ▪ Threshold impulse voltage: < 800 V ▪ Capacitance at 1 MHz: < 1.5 pF ▪ Nominal arrest impulse voltage (8/20 μs): 10 kA ▪ Suited for wire cross-sections: 0.2 to 2.5 mm² (24 to 14 AWG) <p>i Ordering with device The overvoltage protection module is preferably ordered with the device. See product structure, feature 610 "Accessory mounted", option NA "Overvoltage protection". Separate ordering of the module is only necessary if a device is to be retrofitted with the overvoltage protection.</p> <p>i Order code for retrofitting</p> <ul style="list-style-type: none"> ▪ For 1-channel devices (feature 020, option A) OVP10: 71128617 ▪ For 2-channel devices (feature 020, option B, C, E or G) OVP20 : 71128619 <p>Housing lid for retrofitting In order to keep the necessary safety distances, the housing lid needs to be replaced if the device is retrofitted with the overvoltage protection. Depending on the housing type, the order code of the suitable lid is as follows:</p> <ul style="list-style-type: none"> ▪ GT18 housing: Lid 71185516 ▪ GT19 housing: Lid 71185518 ▪ GT20 housing: Lid 71185516 <p>i Restrictions for retrofitting Depending on the approval of the transmitter the usage of the OVP module may be restricted. A device may only be retrofitted with an OVP module if the option NA (overvoltage protection) is quoted under <i>Optional Specifications</i> in the Safety Instructions (XA) pertaining to the device.</p> <p>i For details refer to SD01090F.</p>

16.1.7 Bluetooth module for HART devices

Accessory	Description
Bluetooth module	<div data-bbox="416 324 1066 768" data-label="Image"> </div> <div data-bbox="1476 779 1528 792" data-label="Text">A0036493</div> <ul style="list-style-type: none"> ▪ Quick and easy commissioning via SmartBlue (app) ▪ No additional tools or adapters required ▪ Signal curve via SmartBlue (app) ▪ Encrypted single point-to-point data transmission (tested by Fraunhofer institute) and password protected communication via Bluetooth® wireless technology ▪ Range under reference conditions: > 10 m (33 ft) <p>i When using the Bluetooth module the minimum supply voltage increases by up to 3 V.</p> <p>i Ordering with device The Bluetooth module is preferably ordered with the device. See product structure, feature 610 "Accessory Mounted", option NF "Bluetooth". A separate order is only necessary in case of retrofitting.</p> <p>i Order code for retrofitting Bluetooth module (BT10): 71377355</p> <p>i Restrictions in case of retrofitting Depending on the approval of the transmitter, application of the Bluetooth module may be restricted. A device may only be retrofitted with a Bluetooth module if the option <i>NF</i> (Bluetooth) is listed in the associated Safety Instructions (<i>XA</i>) under <i>Optional specifications</i>.</p> <p>i For details refer to SD02252F.</p>

16.2 Communication-specific accessories

Accessory	Description
Commubox FXA195 HART	For intrinsically safe HART communication with FieldCare via the USB interface.  For details refer to Technical Information TI00404F

Accessory	Description
Commubox FXA291	Connects Endress+Hauser field devices with CDI interface (= Endress+Hauser Common Data Interface) to the USB interface of a computer. Order code: 51516983  For details refer to Technical Information TI00405C

Accessory	Description
HART Loop Converter HMX50	Evaluates the dynamic HART variables and converts them to analog current signals or limit values. Order code: 71063562  For details refer to Technical Information TI00429F and Operating Instructions BA00371F

Accessory	Description
WirelessHART Adapter SWA70	Connects field devices to a WirelessHART network. The WirelessHART adapter can be mounted directly at a HART device and is easily integrated into an existing HART network. It ensures safe data transmission and can be operated in parallel with other wireless networks.  For details refer to Operating Instructions BA00061S

Accessories	Description
Connect Sensor FXA30/FXA30B	Fully integrated, battery-powered gateway for simple applications with SupplyCare Hosting. Up to 4 field devices with 4 to 20 mA communication (FXA30/FXA30B), serial Modbus (FXA30B) or HART (FXA30B) can be connected. With its robust design and ability to run for years on the battery, it is ideal for remote monitoring in isolated locations. Version with LTE (USA, Canada and Mexico only) or 3G mobile transmission for worldwide communication.  For details, see "Technical Information" TI01356S and Operating Instructions BA01710S.

Accessories	Description
Fieldgate FXA42	Fieldgates enable communication between connected 4 to 20 mA, Modbus RS485 and Modbus TCP devices and SupplyCare Hosting or SupplyCare Enterprise. The signals are transmitted either via Ethernet TCP/IP, WLAN or mobile communications (UMTS). Advanced automation capabilities are available, such as an integrated Web-PLC, OpenVPN and other functions.  For details, see "Technical Information" TI01297S and Operating Instructions BA01778S.



Accessories	Description
SupplyCare Enterprise SCE30B	<p>Inventory management software that visualizes levels, volumes, masses, temperatures, pressures, densities or other tank parameters. The parameters are recorded and transmitted by means of gateways of the type Fieldgate FXA42.</p> <p>This Web-based software is installed on a local server and can also be visualized and operated with mobile terminals such as a smartphone or tablet.</p> <p> For details, see "Technical Information" TI01228S and Operating Instructions BA00055S</p>

Accessories	Description
SupplyCare Hosting SCH30	<p>Inventory management software that visualizes levels, volumes, masses, temperatures, pressures, densities or other tank parameters. The parameters are recorded and transmitted by means of gateways of the type Fieldgate FXA42, FXA30 and FXA30B.</p> <p>SupplyCare Hosting is offered as a hosting service (Software as a Service, SaaS). In the Endress+Hauser portal, the user is provided with the data over the Internet.</p> <p> For details, see "Technical Information" TI01229S and Operating Instructions BA00050S.</p>



Accessory	Description
Field Xpert SFX350	<p>Field Xpert SFX350 is a mobile computer for commissioning and maintenance. It enables efficient device configuration and diagnostics for HART and FOUNDATION fieldbus devices in the non-Ex area.</p> <p> For details, see Operating Instructions BA01202S</p>

Accessory	Description
Field Xpert SFX370	<p>Field Xpert SFX370 is a mobile computer for commissioning and maintenance. It enables efficient device configuration and diagnostics for HART and FOUNDATION fieldbus devices in the non-Ex area and the Ex area.</p> <p> For details, see Operating Instructions BA01202S</p>

16.3 Service-specific accessories

Accessory	Description
DeviceCare SFE100	<p>Configuration tool for HART, PROFIBUS and FOUNDATION Fieldbus devices</p> <p> Technical Information TI01134S</p> <p> <ul style="list-style-type: none"> DeviceCare is available for download at www.software-products.endress.com. The download requires a registration in the Endress+Hauser software portal. Alternatively, a DeviceCare DVD can be ordered with the device. Product structure: Feature 570 "Service", Option IV "Tooling DVD (DeviceCare Setup)". </p>
FieldCare SFE500	<p>FDT-based Plant Asset Management tool.</p> <p>Helps to configure and maintain all field devices of your plant. By supplying status information it also supports the diagnosis of the devices.</p> <p> Technical Information TI00028S</p>





















16.4 System components

























Accessory	Description
Graphic Data Manager Memograph M	<p>The graphic data manager Memograph M provides information on all the relevant process variables. Measured values are recorded correctly, limit values are monitored and measuring points analyzed. The data are stored in the 256 MB internal memory and also on an SD card or USB stick.</p> <p> For details refer to Technical Information TI00133R and Operating Instructions BA00247R</p>
RN22.1N	<p>Active barrier with power supply for safe separation of 4 to 20 mA current circuits. Provides bi-directional HART transmission.</p> <p> For details refer to Technical Information TI00073R and Operating Instructions BA00202R</p>
RNS221	<p>Transmitter supply for 2-wire sensors or transmitters exclusively for non-Ex areas. Provides bi-directional communication using the HART communication sockets.</p> <p> For details refer to Technical Information TI00081R and Operating Instructions KA00110R</p>

17 Operating menu

























17.1 Overview of the operating menu (SmartBlue)

Navigation  SmartBlue

Setup	→  125
Device tag	→  125
Distance unit	→  125
Bin type	→  125
Max. filling speed solid	→  126
Max. draining speed solid	→  126
Empty calibration	→  127
Full calibration	→  128
Level	→  128
Distance	→  129
Signal quality	→  129
Confirm distance	→  130
Present mapping	→  131
Mapping end point	→  131
Record map	→  132
► Advanced setup	→  135
Locking status	→  135
Access status tooling	→  135
Enter access code	→  136
► Level	→  137
Medium type	→  137

Medium property	→  137
Advanced process conditions	→  138
Level unit	→  138
Blocking distance	→  139
Level correction	→  139
Tank/silo height	→  140
► Linearization	→  142
Linearization type	→  144
Unit after linearization	→  145
Free text	→  146
Level linearized	→  146
Maximum value	→  147
Diameter	→  147
Intermediate height	→  147
Table mode	→  148
Table number	→  149
Level	→  149
Level	→  150
Customer value	→  150
Activate table	→  150
► Safety settings	→  151
Output echo lost	→  151
Value echo lost	→  151
Ramp at echo lost	→  152
Blocking distance	→  139























▶ Current output 1 to 2	→ 📖 156
Assign current output	→ 📖 156
Current span	→ 📖 157
Fixed current	→ 📖 157
Damping output	→ 📖 158
Failure mode	→ 📖 158
Failure current	→ 📖 159
Output current 1 to 2	→ 📖 159
▶ Switch output	→ 📖 160
Switch output function	→ 📖 160
Assign status	→ 📖 161
Assign limit	→ 📖 161
Assign diagnostic behavior	→ 📖 161
Switch-on value	→ 📖 162
Switch-on delay	→ 📖 163
Switch-off value	→ 📖 163
Switch-off delay	→ 📖 164
Failure mode	→ 📖 164
Switch status	→ 📖 164
Invert output signal	→ 📖 164
🔍 Diagnostics	→ 📖 178
Actual diagnostics	→ 📖 178
Timestamp	→ 📖 178
Previous diagnostics	→ 📖 178
Timestamp	→ 📖 179

Operating time from restart	→  179
Operating time	→  172
▶ Diagnostic list	→  180
Diagnostics 1 to 5	→  180
Timestamp 1 to 5	→  180
▶ Device information	→  182
Device tag	→  182
Serial number	→  182
Firmware version	→  182
Device name	→  182
Order code	→  183
Extended order code 1 to 3	→  183
Device revision	→  183
Device ID	→  183
Device type	→  184
Manufacturer ID	→  184
▶ Measured values	→  185
Distance	→  129
Level linearized	→  146
Output current 1 to 2	→  159
Measured current 1	→  186
Terminal voltage 1	→  186
Electronic temperature	→  186
▶ Simulation	→  191
Assign measurement variable	→  192

Process variable value	→ 192
Current output 1 to 2 simulation	→ 192
Value current output 1 to 2	→ 193
Switch output simulation	→ 193
Switch status	→ 193
Device alarm simulation	→ 194
Diagnostic event simulation	→ 194

17.2 Overview of the operating menu (display module)

Navigation  Operating menu























Language	→  166
Setup	→  125
Device tag	→  125
Distance unit	→  125
Bin type	→  125
Max. filling speed solid	→  126
Max. draining speed solid	→  126
Empty calibration	→  127
Full calibration	→  128
Level	→  128
Distance	→  129
Signal quality	→  129
Mapping	→  133
Confirm distance	→  133
Mapping end point	→  133
Record map	→  133
Distance	→  133
Prepare recording map	→  133
Advanced setup	→  135
Locking status	→  135
Access status display	→  136
Enter access code	→  136

▶ Level	→ 137
Medium type	→ 137
Medium property	→ 137
Advanced process conditions	→ 138
Level unit	→ 138
Blocking distance	→ 139
Level correction	→ 139
Tank/silo height	→ 140
▶ Linearization	→ 142
Linearization type	→ 144
Unit after linearization	→ 145
Free text	→ 146
Maximum value	→ 147
Diameter	→ 147
Intermediate height	→ 147
Table mode	→ 148
▶ Edit table	
Level	→ 149
Customer value	→ 150
Activate table	→ 150
▶ Safety settings	→ 151
Output echo lost	→ 151
Value echo lost	→ 151
Ramp at echo lost	→ 152
Blocking distance	→ 139

▶ SIL/WHG confirmation	→ 154
▶ Deactivate SIL/WHG	→ 155
Reset write protection	→ 155
Code incorrect	→ 155
▶ Current output 1 to 2	→ 156
Assign current output	→ 156
Current span	→ 157
Fixed current	→ 157
Damping output	→ 158
Failure mode	→ 158
Failure current	→ 159
Output current 1 to 2	→ 159
▶ Switch output	→ 160
Switch output function	→ 160
Assign status	→ 161
Assign limit	→ 161
Assign diagnostic behavior	→ 161
Switch-on value	→ 162
Switch-on delay	→ 163
Switch-off value	→ 163
Switch-off delay	→ 164
Failure mode	→ 164
Switch status	→ 164
Invert output signal	→ 164

▶ Display	→ 166
Language	→ 166
Format display	→ 166
Value 1 to 4 display	→ 168
Decimal places 1 to 4	→ 168
Display interval	→ 168
Display damping	→ 169
Header	→ 169
Header text	→ 169
Separator	→ 170
Number format	→ 170
Decimal places menu	→ 170
Backlight	→ 171
Contrast display	→ 171
▶ Configuration backup display	→ 172
Operating time	→ 172
Last backup	→ 172























Configuration management	→ 172
Comparison result	→ 173
▶ Administration	→ 175
▶ Define access code	→ 177
Define access code	→ 177
Confirm access code	→ 177
Device reset	→ 175
🔍 Diagnostics	→ 178
Actual diagnostics	→ 178
Previous diagnostics	→ 178
Operating time from restart	→ 179
Operating time	→ 172
▶ Diagnostic list	→ 180
Diagnostics 1 to 5	→ 180
▶ Event logbook	→ 181
Filter options	→ 181
▶ Event list	→ 181
▶ Device information	→ 182
Device tag	→ 182
Serial number	→ 182
Firmware version	→ 182
Device name	→ 182
Order code	→ 183
Extended order code 1 to 3	→ 183
Device revision	→ 183

























Device ID	→  183
Device type	→  184
Manufacturer ID	→  184
► Measured values	→  185
Distance	→  129
Level linearized	→  146
Output current 1 to 2	→  159
Measured current 1	→  186
Terminal voltage 1	→  186
Electronic temperature	→  186
► Data logging	→  187
Assign channel 1 to 4	→  187
Logging interval	→  187
Clear logging data	→  188
► Display channel 1 to 4	→  189
► Simulation	→  191
Assign measurement variable	→  192
Process variable value	→  192
Current output 1 to 2 simulation	→  192
Value current output 1 to 2	→  193
Switch output simulation	→  193
Switch status	→  193
Device alarm simulation	→  194

Diagnostic event category	
Diagnostic event simulation	→ 194
▶ Device check	→ 195
Start device check	→ 195
Result device check	→ 195
Last check time	→ 195
Level signal	→ 196



























17.3 Overview of the operating menu (operating tool)

























Navigation  Operating menu

Setup	→  125
Device tag	→  125
Distance unit	→  125
Bin type	→  125
Max. filling speed solid	→  126
Max. draining speed solid	→  126
Empty calibration	→  127
Full calibration	→  128
Level	→  128
Distance	→  129
Signal quality	→  129
Confirm distance	→  130
Present mapping	→  131
Mapping end point	→  131
Record map	→  132
▶ Advanced setup	→  135
Locking status	→  135
Access status tooling	→  135
Enter access code	→  136
▶ Level	→  137
Medium type	→  137
Medium property	→  137
Advanced process conditions	→  138

Level unit	→  138
Blocking distance	→  139
Level correction	→  139
Tank/silo height	→  140
► Linearization	→  142
Linearization type	→  144
Unit after linearization	→  145
Free text	→  146
Level linearized	→  146
Maximum value	→  147
Diameter	→  147
Intermediate height	→  147
Table mode	→  148
Table number	→  149
Level	→  149
Level	→  150
Customer value	→  150
Activate table	→  150
► Safety settings	→  151
Output echo lost	→  151
Value echo lost	→  151
Ramp at echo lost	→  152
Blocking distance	→  139
► SIL/WHG confirmation	→  154

▶ Deactivate SIL/WHG	→ 155
Reset write protection	→ 155
Code incorrect	→ 155
▶ Current output 1 to 2	→ 156
Assign current output	→ 156
Current span	→ 157
Fixed current	→ 157
Damping output	→ 158
Failure mode	→ 158
Failure current	→ 159
Output current 1 to 2	→ 159
▶ Switch output	→ 160
Switch output function	→ 160
Assign status	→ 161
Assign limit	→ 161
Assign diagnostic behavior	→ 161
Switch-on value	→ 162
Switch-on delay	→ 163
Switch-off value	→ 163
Switch-off delay	→ 164
Failure mode	→ 164
Switch status	→ 164
Invert output signal	→ 164
▶ Display	→ 166
Language	→ 166

Format display	→  166
Value 1 to 4 display	→  168
Decimal places 1 to 4	→  168
Display interval	→  168
Display damping	→  169
Header	→  169
Header text	→  169
Separator	→  170
Number format	→  170
Decimal places menu	→  170
Backlight	→  171
Contrast display	→  171
► Configuration backup display	→  172
Operating time	→  172
Last backup	→  172
Configuration management	→  172
Backup state	→  173
Comparison result	→  173
► Administration	→  175
Define access code	→  177
Device reset	→  175
 Diagnostics	→  178
Actual diagnostics	→  178
Timestamp	→  178
Previous diagnostics	→  178

Timestamp	→  179
Operating time from restart	→  179
Operating time	→  172
► Diagnostic list	→  180
Diagnostics 1 to 5	→  180
Timestamp 1 to 5	→  180
► Device information	→  182
Device tag	→  182
Serial number	→  182
Firmware version	→  182
Device name	→  182
Order code	→  183
Extended order code 1 to 3	→  183
Device revision	→  183
Device ID	→  183
Device type	→  184
Manufacturer ID	→  184
► Measured values	→  185
Distance	→  129
Level linearized	→  146
Output current 1 to 2	→  159
Measured current 1	→  186
Terminal voltage 1	→  186
Electronic temperature	→  186

▶ Data logging	→ 187
Assign channel 1 to 4	→ 187
Logging interval	→ 187
Clear logging data	→ 188
▶ Simulation	→ 191
Assign measurement variable	→ 192
Process variable value	→ 192
Current output 1 to 2 simulation	→ 192
Value current output 1 to 2	→ 193
Switch output simulation	→ 193
Switch status	→ 193
Device alarm simulation	→ 194
Diagnostic event simulation	→ 194
▶ Device check	→ 195
Start device check	→ 195
Result device check	→ 195
Last check time	→ 195
Level signal	→ 196
▶ Heartbeat	→ 197

17.4 "Setup" menu

- i

 - : Marks the navigation path to the parameter via the display and operating module.
 - : Marks the navigation path to the parameter via an operating tool (e.g. FieldCare).
 - : Marks parameters which can be locked via the software locking.

Navigation Setup

Device tag		
Navigation	Setup → Device tag	
Description	Enter a unique name for the measuring point to identify the device quickly within the plant.	
Factory setting	FMR5x	
Distance unit		
Navigation	Setup → Distance unit	
Description	Used for the basic calibration (Empty / Full).	
Selection	<i>SI units</i> <ul style="list-style-type: none"> ▪ mm ▪ m 	<i>US units</i> <ul style="list-style-type: none"> ▪ ft ▪ in
Factory setting	m	
Bin type		
Navigation	Setup → Bin type	
Prerequisite	Medium type (→ 137) = Solid	
Description	Specify bin type.	
Selection	<ul style="list-style-type: none"> ▪ Buffer silo (fast) ▪ Bin / Pile ▪ Crusher / belt ▪ Silo ▪ Workbench test 	
Factory setting	Silo	

Max. filling speed solid 

Navigation   Setup → Max. filling speed solid

Prerequisite **Medium type (→  137) = Solid**

Description Select expected maximum filling speed.

- Selection**
- Very slow < 0.5m (1.6ft) /h
 - Slow < 1m (3.3ft) /h
 - Standard < 2m (6,5ft) /h
 - Medium < 4m (13ft) /h
 - Fast < 8m (26ft) /h
 - Very fast > 8m (26ft) /h
 - No filter / test

Factory setting Standard < 2m (6,5ft) /h

Additional information The device adjusts the signal evaluation filters and the damping of the output signal to the typical rate of level change defined in this parameter:

Max. filling speed solid (→  126)	Step response time / s
Very slow < 0.5m (1.6ft) /h	910
Slow < 1m (3.3ft) /h	730
Standard < 2m (6,5ft) /h	340
Medium < 4m (13ft) /h	170
Fast < 8m (26ft) /h	75
Very fast > 8m (26ft) /h	10
No filter / test	< 1

Max. draining speed solid 

Navigation   Setup → Max. draining speed solid

Prerequisite **Medium type (→  137) = Solid**

Description Select expected maximum draining speed.

- Selection**
- Very slow < 0.5m (1.6ft) /h
 - Slow < 1m (3.3ft) /h
 - Standard < 2m (6,5ft) /h
 - Medium < 4m (13ft) /h
 - Fast < 8m (26ft) /h
 - Very fast > 8m (26ft) /h
 - No filter / test

Factory setting Standard < 2m (6,5ft) /h

Additional information

The device adjusts the signal evaluation filters and the damping of the output signal to the typical rate of level change defined in this parameter:

Max. draining speed solid (→ 126)	Step response time / s
Very slow < 0.5m (1.6ft) /h	910
Slow < 1m (3.3ft) /h	730
Standard < 2m (6,5ft) /h	340
Medium < 4m (13ft) /h	170
Fast < 8m (26ft) /h	75
Very fast > 8m (26ft) /h	10
No filter / test	< 1

Empty calibration



Navigation

Setup → Empty calibration

Description

Distance between process connection and minimum level (0%).

User entry

Depending on the antenna

Factory setting

Depending on the antenna

Additional information

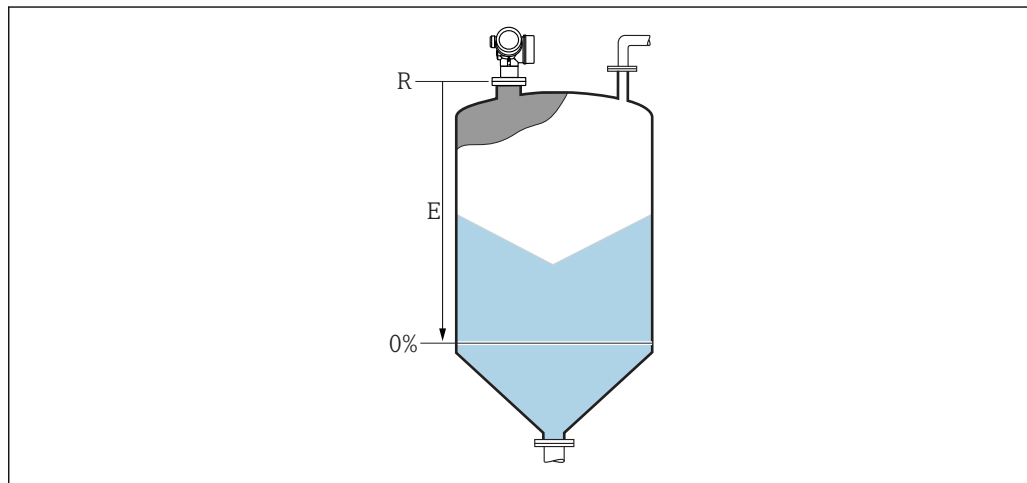

A0019488

47 Empty calibration (E) for level measurements in bulk solids.



The measuring range starts at the point at which the radar beam hits the tank or silo bottom. In the case of dished boiler ends or conical outlets levels below this point can not be measured.

Full calibration



Navigation

Setup → Full calibration

Description

Distance between minimum level (0%) and maximum level (100%).

User entry

Depending on the antenna

Factory setting

Depending on the antenna

Additional information

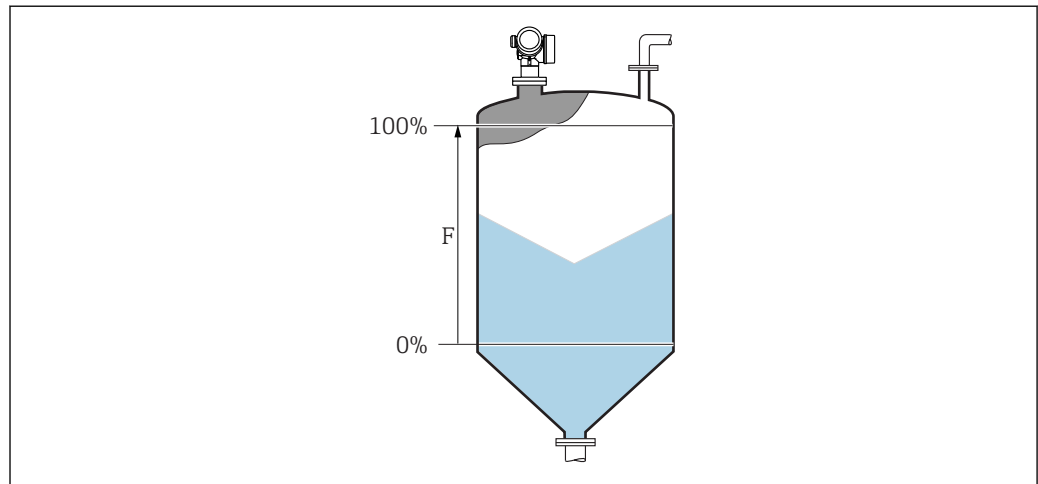

A0019489

48 Full calibration (F) for level measurements in bulk solids

Level

Navigation

Setup → Level

Description

Displays measured level L (before linearization).

Additional information

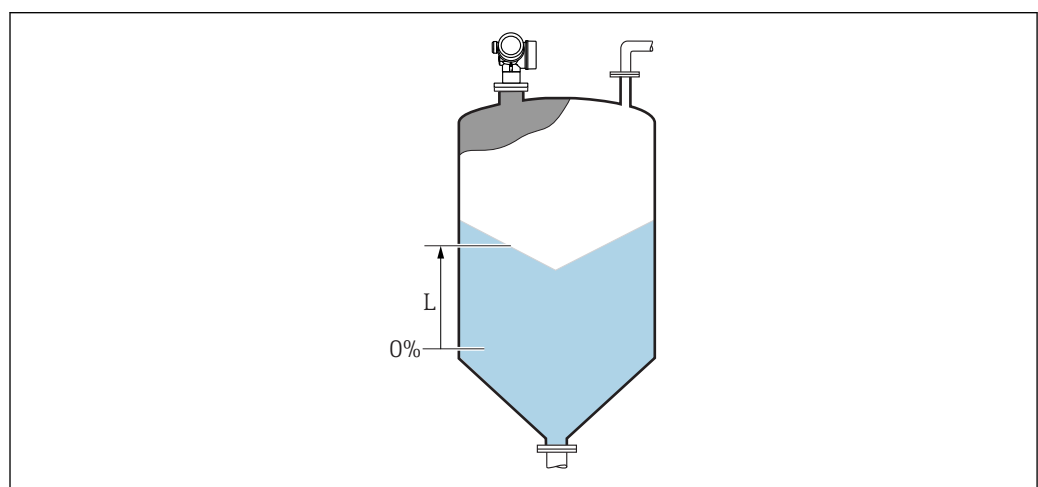

A0019484

49 Level in case of bulk solid measurements

The unit is defined in the **Level unit** parameter (→ 138).

Distance

Navigation
 Setup → Distance
Description

Displays the measured distance D between the reference point (lower edge of the flange or threaded connection) and the level.

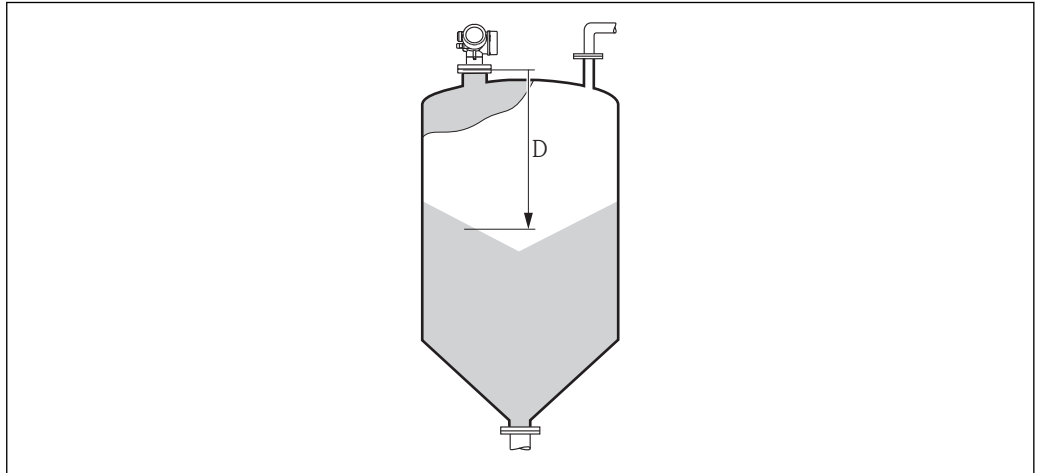
Additional information

 50 Distance for bulk solid measurements

A0019485

 The unit is defined in the **Distance unit** parameter (→  125).

Signal quality

Navigation
 Setup → Signal quality
Description



Displays the signal quality of the level echo.

Additional information**Meaning of the display options**

- **Strong**
The evaluated echo exceeds the threshold by at least 10 dB.
- **Medium**
The evaluated echo exceeds the threshold by at least 5 dB.
- **Weak**
The evaluated echo exceeds the threshold by less than 5 dB.
- **No signal**
The device does not find a usable echo.

The signal quality indicated in this parameter always refers to the currently evaluated echo: either the level echo or the tank bottom echo. To differentiate between these two, the quality of the tank bottom echo is always displayed in brackets.





 In case of a lost echo (**Signal quality** = **No signal**) the device generates the following error message:

- F941, for **Output echo lost** (→  151) = **Alarm**.
- S941, if another option has been selected in **Output echo lost** (→  151).

Confirm distance



Navigation	Setup → Confirm distance
Description	Specify, whether the measured distance matches the real distance. Depending on the selection the device automatically sets the range of mapping.
Selection	<ul style="list-style-type: none"> ■ Manual map ■ Distance ok ■ Distance unknown ■ Distance too small[*] ■ Distance too big[*] ■ Tank empty ■ Factory map
Factory setting	Distance unknown
Additional information	<p>Meaning of the options</p> <ul style="list-style-type: none"> ■ Manual map To be selected if the range of mapping is to be defined manually in the Mapping end point parameter (→ 131). In this case it is not necessary to confirm the distance. ■ Distance ok To be selected if the measured distance matches the actual distance. The device performs a mapping. ■ Distance unknown To be selected if the actual distance is unknown. A mapping can not be performed in this case. ■ Distance too small To be selected if the measured distance is smaller than the actual distance. The device searches for the next echo and returns to the Confirm distance parameter. The distance is recalculated and displayed. The comparison must be repeated until the displayed distance matches the actual distance. After this, the recording of the map can be started by selecting Distance ok.





* Visibility depends on order options or device settings

- **Distance too big** ⁶⁾
 To be selected if the measured distance exceeds the actual distance. The device adjusts the signal evaluation and returns to the **Confirm distance** parameter. The distance is recalculated and displayed. The comparison must be repeated until the displayed distance matches the actual distance. After this, the recording of the map can be started by selecting **Distance ok**.
- **Tank empty**
 To be selected if the tank is completely empty. The device records a mapping covering the complete measuring range as defined by the **Tank/silo height** parameter (→  140). By default, **Tank/silo height** = **Empty calibration**.
 Take into account that in case of conical outlets, for example, a measurement is only possible up to the point at which the radar hits the bottom of the tank or silo. If the **Tank empty** option is used, **Empty calibration** (→  127) and **Tank/silo height** may not reach below this point as otherwise the empty signal is suppressed.
- **Factory map**
 To be selected if the present mapping curve (if one exists) is to be deleted. The device returns to the **Confirm distance** parameter and a new mapping can be recorded.
-  When operating via the display module, the measured distance is displayed together with this parameter for reference purposes.
-  If the teaching procedure with the **Distance too small** option or the **Distance too big** option is quit before the distance has been confirmed, a map is **not** recorded and the teaching procedure is reset after 60 s.

Present mapping

Navigation	 Setup → Present mapping
Description	Indicates up to which distance a mapping has already been recorded.

Mapping end point 



Navigation	 Setup → Mapping end point
Prerequisite	Confirm distance (→  130) = Manual map or Distance too small
Description	Specify new end of the mapping.
User entry	0.1 to 999 999.9 m
Factory setting	0.1 m
Additional information	<p>This parameter defines up to which distance the new mapping is to be recorded. The distance is measured from the reference point, i.e. from the lower edge of the mounting flange or the threaded connection.</p> <p> For reference purposes the Present mapping parameter (→  131) is displayed together with this parameter. It indicates up to which distance a mapping has already been recorded.</p>

6) Only available for "Expert → Sensor → Echo tracking → **Evaluation mode** parameter" = "Short time history" or "Long time history"

Record map

Navigation	Setup → Record map
Prerequisite	Confirm distance (→ 130) = Manual map or Distance too small
Description	Start recording of the map.
Selection	<ul style="list-style-type: none"> ▪ No ▪ Record map ▪ Overlay map ▪ Factory map ▪ Delete partial map
Factory setting	No
Additional information	<p>Meaning of the options</p> <ul style="list-style-type: none"> ▪ No The map is not recorded. ▪ Record map The map is recorded. After the recording is completed, the new measured distance and the new mapping range appear on the display. When operating via the local display, these values must be confirmed by pressing . ▪ Overlay map The new mapping curve is generated by overlaying the old and the current envelope curves. ▪ Factory map The factory map stored in the ROM of the device is used. ▪ Delete partial map The mapping curve is deleted up to Mapping end point (→ 131).

17.4.1 "Mapping" wizard

 The **Mapping** wizard is only available when operating via the local display. When operating via an operating tool, all parameters concerning the mapping are located directly in the **Setup** menu (→  125).

 In the **Mapping** wizard two parameters are displayed simultaneously on the display module at any one time. The upper parameter can be edited, whereas the lower parameter is displayed for reference purposes only.

Navigation  Setup → Mapping

Confirm distance

Navigation  Setup → Mapping → Confirm distance

Description →  130

Mapping end point

Navigation  Setup → Mapping → Mapping end point

Description →  131

Record map

Navigation  Setup → Mapping → Record map

Description →  132

Distance

Navigation  Setup → Mapping → Distance

Description →  129

Prepare recording map

Navigation  Setup → Mapping → Prepare recording map

Description Indicates the progress of the recording of the map.





User interface

- Init. recording
- In progress
- Finished





17.4.2 "Advanced setup" submenu

Navigation  Setup → Advanced setup





Locking status

Navigation	  Setup → Advanced setup → Locking status
Description	Indicates the write protection with the highest priority that is currently active.
User interface	<ul style="list-style-type: none"> ■ Hardware locked ■ SIL locked ■ CT active - defined parameters ■ WHG locked ■ Temporarily locked
Additional information	<p>Meaning and priorities of the types of write protection</p> <ul style="list-style-type: none"> ■ Hardware locked (priority 1) The DIP switch for hardware locking is activated on the main electronics module. This locks write access to the parameters. ■ SIL locked (priority 2) The SIL mode is activated. Writing access to the relevant parameters is denied. ■ WHG locked (priority 3) The WHG mode is activated. Writing access to the relevant parameters is denied. ■ Temporarily locked (priority 4) Write access to the parameters is temporarily locked on account of internal processes in progress in the device (e.g. data upload/download, reset etc.). The parameters can be modified as soon as the processes are complete. <p> On the display module, the -symbol appears in front of parameters that cannot be modified since they are write-protected.</p>





Access status tooling

Navigation	 Setup → Advanced setup → Access status tooling
Description	Shows the access authorization to the parameters via the operating tool.
Additional information	<p> The access authorization can be changed via the Enter access code parameter (→  136).</p> <p> If additional write protection is active, this restricts the current access authorization even further. The write protection status can be viewed via the Locking status parameter (→  135).</p>

Access status display



Navigation	 Setup → Advanced setup → Access status display
Prerequisite	The device has a local display.
Description	Indicates access authorization to parameters via local display.
Additional information	<p> The access authorization can be changed via the Enter access code parameter (→  136).</p> <p> If additional write protection is active, this restricts the current access authorization even further. The write protection status can be viewed via the Locking status parameter (→  135).</p>



Enter access code

Navigation	 Setup → Advanced setup → Enter access code
Description	Enter access code to disable write protection of parameters.
User entry	0 to 9999
Additional information	<ul style="list-style-type: none"> ▪ For local operation, the customer-specific access code, which has been defined in the Define access code parameter (→  175), has to be entered. ▪ If an incorrect access code is entered, the user retains his current access authorization. ▪ The write protection affects all parameters marked with the -symbol in this document. On the local display, the -symbol in front of a parameter indicates that the parameter is write-protected. ▪ If no key is pressed for 10 min, or the user switches from the navigation and editing mode back to the measured value display mode, the device automatically locks the write-protected parameters after another 60 s. <p> Please contact your Endress+Hauser Sales Center if you lose your access code.</p>

"Level" submenu

Navigation  Setup → Advanced setup → Level

Medium type	
Navigation	 Setup → Advanced setup → Level → Medium type
Description	Specify type of medium.
User interface	<ul style="list-style-type: none"> ■ Liquid ■ Solid
Factory setting	FMR56, FMR57: Solid
Additional information	 This parameter determines the value of several other parameters and strongly influences the complete signal evaluation. Therefore, it is strongly recommended not to change the factory setting.

Medium property	
Navigation	 Setup → Advanced setup → Level → Medium property
Description	Specify relative dielectric constant ϵ_r of the medium.
Selection	<ul style="list-style-type: none"> ■ Unknown ■ DC 1.4 ... 1.6 ■ DC 1.6 ... 1.9 ■ DC 1.9 ... 2.5 ■ DC 2.5 ... 4 ■ DC 4 ... 7 ■ DC 7 ... 15 ■ DC > 15
Factory setting	Dependent on Medium type (→  137) and Medium group .
Additional information	<i>Dependency on "Medium type" and "Medium group"</i>

Medium type (→  137)	Medium group	Medium property
Solid		Unknown
Liquid	Water based (DC >= 4)	DC 4 ... 7
	Others	Unknown

 For dielectric constants (DC values) of many media commonly used in various industries refer to:

- the Endress+Hauser DC manual (CP01076F)
- the Endress+Hauser "DC Values App" (available for Android and iOS)

Advanced process conditions

Navigation	Setup → Advanced setup → Level → Advanced process conditions
Description	Specify additional process conditions (if required).
Selection	<ul style="list-style-type: none"> ▪ Many obstacles ▪ Weak signal
Factory setting	None
Additional information	<p><i>"Many obstacles" option</i></p> <p>This option optimizes the signal evaluation for bulk solid applications with a large measuring range where obstacles generate many interference echos. With this selection the last echo in the envelope curve will always be evaluated. For strongly damping media this is always the level echo.</p> <p> The Many obstacles option is only available for bulk solid applications (FMR56, FMR57).</p> <p> Preconditions for the application of the "Many obstacles" option</p> <ul style="list-style-type: none"> ▪ Medium type (→ 137) = Solid <ul style="list-style-type: none"> ▪ Strongly damping medium (e.g. flour, wheat, cereals, ...) ▪ No multiple echos if the tank is full ▪ Interference echo suppression only in the near field (ringing area) ▪ Expert → Sensor → Echo tracking → Evaluation mode = Short time history <p><i>"Weak signal" option</i></p> <p>This option improves the detectability of small level echos in bulk solid applications with very weak signal amplitudes.</p> <p> The Weak signal option is only available for bulk solid measurements (FMR56, FMR57).</p>

Level unit

Navigation	Setup → Advanced setup → Level → Level unit								
Description	Select level unit.								
Selection	<table style="width: 100%; border: none;"> <thead> <tr> <th style="text-align: left;"><i>SI units</i></th> <th style="text-align: left;"><i>US units</i></th> </tr> </thead> <tbody> <tr> <td>▪ %</td> <td>▪ ft</td> </tr> <tr> <td>▪ m</td> <td>▪ in</td> </tr> <tr> <td>▪ mm</td> <td></td> </tr> </tbody> </table>	<i>SI units</i>	<i>US units</i>	▪ %	▪ ft	▪ m	▪ in	▪ mm	
<i>SI units</i>	<i>US units</i>								
▪ %	▪ ft								
▪ m	▪ in								
▪ mm									
Factory setting	%								
Additional information	<p>The level unit may differ from the distance unit defined in the Distance unit parameter (→ 125):</p> <ul style="list-style-type: none"> ▪ The unit defined in the Distance unit parameter is used for the basic calibration (Empty calibration (→ 127) and Full calibration (→ 128)). ▪ The unit defined in the Level unit parameter is used to display the (nonlinearized) level. 								

Blocking distance



Navigation	☰☰ Setup → Advanced setup → Level → Blocking distance
Description	Specify blocking distance BD.
User entry	0 to 200 m
Factory setting	FMR56, FMR57: antenna length + 400 mm (15.7 in)
Additional information	<p>Signals in the blocking distance are only evaluated if they have been outside the blocking distance when the device was switched on and move into the blocking distance due to a level change during operation. Signals which are already in the blocking distance when the device is switched on, are ignored.</p> <p>i This behavior is only valid if the following two conditions are met:</p> <ul style="list-style-type: none"> ▪ Expert → Sensor → Echo tracking → Evaluation mode = Short time history or Long time history ▪ Expert → Sensor → Gas phase compensation → GPC mode= On, Without correction or External correction <p>If one of these conditions is not met, signals in the blocking distance will always be ignored.</p> <p>i If required, a different behavior for signals in the blocking distance can be defined by the Endress+Hauser service.</p>

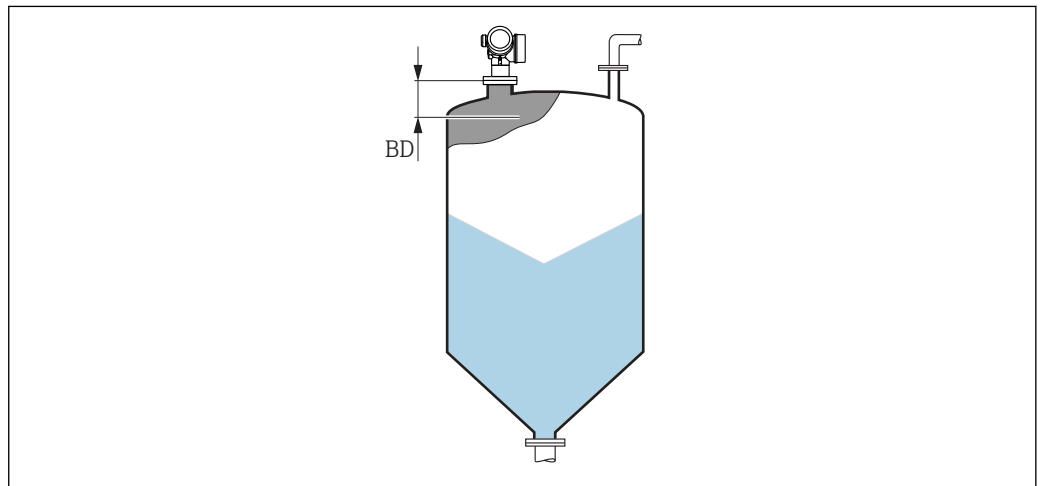

A0023041

☰ 51 Blocking distance (BD) for bulk solid measurements

Level correction



Navigation	☰☰ Setup → Advanced setup → Level → Level correction
Description	Specify level correction (if required).
User entry	-200 000.0 to 200 000.0 %
Factory setting	0.0 %

Additional information The value specified in this parameter is added to the measured level (before linearization).

Tank/silo height



Navigation Setup → Advanced setup → Level → Tank/silo height

Description Specify total height of the tank or silo as measured from the process connection.

User entry -999.9999 to 999.9999 m

Factory setting **Empty calibration** (→ 127)

Additional information If the parametrized measuring range (**Empty calibration** (→ 127)) differs significantly from the tank or silo height, it is recommended to enter the tank or silo height. Example: Continuous level monitoring in the upper third of a tank or silo.

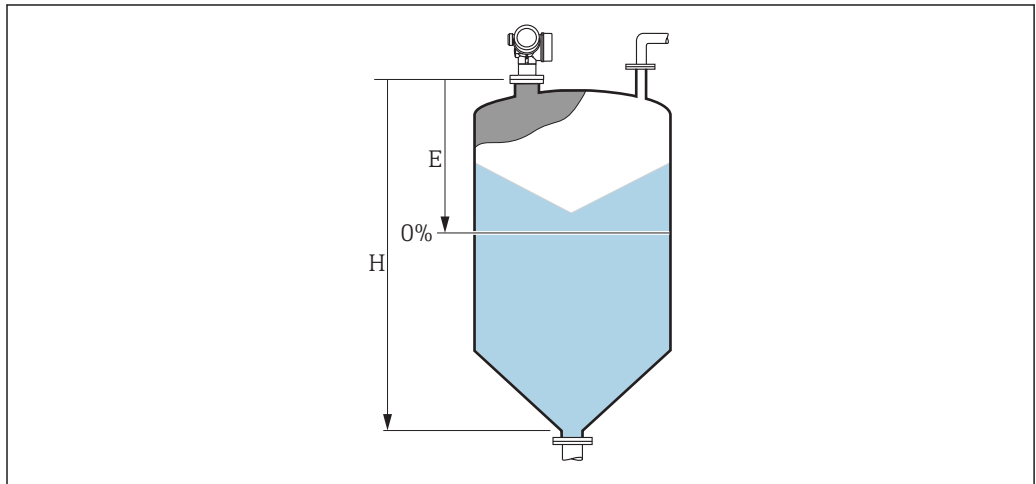

A0019868

52 "Tank/silo height" parameter (→ 140) for measurements in bulk solids

E Empty calibration (→ 127)

H Tank/silo height (→ 140)

For tanks with conical outlet, **Tank/silo height** should not be changed as in this type of applications **Empty calibration** (→ 127) is usually **not** << the tank or silo height.

"Linearization" submenu

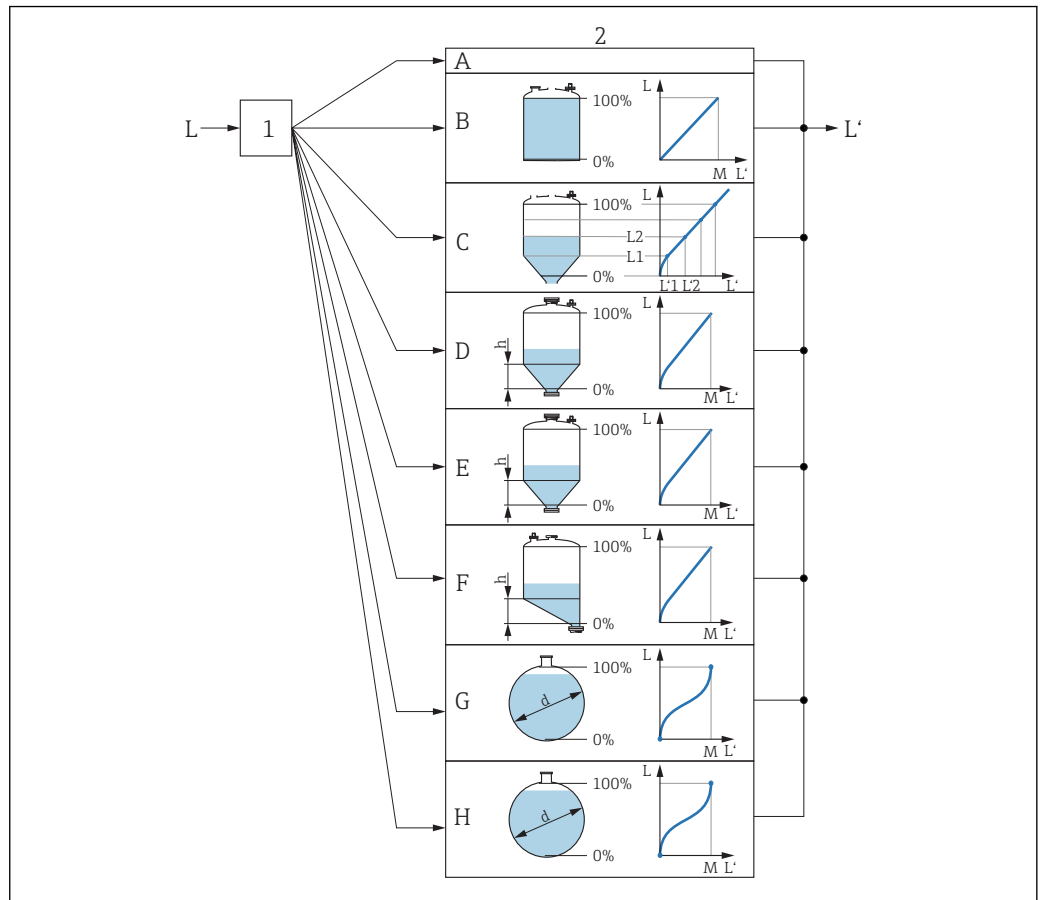











A0019648

53 Linearization: Transformation of the level and (if relevant) the interface height into a volume or weight; the transformation is dependent on the shape of the vessel.

- 1 Selection of linearization type and unit
- 2 Configuration of the linearization
- A Linearization type (→ 144) = None
- B Linearization type (→ 144) = Linear
- C Linearization type (→ 144) = Table
- D Linearization type (→ 144) = Pyramid bottom
- E Linearization type (→ 144) = Conical bottom
- F Linearization type (→ 144) = Angled bottom
- G Linearization type (→ 144) = Horizontal cylinder
- H Linearization type (→ 144) = Sphere
- L Level before linearization (measured in distance units)
- L' Level linearized (→ 146) (corresponds to volume or weight)
- M Maximum value (→ 147)
- d Diameter (→ 147)
- h Intermediate height (→ 147)













Structure of the submenu on the display module

Navigation  Setup → Advanced setup → Linearization

► Linearization	
Linearization type	→  144
Unit after linearization	→  145
Free text	→  146
Maximum value	→  147
Diameter	→  147
Intermediate height	→  147
Table mode	→  148
► Edit table	
Level	→  149
Customer value	→  150
Activate table	→  150

Structure of the submenu in an operating tool (e.g. FieldCare)

Navigation  Setup → Advanced setup → Linearization

► Linearization	
Linearization type	→  144
Unit after linearization	→  145
Free text	→  146
Level linearized	→  146
Maximum value	→  147
Diameter	→  147
Intermediate height	→  147
Table mode	→  148
Table number	→  149
Level	→  149
Level	→  150
Customer value	→  150
Activate table	→  150

Description of parameters

Navigation  Setup → Advanced setup → Linearization

Linearization type 

Navigation  Setup → Advanced setup → Linearization → Linearization type

Description Select linearization type.

- Selection**
- None
 - Linear
 - Table
 - Pyramid bottom
 - Conical bottom
 - Angled bottom
 - Horizontal cylinder
 - Sphere

Factory setting None

Additional information

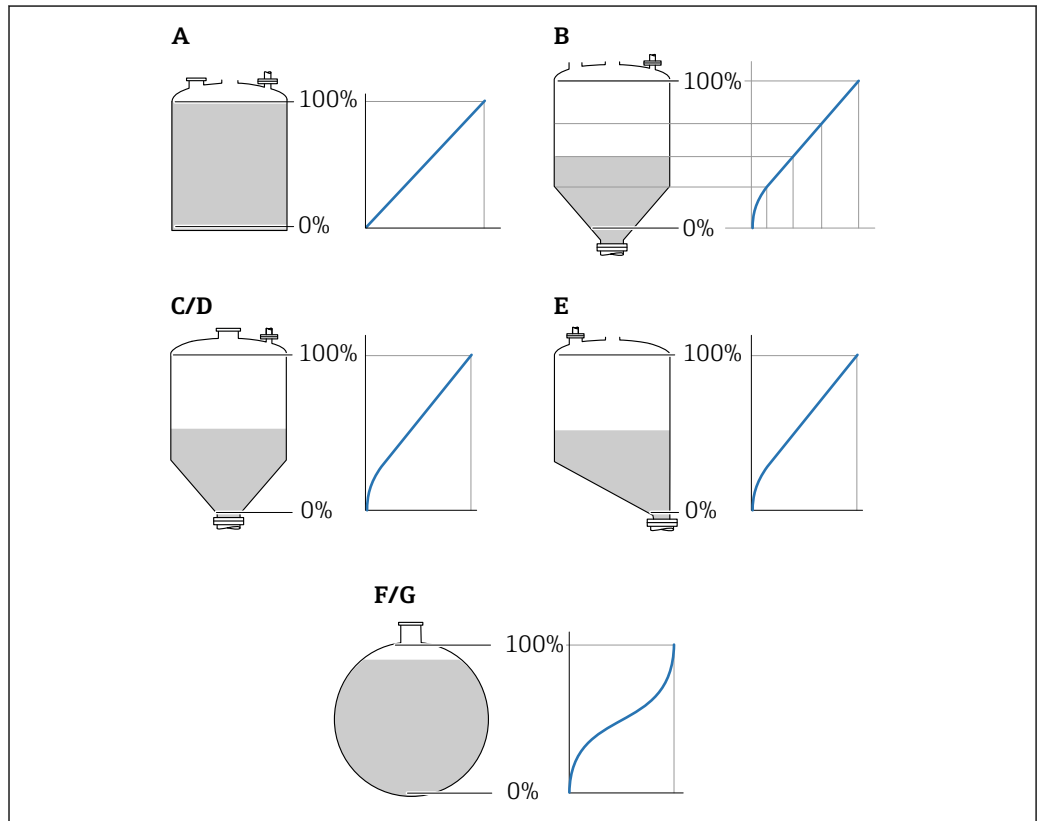

A0021476

 54 *Linearization types*



- A None
- B Table
- C Pyramid bottom
- D Conical bottom
- E Angled bottom
- F Sphere
- G Horizontal cylinder

Meaning of the options■ **None**

The level is transmitted in the level unit without linearization.





■ **Linear**

The output value (volume/weight) is directly proportional to the level L. This is valid, for example, for vertical cylinders. The following additional parameters have to be specified:

- **Unit after linearization** (→  145)
- **Maximum value** (→  147): Maximum volume or weight



■ **Table**

The relationship between the measured level L and the output value (volume/weight) is given by a linearization table consisting of up to 32 pairs of values "level - volume" or "level - weight", respectively. The following additional parameters have to be specified:

- **Unit after linearization** (→  145)
- **Table mode** (→  148)
- For each table point: **Level** (→  149)
- For each table point: **Customer value** (→  150)
- **Activate table** (→  150)



■ **Pyramid bottom**

The output value corresponds to the volume or weight in a silo with pyramid bottom. The following additional parameters have to be specified:

- **Unit after linearization** (→  145)
- **Maximum value** (→  147): Maximum volume or weight
- **Intermediate height** (→  147): The height of the pyramid



■ **Conical bottom**

The output value corresponds to the volume or weight in a tank with conical bottom. The following additional parameters have to be specified:

- **Unit after linearization** (→  145)
- **Maximum value** (→  147): Maximum volume or weight
- **Intermediate height** (→  147): The height of the conical part of the tank



■ **Angled bottom**

The output value corresponds to the volume or weight in a silo with an angled bottom. The following additional parameters have to be specified:

- **Unit after linearization** (→  145)
- **Maximum value** (→  147): Maximum volume or weight
- **Intermediate height** (→  147): Height of the angled bottom



■ **Horizontal cylinder**

The output value corresponds to the volume or weight in a horizontal cylinder. The following additional parameters have to be specified:

- **Unit after linearization** (→  145)
- **Maximum value** (→  147): Maximum volume or weight
- **Diameter** (→  147)

■ **Sphere**

The output value corresponds to the volume or weight in a spherical tank. The following additional parameters have to be specified:

- **Unit after linearization** (→  145)
- **Maximum value** (→  147): Maximum volume or weight
- **Diameter** (→  147)

Unit after linearization**Navigation**

  Setup → Advanced setup → Linearization → Unit after linearization

Prerequisite

Linearization type (→  144) ≠ None

Description

Select unit of the linearized value.



Selection	<i>SI units</i>	<i>US units</i>	<i>Imperial units</i>
	<ul style="list-style-type: none"> ■ STon ■ t ■ kg ■ cm³ ■ dm³ ■ m³ ■ hl ■ l ■ % ■ mm ■ m 	<ul style="list-style-type: none"> ■ lb ■ UsGal ■ ft³ ■ ft ■ in 	<ul style="list-style-type: none"> impGal

Custom-specific units



Free text

Factory setting %

Additional information The selected unit is only used to be indicated on the display. The measured value is **not** transformed according to the selected unit.

 It is also possible to configure a distance-to-distance linearization, i.e. a transformation from the level unit to a different distance unit. To do so, select the **Linear** linearization mode. In order to define the new level unit, select the **Free text** option in the **Unit after linearization** parameter and enter the required unit into the **Free text** parameter (→  146).

Free text 

Navigation   Setup → Advanced setup → Linearization → Free text

Prerequisite **Unit after linearization** (→  145) = **Free text**

Description Enter unit symbol.

User entry Up to 32 alphanumerical characters (letters, numbers, special characters)

Factory setting Free text

Level linearized



Navigation  Setup → Advanced setup → Linearization → Level linearized

Description Displays linearized level.

Additional information  The unit is defined by the **Unit after linearization** parameter →  145.





Maximum value



Navigation	  Setup → Advanced setup → Linearization → Maximum value
Prerequisite	Linearization type (→  144) has one of the following values: <ul style="list-style-type: none"> ■ Linear ■ Pyramid bottom ■ Conical bottom ■ Angled bottom ■ Horizontal cylinder ■ Sphere
Description	Linearized value corresponding to a level of 100%.
User entry	-50 000.0 to 50 000.0 %
Factory setting	100.0 %



Diameter



Navigation	  Setup → Advanced setup → Linearization → Diameter
Prerequisite	Linearization type (→  144) has one of the following values: <ul style="list-style-type: none"> ■ Horizontal cylinder ■ Sphere
Description	Diameter of the cylindrical or spherical tank.
User entry	0 to 9 999.999 m
Factory setting	2 m
Additional information	The unit is defined in the Distance unit parameter (→  125).

Intermediate height



Navigation	  Setup → Advanced setup → Linearization → Intermediate height
Prerequisite	Linearization type (→  144) has one of the following values: <ul style="list-style-type: none"> ■ Pyramid bottom ■ Conical bottom ■ Angled bottom
Description	Height of the pyramid, conical or angled bottom.
User entry	0 to 200 m
Factory setting	0 m

Additional information

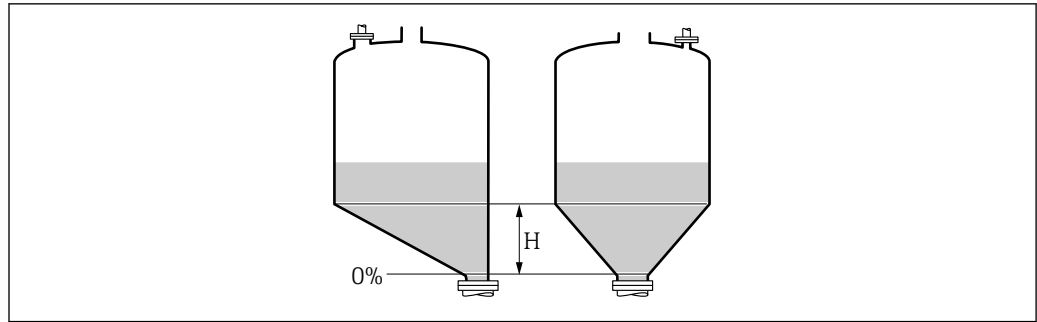

A0013264

H Intermediate height

The unit is defined in the **Distance unit** parameter (→ [125](#)).

Table mode



Navigation

Setup → Advanced setup → Linearization → Table mode

Prerequisite

Linearization type (→ [144](#)) = **Table**

Description

Select editing mode of the linearization table.

Selection

- Manual
- Semiautomatic
- Clear table
- Sort table

Factory setting

Manual

Additional information

Meaning of the options

- **Manual**
The level and the associated linearized value are entered manually for each linearization point.
- **Semiautomatic**
The level is measured by the device for each linearization point. The associated linearized value is entered manually.
- **Clear table**
Deletes the existing linearization table.
- **Sort table**
Rearranges the linearization points into an ascending order.



Conditions the linearization table must meet:



- The table may consist of up to 32 pairs of values "Level - Linearized Value".
- The table must be monotonic (monotonically increasing or decreasing).
- The first linearization point must refer to the minimum level.
- The last linearization point must refer to the maximum level.

Before entering a linearization table, the values for **Empty calibration** (→ [127](#)) and **Full calibration** (→ [128](#)) must be set correctly.

If values of the table need to be changed after the full or empty calibration have been changed, a correct evaluation is only ensured if the existing table is deleted and the complete table is entered again. To do so delete the existing table (**Table mode** (→ [148](#)) = **Clear table**). Then enter a new table.

How to enter the table

- Via FieldCare
The table points can be entered via the **Table number** (→  149), **Level** (→  149) and **Customer value** (→  150) parameters. As an alternative, the graphic table editor may be used: Device Operation → Device Functions → Additional Functions → Linearization (Online/Offline)
- Via local display
Select the **Edit table** submenu to call up the graphic table editor. The table is displayed and can be edited line by line.

 The factory setting for the level unit is "%". If you want to enter the linearization table in physical units, you must select the appropriate unit in the **Level unit** parameter (→  138) beforehand.











 If a decreasing table is entered, the values for 20 mA and 4 mA of the current output are interchanged. That means: 20 mA refers to the lowest level, whereas 4 mA refers to the highest level.

Table number	
<hr/>	
Navigation	 Setup → Advanced setup → Linearization → Table number
Prerequisite	Linearization type (→  144) = Table
Description	Select table point you are going to enter or change.
User entry	1 to 32
Factory setting	1



Level (Manual)	
<hr/>	
Navigation	 Setup → Advanced setup → Linearization → Level
Prerequisite	<ul style="list-style-type: none"> ▪ Linearization type (→  144) = Table ▪ Table mode (→  148) = Manual
Description	Enter level value of the table point (value before linearization).
User entry	Signed floating-point number
Factory setting	0 %

Level (Semiautomatic)

Navigation	 Setup → Advanced setup → Linearization → Level
Prerequisite	<ul style="list-style-type: none"> ▪ Linearization type (→  144) = Table ▪ Table mode (→  148) = Semiautomatic
Description	Displays measured level (value before linearization). This value is transmitted to the table.





Customer value



Navigation	 Setup → Advanced setup → Linearization → Customer value
Prerequisite	Linearization type (→  144) = Table
Description	Enter linearized value for the table point.
User entry	Signed floating-point number
Factory setting	0 %

Activate table



Navigation	  Setup → Advanced setup → Linearization → Activate table
Prerequisite	Linearization type (→  144) = Table
Description	Activate (enable) or deactivate (disable) the linearization table.
Selection	<ul style="list-style-type: none"> ▪ Disable ▪ Enable
Factory setting	Disable
Additional information	<p>Meaning of the options</p> <ul style="list-style-type: none"> ▪ Disable The measured level is not linearized. If Linearization type (→  144) = Table at the same time, the device issues error message F435. ▪ Enable The measured level is linearized according to the table. <p> When editing the table, the Activate table parameter is automatically reset to Disable and must be reset to Enable after the table has been entered.</p>

"Safety settings" submenu

Navigation  Setup → Advanced setup → Safety settings

Output echo lost 



Navigation  Setup → Advanced setup → Safety settings → Output echo lost

Description Output signal in case of a lost echo.

- Selection**
- Last valid value
 - Ramp at echo lost
 - Value echo lost
 - Alarm

Factory setting Last valid value

Additional information **Meaning of the options**

- **Last valid value**
The last valid value is kept in the case of a lost echo.
- **Ramp at echo lost**⁷⁾
In the case of a lost echo the output value is continuously shifted towards 0% or 100%. The slope of the ramp is defined in the **Ramp at echo lost** parameter (→  152).
- **Value echo lost**⁷⁾
In the case of a lost echo the output assumes the value defined in the **Value echo lost** parameter (→  151).
- **Alarm**
In the case of a lost echo the device generates an alarm; see the **Failure mode** parameter (→  158)

Value echo lost 

Navigation  Setup → Advanced setup → Safety settings → Value echo lost



Prerequisite **Output echo lost** (→  151) = **Value echo lost**

Description Output value in case of a lost echo

User entry 0 to 200 000.0 %

Factory setting 0.0 %

Additional information Use the unit which has been defined for the measured value output:

- without linearization: **Level unit** (→  138)
- with linearization: **Unit after linearization** (→  145)

7) Only visible if "Linearization type (→  144)" = "None"

Ramp at echo lost



Navigation Setup → Advanced setup → Safety settings → Ramp at echo lost

Prerequisite **Output echo lost (→ 151) = Ramp at echo lost**

Description Slope of the ramp in the case of a lost echo

User entry Signed floating-point number

Factory setting 0.0 %/min

Additional information

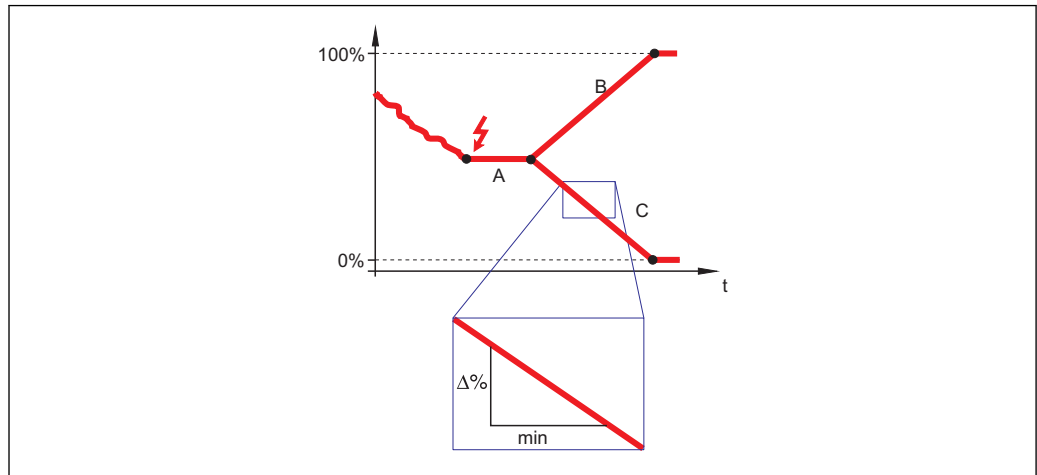

A0013269

- A Delay time echo lost
- B Ramp at echo lost (→ 152) (positive value)
- C Ramp at echo lost (→ 152) (negative value)

- The unit for the slope of the ramp is "percentage of the measuring range per minute" (%/min).
- For a negative slope of the ramp: The measured value is continuously decreased until it reaches 0%.
- For a positive slope of the ramp: The measured value is continuously increased until it reaches 100%.

Blocking distance



Navigation Setup → Advanced setup → Safety settings → Blocking distance

Description Specify blocking distance BD.

User entry 0 to 200 m

Factory setting FMR56, FMR57: antenna length + 400 mm (15.7 in)

Additional information Signals in the blocking distance are only evaluated if they have been outside the blocking distance when the device was switched on and move into the blocking distance due to a

level change during operation. Signals which are already in the blocking distance when the device is switched on, are ignored.

- i** This behavior is only valid if the following two conditions are met:
- Expert → Sensor → Echo tracking → Evaluation mode = **Short time history** or **Long time history**
 - Expert → Sensor → Gas phase compensation → GPC mode= **On, Without correction** or **External correction**

If one of these conditions is not met, signals in the blocking distance will always be ignored.

- i** If required, a different behavior for signals in the blocking distance can be defined by the Endress+Hauser service.

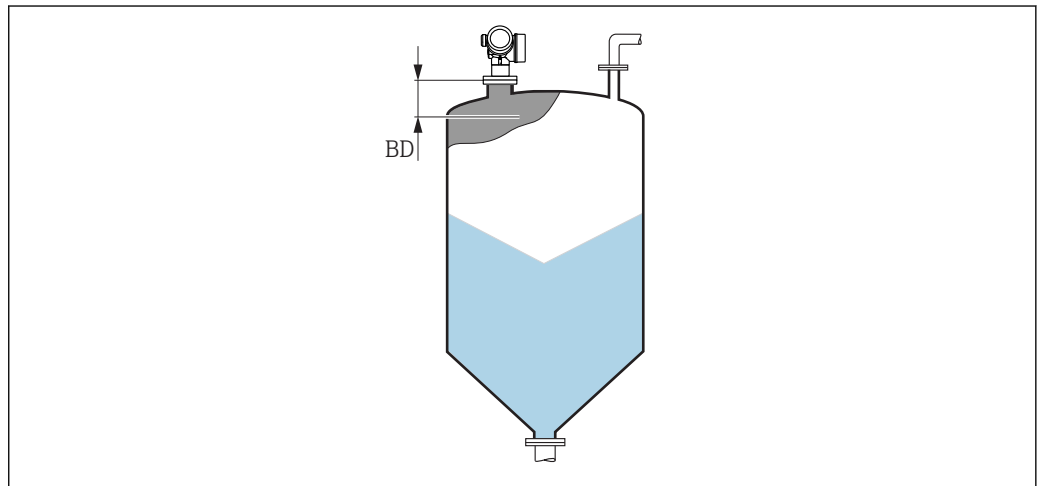

i 55 Blocking distance (BD) for bulk solid measurements

A0023041



"SIL/WHG confirmation" wizard

 The **SIL/WHG confirmation** wizard is only available for devices with SIL or WHG approval (Feature 590: "Additional Approval", option LA: "SIL" or LC: "WHG overflow prevention") which are currently **not** in the SIL- or WHG-locked state.

The **SIL/WHG confirmation** wizard is required to lock the device according to SIL or WHG. For details refer to the "Functional Safety Manual" of the respective device, which describes the locking procedure and the parameters of the sequence.

Navigation  Setup → Advanced setup → SIL/WHG confirmation

"Deactivate SIL/WHG" wizard

 The **Deactivate SIL/WHG** wizard (→  155) is only visible if the device is SIL-locked or WHG-locked. For details refer to the "Functional Safety Manual" of the respective device.

Navigation  Setup → Advanced setup → Deactivate SIL/WHG



Reset write protection

Navigation	 Setup → Advanced setup → Deactivate SIL/WHG → Reset write protection
Description	Enter unlocking code.
User entry	0 to 65 535
Factory setting	0

Code incorrect

Navigation	 Setup → Advanced setup → Deactivate SIL/WHG → Code incorrect
Description	Indicates that a wrong unlocking code has been entered. Select procedure.
Selection	<ul style="list-style-type: none"> ■ Reenter code ■ Abort sequence
Factory setting	Reenter code

"Current output 1 to 2" submenu

 The **Current output 2** submenu (→  156) is only available for devices with two current outputs.

Navigation  Setup → Advanced setup → Current output 1 to 2

Assign current output 1 to 2 

Navigation  Setup → Advanced setup → Current output 1 to 2 → Assign current output



Description Select process variable for current output.

- Selection**
- Level linearized
 - Distance
 - Electronic temperature
 - Relative echo amplitude
 - Analog output adv. diagnostics 1
 - Analog output adv. diagnostics 2
 - Area of incoupling

- Factory setting**
- Current output 1: Level linearized
 - Current output 2 ⁸⁾: Level linearized

Additional information *Definition of the current range for the process variables*

Process variable	4 mA value	20 mA value
Level linearized	0 % ¹⁾ or the associated linearized value	100 % ²⁾ or the associated linearized value
Distance	0 (i.e. level is at the reference point)	Empty calibration (→  127) (i.e. level is at 0 %)
Electronic temperature	-50 °C (-58 °F)	100 °C (212 °F)
Relative echo amplitude	0 dB	150 dB
Analog output adv. diagnostics 1/2	depending on the parametrization of the Advanced Diagnostics	
Area of incoupling	0	100

- 1) the 0% level is defined by **Empty calibration** parameter (→  127)
 2) The 100% level is defined by **Full calibration** parameter (→  128)

 It may be necessary to adjust the 4mA and 20mA values to the application (especially in the case of the **Analog output adv. diagnostics 1/2** and **Area of incoupling** options).

This can be done by the following parameters:

- Expert → Output → Current output 1 to 2 → Turn down
- Expert → Output → Current output 1 to 2 → 4 mA value
- Expert → Output → Current output 1 to 2 → 20 mA value

8) only for devices with two current outputs

Current span



Navigation

Setup → Advanced setup → Current output 1 to 2 → Current span

Description

Determines the current range used to transmit the measured value. '4...20mA': Measured variable: 4 ...20 mA '4...20mA NAMUR': Measured variable: 3.8 ... 20.5 mA '4...20mA US': Measured variable: 3.9 ... 20.8 mA 'Fixed current': Measured variable transmitted via HART only Note: Currents below 3.6 mA or above 21.95 mA can be used to signal an alarm.

Selection

- 4...20 mA
- 4...20 mA NAMUR
- 4...20 mA US
- Fixed current

Factory setting

4...20 mA NAMUR

Additional information

Meaning of the options

Option	Current range for process variable	Lower alarm signal level	Upper alarm signal level
4...20 mA	4 to 20.5 mA	< 3.6 mA	> 21.95 mA
4...20 mA NAMUR	3.8 to 20.5 mA	< 3.6 mA	> 21.95 mA
4...20 mA US	3.9 to 20.8 mA	< 3.6 mA	> 21.95 mA
Fixed current	Constant current, defined in the Fixed current parameter (→ 157).		

- In the case of an error, the output current assumes the value defined in the **Failure mode** parameter (→ 158).
- If the measured value is out of the measuring range, diagnostic message **Current output** is issued.
- In a HART multidrop loop only one device can use the analog current to transmit a signal. For all other devices one must set:
 - **Current span = Fixed current**
 - **Fixed current (→ 157) = 4 mA**

Fixed current



Navigation

Setup → Advanced setup → Current output 1 to 2 → Fixed current

Prerequisite

Current span (→ 157) = Fixed current

Description

Define constant value of the output current.

User entry

4 to 22.5 mA

Factory setting

4 mA

Damping output

Navigation	Setup → Advanced setup → Current output 1 to 2 → Damping output
Description	Reaction time of the output signal on fluctuation in the measured value.
User entry	0.0 to 999.9 s
Factory setting	0.0 s
Additional information	Fluctuations of the measured value affect the output current with an exponential delay, the time constant τ of which is defined in this parameter. With a small time constant the output reacts immediately to changes of the measured value. With a big time constant the reaction of the output is more delayed. For $\tau = 0$ (factory setting) there is no damping.

Failure mode

Navigation	Setup → Advanced setup → Current output 1 to 2 → Failure mode
Prerequisite	Current span (→ 157) ≠ Fixed current
Description	Defines which current the output assumes in the case of an error. 'Min.': < 3.6mA 'Max.': > 21.95mA 'Last valid value': Last valid value before occurrence of the error. 'Actual value': Output current is equal to the measured value; error is ignored. 'Defined value': User defined value.
Selection	<ul style="list-style-type: none"> ▪ Min. ▪ Max. ▪ Last valid value ▪ Actual value ▪ Defined value
Factory setting	Max.
Additional information	<p>Meaning of the options</p> <ul style="list-style-type: none"> ▪ Min. The current output adopts the value of the lower alarm level according to the Current span parameter (→ 157). ▪ Max. The current output adopts the value of the upper alarm level according to the Current span parameter (→ 157). ▪ Last valid value The current remains constant at the last value it had before the error occurred. ▪ Actual value The output current follows the actual measured value; the error is ignored. ▪ Defined value The output current assumes the value defined in the Failure current parameter (→ 159). <p> The error behavior of other output channels is not influenced by these settings but is defined in separate parameters.</p>

Failure current





Navigation	Setup → Advanced setup → Current output 1 to 2 → Failure current
Prerequisite	Failure mode (→ 158) = Defined value
Description	Defines which current the output assumes in case of an error.
User entry	3.59 to 22.5 mA
Factory setting	22.5 mA

Output current 1 to 2

Navigation	Setup → Advanced setup → Current output 1 to 2 → Output current 1 to 2
Description	Shows the actual calculated value of the output current.

"Switch output" submenu

 The **Switch output** submenu (→  160) is only visible for devices with switch output.⁹⁾

Navigation  Setup → Advanced setup → Switch output

Switch output function**Navigation**

 Setup → Advanced setup → Switch output → Switch output function

Description

Defines the function of the switch output. 'Off' The switch output is always open (non-conductive) 'On' The switch output is always closed (conductive). 'Diagnostic behavior' The switch output is normally closed and is only opened if a diagnostic event is present. 'Limit' The switch output is normally closed and is only opened if a measured variable exceeds a defined limit. 'Digital output' The switch output is controlled by one of the digital output blocks of the device.





Selection

- Off
- On
- Diagnostic behavior
- Limit
- Digital Output

Factory setting

Off

Additional information**Meaning of the options**

- **Off**
The output is always open (non-conductive).
- **On**
The output is always closed (conductive).
- **Diagnostic behavior**
The output is normally closed and is only opened if a diagnostic event is present. The **Assign diagnostic behavior** parameter (→  161) determines for which type of event the output is opened.
- **Limit**
The output is normally closed and is only opened if a measured variable exceeds or falls below a defined limit. The limit values are defined by the following parameters:
 - **Assign limit** (→  161)
 - **Switch-on value** (→  162)
 - **Switch-off value** (→  163)
- **Digital Output**
The switching state of the output tracks the output value of a DI function block. The function block is selected in the **Assign status** parameter (→  161).

 The **Off** and **On** options can be used to simulate the switch output.

9) Ordering feature 020 "Power supply; Output", option B, E or G

Assign status
**Navigation**

Setup → Advanced setup → Switch output → Assign status

Prerequisite**Switch output function (→ 160) = Digital Output****Selection**

- Off
- Digital output AD 1
- Digital output AD 2

Factory setting

Off

Additional information

The **Digital output AD 1** and **Digital output AD 2** options refer to the Advanced Diagnostic Blocks. A switch signal generated in these blocks can be transmitted via the switch output.

Assign limit
**Navigation**

Setup → Advanced setup → Switch output → Assign limit

Prerequisite**Switch output function (→ 160) = Limit****Selection**

- Off
- Level linearized
- Distance
- Terminal voltage
- Electronic temperature
- Relative echo amplitude
- Area of incoupling

Factory setting

Off

Assign diagnostic behavior
**Navigation**

Setup → Advanced setup → Switch output → Assign diagnostic behavior

Prerequisite**Switch output function (→ 160) = Diagnostic behavior****Description**

Defines to which behavior of diagnostic events the switch output reacts.

Selection

- Alarm
- Alarm or warning
- Warning

Factory setting

Alarm

Switch-on value



Navigation

Setup → Advanced setup → Switch output → Switch-on value

Prerequisite

Switch output function (→ 160) = **Limit**

Description

Defines the switch-on point. The output is closed if the assigned process variable rises above this point.

User entry

Signed floating-point number

Factory setting

0

Additional information

The switching behavior depends on the relative position of the **Switch-on value** and **Switch-off value** parameters:

Switch-on value > Switch-off value

- The output is closed if the measured value is larger than **Switch-on value**.
- The output is opened if the measured value is smaller than **Switch-off value**.

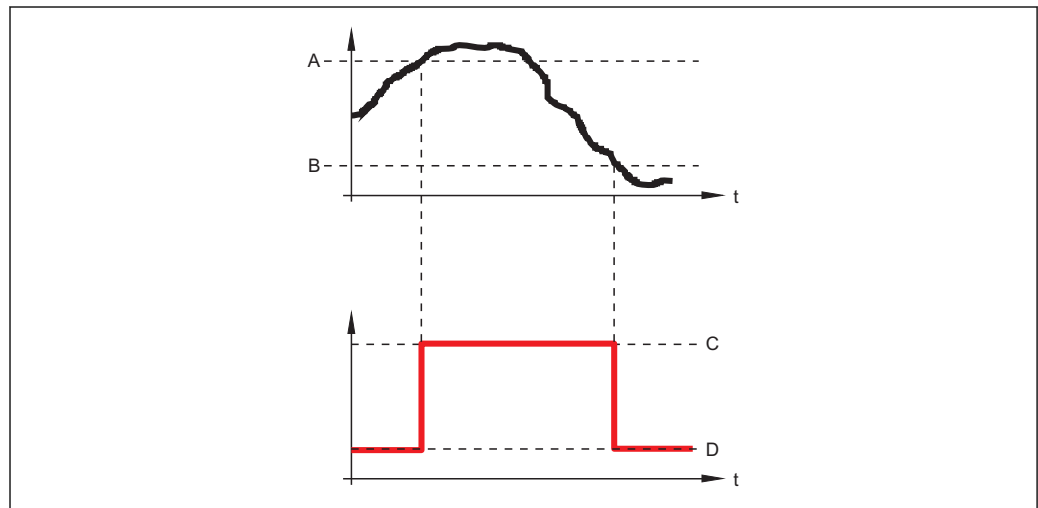

A0015585

- A *Switch-on value*
- B *Switch-off value*
- C *Output closed (conductive)*
- D *Output opened (non-conductive)*

Switch-on value < Switch-off value

- The output is closed if the measured value is smaller than **Switch-on value**.
- The output is opened if the measured value is larger than **Switch-off value**.

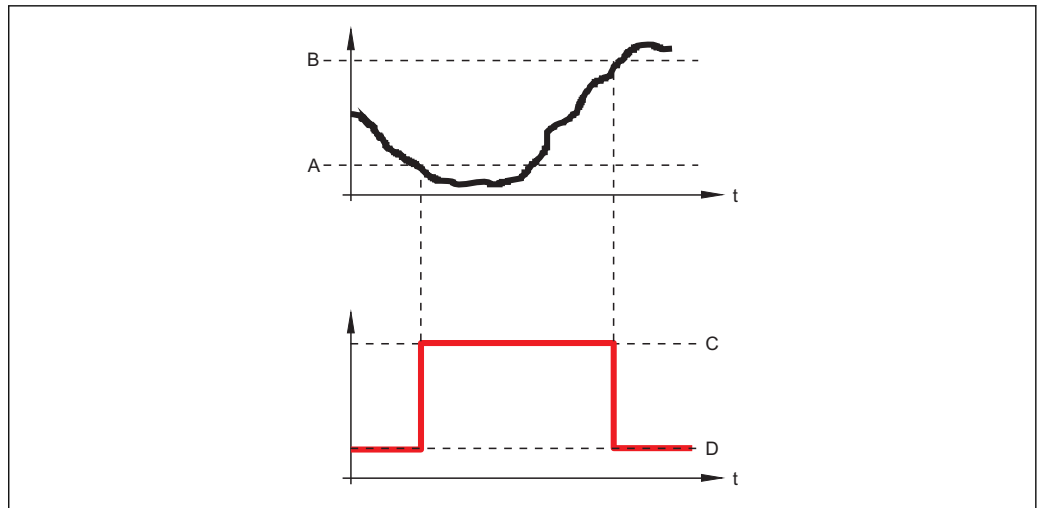

A0015586

- A Switch-on value
- B Switch-off value
- C Output closed (conductive)
- D Output opened (non-conductive)

Switch-on delay



Navigation Setup → Advanced setup → Switch output → Switch-on delay

Prerequisite **▪ Switch output function (→ 160) = Limit**
▪ Assign limit (→ 161) ≠ Off

Description Defines the delay applied before the output is switched on.

User entry 0.0 to 100.0 s

Factory setting 0.0 s

Switch-off value



Navigation Setup → Advanced setup → Switch output → Switch-off value

Prerequisite **Switch output function (→ 160) = Limit**

Description Defines the switch-off point. The output is opened if the assigned process variable falls below this point.





User entry Signed floating-point number

Factory setting 0

Additional information The switching behavior depends on the relative position of the **Switch-on value** and **Switch-off value** parameters; description: see the **Switch-on value** parameter (→ 162).



Switch-off delay



Navigation	  Setup → Advanced setup → Switch output → Switch-off delay
Prerequisite	<ul style="list-style-type: none"> ▪ Switch output function (→  160) = Limit ▪ Assign limit (→  161) ≠ Off
Description	Defines the delay applied before the output is switched off.
User entry	0.0 to 100.0 s
Factory setting	0.0 s



Failure mode



Navigation	  Setup → Advanced setup → Switch output → Failure mode
Prerequisite	Switch output function (→  160) = Limit or Digital Output
Description	Defines the state of the switch output in case of an error.
Selection	<ul style="list-style-type: none"> ▪ Actual status ▪ Open ▪ Closed
Factory setting	Open



Additional information

Switch status

Navigation	  Setup → Advanced setup → Switch output → Switch status
Description	Current status of the switch output.

Invert output signal



Navigation	  Setup → Advanced setup → Switch output → Invert output signal
Description	'No' The switch output behaves as per its parameter setting. 'Yes' The switching behavior is inverted as compared to its parameter setting.
Selection	<ul style="list-style-type: none"> ▪ No ▪ Yes

Factory setting

No

Additional information**Meaning of the options**■ **No**

The behavior of the switch output is as described above.

■ **Yes**The states **Open** and **Closed** are inverted as compared to the description above.

"Display" submenu

 The **Display** submenu is only visible if a display module is connected to the device.

Navigation  Setup → Advanced setup → Display

Language**Navigation**

 Setup → Advanced setup → Display → Language

Description

Set display language.

Selection

- English
- Deutsch *
- Français *
- Español *
- Italiano *
- Nederlands *
- Portuguesa *
- Polski *
- русский язык (Russian) *
- Svenska *
- Türkçe *
- 中文 (Chinese) *
- 日本語 (Japanese) *
- 한국어 (Korean) *
- Bahasa Indonesia *
- tiếng Việt (Vietnamese) *
- čeština (Czech) *

Factory setting

The language selected in feature 500 of the product structure.
If no language has been selected: **English**

Additional information**Format display****Navigation**

 Setup → Advanced setup → Display → Format display

Description

Select how measured values are shown on the display.

Selection

- 1 value, max. size
- 1 bargraph + 1 value
- 2 values
- 1 value large + 2 values
- 4 values

Factory setting

1 value, max. size

* Visibility depends on order options or device settings

Additional information

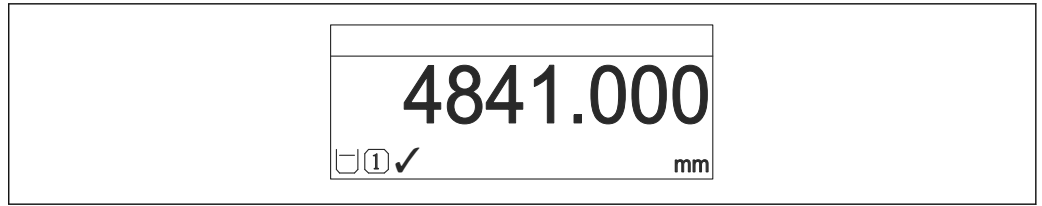

A0019963

56 "Format display" = "1 value, max. size"

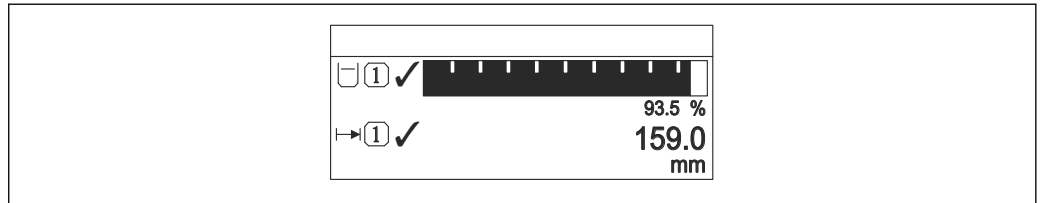

A0019964

57 "Format display" = "1 bargraph + 1 value"

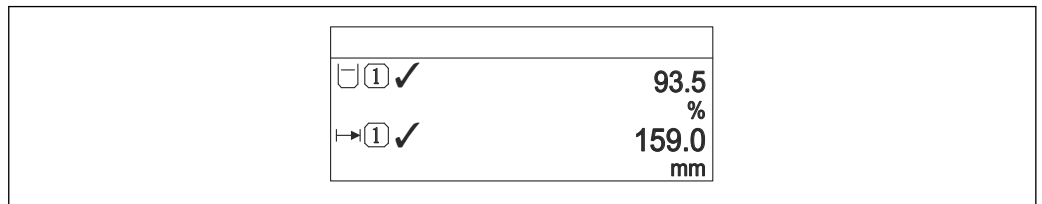

A0019965

58 "Format display" = "2 values"

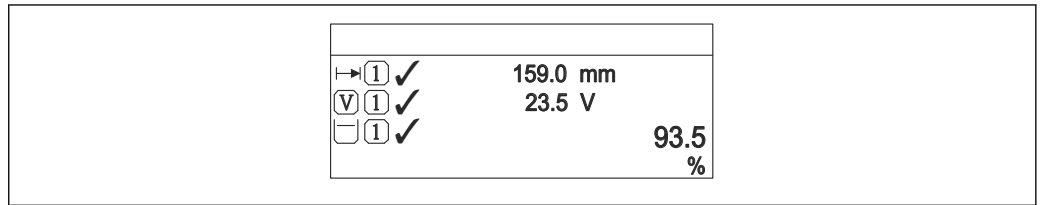

A0019966

59 "Format display" = "1 value large + 2 values"

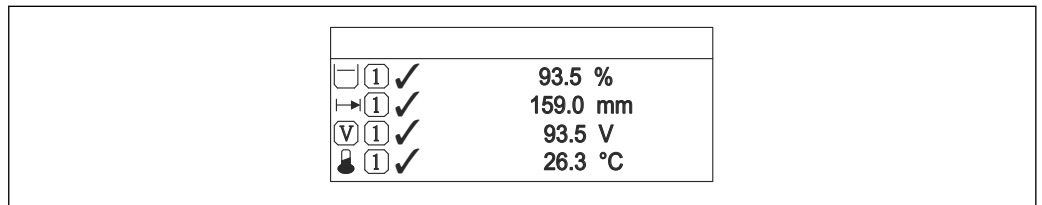

A0019968

60 "Format display" = "4 values"

- i

 - The **Value 1 to 4 display** → 168 parameters specify which measured values are shown on the display and in which order.
 - If more measured values are specified than the current display mode permits, the values alternate on the device display. The display time until the next change is configured in the **Display interval** parameter (→ 168).

Value 1 to 4 display

Navigation	Setup → Advanced setup → Display → Value 1 display
Description	Select the measured value that is shown on the local display.
Selection	<ul style="list-style-type: none"> ■ Level linearized ■ Distance ■ Current output 1 ■ Measured current ■ Current output 2 * ■ Terminal voltage ■ Electronic temperature ■ Absolute echo amplitude ■ Relative echo amplitude ■ Analog output adv. diagnostics 1 ■ Analog output adv. diagnostics 2 ■ Area of incoupling
Factory setting	<ul style="list-style-type: none"> ■ Value 1 display: Level linearized ■ Value 2 display: None ■ Value 3 display: None ■ Value 4 display: None

Decimal places 1 to 4

Navigation	Setup → Advanced setup → Display → Decimal places 1
Description	This selection does not affect the measurement and calculation accuracy of the device.
Selection	<ul style="list-style-type: none"> ■ x ■ x.x ■ x.xx ■ x.xxx ■ x.xxxx
Factory setting	x.xx
Additional information	The setting does not affect the measuring or computational accuracy of the device.

Display interval

Navigation	Setup → Advanced setup → Display → Display interval
Description	Set time measured values are shown on display if display alternates between values.
User entry	1 to 10 s

* Visibility depends on order options or device settings

Factory setting 5 s

Additional information This parameter is only relevant if the number of selected measuring values exceeds the number of values the selected display format can display simultaneously.

Display damping



Navigation Setup → Advanced setup → Display → Display damping

Description Set display reaction time to fluctuations in the measured value.

User entry 0.0 to 999.9 s

Factory setting 0.0 s

Header



Navigation Setup → Advanced setup → Display → Header

Description Select header contents on local display.

Selection

- Device tag
- Free text

Factory setting Device tag

Additional information

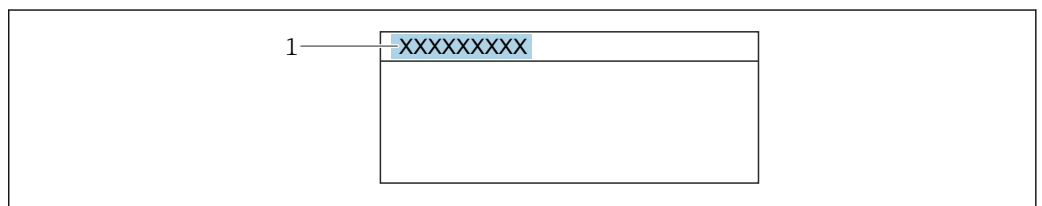

A0029422

1 Position of the header text on the display

Meaning of the options

- **Device tag**
Is defined in the **Device tag** parameter (→ 125)
- **Free text**
Is defined in the **Header text** parameter (→ 169)

Header text



Navigation Setup → Advanced setup → Display → Header text

Prerequisite **Header** (→ 169) = **Free text**

Description	Enter display header text.
Factory setting	-----
Additional information	The number of characters which can be displayed depends on the characters used.

Separator



Navigation	Setup → Advanced setup → Display → Separator
Description	Select decimal separator for displaying numerical values.
Selection	<ul style="list-style-type: none"> ▪ . ▪ ,
Factory setting	.

Number format





Navigation	Setup → Advanced setup → Display → Number format
Description	Choose number format for the display.
Selection	<ul style="list-style-type: none"> ▪ Decimal ▪ ft-in-1/16"
Factory setting	Decimal
Additional information	The ft-in-1/16" option is only valid for distance units.

Decimal places menu









Navigation	Setup → Advanced setup → Display → Decimal places menu
Description	Select number of decimal places for the representation of numbers within the operating menu.
Selection	<ul style="list-style-type: none"> ▪ x ▪ x.x ▪ x.xx ▪ x.xxx ▪ x.xxxx
Factory setting	x.xxxx

- Additional information**
- Is only valid for numbers in the operating menu (e.g. **Empty calibration**, **Full calibration**), but not for the measured value display. The number of decimal places for the measured value display is defined in the **Decimal places 1 to 4** →  168 parameters.
 - The setting does not affect the accuracy of the measurement or the calculations.

Backlight

- Navigation**   Setup → Advanced setup → Display → Backlight
- Prerequisite** The device has the SD03 local display (with optical keys).
- Description** Switch the local display backlight on and off.
- Selection**
- Disable
 - Enable
- Factory setting** Disable
- Additional information**
- Meaning of the options**
- **Disable**
Switches the backlight off.
 - **Enable**
Switches the backlight on.
-  Regardless of the setting in this parameter the backlight may be automatically switched off by the device if the supply voltage is too low.

Contrast display

- Navigation**   Setup → Advanced setup → Display → Contrast display
- Description** Adjust local display contrast setting to ambient conditions (e.g. lighting or reading angle).
- User entry** 20 to 80 %
- Factory setting** Dependent on the display.
- Additional information**
-  Setting the contrast via push-buttons:
- Darker: press the   buttons simultaneously.
 - Brighter: press the   buttons simultaneously.

"Configuration backup display" submenu

 This submenu is only visible if a display module is connected to the device.

The configuration of the device can be saved to the display module at a certain point of time (backup). The saved configuration can be restored to the device if required, e.g. in order to bring the device back into a defined state. The configuration can also be transferred to a different device of the same type using the display module.

Navigation  Setup → Advanced setup → Configuration backup display

Operating time

Navigation  Setup → Advanced setup → Configuration backup display → Operating time

Description Indicates how long the device has been in operation.

Additional information *Maximum time*
9999 d (≈ 27 years)

Last backup

Navigation  Setup → Advanced setup → Configuration backup display → Last backup

Description Indicates when the last data backup was saved to the display module.

Configuration management



Navigation  Setup → Advanced setup → Configuration backup display → Configuration management

Description Select action for managing the device data in the display module.

- Selection**
- Cancel
 - Execute backup
 - Restore
 - Duplicate
 - Compare
 - Clear backup data

Factory setting Cancel

Additional information

Meaning of the options

■ **Cancel**

No action is executed and the user exits the parameter.

■ **Execute backup**

A backup copy of the current device configuration in the HistoROM (built-in in the device) is saved to the display module of the device.

■ **Restore**

The last backup copy of the device configuration is copied from the display module to the HistoROM of the device.

■ **Duplicate**

The transmitter configuration is duplicated to another device using the transmitter display module. The following parameters, which characterize the individual measuring point are **not** included in the transmitted configuration:

- HART date code
- HART short tag
- HART message
- HART descriptor
- HART address
- Device tag
- Medium type

■ **Compare**

The device configuration saved in the display module is compared to the current device configuration of the HistoROM. The result of this comparison is displayed in the **Comparison result** parameter (→  173).

■ **Clear backup data**

The backup copy of the device configuration is deleted from the display module of the device.



While this action is in progress, the configuration cannot be edited via the local display and a message on the processing status appears on the display.



If an existing backup is restored to a different device using the **Restore** option, it may occur that some device functionalities are no longer available. In some cases even a device reset will not restore the original status.

In order to transmit a configuration to a different device, the **Duplicate** option should always be used.

Backup state

Navigation

 Setup → Advanced setup → Configuration backup display → Backup state

Description

Displays which backup action is currently in progress.

Comparison result

Navigation

  Setup → Advanced setup → Configuration backup display → Comparison result

Description

Comparison between present device data and display backup.

Additional information**Meaning of the display options****■ Settings identical**

The current device configuration of the HistoROM is identical to the backup copy in the display module.

■ Settings not identical

The current device configuration of the HistoROM is not identical to the backup copy in the display module.

■ No backup available

There is no backup copy of the device configuration of the HistoROM in the display module.

■ Backup settings corrupt

The current device configuration of the HistoROM is corrupt or not compatible with the backup copy in the display module.

■ Check not done

The device configuration of the HistoROM has not yet been compared to the backup copy in the display module.

■ Dataset incompatible

The data sets are incompatible and can not be compared.





To start the comparison, set **Configuration management** (→  172) = **Compare**.



If the transmitter configuration has been duplicated from a different device by **Configuration management** (→  172) = **Duplicate**, the new device configuration in the HistoROM is only partially identical to the configuration stored in the display module: Sensor specific properties (e.g. the mapping curve) are not duplicated. Thus, the result of the comparison will be **Settings not identical**.

"Administration" submenu

Navigation  Setup → Advanced setup → Administration

Define access code 









Navigation  Setup → Advanced setup → Administration → Define access code

Description Define release code for write access to parameters.

User entry 0 to 9999

Factory setting 0

Additional information

-  If the factory setting is not changed or 0 is defined as the access code, the parameters are not write-protected and the configuration data of the device can then always be modified. The user is logged on in the *Maintenance* role.
-  The write protection affects all parameters marked with the  symbol in this document. On the local display, the  symbol in front of a parameter indicates that the parameter is write-protected.
-  Once the access code has been defined, write-protected parameters can only be modified if the access code is entered in the **Enter access code** parameter (→  136).
-  Please contact your Endress+Hauser Sales Center if you lose your access code.
-  For display operation: The new access code is only valid after it has been confirmed in the **Confirm access code** parameter (→  177).

Device reset 

Navigation   Setup → Advanced setup → Administration → Device reset

Description Reset the device configuration - either entirely or in part - to a defined state.

Selection

- Cancel
- To factory defaults
- To delivery settings
- Of customer settings
- To transducer defaults
- Restart device

Factory setting Cancel

Additional information**Meaning of the options****■ Cancel**

No action

■ To factory defaults

All parameters are reset to the order-code specific factory setting.

■ To delivery settings

All parameters are reset to the delivery setting. The delivery setting may differ from the factory default if customer specific settings have been ordered.

This option is only visible if customer specific settings have been ordered.

■ Of customer settings

All customer parameters are reset to their factory setting. Service parameters, however, remain unchanged.

■ To transducer defaults

Every measurement-related parameter is reset to its factory setting. Service parameters and communication-related parameters, however, remain unchanged.

■ Restart device

The restart resets every parameter which is stored in the volatile memory (RAM) to the factory setting (e.g. measured value data). The device configuration remains unchanged.

"Define access code" wizard

 The **Define access code** wizard is only available when operating via the local display. When operating via an operating tool, the **Define access code** parameter is located directly in the **Administration** submenu. The **Confirm access code** parameter is not available for operation via operating tool.

Navigation  Setup → Advanced setup → Administration → Define access code

Define access code 

Navigation  Setup → Advanced setup → Administration → Define access code → Define access code

Description →  175

Confirm access code 

Navigation  Setup → Advanced setup → Administration → Define access code → Confirm access code

Description Confirm the entered access code.

User entry 0 to 9999

Factory setting 0

17.5 "Diagnostics" menu

Navigation  Diagnostics

Actual diagnostics



Navigation  Diagnostics → Actual diagnostics

Description Displays current diagnostic message.

Additional information The display consists of:

- Symbol for event behavior
- Code for diagnostic behavior
- Operating time of occurrence
- Event text

 If several messages are active at the same time, the messages with the highest priority is displayed.

 Information on what is causing the message, and remedy measures, can be viewed via the  symbol on the display.

Timestamp

Navigation  Diagnostics → Timestamp

Description Displays the timestamp for the currently active diagnostic message.



Previous diagnostics

Navigation  Diagnostics → Previous diagnostics

Description Displays the last diagnostic message which has been active before the current message.

Additional information The display consists of:

- Symbol for event behavior
- Code for diagnostic behavior
- Operating time of occurrence
- Event text

 The condition displayed may still apply. Information on what is causing the message, and remedy measures, can be viewed via the  symbol on the display.

Timestamp

Navigation  Diagnostics → Timestamp

Description Shows the timestamp of the previous diagnostic message.

Operating time from restart

Navigation   Diagnostics → Operating time from restart

Description Displays the time the device has been in operation since the last device restart.

Operating time

Navigation   Diagnostics → Operating time

Description Indicates how long the device has been in operation.

Additional information *Maximum time*
9999 d (≈ 27 years)

17.5.1 "Diagnostic list" submenu

Navigation  Diagnostics → Diagnostic list

Diagnostics 1 to 5

Navigation

 Diagnostics → Diagnostic list → Diagnostics 1

Description

Display the current diagnostics messages with the highest to fifth-highest priority.

Additional information

The display consists of:

- Symbol for event behavior
- Code for diagnostic behavior
- Operating time of occurrence
- Event text

Timestamp 1 to 5

Navigation

 Diagnostics → Diagnostic list → Timestamp

Description



Timestamp of the diagnostic message.

17.5.2 "Event logbook" submenu

 The **Event logbook** submenu is only available when operating via the local display. When operating via FieldCare, the event list can be displayed in the FieldCare function "Event List / HistoROM".

Navigation  Diagnostics → Event logbook



Filter options



Navigation	 Diagnostics → Event logbook → Filter options
Description	Define which category of event messages is shown in the Events list submenu.
Selection	<ul style="list-style-type: none"> ▪ All ▪ Failure (F) ▪ Function check (C) ▪ Out of specification (S) ▪ Maintenance required (M) ▪ Information (I)
Factory setting	All
Additional information	 <ul style="list-style-type: none"> ▪ This parameter is only used for operation via the local display. ▪ The status signals are categorized according to NAMUR NE 107.

"Event list" submenu

The **Event list** submenu displays the history of past events of the category selected in the **Filter options** parameter (→  181). A maximum of 100 events are displayed in chronological order.

The following symbols indicate whether an event has occurred or has ended:

- : Event has occurred
- : Event has ended

 Information on what is causing the message, and remedy instructions, can be viewed via the -button.

Display format

- For event messages in category I: information event, event text, "recording event" symbol and time the event occurred
- For event messages in category F, M, C, S (status signal): diagnostics event, event text, "recording event" symbol and time the event occurred

Navigation  Diagnostics → Event logbook → Event list

17.5.3 "Device information" submenu

Navigation  Diagnostics → Device information

Device tag

Navigation  Diagnostics → Device information → Device tag

Description Enter the name for the measuring point.

Factory setting FMR5x

Serial number

Navigation  Diagnostics → Device information → Serial number

Description Shows the serial number of the measuring device.

Additional information  **Uses of the serial number**

- To identify the device quickly, e.g. when contacting Endress+Hauser.
- To obtain specific information on the device using the Device Viewer:
www.endress.com/deviceviewer

 The serial number is also indicated on the nameplate.

Firmware version

Navigation  Diagnostics → Device information → Firmware version

Description Shows the device firmware version installed.











User interface xx.yy.zz

Additional information  For firmware versions differing only in the last two digits ("zz") there is no difference concerning functionality or operation.

Device name

Navigation  Diagnostics → Device information → Device name

Description Shows the name of the transmitter.

Order code		
Navigation	  Diagnostics → Device information → Order code	
Description	Shows the device order code.	
Additional information	The order code is generated from the extended order code, which defines all device features of the product structure. In contrast, the device features can not be read directly from the order code.	
Extended order code 1 to 3		
Navigation	  Diagnostics → Device information → Extended order code 1	
Description	Display the three parts of the extended order code.	
Additional information	The extended order code indicates the version of all the features of the product structure and thus uniquely identifies the device.	
Device revision		
Navigation	  Diagnostics → Device information → Device revision	
Description	Shows the device revision with which the device is registered with the HART Communication Foundation.	
Additional information	The device revision is used to allocate the correct Device Description file (DD) to the device.	
Device ID		
Navigation	  Diagnostics → Device information → Device ID	
Description	Shows the device ID for identifying the device in a HART network.	
Additional information	In addition to the Device type and Manufacturer ID, the Device ID is part of the unique device identification (Unique ID) which characterizes each HART device unambiguously.	

Device type

Navigation	 Diagnostics → Device information → Device type
Description	Shows the device type with which the measuring device is registered with the HART Communication Foundation.
Additional information	The device type is needed to allocate the suitable Device Description (DD) to the device.

Manufacturer ID

Navigation	 Diagnostics → Device information → Manufacturer ID
Description	Use this function to view the manufacturer ID with which the measuring device is registered with the HART Communication Foundation.
User interface	2-digit hexadecimal number
Factory setting	0x11 (for Endress+Hauser)

17.5.4 "Measured values" submenu

Navigation  Diagnostics → Measured values

Distance

Navigation  Diagnostics → Measured values → Distance

Description Displays the measured distance D between the reference point (lower edge of the flange or threaded connection) and the level.

Additional information

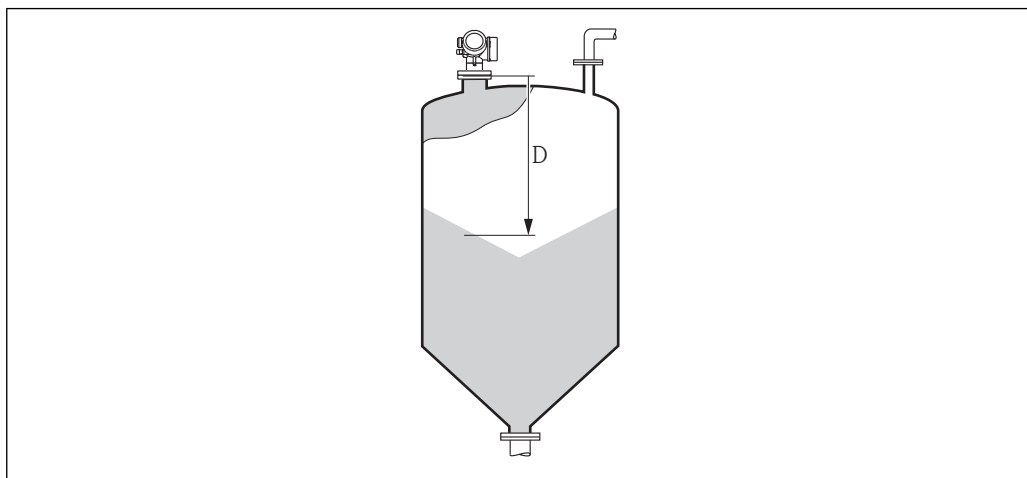

 61 Distance for bulk solid measurements A0019485

 The unit is defined in the **Distance unit** parameter (→  125).

Level linearized

Navigation  Diagnostics → Measured values → Level linearized

Description Displays linearized level.

Additional information  The unit is defined by the **Unit after linearization** parameter →  145.

Output current 1 to 2

Navigation  Diagnostics → Measured values → Output current 1 to 2

Description Shows the actual calculated value of the output current.

Measured current 1

Navigation	 Diagnostics → Measured values → Measured current 1
Prerequisite	Only available for current output 1
Description	Shows the current value of the current output which is currently measured.

Terminal voltage 1

Navigation	 Diagnostics → Measured values → Terminal voltage 1
Description	Shows the current terminal voltage that is applied at the output.

Electronic temperature

Navigation	 Diagnostics → Measured values → Electronic temperature
Description	Displays the current temperature of the electronics.
Additional information	The unit is defined in the Temperature unit parameter.

17.5.5 "Data logging" submenu

Navigation  Diagnostics → Data logging

Assign channel 1 to 4

Navigation  Diagnostics → Data logging → Assign channel 1 to 4

Description Assign a process variable to logging channel.

Selection

- Off
- Level linearized
- Distance
- Current output 1
- Measured current
- Current output 2 *
- Terminal voltage
- Electronic temperature
- Absolute echo amplitude
- Relative echo amplitude
- Area of incoupling
- Analog output adv. diagnostics 1
- Analog output adv. diagnostics 2

Factory setting Off

Additional information A total of 1000 measured values can be logged. This means:

- 1000 data points if 1 logging channel is used
- 500 data points if 2 logging channels are used
- 333 data points if 3 logging channels are used
- 250 data points if 4 logging channels are used

If the maximum number of data points is reached, the oldest data points in the data log are cyclically overwritten in such a way that the last 1000, 500, 333 or 250 measured values are always in the log (ring memory principle).

 The logged data are deleted if a new option is selected in this parameter.

Logging interval

Navigation  Diagnostics → Data logging → Logging interval

 Diagnostics → Data logging → Logging interval

Description Define the logging interval tlog for data logging. This value defines the time interval between the individual data points in the memory.

User entry 1.0 to 3 600.0 s

* Visibility depends on order options or device settings

Factory setting 30.0 s

Additional information This parameter defines the interval between the individual data points in the data log, and thus the maximum loggable process time T_{\log} :

- If 1 logging channel is used: $T_{\log} = 1000 \cdot t_{\log}$
- If 2 logging channels are used: $T_{\log} = 500 \cdot t_{\log}$
- If 3 logging channels are used: $T_{\log} = 333 \cdot t_{\log}$
- If 4 logging channels are used: $T_{\log} = 250 \cdot t_{\log}$

Once this time elapses, the oldest data points in the data log are cyclically overwritten such that a time of T_{\log} always remains in the memory (ring memory principle).

 The logged data are deleted if this parameter is changed.



Example

When using 1 logging channel

- $T_{\log} = 1000 \cdot 1 \text{ s} = 1000 \text{ s} \approx 16.5 \text{ min}$
- $T_{\log} = 1000 \cdot 10 \text{ s} = 10000 \text{ s} \approx 2.75 \text{ h}$
- $T_{\log} = 1000 \cdot 80 \text{ s} = 80000 \text{ s} \approx 22 \text{ h}$
- $T_{\log} = 1000 \cdot 3600 \text{ s} = 3600000 \text{ s} \approx 41 \text{ d}$

Clear logging data

Navigation

-  Diagnostics → Data logging → Clear logging data
-  Diagnostics → Data logging → Clear logging data

Description Clear the entire logging data.

Selection

- Cancel
- Clear data

Factory setting Cancel

"Display channel 1 to 4" submenu

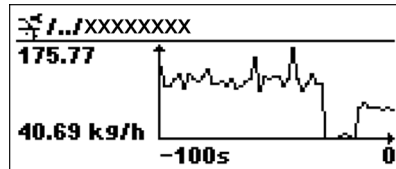

i The **Display channel 1 to 4** submenus are only available for operation via the local display. When operating via FieldCare, the logging diagram can be displayed in the FieldCare function "Event List / HistoROM" .

The **Display channel 1 to 4** submenus invoke a diagram of the logging history of the respective channel.



- x-axis: depending on the number of selected channels, 250 to 1000 measured values of a process variable are displayed.
- y-axis: covers the approximate measured value span and constantly adapts this to the measurement.







i To return to the operating menu, press \oplus and \ominus simultaneously.

Navigation   Diagnostics → Data logging → Display channel 1 to 4

17.5.6 "Simulation" submenu







The **Simulation** submenu is used to simulate specific measuring values or other conditions. This helps to check the correct configuration of the device and connected control units.

Conditions which can be simulated

Condition to be simulated	Associated parameters
Specific value of a process variable	<ul style="list-style-type: none"> ▪ Assign measurement variable (→  192) ▪ Process variable value (→  192)
Specific value of the output current	<ul style="list-style-type: none"> ▪ Current output simulation (→  192) ▪ Value current output (→  193)
Specific state of the switch output	<ul style="list-style-type: none"> ▪ Switch output simulation (→  193) ▪ Switch status (→  193)
Existence of an alarm	Device alarm simulation (→  194)

Structure of the submenu



Navigation  Expert → Diagnostics → Simulation

▶ Simulation	
Assign measurement variable	→  192
Process variable value	→  192
Current output 1 to 2 simulation	→  192
Value current output 1 to 2	→  193
Switch output simulation	→  193
Switch status	→  193
Device alarm simulation	→  194



Description of parameters

Navigation  Expert → Diagnostics → Simulation

Assign measurement variable

Navigation	 Expert → Diagnostics → Simulation → Assign measurement variable
Selection	<ul style="list-style-type: none"> ▪ Off ▪ Level ▪ Level linearized
Factory setting	Off
Additional information	<ul style="list-style-type: none"> ▪ The value of the variable to be simulated is defined in the Process variable value parameter (→  192). ▪ If Assign measurement variable ≠ Off, a simulation is active. This is indicated by a diagnostic message of the <i>Function check (C)</i> category.

Process variable value

Navigation	 Expert → Diagnostics → Simulation → Process variable value
Prerequisite	Assign measurement variable (→  192) ≠ Off
User entry	Signed floating-point number
Factory setting	0
Additional information	Downstream measured value processing and the signal output use this simulation value. In this way, users can verify whether the measuring device has been configured correctly.

Current output 1 to 2 simulation

Navigation	 Expert → Diagnostics → Simulation → Current output 1 to 2 simulation
Description	Switch the simulation of the current output on and off.
Selection	<ul style="list-style-type: none"> ▪ Off ▪ On
Factory setting	Off
Additional information	An active simulation is indicated by a diagnostic message of the <i>Function check (C)</i> category.

Value current output 1 to 2

Navigation	Expert → Diagnostics → Simulation → Value current output 1 to 2
Prerequisite	Current output simulation (→ 192) = On
Description	Defines the value of the simulated output current.
User entry	3.59 to 22.5 mA
Factory setting	3.59 mA
Additional information	The current output assumes the value specified in this parameter. In this way, users can verify the correct adjustment of the current output and the correct function of connected control units.

Switch output simulation

Navigation	Expert → Diagnostics → Simulation → Switch output simulation
Description	Switch the simulation of the switch output on and off.
Selection	<ul style="list-style-type: none"> ■ Off ■ On
Factory setting	Off

Switch status

Navigation	Expert → Diagnostics → Simulation → Switch status
Prerequisite	Switch output simulation (→ 193) = On
Description	Current status of the switch output.
Selection	<ul style="list-style-type: none"> ■ Open ■ Closed
Factory setting	Open
Additional information	The switch status assumes the value defined in this parameter. This helps to check correct operation of connected control units.

Device alarm simulation

**Navigation**

Expert → Diagnostics → Simulation → Device alarm simulation

Description

Switch the device alarm on and off.

Selection

- Off
- On

Factory setting

Off

Additional information

When selecting the **On** option, the device generates an alarm. This helps to check the correct output behavior of the device in the case of an alarm.

An active simulation is indicated by the diagnostic message **C484 Failure mode simulation**.

Diagnostic event simulation

**Navigation**

Expert → Diagnostics → Simulation → Diagnostic event simulation

Description

Select the diagnostic event to be simulated. Note: To terminate the simulation, select 'Off'.

Factory setting

Off



Additional information

When operated via the local display, the selection list can be filtered according to the event categories (**Diagnostic event category** parameter).



17.5.7 "Device check" submenu

Navigation   Diagnostics → Device check



Start device check

Navigation	  Diagnostics → Device check → Start device check
Description	Start a device check.
Selection	<ul style="list-style-type: none"> ■ No ■ Yes
Factory setting	No
Additional information	In the case of a lost echo a device check can not be performed.

Result device check

Navigation	  Diagnostics → Device check → Result device check
Description	Displays the result of the device check.
Additional information	<p>Meaning of the display options</p> <ul style="list-style-type: none"> ■ Installation ok Measurement possible without restrictions. ■ Accuracy reduced A measurement is possible. However, the measuring accuracy may be reduced due to the signal amplitudes. ■ Measurement capability reduced A measurement is currently possible. However, there is the risk of an echo loss. Check the mounting position of the device and the dielectric constant of the medium. ■ Check not done No device check has been performed.

Last check time

Navigation	  Diagnostics → Device check → Last check time
Description	Displays the operating time at which the last device check has been performed.

Level signal

Navigation Diagnostics → Device check → Level signal**Prerequisite**

Device check has been performed.

Description

Displays result of the device check for the level signal.

User interface

- Check not done
- Check not OK
- Check OK

Additional informationFor **Level signal = Check not OK**: Check the mounting position of the device and the dielectric constant of the medium.

17.5.8 "Heartbeat" submenu

 The **Heartbeat** submenu is only available via **FieldCare** or **DeviceCare**. It contains the wizards which are part of the **Heartbeat Verification** and **Heartbeat Monitoring** application packages.

Detailed description

SD01871F

Navigation  Diagnostics → Heartbeat

Index

A

Access authorization to parameters	
Read access	56
Write access	56
Access code	56
Incorrect input	56
Access status display (Parameter)	136
Access status tooling (Parameter)	135
Accessories	
Communication specific	104
Service specific	105
Activate table (Parameter)	150
Actual diagnostics (Parameter)	178
Administration (Submenu)	175
Advanced process conditions (Parameter)	138
Advanced setup (Submenu)	135
Application	10
Residual risk	10
Assign channel 1 to 4 (Parameter)	187
Assign current output (Parameter)	156
Assign diagnostic behavior (Parameter)	161
Assign limit (Parameter)	161
Assign measurement variable (Parameter)	192
Assign status (Parameter)	161

B

Backlight (Parameter)	171
Backup state (Parameter)	173
Bin type (Parameter)	125
Blocking distance (Parameter)	139, 152
Bluetooth® wireless technology	52

C

CE mark	11
Cleaning	94
Clear logging data (Parameter)	188
Code incorrect (Parameter)	155
Comparison result (Parameter)	173
Configuration backup display (Submenu)	172
Configuration management (Parameter)	172
Configuration of a level measurement	76
Confirm access code (Parameter)	177
Confirm distance (Parameter)	130, 133
Context menu	67
Contrast display (Parameter)	171
Current output 1 to 2 (Submenu)	156
Current output 1 to 2 simulation (Parameter)	192
Current span (Parameter)	157
Customer value (Parameter)	150

D

Damping output (Parameter)	158
Data logging (Submenu)	187
DD	69
Deactivate SIL/WHG (Wizard)	155
Decimal places 1 (Parameter)	168

Decimal places menu (Parameter)	170
Declaration of Conformity	11
Define access code	56
Define access code (Parameter)	175, 177
Define access code (Wizard)	177
Designated use	10
Device alarm simulation (Parameter)	194
Device check (Submenu)	195
Device Descriptions	69
Device ID (Parameter)	183
Device information (Submenu)	182
Device name (Parameter)	182
Device replacement	95
Device reset (Parameter)	175
Device revision (Parameter)	183
Device tag (Parameter)	125, 182
Device type (Parameter)	184
Diagnostic event	
In the operating tool	88
Diagnostic event simulation (Parameter)	194
Diagnostic events	85
Diagnostic list	89
Diagnostic list (Submenu)	180
Diagnostic message	85
Diagnostics	
Symbols	85
Diagnostics (Menu)	178
Diagnostics 1 (Parameter)	180
Diagnostics event	86
Diameter (Parameter)	147
DIP switch	
see Write protection switch	
Display (Submenu)	166
Display and operating module FHX50	51
Display channel 1 to 4 (Submenu)	189
Display damping (Parameter)	169
Display interval (Parameter)	168
Display module	61
Display symbols for submenus	62
Display symbols for the locking state	62
Disposal	96
Distance (Parameter)	129, 133, 185
Distance unit (Parameter)	125
Document	
Function	5
Document function	5

E

Electronic temperature (Parameter)	186
Electronics housing	
Design	16
Empty calibration (Parameter)	127
Enter access code (Parameter)	136
Envelope curve display	68
Event history	91

Event level
 Explanation 85
 Symbols 85
 Event list (Submenu) 181
 Event logbook (Submenu) 181
 Event text 86
 Events list 91
 Extended order code 1 (Parameter) 183
 Exterior cleaning 94

F
 Failure current (Parameter) 159
 Failure mode (Parameter) 158, 164
 FHX50 51
 Filter options (Parameter) 181
 Filtering the event logbook 92
 Firmware version (Parameter) 182
 Fixed current (Parameter) 157
 Format display (Parameter) 166
 Free text (Parameter) 146
 Full calibration (Parameter) 128
 FV (HART device variable) 69

H
 Hardware write protection 57
 HART device variables 69
 HART integration 69
 HART protocol 53
 Header (Parameter) 169
 Header text (Parameter) 169
 Heartbeat (Submenu) 197
 Housing
 Design 16
 Turning 34

I
 Input mask 65
 Intermediate height (Parameter) 147
 Invert output signal (Parameter) 164

K
 Keypad lock
 Disabling 60
 Switching on 60

L
 Language (Parameter) 166
 Last backup (Parameter) 172
 Last check time (Parameter) 195
 Level (Parameter) 128, 149, 150
 Level (Submenu) 137
 Level correction (Parameter) 139
 Level linearized (Parameter) 146, 185
 Level measurement configuration 76
 Level signal (Parameter) 196
 Level unit (Parameter) 138
 Linearization (Submenu) 142, 143, 144
 Linearization type (Parameter) 144
 Local display 50
 see Diagnostics message

 see In alarm condition
 Locking status (Parameter) 135
 Logging interval (Parameter) 187

M
 Maintenance 94
 Manage device configuration 80
 Manufacturer ID (Parameter) 184
 Mapping (Wizard) 133
 Mapping end point (Parameter) 131, 133
 Max. draining speed solid (Parameter) 126
 Max. filling speed solid (Parameter) 126
 Maximum value (Parameter) 147
 Measured current 1 (Parameter) 186
 Measured materials 10
 Measured value symbols 63
 Measured values (Submenu) 185
 Medium property (Parameter) 137
 Medium type (Parameter) 137
 Menu
 Diagnostics 178
 Setup 125

N
 Number format (Parameter) 170

O
 Operating elements
 Diagnostics message 86
 Operating module 61
 Operating time (Parameter) 172, 179
 Operating time from restart (Parameter) 179
 Operational safety 11
 Order code (Parameter) 183
 Output current 1 to 2 (Parameter) 159, 185
 Output echo lost (Parameter) 151
 Overvoltage protection
 General information 46

P
 Prepare recording map (Parameter) 133
 Present mapping (Parameter) 131
 Previous diagnostics (Parameter) 178
 Process variable value (Parameter) 192
 Product safety 11
 PV (HART device variable) 69

R
 Ramp at echo lost (Parameter) 152
 Read access 56
 Record map (Parameter) 132, 133
 Registered trademarks 9
 Remedial measures
 Calling up 87
 Closing 87
 Remote operation 53
 Repair concept 95
 Replacing a device 95
 Requirements for personnel 10
 Reset write protection (Parameter) 155

Result device check (Parameter)	195
Return	96
S	
Safety instructions	
Basic	10
Safety Instructions (XA)	12
Safety settings (Submenu)	151
Separator (Parameter)	170
Serial number (Parameter)	182
Service interface (CDI)	53
Setting the operating language	75
Settings	
Manage device configuration	80
Operating language	75
Setup (Menu)	125
Signal quality (Parameter)	129
SIL/WHG confirmation (Wizard)	154
Simulation (Submenu)	191, 192
Spare parts	96
Nameplate	96
Start device check (Parameter)	195
Status signals	62, 85
Submenu	
Administration	175
Advanced setup	135
Configuration backup display	172
Current output 1 to 2	156
Data logging	187
Device check	195
Device information	182
Diagnostic list	180
Display	166
Display channel 1 to 4	189
Event list	181
Event logbook	181
Events list	91
Heartbeat	197
Level	137
Linearization	142, 143, 144
Measured values	185
Safety settings	151
Simulation	191, 192
Switch output	160
SV (HART device variable)	69
Switch output (Submenu)	160
Switch output function (Parameter)	160
Switch output simulation (Parameter)	193
Switch status (Parameter)	164, 193
Switch-off delay (Parameter)	164
Switch-off value (Parameter)	163
Switch-on delay (Parameter)	163
Switch-on value (Parameter)	162
Symbols	
For correction	65
In the text and numeric editor	65
System components	106

T

Table mode (Parameter)	148
Table number (Parameter)	149
Tank/silo height (Parameter)	140
Terminal voltage 1 (Parameter)	186
Timestamp (Parameter)	178, 179, 180
Transmitter	
Turning the display	34
Turning the display module	35
Transmitter housing	
Turning	34
Trouble shooting	82
Turning the display	34
Turning the display module	35
TV (HART device variable)	69

U

Unit after linearization (Parameter)	145
--	-----

V

Value 1 display (Parameter)	168
Value current output 1 to 2 (Parameter)	193
Value echo lost (Parameter)	151

W

W@M Device Viewer	96
Wizard	
Deactivate SIL/WHG	155
Define access code	177
Mapping	133
SIL/WHG confirmation	154
Workplace safety	11
Write access	56
Write protection	
Via access code	56
Via write protection switch	57
Write protection switch	57

Z

Zubehör	
Gerätespezifisch	97



www.addresses.endress.com
