

liquisys CLM 221 Transmitter for Conductivity with Limit contacter

Operating Instructions

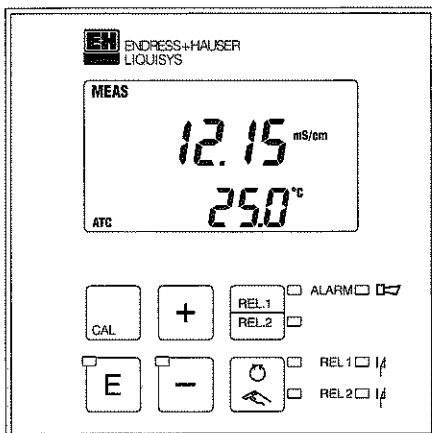

Please familiarise yourself with the instrument before you take any other steps:

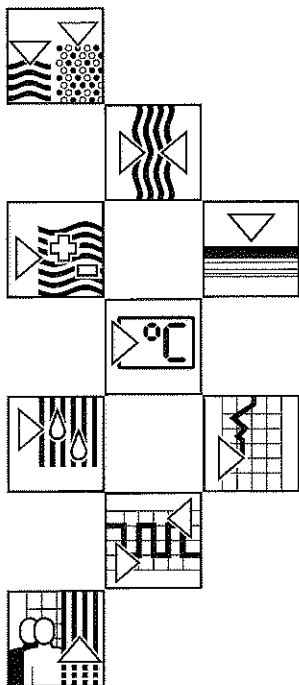

1 General information



2 Safety



3 Description

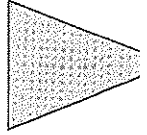

You wish to install and start up the instrument. The required steps are described in these chapters:



4 Installation



5 First start-up

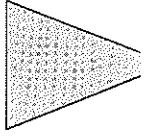

You wish to operate or reconfigure the instrument. The operating concept is explained in these chapters:



6 Operation



7 Instrument configuration

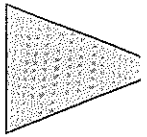

See the back cover for a fold-out overview of the menu

When you encounter problems or when the instrument requires maintenance, refer to these chapters for help:



8 Diagnostics



9 Maintenance and service

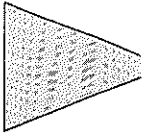

Table of contents

1	General information	2
1.1	Symbols used	2
1.2	Conformity statement	2
2	Safety	3
2.1	Intended use	3
2.2	General safety notes	3
2.3	Safety devices	3
3	Description	4
3.1	Areas of application	4
3.2	Measuring system	4
3.3	Important features	5
3.4	Instrument variants	6
3.5	Accessories	7
4	Installation	9
4.1	Storage and transport	9
4.2	Unpacking	9
4.3	Mounting	10
4.4	Connection	12
4.5	Packaging and disposal	17
5	First start-up	18
5.1	Measures before first power-up	18
5.2	Power-up, factory settings	19
5.3	First configuration and calibration	20
5.4	Test	21
6	Operation	22
6.1	Operator interface	22
6.2	Display elements	22
6.3	Key functions	24
6.4	Operating concept	25
6.5	Operation example	27
6.6	Auto / manual mode of operation	29
7	Instrument configuration	30
7.1	Temperature compensation type selection	30
7.2	Selection of temperature compensation	31
7.3	Limit contacter configuration	32
7.4	Limit contacter relay configuration	34
7.5	Measuring range / current output selection	35
7.6	General instrument configuration	36
7.7	Calibration of measuring transmitter	37
8	Diagnostics	40
8.1	Alarm	40
8.2	Errors	40
8.3	Instrument test	41
8.4	Possible faults in measuring mode and remedy	43
9	Maintenance and service	44
9.1	Cleaning	44
9.2	Maintenance notes on conductivity measuring cells	44
9.3	Repair	44
10	Appendix	45
10.1	Technical data	45
10.2	Index	48

1 General information

1.1 Symbols used

**Warning!**

This symbol alerts to hazards which may cause serious injuries as well as damage to the instrument, measuring system or other equipment if ignored.

**Caution!**

This symbol alerts to possible malfunction due to operator error.

**Note!**

This symbol indicates important items of information.

1.2 Conformity statement

The conductivity measuring transmitter Liquisys CLM 221 has been developed and manufactured in accordance with the applicable European standards and directives.

**Note:**

The corresponding certificate of conformity may be requested from Endress+Hauser.

2 Safety

2.1 Intended use

The measuring transmitter Liquisys CLM 221 is a field-tested and reliable measuring instrument for determining the electrolytic conductivity or specific resistance. It is equipped with a current output and two switched outputs for connection to automated process controllers.

2.2 General safety notes



Warning:

- Operation of the device in a manner other than as described in these operating instructions can lead to unsafe and improper functioning of the measuring system.
- The instrument must only be used as a panel-mounted device or in conjunction with the optional field housing.

Installation, start-up, operation

The Liquisys CLM 221 instrument has been designed for safe operation according to the state of the art in engineering and in accordance with the applicable regulations and EC directives; see "Technical data". However, if used improperly or other than for the intended purpose, it may pose a hazard, e.g. due to improper connection.

Installation, electrical connection, start-up, operation and maintenance of the measuring system must therefore be performed exclusively by trained specialists authorised by the system operator. This personnel must have read and understood these operating instructions and must adhere to them.

2.3 Safety devices

- **Access code:**
Unauthorised access to the calibration and configuration data of the measuring transmitter is effectively prevented by access codes. The instrument settings can be read at any time without entry of an access code.
- **Alarm function:**
Continuous violation of the limit settings or temperature sensor failure will activate an alarm. This condition is indicated by an LED on the control panel and via a switched output. The alarm contact has been designed as a fail-safe switch, i.e. the alarm condition will be immediately signalled in case of a power failure. The alarm contact is also activated by internal errors (see 8.2).
- **Data protection:**
The instrument configuration is retained even after a power failure.
- **Immunity to interference:**
This instrument is protected against interference, such as pulse-shaped transients, high frequency and electrostatic discharges, according to the applicable European standards. This is only valid, however, for an instrument connected according to the notes in these operating instructions.

3 Description

3.1 Areas of application

The measuring transmitter Liquisys CLM 221 is suitable for measuring and control tasks in the following areas of application:

- Water treatment
- Ultrapure water monitoring
- Ion exchangers
- Reverse osmosis
- Cooling water desalination

3.2 Measuring system

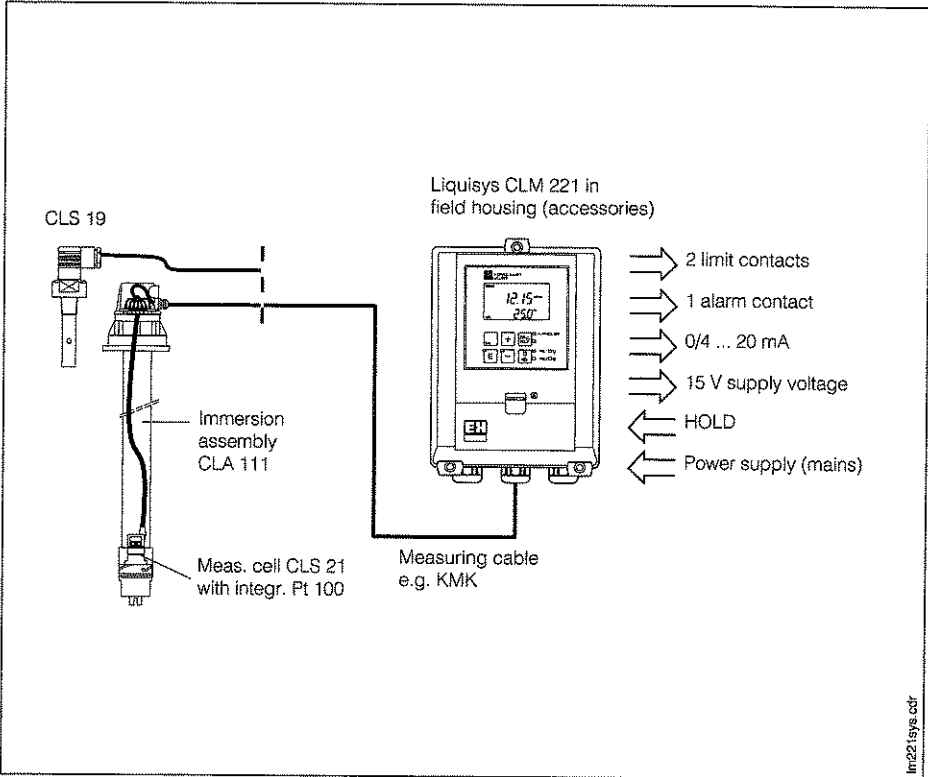

Fig. 3.1 Example of a complete measuring system

A typical measuring system consists of:

- a conductive conductivity measuring cell with an integrated temperature sensor Pt 100
- an additional temperature sensor Pt 100 if used with conductive conductivity measuring cells without an integrated temperature sensor
- an appropriate conductivity measuring cable
- the measuring transmitter Liquisys CLM 221 as a panel-mounted instrument or with the field housing (accessories)

**Note:**

Connection of inductive conductivity measuring cells and 4-electrode measuring cells to the CLM 221 is not possible.

3.3 Important features

- 10 conductivity measuring ranges from 0 ... 2.000 $\mu\text{S}/\text{cm}$ to 0 ... 200.0 mS/cm
- 2 resistance measuring ranges, 0 ... 20.00 $\text{M}\Omega\text{-cm}$ and 0 ... 2.000 $\text{M}\Omega\text{-cm}$
- Temperature measurement from -9.9 ... 125 $^{\circ}\text{C}$
- Easy to read, two-line display
- Simple configuration with only three keys
- Configuration protected by access code
- Quick calibration using the "CAL" key
- Limit contacter function with two switched outputs
- A switched output for alarm signalling in cases of limit violation or temperature sensor failure
- A current output with selectable measurement range, switchable between 0 ... 20 mA and 4 ... 20 mA proportional
- Automatic "hold" function to "freeze" the outputs during calibration and configuration
- "Hold" function can be controlled externally via a galvanically separated contact input using an auxiliary voltage

3.4 Instrument variants

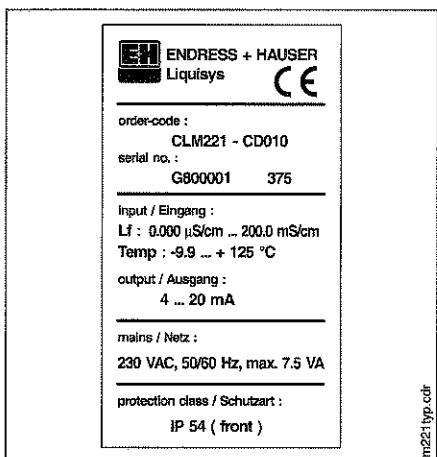
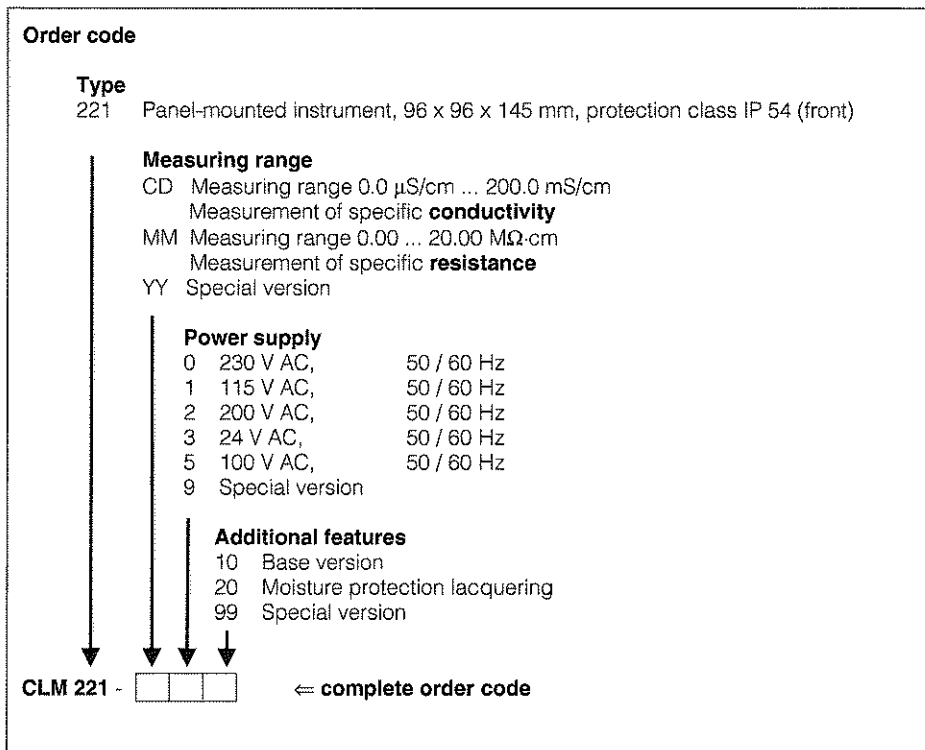

Using the order code on the nameplate of the instrument, you can identify the device variant and the mains supply type.

Fig. 3.2 Nameplate of Liquisys CLM 221

3.5 Accessories

Endress+Hauser offer a wide selection of matching conductivity measuring cells for the Liquisys measuring instruments which are designed for special applications. The following table gives a rough overview.

Overview: Conductive conductivity measuring cells with 2 electrodes

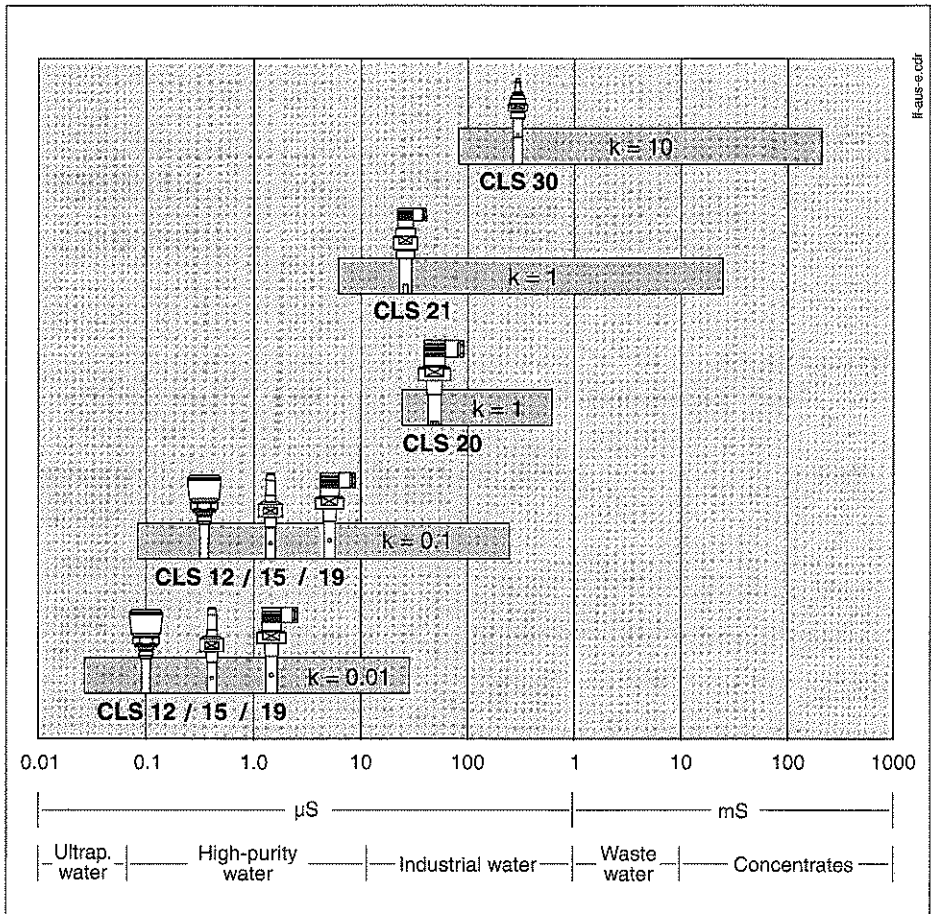

Fig. 3.3 Overview of conductive conductivity measuring cells with 2 electrodes from Endress+Hauser

Immersion assembly

Type	Features	Areas of application
Dipsys CLA 111	Immersion assembly with DN 100 flange, bayonet mounting for fast installation and removal of measuring cell, integration of Chemoclean measuring cell cleaning system is possible without modification	Open and closed containers and tanks

Field housing

Type	Features	Order number
Field housing	For installation of CPM/CLM 221 Dimensions (H x W x D): 204 x 155 x 215 mm Ingress protection IP 65, for wall and post mounting	50054413

Calibration solutions

Precision calibration solutions for conductivity, accuracy $\pm 0.5\%$ at 25 °C, bottle with 500 ml.

Type	Conductivity at 25 °C ¹⁾	Order number
CLY 11-A	74.0 μ S	50081902
CLY 11-B	149.6 μ S	50081903
CLY 11-C	1.406 mS	50081904
CLY 11-D	12.64 mS	50081905
CLY 11-E	114 mS	50081906

¹⁾ Values may vary due to manufacturing tolerances. The accuracy is given for the value specified on the bottle



4 Installation

4.1 Storage and transport

The packaging material used to store or transport the instrument must provide shock and moisture protection. Optimal protection is provided by the original packaging materials. Conformance with the ambient conditions (see technical data) must be assured.

4.2 Unpacking

Verify that the contents are undamaged. Inform the post office or freight carrier as well as the supplier of any damage.

Check that the delivery is complete and agrees with the shipping documents and your order:

- Quantity delivered
- Instrument type and version according to the nameplate (see chapter 3.4)
- Accessories
- Operating instructions
- Identification card(s)

Included in delivery:

- Flat gasket
- Mounting screws
- 3-, 9- and 14-pole terminal blocks

Save the original packaging in case the device must be stored or shipped at a later time.

If you have any questions, please consult your supplier or the Endress+Hauser sales office in your area (see back page of these operating instructions for addresses).

4.3 Mounting

Panel mounting of Liquisys CLM 221

The instrument is fastened using the mounting screws supplied with the instrument (see figure 4.1). The required mounting depth is approx. 175 mm.

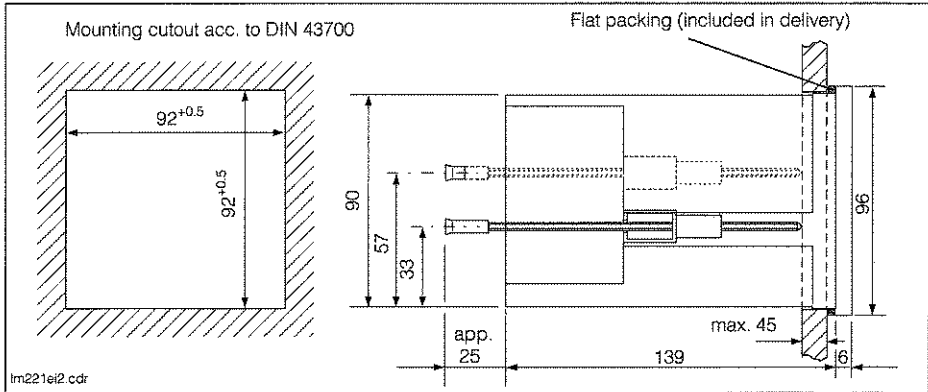

Fig. 4.1 Panel mounting of Liquisys CLM 221

Wall mounting of Liquisys CLM 221 with optional field housing

The brackets and screws for wall mounting are contained in the shipment. Install the brackets onto the rear of the instrument. The dimensions of the mounting holes are shown in figure 4.2.



Warning:

For installation in the field, weather protection cover VH3 is required (see mounting accessories). The protective cover is suitable for wall or post mounting.

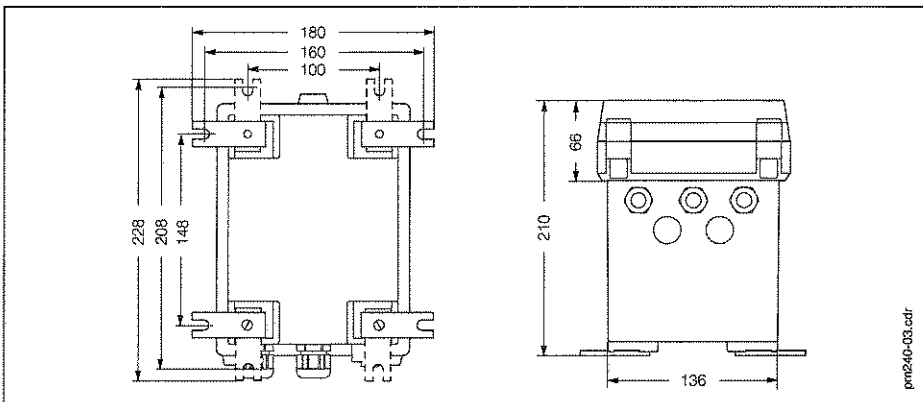
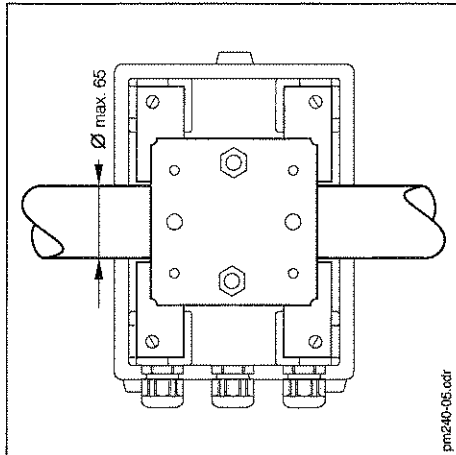

Fig. 4.2 Wall mounting of Liquisys CLM 221 with optional field housing

Post mounting of Liquisys CLM 221 with optional field housing



Additional requirements: post mounting kit (see mounting accessories). Install the post mounting kit on the rear of the instrument. Installation is possible on horizontal or vertical pipes. The maximum pipe diameter is 65 mm (see figure 4.3).

Fig. 4.3 Post mounting of Liquisys CLM 221 with optional field housing

Mounting accessories

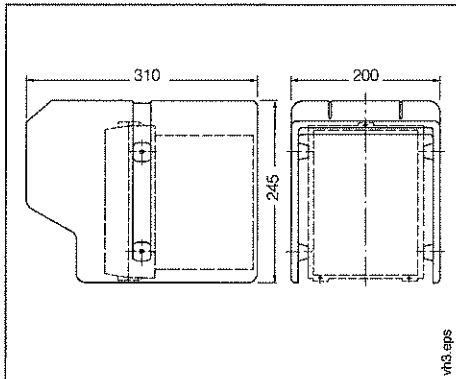

Weather protection cover VH3

Weather protection cover for installation on field housing.
 Dimensions: 245 x 200 x 310 mm (H x W x D)
 Material: plastic
 Order no.: 50003254

Post mounting kit

Retrofit kit for mounting the field housing on horizontal or vertical pipes (max. Ø 65 mm)
 Material: galvanised steel
 Order no. 50003244

Fig. 4.4 Weather protection cover VH3

4.4 Connection



Warning:

- The connection to the mains may only be performed by properly trained specialist personnel.
- The instrument must be grounded before start-up!
- A clearly identified mains disconnecting device must be installed close to the instrument..
- Before connecting the instrument to the mains, make sure the mains voltage matches the voltage rating on the nameplate.
- Live components can be touched through the vent slots in the housing and the openings on the rear of the housing. Do not insert tools, wires, etc., in these slots.

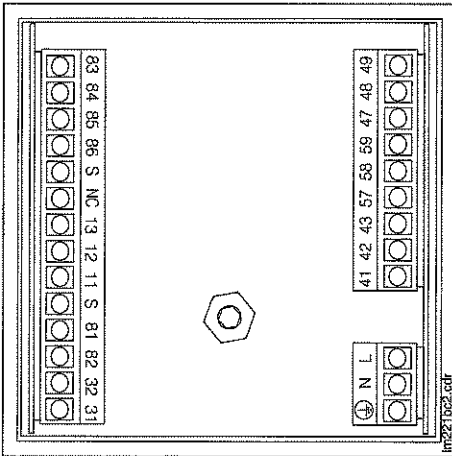

Instrument connections

Connections are carried out on the rear of the instrument

- for conductivity measuring cells, auxiliary supply voltage, temperature sensor, switched "hold" input and current output via the removable 14-pin terminal block,
- for the limit contactor relays and alarm contact via the removable 9-pin terminal block,
- for the power supply via the removable 3-pin terminal block.

The max. conductor cross section is 2.5 mm². See figure 4.6 for terminal assignments.

Fig. 4.5 Position and designations of the connections on the rear of the instrument

Connection diagram

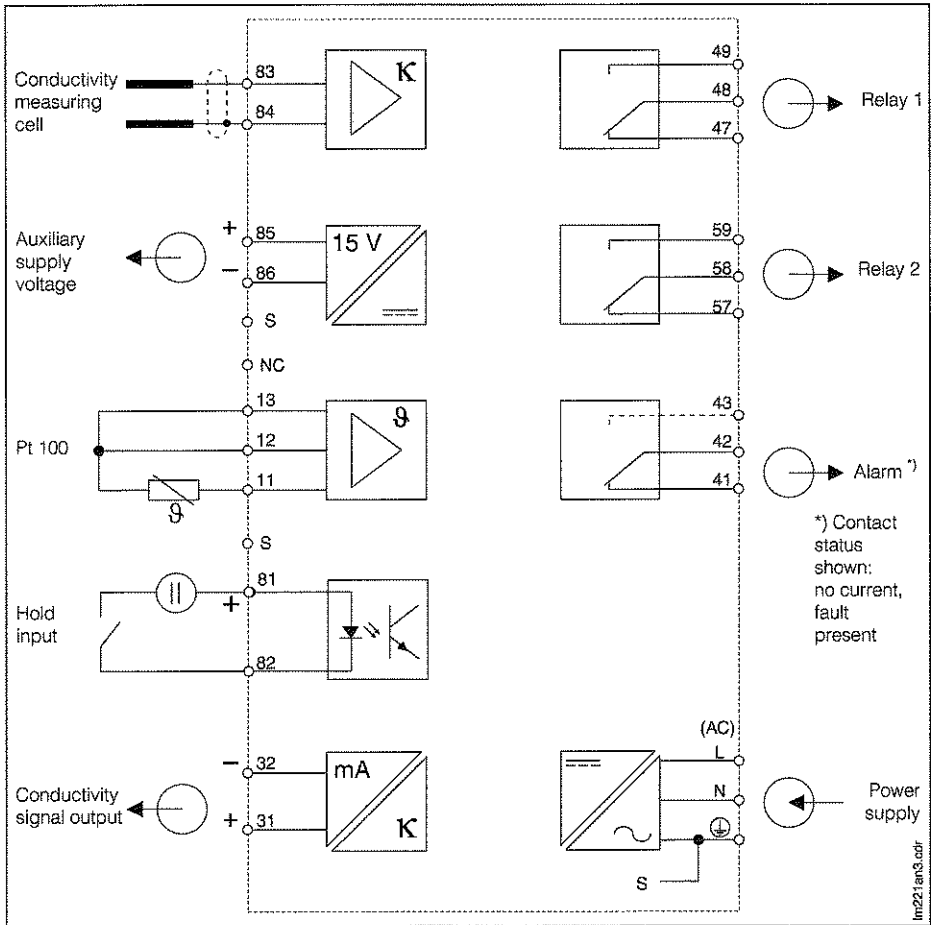

Fig. 4.6 Electrical connection of Liquisys CLM 221

Liquisys CLM 221

Connect the instrument according to figure 4.6.

Liquisys CLM 221 in field housing

Introduce the connecting cables through the glands in the field housing. Connect the instrument according to figure 4.6. Slide the instrument into the housing, exerting a slight pulling force on the cables to pull them out. Tighten the cable glands. Install the front panel and tighten the screws with a hexagon socket wrench.

Conductivity measuring cell connection

Conductivity measuring cells are connected via special multi-core, shielded measuring cables of types KMK or SMK (see table "Special measuring cables required"). Should it become necessary to extend the measuring cables, use junction box VS. Instructions for preparing the measuring cables are included with the cables.



Warning:

Connectors and terminals must be protected against humidity, otherwise faulty measurements will result!

Special measuring cables required for connection of conductivity measuring cells	
Measuring cell type	Cable (extension)
2-electrode measuring cell without temp. sensor Pt 100	SMK (+ VS + SMK)
2-electrode measuring cell with temp. sensor Pt 100	KMK (+ VS + KMK) or CYK 7 (+ VS + CYK 7)

Construction and preparation of SMK cable

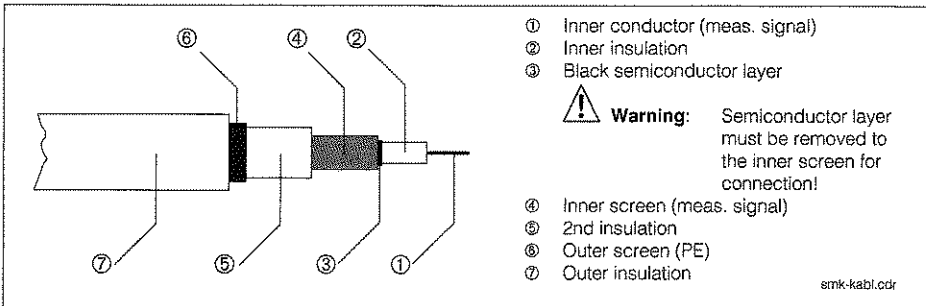

Fig. 4.7 Construction / preparation of special measuring cable SMK

Construction and preparation of KMK cable

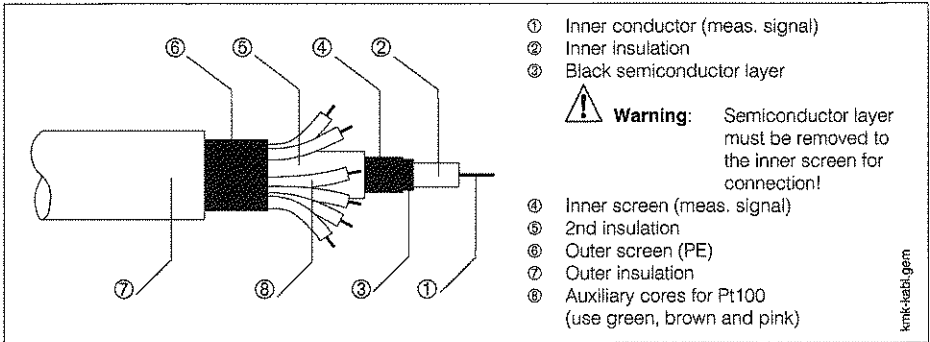

Fig. 4.8 Construction / preparation of special measuring cable KMK

Connection example with KMK cable

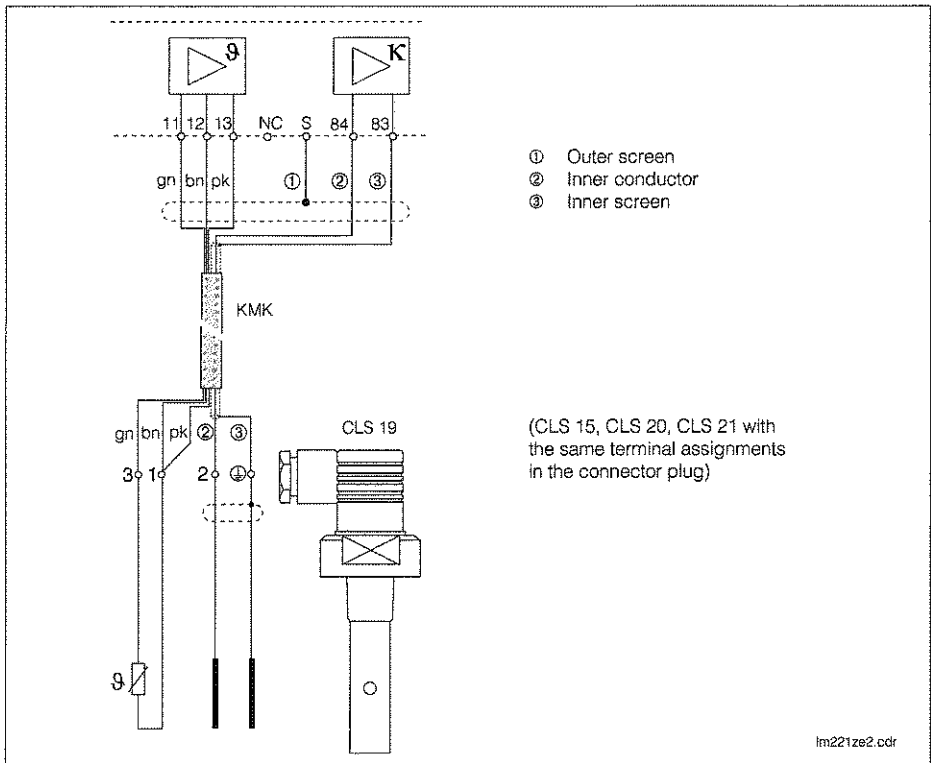

Fig. 4.9 Connection of measuring cells CLS 15, CLS 19, CLS 20 or CLS 21 with cable KMK

Construction and preparation of CYK 7 cable

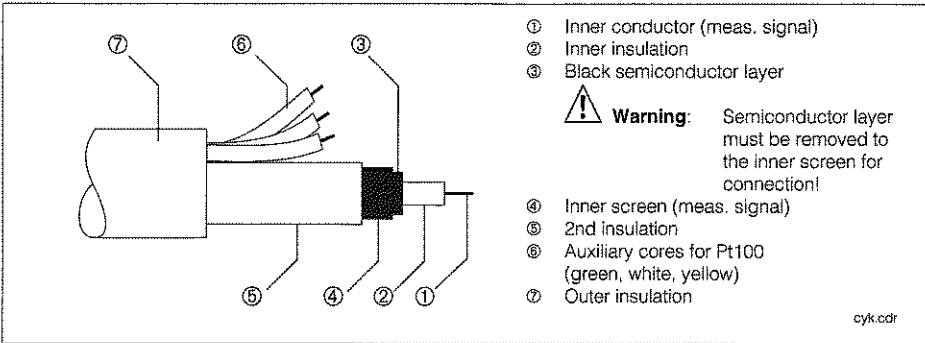

Fig. 4.10 Construction / preparation of special measuring cable CYK 7

Connection example with CYK 7 cable

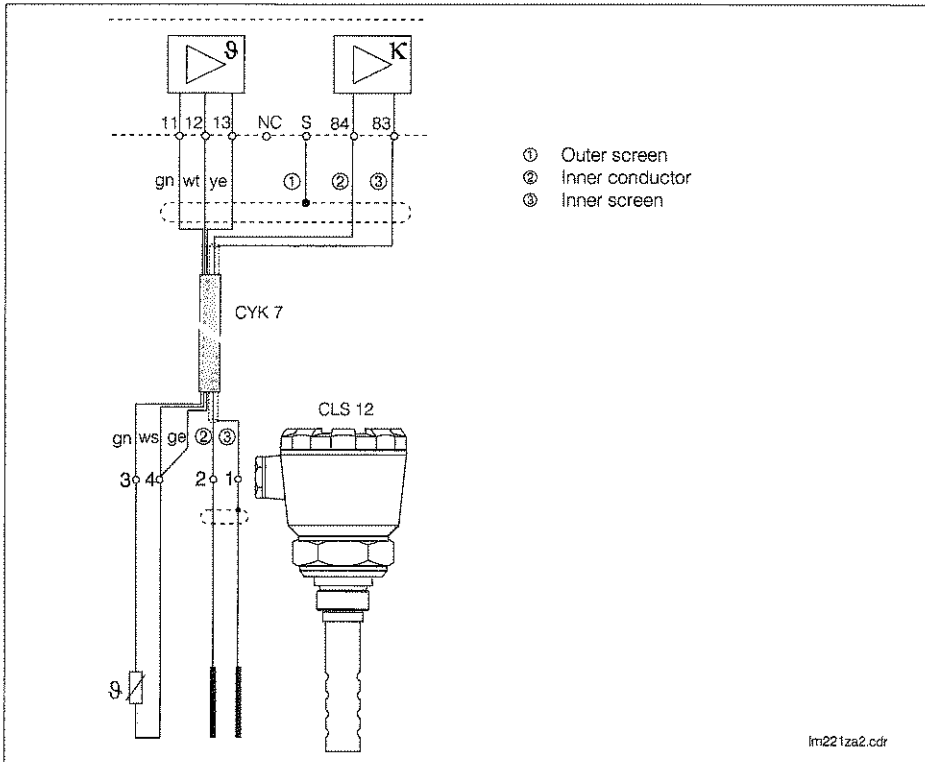

Fig. 4.11 Connection of measuring cell CLS 12 with cable CYK 7

Connection accessories

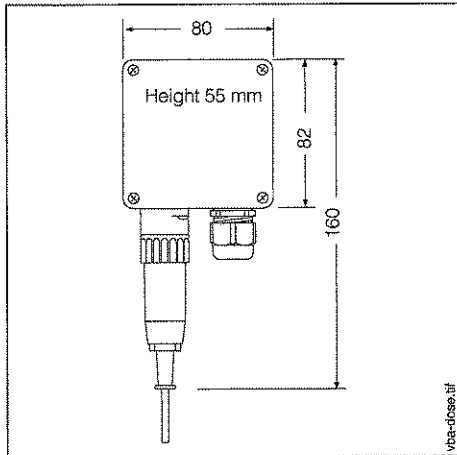

Fig. 4.12 Dimensions of junction box VS

Junction box VS

Junction box with cable gland and receptacle, including 7-pin SXP connector for plug-in connection between measuring cell and the connecting cable to the measuring instrument. Material: plastic; protection class: IP 65
Order no.: 50001054



Caution:

To avoid measuring errors caused by humidity bridges on the redox connecting line, please check desiccant bags regularly and replace if necessary (depending on the ambient conditions).

4.5 Packaging and disposal

Packaging

Packaging must provide shock and moisture protection. Optimal protection is provided by the original packaging materials.

Disposal



Note:

Electronic components to be disposed of are considered special waste!
Please observe local regulations for disposal!

5 First start-up

5.1 Measures before first power-up

**Note:**

Familiarise yourself with the operation of the measuring instrument before switching it on for the first time!

**Caution:**

Before power-up, check that all connections have been properly made! Make sure that the conductivity measuring cell is located in the medium to be measured or in an electrolyte. This ensures that a plausible value will be displayed.

**Warning:**

Before power-up make sure that there is no risk of damage to the system the instrument is a part of; for example, due to valves or pumps that might operate in an uncontrolled manner, etc.

5.2 Power-up, factory settings

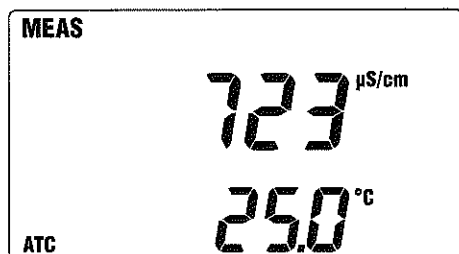

After power-up, the instrument performs a self-test and then starts up in the measuring mode. If the display is similar to figure 5.1, the instrument is functioning properly.

The measured values shown on the display may be different.

Now the instrument can be configured and calibrated for the first time.

Fig. 5.1 Display after power-up and completion of self-test

The following factory settings are active when the instrument is powered up for the first time:

Type of measurement	Instrument variant CD: conductivity measurement Instrument variant MM: resistance measurement
Type of temperature compensation	Linear with reference temperature 25 °C
Temperature compensation	Automatic (ATC on)
Limit value 1	5 % of upper value of measuring range selected, minimum contact without delay (switched on when value drops below limit 1)
Limit value 2	95 % of upper value of measuring range selected, maximum contact without delay (switched on when limit 2 is exceeded)
Limit function	Switched on, normally closed contacts
Measuring range	Instrument variant CD: conductivity measuring range no. 5: 0 ... 2000 μS/cm Instrument variant MM: resistance measuring range no. 10: 0 ... 20.00 MΩ·cm
0 / 4 ... 20 mA current output	4 ... 20 mA
Meas. value for 4 mA signal cur.	0 μS/cm, 0 mS/cm or 0 MΩ·cm depending on measuring range
Meas. value for 20 mA signal cur.	Upper range value of measuring range chosen



Note:

Refer to chapters 7.1 to 7.7 for all other factory settings.

5.3 First configuration and calibration

The measuring transmitter Liquisys CLM 221 is pre-configured as a conductivity measuring instrument or resistance measuring instrument at the factory (see chapter 3.4 "Instrument variants").

Change of basic configuration conductivity / resistance

To change the basic configuration 4 jumpers in the instrument have to be moved. Before starting the instrument has to be voltage-free. Detach screw on the rear of the housing and pull the instrument insert halfway out of the housing.



Warning:

Touch a grounded spot before touching parts of electronics. Otherwise the components could be damaged by static electricity.

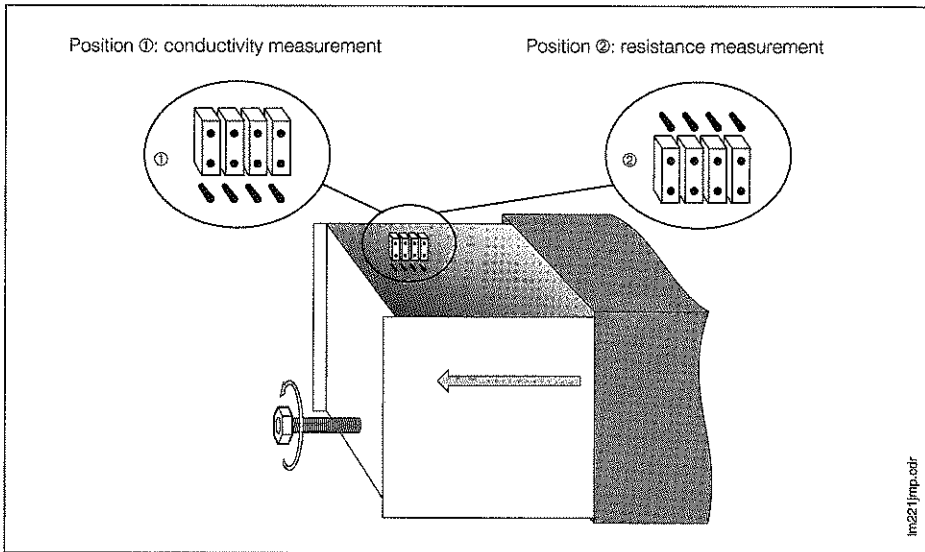

Fig. 5.2 Position of plug-in jumpers for basic configuration conductivity / resistance

For conductivity measurement (order variant CD) all 4 jumpers are in position ①, for resistance measurement (order variant MM) in position ② (see fig. 5.2).



Caution:

To avoid later confusions the nameplate has to be changed according to the change in the basic configuration.

Measuring range, calibration, further adjustments

First, you must set the measuring range according to the cell constant of the measuring cell type you have chosen as described in chapter 7.5.

Next calibrate the measuring transmitter as described in chapter 7.8.

Make any additional changes to the instrument settings as needed for your particular application. The following table will help you locate the corresponding chapter in this manual.

Chapters relevant to the configuration and calibration of the measuring transmitter	
Selection of measuring range / configuration of current output	☞ chapter 7.5
Type of temperature compensation linear / ultrapure water	☞ chapter 7.1
Set temperature compensation / calibrate Pt 100	☞ chapter 7.2
Configuration of limit contacters	☞ chapters 7.3, 7.4
Instrument configuration / alarm function	☞ chapter 7.6
Calibration of measuring transmitter / alarm delay setting	☞ chapter 7.7

5.4 Test

If the instrument proceeds into measurement mode after power-up and completing the self-test, it is working properly.

In order to check the alarm function as well as any connected alarm signalling device, the current supply can be interrupted for a moment. All configuration data will be maintained.

The limit contacter relays can be operated manually for function checks, maintenance work, etc. See chapter 6.6, Auto / manual mode of operation.

6 Operation

6.1 Operator interface

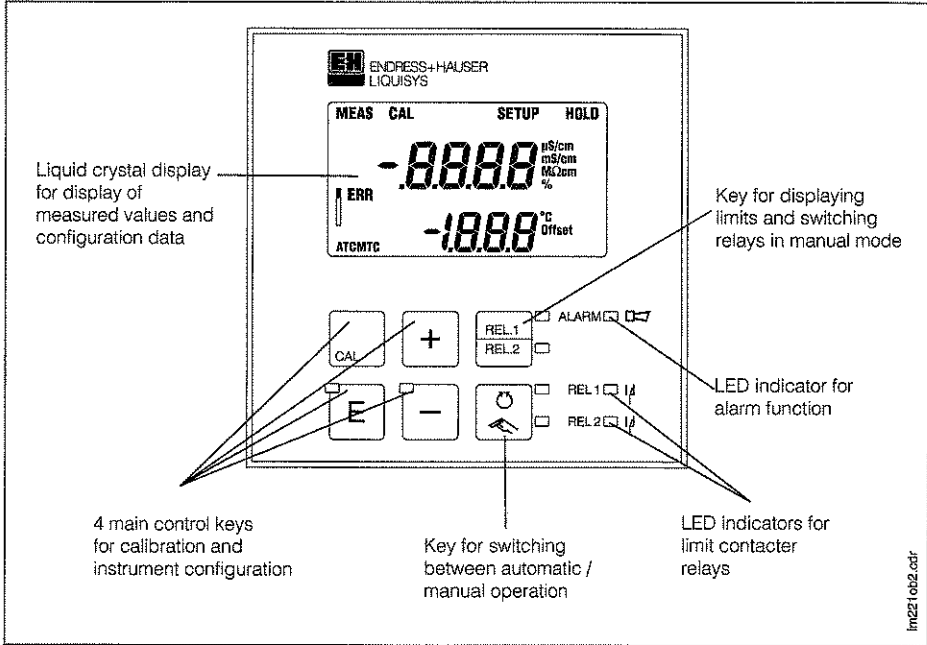

Fig. 6.1 Operating elements of Liquisys CLM 221

6.2 Display elements

LED indicators

- REL.1
 REL.2 Indication for relay controlled in "manual" mode (red LED).
- Indication of current operating mode: "auto" (green LED) or "manual" (yellow LED).
- REL.1 I/A Indicates the status of relays 1 and 2.
LED green: measured value is within permissible limits, relay is inactive.
LED red: measured value is outside of permissible limits, relay is active.
- Alarm indication for continuous limit violation, temperature sensor failure, AD converter overflow or system errors.

Liquid crystal display

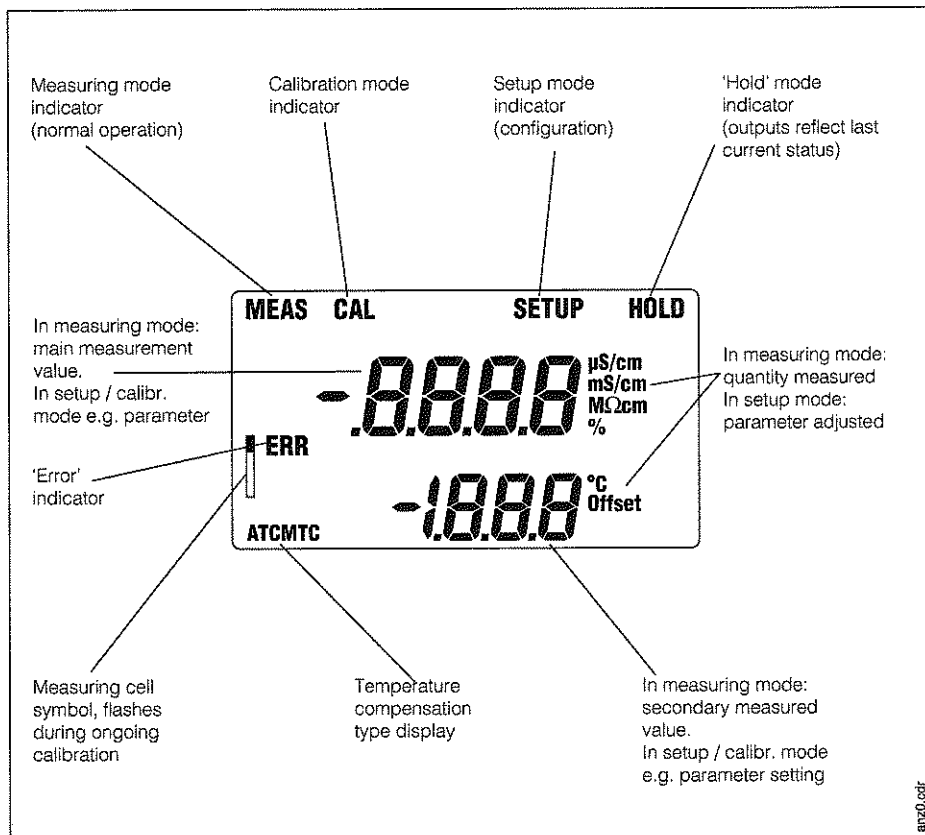

Fig. 6.2 Liquid crystal display of Liquisys CLM 221

6.3 Key functions



Quick calibration

After pressing the CAL key and entering the access code "11", the instrument shows the display for the first calibration step.
The CAL key is further used for controlling the entire calibration.



Setup

After pressing the E key and entering the access code "22", the instrument switches to the setup mode. The E key is further used for:

- selecting the individual functions in setup mode
- saving the data entered in setup mode
- starting calibration



In measuring mode: Relay operation in "manual" mode.
In setup mode: Setting of parameters and numerical values (the setting speed increases when the key is held down).

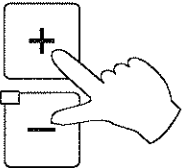

Note:

Push both keys simultaneously to return to the measuring mode.



- ☐ Displays the limits set for the relays in "auto" mode,
- ☐ switches between relay 1 and relay 2 in "manual" mode.



- ☐ Toggles the relays between the "auto" and "manual" modes.

6.4 Operating concept

Operating modes

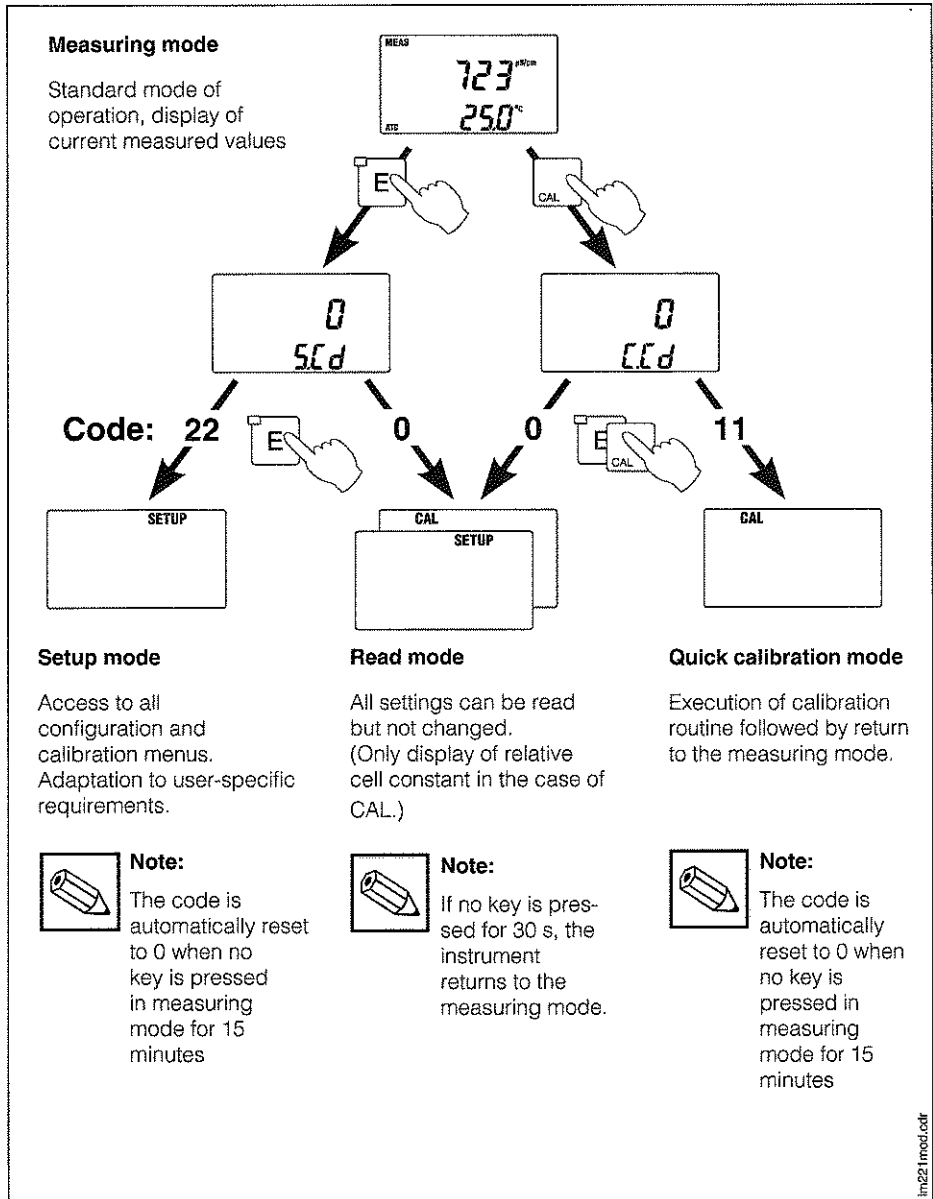

Fig. 6.3 Description of the four operating modes

Menu structure

The configuration and calibration functions are arranged in a menu structure by function groups.



Note:

See the fold-out back page of these operating instructions for an overview of the Liquisys menu structure.

The function groups are selected in the setup mode with the '+' and '-' keys. The 'E' key is used to move from one function to the next within a function group. The '+' and '-' keys are used for option selection and editing.

Selections must be confirmed by pressing the 'E' key. Pressing the '+' and '-' keys at the same time terminates programming and accepts the changes made.



Note:

If a change is made but not confirmed by pressing the 'E' key, the previous setting is retained.

Changes outside the permissible adjusting range are rejected.

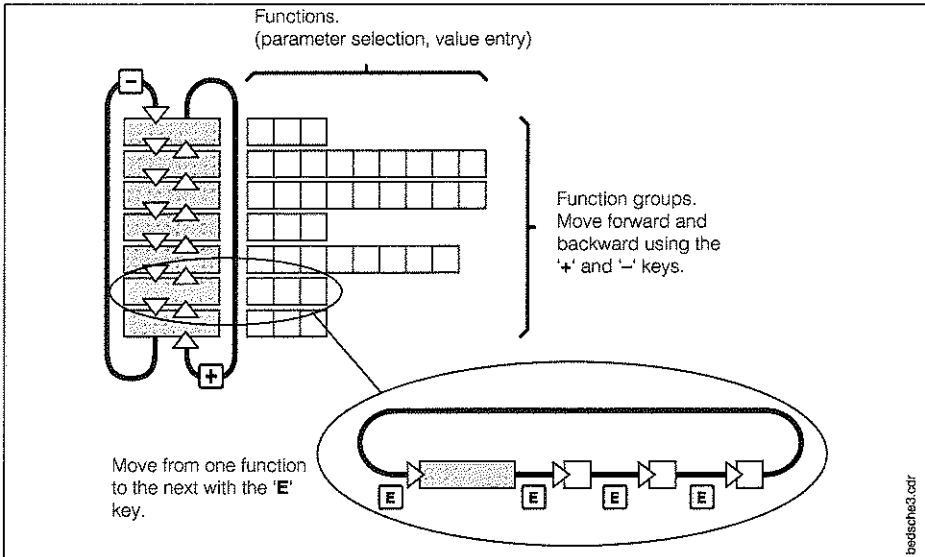

Fig. 6.4 Schematic representation of Liquisys menu structure

Hold function: "freezes" the outputs

The current output is "frozen" in the setup mode and during quick calibration, i.e. the last current value is constantly output. The display shows the "HOLD" message. During automatic operation, all contacts will go to their normal positions. Any alarm delay accumulated will be reset to '0'. This function can also be activated externally via a contact input (see chapter 4.4, "Connection").



Note:

If the hold function is to remain active even after a power failure, the hold contact input is to be used.

6.5 Operation example



Note:

Please refer to menu structure on fold-out back page.

Supposing the limit value for limit contacter 2 were to be set to 330 $\mu\text{S}/\text{cm}$ as the switching point using the min. function, you would proceed as follows:



Select the "Setup Code" field (S.Cd = Setup Code).

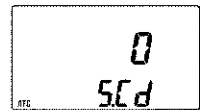

Enter code 22 to access the configuration mode.

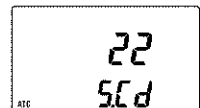

Confirm the code.

The instrument is now in setup mode, and the first function group is selected ("tc" = temperature compensation). The hold function is active.

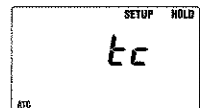

Select the "setpoint 2" function group (SP 2 = setpoint 2).

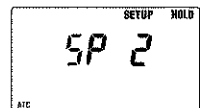



Select the "setpoint entry" function.



Change the setting, e.g. from 1900 to 330 µS/cm.



Confirm the entry.
The instrument advances to the next function.

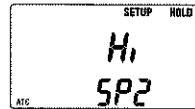

Change the factory setting of
"Hi" (upper limit = Max Function) to
"Lo" (lower limit = Min Function).

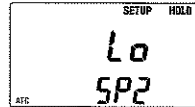

Confirm the setting.
The instrument advances to the next function
(HYS = hysteresis setting).



Return to the measuring mode by pressing
the '+' and '-' keys at the same time.
The hold function is deactivated.

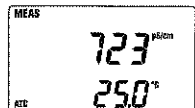

Select the "Setup Code" field.

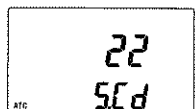



Change the code
(to any number) to block the access to the configuration function.

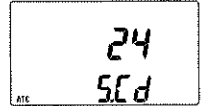

Confirm the (blocking) code entry.
The instrument returns to the measuring mode.

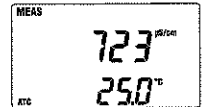
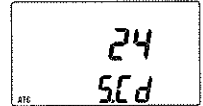

6.6 Auto / manual mode of operation

Automatic operation



In this mode of operation, the relays are controlled by the measuring transmitter.



The limit settings can also be displayed in the measuring mode with the relay shift key.
When this key is pressed, limit 1 is displayed for 2 seconds, then limit 2 for another 2 seconds. Then the display reverts to the current measured value.



Switching to manual operation

The instrument is switched to the manual mode by pressing the Auto / Manual key. In this mode, the relays are switched manually.
Press the "REL 1 / REL 2" key to toggle between the relays.



Note:

- The manual mode must be enabled by entering setup code "22".
- The current operating mode setting is retained even in the event of a power failure.
- The manual mode has precedence over an external hold request.

Relay operation

The relays can be controlled with the '+' and '-' keys.
The current status or value is shown on the second display line.

Switch on with '+', switch off with '-'. The relay status remains in effect until changed.

7 Instrument configuration

7.1 Temperature compensation type selection t_c

This function group is used to select the temperature compensation type and the temperature coefficients for process and calibration with linear temperature compensation. You can choose either linear or ultrapure water temperature compensation.



Note:

The ultrapure water temperature compensation can only be selected in conjunction with the following measuring ranges:

Measuring range 0:	0 ... 2.000 $\mu\text{S}/\text{cm}$ (cell constant 0.01 cm^{-1})
Measuring range 1:	0 ... 20.00 $\mu\text{S}/\text{cm}$ (cell constant 0.01 cm^{-1})
Measuring range 10:	0 ... 20.00 $\text{M}\Omega\cdot\text{cm}$ (cell constant 0.01 cm^{-1})
Measuring range 11:	0 ... 2.000 $\text{M}\Omega\cdot\text{cm}$ (cell constant 0.1 cm^{-1})

The temperature coefficient can only be selected in conjunction with the linear temperature compensation type.

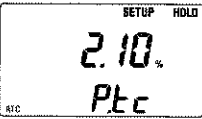
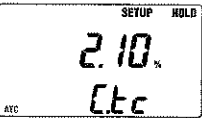
Field	Selection / range	Display	Info
Selection of temperature compensation type (Lin = linear compensation) (Pur = ultrap. water comp.) (tc = temperature compens.)	Lin Pur Default: Lin		Measuring ranges 0, 1, 10 and 11 only
for linear temperature compensation			
Entry of temperature coefficient for the process in measuring mode (P.tc = process temp. coeff.)	0.0 ... 10.00 %/K Default: 2.10 %/K		With linear temperature compensation only
Entry of temperature coefficient to be used during calibration for computation. (C.tc = calibr. temp. coeff.)	0.0 ... 10.00 %/K Default: 2.10 %/K		With linear temperature compensation only

7.2 Selection of temperature compensation 5Et °C

This function group is used to select the temperature compensation and to calibrate the Pt 100 sensor.

Field	Selection / range	Display	Info
Switches the automatic temperature compensation ATC on or off. (on ATC = ATC switched on) (oFF ATC = ATC switched off)	on ATC oFF ATC Default: on		
for ATC "on"			
Adapts the Pt100 signal by an offset value (when using various quality classes). The actual measured value is shown on the small display.	-5 ... +5 °C relative to absolute value (ATC operation only) Default: 0 °C		
for ATC "off" (MTC)			
Entry of a process temperature value for manual temperature compensation. (P.°C = process temperature)	-9.9 ... 125 °C Default: 25 °C		
Entry of a calibration temperature value for manual temperature compensation. (C.°C = calibration temperature)	-9.9 ... 125 °C Default: 25 °C		



Note:

When switching between manual and automatic temperature compensation (on Atc / oFF Atc), the temperature offset is reset to the default value (0 °C).





7.3 Limit contacter configuration 5P 1, 5P 2



These function groups are used to configure the limit parameters. Programming for limits 1 and 2 is identical; therefore both function groups are covered by this description.

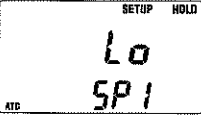

Note:

If limit contacters 1 and 2 are disabled in the "Controller Relays" function group, the "Setpoint 1" and "Setpoint 2" function groups are not displayed.

Field	Selection / range	Display	Info
Entry of limit contacter setpoint for limit 1 / 2 (SP1 = setpoint 1= limit 1) (SP2 = setpoint 2= limit 2)	0 ... 2.000 μ S/cm : 0 ... 2.000 M Ω .cm depending on measuring range Defaults: Limit 1: 5 % of upper range value Limit 2: 95 % of upper range value	 	
Determines the contact function (Lo = MIN contact, activated when value drops below limit) (Hi = MAX contact, activated when limit is exceeded) (SP 1 / 2 = setpoint 1 / 2)	Lo Hi Default: Limit 1: Lo Limit 2: Hi	 	All combinations of the two contacts, Lo/Lo, Lo/Hi, Hi/Lo and Hi/Hi, can be selected.

Field	Selection / range	Display	Info
<p>Determines the hysteresis for limit contacter 1 / 2</p> <p>MAX function: the contact is activated when the limit is exceeded and deactivated when the value drops below the limit minus hysteresis.</p> <p>MIN function: the contact is activated when the value drops below the limit and deactivated when the value exceeds the limit plus hysteresis. (HYS = hysteresis)</p>	<p>0...0.200 μS/cm : 0...0.200 MΩcm depending on measuring range selected</p> <p>Default: Limit 1 / 2: 1 % of upper meas. range value</p>		
<p>Sets the pickup delay for limit contacter relay 1 / 2</p> <p>(On.d = On delay = pickup delay)</p>	<p>0 ... 2000 s</p> <p>Default: 0 s</p>		
<p>Sets the dropout delay for limit contacter relay 1 / 2</p> <p>(OF.d = Off delay = dropout delay)</p>	<p>0 ... 2000 s</p> <p>Default: 0 s</p>		

Characteristic of limit contacters

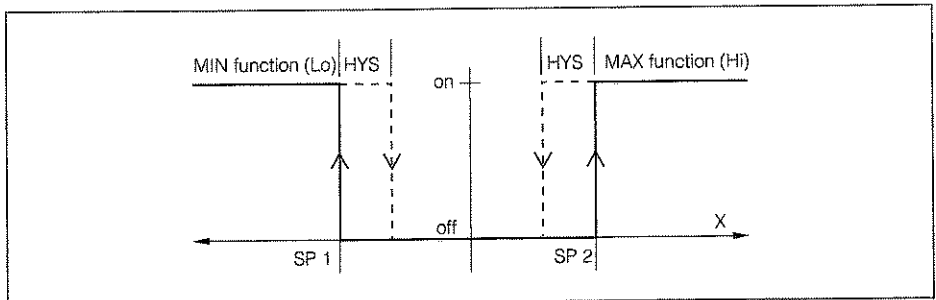

Fig. 7.1 Characteristic of limit contacters (HYS = hysteresis, SP = setpoint)

7.4 Limit contacter relay configuration *[ntr]*

This function group is used to activate / deactivate the limit contacter relays and to determine the relay function (normally closed / normally open contacts). These settings affect both limit contacter relays.

Field	Selection / range	Display	Info
Switches the limit contacter function on or off (on = limit contacter on) (oFF = limit contacter off) (L.Ct = limit contacter)	on oFF Default: on		If OFF is selected, the following function is not displayed.
Toggles between normally closed and normally open function (rEL = relay function) (dEEEn = deenergized, normally closed contact) (En = energized, normally open contact)	dEEEn En Default: dEEEn		



Note:

If the limit contacter function is disabled (L.Ct oFF), the two function groups for limit contacter configuration (SP 1 / SP 2) are not displayed.

7.5 Measuring range / current output selection ^{rng}

This function group is used to determine the measuring range and the current output range.

Field	Selection / range	Display	Info
<p>Selection of measuring range depending on cell constant of measuring cell connected</p> <p>Large display: upper measuring range value</p> <p>Small display: cell constant of measuring cell</p>	<p>URV Cell const.</p> <p>Conductivity</p> <p>2.000 $\mu\text{S}/\text{cm}$ 0.01 20.00 $\mu\text{S}/\text{cm}$ 0.01 20.00 $\mu\text{S}/\text{cm}$ 0.10 200.0 $\mu\text{S}/\text{cm}$ 0.10 200.0 $\mu\text{S}/\text{cm}$ 1.00 2000 $\mu\text{S}/\text{cm}$ 1.00 5000 $\mu\text{S}/\text{cm}$ 1.00 20.00 mS/cm 1.00 200.0 mS/cm 1.00 200.0 mS/cm 10.0</p> <p>Resistance</p> <p>20.00 $\text{M}\Omega\text{-cm}$ 0.01 2.000 $\text{M}\Omega\text{-cm}$ 0.10</p> <p>Default: 2000 $\mu\text{S}/\text{cm}$ or 20.00 $\text{M}\Omega\text{-cm}$</p>		<p>URV = upper range value</p>
<p>Toggles the lower limit of the current output between 0 and 4 mA</p> <p>(out = current output)</p>	<p>0 – 20 4 – 20</p> <p>Default: 4 – 20 mA</p>		
<p>Entry of conductivity or resistance value for 0 or 4 mA (depending on setting for lower limit).</p> <p>(r. 0 = value for 0 mA in case of 0-20 mA) (r. 4 = value for 4 mA in case of 4-20 mA)</p>	<p>Value range corresponds to measuring range selected</p> <p>Default: 0 $\mu\text{S}/\text{cm}$ or 0 mS/cm or 0 $\text{M}\Omega\text{-cm}$</p>		<p>The difference to the value at 20 mA must be at least 20 % of the upper range value.</p>
<p>Entry of conductivity or resistance value for 20 mA.</p> <p>(r.20 = value for 20 mA)</p>	<p>Value range corresponds to measuring range selected</p> <p>Default: upper range value</p>		



Note:

Whenever the measuring range is switched, the parameters "temperature offset value" and "cell constant" are reset to their defaults.

The values for limits 1 + 2, the hysteresis of limits 1 + 2 and the measuring range assignment of the current output are only reset to their defaults when the upper value of the measuring range changes as the result of selecting another measuring range.

7.6 General instrument configuration *[onF]*

This function group comprises the general instrument configuration parameters. Here, you can configure the alarm relay output, enter the line resistance of the sensor connecting cable for purposes of compensation and reset the instrument to the factory settings (defaults).

Field	Selection / range	Display	Info
<p>Determines the alarm delay for the alarm contact</p> <p>(AL.d = alarm delay)</p>	<p>0 ... 2000 s</p> <p>Default: 0 s</p>		
<p>Defines the alarm relay as a steady or fleeting contact.</p> <p>(StdY = steady contact)</p> <p>(FLet = fleeting contact)</p> <p>AL.C = alarm contact)</p>	<p>StdY</p> <p>FLet</p> <p>Default: StdY</p>		<p>When defined as a "fleeting contact", the closing time is approx. 1 s.</p>
<p>Entry of line resistance of sensor connecting cable</p> <p>(L.Ad = line adjustment = line resistance adjustment)</p>	<p>0 ... 100.0 Ω</p> <p>Default: 0 Ω</p>		
<p>Use this function to restore the factory settings for all functions.</p> <p>(no = do not restore)</p> <p>(YES = restore)</p> <p>(dEF = default = factory settings)</p>	<p>no</p> <p>YES</p> <p>Default: no</p>		<p>Warning: All user settings will be overwritten by the factory defaults!</p>

**Warning:**

All user settings are lost if the instrument is reset to the factory default settings! This includes the settings in the other function groups!

7.7 Calibration of measuring transmitter *CAL Con*, *CAL RES*

This function group is used to calibrate the measuring transmitter.

The calibration can be performed in two different ways:

- By measurement in a calibration solution with a known conductivity.
- By entry of the exact cell constant of the conductivity measuring cell.

**Note:**

In the case of quick calibration with 'CAL', that calibration function is used which has been selected in the "Calibration" setup menu.

**Caution:**

If the calibration is aborted by pressing the '+' and '-' keys at the same time (return to measuring mode) or if the calibration is faulty, the previous calibration data will continue to be used. A calibration error is indicated by an "ERR" and a flashing measuring cell symbol on the display.
Repeat the calibration!



**Note:**

Errors during calibration can have the following causes:

- The computed cell constant lies outside of the valid calibration range of 80 ... 120 % of the default cell constant.
- The conductivity of the calibration solution is below 40 % of measuring range final value.
- The temperature of the calibration solution does not match the calibration temperature value in the case of manual temperature compensation (Atc OFF, see chapter 7.2).

Automatic calibration using a calibration solution with a known conductivity

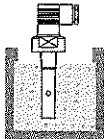
For selection of suitable calibration solutions see chapter 3.5 "Accessories"

Description	Display	Info
<p>Set the display to 'AUtO' for automatic calibration and confirm by pressing the E key.</p>		<p>Manual temperature compensation (Atc OFF): Make sure that the temperature of the calibration solution matches the calibration temperature value entered (see chapter 7.2).</p>
<p>Start of automatic calibration (beginning of quick calibration)</p>		
<p>Place the measuring cell in the calibration solution.</p>	 <p style="text-align: right; font-size: small;">kal. loss: cdf</p>	
<p>The current measured value is displayed and can be changed with the '+' and '-' keys.</p>		
<p>Confirm with 'CAL' or 'E'. Now the actual cell constant is computed and displayed as a percentage of the nominal cell constant.</p>		<p>If the computed cell constant lies outside of the valid calibration range of 80 ... 120 %, the ERR symbol appears and the measuring cell symbol flashes.</p>

Manual calibration by entry of exact cell constant of measuring cell

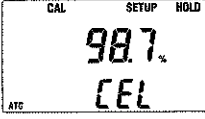
Description	Display	Info
<p>To calibrate by entering the exact cell constant, set the display to 'Edit' and confirm by pressing the E key.</p>		
<p>Start of manual calibration (beginning of quick calibration)</p>		
<p>Enter the exact cell constant of the measuring cell used in % of the nominal cell constant and confirm by pressing the E key.</p>		

8 Diagnostics

**Warning:**

Alarm signalling devices must have an independent power supply to permit alarm signalling in the event of a power failure!

8.1 Alarm

An alarm condition exists when the measured value

- exceeds the upper limit or
 - stays below the lower limit
- for a period which exceeds the alarm delay setting.

Effect:

- Alarm LED is on
- Alarm contact (41 / 42) is closed

8.2 Errors

Editing error

If values outside of the permissible value range are entered when editing a configuration setting, the "ERR" symbol on the display flashes briefly.

Temperature error

A temperature error is signalled when

- the temperature sensor cable is defective, or
- when a temperature is measured that lies outside the measuring or ATC range.

Effect:

- Alarm LED is on
- Alarm contact (41 / 42) is closed
- Symbol "ERR" is displayed
- Symbol "ATC" flashes on the display

**Note:**

Temperature error monitoring only takes place when the temperature measurement is enabled.

System errors

Internal communication errors lead to the display of a system error. The message "Err." and an one-digit error code flash on the main parameter display field.

- 1: EEPROM error
- 2: Internal communication error

Effect:

- Alarm LED is on
- Alarm contact (41 / 42) is closed
- Hold function is activated

If the system error cannot be eliminated by switching the power supply to the instrument off and back on, the instrument must be sent to the competent Endress+Hauser sales agency for servicing.

Error message in the event of AD converter overflow

Effect:

- Symbol "ERR" is displayed
- Alarm LED is on
- Alarm contact (41 / 42) is closed

To eliminate the error, check calibration, offset setting and measuring input wiring.

8.3 Instrument test

In the event of a problem, you can check by means of equivalent resistances or a conductivity simulator whether the problem is caused by the measuring cell or cable or the instrument itself.

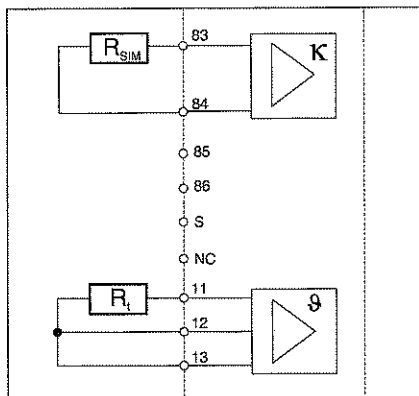

Fig. 8.1 Connection of resistances for instrument testing

Resistance R_t for temperature simulation

Display	Resistance R_t
approx. 25 °C	108 Ω

Resistances R_{SIM} for conductivity simulation

Display	Cell constant k	Resistance R_{SIM}
10 $\mu\text{S/cm}$	0.01 cm^{-1}	1 $\text{k}\Omega$
	0.1 cm^{-1}	10 $\text{k}\Omega$
	1 cm^{-1}	100 $\text{k}\Omega$
100 $\mu\text{S/cm}$	0.1 cm^{-1}	1 $\text{k}\Omega$
	1 cm^{-1}	10 $\text{k}\Omega$
1000 $\mu\text{S/cm}$	1 cm^{-1}	1 $\text{k}\Omega$
10 mS/cm	1 cm^{-1}	100 Ω
	10 cm^{-1}	1 $\text{k}\Omega$
100 mS/cm	10 cm^{-1}	100 Ω

Resistances R_{SIM} for simulation in $\text{M}\Omega$ range

Display	Cell constant k	Resistance R_{SIM}
10 $\text{M}\Omega\text{-cm}$	0.01 cm^{-1}	100 $\text{k}\Omega$
1 $\text{M}\Omega\text{-cm}$	0.1 cm^{-1}	100 $\text{k}\Omega$



Note:

For correct display, a measuring range matching the display value and cell constant must be selected in the "measuring range / current output" function group (see chapter 7.5).

8.4 Possible faults in measuring mode and remedy

Cause	Analysis / remedy
No display	
No power	Check power supply and conn. terminals
Fuse blown	Check fuse (see chapter 9.3)
Power supply unit defective	Send in unit for repair
Continuous "000" display	
Measuring cell defective	Check measuring cell, replace if necessary
Measuring line interrupted	Check cable, plug connectors and boxes
Continuous "Or" display (Over range)	
Meas. range or cell constant selected too small	Check meas. range and cell constant
Short in meas. cell or cable	Check cable and cell for short circuit
Display deviates from reference measurement	
Meas. range or cell constant incorrect	Check meas. range and cell constant
Incorrect ATC setting	Check ATC setting
Instrument calibrated incorrectly	Calibrate instrument
Measuring cell soiled	Clean measuring cell
Pt 100 or line defective	Check temperature sensor
Measured value fluctuates	
Measuring cable influence	Ground outer screen
Power supply cable influence	Use mains filter
Current output influence	Use screened line
Interference voltage in medium	Ground medium / assembly / tubing
PE not connected	PE must be connected

9 Maintenance and service

9.1 Cleaning

Use a soft cloth and soap solution to clean the front of the field housing and the membrane keyboard.

**Caution:**

Even if the instrument becomes very dirty (e.g. from paint or varnish) do not use aggressive cleaning agents such as thinner or acetone!

9.2 Maintenance of conductivity measuring cells

Depending on the composition of the measuring solution, the suspended matter it contains and the flow rate of the medium, there is always a risk that the electrodes in the measuring cell may become soiled during continuous measurement, which may result in more or less inaccurate measurement. The measuring cell should therefore be checked for soiling on a regular basis and cleaned if necessary to ensure trouble-free operation.

Removing deposits

- Thick deposits of carbonates or similar electrically non-conductive coatings are likely to result in significantly lower measured values.
Following mechanical pre-cleaning, such deposits can normally be removed quite easily with hydrochloric acid (and a brush).
- Organic soiling can be removed with strong oxidising agents and/or fat solvents, depending on the degree of soiling.
- If the measuring cells are used in CIP applications for media separation, the risk of electrode soiling is very low since coatings cannot form due to the constant changes from base to acid and vice versa.

**Warning:**

Observe the applicable local regulations for the handling of acids and other chemicals!



9.3 Repair

Replacing a blown fuse

Disconnect the instrument from the power source. Loosen the screw on the rear of the instrument and pull the plug-in unit out of the housing halfway. The fuse is located on the right board between the transformer and the rear of the instrument.

Further repairs

All further repairs may only be carried out directly by the manufacturer or through the Endress+Hauser service organisation. An overview of the Endress+Hauser service network can be found on the back page of these operating instructions.

10 Appendix

10.1 Technical data

Conductivity measurement

Display and measuring ranges (cell constant)

Range 0	0.000 ... 2.000 $\mu\text{S/cm}$ (0.01 cm^{-1})
Range 1	0.00 ... 20.00 $\mu\text{S/cm}$ (0.01 cm^{-1})
Range 2	0.00 ... 20.00 $\mu\text{S/cm}$ (0.1 cm^{-1})
Range 3	0.0 ... 200.0 $\mu\text{S/cm}$ (0.1 cm^{-1})
Range 4	0.0 ... 200.0 $\mu\text{S/cm}$ (1.0 cm^{-1})
Range 5	0 ... 2000 $\mu\text{S/cm}$ (1.0 cm^{-1})
Range 6	0 ... 5000 $\mu\text{S/cm}$ (1.0 cm^{-1})
Range 7	0.00 ... 20.00 mS/cm (1.0 cm^{-1})
Range 8	0.0 ... 200.0 mS/cm (1.0 cm^{-1})
Range 9	0.0 ... 200.0 mS/cm (10 cm^{-1})

Measured value resolution . . . 0.001 $\mu\text{S/cm}$... 0.1 mS/cm (depending on measuring range)

Deviation of indication ¹⁾ max. 0.5 % of URV

Reproducibility ¹⁾ max. 0.2 % of URV

Reference temperature +25 °C

Calibration range 80 ... 120 %

Signal output

Current range 0 / 4 ... 20 mA, galvanically separated

Measurement deviation ¹⁾ 0.75 % of URV

Load max. 500 Ω

Output range adjustable, $\Delta 20$... $\Delta 100$ % of URV

Resistance measurement

Display and measuring ranges (cell constant)

Range 10	0.10 ... 20.00 $\text{M}\Omega\text{-cm}$ (0.01 cm^{-1})
Range 11	0.010 ... 2.000 $\text{M}\Omega\text{-cm}$ (0.1 cm^{-1})

Measured value resolution (range 10 / 11) 0.01 $\text{M}\Omega\text{-cm}$ / 0.001 $\text{M}\Omega\text{-cm}$

Deviation of indication ¹⁾ max. 0.5 % of URV

Reproducibility ¹⁾ max. 0.2 % of URV

Signal output

Current range 0 / 4 ... 20 mA, galvanically separated

Measurement deviation ¹⁾ 0.75 % of URV

Load max. 500 Ω

Output range adjustable, $\Delta 20$... $\Delta 100$ % of URV

Temperature measurement

Temperature sensor Pt 100

Measuring range / ATC range -9.9 ... +125 °C

Measured value resolution 0.1 °C

Deviation of indication ¹⁾ max. 1.0 % of MR

¹⁾ Acc. to DIN IEC 746 part 1, for nominal operating conditions

Limit functions

Function	limit contactor
Switching hysteresis	0 ... 10 % of URV
Pickup / dropout delay	0 ... 2000 s

Alarm function

Function (switchable)	steady contact / fleeting contact
Alarm delay	0 ... 2000 s

Electrical data and connections

Power supply	110 / 230 V AC, +10 / -15 %
Mains frequency	48 ... 62 Hz
Current consumption	max. 7.5 VA
Auxiliary supply voltage	
Output voltage	15 V ± 0.6 V
Output current	max. 10 mA
Contact outputs	potential-free changeover contacts
Switching current	
With ohmic load (cosφ = 1)	max. 5 A
With inductive load (cosφ = 0.4)	max. 3 A
Switching voltage	max. 250 V AC, 30 V DC
Switching power	
With ohmic load (cosφ = 1)	max. 1250 VA AC, 150 W DC
With inductive load (cosφ = 0.4)	max. 500 VA AC, 90 W DC
	0 / 4 ... 20 mA, galvanically separated
Isolation voltage, signal output	max. 2500 VRMS
Terminals	plug-in terminal blocks, 3, 9 and 14 poles
Conductor cross section	max. 2.5 mm ²
Mains fuse	fine wire fuse, medium, 250 V / 1 A

General technical data

Measured value display	LC display, two lines, 4 and 3½ digits with status symbols
Electromagnetic compatibility (EMC)	
Emission	acc. to EN 50081-1
Immunity	acc. to EN 50082-1
Nominal operating conditions	
Ambient temperature	0 ... +50 °C
Relative humidity	10 ... 95 %, non-condensing
Voltage supply AC	110/230 V AC +10 / -15 %
Frequency	48 ... 62 Hz
Limit operating conditions	
Ambient temperature	-10 ... +60 °C
Temperature for storage and transport	-25 ... +65 °C

Physical data

Dimensions

Housing for panel mounting (H x W x D)	96 x 96 x 145 mm
Field housing (H x W x D)	204 x 155 x 215 mm

Weight

Liquisys CLM 221 (housing for panel mounting)	max. 0.7 kg
Liquisys CLM 221 with field housing	max. 2.3 kg

Protection class

Liquisys CLM 221 (housing for panel mounting)	IP 54 (front), IP 30 (housing)
Field housing	IP 65

Materials

Housing	polycarbonate
Front membrane	polyester, UV-resistant
Field housing	polycarbonate

10.2 Index

A		F	
Access code	3	Factory settings	19
Accessories	7	Field housing	5, 8
Alarm	3, 40	First power-up	19
Alarm delay	46	Function check	21
Alarm function	46	Fuse	44
Ambient temperature	46		
Areas of application	4	G	
Assemblies	8	General instrument configuration	36
ATC	31		
Auto / Manual mode of operation	29	H	
Automatic operation	29	Hold function	27
		Hysteresis	33
C			
Calibration	37	I	
Calibration error	37	Identification card	9
Cell constant	45	Immersion assembly	8
Cleaning	44	Immunity	46
Cleaning agents	44	Immunity to interference	3
Conductivity measuring cell	5	Important features	5
Conductivity measuring cell connection	14	Instrument configuration	30 - 39
Configuration	30 - 39	Instrument connections	12
Conformity statement	2	Instrument test	41
Connection	12	Instrument variants	6
Connection accessories	17	Instrument version	6
Connection diagram	13	Intended use	3
Connections	46	Isolation voltage	46
Contact function	32		
Contact outputs	46	J	
Current consumption	46	Junction box	17
D		K	
Data protection	3	Keys	22, 24
Description	4 - 8		
Dimensions	47	L	
Display	22	LEDs	22
Display range	45	Limit contactor	32
Disposal	17	Limit contactor configuration	34
Dropout delay	33	Limit functions	46
		Line resistance	36
E		Load	45
Electrical connection	12, 13		
Electrical data	46		
Electromagnetic compatibility	46		
Emission	46		
Error messages	40		
Errors during calibration	37		

M		R	
Mains disconnecting device	12	Reference temperature	45
Mains frequency	46	Relative humidity	46
Mains fuse	46	Relays	29
Mains supply type	6	Repair	44
Maintenance	44	Reproducibility	45
Manual operation	29	Resistance measuring range	5
Materials	47		
Max contact	32	S	
Measured value resolution	45	Safety devices	3
Measurement deviation	45	Safety notes	3
Measuring range	5, 45	Self-test	19, 21
Measuring system	4, 5	Service	44
Measuring transmitter supply voltage	46	Service network	44
Menu structure	26	Setup mode	26
Min contact	32	Signal output	45
Mounting	10	Start-up	18 - 21
Mounting accessories	11	Storage	9
Mounting brackets	10	Storage temperature	46
MTC	31	Switching current	46
		Switching hysteresis	46
		Switching power	46
		Switching voltage	46
		Symbols	2
N		T	
Nameplate	6	Technical data	45
		Temperature sensor	45
O		Temperature compensation	31
Operating concept	25	Temperature compensation type	30
Operating elements	22	Temperature measurement	45
Operation example	27	Terminal block	12
Operator interface	22	Terminals	46
Order code	6	Test	21
		Transport	9
P		Troubleshooting	40, 41, 42, 43
Packaging	17		
Panel mounting	10	U	
Pickup / dropout delay	46	Unpacking	9
Pickup delay	33		
Post mounting	10	W	
Post mounting kit	11	Wall mounting	10
Power supply	46	Weather protection cover	10, 11
Power-up	18	Weight	4
Programming	26		
Protection class	46, 47		
Q			
Quick calibration	24		

Display	Abbreviation for	Meaning	Page
ALC	alarm contact	Alarm contact	36
ALd	alarm delay	Alarm delay	36
Atc	automatic temperature compensation	Automatic temperature compensation	31
AUTO	automatic calibration	Automatic calibration	38
CAL Con	calibration conductivity	Conductivity calibration	37
CAL RES	calibration resistance	Resistance calibration	37
C°C	calibration °C	Calibration temperature	31
CCd	calibration code	Calibration code	25
CEL	cell	Measuring cell	38, 39
Conf	configuration	Configuration	36
Entr	controller	Limit contactor	34
Ctc	calibration temperature coefficient	Calibration temperature coefficient	30
dEEen	deenergized	Normally closed contact	34
dEF	default	Factory settings	36
Edit	edit	Entry of cell constant	39
En	energized	Normally open contact	34
FLEt	fleeting contact	Fleeting contact	36
Hi	high	Upper limit	32
HYS	hysteresis	Hysteresis	33
LAd	line adjustment	Line resistance adjustment	36

Display	Abbreviation for	Meaning	Page
Lc	limit contactor	Limit contactor	34
L in	linear	Linear temperature compensation	30
Lo	low	Lower limit	32
no	no	Do not restore defaults	36
OFd	off delay	Dropout delay	33
off	off (controller / ATC)	Limit contactor / ATC off	31, 34
on	on (controller / ATC)	Limit contactor / ATC on	31, 34
OnD	on delay	Pickup delay	33
out	current output	Current output	35
PoC	process °C	Process temperature	31
Ptc	process temperature coefficient	Process temperature coefficient	30
Pur	pure water	Ultrapure water	30
r.0	range 0 mA	Value at 0 mA (0...20 mA)	35
r.4	range 4 mA	Value at 4 mA (4...20 mA)	35
r.20	range 20 mA	Value at 20 mA (0/4...20 mA)	35
rEL	relay	Relay function	34
rng	range	Measuring range / current output	35
SCd	setup code	Setup code	25
SEt °C	set temperature	Function group 'Temperature'	33
SP 1	setpoint 1	Limit 1	32

Display	Abbreviation for	Meaning	Page
SP2	setpoint 2	Limit 2	32
Stdy	steady	Steady contact	36
tC	temperature compensation	Temperature compensation	30
YES	yes	Restore defaults	36

liquisys CLM 221 Menu structure

The display screens shown in this overview are examples and may be different during operation.



Caution:

In the case of function groups marked with an asterisk *****, all settings are reset to the defaults when switching between pH and redox measurement!



Fields marked with a triangle in the lower right corner may not be shown depending on the instrument configuration.

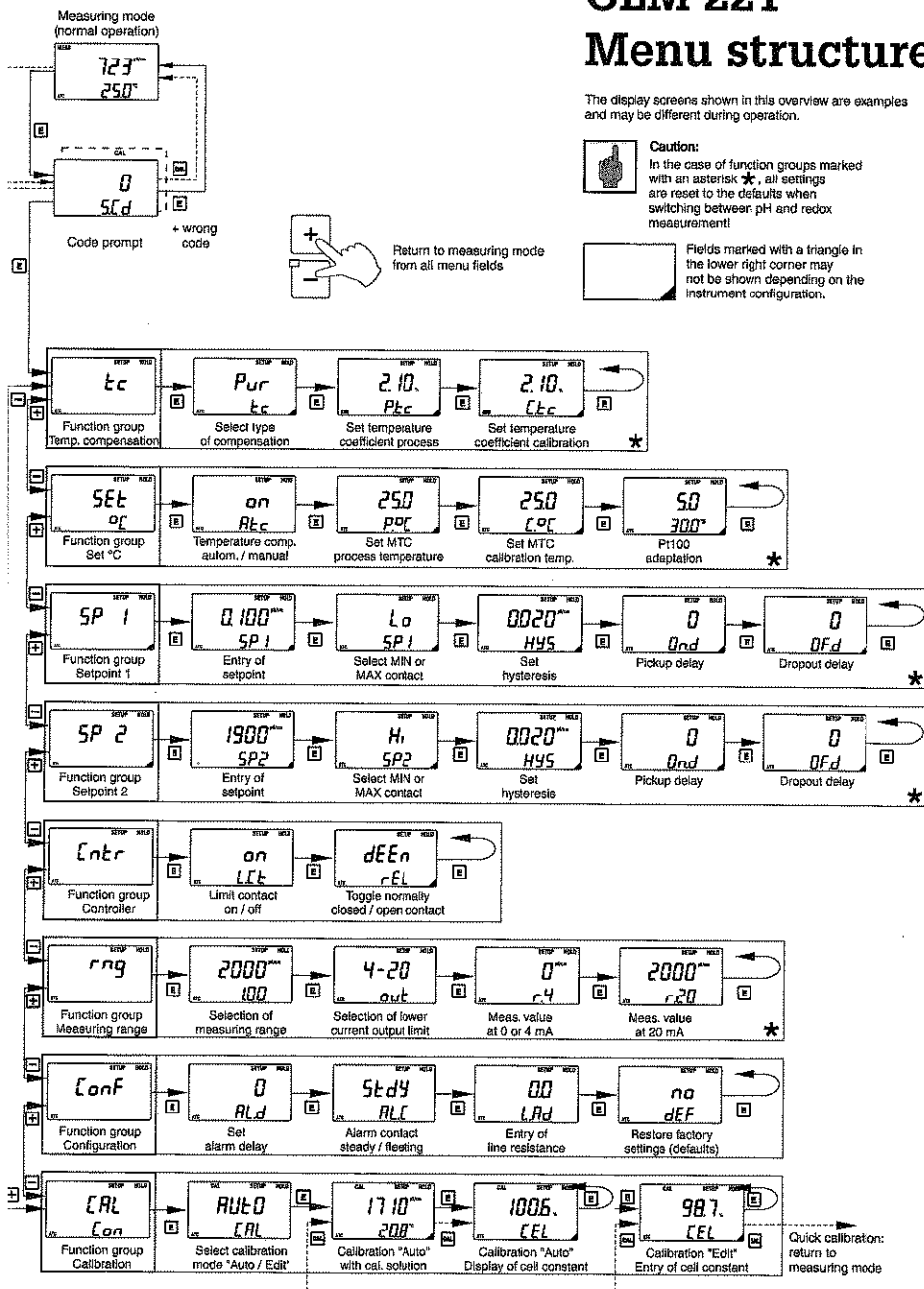

Europe

Austria
□ Endress+Hauser Gas.m.b.H.
Wien
Tel. (02 22) 880 56-0, Fax (02 22) 880 56-35

Belgium
□ Endress+Hauser S.A./N.V.
Brussels
Tel. (02) 2 49 06 00, Fax (02) 2 49 05 53

Bulgaria
INTERTECH-AUTOMATION
Sofia
Tel. (02) 65 28 09, Fax (02) 65 28 08

Croatia
□ Endress+Hauser GmbH+Co.
Zagreb
Tel. (01) 41 58 12, Fax (01) 44 78 59

Czech Republic
□ Endress+Hauser GmbH+Co.
Ostrava
Tel. (069) 6 61 19 48, Fax (069) 6 61 26 69

Denmark
□ Endress+Hauser A/S
Saborn
Tel. (31) 67 31 22, Fax (31) 67 30 45

Finland
□ Endress+Hauser Oy
Espoo
Tel. (90) 8 59 61 55, Fax (90) 8 59 60 55

France
□ Endress+Hauser
Huntingue
Tel. (03) 89 69 67 68, Fax (03) 89 69 48 02

Germany
□ Endress+Hauser Meßtechnik GmbH+Co.
Wall an Rhein
Tel. (0 76 21) 9 75-01, Fax (0 76 21) 9 75-555

Great Britain
□ Endress+Hauser Ltd.
Manchester
Tel. (01 61) 2 86 50 00, Fax (01 61) 9 98 18 41

Greece
I & G Building Services Automation S.A.
Athens
Tel. (01) 9 24 15 00, Fax (01) 9 22 17 14

Hungary
Mile Ipari-Elektro
Budapest
Tel. (01) 2 61 55 35, Fax (01) 2 61 55 35

Ireland
Fluoreaco Company Ltd.
Kildare
Tel. (045) 86 86 15, Fax (045) 86 81 82

Italy
□ Endress+Hauser Itella S.p.A.
Cernusco s/N Milano
Tel. (02) 92 10 64 21, Fax (02) 92 10 71 53

Luxembourg
□ Endress+Hauser S.A./N.V.
Brussels
Tel. (02) 2 48 06 00, Fax (02) 2 48 05 53

Netherlands
□ Endress+Hauser B.V.
Naarden
Tel. (0 35) 6 95 96 11, Fax (0 35) 6 95 68 25

Norway
□ Endress+Hauser A/S
Tranby
Tel. (0 32) 85 10 85, Fax (0 32) 85 11 12

Poland
Endress+Hauser Polska Sp. z o.o.
Warsaw
Tel. (0 22) 6 51 01 74, Fax (0 22) 6 51 01 78

Portugal
Tecnisis - Tecnica de Sistemas Industriais
Linda-a-Velha
Tel. (01) 4 17 26 37, Fax (01) 4 18 52 78

Europe

Russia
Avtomatika-Sever Ltd.
St. Petersburg
Tel. (08 12) 5 55 07 00, Fax (08 12) 5 56 13 21

Slovak Republic
Transcom technik s.r.o.
Bratislava
Tel. (7) 5 21 31 61, Fax (7) 5 21 31 61

Slovenia
Endress+Hauser D.O.O.
Ljubljana
Tel. (061) 1 59 22 17, Fax (061) 1 59 22 98

Spain
□ Endress+Hauser S.A.
Barcelona
Tel. (93) 4 73 46 44, Fax (93) 4 73 38 39

Sweden
□ Endress+Hauser AB
Solentuna
Tel. (08) 6 26 16 00, Fax (08) 6 26 94 77

Switzerland
□ Endress+Hauser AG
Reinach/BL 1
Tel. (081) 7 15 62 22, Fax (081) 7 11 16 50

Turkey
Intek Endüstriyel Ölçü ve Kontrol Sistemleri
İstanbul
Tel. (02 12) 2 75 13 55, Fax (02 12) 2 66 27 75

Ukraine
Industria Ukraina
Kyiv
Tel. (44) 2 68 52 13, Fax (44) 2 68 52 13

Overseas

Argentina
Servotron SACIFI
Buenos Aires
Tel. (01) 3 31 01 68, Fax (01) 3 34 01 04

Australia
GEC Aisthom LTD.
Sydney
Tel. (02) 6 45 07 77, Fax (02) 7 43 70 35

Brazil
Servotek
Sao Paulo
Tel. (0 11) 5 36 34 55, Fax (0 11) 5 36 34 57

Canada
□ Endress+Hauser Ltd.
Burlington, Ontario
Tel. (905) 6 81 92 92, Fax (905) 6 81 94 44

Chile
DIN Instrumentos Ltda.
Santiago
Tel. (02) 2 05 01 00, Fax (02) 2 25 81 39

China
Endress+Hauser Beijing
Beijing
Tel. (0 10) 4 07 21 20, Fax (0 10) 4 03 45 36

Hong Kong
□ Endress+Hauser (H.K.) Ltd.
Hong Kong
Tel. 2 5 28 31 20, Fax 2 8 65 41 71

India
□ Endress+Hauser India Branch Office
Bombay
Tel. (022) 6 04 55 78, Fax (022) 6 04 02 11

Indonesia
PT Grama Bazita
Jakarta
Tel. (21) 7 97 50 83, Fax (21) 7 97 50 89

Israel
Instrumetrics Industrial Control Ltd.
Tel-Aviv
Tel. (03) 6 48 02 05, Fax (03) 6 47 19 92

Overseas

Japan
□ Sakura Endress Co., Ltd.
Tokyo
Tel. (04 22) 54 06 11, Fax (04 22) 55 02 75

Kingdom of Saudi Arabia
Intrah
Dammam
Tel. (03) 8 34 78 79, Fax (03) 8 34 48 32

Kuwait
Kuwait Maritime & Mercantile Co. K.S.C.
Safat
Tel. 2 43 47 52, Fax 2 44 14 86

Malaysia
□ Endress+Hauser (M) Sdn. Bhd.
Petaling Jaya, Selangor Darul Ehsan
Tel. (03) 7 33 48 48, Fax (03) 7 33 86 00

Mexico
Maquinaria y Accesorios S.A. de C.V.
Mexico D.F.
Tel. (5) 5 63 81 88, Fax (5) 5 93 29 37

New Zealand
EMC Industrial Instrumentation
Auckland
Tel. (09) 4 44 92 29, Fax (09) 4 44 11 45

Philippines
Brenton Industries Inc.
Makati Metro Manila
Tel. (2) 8 43 06 61, Fax (2) 8 17 57 39

Singapore
□ Endress+Hauser (S.E.A.) Pte., Ltd.
Singapore
Tel. 4 68 82 22, Fax 4 68 68 48

South Africa
□ Endress+Hauser Pty. Ltd.
Sandton
Tel. (0 11) 4 44 13 86, Fax (0 11) 4 44 18 77

South Korea
Hitrol Co. Ltd.
Kyung Gi-Do
Tel. (032) 6 72 31 31, Fax (32) 6 72 00 90

Sultanate of Oman
Mustafa & Jawad Science & Industry Co. L.L.C.
Ruwi
Tel. 60 20 09, Fax 60 70 66

Taiwan
Kingjari Corporation
Taipei R.O.C.
Tel. (02) 7 18 39 38, Fax (02) 7 13 41 90

Thailand
□ Endress+Hauser Ltd.
Bangkok
Tel. (2) 2 72 36 74, Fax (2) 2 72 36 73

United Arab Emirates
Descon Trading EST.
Dubai
Tel. (04) 35 95 22, Fax (04) 35 96 17

USA
□ Endress+Hauser Inc.
Greenwood, Indiana
Tel. (3 17) 5 35-71 38, Fax (3 17) 5 35-14 89

Venezuela
H. Z. Instrumentos C.A.
Caracas
Tel. (02) 9 78 88 13, Fax (02) 9 79 96 08

All other countries

□ Endress+Hauser GmbH+Co.
Instruments International
Well am Rhein
Tel. (0 76 21) 9 75-02, Fax (0 76 21) 9 75 34 5

□ Members of the Endress+Hauser group



50077390

Endress+Hauser

Nothing beats know-how



Environmentally friendly
Bleached without chlorine

