

Brief Operating Instructions

Deltapilot S

FMB70

Hydrostatic level measurement

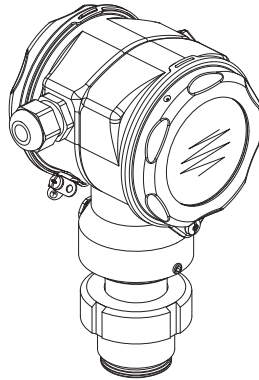

These Instructions are Brief Operating Instructions; they are not a substitute for the Operating Instructions pertaining to the device.

Detailed information about the device can be found in the Operating Instructions and the other documentation:

Available for all device versions via:

- Internet: www.endress.com/deviceviewer
- Smart phone/tablet: *Endress+Hauser Operations App*

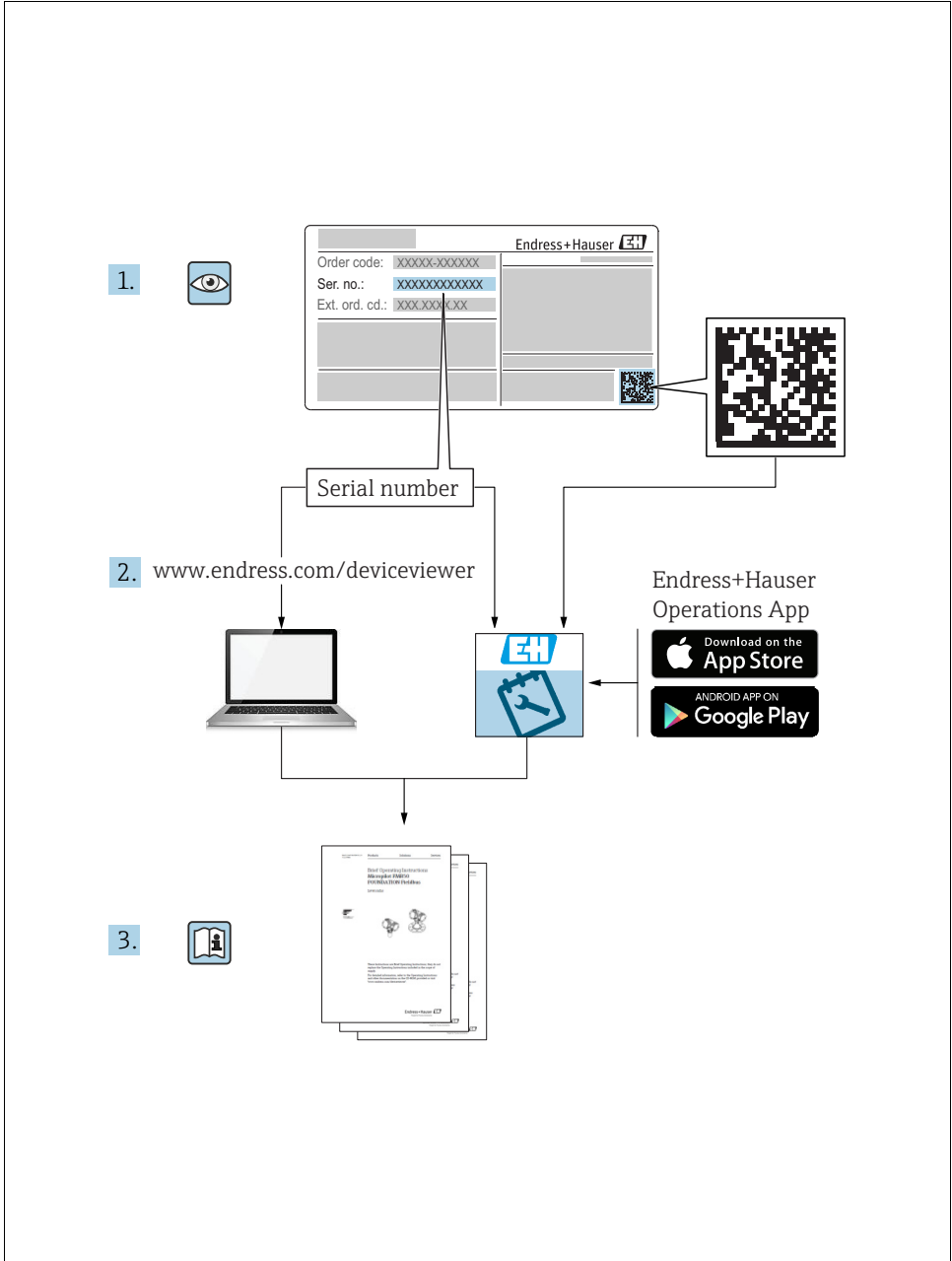

Table of contents

1	Document information	4
1.1	Document function	4
1.2	Symbols used	4
1.3	Registered trademarks	6
1.4	Terms and abbreviations	7
1.5	Turn down calculation	8
2	Basic safety instructions	9
2.1	Requirements concerning the staff	9
2.2	Designated use	9
2.3	Workplace safety	9
2.4	Operational safety	9
2.5	Hazardous area	10
2.6	Product safety	10
2.7	Functional Safety SIL3 (optional)	10
3	Identification	10
3.1	Product identification	10
3.2	Device designation	11
3.3	Scope of delivery	11
3.4	CE mark, declaration of conformity	12
4	Installation	12
4.1	Incoming acceptance and storage	12
4.2	Installation conditions	12
4.3	General installation instructions	13
4.4	Installation instructions	13
4.5	Post-installation check	18
5	Wiring	18
5.1	Connecting the device	18
5.2	Connecting the measuring unit	21
5.3	Potential matching	23
5.4	Overvoltage protection (optional)	23
5.5	Post-connection check	23
6	Operation	24
6.1	On-site display (optional)	24
6.2	Operating elements	26
6.3	On-site operation – on-site display not connected	28
6.4	On-site operation – on-site display connected	31
6.5	HistoROM®/M-DAT (optional)	33
6.6	Operation via SFX100	34
6.7	Endress+Hauser operating program	34
6.8	Locking/unlocking operation	34
6.9	Factory setting (reset)	34
7	Commissioning	34
7.1	Configuring messages	35
7.2	Function check	35
7.3	Selecting language and measuring mode	35
7.4	Position adjustment	35
7.5	Level measurement	37
7.6	Pressure measurement	41





1 Document information

1.1 Document function







These Operating Instructions contain all the information that is required in various phases of the life cycle of the device: from product identification, incoming acceptance and storage, to mounting, connection, operation and commissioning through to troubleshooting, maintenance and disposal.

1.2 Symbols used



1.2.1 Safety symbols

Symbol	Meaning
 A0011189-DE	DANGER! This symbol alerts you to a dangerous situation. Failure to avoid this situation will result in serious or fatal injury.
 A0011190-DE	WARNING! This symbol alerts you to a dangerous situation. Failure to avoid this situation can result in serious or fatal injury.
 A0011191-DE	CAUTION! This symbol alerts you to a dangerous situation. Failure to avoid this situation can result in minor or medium injury.
 A0011192-DE	NOTICE! This symbol contains information on procedures and other facts which do not result in personal injury.









1.2.2 Electrical symbols

Symbol	Meaning	Symbol	Meaning
	Direct current		Alternating current
	Direct current and alternating current		Ground connection A grounded terminal which, as far as the operator is concerned, is grounded via a grounding system.
	Protective ground connection A terminal which must be connected to ground prior to establishing any other connections.		Equipotential connection A connection that has to be connected to the plant grounding system: This may be a potential equalization line or a star grounding system depending on national or company codes of practice.

1.2.3 Tool symbols

Symbol	Meaning
 A0011221	Allen key
 A0011222	Hexagon wrench

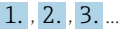
1.2.4 Symbols for certain types of information

Symbol	Meaning
 A0011182	Permitted Indicates procedures, processes or actions that are permitted.
 A0011184	Forbidden Indicates procedures, processes or actions that are forbidden.
 A0011193	Tip Indicates additional information.
 A0028658	Reference to documentation
 A0028659	Reference to page
 A0028660	Reference to graphic
 A0031595	Series of steps
 A0018343	Result of a sequence of actions
 A0028673	Visual inspection

1.2.5 Symbols in graphics

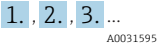
Symbol	Meaning
1, 2, 3, 4, ...	Item numbers
	Series of steps
A, B, C, D, ...	Views

1.2.6 Symbols at the device

Symbol	Meaning
	Safety instructions Observe the safety instructions contained in the associated Operating Instructions.

1.3 Registered trademarks

KALREZ, VITON, TEFLON

Registered trademarks of E.I. Du Pont de Nemours & Co., Wilmington, USA

TRI-CLAMP

Registered trademark of Ladish & Co., Inc., Kenosha, USA

HART

Registered trademark of the HART Communication Foundation, Austin, USA.

GORE-TEX®

Registered trademarks of W.L. Gore & Associates, Inc., USA

1.4 Terms and abbreviations

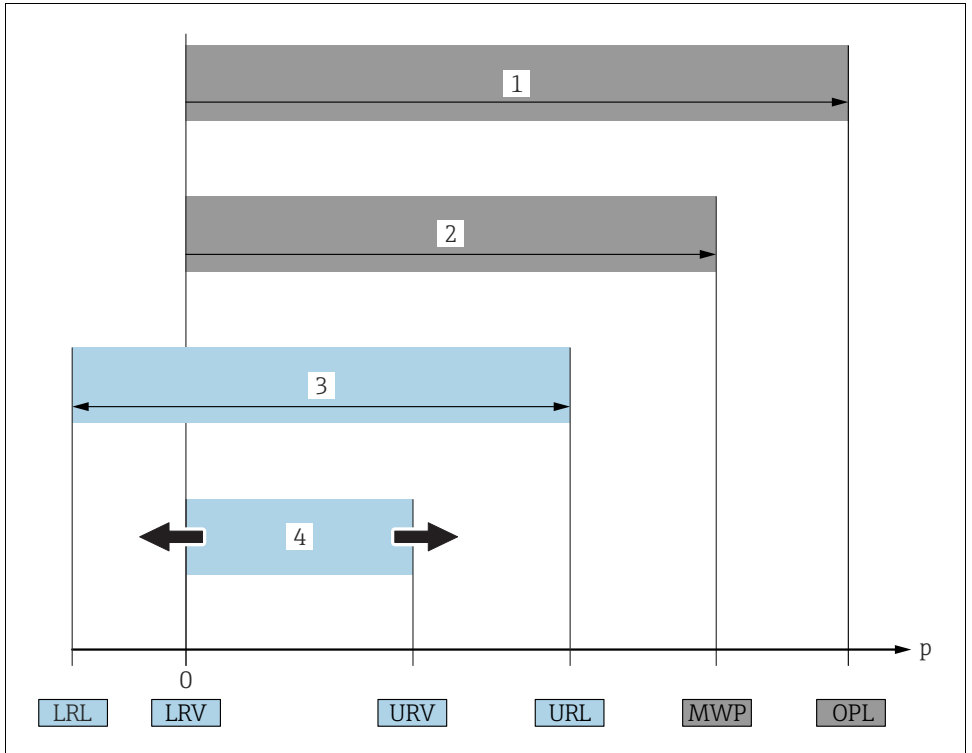

A0029505

Position	Term/Abbreviation	Explanation
1	OPL	The OPL (over pressure limit = sensor overload limit) for the sensors depends on the lowest-rated element, with regard to pressure, of the selected components, i.e. the process connection must be taken into consideration in addition to the measuring cell. Also observe pressure-temperature dependency. For the relevant standards and additional notes, see technical information. The OPL may be applied for a limited time period.
2	MWP	The MWP (maximum working pressure) for the sensors depends on the lowest-rated element, with regard to pressure, of the selected components, i.e. the process connection has to be taken into consideration in addition to the measuring cell. Also observe pressure-temperature dependency. For the relevant standards and additional notes, see technical information. The MWP may be applied for an unlimited time.
3	Maximum sensor measuring range	Range between LRL and URL. This span is the maximum calibratable/adjustable measuring span.

Position	Term/Abbreviation	Explanation
4	Calibrated/Adjusted measuring span	Range between LRV and URV Factory setting: 0...URL Other calibrated spans can be ordered with customised settings.
p	-	Pressure
-	LRL	Lower range limit
-	URL	Upper range limit
-	LRV	Lower range value
-	URV	Upper range value
-	TD	Turn down

1.5 Turn down calculation

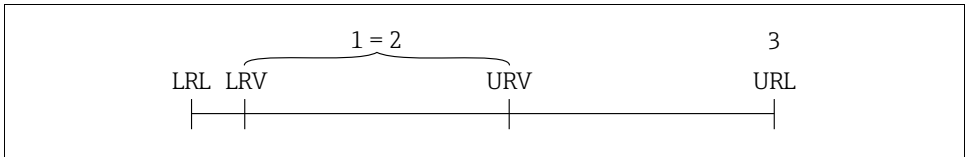

A0029545

Fig. 1:

- 1 Calibrated/Adjusted measuring span
- 2 Zero-based span
- 3 Upper range limit

Example	
<ul style="list-style-type: none"> ▪ Sensor: 10 bar (150 psi) ▪ Upper range limit (URL) = 10 bar (150 psi) <p>Turn down (TD):</p> $TD = \frac{URL}{ URV - LRV }$ $TD = \frac{10 \text{ bar (150 psi)}}{ 5 \text{ bar (75 psi)} - 0 \text{ bar (0 psi)} } = 2$ <p>In this example, the TD is thus 2:1. This span is based on the zero point.</p>	<ul style="list-style-type: none"> ▪ Calibrated/Adjusted measuring span: 0...5 bar (0...75 psi) ▪ Lower range value (LRV) = 0 bar ▪ Upper range value (URV) = 5 bar (75 psi)

2 Basic safety instructions

2.1 Requirements concerning the staff

The personnel for installation, commissioning, diagnostics and maintenance must fulfill the following requirements:

- Trained, qualified specialists: must have a relevant qualification for this specific function and task
- Are authorized by the plant owner/operator
- Are familiar with federal/national regulations
- Before beginning work, the specialist staff must have read and understood the instructions in the Operating Instructions and supplementary documentation as well as in the certificates (depending on the application)
- Following instructions and basic conditions

The operating personnel must fulfill the following requirements:

- Being instructed and authorized according to the requirements of the task by the facility's owner-operator
- Following the instructions in these Operating Instructions

2.2 Designated use

The Deltapilot S is a hydrostatic pressure transmitter for measuring level and pressure.

2.2.1 Incorrect use

The manufacturer is not liable for damage caused by improper or non-designated use.

Verification for borderline cases:

For special fluids and fluids for cleaning, Endress+Hauser is glad to provide assistance in verifying the corrosion resistance of fluid-wetted materials, but does not accept any warranty or liability.

2.3 Workplace safety

For work on and with the device:

- Wear the required personal protective equipment according to federal/national regulations.
- Switch off the supply voltage before connecting the device.

2.4 Operational safety

Risk of injury!

- ▶ Operate the device in proper technical condition and fail-safe condition only.
- ▶ The operator is responsible for interference-free operation of the device.

Conversions to the device

Unauthorized modifications to the device are not permitted and can lead to unforeseeable dangers:

- ▶ If, despite this, modifications are required, consult with Endress+Hauser.

Repair

To ensure continued operational safety and reliability,

- ▶ Carry out repairs on the device only if they are expressly permitted.
- ▶ Observe federal/national regulations pertaining to repair of an electrical device.
- ▶ Use original spare parts and accessories from Endress+Hauser only.

2.5 Hazardous area

To eliminate a danger for persons or for the facility when the device is used in the hazardous area (e.g. explosion protection, pressure vessel safety):

- Based on the nameplate, check whether the ordered device is permitted for the intended use in the hazardous area.
- Observe the specifications in the separate supplementary documentation that is an integral part of these Instructions.

2.6 Product safety

This measuring device is designed in accordance with good engineering practice to meet state-of-the-art safety requirements, has been tested, and left the factory in a condition in which they are safe to operate. It fulfills general safety requirements and legal requirements. It also conforms to the EC directives listed in the device-specific EC declaration of conformity. Endress+Hauser confirms this fact by applying the CE mark.

2.7 Functional Safety SIL3 (optional)

If using devices for applications with safety integrity, the Functional Safety Manual must be observed thoroughly.

3 Identification

3.1 Product identification

The following options are available for identification of the measuring device:

- Nameplate specifications
- Order code with breakdown of the device features on the delivery note
- Enter serial numbers from nameplates in W@M Device Viewer
(www.endress.com/deviceviewer) : All information about the measuring device is displayed.

For an overview of the technical documentation provided, enter the serial number from the nameplates in the W@M Device Viewer (www.endress.com/deviceviewer).

3.1.1 Manufacturer address

Endress+Hauser GmbH+Co. KG
Hauptstraße 1
79689 Maulburg, Germany
Address of the manufacturing plant: See nameplate.

3.2 Device designation

3.2.1 Nameplate

- The MWP (maximum working pressure) is specified on the nameplate. This value refers to a reference temperature of +20 °C (68°F) and may be applied to the device for an unlimited time. Observe temperature dependency of the MWP. The pressure values permitted at higher temperatures can be found in the standards EN 1092-1: 2001 Tab. 18 (With regard to their stability-temperature property, the materials 1.4435 and 1.4404 are grouped together under 13EO in EN 1092-1 Tab. 18. The chemical composition of the two materials can be identical.), ASME B 16.5a – 1998 Tab. 2-2.2 F316, ASME B 16.5a – 1998 Tab. 2.3.8 N10276, JIS B 2220.
- The test pressure corresponds to the over pressure limit (OPL) of the device = MWP x 1.5.
- The Pressure Equipment Directive (2014/68/EU) uses the abbreviation "PS". The abbreviation "PS" corresponds to the MWP (maximum working pressure) of the measuring device.

3.2.2 Identifying the sensor type

See parameter "Sensor Meas.Type" in Operating Instruction BA00274P.

3.3 Scope of delivery

The scope of delivery comprises:

- Deltapilot S hydrostatic pressure transmitter
- For devices with the "HistoROM/M-DAT" option:
CD-ROMs with Endress+Hauser operating program
- Optional accessories

Documentation supplied:

- The Operating Instructions BA00332P and BA00274P are available via the Internet.
→ See: www.endress.com → Download.
- Brief Operating Instructions KA01020P
- Leporello KA00218P
- Final inspection report
- Also Safety Instructions with devices for use in hazardous areas
- Optional: factory calibration form, test certificates

3.4 CE mark, declaration of conformity

The device is designed to meet state-of-the-art safety requirements, has been tested and left the factory in a condition in which it is safe to operate. The device complies with the applicable standards and regulations as listed in the EC declaration of conformity and thus complies with the statutory requirements of the EC Directives. Endress+Hauser confirms the successful testing of the device by affixing to it the CE mark.

4 Installation

4.1 Incoming acceptance and storage

4.1.1 Incoming acceptance

- Check the packaging and the contents for damage.
- Check the shipment, make sure nothing is missing and that the scope of supply matches your order.

4.1.2 Transport

⚠ WARNING

Incorrect transportation

Housing and diaphragm may become damaged, and there is a risk of injury!

- ▶ Transport the measuring device to the measuring point in its original packaging or by the process connection (with secure transport protection for the diaphragm).
- ▶ Follow the safety instructions and transport conditions for devices weighing more than 18 kg (39.6 lbs).

4.1.3 Storage

The device must be stored in a dry, clean area and protected against damage from impact (EN 837-2).

Storage temperature range:

- -40 to +90°C (-40 to +194°F)
- On-site display: -40 to +85°C (-40 to +185°F)
- Separate housing: -40 to +60°C (-40 to +140°F)

4.2 Installation conditions

4.2.1 Dimensions





→ For dimensions, please refer to the Technical Information for Deltapilot S TI00416P, "Mechanical construction" section.

4.3 General installation instructions

- Devices with a G 1 1/2 thread:

When screwing the device into the tank, the flat seal has to be positioned on the sealing surface of the process connection. To avoid additional strain on the process isolating diaphragm, the thread should never be sealed with hemp or similar materials.
- Devices with NPT threads:
 - Wrap Teflon tape around the thread to seal it.
 - Tighten the device at the hexagonal bolt only. Do not turn at the housing.
 - Do not overtighten the thread when screwing. Max. torque: 20 to 30 Nm (14.75 to 22.13 lbf ft)

4.4 Installation instructions

- Due to the orientation of the Deltapilot S, there may be a shift in the measured value, i.e. when the container is empty, the measured value does not display zero. You may correct this zero point shift either directly on the device using the -key or by remote operation. →  27, "Function of the operating elements – on-site display not connected" or →  35, "Position adjustment"..
- To ensure optimal readability of the on-site display, it is possible to rotate the housing up to 380°. →  17, Section 4.4.5 "Rotating the housing".
- The on-site display can be rotated in 90° stages.
- Endress+Hauser offers a mounting bracket for installing on pipes or walls. →  15, Section 4.4.3 "Wall and pipe mounting (optional)".

4.4.1 Installation instructions

NOTICE

Damage to the device!

If a heated Deltapilot S is cooled during the cleaning process (e.g. by cold water), a vacuum develops for a short time, whereby moisture can penetrate the sensor through the pressure compensation (1).

- ▶ If this is the case, mount the sensor with the pressure compensation (1) pointing downwards.

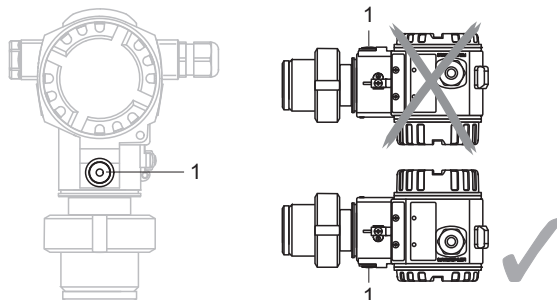

- Keep the pressure compensation and GORE-TEX® filter (1) free from contaminations.
- Do not clean or touch process isolating diaphragm with hard or pointed objects.
- The device must be installed as follows in order to comply with the cleanability requirements of the ASME-BPE (Part SD Cleanability):

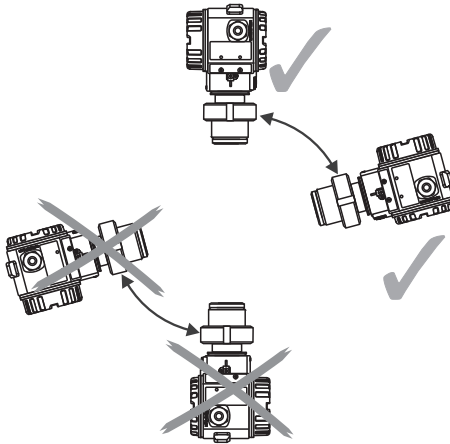

Level measurement

- Always install the device below the lowest measuring point.
- Do not install the device at the following positions:
 - in the filling curtain
 - in the tank outflow
 - in the suction area of a pump
 - or at a point in the tank that can be affected by pressure pulses from the agitator
- The calibration and functional test can be carried out more easily if you mount the device downstream of a shutoff device.
- Deltapilot S must be included in the insulation for media that can harden when cold.

Pressure measurement in gases

- Mount Deltapilot S with shutoff device above the tapping point so that any condensate can flow into the process.

Pressure measurement in steams

- Mount Deltapilot S with siphon above the tapping point.
- Fill the siphon with liquid before commissioning.
The siphon reduces the temperature to almost the ambient temperature.

Pressure measurement in liquids

- Mount Deltapilot S with the shutoff device below or at the same level as the tapping point.

4.4.2 Seal for flange mounting

NOTICE**Corrupted measurement results.**

The seal is not allowed to press against the process isolating diaphragm as this could affect the measurement result.

- Ensure that the seal is not touching the process isolating diaphragm.

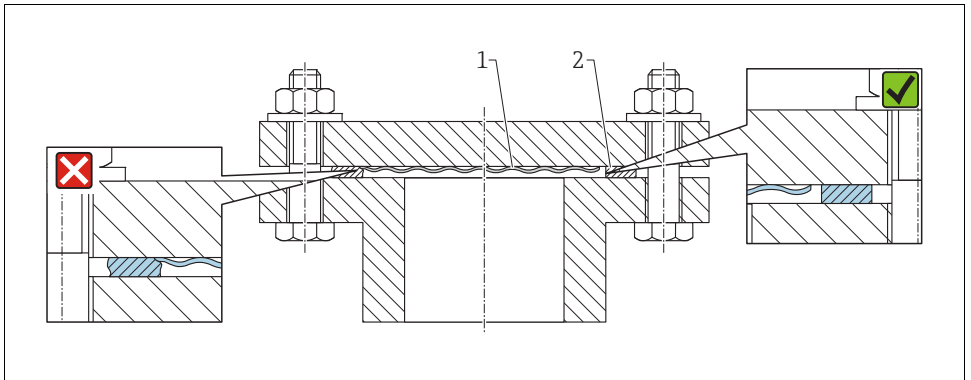

A0017743

Fig. 2:

- 1 Process isolating diaphragm
- 2 Seal

4.4.3 Wall and pipe mounting (optional)

Endress+Hauser offers a mounting bracket for installation on pipes or walls (for pipe diameters from 1 ¼" to 2").

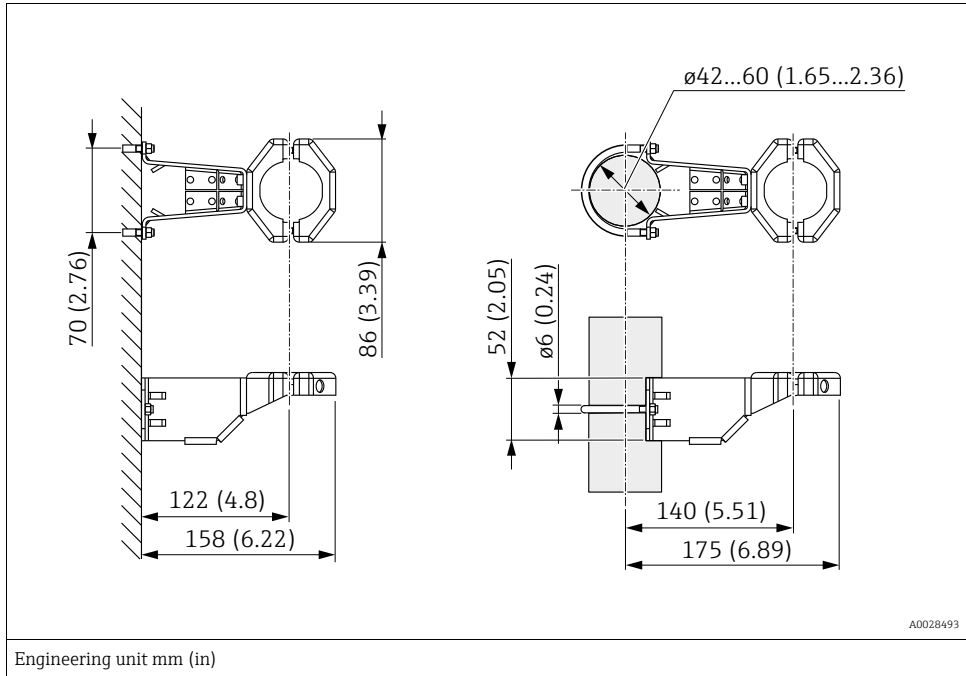

Please note the following when mounting:

- Devices with capillary tubes: mount capillaries with a bending radius ≥ 100 mm (3.94 in).
- When mounting on a pipe, tighten the nuts on the bracket uniformly with a torque of at least 5 Nm (3.69 lbs ft).

4.4.4 Assembling and mounting the "separate housing" version

See operating instructions.

4.4.5 Rotating the housing

The housing can be rotated up to 380° by loosening the Allen screw.

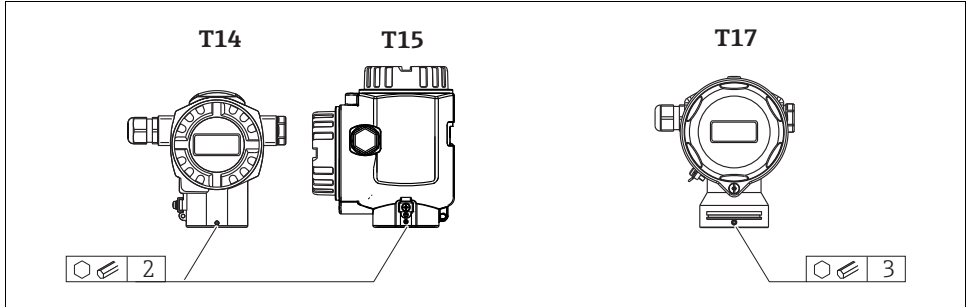

A0019996

1. T14 and T15 housing: Loosen setscrew with a 2 mm (0.08 in) Allen key.
T17 housing: Loosen setscrew with a 3 mm (0.12 in) Allen key.
2. Rotate housing (max. up to 380°).
3. Retighten setscrew with 1 Nm (0,74 lbf ft).

4.4.6 Closing the housing cover

NOTICE

Devices with EPDM cover seal - transmitter leakiness!

Mineral-based, animal-based or vegetable-based lubricants cause the EPDM cover seal to swell and the transmitter to become leaky.

- ▶ The thread is coated at the factory and therefore does not require any lubrication.

NOTICE

The housing cover can no longer be closed.

Damaged thread!

- ▶ When closing the housing cover, please ensure that the thread of the cover and housing are free from dirt, e.g. sand. If you feel any resistance when closing the cover, check the thread on both again to ensure that they are free from dirt.

Close cover on a hygienic stainless steel housing (T17)

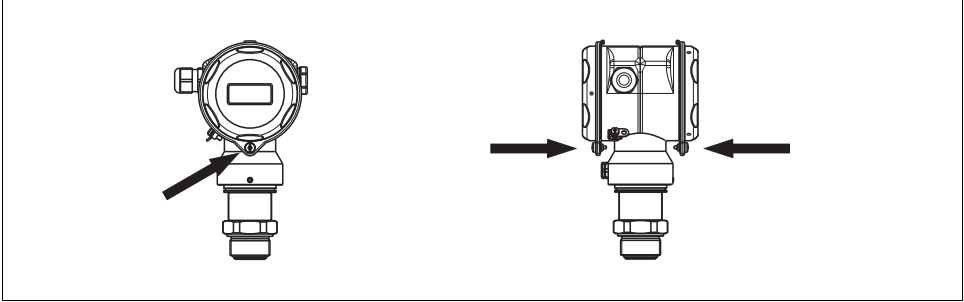

Fig. 3: Close cover

F01-FMB70xxx-17-xx-xx-xx-001

The covers for the terminal and electronics compartment are hooked into the casing and closed with a screw. These screws should be finger-tightened (2 Nm (1.48 lbf ft)) to the stop to ensure that the covers sit tightly.

4.4.7 Mounting of the profile seal for universal process mounting adapter

For details on mounting, see KA00096F/00/A3.

4.5 Post-installation check

After installing the device, carry out the following checks:

- Are all screws firmly tightened?
- Are the housing covers screwed down tight?

5 Wiring

5.1 Connecting the device

⚠ WARNING

Risk of electric shock!

If the operating voltage is > 35 VDC: Dangerous contact voltage at terminals.

- ▶ In a wet environment, do not open the cover if voltage is present.

⚠ WARNING

Limitation of electrical safety due to incorrect connection!

- Risk of electric shock and/or explosion in hazardous areas! In a wet environment, do not open the cover if voltage is present.

- When using the measuring device in hazardous areas, installation must comply with the corresponding national standards and regulations and the Safety Instructions or Installation or Control Drawings.
- Devices with integrated overvoltage protection must be earthed.
- Protective circuits against reverse polarity, HF influences and overvoltage peaks are installed.
- The supply voltage must match the supply voltage on the nameplate. (→ 11, Section 3.2.1 "Nameplate")
- Switch off the supply voltage before connecting the device.
- Remove housing cover of the terminal compartment.
- Guide cable through the gland. Preferably use twisted, screened two-wire cable.
- Connect device in accordance with the following diagram.
- Screw down housing cover.
- Switch on supply voltage.

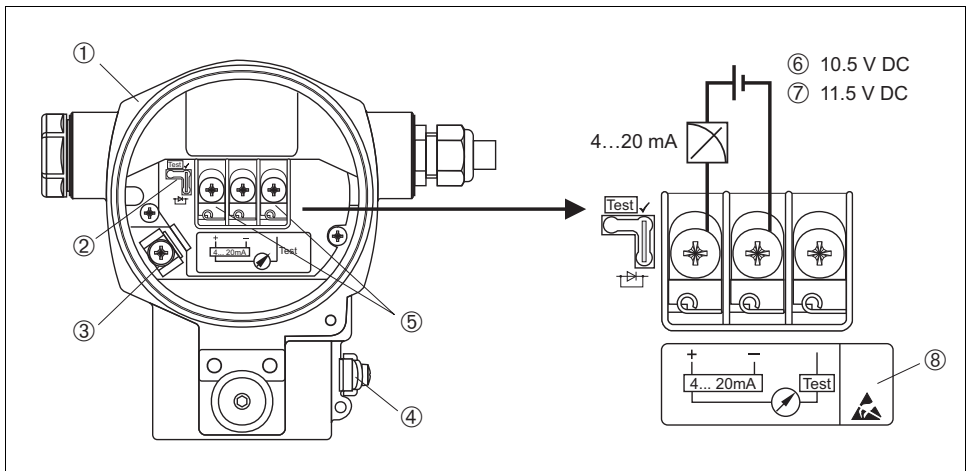

Fig. 4: Electrical connection 4 to 20 mA HART
→ Observe also Section 5.2.1 "Supply voltage", → 21.

- 1 Housing
- 2 Jumper for 4 to 20 mA test signal.
→ 21, Section 5.2.1 "Taking 4 to 20 mA test signal" part.
- 3 Internal earth terminal
- 4 External earth terminal
- 5 4 to 20 mA test signal between plus and test terminal
- 6 Minimum supply voltage = 10.5 V DC, jumper is inserted in accordance with the illustration.
- 7 Minimum supply voltage = 11.5 V DC, jumper is inserted in "Test" position.
- 8 Devices with integrated overvoltage protection are labelled OVP (overvoltage protection) here.

5.1.1 Connecting devices with Harting plug Han7D

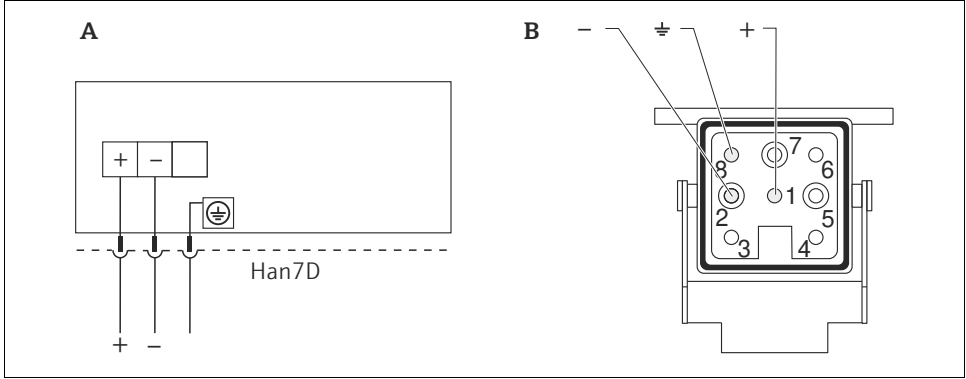

Fig. 5:

- A Electrical connection for devices with Harting plug Han7D
- B View of the plug connector at the device

5.1.2 Connecting devices with an M12 connector

PIN assignment for M12 connector	PIN	Meaning
	1	Signal +
	2	Not assigned
	3	Signal -
	4	Earth

5.1.3 Connecting the cable version

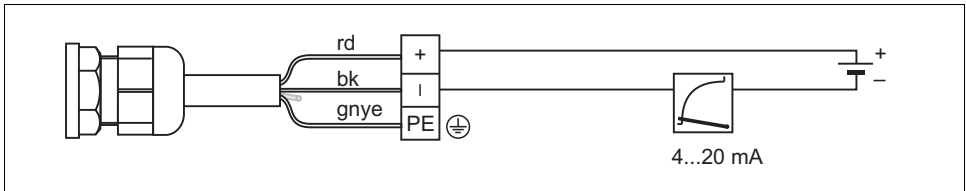

Fig. 6: rd = red, bk = black, gnye = green-yellow

P01-PMx4xxxx-04-xx-xx-xx-010

5.2 Connecting the measuring unit

5.2.1 Supply voltage

⚠ WARNING

Supply voltage might be connected!



Risk of electric shock and/or explosion!

- ▶ When using the measuring device in hazardous areas, installation must comply with the corresponding national standards and regulations and the Safety Instructions or Installation or Control Drawings.
- ▶ All explosion protection data are given in separate documentation which is available upon request. The Ex documentation is supplied as standard with all devices approved for use in explosion hazardous areas.

Electronic version	Jumper for 4 to 20 mA test signal in "Test" position (Delivery status)	Jumper for 4 to 20 mA test signal in "Non-Test" position
4 to 20 mA HART, for non-hazardous areas	11.5 to 45 V DC	10.5 to 45 V DC

Taking 4 to 20 mA test signal

A 4 to 20 mA signal may be measured via the positive and test terminal without interrupting the measurement. The minimum supply voltage of the device can be reduced by simply changing the position of the jumper. As a result, operation is also possible with lower voltage sources. To keep the measured error below 0.1%, the current measuring device should display an internal resistance of $< 0.7 \Omega$. Observe the position of the jumper in accordance with the following table.

Jumper position for test signal	Description
	<ul style="list-style-type: none"> - Taking 4 to 20 mA test signal via plus and test terminal: possible. (Thus, the output current can be measured without interruption via the diode.) - Delivery status - minimum supply voltage: 11.5 V DC
	<ul style="list-style-type: none"> - Taking 4 to 20 mA test signal via plus and test terminal: not possible. - minimum supply voltage: 10.5 V DC

5.2.2 Terminals

- Supply voltage and internal ground terminal: 0.5 to 2.5 mm² (20 to 14 AWG)
- External ground terminal: 0.5 to 4 mm² (20 to 12 AWG)

5.2.3 Cable specification

- Endress+Hauser recommends using twisted, screened two-wire cables.
- Cable external diameter: 5 to 9 mm (0.2 to 0.35 in)

5.2.4 Load

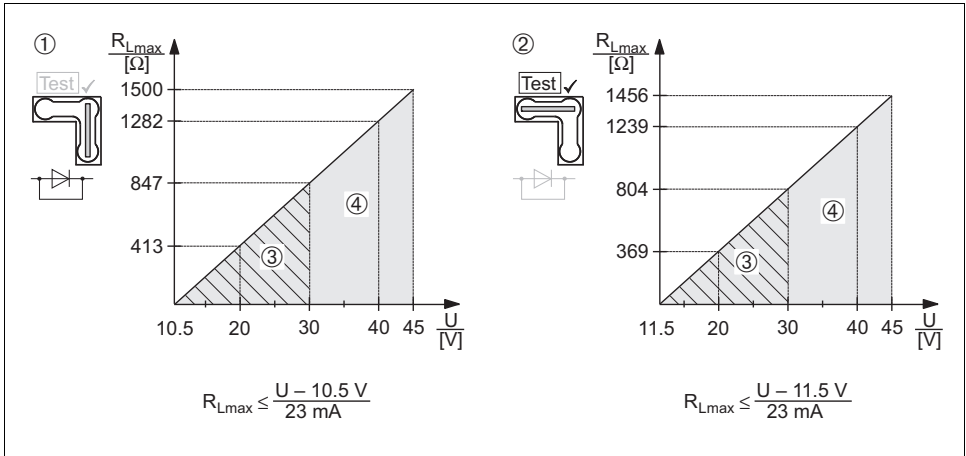

P01-xMD/xxxx-05-xx-xx-xx-005

Fig. 7: Load diagram, observe the position of the jumper and the explosion protection. (→ 21, Section 5.2.1 "Taking 4 to 20 mA test signal" part.)

- Jumper for the 4 to 20 mA test signal inserted in "Non-Test" position
- Jumper for the 4 to 20 mA test signal inserted in "Test" position
- Supply voltage 10.5 (11.5) to 30 V DC for Ex ia, 1/2 D, 1 GD, 1/2 GD, FM IS and CSA IS, IEC Ex ia, NEPSI Ex ia
- Supply voltage 10.5 (11.5) to 45 V DC for devices for non-hazardous areas, 1/3 D, Ex nA, FM DIP, FM NI

R_{Lmax} Maximum load resistance

U Supply voltage



When operating via a handheld terminal or via PC with an operating program, a minimum communication resistance of 250 Ω must exist within the loop.

5.2.5 Screening/potential matching

- You achieve optimum screening against disturbances if the screening is connected on both sides (in the cabinet and on the device). If you have to reckon with potential equalisation currents in the plant, only earth screening on one side, preferably at the transmitter (possibility of hydrogen diffusion).
- When using in hazardous areas, you must observe the applicable regulations. Separate Ex documentation with additional technical data and instructions is included with all Ex systems as standard.

5.2.6 Connecting Field Xpert SFX100

See operating instructions.

5.2.7 Connecting Commubox FXA195

See operating instructions.

5.2.8 Connecting Commubox FXA291/ToF Adapter FXA291 for operation via FieldCare

See operating instructions.

5.3 Potential matching

Ex applications: Connect all devices to the local potential matching.
Observe the applicable regulations.

5.4 Overvoltage protection (optional)

NOTICE

Device could be destroyed!

Devices with integrated overvoltage protection must be earthed.

Devices showing version "M" in feature 100 "Additional options 1" or feature 110 "Additional options 2" in the order code are equipped with overvoltage protection (see also Technical Information TI00416P "Ordering information").

- Overvoltage protection:
 - Nominal functioning DC voltage: 600 V
 - Nominal discharge current: 10 kA
- Surge current check $\hat{i} = 20 \text{ kA}$ as per DIN EN 60079-14: 8/20 μs satisfied
- Arrester AC current check $I = 10 \text{ A}$ satisfied

5.5 Post-connection check

Perform the following checks after completing electrical installation of the device:

- Does the supply voltage match the specifications on the nameplate?
- Is the device connected as per Section 5.1?
- Are all screws firmly tightened?
- Are the housing covers screwed down tight?

As soon as voltage is applied to the device, the green LED on the electronic insert lights up for a few seconds or the connected on-site display lights up.

6 Operation

Feature 20 "Output; operation" in the order code provides you with information on the operating options available to you.

6.1 On-site display (optional)

A 4-line liquid crystal display (LCD) is used for display and operation. The on-site display shows measured values, dialog texts, fault messages and notice messages.

The display of the device can be turned in 90° steps.

Depending on the installation position of the device, this makes it easy to operate the device and read the measured values.

Functions:

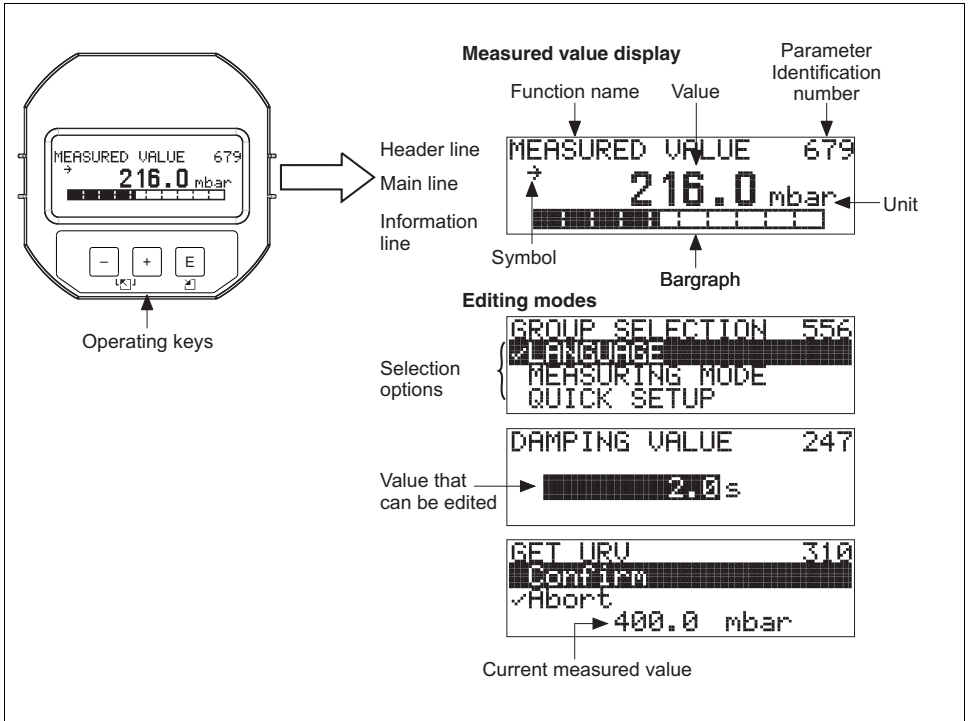

- 8-digit measured value display including sign and decimal point, bargraph for current display
- simple and complete menu guidance thanks to separation of the parameters into several levels and groups
- each parameter is given a 3-digit ID number for easy navigation
- option for configuring the display according to individual requirements and desires, such as language, alternating display, contrast setting, display of other measured values such as sensor temperature
- comprehensive diagnostic functions (fault and warning message, peak-hold indicators, etc.)
- rapid and safe commissioning with the Quick Setup menus



P01-xMx7xxxx-07-xx-xx-xx-001

The following table illustrates the symbols that can appear on the on-site display. Four symbols can occur at one time.

Symbol	Meaning
	<p>Alarm symbol</p> <ul style="list-style-type: none"> - Symbol flashing: warning, device continues measuring. - Symbol permanently lit: error, device does not continue measuring. <p><i>Note:</i> The alarm symbol may overlie the tendency symbol.</p>
	<p>Lock symbol</p> <p>The operation of the device is locked. Unlock device, → 34.</p>
	<p>Communication symbol</p> <p>Data transfer via communication</p> <p><i>Note:</i> The alarm symbol may overlie the communication symbol.</p>

Symbol	Meaning
	Tendency symbol (increasing) The measured value is increasing.
	Tendency symbol (decreasing) The measured value is decreasing.
	Tendency symbol (constant) The measured value has remained constant over the past few minutes.

6.2 Operating elements

6.2.1 Position of operating elements

With regard to aluminium housings (T14/T15), the operating keys are located either outside the device under the protection cap or inside on the electronic insert. In hygienic stainless steel housings (T17), the operating keys are always located inside on the electronic insert.

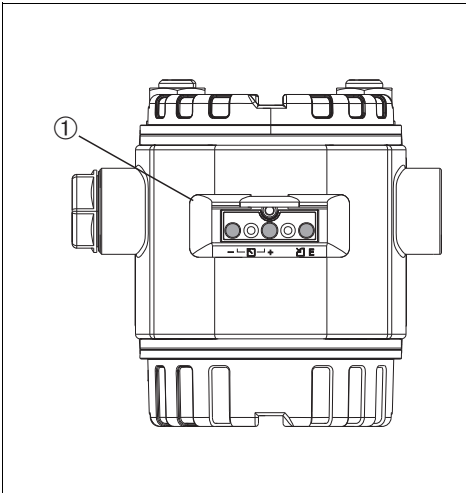

P01-PMx7xxxx-19-xx-xx-xx-009

Fig. 8: Operating keys, external

- 1 Operating keys on the exterior of the device under the protective flap

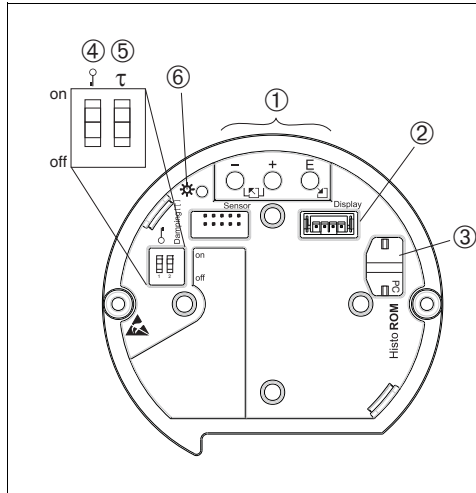















P01-xxxxxxx-19-xx-xx-xx-104

Fig. 9: Operating keys, internal





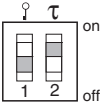

- 1 Operating keys
- 2 Slot for optional display
- 3 Slot for optional HistoROM®/M-DAT
- 4 DIP-switch for locking/unlocking measured-value-relevant parameters
- 5 DIP-switch for damping on/off
- 6 Green LED to indicate value being accepted

6.2.2 Function of the operating elements – on-site display not connected

Press and hold the key or the key combination for at least 3 seconds to execute the corresponding function. Press the key combination for at least 6 seconds for a reset.

Operating key(s)	Meaning
	Adopt lower range value. A reference pressure is present at the device. →  28, Section 6.3.1 "Level measuring mode" or →  30, Section 6.3.2 "Level measuring mode".
	Adopt upper range value. A reference pressure is present at the device. →  28, Section 6.3.1 "Level measuring mode" or →  30, Section 6.3.2 "Level measuring mode".
	Position adjustment
 and  and 	Reset all parameters. The reset via operating keys corresponds to the software reset code 7864.
 and 	Copy the configuration data from the optional HistoROM®/M-DAT module to the device.
 and 	Copy the configuration data from the device to the optional HistoROM®/M-DAT module.
	<ul style="list-style-type: none"> - DIP-switch 1: for locking/unlocking measured-value-relevant parameters Factory setting: off (unlocked) - DIP-switch 2: damping on/off, Factory setting: on (damping on)

6.2.3 Function of the operating elements – on-site display connected

Operating key(s)	Meaning
	<ul style="list-style-type: none"> - Navigate upwards in the picklist - Edit the numerical values and characters within a function
	<ul style="list-style-type: none"> - Navigate downwards in the picklist - Edit the numerical values and characters within a function
	<ul style="list-style-type: none"> - Confirm entry - Jump to the next item
 and 	Contrast setting of on-site display: darker
 and 	Contrast setting of on-site display: brighter

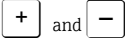
Operating key(s)	Meaning
	<p>ESC functions:</p> <ul style="list-style-type: none"> - Exit edit mode without saving the changed value. - You are in a menu within a function group. The first time you press the keys simultaneously, you go back a parameter within the function group. Each time you press the keys simultaneously after that, you go up a level in the menu. - You are in a menu at a selection level. Each time you press the keys simultaneously, you go up a level in the menu. <p>Note: The terms function group, level and selection level are explained in → 31, Section 6.4.1.</p>

6.3 On-site operation – on-site display not connected

To operate the device with a HistoROM®/M-DAT module → [33](#), Section 6.5 "HistoROM®/M-DAT (optional)".

6.3.1 Level measuring mode

If no on-site display is connected, the following functions are possible by means of the three keys on the electronic insert or on the exterior of the device:

- Position adjustment (zero point correction)
- Assign the lower and upper pressure value to the lower and upper level value
- Device reset, → [27](#), Section 6.2.2 "Function of the operating elements – on-site display not connected", Table.
- The "-" and - keys only have a function in the following cases:
 - LEVEL SELECTION "Level Easy Pressure", CALIBRATION MODE "Wet"
 - LEVEL SELECTION "Level Standard", LEVEL MODE "Linear", CALIBRATION MODE "Wet"

The keys have no function in other settings.

- The device is configured for the Level measuring mode as standard. You can switch measuring modes by means of the MEASURING MODE parameter. → [35](#), Section 7.3 "Selecting language and measuring mode".

The following parameters are set to the following values in the factory:

- LEVEL SELECTION: Level Easy Pressure
- CALIBRATION MODE: Wet
- OUTPUT UNIT or LIN. MEASURAND: %
- EMPTY CALIB.: 0.0
- FULL CALIB.: 100.0.
- SET LRV: 0.0 (corresponds to 4 mA value)
- SET URV: 100.0 (corresponds to 20 mA value)

These parameters can only be modified by means of the on-site display or remote operation such as the FieldCare.

- The operation must be unlocked. → [34](#), Section 6.8 "Locking/unlocking operation".
- The pressure applied must be within the nominal pressure limits of the sensor. See information on the nameplate.



-  37, Section 7.5 "Section 7.5". For parameter description see Operating Instructions BA00274P.
- LEVEL SELECTION, CALIBRATION MODE, LEVEL MODE, EMPTY CALIB., FULL CALIB, SET LRV and SET URV are parameter names used for on-site display or remote operation such as FieldCare, for instance.

WARNING

Changing the measuring mode can affect the adjustment data!

This situation can result in product overflow.

- Check calibration data when the measuring mode is changed.

Carry out position adjustment. ¹⁾		Setting lower pressure value.		Setting upper pressure value.	
Pressure is present at device.		Desired pressure for lower pressure value (EMPTY PRESSURE ²⁾) is present at device.		Desired pressure for upper pressure value (FULL PRESSURE ¹⁾) is present at device.	
↓		↓		↓	
Press  -key for 3 s.		Press  -key for 3 s.		Press  -key for 3 s.	
↓		↓		↓	
Does the LED on the electronic insert light up briefly?		Does the LED on the electronic insert light up briefly?		Does the LED on the electronic insert light up briefly?	
Yes	No	Yes	No	Yes	No
↓	↓	↓	↓	↓	↓
Applied pressure for position adjustment has been accepted.	Applied pressure for position adjustment has not been accepted. Observe the input limits.	The pressure present was saved as the lower pressure value (EMPTY PRESSURE ²⁾) and assigned to the lower level value (EMPTY CALIB. ²⁾ .	The pressure present was not saved as the lower pressure value. Observe the input limits.	The pressure present was saved as the upper pressure value (FULL PRESSURE ²⁾) and assigned to the upper level value (FULL CALIB. ²⁾ .	The pressure present was not saved as the upper pressure value. Observe the input limits.

- 1) Observe "Warning" on →  34, Section 7 "Commissioning".
- 2) Parameter name used for the on-site display or remote operation such as the FieldCare.

6.3.2 Pressure measuring mode

If no on-site display is connected, the following functions are possible by means of the three keys on the electronic insert or on the exterior of the device:

- Position adjustment (zero point correction)
- Setting lower range value and upper range value
- Device reset, → [32](#), Section 6.2.2 "Function of the operating elements – on-site display not connected", Table.

- The operation must be unlocked. → [34](#), Section 6.8 "Locking/unlocking operation".
- The device is configured for the Level measuring mode as standard. You can switch measuring modes by means of the MEASURING MODE parameter. → [35](#), Section 7.3 "Selecting language and measuring mode".
- The pressure applied must be within the nominal pressure limits of the sensor. See information on the nameplate.

⚠ WARNING

Changing the measuring mode can affect the adjustment data!

This situation can result in product overflow.

- ▶ Check calibration data when the measuring mode is changed.

Carry out position adjustment. ¹⁾		Setting lower range value.		Setting upper range value.	
Pressure is present at device.		Desired pressure for lower range value is present at device.		Desired pressure for upper range value is present at device.	
↓		↓		↓	
Press -key for 3 s.		Press -key for 3 s.		Press -key for 3 s.	
↓		↓		↓	
Does the LED on the electronic insert light up briefly?		Does the LED on the electronic insert light up briefly?		Does the LED on the electronic insert light up briefly?	
Yes	No	Yes	No	Yes	No
↓	↓	↓	↓	↓	↓
Applied pressure for position adjustment has been accepted.	Applied pressure for position adjustment has not been accepted. Observe the input limits.	Applied pressure for lower range value has been accepted.	Applied pressure for lower range value has not been accepted. Observe the input limits.	Applied pressure for upper range value has been accepted.	Applied pressure for upper range value has not been accepted. Observe the input limits.

1) Observe "Warning" on → [34](#), Section 7 "Commissioning".

6.4 On-site operation – on-site display connected

If the on-site display is connected, the three operating keys are used to navigate through the operating menu and parameter input, →  27, Section 6.2.3 "Function of the operating elements – on-site display connected".





6.4.1 General structure of the operating menu

The menu is split into four levels. The three upper levels are used to navigate while you use the bottom level to enter numerical values, select options and save settings. The entire operating menu is shown in the operating instructions BA00274P "Cerabar S/Deltabar S/Deltapilot S, Description of Instrument Functions".

The structure of the OPERATING MENU depends on the measuring mode selected, e.g. if the "Pressure" measuring mode is selected, only the functions necessary for this mode are displayed.

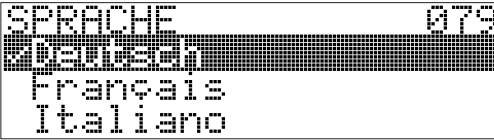
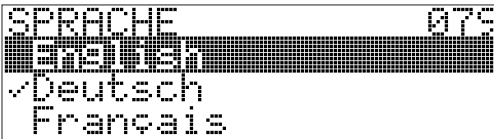

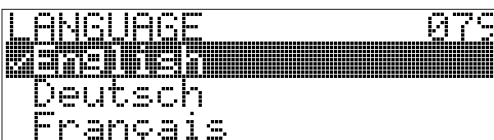





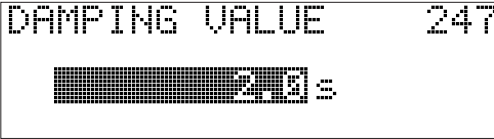
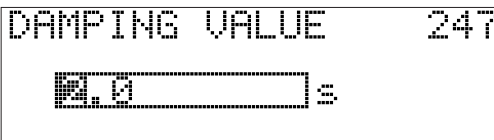

6.4.2 Selecting an option

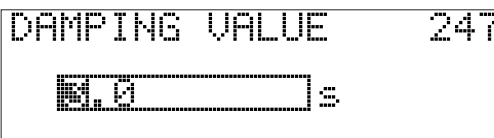
Example: select "English" as the language of the menu.

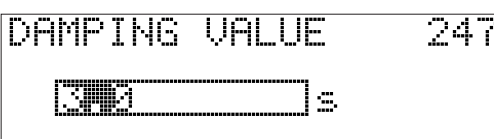
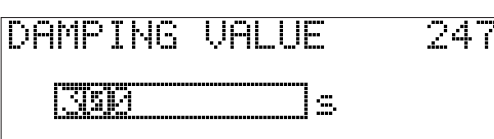
On-site display	Operation
 <p style="text-align: right; font-size: small;">P01-xxxxxxxx-19-xx-xx-xx-017</p>	<p>German is selected as the language. A ✓ in front of the menu text indicates the active option.</p>
 <p style="text-align: right; font-size: small;">P01-xxxxxxxx-19-xx-xx-xx-033</p>	<p>Select English with  or .</p>
 <p style="text-align: right; font-size: small;">P01-xxxxxxxx-19-xx-xx-xx-034</p>	<ol style="list-style-type: none"> 1. Confirm your choice with . A ✓ in front of the menu text indicates the active option. (English is now selected as the menu language.) 2. Jump to the next item with .

6.4.3 Editing a value

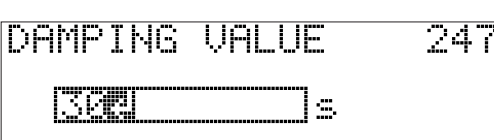

Example: adjusting DAMPING VALUE function from 2.0 s to 30.0 s. →  27, Section 6.2.3 "Function of the operating elements – on-site display connected".

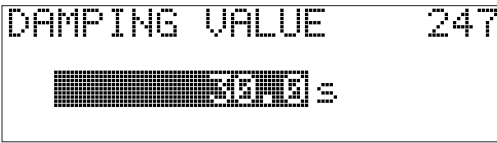
On-site display	Operation
 <p style="text-align: right; font-size: small;">P01-xxxxxxxx-19-xx-xx-xx-023</p>	<p>The on-site display shows the parameter to be changed. The value highlighted in black can be changed. The "s" unit is fixed and cannot be changed.</p>
 <p style="text-align: right; font-size: small;">P01-xxxxxxxx-19-xx-xx-xx-027</p>	<ol style="list-style-type: none"> 1. Press  or  to get to the editing mode. 2. The first digit is highlighted in black.
 <p style="text-align: right; font-size: small;">P01-xxxxxxxx-19-xx-xx-xx-028</p>	<ol style="list-style-type: none"> 1. Use  to change "2" to "3". 2. Confirm "3" with . The cursor jumps to the next position (highlighted in black).
 <p style="text-align: right; font-size: small;">P01-xxxxxxxx-19-xx-xx-xx-029</p>	<p>The decimal point is highlighted in black, i.e. you can now edit it.</p>
 <p style="text-align: right; font-size: small;">P01-xxxxxxxx-19-xx-xx-xx-030</p>	<ol style="list-style-type: none"> 1. Keep pressing  or  until "0" is displayed. 2. Confirm "0" with . The cursor jumps to the next position.  is displayed and is highlighted in black. → See next graphic.
 <p style="text-align: right; font-size: small;">P01-xxxxxxxx-19-xx-xx-xx-031</p>	<p>Use  to save the new value and exit the editing mode. → See next graphic.</p>

On-site display	Operation
 <p style="text-align: right; font-size: small;">P01-xxxxxxxx-19-xx-xx-xx-032</p>	<p>The new value for the damping is now 30.0 s.</p> <ul style="list-style-type: none"> - Jump to the next parameter with <input type="checkbox"/>. - You can get back to the editing mode with <input type="checkbox"/> or <input type="checkbox"/>.

6.4.4 Taking pressure applied at device as value

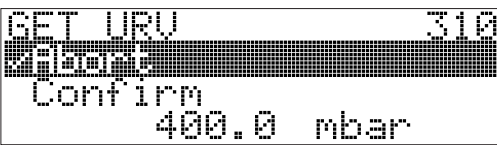
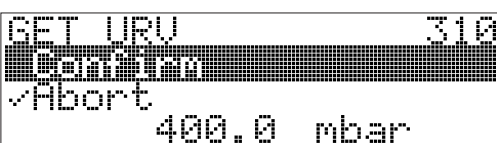
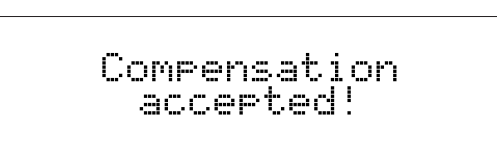
Example: configuring upper range value – assign 20 mA to the pressure value 400 mbar.

On-site display	Operation
 <p style="text-align: right; font-size: small;">P01-xxxxxxxx-19-xx-xx-xx-035</p>	<p>The bottom line on the on-site display displays the pressure present, here 400 mbar.</p>
 <p style="text-align: right; font-size: small;">P01-xxxxxxxx-19-xx-xx-xx-036</p>	<p>Use <input type="checkbox"/> or <input type="checkbox"/> to switch to the "Confirm" option. The active selection is highlighted in black.</p>
 <p style="text-align: right; font-size: small;">P01-xxxxxxxx-19-xx-xx-xx-037</p>	<p>Use <input type="checkbox"/> to assign the value (400 mbar) to the GET URV parameter. The device confirms the calibration and jumps back to the parameter, here GET URV (see next graphic).</p>
 <p style="text-align: right; font-size: small;">P01-xxxxxxxx-19-xx-xx-xx-035</p>	<p>Switch to the next parameter with <input type="checkbox"/>.</p>

6.5 HistoROM®/M-DAT (optional)

See operating instructions.

6.6 Operation via SFX100

See operating instructions.

6.7 Endress+Hauser operating program

See operating instructions.

6.8 Locking/unlocking operation

See operating instructions.

6.9 Factory setting (reset)

See operating instructions.

7 Commissioning

The device is configured for the level measuring mode as standard. The measuring range and the unit in which the measured value is transmitted correspond to the specifications on the nameplate.

⚠ WARNING

Exceeding the maximum allowable working pressure!

Risk of injury due to bursting of parts! Warning messages are generated if pressure is too high.

- ▶ If a pressure greater than the maximum permitted pressure is present at the device, the messages "E115 Sensor overpressure" and "E727 Sensor pressure error - overrange" are output in succession! Use the device only within the sensor range limits

NOTICE

Shortfall of the allowable working pressure!

Output of messages if pressure is too low.

- ▶ If a pressure smaller than the minimum permitted pressure is present at the device, the messages "E120 Sensor low pressure" and "E727 Sensor pressure error - overrange" are output in succession! Use the device only within the sensor range limits

7.1 Configuring messages

- Messages E727, E115 and E120 are "Error"-type messages and can be configured as a "Warning" or an "Alarm". These messages are configured as "Warning" messages at the factory. This setting prevents the current output from assuming the set alarm current value for applications (e.g. cascade measurement) where the user is consciously aware of the fact that the sensor range can be exceeded.
- We recommend setting messages E727, E115 and E120 to "Alarm" in the following instances:
 - The sensor range does not have to be exceeded for the measuring application.
 - Position adjustment has to be carried out that has to correct a large measured error as a result of the orientation of the device (e.g. devices with a diaphragm seal).

7.2 Function check

Carry out a post-installation and a post-connection check as per the checklist before commissioning the device.

- "Post-installation check" checklist → see Section 4.5
- "Post-connection check" checklist → see Section 5.5

7.3 Selecting language and measuring mode

7.3.1 On-site operation

The LANGUAGE and MEASURING MODE parameters are located on the top menu level.

The following measuring modes are available:

- Pressure
- Level

7.3.2 Digital communication

The following measuring modes are available:

- Pressure
- Level

The LANGUAGE parameter is arranged in the DISPLAY group (OPERATING MENU → DISPLAY).

- Use the LANGUAGE parameter to select the menu language for the on-site display.
- Select the menu language for ToF Tool via the "Options" menu → "Options" → "Display" → "Language".
- Select the menu language for FieldCare by means of the "Language Button" in the configuration window. Select the menu language for the FieldCare frame via the "Extra" menu → "Options" → "Display" → "Language".

7.4 Position adjustment

Due to the orientation of the device, there may be a shift in the measured value, i.e. when the container is empty, the measured value parameter does not display zero. There are three options

to choose from when performing position adjustment.
 (Menu path: (GROUP SELECTION →) OPERATING MENU → SETTINGS → POSITION ADJUSTMENT)

Parameter name	Description
POS. ZERO ADJUST (685) Entry	<p>Position adjustment – the pressure difference between zero (set point) and the measured pressure need not be known.</p> <p>Example:</p> <ul style="list-style-type: none"> – MEASURED VALUE = 2.2 mbar (0.032 psi) – Correct the MEASURED VALUE via the POS. ZERO ADJUST parameter with the "Confirm" option. This means that you are assigning the value 0.0 to the pressure present. – MEASURED VALUE (after pos. zero adjust) = 0.0 mbar – The current value is also corrected. <p>The CALIB. OFFSET parameter displays the resulting pressure difference (offset) by which the MEASURED VALUE was corrected.</p> <p>Factory setting: 0.0</p>
POS. INPUT VALUE (563) Entry	<p>Position adjustment – the pressure difference between zero (set point) and the measured pressure need not be known. To correct the pressure difference, you need a reference measurement value (e. g. from a reference device).</p> <p>Example:</p> <ul style="list-style-type: none"> – MEASURED VALUE = 0.5 mbar (0.0073 psi) – For the POS. INPUT VALUE parameter, specify the desired set point for the MEASURED VALUE, e.g. 2.0 mbar (0.029 psi). (MEASURED VALUE_{new} = POS. INPUT VALUE) – MEASURED VALUE (after entry for POS. INPUT VALUE) = 2.0 mbar (0.029 psi) – The CALIB. OFFSET parameter displays the resulting pressure difference (offset) by which the MEASURED VALUE was corrected. CALIB. OFFSET = MEASURED VALUE_{old} – POS. INPUT VALUE, here: CALIB. OFFSET = 0.5 mbar (0.0073 psi) – 2.0 mbar (0.029 psi) = – 1.5 mbar (0.022 psi) – The current value is also corrected. <p>Factory setting: 0.0</p>
CALIB. OFFSET (319) Entry	<p>Position adjustment – the pressure difference between zero (set point) and the measured pressure is known.</p> <p>Example:</p> <ul style="list-style-type: none"> – MEASURED VALUE = 2.2 mbar (0.032 psi) – Via the CALIB. OFFSET parameter, enter the value by which the MEASURED VALUE should be corrected. To correct the MEASURED VALUE to 0.0 mbar, you must enter the value 2.2 here. (MEASURED VALUE_{new} = MEASURED VALUE_{old} – CALIB. OFFSET) – MEASURED VALUE (after entry for calib. offset) = 0.0 mbar – The current value is also corrected. <p>Factory setting: 0.0</p>

7.5 Level measurement

7.5.1 Information on level measurement

- The Pressure and Level operating modes each have a quick setup menu which guides you through the most important basic functions. See →  40 for the "Level" quick setup menu.
- Furthermore, the three level modes "Level Easy Pressure", "Level Easy Height" and "Level Standard" are available to you for level measurement. You can select from the "Linear", "Pressure linearized" and "Height linearized" level types for the "Level Standard" level mode. The table in the "Overview of level measurement" section below provides an overview of the various measuring tasks.
 - In the "Level Easy Pressure" and "Level Easy Height" level modes, the values entered are not tested as extensively as in the "Level Standard" level mode. The values entered for EMPTY CALIB./FULL CALIB., EMPTY PRESSURE/FULL PRESSURE, EMPTY HEIGHT/FULL HEIGHT and SET LRV/SET URV must have a minimum interval of 1% for the "Level Easy Pressure" and "Level Easy Height" level modes. The value will be rejected with a warning message if the values are too close together. Further limit values are not checked; i.e. the values entered must be appropriate for the sensor and the measuring task so that the measuring device can measure correctly.
 - The "Level Easy Pressure" and "Level Easy Height" level modes encompass fewer parameters than the "Level Standard" mode and are used for quick and easy configuration of a level application.
 - Customer-specific units of fill level, volume and mass or a linearization table may only be entered in the "Level Standard" level mode.
 - Where the device is intended for use as a subsystem in a safety function (SIL), a "Device configuration with enhanced parameter security" (SAFETY CONFIRM.) is only possible for the "Level" operating mode in the "Level Easy Pressure" level mode. All parameters previously entered are checked after a password is entered. Once the "Level Easy Height" or "Level Standard" has been selected, the configuration will first have to be reset to the ex-works setting using the RESET parameter (menu path: (GROUP SELECTION →) OPERATING MENU → OPERATION) using the reset code "7864". → For further information see the Deltapilot S (SD00213P) Functional Safety Manual.
- See the Operating Instructions BA00274P "Cerabar S/Deltabar S/Deltapilot S, Description of device functions".

WARNING

Changing the measuring mode can affect the adjustment data!

This situation can result in product overflow.

- ▶ Check calibration data when the measuring mode is changed.

7.5.2 Overview of level measurement

Measuring task	LEVEL SELECTION/ LEVEL MODE	Measured variable options	Description	Comment	Measured value display
The measured variable is in direct proportion to the measured pressure. Calibration is performed by entering two pressure-level value pairs.	LEVEL SELECTION: Level Easy Pressure	Via OUTPUT UNIT parameter: %, level, volume or mass units.	<ul style="list-style-type: none"> - Calibration with reference pressure – wet calibration, see Operating Instructions BA00274P. - Calibration without reference pressure – dry calibration, see Operating Instructions BA00274P. 	<ul style="list-style-type: none"> - Incorrect entries are possible - SIL mode possible - Customised units are not possible 	The measured value display and the LEVEL BEFORE LIN parameter show the measured value.
The measured variable is in direct proportion to the measured pressure. Calibration is performed by entering the density and two height-level value pairs.	LEVEL SELECTION: Level Easy Height	Via OUTPUT UNIT parameter: %, level, volume or mass units.	<ul style="list-style-type: none"> - Calibration with reference pressure – wet calibration, see Operating Instructions BA00274P. - Calibration without reference pressure – dry calibration, see Operating Instructions BA00274P. 	<ul style="list-style-type: none"> - Incorrect entries are possible - SIL mode not possible - Customised units are not possible 	The measured value display and the LEVEL BEFORE LIN parameter show the measured value.
The measured variable is in direct proportion to the measured pressure.	LEVEL SELECTION: Level standard/ LEVEL MODE: Linear	Via LIN. MEASURAND parameter: <ul style="list-style-type: none"> - % (level) - Level - Volume - Mass 	<ul style="list-style-type: none"> - Calibration with reference pressure – wet calibration, see Operating Instructions BA00274P. - Calibration without reference pressure – dry calibration, see Operating Instructions BA00274P. 	<ul style="list-style-type: none"> - Incorrect entries are rejected by the device - SIL mode not possible - Customised level, volume and mass units are possible 	The measured value display and the LEVEL BEFORE LIN parameter show the measured value.

Measuring task	LEVEL SELECTION/ LEVEL MODE	Measured variable options	Description	Comment	Measured value display
The measured variable is not in direct proportion to the measured pressure as, for example, with containers with a conical outlet. A linearisation table must be entered for the calibration.	LEVEL SELECTION: Level standard/ LEVEL MODE: Pressure linearized	Via LIND MEASURAND parameter: - Pressure + % - Pressure + volume - Pressure + mass	- Calibration with reference pressure: semiautomatic entry of linearisation table, see Operating Instructions BA00274P. - Calibration without reference pressure: manual entry of linearisation table, see Operating Instructions BA00274P.	- Incorrect entries are rejected by the device - SIL mode not possible - Customised level, volume and mass units are possible	The measured value display and the TANK CONTENT parameter show the measured value.
- Two measured variables are required or - The container shape is given by value pairs, such as height and volume. The 1st measured variable %-height or height must be in direct proportion to the measured pressure. The 2nd measured variable volume, mass or % must not be in direct proportion to the measured pressure. A linearisation table must be entered for the 2nd measured variable. The 2nd measured variable is assigned to the 1st measured variable by means of this table.	LEVEL SELECTION: Level standard/ LEVEL MODE: Height linearized	Via COMB. MEASURAND parameter: - Height + volume - Height + mass - Height + % - %-Height + volume - %-Height + mass - %-Height + %	- Calibration with reference pressure: wet calibration and semiautomatic entry of linearisation table, see Operating Instructions BA00274P. - Calibration without reference pressure: dry calibration and manual entry of linearisation table, see Operating Instructions BA00274P.	- Incorrect entries are rejected by the device - SIL mode not possible - Customised level, volume and mass units are possible	The measured value display and the TANK CONTENT parameter show the 2nd measured value (volume, mass or %). The LEVEL BEFORE LIN parameter displays the 1st measured value (%-height or height).

7.5.3 Quick Setup menu for Level measuring mode

- On-site display: Some parameters are only displayed if other parameters are appropriately configured. For example, the EMPTY CALIB. parameter is only displayed in the following cases:

- LEVEL SELECTION "Level Easy Pressure" and CALIBRATION MODE "Wet"
- LEVEL SELECTION "Level Standard", LEVEL MODE "Linear" and CALIBRATION MODE "WET"

You can find the LEVEL MODE parameter in the BASIC SETTINGS function group (menu path: (GROUP SELECTION →) OPERATING MENU → SETTINGS → BASIC SETTINGS).



- The following parameters are set to the following values in the factory:
 - LEVEL SELECTION: Level Easy Pressure
 - CALIBRATION MODE: Wet
 - OUTPUT UNIT or LIN. MEASURAND: %
 - EMPTY CALIB.: 0.0
 - FULL CALIB.: 100.0
 - SET LRV (BASIC SETTINGS group): 0.0 (corresponds to 4 mA value)
 - SET URV (BASIC SETTINGS group): 100.0 (corresponds to 20 mA value).
- The quick setup is suitable for simple and quick commissioning. If you wish to make more complex settings, e.g. change the unit from "%" to "m", you will have to calibrate using the BASIC SETTINGS group. → See Operating Instructions BA00274P.

⚠ WARNING

Changing the measuring mode can affect the adjustment data!



This situation can result in product overflow.

- ▶ Check calibration data when the measuring mode is changed.

On-site operation	Digital communication
Measured value display On-site display: Switch from the measured value display to GROUP SELECTION with  .	See BA00274P.
GROUP SELECTION Select MEASURING MODE.	
MEASURING MODE Select "Level" option.	
LEVEL SELECTION Select level mode. For an overview see →  38.	
GROUP SELECTION Select QUICK SETUP menu.	
POS. ZERO ADJUST Due to orientation of the device, there may be a shift in the measured value. You correct the MEASURED VALUE via the POS. ZERO ADJUST parameter with the "Confirm" option, i. e. you assign the value 0.0 to the pressure present.	

On-site operation	Digital communication
EMPTY CALIB. ¹⁾ (produce appropriate level) Enter level for the lower calibration point. For this parameter, enter a level value which is assigned to the pressure present at the device.	
FULL CALIB. ¹⁾ (produce appropriate level) Enter level for the upper calibration point. For this parameter, enter a level value which is assigned to the pressure present at the device.	
DAMPING TIME Enter damping time (time constant τ). The damping affects the speed at which all subsequent elements, such as the on-site display, measured value and current output react to a change in the pressure.	

- 1) – LEVEL SELECTION "Level Easy Pressure" and CALIBRATION MODE "Wet"
 – LEVEL SELECTION "Level Standard", LEVEL MODE "Linear" and CALIBRATION MODE "Wet"

For on-site operation, see also →  27, Section 6.2.3 "Function of the operating elements – on-site display connected" and →  31, Section 6.4 ff "Operating elements".

7.6 Pressure measurement

7.6.1 Information on pressure measurement

- There is a Quick Setup menu for each of the measuring modes Pressure and Level which guides you through the most important basic functions. With the setting in the MEASURING MODE parameter, you specify which Quick Setup menu should be displayed. →  35, Section 7.3 "Selecting language and measuring mode".
- For a detailed description of the parameters see the Operating Instructions BA00274P "Cerabar S/Deltabar S/Deltapilot S, Description of device functions"
 - Table 6, POSITION ADJUSTMENT
 - Table 7, BASIC SETUP
 - Table 15, EXTENDED SETUP
- For pressure measurement, select the "Pressure" option by means of the MEASURING MODE parameter. The operating menu is structured appropriately.

WARNING



Changing the measuring mode can affect the adjustment data!

This situation can result in product overflow.

- ▶ Check calibration data when the measuring mode is changed.

7.6.2 Quick Setup menu for Pressure measuring mode

On-site operation	Digital communication
<p>Measured value display On-site display: Switch from the measured value display to GROUP SELECTION with .</p>	See BA00274P.
<p>GROUP SELECTION Select MEASURING MODE.</p>	
<p>MEASURING MODE Select "Pressure" option.</p>	
<p>GROUP SELECTION Select QUICK SETUP menu.</p>	
<p>POS. ZERO ADJUST Due to orientation of the device, there may be a shift in the measured value. You correct the MEASURED VALUE via the POS. ZERO ADJUST parameter with the "Confirm" option, i. e. you assign the value 0.0 to the pressure present.</p>	
<p>SET LRV Set the measuring range (enter 4 mA value). Specify a pressure value for the lower current value (4 mA value). A reference pressure does not have to be present at the device.</p>	
<p>SET URV Set the measuring range (enter 20 mA value). Specify a pressure value for the upper current value (20 mA value). A reference pressure does not have to be present at the device.</p>	
<p>DAMPING TIME Enter damping time (time constant τ). The damping affects the speed at which all subsequent elements, such as the on-site display, measured value and current output react to a change in the pressure.</p>	

For on-site operation, →  27, Section 6.2.3 "Function of the operating elements – on-site display connected" and →  31, Section 6.4 ff "Operating elements".



71336352

www.addresses.endress.com
