

Brief Operating Instructions

Proline Promag H 200

Electromagnetic flowmeter

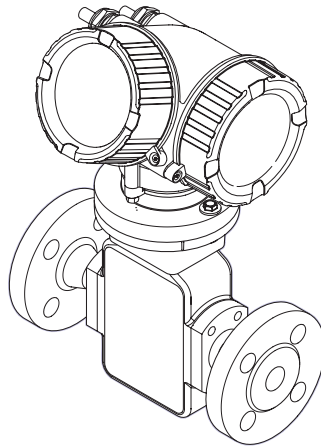

These Instructions are Brief Operating Instructions; they are not a substitute for the Operating Instructions pertaining to the device.

Detailed information about the device can be found in the Operating Instructions and the other documentation:

- On the CD-ROM supplied (not included in the delivery for all device versions).
- Available for all device versions via:
 - Internet: www.endress.com/deviceviewer
 - Smart phone/tablet: *Endress+Hauser Operations App*

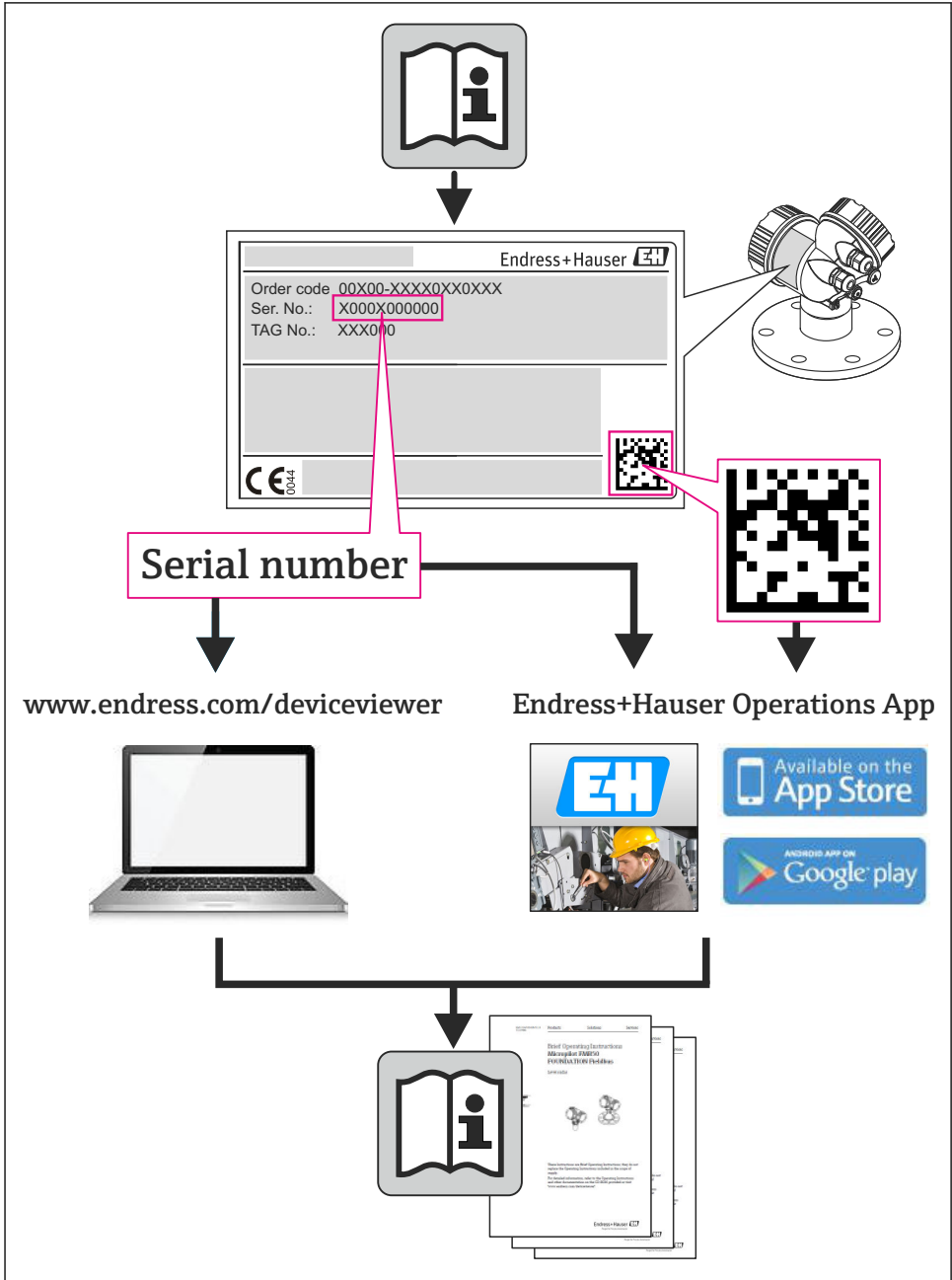

A0023555





Table of contents

1	Document information	4
1.1	Symbols used	4
2	Basic safety instructions	5
2.1	Requirements for the personnel	5
2.2	Designated use	6
2.3	Workplace safety	7
2.4	Operational safety	7
2.5	Product safety	7
2.6	IT security	7
3	Product description	7
3.1	Product design	8
4	Incoming acceptance and product identification	9
4.1	Incoming acceptance	9
4.2	Product identification	10
5	Storage and transport	10
5.1	Storage conditions	10
5.2	Transporting the product	10
6	Installation	12
6.1	Installation conditions	12
6.2	Mounting the measuring device	16
6.3	Post-installation check	21
7	Electrical connection	23
7.1	Connection conditions	23
7.2	Connecting the measuring device	29
7.3	Hardware settings	31
7.4	Ensuring the degree of protection	33
7.5	Post-connection check	33
8	Operation options	34
8.1	Structure and function of the operating menu	34
8.2	Access to the operating menu via the local display	35
8.3	Access to the operating menu via the operating tool	39
9	System integration	39
9.1	FOUNDATION Fieldbus cyclic data transmission	39
9.2	Cyclic data transfer PROFIBUS PA	42
10	Commissioning	45
10.1	Function check	45
10.2	Switching on the measuring device	46
10.3	Setting the operating language	46
10.4	Configuring the measuring device	46
10.5	Defining the tag name	47
10.6	Protecting settings from unauthorized access	47
11	Diagnostic information	48







1 Document information

1.1 Symbols used





1.1.1 Safety symbols

Symbol	Meaning
	DANGER! This symbol alerts you to a dangerous situation. Failure to avoid this situation will result in serious or fatal injury.
	WARNING! This symbol alerts you to a dangerous situation. Failure to avoid this situation can result in serious or fatal injury.
	CAUTION! This symbol alerts you to a dangerous situation. Failure to avoid this situation can result in minor or medium injury.
	NOTE! This symbol contains information on procedures and other facts which do not result in personal injury.









1.1.2 Electrical symbols

Symbol	Meaning	Symbol	Meaning
	Direct current		Alternating current
	Direct current and alternating current		Ground connection A grounded terminal which, as far as the operator is concerned, is grounded via a grounding system.
	Protective ground connection A terminal which must be connected to ground prior to establishing any other connections.		Equipotential connection A connection that has to be connected to the plant grounding system: This may be a potential equalization line or a star grounding system depending on national or company codes of practice.



1.1.3 Tool symbols

Symbol	Meaning	Symbol	Meaning
	Torx screwdriver		Flat blade screwdriver
	Phillips head screwdriver		Allen key
	Open-ended wrench		

1.1.4 Symbols for certain types of information

Symbol	Meaning	Symbol	Meaning
	Permitted Procedures, processes or actions that are permitted.		Preferred Procedures, processes or actions that are preferred.
	Forbidden Procedures, processes or actions that are forbidden.		Tip Indicates additional information.
	Reference to documentation		Reference to page
	Reference to graphic	1. 2. 3. ...	Series of steps
	Result of a step		Visual inspection

1.1.5 Symbols in graphics

Symbol	Meaning	Symbol	Meaning
1, 2, 3, ...	Item numbers	1. 2. 3. ...	Series of steps
A, B, C, ...	Views	A-A, B-B, C-C, ...	Sections
	Hazardous area		Safe area (non-hazardous area)
	Flow direction		

2 Basic safety instructions

2.1 Requirements for the personnel

The personnel must fulfill the following requirements for its tasks:

- ▶ Trained, qualified specialists must have a relevant qualification for this specific function and task
- ▶ Are authorized by the plant owner/operator
- ▶ Are familiar with federal/national regulations
- ▶ Before beginning work, the specialist staff must have read and understood the instructions in the Operating Instructions and supplementary documentation as well as in the certificates (depending on the application)
- ▶ Following instructions and basic conditions

2.2 Designated use

Application and media

The measuring device is only suitable for flow measurement of liquids with a minimum conductivity of 20 $\mu\text{S}/\text{cm}$.

Depending on the version ordered, the measuring device can also measure potentially explosive, flammable, poisonous and oxidizing media.

Measuring devices for use in hazardous areas, in hygienic applications or in applications where there is an increased risk due to process pressure, are labeled accordingly on the nameplate.

To ensure that the measuring device remains in proper condition for the operation time:

- ▶ Only use the measuring device in full compliance with the data on the nameplate and the general conditions listed in the Operating Instructions and supplementary documentation.
- ▶ Check the nameplate to verify if the device ordered can be put to its intended use in the approval-related area (e.g. explosion protection, pressure vessel safety).
- ▶ Use the measuring device only for media against which the process-wetted materials are adequately resistant.
- ▶ If the measuring device is not operated at atmospheric temperature, compliance with the relevant basic conditions specified in the associated device documentation is absolutely essential.
- ▶ Protect the measuring device permanently against corrosion from environmental influences.

Incorrect use

Non-designated use can compromise safety. The manufacturer is not liable for damage caused by improper or non-designated use.

WARNING

Danger of breakage of the sensor due to corrosive or abrasive fluids or from environmental conditions!

- ▶ Verify the compatibility of the process fluid with the sensor material.
- ▶ Ensure the resistance of all fluid-wetted materials in the process.
- ▶ Keep within the specified pressure and temperature range.

Verification for borderline cases:

- ▶ For special fluids and fluids for cleaning, Endress+Hauser is glad to provide assistance in verifying the corrosion resistance of fluid-wetted materials, but does not accept any warranty or liability as minute changes in the temperature, concentration or level of contamination in the process can alter the corrosion resistance properties.

Residual risks

The external surface temperature of the housing can increase by max. 10 K due to the power consumption of the electronic components. Hot process fluids passing through the measuring device will further increase the surface temperature of the housing. The surface of the sensor, in particular, can reach temperatures which are close to the fluid temperature.

Possible burn hazard due to fluid temperatures!

- ▶ For elevated fluid temperature, ensure protection against contact to prevent burns.

2.3 Workplace safety

For work on and with the device:

- ▶ Wear the required personal protective equipment according to federal/national regulations.

For welding work on the piping:

- ▶ Do not ground the welding unit via the measuring device.

If working on and with the device with wet hands:

- ▶ It is recommended to wear gloves on account of the higher risk of electric shock.

2.4 Operational safety

Risk of injury.

- ▶ Operate the device in proper technical condition and fail-safe condition only.
- ▶ The operator is responsible for interference-free operation of the device.

2.5 Product safety

This measuring device is designed in accordance with good engineering practice to meet state-of-the-art safety requirements, has been tested, and left the factory in a condition in which it is safe to operate.

It meets general safety standards and legal requirements. It also complies with the EC directives listed in the device-specific EC Declaration of Conformity. Endress+Hauser confirms this by affixing the CE mark to the device.

2.6 IT security

We only provide a warranty if the device is installed and used as described in the Operating Instructions. The device is equipped with security mechanisms to protect it against any inadvertent changes to the device settings.

IT security measures in line with operators' security standards and designed to provide additional protection for the device and device data transfer must be implemented by the operators themselves.

3 Product description

The device consists of a transmitter and a sensor.

The device is available as a compact version:

The transmitter and sensor form a mechanical unit.



For detailed information on the product description, see the Operating Instructions for the device.

3.1 Product design

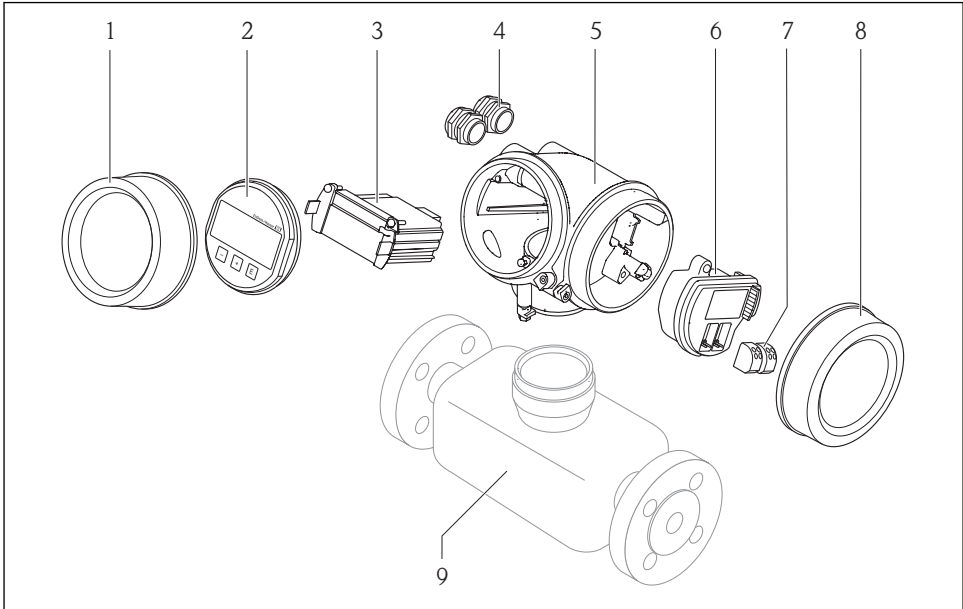

A0014056

1 Important components of a measuring device

- 1 Electronics compartment cover
- 2 Display module
- 3 Main electronics module
- 4 Cable glands
- 5 Transmitter housing (incl. integrated HistoROM)
- 6 I/O electronics module
- 7 Terminals (pluggable spring terminals)
- 8 Connection compartment cover
- 9 Sensor

4 Incoming acceptance and product identification

4.1 Incoming acceptance



1
+
2

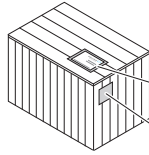

1
+
2

Are the order codes on the delivery note (1) and the product sticker (2) identical?

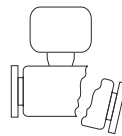
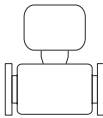
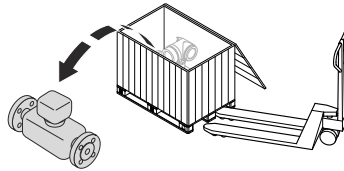

Are the goods undamaged?

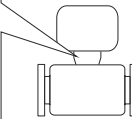
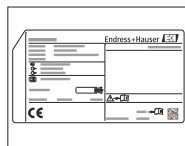

Do the nameplate data match the ordering information on the delivery note?



Is the CD-ROM with the Technical Documentation (depends on device version) and documents present?



- If one of the conditions is not satisfied, contact your Endress+Hauser Sales Center.
- Depending on the device version, the CD-ROM might not be part of the delivery! The Technical Documentation is available via the Internet or via the *Endress+Hauser Operations App*.

4.2 Product identification

The following options are available for identification of the measuring device:

- Nameplate specifications
- Order code with breakdown of the device features on the delivery note
- Enter serial numbers from nameplates in *W@M Device Viewer* (www.endress.com/deviceviewer): All information about the measuring device is displayed.
- Enter the serial number from the nameplates into the *Endress+Hauser Operations App* or scan the 2-D matrix code (QR code) on the nameplate with the *Endress+Hauser Operations App*: all the information for the measuring device is displayed.

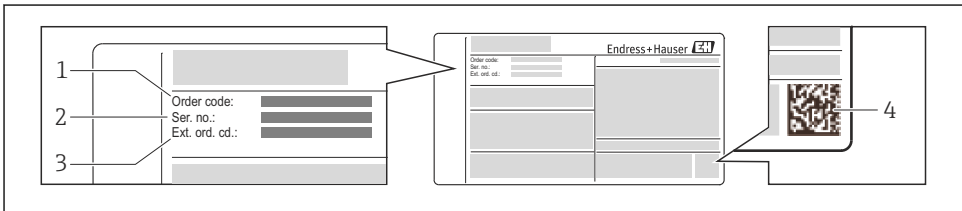

A0021952

2 Example of a nameplate

- 1 Order code
- 2 Serial number (Ser. no.)
- 3 Extended order code (Ext. ord. cd.)
- 4 2-D matrix code (QR code)

 For detailed information on the breakdown of the specifications on the nameplate, see the Operating Instructions for the device .

5 Storage and transport

5.1 Storage conditions

Observe the following notes for storage:

- Store in original packaging.
- Do not remove protective covers or protective caps installed on process connections.
- Protect from direct sunlight.
- Select a storage location where moisture cannot collect in the measuring device.
- Store in a dry and dust-free place.
- Do not store outdoors.

Storage temperature →  12

5.2 Transporting the product

Transport the measuring device to the measuring point in the original packaging.

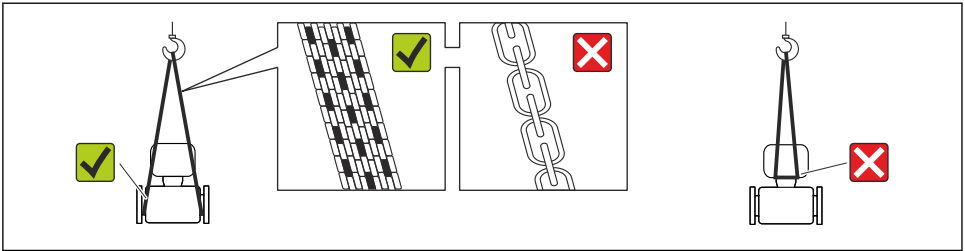

A0015604

i Do not remove protective covers or caps installed on process connections. They prevent mechanical damage to the sealing surfaces and contamination in the measuring tube.

5.2.1 Measuring devices without lifting lugs

⚠ WARNING

Center of gravity of the measuring device is higher than the suspension points of the webbing slings.

Risk of injury if the measuring device slips.

- ▶ Secure the measuring device against slipping or turning.
- ▶ Observe the weight specified on the packaging (stick-on label).

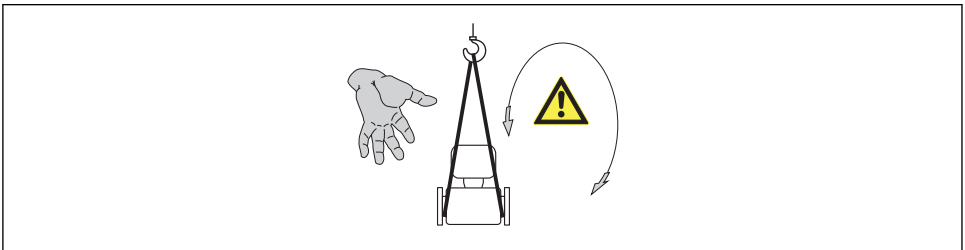

A0015606

5.2.2 Measuring devices with lifting lugs

⚠ CAUTION

Special transportation instructions for devices with lifting lugs

- ▶ Only use the lifting lugs fitted on the device or flanges to transport the device.
- ▶ The device must always be secured at two lifting lugs at least.

5.2.3 Transporting with a fork lift

If transporting in wood crates, the floor structure enables the crates to be lifted lengthwise or at both sides using a forklift.

⚠ CAUTION

Risk of damaging the magnetic coil

- ▶ If transporting by forklift, do not lift the sensor by the metal casing.
- ▶ This would buckle the casing and damage the internal magnetic coils.

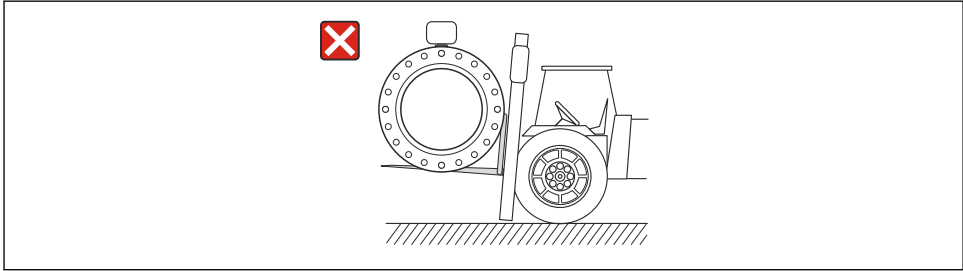

A0023726

6 Installation

6.1 Installation conditions

6.1.1 Mounting position

Mounting location

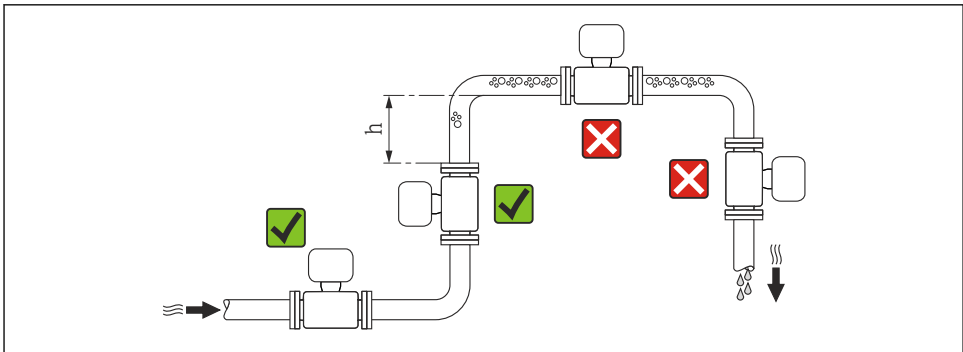

A0023343

$$h \geq 2 \times DN$$

Installation in down pipes

Install a siphon with a vent valve downstream of the sensor in down pipes whose length $h \geq 5 \text{ m}$ (16.4 ft). This precaution is to avoid low pressure and the consequent risk of damage to the measuring tube. This measure also prevents the system losing prime.

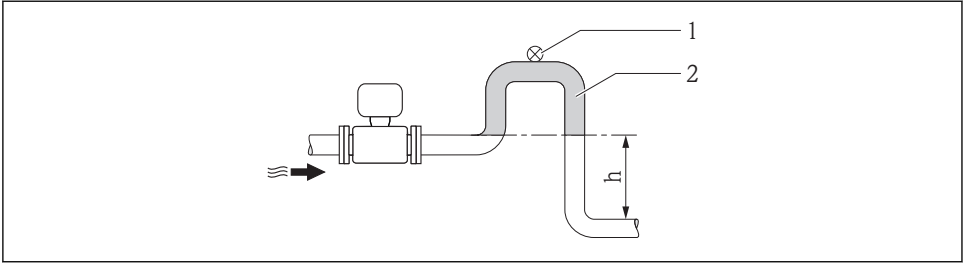

A0017064

3 Installation in a down pipe

- 1 Vent valve
- 2 Pipe siphon
- h Length of down pipe

Installation in partially filled pipes

A partially filled pipe with a gradient necessitates a drain-type configuration.

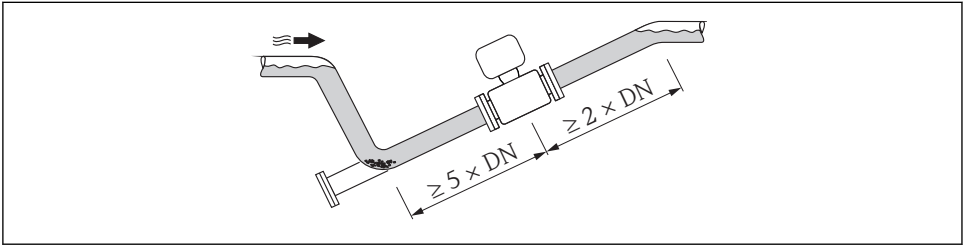

A0017063

Orientation

The direction of the arrow on the sensor nameplate helps you to install the sensor according to the flow direction.

An optimum orientation position helps avoid gas and air accumulations and deposits in the measuring tube.

Vertical

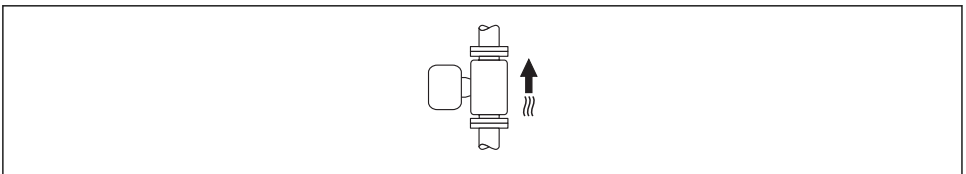

A0015591

Optimum for self-emptying pipe systems and for use in conjunction with empty pipe detection.

Horizontal

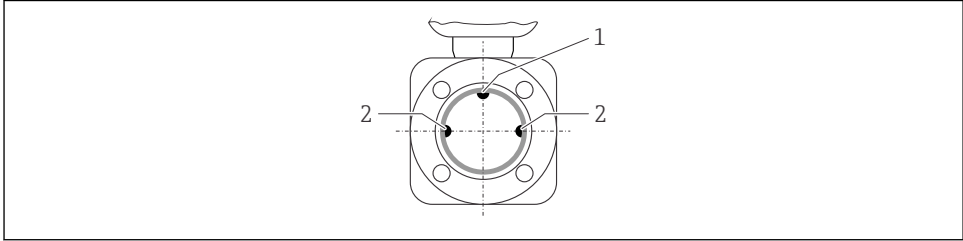

A0019602

- 1 EPD electrode for empty pipe detection
2 Measuring electrodes for signal detection

-  The measuring electrode plane must be horizontal. This prevents brief insulation of the two measuring electrodes by entrained air bubbles.
- Empty pipe detection only works if the transmitter housing is pointing upwards as otherwise there is no guarantee that the empty pipe detection function will actually respond to a partially filled or empty measuring tube.

Inlet and outlet runs

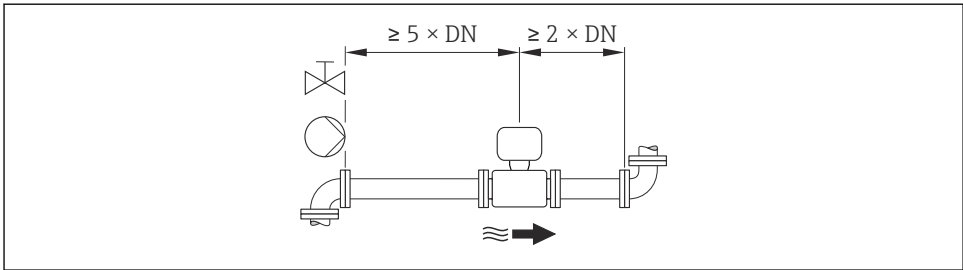

A0016275

 For the dimensions and installation lengths of the device, see the "Technical Information" document, "Mechanical construction" section

6.1.2 Requirements from environment and process

Ambient temperature range

 For detailed information on the ambient temperature range, see the Operating Instructions for the device.

If operating outdoors:

- Install the measuring device in a shady location.
- Avoid direct sunlight, particularly in warm climatic regions.
- Avoid direct exposure to weather conditions.

Temperature tables



Observe the interdependencies between the permitted ambient and fluid temperatures when operating the device in hazardous areas.



For detailed information on the temperature tables, see the separate document entitled "Safety Instructions" (XA) for the device.

System pressure

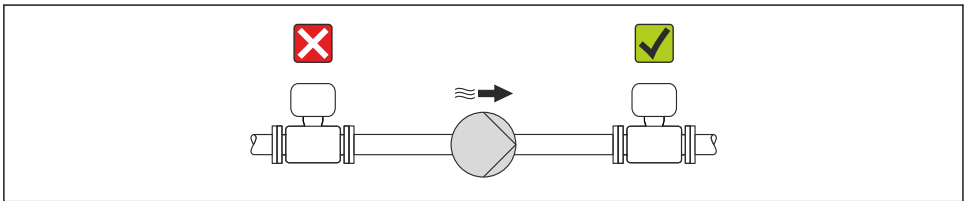

A0015594



Furthermore, install pulse dampers if reciprocating, diaphragm or peristaltic pumps are used.

Vibrations

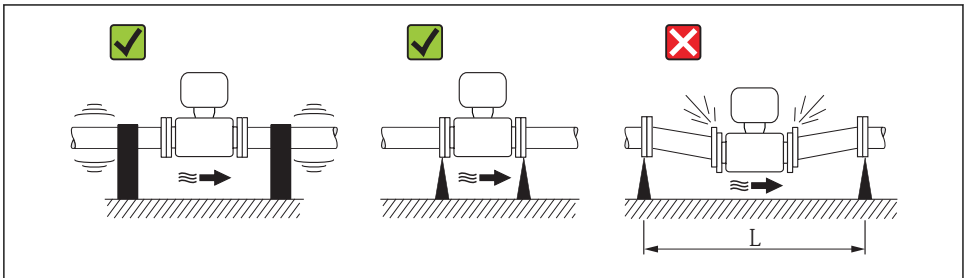

A0016266

- 4 Measures to avoid device vibrations ($L > 10\text{ m (33 ft)}$)

Adapters

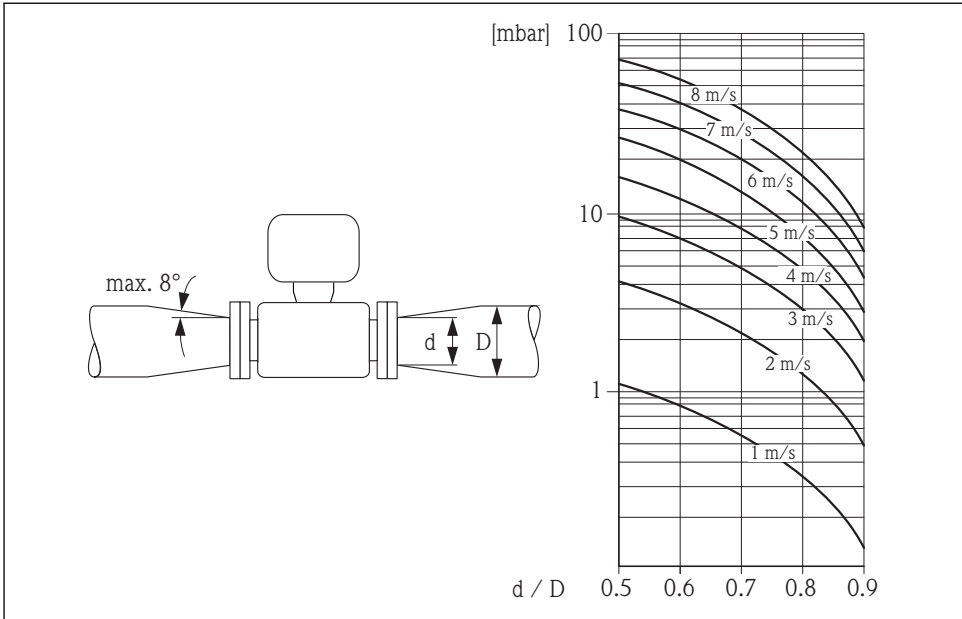

A0016359

6.1.3 Special mounting instructions

Display protection

- To ensure that the optional display protection can be easily opened, maintain the following minimum head clearance: 350 mm (13.8 in)

6.2 Mounting the measuring device

6.2.1 Required tools

For transmitter

- For turning the transmitter housing: Open-ended wrench 8 mm
- For opening the securing clamps: Allen key 3 mm

For sensor

For flanges and other process connections:

- Screws, nuts, seals etc. are not included in the scope of supply and must be provided by the customer.
- Appropriate mounting tools

6.2.2 Preparing the measuring device

1. Remove all remaining transport packaging.
2. Remove any protective covers or protective caps present from the sensor.
3. Remove stick-on label on the electronics compartment cover.

6.2.3 Mounting the sensor

WARNING

Danger due to improper process sealing!

- ▶ Ensure that the inside diameters of the gaskets are greater than or equal to that of the process connections and piping.
 - ▶ Ensure that the gaskets are clean and undamaged.
 - ▶ Install the gaskets correctly.
1. Ensure that the direction of the arrow on the sensor matches the flow direction of the medium.
 2. To ensure compliance with device specifications, install the measuring device between the pipe flanges in a way that it is centered in the measurement section.
 3. Install the measuring device or turn the transmitter housing so that the cable entries do not point upwards.

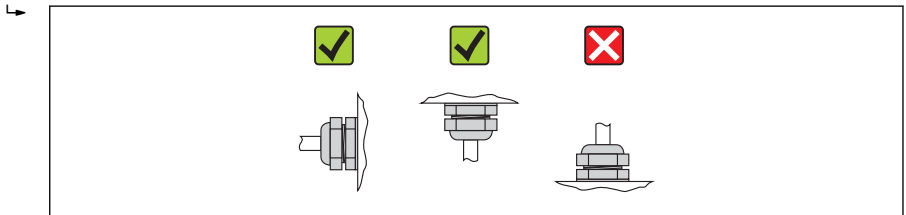

A0013964

The sensor is supplied to order, with or without pre-installed process connections. Pre-installed process connections are firmly secured to the sensor by 4 or 6 hexagonal-headed bolts.

-  The sensor may need to be supported or additionally secured depending on the application and pipe length. In particular, it is absolutely essential to secure the sensor additionally if plastic process connections are used. An appropriate wall mounting kit can be ordered separately as an accessory from Endress+Hauser .

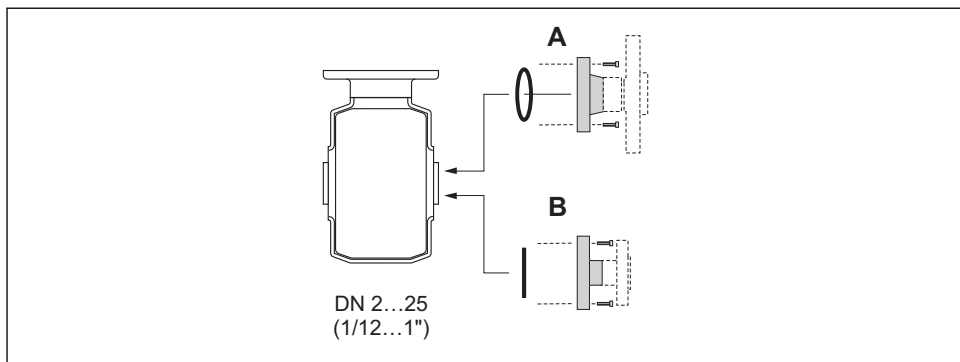

5 Process connection seals

A Process connections with O-ring seal

B Process connections with aseptic molded seal

Welding the sensor into the pipe (welding connections)

⚠ WARNING

Risk of destroying the electronics!

► Make sure that the welding system is not grounded via the sensor or transmitter.

1. Tack-weld the sensor to secure it in the pipe. A suitable welding aid can be ordered separately as an accessory .
2. Release the screws on the process connection flange and remove the sensor, along with the seal, from the pipe.
3. Weld the process connection into the pipe.
4. Reinstall the sensor in the pipe, and in doing so make sure that the seal is clean and in the right position.



- If thin-walled pipes carrying food are welded correctly, the seal is not damaged by the heat even when mounted. However, it is recommended to disassemble the sensor and seal.
- It must be possible to open the pipe by approx. 8 mm (0.31 in) in total to permit disassembly.

Cleaning with pigs

It is essential to take the internal diameters of the measuring tube and process connection into account when cleaning with pigs. All the dimensions and lengths of the sensor and transmitter are provided in the separate "Technical Information" document.

Mounting the seals

CAUTION

An electrically conductive layer could form on the inside of the measuring tube!

Risk of measuring signal short circuit.

- ▶ Do not use electrically conductive sealing compounds such as graphite.

Comply with the following instructions when installing seals:

- Make sure that the seals do not protrude into the piping cross-section.
- In the case of metal process connections, the screws must be tightened securely. The process connection forms a metal connection with the sensor, which ensures a defined compression of the seal.
- In the case of plastic process connections, comply with the max. screw tightening torques for lubricated threads: 7 Nm (5.2 lbf ft). In the case of plastic flanges, always insert a seal between the connection and the counterflange.
- For "PFA" lining; additional seals are **always** required.
- Depending on the application the seals should be replaced periodically, particularly if molded seals are used (aseptic version)! The interval between changes depends on the frequency of the cleaning cycles, the cleaning temperature and the medium temperature. Replacement seals can be ordered as an accessory .

Mounting grounding rings (DN 2 to 25 (1/12 to 1"))



Pay attention to the information on potential equalization →  31.

In the case of plastic process connections (e.g. flange connections or adhesive fittings), additional ground rings must be used to ensure potential matching between the sensor and the fluid. If grounding rings are not installed, this can affect the measuring accuracy or cause the destruction of the sensor as a result of the electrochemical decomposition of the electrodes.



- Depending on the option ordered, plastic disks are used instead of grounding rings on some process connections. These plastic disks only act as "spacers" and do not have any potential matching function. Furthermore, they also perform a significant sealing function at the sensor/process connection interface. Therefore, in the case of process connections without metal grounding rings, these plastic disks/seals should never be removed and should always be installed!
- Grounding rings can be ordered separately as an accessory from Endress+Hauser . When ordering make sure that the grounding rings are compatible with the material used for the electrodes, as otherwise there is the danger that the electrodes could be destroyed by electrochemical corrosion!
- Grounding rings, including seals, are mounted inside the process connections. Therefore the installation length is not affected.

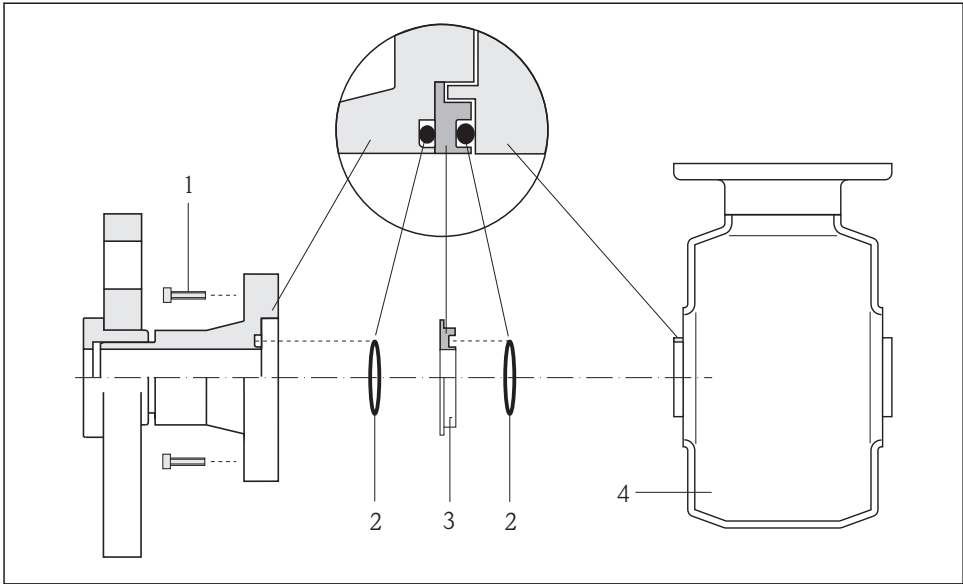

A0002651

6 Installing grounding rings

- 1 Hexagonal-headed bolts of process connection
- 2 O-ring seals
- 3 Grounding ring or plastic disk (spacer)
- 4 Sensor

1. Release the 4 or 6 hexagonal-headed bolts (1) and remove the process connection from the sensor (4).
2. Remove the plastic disk (3), along with the two O-ring seals (2), from the process connection.
3. Place the first O-ring seal (2) back into the groove of the process connection.
4. Fit the metal grounding ring (3) in the process connection as illustrated.
5. Place the second O-ring seal (2) into the groove of the grounding ring.
6. Mount the process connection back on the sensor. In doing so, make sure to observe the maximum screw tightening torques for lubricated threads: 7 Nm (5.2 lbf ft)

6.2.4 Turning the transmitter housing

To provide easier access to the connection compartment or display module, the transmitter housing can be turned.

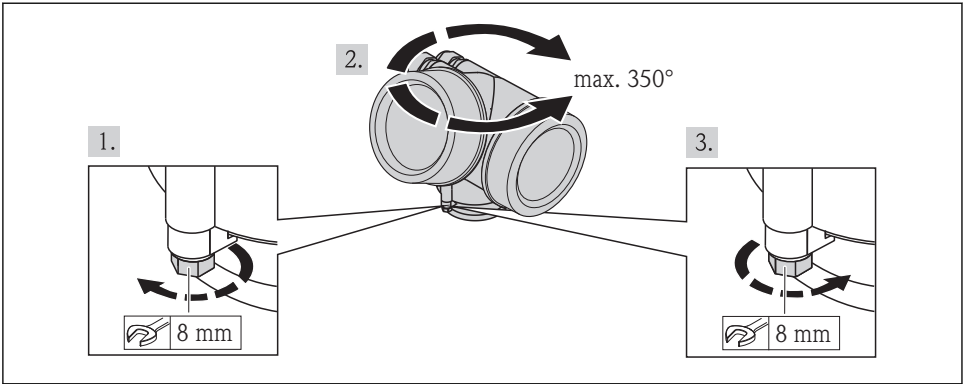

A0013713

6.2.5 Turning the display module

The display module can be turned to optimize display readability and operability.

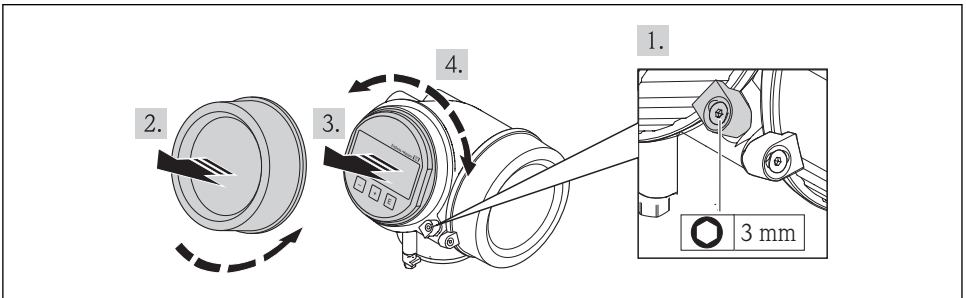

A0013905

6.3 Post-installation check

Is the device undamaged (visual inspection)?	<input type="checkbox"/>
Does the measuring device conform to the measuring point specifications? For example:	<input type="checkbox"/>
▪ Process temperature	
▪ Process pressure (refer to the section on "Pressure-temperature ratings" in the "Technical Information" document on the CD-ROM provided)	
▪ Ambient temperature ▪ Measuring range	
Has the correct orientation for the sensor been selected ?	<input type="checkbox"/>
▪ According to sensor type ▪ According to medium temperature ▪ According to medium properties (outgassing, with entrained solids)	
Does the arrow on the sensor nameplate match the direction of flow of the fluid through the piping ?	<input type="checkbox"/>
Are the measuring point identification and labeling correct (visual inspection)?	<input type="checkbox"/>

Is the device adequately protected from precipitation and direct sunlight?	<input type="checkbox"/>
Have the fixing screws been tightened with the correct tightening torque?	<input type="checkbox"/>

7 Electrical connection



The measuring device does not have an internal circuit breaker. For this reason, assign the measuring device a switch or power-circuit breaker so that the power supply line can be easily disconnected from the mains.

7.1 Connection conditions

7.1.1 Required tools

- For cable entries: Use corresponding tools
- For securing clamp: Allen key 3 mm
- Wire stripper
- When using stranded cables: crimping tool for ferrule
- For removing cables from terminal: flat blade screwdriver ≤ 3 mm (0.12 in)

7.1.2 Connecting cable requirements

The connecting cables provided by the customer must fulfill the following requirements.

Electrical safety

In accordance with applicable federal/national regulations.

Permitted temperature range

- -40°C (-40°F) to $+80^{\circ}\text{C}$ ($+176^{\circ}\text{F}$)
- Minimum requirement: cable temperature range \geq ambient temperature $+20$ K

Signal cable

Current output

For 4-20 mA HART: Shielded cable recommended. Observe grounding concept of the plant.

Pulse/frequency/switch output

Standard installation cable is sufficient.

FOUNDATION Fieldbus

Twisted, shielded two-wire cable.



For further information on planning and installing FOUNDATION Fieldbus networks see:

- Operating Instructions for "FOUNDATION Fieldbus Overview" (BA00013S)
- FOUNDATION Fieldbus Guideline
- IEC 61158-2 (MBP)

PROFIBUS PA

Twisted, shielded two-wire cable. Cable type A is recommended.



For further information on planning and installing PROFIBUS PA networks see:

- Operating Instructions "PROFIBUS DP/PA: Guidelines for planning and commissioning" (BA00034S)
- PNO Directive 2.092 "PROFIBUS PA User and Installation Guideline"
- IEC 61158-2 (MBP)

Cable diameter

- Cable glands supplied:
 - M20 × 1.5 with cable ϕ 6 to 12 mm (0.24 to 0.47 in)
- Plug-in spring terminals for device version without integrated overvoltage protection: wire cross-sections 0.5 to 2.5 mm² (20 to 14 AWG)
- Screw terminals for device version with integrated overvoltage protection: wire cross-sections 0.2 to 2.5 mm² (24 to 14 AWG)

7.1.3 Terminal assignment

Transmitter

Connection versions

<p style="text-align: center;">A0013570</p>	<p style="text-align: center;">A0018161</p>
<p><i>Maximum number of terminals, without integrated overvoltage protection</i></p>	<p><i>Maximum number of terminals, with integrated overvoltage protection</i></p>
<p>1 Output 1 (passive): supply voltage and signal transmission 2 Output 2 (passive): supply voltage and signal transmission 3 Ground terminal for cable shield</p>	

Order code for "Output"	Terminal numbers			
	Output 1		Output 2	
	1 (+)	2 (-)	3 (+)	4 (-)
Option A	4-20 mA HART (passive)		-	
Option B ¹⁾	4-20 mA HART (passive)		Pulse/frequency/switch output (passive)	
Option E ^{1) 2)}	FOUNDATION Fieldbus		Pulse/frequency/switch output (passive)	
Option G ^{1) 3)}	PROFIBUS PA		Pulse/frequency/switch output (passive)	

- 1) Output 1 must always be used; output 2 is optional.
- 2) FOUNDATION Fieldbus with integrated reverse polarity protection.
- 3) PROFIBUS PA with integrated reverse polarity protection.

7.1.4 Pin assignment, device plug

PROFIBUS PA

Device plug for signal transmission (device side)

Pin	Assignment	Coding	Plug/socket
1	+	A	Plug
2			
3	-		
4			

FOUNDATION Fieldbus

Device plug for signal transmission (device side)

Pin	Assignment	Coding	Plug/socket
1	+	A	Plug
2	-		
3			
4			

7.1.5 Shielding and grounding

PROFIBUS PA and FOUNDATION Fieldbus

Optimum electromagnetic compatibility (EMC) of the fieldbus system can only be guaranteed if the system components and, in particular, the lines are shielded and the shield forms as complete a cover as possible. A shield coverage of 90% is ideal.

- To ensure an optimum EMC protective effect, connect the shield as often as possible to the reference ground.
- For reasons of explosion protection, you should refrain from grounding however.

To comply with both requirements, the fieldbus system allows three different types of shielding:

- Shielding at both ends.
- Shielding at one end on the feed side with capacitance termination at the field device.
- Shielding at one end on the feed side.

Experience shows that the best results with regard to EMC are achieved in most cases in installations with one-sided shielding on the feed side (without capacitance termination at the field device). Appropriate measures with regard to input wiring must be taken to allow unrestricted operation when EMC interference is present. These measures have been taken into account for this device. Operation in the event of disturbance variables as per NAMUR NE21 is thus guaranteed.

Where applicable, national installation regulations and guidelines must be observed during the installation!

Where there are large differences in potential between the individual grounding points, only one point of the shielding is connected directly with the reference ground. In systems without

potential equalization, therefore, cable shielding of fieldbus systems should only be grounded on one side, for example at the fieldbus supply unit or at safety barriers.

NOTICE

In systems without potential matching, the multiple grounding of the cable shield causes mains frequency equalizing currents!

Damage to the bus cable shield.

- ▶ Only ground the bus cable shield to either the local ground or the protective ground at one end. Insulate the shield that is not connected.

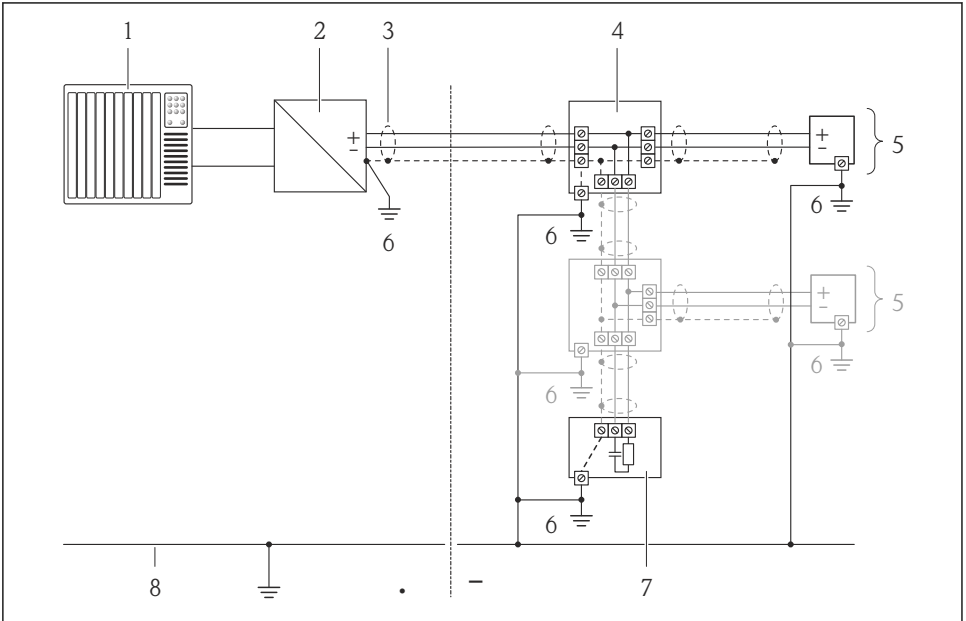

A0019004

- 1 Controller (e.g. PLC)
- 2 Segment coupler PROFIBUS DP/PA or Power Conditioner (FOUNDATION Fieldbus)
- 3 Cable shield
- 4 T-box
- 5 Measuring device
- 6 Local grounding
- 7 Bus terminator
- 8 Potential matching line

7.1.6 Requirements for the supply unit

Supply voltage

Transmitter

Order code for "Output"	Minimum terminal voltage	Maximum terminal voltage
Option A ^{1) 2)} : 4-20 mA HART	<ul style="list-style-type: none"> ■ For 4 mA: \geq DC 18 V ■ For 20 mA: \geq DC 14 V 	DC 35 V
Option B ^{1) 2)} : 4-20 mA HART, pulse/frequency/switch output	<ul style="list-style-type: none"> ■ For 4 mA: \geq DC 18 V ■ For 20 mA: \geq DC 14 V 	DC 35 V
Option E ³⁾ : FOUNDATION Fieldbus, pulse/frequency/switch output	\geq DC 9 V	DC 32 V
Option G ³⁾ : PROFIBUS PA, pulse/frequency/switch output	\geq DC 9 V	DC 32 V

- 1) External supply voltage of the power supply unit with load.
- 2) For device versions with SD03 local display: The terminal voltage must be increased by DC 2 V if backlighting is used.
- 3) For device version with SD03 local display: The terminal voltage must be increased by DC 0.5 V if backlighting is used.

Load

Load for current output: 0 to 500 Ω , depending on the external supply voltage of the power supply unit

Calculation of the maximum load

Depending on the supply voltage of the power supply unit (U_S), the maximum load (R_B) including line resistance must be observed to ensure adequate terminal voltage at the device. In doing so, observe the minimum terminal voltage

- For $U_S = 18$ to 18.9 V: $R_B \leq (U_S - 18 \text{ V}): 0.0036 \text{ A}$
- For $U_S = 18.9$ to 24.5 V: $R_B \leq (U_S - 13.5 \text{ V}): 0.022 \text{ A}$
- For $U_S = 24.5$ to 30 V: $R_B \leq 500 \Omega$

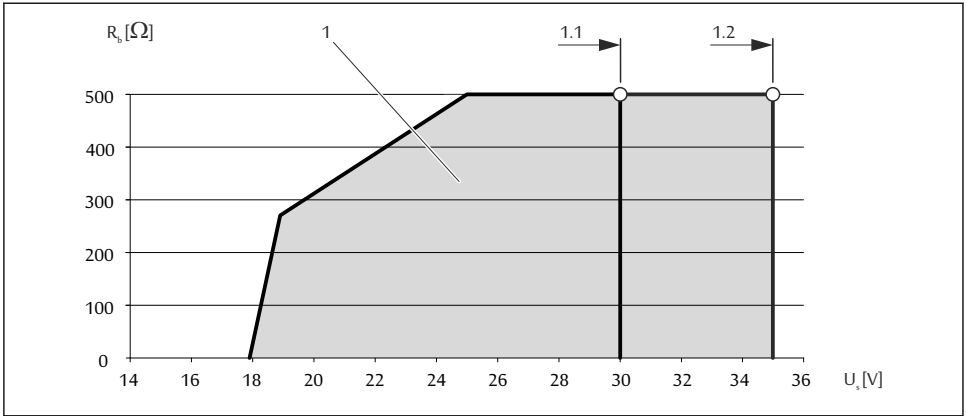

A0013563

1 Operating range

- 1.1 For order code for "Output", option A "4-20 mA HART"/option B "4-20 mA HART, pulse/frequency/switch output" with Ex i
- 1.2 For order code for "Output", option A "4-20 mA HART"/option B "4-20 mA HART, pulse/frequency/switch output" with non-Ex and Ex d

Sample calculation

Supply voltage of the power supply unit: $U_S = 19 \text{ V}$

Maximum load: $R_B \leq (19 \text{ V} - 13.5 \text{ V}) : 0.022 \text{ A} = 250 \Omega$

7.1.7 Preparing the measuring device

1. Remove dummy plug if present.
2. **NOTICE!** Insufficient sealing of the housing! Operational reliability of the measuring device could be compromised. Use suitable cable glands corresponding to the degree of protection.
If measuring device is delivered without cable glands:
Provide suitable cable gland for corresponding connecting cable .
3. If measuring device is delivered with cable glands:
Observe cable specification .

7.2 Connecting the measuring device

NOTICE

Limitation of electrical safety due to incorrect connection!

- ▶ For use in potentially explosive atmospheres, observe the information in the device-specific Ex documentation.

7.2.1 Connecting the transmitter

The connection of the transmitter depends on the following order codes:

Connection version: terminals or device plug

Connection via terminals

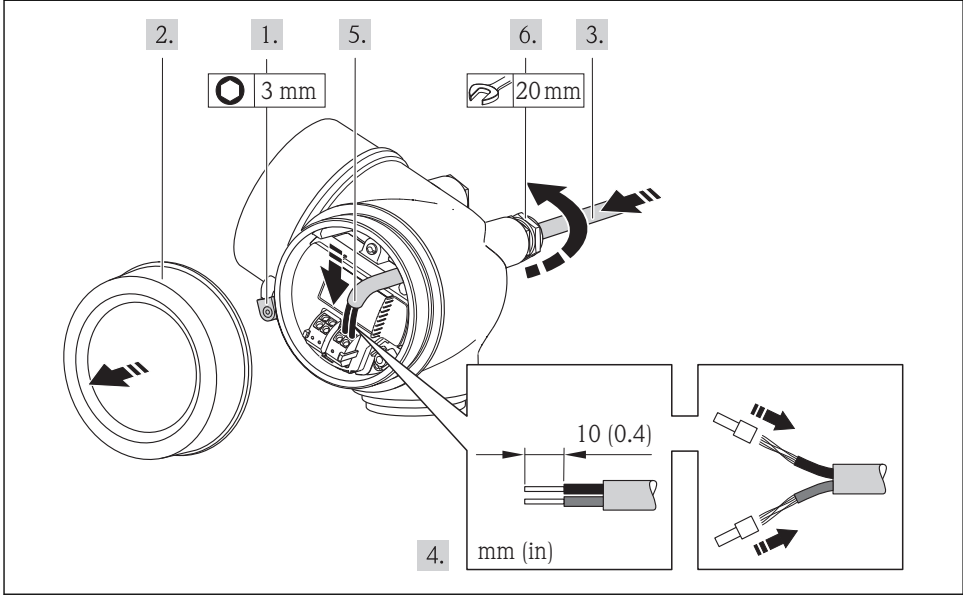

A0013836

- Connect the cable in accordance with the terminal assignment . For HART communication: when connecting the cable shielding to the ground terminal, observe the grounding concept of the facility.

Connection via device plug

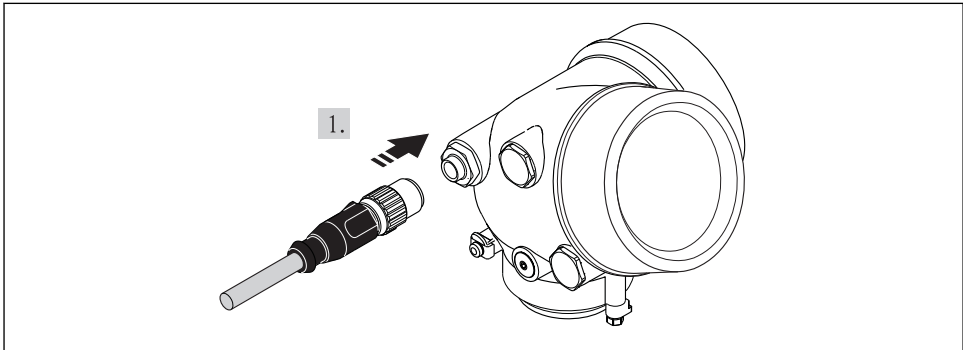

A0019147

- Plug in the device plug and tighten firmly.

7.2.2 Ensuring potential equalization

Requirements



Electrode damage can result in the complete failure of the device!

- ▶ Same electrical potential for the fluid and sensor
- ▶ Company-internal grounding concepts
- ▶ Pipe material and grounding



For devices intended for use in hazardous locations, please observe the guidelines in the Ex documentation (XA).

Connection example, standard scenario

Metal process connections

Potential equalization is generally via the metal process connections that are in contact with the medium and mounted directly on the sensor. Therefore there is generally no need for additional potential equalization measures.

Connection example in special situations



For detailed information on special cases, see the Operating Instructions for the device.

- Unlined and ungrounded metal pipe
- Plastic pipe or pipe with insulating liner
- Pipe with a cathodic protection unit

7.3 Hardware settings

7.3.1 Setting the device address

PROFIBUS PA

The address must always be configured for a PROFIBUS DP/PA device. The valid address range is between 1 and 126. In a PROFIBUS DP/PA network, each address can only be assigned once. If an address is not configured correctly, the device is not recognized by the master. All measuring devices are delivered from the factory with the device address 126 and with the software addressing method.

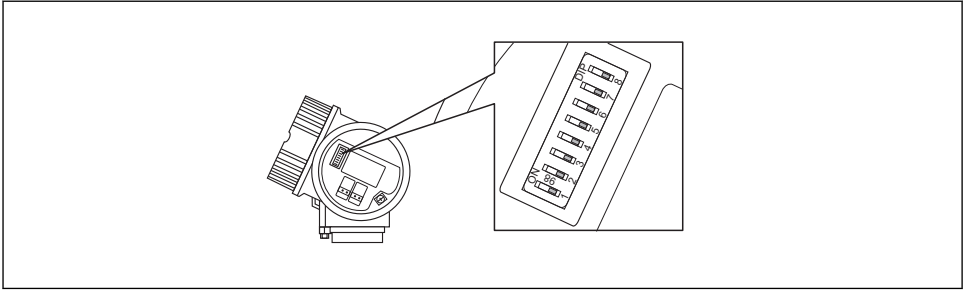

A0015686

7 Address switch in the connection compartment

Hardware addressing

1. Set switch 8 to the "OFF" position.
2. Using switches 1 to 7, set the address as indicated in the table below.

The change of address takes effect after 10 seconds. The device is restarted.

Switch	1	2	3	4	5	6	7
Value in "ON" position	1	2	4	8	16	32	64
Value in "OFF" position	0	0	0	0	0	0	0

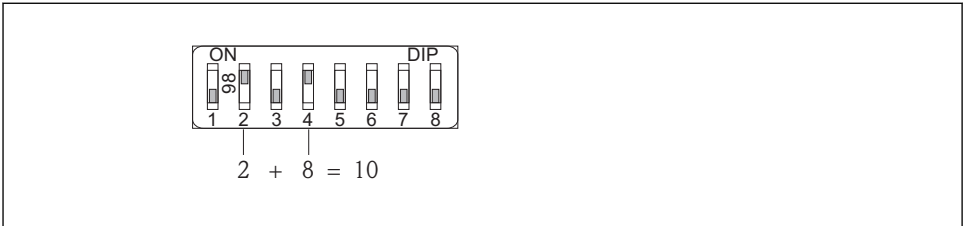

A0015902

8 Example of hardware addressing; switch 8 is set to the "OFF" position; switches 1 to 7 define the address.

Software addressing

1. Set switch 8 to "ON".
 - ↳ The device restarts automatically and reports the current address (factory setting: 126).
2. Configuring the address via the operating menu: **Setup** menu → **Communication** submenu → **Device address** parameter

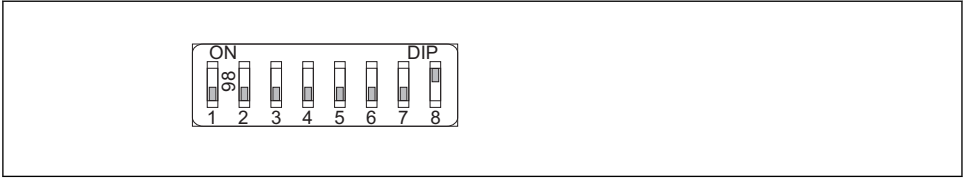

A0015903

- 9 Example of software addressing; switch 8 is set to the "ON" position; the address is defined in the operating menu ("Setup" menu → "Communication" submenu → "Device address" parameter).

7.4 Ensuring the degree of protection

The measuring device fulfills all the requirements for the IP66/67 degree of protection, Type 4X enclosure.

To guarantee IP66/67 degree of protection, Type 4X enclosure, carry out the following steps after the electrical connection:

1. Check that the housing seals are clean and fitted correctly. Dry, clean or replace the seals if necessary.
2. Tighten all housing screws and screw covers.
3. Firmly tighten the cable glands.
4. To ensure that moisture does not enter the cable entry, route the cable so that it loops down before the cable entry ("water trap").

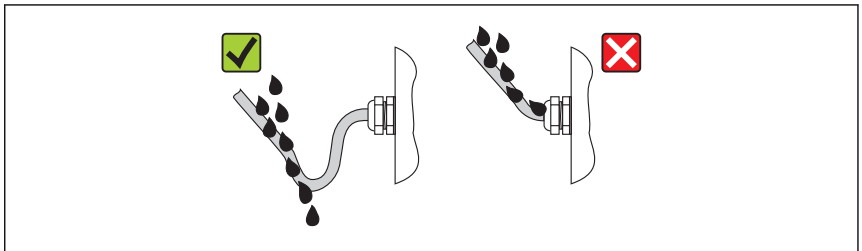

A0015960

5. Insert dummy plugs into unused cable entries.

7.5 Post-connection check

Are cables or the device undamaged (visual inspection)?	<input type="checkbox"/>
Do the cables comply with the requirements ?	<input type="checkbox"/>
Do the cables have adequate strain relief?	<input type="checkbox"/>
Are all the cable glands installed, firmly tightened and leak-tight? Cable run with "water trap" → 33 ?	<input type="checkbox"/>
Depending on the device version: are all the device plugs firmly tightened ?	<input type="checkbox"/>
Does the supply voltage match the specifications on the transmitter nameplate ?	<input type="checkbox"/>
Is the terminal assignment correct ?	<input type="checkbox"/>
Is the terminal assignment or the pin assignment of the device plug correct?	<input type="checkbox"/>
If supply voltage is present, do values appear on the display module?	<input type="checkbox"/>

Is the potential equalization established correctly → 31?	<input type="checkbox"/>
Are all housing covers installed and firmly tightened?	<input type="checkbox"/>
Is the securing clamp tightened correctly?	<input type="checkbox"/>

8 Operation options

8.1 Structure and function of the operating menu

8.1.1 Structure of the operating menu

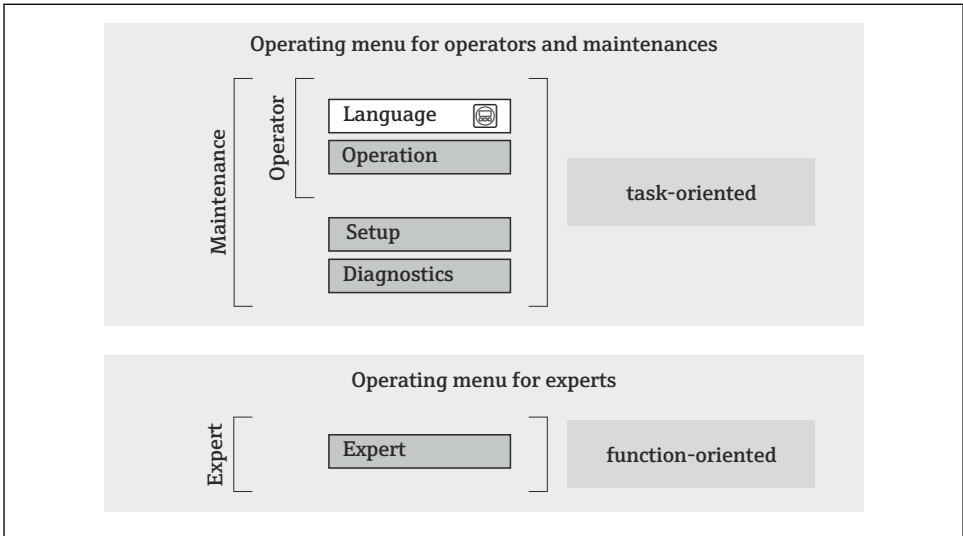

A0014058-EN

10 Schematic structure of the operating menu

8.1.2 Operating philosophy

The individual parts of the operating menu are assigned to certain user roles (operator, maintenance etc.). Each user role contains typical tasks within the device lifecycle.

For detailed information on the operating philosophy, see the Operating Instructions for the device.

8.2 Access to the operating menu via the local display

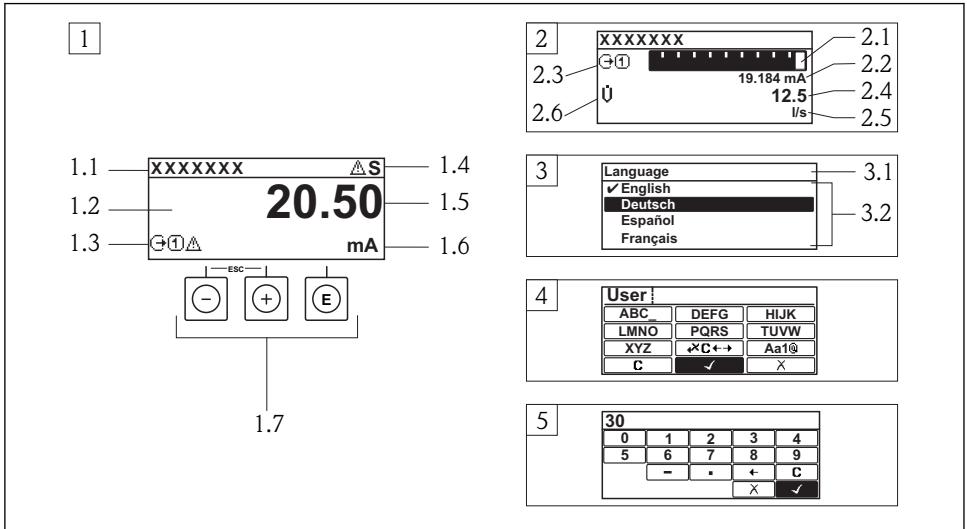





A0014013

- 1 Operational display with measured value shown as "1 value, max." (example)
 - 1.1 Device tag
 - 1.2 Display area for measured values (4-line)
 - 1.3 Explanatory symbols for measured value: Measured value type, measuring channel number, symbol for diagnostic behavior
 - 1.4 Status area
 - 1.5 Measured value
 - 1.6 Unit for the measured value
 - 1.7 Operating elements
- 2 Operational display with measured value shown as "1 bar graph + 1 value" (example)
 - 2.1 Bar graph display for measured value 1
 - 2.2 Measured value 1 with unit
 - 2.3 Explanatory symbols for measured value 1: measured value type, measuring channel number
 - 2.4 Measured value 2
 - 2.5 Unit for measured value 2
 - 2.6 Explanatory symbols for measured value 2: measured value type, measuring channel number
- 3 Navigation view: picklist of a parameter
 - 3.1 Navigation path and status area
 - 3.2 Display area for navigation: ✓ designates the current parameter value
- 4 Editing view: text editor with input mask
- 5 Editing view: numeric editor with input mask











8.2.1 Operational display

Status area

The following symbols appear in the status area of the operational display at the top right:

- Status signals
 - **F**: Failure
 - **C**: Function check
 - **S**: Out of specification
 - **M**: Maintenance required
- Diagnostic behavior
 - : Alarm
 - : Warning
- : Locking (the device is locked via the hardware)
- : Communication (communication via remote operation is active)

Display area

- Measured variables (depending on the device version), e.g.:
 - : Volume flow
 - : Mass flow
 - : Density
 - **G**: Conductivity
 - : Temperature
- : Totalizer (the measurement channel number indicates which totalizer is displayed)
- : Output (the measurement channel number indicates which output is displayed)
- : Input
-  ... : Measurement channel number (if more than one channel is present for the same measured variable type)
- Diagnostic behavior (for a diagnostic event that concerns the displayed measured variable)
 - : Alarm
 - : Warning

8.2.2 Navigation view

Status area

The following appears in the status area of the navigation view in the top right corner:

- Of the submenu
 - The direct access code for the parameter you are navigating to (e.g. 0022-1)
 - If a diagnostic event is present, the diagnostic behavior and status signal
- In the wizard
 - If a diagnostic event is present, the diagnostic behavior and status signal

Display area

- Icons for menus
 - : Operation
 - : Setup
 - : Diagnostics
 - : Expert
- : Submenus
- : Wizards
- : Parameters within a wizard
- : Parameter locked

8.2.3 Editing view

Input mask

Operating symbols in the numeric editor

Key	Meaning	Key	Meaning
	Confirms selection.		Moves the input position one position to the left.
	Exits the input without applying the changes.		Inserts decimal separator at the input position.
	Inserts minus sign at the input position.		Clears all entered characters.

Operating symbols in the text editor

Key	Meaning	Key	Meaning
	Confirms selection.		Switches to the selection of the correction tools.
	Exits the input without applying the changes.		Clears all entered characters.
	Toggle <ul style="list-style-type: none"> ■ Between upper-case and lower-case letters ■ For entering numbers ■ For entering special characters 		

Correction symbols under

Key	Meaning	Key	Meaning
	Clears all entered characters.		Moves the input position one position to the left.
	Moves the input position one position to the right.		Deletes one character immediately to the left of the input position.

8.2.4 Operating elements

Keys and meaning
<p>⊖ Minus key</p> <ul style="list-style-type: none"> ▪ <i>In a menu, submenu:</i> Moves the selection bar upwards in a choose list. ▪ <i>With a wizard:</i> Confirms the parameter value and goes to the previous parameter. ▪ <i>With a text and numeric editor:</i> Moves the selection bar to the left (backwards) in an input screen.
<p>⊕ Plus key</p> <ul style="list-style-type: none"> ▪ <i>In a menu, submenu:</i> Moves the selection bar downwards in a choose list. ▪ <i>With a wizard:</i> Confirms the parameter value and goes to the next parameter. ▪ <i>With a text and numeric editor:</i> Moves the selection bar to the right (forwards) in an input screen.
<p>⊞ Enter key</p> <p><i>For operational display</i></p> <ul style="list-style-type: none"> ▪ Pressing the key briefly opens the operating menu. ▪ Pressing the key for 2 s opens the context menu. <p><i>In a menu, submenu</i></p> <ul style="list-style-type: none"> ▪ Pressing the key briefly: <ul style="list-style-type: none"> – Opens the selected menu, submenu or parameter. – Starts the wizard. – If help text is open, closes the help text of the parameter. ▪ Pressing the key for 2 s for parameter: If present, opens the help text for the function of the parameter. <p><i>With a wizard:</i> Opens the editing view of the parameter.</p> <p><i>With a text and numeric editor:</i></p> <ul style="list-style-type: none"> ▪ Pressing the key briefly: <ul style="list-style-type: none"> – Opens the selected group. – Carries out the selected action. ▪ Pressing the key for 2 s confirms the edited parameter value.
<p>⊞+⊖ Escape key combination (press keys simultaneously)</p> <p><i>In a menu, submenu</i></p> <ul style="list-style-type: none"> ▪ Pressing the key briefly: <ul style="list-style-type: none"> – Exits the current menu level and takes you to the next higher level. – If help text is open, closes the help text of the parameter. ▪ Pressing the key for 2 s for the parameter: Returns you to the operational display ("home position"). <p><i>With a wizard:</i> Exits the wizard and takes you to the next higher level.</p> <p><i>With a text and numeric editor:</i> Closes the text or numeric editor without applying changes.</p>
<p>⊞+⊞ Minus/Enter key combination (press the keys simultaneously)</p> <p>Reduces the contrast (brighter setting).</p>
<p>⊞+⊞ Plus/Enter key combination (press and hold down the keys simultaneously)</p> <p>Increases the contrast (darker setting).</p>
<p>⊞ + ⊞ + ⊞ Minus/Plus/Enter key combination (press the keys simultaneously)</p> <p><i>For operational display:</i> Enables or disables the keypad lock (only SD02 display module).</p>

8.2.5 Further information



For further information on the following topics, see the Operating Instructions for the device

- Calling up help text
- User roles and related access authorization
- Disabling write protection via access code
- Enabling and disabling the keypad lock

8.3 Access to the operating menu via the operating tool



For detailed information about access to the operating menu via operating tool, refer to the Operating Instructions for the device .

9 System integration



For detailed information on system integration, see the Operating Instructions for the device.

9.1 FOUNDATION Fieldbus cyclic data transmission

9.1.1 Cyclic data transmission

Cyclic data transmission when using the device master file (GSD).

Block model

The block model shows which input and output data the measuring device makes available for cyclic data exchange. Cyclic data exchange takes place with a FOUNDATION Fieldbus master (Class 1), e.g. a control system etc.

Display text (xxxx... = serial number)	Base index	Description
RESOURCE_ xxxxxxxxxxxx	400	Resource block
SETUP_ xxxxxxxxxxxx	600	"Setup" Transducer block
ADVANCED_SETUP_ xxxxxxxxxxxx	800	"Advanced setup" Transducer block
DISPLAY_ xxxxxxxxxxxx	1000	"Display" Transducer block
HISTOROM_ xxxxxxxxxxxx	1200	"HistoROM" Transducer block
DIAGNOSTIC_ xxxxxxxxxxxx	1400	"Diagnostic" Transducer block
EXPERT_CONFIG_ xxxxxxxxxxxx	1600	"Expert configuration" Transducer block
EXPERT_INFO_ xxxxxxxxxxxx	1800	"Expert information" Transducer block
SERVICE_SENSOR_ xxxxxxxxxxxx	2000	"Service sensor" Transducer block
SERVICE_INFO_ xxxxxxxxxxxx	2200	"Service info" Transducer block
TOTAL_INVENTORY_COUNTER_ xxxxxxxxxxxx	2400	"Totalizer" Transducer block

Display text (xxxx... = serial number)	Base index	Description
HEARTBEAT_RESULTS1_ xxxxxxxxxxxx	2600	"Heartbeat results 1" Transducer block
HEARTBEAT_RESULTS2_ xxxxxxxxxxxx	2800	"Heartbeat results 2" Transducer block
HEARTBEAT_RESULTS3_ xxxxxxxxxxxx	3000	"Heartbeat results 3" Transducer block
HEARTBEAT_RESULTS4_ xxxxxxxxxxxx	3200	"Heartbeat results 4" Transducer block
HEARTBEAT_TECHNOLOGY_ xxxxxxxxxxxx	3400	"Heartbeat" Transducer block
ANALOG_INPUT_1_ xxxxxxxxxxxx	3600	Analog Input function block 1 (AI)
ANALOG_INPUT_2_ xxxxxxxxxxxx	3800	Analog Input function block 2 (AI)
ANALOG_INPUT_3_ xxxxxxxxxxxx	4000	Analog Input function block 3 (AI)
ANALOG_INPUT_4_ xxxxxxxxxxxx	4200	Analog Input function block 4 (AI)
DIGITAL_INPUT_1_ xxxxxxxxxxxx	4400	Digital Input function block 1 (DI)
DIGITAL_INPUT_2_ xxxxxxxxxxxx	4600	Digital Input function block 2 (DI)
MULTI_DIGITAL_OUTPUT_ xxxxxxxxxxxx	4800	Multiple Digital Output block (MDO)
PID_ xxxxxxxxxxxx	5000	PID function block (PID)
INTEGRATOR_ xxxxxxxxxxxx	5200	Integrator function block (INTG)

Assignment of the measured values in the function blocks

The input value of a function block is defined via the CHANNEL parameter.

AI module (Analog Input)

Description

Four Analog Input blocks are available.

CHANNEL	Measured variable
0	Uninitialized (factory setting)
7	Temperature
9	Volume flow
11	Mass flow
16	Totalizer 1
17	Totalizer 2
18	Totalizer 3

DI module (Discrete Input)

Two Discrete Input blocks are available.

Description

CHANNEL	Device function	State
0	Uninitialized (factory setting)	–
101	Switch output state	0 = off, 1 = active
102	Empty pipe detection	0 = full, 1 = empty
103	Low flow cut off	0 = off, 1 = active
105	Status verification ¹⁾	0 = good, 1 = bad

1) Only available with the Heartbeat Verification application package

*MDO module (Multiple Discrete Output)**Description*

Channel	Name
122	Channel_DO

Structure

Channel_DO							
Value 1	Value 2	Value 3	Value 4	Value 5	Value 6	Value 7	Value 8

Value	Device function	State
Value 1	Reset totalizer 1	0 = off, 1 = execute
Value 2	Reset totalizer 2	0 = off, 1 = execute
Value 3	Reset totalizer 3	0 = off, 1 = execute
Value 4	Flow override	0 = off, 1 = active
Value 5	Start heartbeat verification ¹⁾	0 = off, 1 = start
Value 6	Status switch output	0 = off, 1 = on
Value 7	Not assigned	–
Value 8	Not assigned	–

1) Only available with the Heartbeat Verification application package

9.2 Cyclic data transfer PROFIBUS PA

9.2.1 Cyclic data transmission

Cyclic data transmission when using the device master file (GSD).

Block model

The block model shows which input and output data the measuring device makes available for cyclic data exchange. Cyclic data exchange takes place with a PROFIBUS master (Class 1), e.g. a control system etc.

Measuring device				Control system
Transducer Block	Analog Input block 1 to 2	→	📄 43	Output value AI →
				Output value TOTAL →
	Totalizer block 1 to 3	→	📄 43	Controller SETTOT ←
				Configuration MODETOT ←
	Discrete Input block 1 to 2	→	📄 44	Output values DI →
Discrete Output block 1 to 3	→	📄 45	Input values DO ←	
				PROFIBUS PA

Defined order of modules

The modules are permanently assigned to the slots, i.e. when configuring the modules, the order and the arrangement of the modules must be respected.

Slot	Module	Function block
1...2	AI	Analog Input block 1 to 2
3	TOTAL or SETTOT_TOTAL or SETTOT_MODETOT_TOTAL	Totalizer block 1
4		Totalizer block 2
5		Totalizer block 3
6...7	DI	Discrete Input block 1 to 2
8...10	DO	Discrete Output block 1 to 3

To optimize the data throughput rate of the PROFIBUS network, it is advisable to only configure modules that are processed in the PROFIBUS master system. If this results in gaps between the configured modules, these gaps must be assigned to the EMPTY_MODULE.

Description of the modules



The data structure is described from the perspective of the PROFIBUS master:

- Input data: Are sent from the measuring device to the PROFIBUS master.
- Output data: Are sent from the PROFIBUS master to the measuring device.

AI module (Analog Input)

Transmit an input variable from the measuring device to the PROFIBUS master (Class 1).

Selection: input variable

The input variable can be specified using the CHANNEL parameter.

CHANNEL	Input variable
9	Volume flow
11	Mass flow

Factory setting

Function block	Factory setting
AI 1	Volume flow
AI 2	Mass flow

TOTAL module

Transmit a totalizer value from the measuring device to the PROFIBUS master (Class 1).

Selection: totalizer value

The totalizer value can be specified using the CHANNEL parameter.

CHANNEL	Input variable
9	Mass flow
11	Volume flow

Factory setting

Function block	Factory setting: TOTAL
Totalizer 1, 2 and 3	Volume flow

SETTOT_TOTAL module

The module combination consists of the SETTOT and TOTAL functions:

- SETTOT: Control the totalizers via the PROFIBUS master.
- TOTAL: Transmit totalizer value, along with the status, to the PROFIBUS master.

Selection: control totalizer

Value SETTOT	Control totalizer
0	Totalize
1	Resetting
2	Adopt totalizer initial setting

Factory setting

Function block	Factory setting: Value SETTOT (meaning)
Totalizer 1, 2 and 3	0 (totalizing)

SETTOT_MODETOT_TOTAL module

The module combination consists of the SETTOT, MODETOT and TOTAL functions:

- SETTOT: Control the totalizers via the PROFIBUS master.
- MODETOT: Configure the totalizers via the PROFIBUS master.
- TOTAL: Transmit totalizer value, along with the status, to the PROFIBUS master.

Selection: totalizer configuration

MODETOT value	Totalizer configuration
0	Balancing
1	Balance the positive flow
2	Balance the negative flow
3	Stop totalizing

Factory setting

Function block	Factory setting: Value MODETOT (meaning)
Totalizer 1, 2 and 3	0 (balancing)

DI module (Discrete Input)

Transmit discrete input values from the measuring device to the PROFIBUS master (Class 1).

Selection: device function

The device function can be specified using the CHANNEL parameter.

CHANNEL	Device function	Factory setting: Status (meaning)
893	Status switch output	<ul style="list-style-type: none"> ▪ 0 (device function not active) ▪ 1 (device function active)
894	Empty pipe detection	

CHANNEL	Device function	Factory setting: Status (meaning)
895	Low flow cut off	
1430	Status verification ¹⁾	

1) Only available with the Heartbeat Verification application package

Factory setting

Function block	Factory setting	Function block	Factory setting
DI 1	Empty pipe detection	DI 2	Low flow cut off

DO module (Discrete Output)

Transmit discrete output values from the PROFIBUS master (Class 1) to the measuring device.

Assigned device functions

A device function is permanently assigned to the individual Discrete Output blocks.

CHANNEL	Function block	Device function	Values: control (meaning)
891	DO 1	Flow override	<ul style="list-style-type: none"> ▪ 0 (disable device function) ▪ 1 (enable device function)
253	DO 2	Pulse/freq./switch output	
1429	DO 3	Start verification ¹⁾	

1) Only available with the Heartbeat Verification application package

EMPTY_MODULE module

This module is used to assign empty spaces arising from modules not being used in the slots
→  42.

10 Commissioning



10.1 Function check

Before commissioning the measuring device:

- ▶ Make sure that the post-installation and post-connection checks have been performed.
- "Post-installation check" checklist →  21
- "Post-connection check" checklist →  33

10.2 Switching on the measuring device

- ▶ After a successful function check, switch on the measuring device.
 - ↳ After a successful startup, the local display switches automatically from the startup display to the operational display.

 If nothing appears on the local display or a diagnostic message is displayed, refer to the Operating Instructions for the device →  2

10.3 Setting the operating language

Factory setting: English or ordered local language

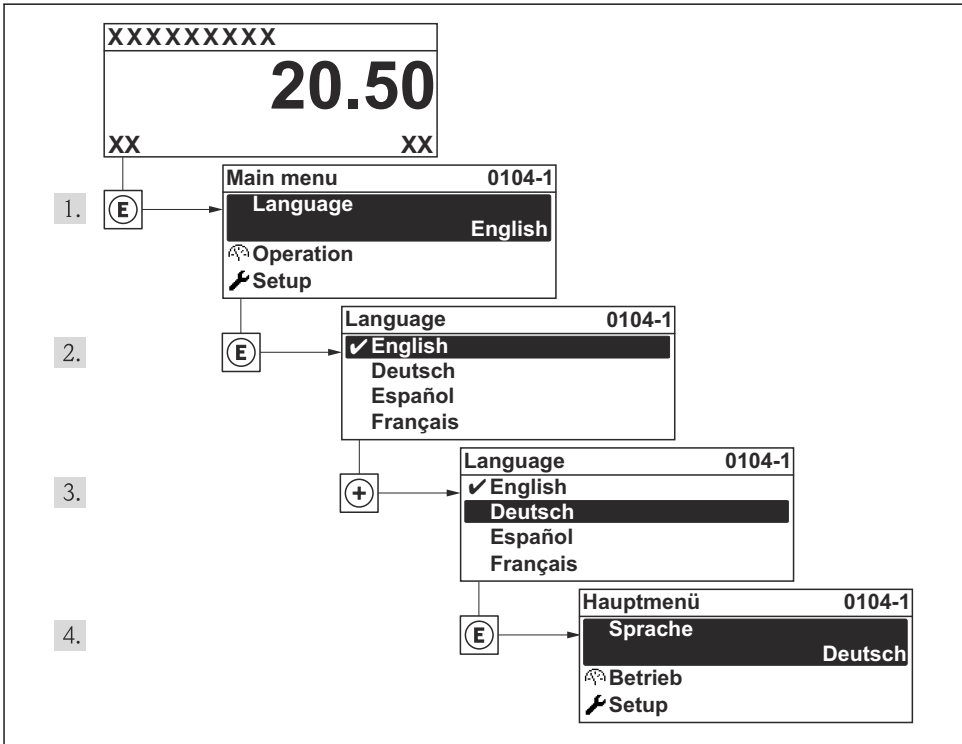

A0013996

 11 Taking the example of the local display

10.4 Configuring the measuring device

The **Setup** menu with its **System units** submenu and various guided wizards enable fast commissioning of the measuring device.

The desired units can be selected in the **System units** submenu. The wizards systematically guide the user through all the parameters required for configuration, such as parameters for measurement or outputs.



The wizards available in the particular device can vary on account of the device version (e.g. communication method).

Wizard	Meaning
Current output 1	Set current output 1
Pulse/frequency/switch output	Configure the selected output type
Analog inputs	Configure the analog inputs
Display	Configure the measured value display
Output conditioning	Define the output conditioning
Low flow cut off	Set the low flow cut off

10.5 Defining the tag name

To enable fast identification of the measuring point within the system, you can enter a unique designation using the **Device tag** parameter and thus change the factory setting.

Navigation

"Setup" menu → Device tag

Parameter overview with brief description

Parameter	Description	User entry	Factory setting
Device tag	Enter the name for the measuring point.	Max. 32 characters such as letters, numbers or special characters (e.g. @, %, /).	Promag

10.6 Protecting settings from unauthorized access

The following options exist for protecting the configuration of the measuring device from unintentional modification after commissioning:

- Write protection via access code
- Write protection via write protection switch
- Write protection via keypad lock
- FOUNDATION Fieldbus: write protection via block operation



For detailed information on protecting the settings against unauthorized access, see the Operating Instructions for the device.

11 Diagnostic information

Faults detected by the self-monitoring system of the measuring device are displayed as a diagnostic message in alternation with the operational display. The message on remedial measures can be called up from the diagnostic messages, and contains important information on the fault.

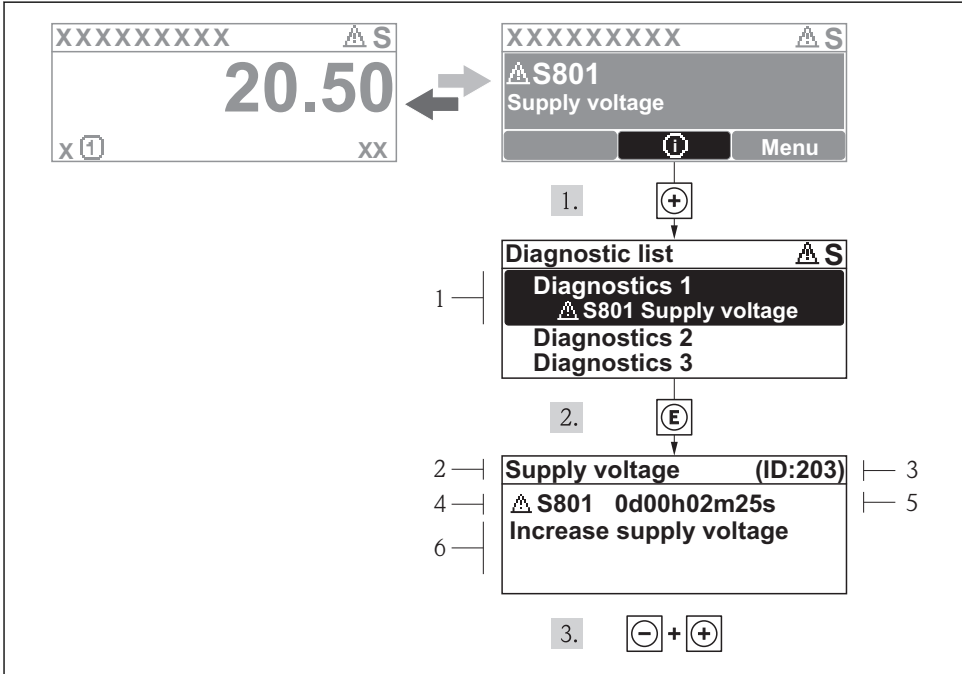

12 Message for remedial measures

- 1 Diagnostic information
- 2 Short text
- 3 Service ID
- 4 Diagnostic behavior with diagnostic code
- 5 Operation time of occurrence
- 6 Remedial measures

The user is in the diagnostic message.

1. Press **+** (ⓘ symbol).
 - ↳ The **Diagnostic list** submenu opens.
2. Select the desired diagnostic event with **+** or **-** and press **E** .
 - ↳ The message for the remedial measures for the selected diagnostic event opens.
3. Press **-** + **+** simultaneously.
 - ↳ The message for the remedial measures closes.

www.addresses.endress.com
