

Brief Operating Instructions

Deltabar FMD71, FMD72

Level measurement with electronic differential pressure

Electronic differential pressure transmitter with ceramic and metal sensors

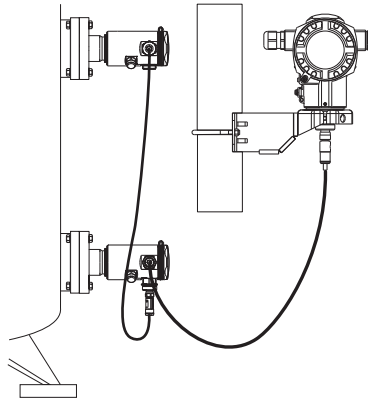

These Instructions are Brief Operating Instructions; they are not a substitute for the Operating Instructions pertaining to the device.

Detailed information about the device can be found in the Operating Instructions and the other documentation:

Available for all device versions via:

- Internet: www.endress.com/deviceviewer
- Smart phone/tablet: *Endress+Hauser Operations App*

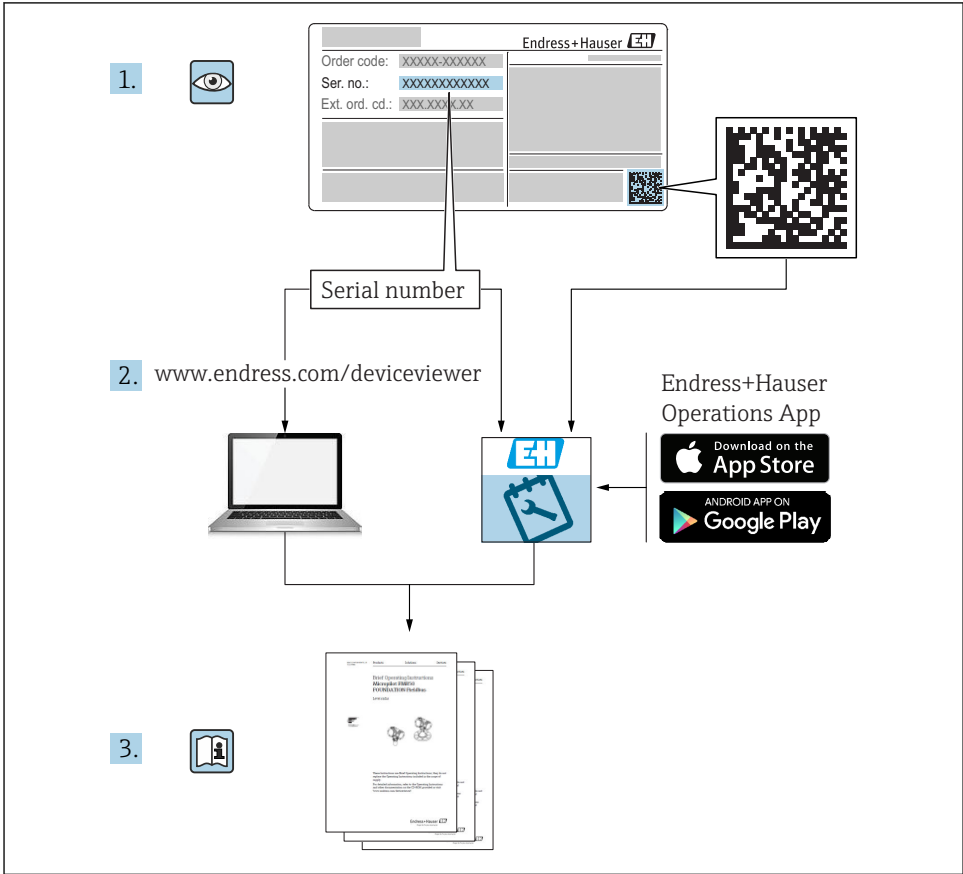

A0023555

Table of contents

1	Document information	4
1.1	Document function	4
1.2	Symbols used	4
1.3	Documentation	6
1.4	Terms and abbreviations	8
1.5	Turn down calculation	9
1.6	Registered trademarks	10
2	Basic safety instructions	10
2.1	Requirements concerning the staff	10
2.2	Designated use	10
2.3	Workplace safety	11
2.4	Operational safety	11
2.5	Product safety	12
3	Product description	12
3.1	Product design	12
4	Incoming acceptance and product identification	13
4.1	Incoming acceptance	13
4.2	Product identification	15
4.3	Nameplates	16
4.4	Storage and transport	18
5	Installation	19
5.1	Mounting dimensions	19
5.2	Mounting location	19
5.3	Orientation	19
5.4	General installation instructions	19
5.5	Thermal insulation - FMD71 high-temperature version	19
5.6	Installing the sensor modules	20
5.7	Mounting sensor modules with PVDF installation coupling	21
5.8	Installing the transmitter	21
5.9	Closing the housing cover	21
5.10	Seal for flange mounting	22
5.11	Post-installation check	22
6	Electrical connection	23
6.1	Connecting the sensor module LP to the sensor module HP	23
6.2	Connecting the sensor module HP to the transmitter	24
6.3	Connecting the measuring unit	26
6.4	Connection conditions	28
6.5	Connection data	28
6.6	Post-connection check	28
7	Operation options	29
7.1	Operation without operating menu	29
7.2	Operation with an operating menu	31
7.3	Structure of the operating menu	32
7.4	Operating options	33
7.5	Operating the device using onsite display (optional)	33
7.6	Operation using Endress+Hauser operating program	36
7.7	Direct access to parameters	36
7.8	Locking/unlocking operation	36
7.9	Resetting to factory settings (reset)	36
8	Integrating transmitter via HART® protocol	36

9	Commissioning	37
9.1	Post-installation check and function check	37
9.2	Unlocking/locking configuration	37
9.3	Commissioning without an operating menu	37
9.4	Commissioning with an operating menu	39
9.5	Language selection	39
9.6	Measuring mode selection	40
9.7	Selecting the high-pressure side	40
9.8	Pressure unit selection	41
9.9	Pos. zero adjust	41
9.10	Configuring level measurement	43
9.11	Linearization	46
9.12	Configuring pressure measurement	46





1 Document information

1.1 Document function





The Brief Operating Instructions contain all the essential information from incoming acceptance to initial commissioning.

1.2 Symbols used

1.2.1 Safety symbols





Symbol	Meaning
	DANGER! This symbol alerts you to a dangerous situation. Failure to avoid this situation will result in serious or fatal injury.
	WARNING! This symbol alerts you to a dangerous situation. Failure to avoid this situation can result in serious or fatal injury.
	CAUTION! This symbol alerts you to a dangerous situation. Failure to avoid this situation can result in minor or medium injury.
	NOTE! This symbol contains information on procedures and other facts which do not result in personal injury.

1.2.2 Electrical symbols









Symbol	Meaning	Symbol	Meaning
	Direct current		Alternating current
	Direct current and alternating current		Ground connection A grounded terminal which, as far as the operator is concerned, is grounded via a grounding system.

Symbol	Meaning
	<p>Protective Earth (PE) A terminal which must be connected to ground prior to establishing any other connections.</p> <p>The ground terminals are situated inside and outside the device:</p> <ul style="list-style-type: none"> ▪ Inner ground terminal: Connects the protective earth to the mains supply. ▪ Outer ground terminal: Connects the device to the plant grounding system.

1.2.3 Tool symbols

Symbol	Meaning
 A0011220	Flat blade screwdriver
 A0011219	Phillips head screwdriver
 A0011221	Allen key
 A0011222	Open-ended wrench

1.2.4 Symbols for certain types of information

Symbol	Meaning
	<p>Permitted Procedures, processes or actions that are permitted.</p>
	<p>Preferred Procedures, processes or actions that are preferred.</p>
	<p>Forbidden Procedures, processes or actions that are forbidden.</p>
	<p>Tip Indicates additional information.</p>
	Reference to documentation
	Reference to page
	Reference to graphic
	Visual inspection

1.2.5 Symbols in graphics

Symbol	Meaning
1, 2, 3 ...	Item numbers
1. 2. 3. ...	Series of steps
A, B, C, ...	Views
A-A, B-B, C-C, ...	Sections

1.3 Documentation



The document types listed are available:

In the Download Area of the Endress+Hauser Internet site: www.endress.com → Download

1.3.1 Technical Information (TI): planning aid for your device

TI01033P:

The document contains all the technical data on the device and provides an overview of the accessories and other products that can be ordered for the device.

1.3.2 Operating Instructions (BA): your comprehensive reference

BA01044P:

These Operating Instructions contain all the information that is required in various phases of the life cycle of the device: from product identification, incoming acceptance and storage, to mounting, connection, operation and commissioning through to troubleshooting, maintenance and disposal.

1.3.3 Description of Device Parameters (GP): reference for your parameters

GP01013P:

The document provides a detailed explanation of each individual parameter in the operating menu. The description is aimed at those who work with the device over the entire life cycle and perform specific configurations.

1.3.4 Safety Instructions (XA)

Safety Instructions (XA) are supplied with the device depending on the approval. These instructions are an integral part of the Operating Instructions.

Device	Directive	Documentation	Option ¹⁾
FMD71, FMD72	ATEX II 1/2G Ex ia IIC T6 Ga/Gb	XA00619P	BA
FMD71, FMD72	ATEX II 1/2G Ex d [ia] IIC T6 Ga/Gb	XA00620P	BC
FMD71, FMD72	ATEX II 3G Ex nA IIC T6 GC	XA00621P	BD
FMD71, FMD72	IEC Ex ia IIC T6 Ga/Gb	XA00622P	IA
FMD71, FMD72	IEC Ex d [ia] IIC T6 Ga/Gb	XA00623P	IB

Device	Directive	Documentation	Option ¹⁾
FMD71, FMD72	CSA General Purpose	-	CD
FMD71, FMD72	NEPSI Ex ia IIC T4/T6 Ga/Gb	XA01352P	NA
FMD71, FMD72	NEPSI Ex d [ia] IIC T4/T6 Ga/Gb	XA01353P	NB
FMD71, FMD72	INMETRO Ex ia IIC T6...T4 Ga/Gb	XA01378P	MA
FMD71, FMD72	INMETRO Ex d [ia] IIC T6...T4 Ga/Gb	XA01379P	MC
FMD71, FMD72	EAC Ga/Gb Ex ia IIC T6...T4	XA01594P	GA
FMD71, FMD72	EAC Ga/Gb Ex d [ia] IIC T6...T4 X	XA01595P	GB
FMD71	FM C/US IS Cl.I Div.1 Gr.A-D, AEx ia, Zone 0,1,2	XA00628P	FA
FMD71	FM C/US XP AIS Cl.I Div.1 Gr.A-D, Ex d [ia] Zone 0,1,2	XA00629P	FB
FMD71	CSA C/US XP Cl.I Div.1 Gr.A-D, Ex d [ia], Zone 0,1,2	XA00631P	CB
FMD71	FM C/US NI Cl.I Div.2 Gr.A-D, Zone 2	XA00668P	FD
FMD71	CSA C/US NI, Cl.I Div. 2, Gr.A-D Cl.I, Zone 2, IIC	XA00670P	CC
FMD71	CSA C/US IS Cl.I Div.1 Gr.A-D, Ex ia Zone 0,1,2	XA00630P	CA
FMD72	CSA C/US IS Cl.I Div.1 Gr.A-D, Ex ia Zone 0,1,2	XA00626P	CA
FMD72	CSA C/US XP Cl.I Div.1 Gr.A-D, Ex d [ia], Zone 0,1,2	XA00627P	CB
FMD72	CSA C/US NI, Cl.I Div.2 Gr.A-D, Zone 2	XA00671P	CC
FMD72	FM C/US IS Cl.I Div.1 Gr.A-D, AEx ia, Zone 0,1,2	XA00624P	FA
FMD72	FM C/US XP AIS Cl.I Div.1 Gr.A-D, Ex d [ia] Zone 0,1,2	XA00625P	FB
FMD72	FM C/US NI Cl.I Div.2 Gr.A-D, Zone 2	XA00669P	FD

1) Product Configurator order code for "Approval"



The nameplate provides information on the Safety Instructions (XA) that are relevant for the device.

1.4 Terms and abbreviations

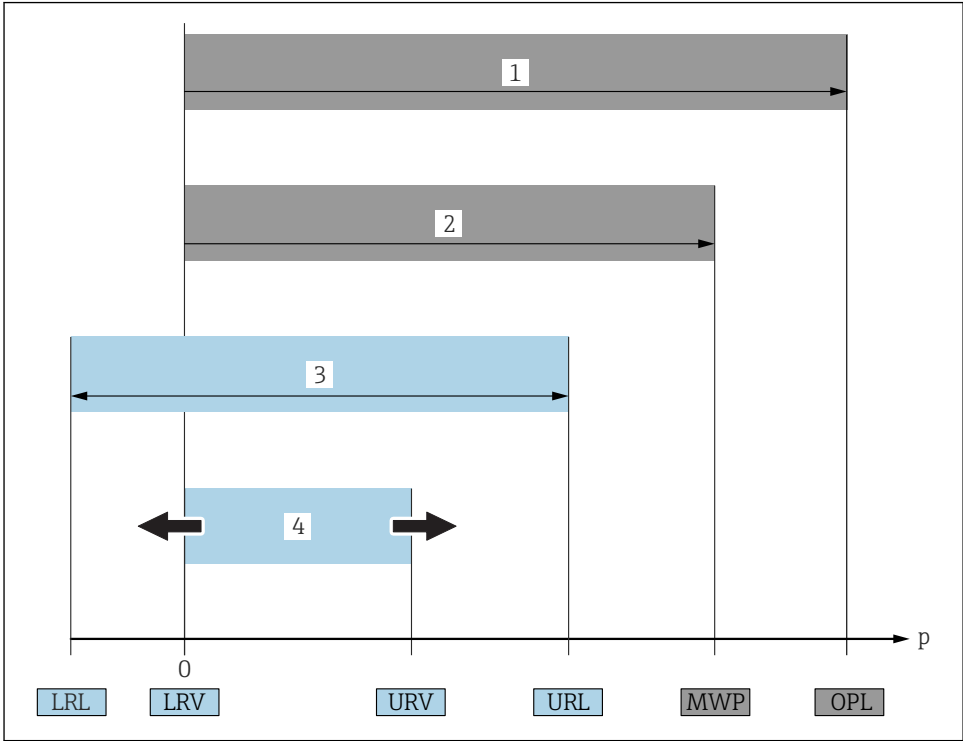

A0029505

Position	Term/ abbreviation	Explanation
1	OPL	The OPL (over pressure limit = sensor overload limit) for the measuring device depends on the lowest-rated element, with regard to pressure, of the selected components, i.e. the process connection has to be taken into consideration in addition to the measuring cell. Also observe pressure-temperature dependency. For the relevant standards and additional notes, see the "Pressure specifications" section of the Operating Instructions. The OPL may only be applied for a limited period of time.
2	MWP	The MWP (maximum working pressure) for the sensors depends on the lowest-rated element, with regard to pressure, of the selected components, i.e. the process connection has to be taken into consideration in addition to the measuring cell. Also observe pressure-temperature dependency. For the relevant standards and additional notes, see the "Pressure specifications" section of the Operating Instructions. The MWP may be applied at the device for an unlimited period. The MWP can also be found on the nameplate.

Position	Term/abbreviation	Explanation
3	Maximum sensor measuring range	Span between LRL and URL This sensor measuring range is equivalent to the maximum calibratable/adjustable span.
4	Calibrated/adjusted span	Span between LRV and URV Factory setting: 0 to URL Other calibrated spans can be ordered as customized spans.
p	-	Pressure
-	LRL	Lower range limit
-	URL	Upper range limit
-	LRV	Lower range value
-	URV	Upper range value
-	TD (Turn down)	Turn down Example - see the following section.

1.5 Turn down calculation

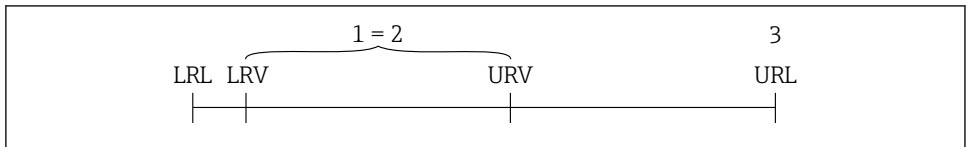

A0029545

- 1 *Calibrated/adjusted span*
- 2 *Zero point-based span*
- 3 *URL sensor*

Example

- Sensor: 10 bar (150 psi)
- Upper range value (URL) = 10 bar (150 psi)
- Calibrated/adjusted span: 0 to 5 bar (0 to 75 psi)
- Lower range value (LRV) = 0 bar (0 psi)
- Upper range value (URV) = 5 bar (75 psi)

Turn down (TD):

$$TD = \frac{URL}{|URV - LRV|}$$

$$TD = \frac{10 \text{ bar (150 psi)}}{|5 \text{ bar (75 psi)} - 0 \text{ bar (0 psi)}|} = 2$$

In this example, the TD is 2:1.

This span is based on the zero point.

1.6 Registered trademarks

1.6.1 HART®

Registered trademark of the FieldComm Group, Austin, USA

2 Basic safety instructions

2.1 Requirements concerning the staff

The staff must fulfill the following requirements for their tasks:

- ▶ Trained staff: Must have a qualification which corresponds to their function and tasks.
- ▶ Authorized by the plant operator.
- ▶ Familiar with the national regulations.
- ▶ Before starting their work: Must have read and understood all instructions in the operating manual and supplementary documentation as well as the certificate (depending on the application).
- ▶ Must comply with all instructions and the regulatory framework.

2.2 Designated use

2.2.1 Application and media

The Deltabar FMD72 is a differential pressure transmitter for measuring differential pressure and level in pressurized tanks. The device has two sensor modules, which measure the operating pressure (High Pressure HP and Low Pressure LP). The differential pressure/hydrostatic level is calculated in the transmitter unit. The sensor signal is transmitted digitally. In addition, sensor temperatures and the individual process pressures present at the respective sensor modules can be individually evaluated and transmitted. If the limit values specified in the "Technical Data" and the conditions listed in the instructions and additional documentation are observed, the measuring device may be used for the following measurements (process variables):

Measured process variables

- Pressure HP and Pressure LP
- Sensor temperature HP and sensor temperature LP
- Transmitter temperature

Calculated process variables

- Differential pressure
- Level (level, volume or mass)

2.2.2 Incorrect use

The manufacturer is not liable for damage caused by improper or non-designated use.

Verification for borderline cases:

- ▶ For special fluids and fluids for cleaning, Endress+Hauser is glad to provide assistance in verifying the corrosion resistance of fluid-wetted materials, but does not accept any warranty or liability.

2.2.3 Residual risks

Due to heat transfer from the process as well as power loss in the electronics, the temperature of the electronics housing and the assemblies contained therein (e.g. display module, main electronics module and I/O electronics module) may rise up to 80 °C (176 °F). When in operation, the sensor can reach a temperature close to the medium temperature.

Danger of burns from contact with surfaces!

- ▶ For elevated fluid temperature, ensure protection against contact to prevent burns.

2.3 Workplace safety

For work on and with the device:

- ▶ Wear the required personal protective equipment according to federal/national regulations.
- ▶ Switch off the supply voltage before connecting the device.

2.4 Operational safety

Risk of injury!

- ▶ Operate the device in proper technical condition and fail-safe condition only.
- ▶ The operator is responsible for interference-free operation of the device.

Modifications to the device

Unauthorized modifications to the device are not permitted and can lead to unforeseeable dangers.

- ▶ If, despite this, modifications are required, consult with Endress+Hauser.

Repairs

To ensure continued operational safety and reliability,

- ▶ Carry out repairs on the device only if they are expressly permitted.
- ▶ Observe federal/national regulations pertaining to repair of an electrical device.
- ▶ Use original spare parts and accessories from Endress+Hauser only.

Hazardous area

To eliminate danger to persons or the facility when the device is used in the approval-related area (e.g. explosion protection, pressure vessel safety):

- ▶ Check the nameplate to verify if the device ordered can be put to its intended use in the approval-related area.
- ▶ Observe the specifications in the separate supplementary documentation that is an integral part of these Instructions.

2.5 Product safety

This measuring device is designed in accordance with good engineering practice to meet state-of-the-art safety requirements, has been tested, and left the factory in a condition in which it is safe to operate.

It meets general safety standards and legal requirements. It also complies with the EC directives listed in the device-specific EC Declaration of Conformity. Endress+Hauser confirms this by affixing the CE mark to the device.

3 Product description

3.1 Product design

See Operating Instructions.

Level measurement (level, volume and mass) with Deltabar:

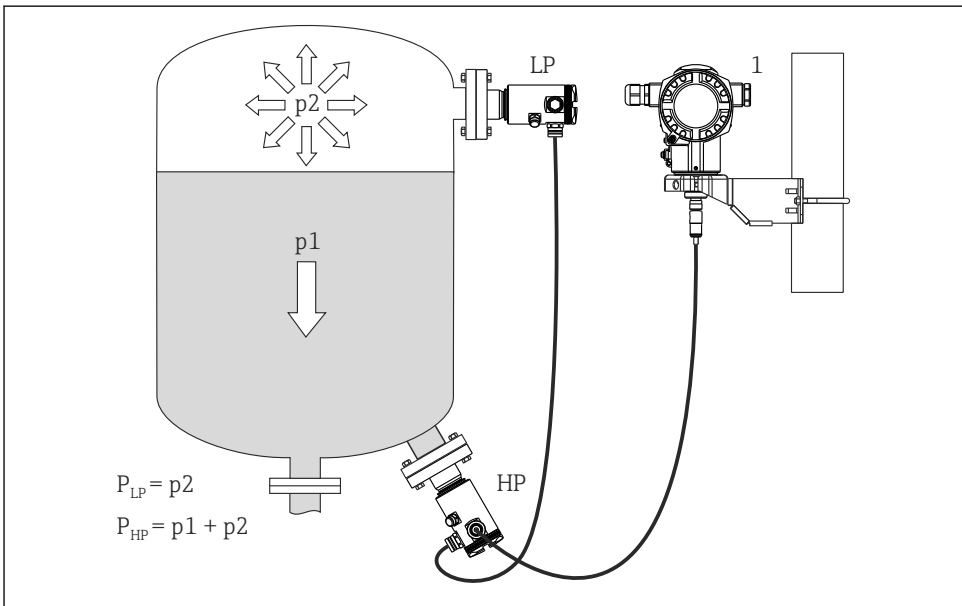

A0016449

- LP Sensor module LP (low pressure)
- HP Sensor module HP (high pressure)
- p_2 Head pressure
- p_1 Hydrostatic pressure
- 1 Transmitter

The FMD71/FMD72 is best suited to level measurement in vessels with pressure overlay or in vacuum vessels and tanks, high distillation columns and other vessels with changing ambient temperatures.

The sensor module HP is mounted on the lower measuring connection and the sensor module LP is mounted above the maximum level. The transmitter can be mounted on pipes or walls with the mounting bracket.

The sensor signal is transmitted digitally. In addition, sensor temperatures and the individual process pressures present at the respective sensor modules can be individually evaluated and transmitted.

NOTICE

Incorrect sizing/order of sensor modules

- ▶ In a closed system, please note that the sensor module is affected by the superimposed head pressure (p2) in addition to the hydrostatic pressure (p1). This must be taken into account when sizing the sensor module on the high-pressure side (HP).

4 Incoming acceptance and product identification

4.1 Incoming acceptance

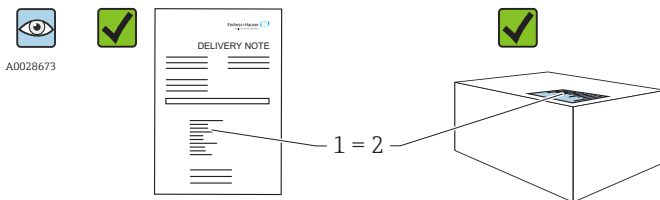

A0016870

Is the order code on the delivery note (1) identical to the order code on the product sticker (2)?

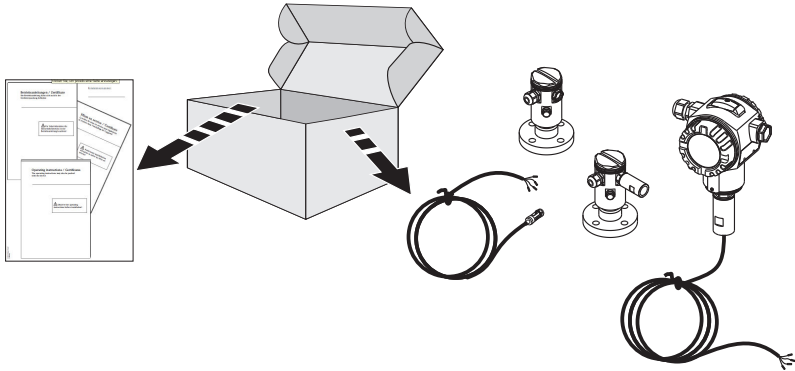

A0016052

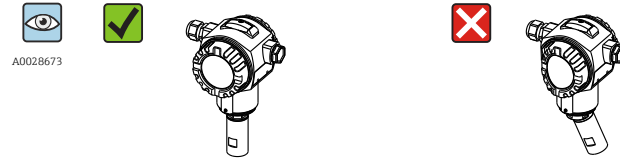

A0028673

A0016053

Are the goods undamaged?

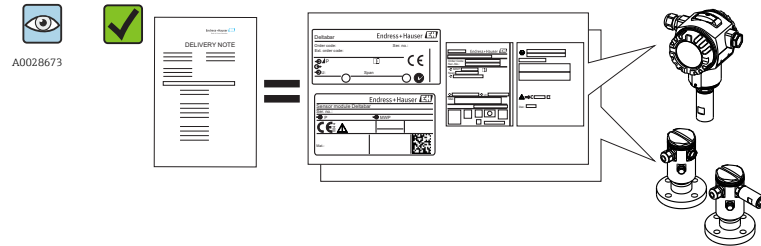

A0028673

A0016054

Do the data on the nameplate correspond to the order specifications and the delivery note?

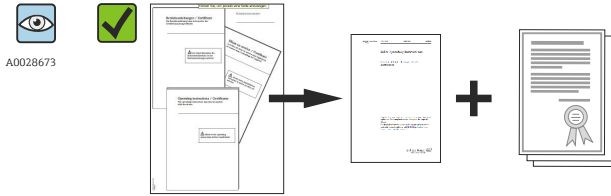

A0022106

Is the documentation provided?

If required (see nameplate): Are the safety instructions (XA) present?



If one of these conditions is not fulfilled, please contact your Endress+Hauser sales office.

4.2 Product identification

The following options are available for identification of the measuring device:

- Nameplate specifications
- Order code with breakdown of the device features on the delivery note
- Enter serial numbers from nameplates in *W@M Device Viewer* (www.endress.com/deviceviewer): All information about the measuring device is displayed.

For an overview of the technical documentation provided, enter the serial number from the nameplates in *W@M Device Viewer* (www.endress.com/deviceviewer)

4.2.1 Manufacturer address

Endress+Hauser GmbH+Co. KG

Hauptstraße 1

79689 Maulburg, Germany

Address of the manufacturing plant: See nameplate.

4.3 Nameplates

4.3.1 Nameplates of the T14 transmitter housing

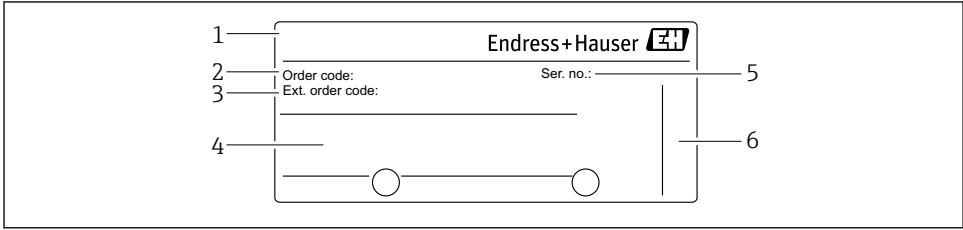

A0016056

- 1 Device name
- 2 Order code (for re-orders)
- 3 Extended order code (complete)
- 4 Technical data
- 5 Serial number (for identification)
- 6 Manufacturer address

Additional nameplate for devices with Ex approval

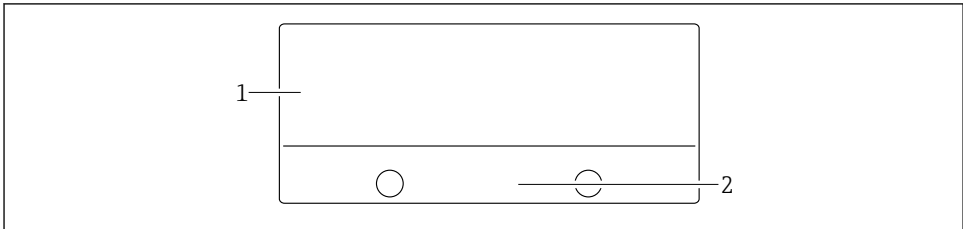

A0021222

- 1 Approval-specific information
- 2 Document number of Safety Instructions or drawing number

Additional nameplate for devices with PVDF process connection

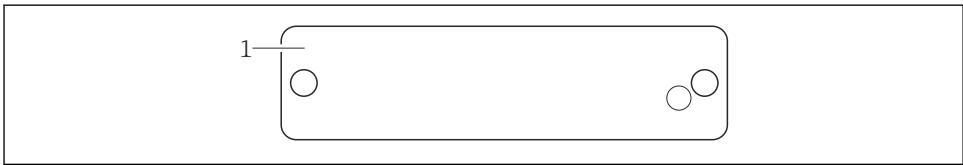

A0022683

- 1 application limits

4.3.2 Nameplates of the T17 transmitter housing

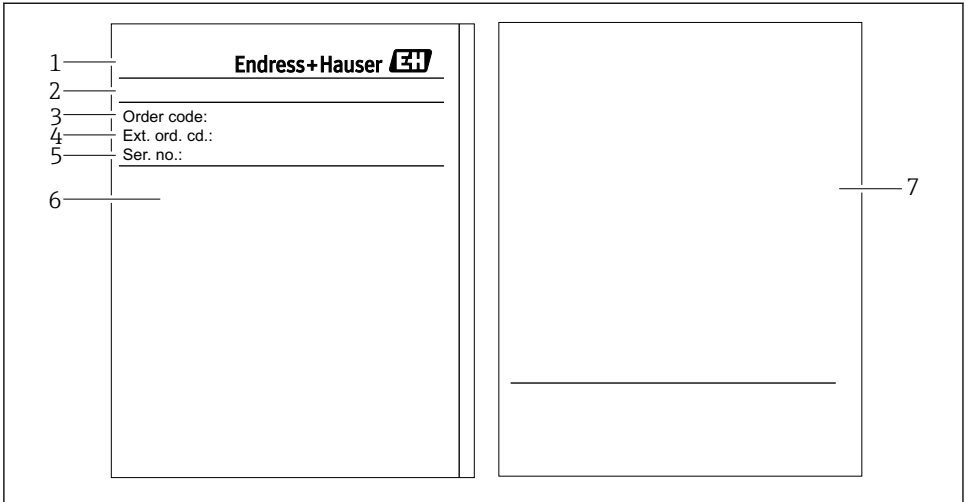

A0021552

- 1 Device name
- 2 Manufacturer address
- 3 Order code (for re-orders)
- 4 Extended order code (complete)
- 5 Serial number (for identification)
- 6 Technical data
- 7 Approval-related information and document number of Safety Instructions or drawing number

4.3.3 Nameplate of the sensor housing

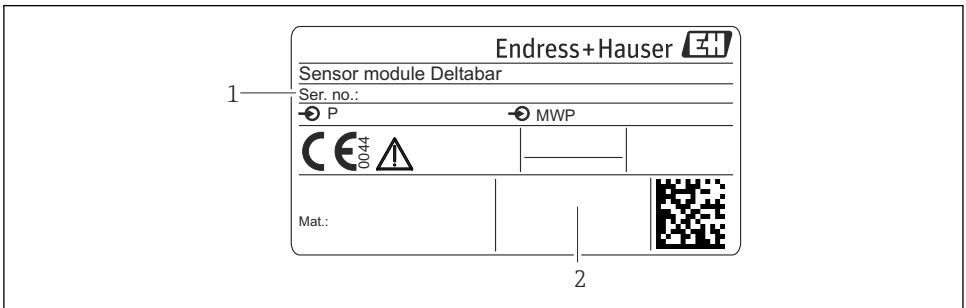

A0021224

- 1 Sensor serial number
- 2 Identification of sensor type (HP/LP)

4.4 Storage and transport

4.4.1 Storage conditions

Use original packaging.

Store the measuring device in clean and dry conditions and protect from damage caused by shocks (EN 837-2).

Storage temperature range

-40 to +80 °C (-40 to +176 °F)

4.4.2 Transporting the product to the measuring point

⚠ WARNING

Incorrect transport!

Housing and diaphragm may become damaged, and there is a risk of injury!

- ▶ Transport the measuring device to the measuring point in its original packaging or by the process connection.
- ▶ Follow the safety instructions and transport conditions for devices weighing more than 18 kg (39.6 lbs).

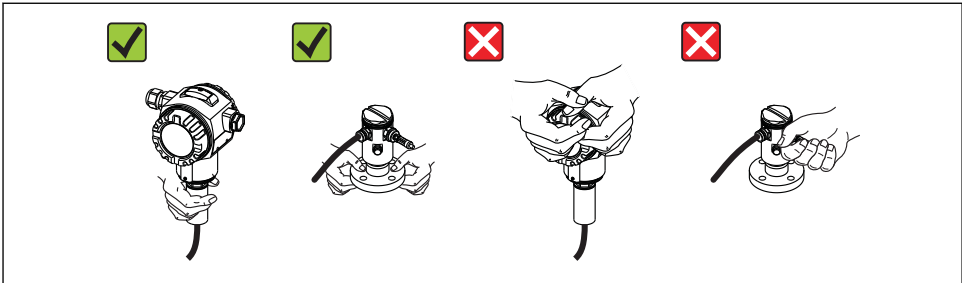

A0016058

5 Installation

- Moisture must not penetrate the housing when mounting the device, establishing the electrical connection and during operation.
- When measuring in media containing solids, such as dirty liquids, installing separators and drain valves is useful for capturing and removing sediment.
- Do not clean or touch process isolating diaphragms with hard and/or pointed objects.
- Do not remove process isolating diaphragm protection until shortly before installation.
- Always firmly tighten the housing cover and the cable entries.
- Point the cable and connector downwards where possible to prevent moisture from entering (e.g. rain or condensation water).

5.1 Mounting dimensions

For dimensions, see the "Mechanical construction" section in the Technical Information.

5.2 Mounting location

The FMD71/FMD72 is best suited to level measurement in vessels with pressure overlay or in vacuum vessels and tanks, high distillation columns and other vessels with changing ambient temperatures.

The sensor module HP is mounted on the lower measuring connection and the sensor module LP is mounted above the maximum level. The transmitter can be mounted on pipes or walls with the mounting bracket.

5.3 Orientation

- Transmitter: Any orientation.
- Sensor modules: The orientation can cause a zero point shift .
This position-dependent zero point shift can be corrected directly at the device via the operating key, and also in hazardous areas in the case of devices with external operation (position adjustment).

5.4 General installation instructions

Mounting the sensor modules and transmitter is very easy

- The housings of the sensor modules can be rotated up to 360°.
- The transmitter is freely rotatable in the mounting bracket.

The sensor modules and transmitter can be easily aligned when mounted.

Your benefits



- Easy mounting due to optimum alignment of housing
- Easily accessible device operation
- Optimum readability of the onsite display (optional)
- Easy pipe installation due to optional alignment of the modules.

5.5 Thermal insulation - FMD71 high-temperature version

See Operating Instructions.

5.6 Installing the sensor modules

5.6.1 General installation instructions

- The nameplate on the sensor module specifies where the sensor module is typically installed:
HP (bottom)
LP (top)
For further information, see the "Function" section .
- Due to the orientation of the sensor modules, there may be a shift in the zero point, i.e. when the vessel is empty or partially full, the measured value does not display zero. You can correct this zero point shift: see the "Commissioning without an operating menu" →  37 or the "Position adjustment" →  41 section.
- Always install the sensor module HP below the lowest measuring point.
- Always install the sensor module LP above the highest measuring point.
- Do not mount the sensor modules in the filling curtain or at a point in the tank which could be affected by pressure pulses from an agitator.
- Do not mount the sensor modules in the suction area of a pump.
- The adjustment and functional test can be carried out more easily if you mount the sensor modules downstream of a shutoff device.
- If a heated sensor module is cooled during the cleaning process (e.g. by cold water), a vacuum develops for a short time, whereby moisture can penetrate the sensor through the pressure compensation (3). If this is the case, mount the sensor with the pressure compensation (3) pointing downwards.
- Keep the pressure compensation and GORE-TEX® filter (3) free from contamination.
- Do not clean or touch process isolating diaphragms with hard or pointed objects.

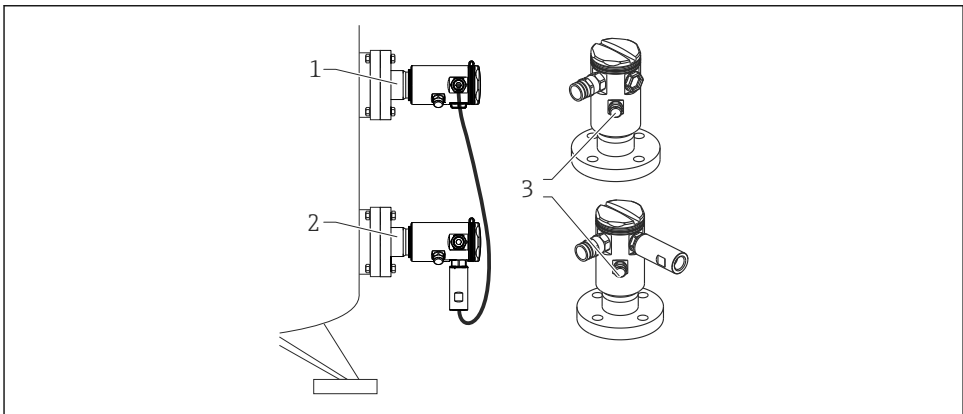

A0017512

5.7 Mounting sensor modules with PVDF installation coupling

WARNING

Risk of damage to process connection!

Risk of injury!

- ▶ Sensor modules with PVDF process connections with threaded connection must be installed with the mounting bracket provided!

WARNING

Material fatigue from pressure and temperature!

Risk of injury due to bursting of parts! The thread can become loose if exposed to high pressure and temperature loads.

- ▶ The integrity of the thread must be checked regularly and the thread may need to be retightened with the maximum tightening torque of 7 Nm (5.16 lbf ft). Teflon tape is recommended for sealing the ½" NPT thread.

The mounting bracket can be installed on pipes with a diameter of 1¼" to 2" or on walls.

In the case of pipe mounting, the nuts on the bracket must be tightened uniformly with a torque of at least 5 Nm (3.69 lbf ft).

- The mounting bracket is included in the delivery.
- Ordering information:
Product Configurator order code for "Enclosed accessories", option "PA" or as a separate accessory (part no.: 71102216).

5.8 Installing the transmitter

The transmitter is installed with the mounting bracket supplied. The mounting bracket can be installed on pipes with a diameter of 1¼" to 2" or on walls.

In the case of pipe mounting, the nuts on the bracket must be tightened uniformly with a torque of at least 5 Nm (3.69 lbf ft).

The mounting bracket is included in the delivery.

5.8.1 Turning the display module

See "Operating Instructions".

5.9 Closing the housing cover

NOTICE

The housing cover can no longer be closed.

Damaged thread!

- ▶ When closing the housing cover, please ensure that the thread of the cover and housing are free from dirt, e.g. sand. If you feel any resistance when closing the cover, check the thread on both again to ensure that they are free from dirt.

5.9.1 Closing the covers on the hygienic stainless steel housing (T17)

The covers for the terminal compartment and electronics compartment are hooked into the housing and closed with a screw in each case. These screws must be tightened finger-tight (2 Nm (1.48 lbf ft)) to the stop to ensure that the covers are securely seated and leak-tight.

5.10 Seal for flange mounting

NOTICE

Distorted measurement results.

The seal is not allowed to press against the process isolating diaphragm as this could affect the measurement result.

- ▶ Ensure that the seal is not touching the process isolating diaphragm.

5.11 Post-installation check

<input type="checkbox"/>	Is the device undamaged (visual inspection)?
<input type="checkbox"/>	Does the device comply with the measuring point specifications? For example: <ul style="list-style-type: none"> ▪ Process temperature ▪ Process pressure ▪ Ambient temperature ▪ Measuring range
<input type="checkbox"/>	Are the measuring point identification and labeling correct (visual inspection)?
<input type="checkbox"/>	Is the device adequately protected against precipitation and direct sunlight?
<input type="checkbox"/>	Are the securing screw and securing clamp tightened securely?

6 Electrical connection

WARNING

If the operating voltage is > 35 VDC: Dangerous contact voltage at terminals.

Risk of electric shock!

► In a wet environment, do not open the cover if voltage is present.



The sensor modules have a designation independent of the master/slave configuration.

This indicates where the sensor module is typically installed:

- Sensor module LP
LP = Low pressure; top
- Sensor module HP
HP = High pressure; bottom

For further information, see the "Function" section .

6.1 Connecting the sensor module LP to the sensor module HP

WARNING

Supply voltage might be connected!

Risk of electric shock and/or explosion!

► Switch off the supply voltage before connecting the device.

- Screw on the housing cover of the terminal compartment of the sensor module LP.
- Guide the cable of the sensor module HP through the cable gland of the sensor module LP. Use the shielded 4-wire cable that is provided. The wire ends are color-coded to match the corresponding terminal.
- Connect device in accordance with the following diagrams.
- Screw down housing cover.

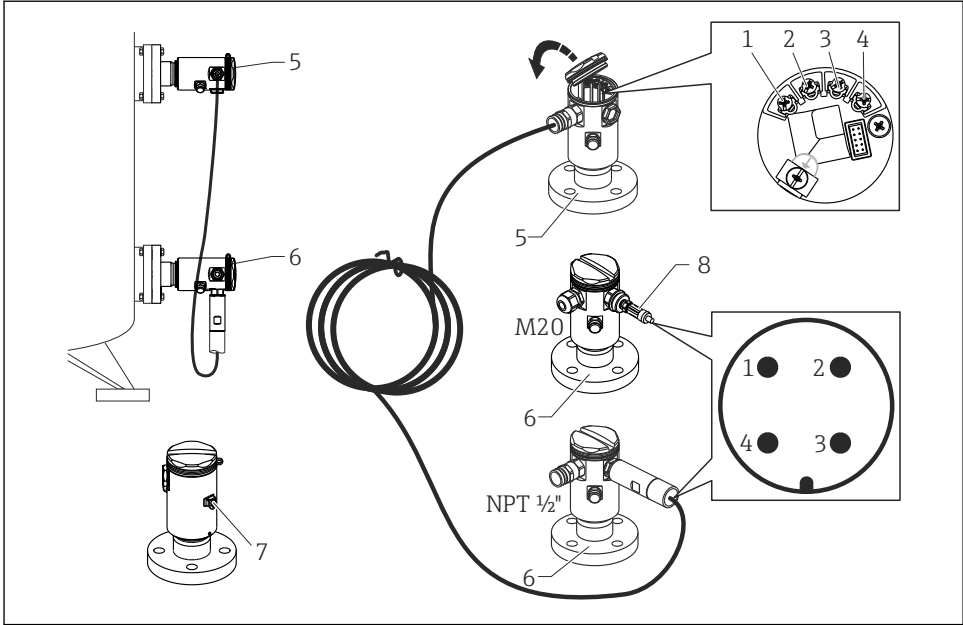

A0017528

- 1 BK (black)
- 2 BU (blue)
- 3 WH (white)
- 4 BN (brown)
- 5 Sensor module LP
- 6 Sensor module HP
- 7 Ground terminal
- 8 Torque 0.4 Nm

6.1.1 Screening with cable shield

Screening with cable shield is described in the associated documentation SD00354P. The documentation is provided with the connecting cables.

6.2 Connecting the sensor module HP to the transmitter

⚠ WARNING

Supply voltage might be connected!

Risk of electric shock and/or explosion!

- ▶ Switch off the supply voltage before connecting the device.

- Screw on the housing cover of the terminal compartment of the sensor module HP.
- Guide the cable of the transmitter through the cable gland of the sensor module HP. Use the shielded 4-wire cable that is provided. The wire ends are color-coded to match the corresponding terminal.
- Connect device in accordance with the following diagram.
- Screw down housing cover.

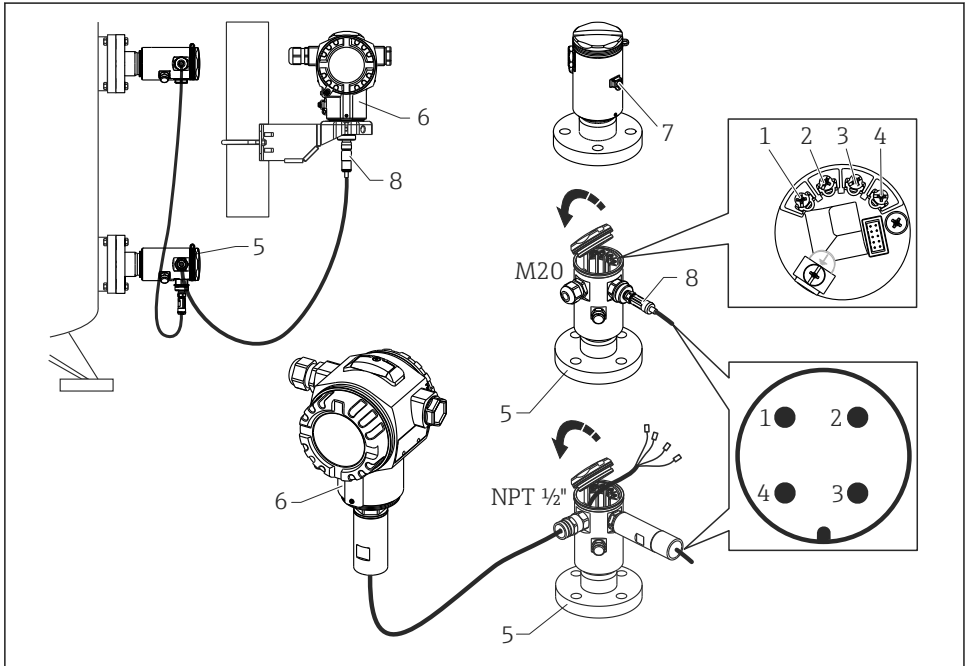

A0017529

- 1 BK (black)
- 2 BU (blue)
- 3 WH (white)
- 4 BN (brown)
- 5 Sensor module HP
- 6 Transmitter
- 7 Ground terminal
- 8 Torque 0.4 Nm

6.2.1 Screening with cable shield

Screening with cable shield is described in the associated documentation SD00354P. The documentation is provided with the connecting cables.

6.3 Connecting the measuring unit

6.3.1 Terminal assignment

WARNING

Supply voltage might be connected!

Risk of electric shock and/or explosion!

- ▶ Switch off the supply voltage before connecting the device.

WARNING

Electrical safety is compromised by an incorrect connection!

- ▶ In accordance with IEC/EN61010 a separate circuit breaker must be provided for the device .
- ▶ When using the measuring device in hazardous areas, installation must comply with the corresponding national standards and regulations and the Safety Instructions or Installation or Control Drawings.
- ▶ All explosion protection data are given in separate documentation which is available upon request. The Ex documentation is supplied as standard with all devices approved for use in explosion hazardous areas.
- ▶ Devices with integrated overvoltage protection must be grounded.
- ▶ Protective circuits against reverse polarity, HF influences and overvoltage peaks are integrated.

Connect the device in the following order:

1. Check whether the supply voltage matches the supply voltage indicated on the nameplate.
2. Remove the housing cover.
3. Guide cable through the gland.
4. Connect device in accordance with the following diagram.
5. Screw down housing cover.

Switch on supply voltage.

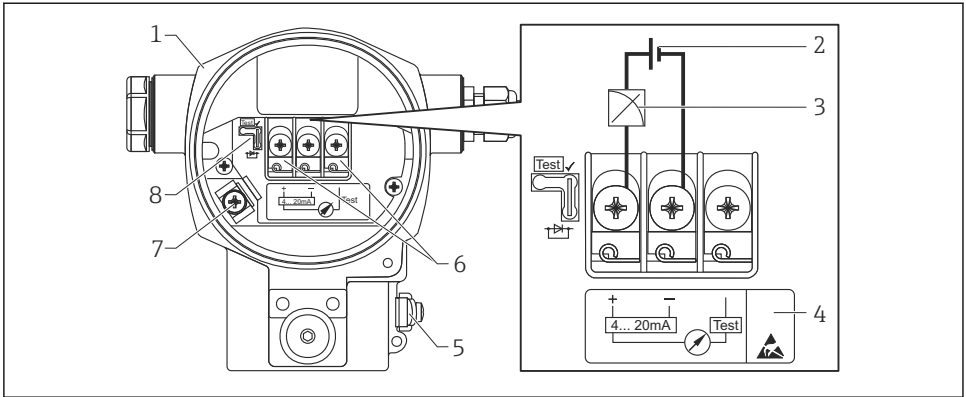

A0019989

- 1 Housing
- 2 Supply voltage
- 3 4 to 20 mA
- 4 Devices with integrated overvoltage protection are labeled "OVP" (overvoltage protection) here.
- 5 External ground terminal
- 6 4 to 20 mA test signal between positive and test terminal
- 7 Internal ground terminal, minimum supply voltage = 12 V DC, jumper is set as illustrated in the diagram.
- 8 Jumper for 4 to 20 mA test signal,

6.3.2 Supply voltage

⚠ WARNING

Supply voltage might be connected!

Risk of electric shock and/or explosion!

- ▶ When using the measuring device in hazardous areas, installation must comply with the corresponding national standards and regulations as well as the Safety Instructions.
- ▶ All explosion protection data are given in separate documentation which is available upon request. The Ex documentation is supplied as standard with all devices approved for use in explosion hazardous areas.

Electronic version	Jumper for 4 to 20 mA test signal in "Test" position (delivery status)	Jumper for 4 to 20 mA test signal in "Non-test" position
4 to 20 mA HART, version for non-hazardous areas	13 to 45 V DC	12 to 45 V DC

Measuring a 4 to 20 mA test signal

See Operating Instructions.

6.4 Connection conditions

6.4.1 Cable specification

Preferably use twisted, screened two-wire cable.

6.4.2 Cable specification for transmitter connection

See Operating Instructions.

6.4.3 Cable entries

See Operating Instructions.

6.4.4 Overvoltage protection

Standard version

The standard version of the pressure instruments does not contain any special elements to protect against overvoltage ("wire to ground"). Nevertheless the requirements of the applicable EMC standard EN 61000-4-5 (testing voltage 1kV EMC wire/ground) are met.

Optional overvoltage protection

See Operating Instructions.

6.5 Connection data

See Operating Instructions.

6.5.1 Maximum load

See Operating Instructions.



When operating via a handheld terminal or via a PC with an operating program, a minimum communication resistance of 250 Ω must be taken into account.

6.6 Post-connection check

<input type="checkbox"/>	Is the device or cable undamaged (visual inspection)?
<input type="checkbox"/>	Do the cables comply with the requirements?
<input type="checkbox"/>	Do the mounted cables have adequate strain relief?
<input type="checkbox"/>	Are all the cable glands installed, tightened and sealed?
<input type="checkbox"/>	Does the supply voltage match the specifications on the nameplate?
<input type="checkbox"/>	Is the terminal assignment correct ?
<input type="checkbox"/>	If required: Has protective ground connection been established?
<input type="checkbox"/>	If supply voltage is present, is the device ready for operation and do values appear on the display module?
<input type="checkbox"/>	Are all the housing covers installed and tightened?
<input type="checkbox"/>	Is the securing clamp tightened correctly?

7 Operation options

7.1 Operation without operating menu

7.1.1 Position of operating elements

Operating keys on the exterior of the device

With the T14 housing (aluminum or stainless steel), the operating keys are located either outside of the housing, under the protection cap or inside on the electronic insert. In addition, devices with an onsite display and a 4 to 20 mA HART electronic insert have operating keys on the onsite display.

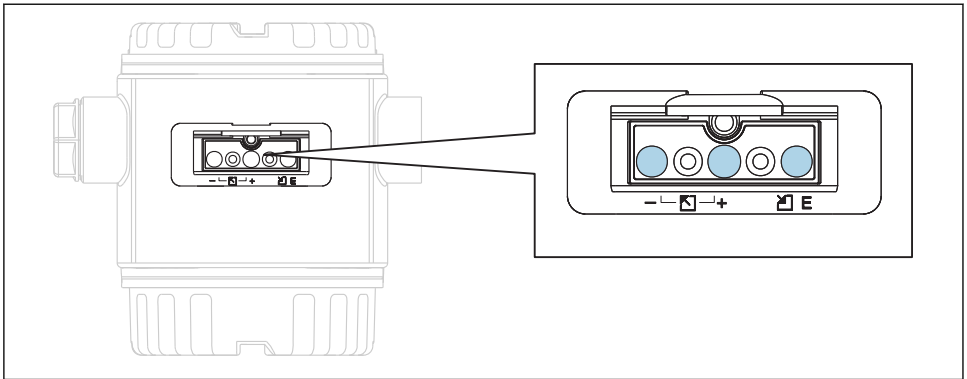

A0016499

The operating keys on the outside of the device make it unnecessary to open the housing. This guarantees:

- Complete protection against environmental influences such as moisture and contamination
- Simple operation without any tools
- No wear.

Operating keys and elements located internally on the electronic insert

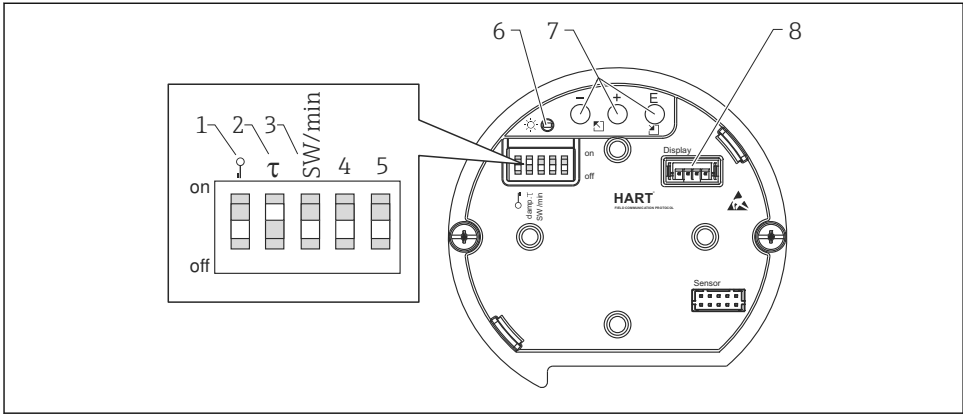

A0016500









- 1 *DIP switch for locking/unlocking parameters relevant to the measured value*
- 2 *DIP switch for switching damping on/off*
- 3 *DIP switch for alarm current SW/Alarm min (3.6 mA)*
- 4...5 *Not assigned*
- 6 *Green LED to indicate value being accepted*
- 7 *Operating keys*
- 8 *Slot for optional display*

Function of the DIP switches

Switch	Symbol/ labeling	Switch position	
		"off"	"on"
1	 A0011978	The device is unlocked. Parameters relevant to the measured value can be modified.	The device is locked. Parameters relevant to the measured value cannot be modified.
2	damping τ	Damping is switched off. The output signal follows measured value changes without any delay.	Damping is switched on. The output signal follows measured value changes with the delay time τ . ¹⁾
3	SW/Alarm min	The alarm current is defined by the setting in the operating menu. ("Setup" → "Extended setup" → "Current output" → "Output fail mode") ²⁾	The alarm current is 3.6 mA (min), regardless of the setting in the operating menu.

- 1) The value for the delay time can be configured via the operating menu ("Setup" → "Damping"). Factory setting: $\tau = 2$ s or as per order specifications.
- 2) Factory setting: 22 mA

Function of the operating elements

	Operating key(s)	Meaning
 A0017535	Press for at least 3 seconds	Adopt lower range value. A reference pressure is present at the device. For a detailed description, see also "Pressure measuring mode" section (see "Operating Instructions"), or "Level measuring mode" section. →  37
 A0017536	Press for at least 3 seconds	Adopt upper range value. A reference pressure is present at the device. For a detailed description, see also "Pressure measuring mode" section (see "Operating Instructions"), or "Level measuring mode" section →  37.
 A0017537	Press for at least 3 seconds	Position adjustment
 and  and  A0017535 A0017536 A0017537	Press for at least 6 seconds	Reset all parameters. The reset via operating keys corresponds to the software reset code 7864.

7.2 Operation with an operating menu

7.2.1 Operation concept

Operation with an operating menu is based on an operation concept with "user roles".

User role	Meaning
Operator	Operators are responsible for the devices during normal "operation". This is usually limited to reading process values either directly at the device or in a control room. If the work with the devices extends beyond value read-off tasks, the tasks involve simple, applicationspecific functions that are used in operation. Should an error occur, these users simply forward the information on the errors but do not intervene themselves.
Maintenance	Service engineers usually work with the devices in the phases following device commissioning. They are primarily involved in maintenance and troubleshooting activities for which simple settings have to be made at the device. Technicians work with the devices over the entire life cycle of the product. Thus, commissioning and advanced settings and configurations are some of the tasks they have to carry out.
Expert	Experts work with the devices over the entire life cycle of the device, but, at times, have high device requirements. Individual parameters/functions from the overall functionality of the devices are required for this purpose time and again. In addition to technical, process-oriented tasks, experts can also perform administrative tasks (e.g. user administration). "Experts" can access the entire parameter set.

7.3 Structure of the operating menu

User role	Submenu	Meaning/use
Operator	Language	Only consists of the "Language" parameter (000) where the operating language for the device is specified. The language can always be changed even if the device is locked.
Operator	Display/ operat.	Contains parameters that are needed to configure the measured value display (selecting the values displayed, display format, display contrast, etc.). With this submenu, users can change the measured value display without affecting the actual measurement.
Maintenance	Setup	<p>Contains all the parameters that are needed to commission measuring operations. This submenu has the following structure:</p> <ul style="list-style-type: none"> ▪ Standard setup parameters A wide range of parameters, which can be used to configure a typical application, is available at the start. The measuring mode selected determines which parameters are available. After making settings for all these parameters, the measuring operation should be completely configured in the majority of cases. ▪ "Extended setup" submenu The "Extended setup" submenu contains additional parameters for more indepth configuration of the measurement operation to convert the measured value and to scale the output signal. This menu is split into additional submenus depending on the measuring mode selected.
Maintenance	Diagnosis	<p>Contains all the parameters that are needed to detect and analyze operating errors. This submenu has the following structure:</p> <ul style="list-style-type: none"> ▪ Diagnostic list Contains up to 10 error messages currently pending. ▪ Event logbook Contains the last 10 error messages (no longer pending). ▪ Instrument info Contains information on the device identification. ▪ Measured values Contains all the current measured values ▪ Simulation Is used to simulate pressure, level, current and alarm/warning. ▪ Reset ▪ Sensor LP ▪ Sensor HP
Expert	Expert	<p>Contains all the parameters of the device (including those in one of the submenus). The "Expert" submenu is structured by the function blocks of the device. It thus contains the following submenus:</p> <ul style="list-style-type: none"> ▪ System Contains all the device parameters that neither affect measurement nor integration into a distributed control system. ▪ Measurement Contains all the parameters for configuring the measurement. ▪ Output Contains all the parameters for configuring the current output. ▪ Communication contains all parameters for configuring the HART interface. ▪ Diagnosis Contains all the parameters that are needed to detect and analyze operating errors.

7.4 Operating options

7.4.1 Local operation

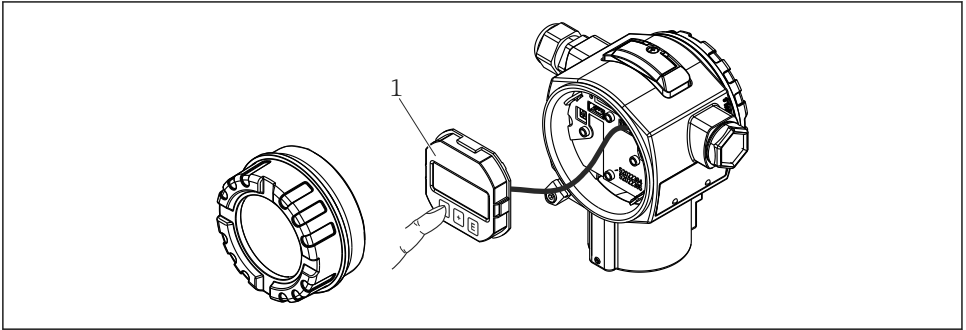

A0017650

1 Display and operating module with push buttons. Cover must be opened for operation.

7.5 Operating the device using onsite display (optional)

A 4-line liquid crystal display (LCD) is used for display and operation. The onsite display shows measured values, dialog text as well as fault and notice messages in plain text, thereby supporting the user in every stage of operation.

The display can be removed for easy operation.

The device display can be turned in 90° steps.

Depending on the installation position of the device, this makes it easy to operate the device and read the measured value.

Functions:

- 8-digit measured value display including sign and decimal point, bargraph for 4 to 20 mA HART as current display.
- Simple and complete menu guidance due to breakdown of parameters into several levels and groups.
- Each parameter is given a 3-digit ID number for easy navigation.
- Option for configuring the display according to individual requirements and preferences, such as language, alternating display, display of other measured values such as sensor temperature, contrast setting.
- Comprehensive diagnostic functions (fault and warning message, peak-hold indicators, etc.).
- Quick and safe commissioning

7.5.1 Overview

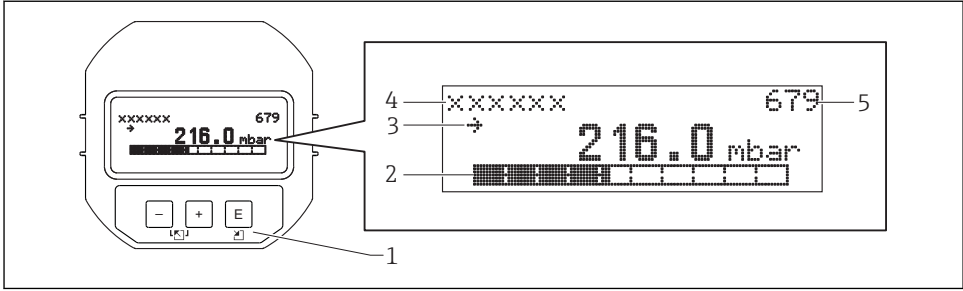

A0016498

- 1 Operating keys
- 2 Bargraph
- 3 Symbol
- 4 Header
- 5 Parameter ID number

7.5.2 Setting the contrast on the display module

- \oplus and \boxminus (press simultaneously): increases the contrast.
- \boxplus and \boxminus (press simultaneously): decreases the contrast.

7.5.3 Symbols on the onsite display

The following tables show the icons that can be used on the local display. Four symbols may appear at the same time.

Error symbols

See Operating Instructions.

Display symbols for locking status









See Operating Instructions.

Display symbols for communication

See Operating Instructions.





7.5.4 Navigation and selection from list

The operating keys are used to navigate through the operating menu and to select an option from a picklist.

Operating key(s)	Meaning
 A0017879	<ul style="list-style-type: none"> Navigate downwards in the picklist Edit the numerical values and characters within a function
 A0017880	<ul style="list-style-type: none"> Navigate upwards in the picklist Edit the numerical values and characters within a function
 A0017881	<ul style="list-style-type: none"> Confirm entry Jump to the next item Selection of a menu item and activation of edit mode
 and  A0017879 A0017881	Contrast setting of onsite display: darker
 and  A0017880 A0017881	Contrast setting of onsite display: brighter
 and  A0017879 A0017880	ESC functions: <ul style="list-style-type: none"> Exit edit mode for a parameter without saving the changed value. You are in a menu at a selection level. Each time you press the keys simultaneously, you go up a level in the menu.

7.5.5 Navigation examples

Parameters with a picklist

	Language	000	Software operation
1	✓ German Spanish		"English" is set as the menu language (default value). A ✓ in front of the menu text indicates the option that is currently active.
2	German ✓ Spanish		Select the menu language "Spanish" using  or  .
3	✓ Spanish German		Confirm your selection with  A ✓ in front of the menu text indicates the option that is currently active ("Spanish" is the language selected). Use  to exit edit mode for the parameter.

Accepting the pressure present

Example: setting position adjustment.

Menu path: Main menu → Setup → Pos. zero adjust

	Pos. zero adjust	007	Software operation
1	✓ Cancel Confirm		The pressure for position adjustment is present at the device.
2	Cancel ✓ Confirm		Use <input type="checkbox"/> or <input type="checkbox"/> to switch to the "Confirm" option. The active option is highlighted in black.
3	Adjustment has been accepted!		Use the <input type="checkbox"/> key to accept the applied pressure as a position adjustment. The device confirms the adjustment and goes back to the "Pos. zero adjust" parameter.
4	✓ Cancel Confirm		Use <input type="checkbox"/> to exit edit mode for the parameter.

User-definable parameters

See Operating Instructions.

7.6 Operation using Endress+Hauser operating program

See Operating Instructions.

7.7 Direct access to parameters

See Operating Instructions.

7.8 Locking/unlocking operation

See Operating Instructions.

7.9 Resetting to factory settings (reset)

See Operating Instructions.

8 Integrating transmitter via HART® protocol

See Operating Instructions.

9 Commissioning



NOTICE

If a pressure smaller than the minimum permitted pressure or greater than the maximum permitted pressure is present at the device, the following messages are output in succession:

- ▶ "S140 Working range P LP/HP" or "F140 Working range P LP/HP" (depending on the setting in the "Alarm behav. P" (050) parameter)
- ▶ "S841 Sensor range LP/HP" or "F841 Sensor range LP/HP" (depending on the setting in the "Alarm behav. P" (050) parameter)
- ▶ "S945/F945 Pressure limit LP"
- ▶ "S971 Calibration"

9.1 Post-installation check and function check

Before commissioning your measuring point, ensure that the post-installation and post-connection check have been performed:

- "Post-installation check" checklist →  22
- "Post-connection check" checklist →  28

9.2 Unlocking/locking configuration

If the device is locked to prevent configuration, it must first be unlocked.

9.2.1 Locking/unlocking hardware

If the device is locked via the hardware (write protection switch) and an attempt is made to write to a parameter, the message "HW lock state is ON" appears.

In addition, the key symbol appears in the measured value display. To unlock, toggle the write protection switch, which is located below the display module →  30.

9.2.2 Locking/unlocking software

If the device is locked via the software (device access code), the key symbol appears in the measured value display. If an attempt is made to write to a parameter, a prompt for the device access code appears. To unlock, enter the user-defined device access code →  36.

9.3 Commissioning without an operating menu

See Operating Instructions.

9.3.1 Level measuring mode

If no local display is connected, the following functions are possible via the three keys on the electronic insert or externally on the device:

- Position adjustment (zero point correction)
- Setting the lower and upper pressure value and assigning to the lower or upper level value
- To reset the device, see "Function of the operating elements" section, table .



- The pressure applied must be within the nominal pressure limits of the respective sensor module. See information on the nameplate.
- Operation must be unlocked, see "Unlocking/locking configuration" section → 37.
- The and keys have a function only in the case of the "Calibration mode wet" setting. The keys have no function in other settings.
- "Overview of level measurement" → 43
- The device is configured for the "Level" measuring mode as standard. You can change the measuring mode using the "Measuring mode" parameter, see "Commissioning with an operating menu" section. → 39

The following parameters are set to the following values at the factory: → 39.

- "Level selection": In pressure
- "Calibration Mode": Wet
- "Unit before lin." or "Linear range limit": %
- "Empty calib.": 0.0 (corresponds to 4 mA value)
- "Full calib.": 100.0 (corresponds to 20 mA value)
- "Empty pressure": 0.0
- "Full pressure": 100.0

These parameters can be changed only via the local display or remote control, such as FieldCare.

- "Calibration mode", "Level type", "Empty calib.", "Full calib.", "Empty pressure" and "Full pressure" are parameter names that are used for the local display or remote control, such as FieldCare.

WARNING

Changing the measuring mode affects the span (URV)

This situation can result in product overflow.

- ▶ If the measuring mode is changed, the setting for the span (URV) must be checked and readjusted if necessary.

Perform position adjustment (see information at the start of "Commissioning" section.)	
1	Device is installed. Process pressure is not present.
2	Press key for at least 3 s.
3	Does the LED on the electronic insert light up briefly?
4	Yes No
5	Applied pressure for position adjustment has been accepted. Applied pressure for position adjustment has not been accepted. Observe the input limits.





Set the lower pressure value.	
1	Desired pressure for lower pressure value ("Empty pressure") is present at the device.
2	Press key for at least 3 s.

Set the lower pressure value.	
3	Does the LED on the electronic insert light up briefly?
4	Yes No
5	Applied pressure was saved as the lower pressure value ('Empty pressure') and assigned to the lower level value ('Empty calib.'). The pressure present was not saved as the lower pressure value. Observe the input limits.

Set the upper pressure value.	
1	Desired pressure for upper pressure value ('Full pressure') is present at device.
2	 Press key for at least 3 s.
3	Does the LED on the electronic insert light up briefly?
4	Yes No
5	Applied pressure was saved as the upper pressure value ('Full pressure') and assigned to the upper level value ('Full calib.'). The pressure present was not saved as the upper pressure value. Observe the input limits.

9.4 Commissioning with an operating menu

Commissioning comprises the following steps:

- Function check →  37
- Selecting the language, measuring mode, high-pressure side, and pressure engineering unit →  40
- Position adjustment →  41
- Configuring measurement:
 - Pressure measurement →  46
 - Level measurement →  43

9.5 Language selection

9.5.1 Configure language via onsite display

Language (000)

Navigation

  Main menu → Language

Write permission

Operator/Service engineers/Expert

Description

Select the menu language for the local display.

Options	<ul style="list-style-type: none"> ▪ English ▪ Another language (as selected when ordering the device) ▪ Possibly a third language (language of the manufacturing plant)
----------------	---

Factory setting	English
------------------------	---------

9.5.2 Configuring language via operating tool (FieldCare)

See Operating Instructions.

9.6 Measuring mode selection

WARNING

Changing the measuring mode affects the span (URV)

This situation can result in product overflow.

- ▶ If the measuring mode is changed, the setting for the span (URV) must be checked in the "Setup" operating menu and readjusted if necessary.

Measuring mode (005)

Navigation	  Setup → Measuring mode
-------------------	--

Write permission	Operator/Service engineers/Expert
-------------------------	-----------------------------------

Description	Select the measuring mode. The operating menu is structured differently depending on the measuring mode selected.
--------------------	--

Options	<ul style="list-style-type: none"> ▪ Pressure ▪ Level
----------------	---

Factory setting	Level
------------------------	-------

9.7 Selecting the high-pressure side

9.7.1 Defining the high-pressure side

High press. side (183)

Navigation	  Setup → High press. side
-------------------	--

Write permission	Operator/Service engineers/Expert
Description	Define which sensor module corresponds to the high-pressure side.
Options	<ul style="list-style-type: none"> ▪ Sensor module HP ▪ Sensor module LP
Factory setting	Sensor module HP

9.8 Pressure unit selection

Press. eng. unit (125)

Navigation	 Setup → Press. eng. unit
Write permission	Operators/Service engineers/Expert
Description	Select the pressure engineering unit. If a new pressure engineering unit is selected, all pressure-specific parameters are converted and displayed with the new unit.
Options	<ul style="list-style-type: none"> ▪ mbar, bar ▪ mmH2O, mH2O ▪ in H2O, ftH2O ▪ Pa, kPa, MPa ▪ psi ▪ mmHg, inHg ▪ kgf/cm²
Factory setting	mbar, bar or psi depending on the sensor module nominal measuring range, or as per order specifications.

9.9 Pos. zero adjust



The pressure resulting from the orientation of the device can be corrected here.

Corrected press. (172)

Navigation	 Setup → Corrected press.
-------------------	--

Write permission	Operators/Service engineers/Expert
Description	Displays the measured pressure after the differential pressure buildup and position adjustment.
Note	If this value is not equal to "0", it can be corrected to "0" by the position adjustment.

Pos. zero adjust (007)

Navigation	  Setup → Pos. zero adjust
Write permission	Operators/Service engineers/Expert
Description	Position adjustment – the pressure difference between zero (set point) and the measured differential pressure need not be known.
Options	<ul style="list-style-type: none"> ■ Confirm ■ Cancel
Example	<ul style="list-style-type: none"> ■ Measured value = 2.2 mbar (0.033 psi) ■ You correct the measured value via the "Pos. zero adjust" parameter with the "Confirm" option. This means that you are assigning the value 0.0 to the pressure present. ■ Measured value (after pos. zero adjust) = 0.0 mbar ■ The current value is also corrected.
Factory setting	Cancel

9.10 Configuring level measurement

9.10.1 Information on level measurement



You have a choice of two methods for calculating the level: "In pressure" and "In height". The table in the "Overview of level measurement" section that follows provides you with an overview of these two measuring tasks.

- The limit values are not checked, i.e. the values entered must be appropriate for the sensor module and the measuring task for the device to be able to measure correctly.
- Customer-specific units are not possible.
- There is no unit conversion.
- The values entered for "Empty calib./Full calib.", "Empty pressure/Full pressure", "Empty height/Full height" and "Set LRV/Set URV" must be at least 1% apart. The value will be rejected, and a warning message displayed, if the values are too close together.

9.10.2 Overview of level measurement

Measuring task	Level selection	Measured variable options	Description	Measured value display
Calibration is performed by entering two pressure-level value pairs.	"In pressure"	Via the "Unit before lin. (025)" parameter : %, level, volume or mass units.	<ul style="list-style-type: none"> ■ Calibration with reference pressure (wet calibration) → 43 ■ Calibration without reference pressure (dry calibration), → 44 	The measured value display and the "Level before lin (019)" parameter show the measured value.
Calibration is performed by entering the density and two height-level value pairs.	"In height"		<ul style="list-style-type: none"> ■ Calibration with reference pressure (wet calibration) → 46 ■ Calibration without reference pressure (dry calibration), → 46 	

9.10.3 "In pressure" level selection Calibration with reference pressure (wet calibration)

See Operating Instructions.

9.10.4 "In pressure" level selection Calibration without reference pressure (dry calibration)

Example:

In this example, the volume in a tank should be measured in liters. The maximum volume of 1 000 l (264 gal) corresponds to a pressure of 450 mbar (6.53 psi).

The minimum volume of 0 liters corresponds to a pressure of 50 mbar (0.73 psi) since the device is mounted below the start of the level measuring range.

Prerequisite:

- The measured variable is in direct proportion to the pressure.
- This is a theoretical calibration i.e. the pressure and volume values for the lower and upper calibration point must be known.



- The values entered for "Empty calib./Full calib.", "Empty pressure/Full pressure" and "Set LRV/Set URV" must be at least 1% apart. The value will be rejected, and a warning message displayed, if the values are too close together. Further limit values are not checked, i.e. the values entered must be appropriate for the sensor module and the measuring task for the device to be able to measure correctly.
- Due to the orientation of the device, there may be pressure shifts in the measured value, i.e. when the vessel is empty or partly filled, the measured value is not zero. For information on how to perform position adjustment, see .

Description	
1	Select the "Level" measuring mode via the "Measuring mode (005)" parameter. Menu path: Setup → Measuring mode
2	Select a pressure engineering unit via the "Press eng. unit (125)" parameter, here "mbar" for example. Menu path: Setup → Press. eng. unit
3	Select the "In pressure" level mode via the "Level selection (024)" parameter. Menu path: Setup → Extended setup → Level → Level selection
4	Select a volume unit via the "Unit before lin. (025)" parameter, here "l" (liters) for example. Menu path: Setup → Extended setup → Level → Unit before lin.

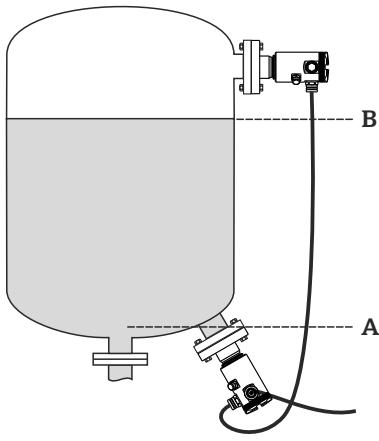

A See table, steps 6 and 7.

B See table, steps 8 and 9.

A0017661

Description	
5	Select the "Dry" option via the "Calibration mode (027)" parameter. Menu path: Setup → Extended setup → Level → Calibration mode
6	Enter the volume value for the lower calibration point via the "Empty calib. (028)" parameter, here 0 liters for example. Menu path: Setup → Extended setup → Level → Empty calib.
7	Enter the pressure value for the lower calibration point via the "Empty pressure (029)" parameter, here 50 mbar (0.73 psi) for example. Menu path: Setup → Extended setup → Level → Empty pressure
8	Enter the volume value for the upper calibration point via the "Full calib. (031)" parameter, here 1000 l (264 gal) for example. Menu path: Setup → Extended setup → Level → Full calib.
9	Enter the pressure value for the upper calibration point via the "Full pressure (032)" parameter, here 450 mbar (6.53 psi) for example. Menu path: Setup → Extended setup → Level → Full pressure
10	"Adjust density (034)" contains the factory setting 1.0, but this value can be changed if required. Menu path: Setup → Extended setup → Level → Adjust density
11	Set the volume value for the lower current value (4 mA) via the "Set LRV (166)" parameter (0 l). Menu path: Setup → Extended setup → Current output → Set LRV
12	Set the volume value for the upper current value (20 mA) via the "Set URV (167)" parameter (1000 l (264 gal)). Menu path: Setup → Extended setup → Current output → Set URV

A0034736

C See table, step 6.
 D See table, step 7.
 E See table, step 8.
 F See table, step 9.
 G See table, step 11
 H See table, step 12
 i Current value
 p Pressure
 v Volume

	Description
13	If the process uses a medium other than that on which the calibration was based, the new density must be specified in the "Process Density" parameter. Menu path: Setup → Extended setup → Current output → Process density.
14	Result: The measuring range is configured for 0 to 1 000 l (0 to 264 gal).



For this level mode, the measured variables %, level, volume and mass are available, see "Unit before lin. (025)".

9.10.5 "In height" level selection Calibration with reference pressure (wet calibration)

See "Operating Instructions".

9.10.6 "In height" level selection Calibration without reference pressure (dry calibration)

See "Operating Instructions".

9.10.7 Calibration with partially filled vessel (wet calibration)

See "Operating Instructions".

9.11 Linearization

See "Operating Instructions".

9.12 Configuring pressure measurement

See "Operating Instructions".



71376030

www.addresses.endress.com
