

Operating Instructions

Proline Promag W 400

HART

Electromagnetic flowmeter

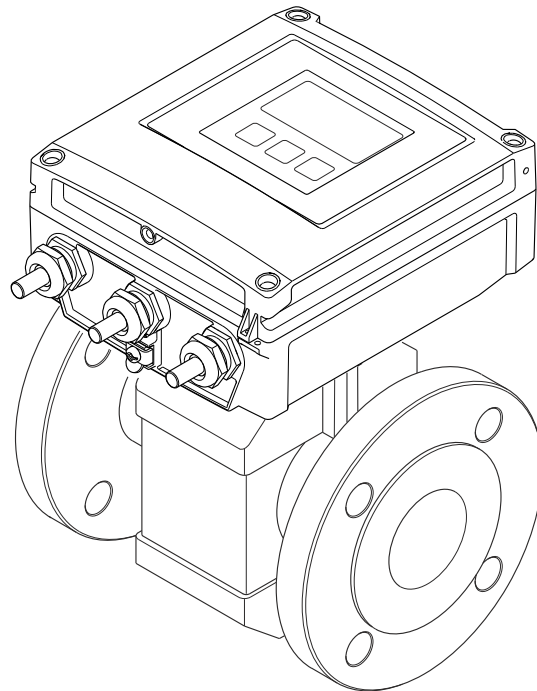

- Make sure the document is stored in a safe place such that it is always available when working on or with the device.
- To avoid danger to individuals or the facility, read the "Basic safety instructions" section carefully, as well as all other safety instructions in the document that are specific to working procedures.
- The manufacturer reserves the right to modify technical data without prior notice. Your Endress+Hauser Sales Center will supply you with current information and updates to these instructions.

Table of contents

1	About this document	6	6	Installation	21
1.1	Document function	6	6.1	Installation conditions	21
1.2	Symbols used	6	6.1.1	Mounting position	21
1.2.1	Safety symbols	6	6.1.2	Requirements from environment and process	24
1.2.2	Electrical symbols	6	6.1.3	Special mounting instructions	26
1.2.3	Communication symbols	6	6.2	Mounting the measuring device	27
1.2.4	Tool symbols	7	6.2.1	Required tools	27
1.2.5	Symbols for certain types of information	7	6.2.2	Preparing the measuring device	28
1.2.6	Symbols in graphics	7	6.2.3	Mounting the sensor	28
1.3	Documentation	8	6.2.4	Mounting the transmitter of the remote version	35
1.3.1	Standard documentation	8	6.2.5	Turning the transmitter housing	37
1.3.2	Supplementary device-dependent documentation	8	6.2.6	Turning the display module	39
1.4	Registered trademarks	9	6.3	Post-installation check	40
2	Basic safety instructions	10	7	Electrical connection	41
2.1	Requirements for the personnel	10	7.1	Connection conditions	41
2.2	Designated use	10	7.1.1	Requirements for connecting cable	41
2.3	Workplace safety	11	7.1.2	Required tools	43
2.4	Operational safety	11	7.1.3	Terminal assignment	43
2.5	Product safety	11	7.1.4	Shielding and grounding	44
2.6	IT security	12	7.1.5	Requirements for the supply unit	44
2.7	Device-specific IT security	12	7.1.6	Preparing the measuring device	44
2.7.1	Protecting access via hardware write protection	12	7.1.7	Preparing the connecting cable for the remote version	45
2.7.2	Protecting access via a password	12	7.2	Connecting the measuring device	46
2.7.3	Access via fieldbus	13	7.2.1	Connecting the remote version	46
2.7.4	Access via Web server	13	7.2.2	Connecting the transmitter	48
3	Product description	14	7.2.3	Ensure potential equalization	49
3.1	Product design	14	7.3	Special connection instructions	52
4	Incoming acceptance and product identification	15	7.3.1	Connection examples	52
4.1	Incoming acceptance	15	7.4	Ensuring the degree of protection	54
4.2	Product identification	15	7.4.1	Degree of protection IP66/67, Type 4X enclosure	54
4.2.1	Transmitter nameplate	16	7.4.2	Degree of protection IP68, Type 6P enclosure, with "Cust-potted" option	54
4.2.2	Sensor nameplate	17	7.5	Post-connection check	54
4.2.3	Symbols on measuring device	18	8	Operation options	56
5	Storage and transport	19	8.1	Overview of operation options	56
5.1	Storage conditions	19	8.2	Structure and function of the operating menu	57
5.2	Transporting the product	19	8.2.1	Structure of the operating menu	57
5.2.1	Measuring devices without lifting lugs	19	8.2.2	Operating philosophy	58
5.2.2	Measuring devices with lifting lugs	20	8.3	Access to the operating menu via the local display	59
5.2.3	Transporting with a fork lift	20	8.3.1	Operational display	59
5.3	Packaging disposal	20	8.3.2	Navigation view	61
			8.3.3	Editing view	63
			8.3.4	Operating elements	64
			8.3.5	Opening the context menu	65
			8.3.6	Navigating and selecting from list	67
			8.3.7	Calling the parameter directly	67

8.3.8	Calling up help text	68	10.5.6	Using parameters for device administration	112
8.3.9	Changing the parameters	69	10.6	Simulation	114
8.3.10	User roles and related access authorization	70	10.7	Protecting settings from unauthorized access	117
8.3.11	Disabling write protection via access code	70	10.7.1	Write protection via access code . . .	117
8.3.12	Enabling and disabling the keypad lock	71	10.7.2	Write protection via write protection switch	118
8.4	Access to the operating menu via the Web browser	71	11	Operation	120
8.4.1	Function range	71	11.1	Reading the device locking status	120
8.4.2	Prerequisites	72	11.2	Adjusting the operating language	120
8.4.3	Establishing a connection	73	11.3	Configuring the display	120
8.4.4	Logging on	75	11.4	Reading measured values	120
8.4.5	User interface	76	11.4.1	Process variables	121
8.4.6	Disabling the Web server	77	11.4.2	"Totalizer" submenu	122
8.4.7	Logging out	77	11.4.3	Input values	122
8.5	Access to the operating menu via the operating tool	77	11.4.4	Output values	123
8.5.1	Connecting the operating tool	78	11.5	Adapting the measuring device to the process conditions	123
8.5.2	Field Xpert SFX350, SFX370	79	11.6	Performing a totalizer reset	124
8.5.3	FieldCare	80	11.6.1	Function scope of the "Control Totalizer" parameter	124
8.5.4	DeviceCare	81	11.6.2	Function scope of the "Reset all totalizers" parameter	125
8.5.5	AMS Device Manager	81	11.7	Showing data logging	125
8.5.6	SIMATIC PDM	82	12	Diagnostics and troubleshooting ..	128
8.5.7	Field Communicator 475	82	12.1	General troubleshooting	128
9	System integration	83	12.2	Diagnostic information via light emitting diodes	130
9.1	Overview of device description files	83	12.2.1	Transmitter	130
9.1.1	Current version data for the device . . .	83	12.3	Diagnostic information on local display	131
9.1.2	Operating tools	83	12.3.1	Diagnostic message	131
9.2	Measured variables via HART protocol	83	12.3.2	Calling up remedial measures	133
9.3	Other settings	85	12.4	Diagnostic information in the Web browser .	133
10	Commissioning	87	12.4.1	Diagnostic options	133
10.1	Function check	87	12.4.2	Calling up remedy information	134
10.2	Switching on the measuring device	87	12.5	Diagnostic information in DeviceCare or FieldCare	135
10.3	Setting the operating language	87	12.5.1	Diagnostic options	135
10.4	Configuring the measuring device	87	12.5.2	Calling up remedy information	136
10.4.1	Defining the tag name	88	12.6	Adapting the diagnostic information	136
10.4.2	Setting the system units	89	12.6.1	Adapting the diagnostic behavior . . .	136
10.4.3	Configuring the status input	90	12.6.2	Adapting the status signal	136
10.4.4	Configuring the current output	92	12.7	Overview of diagnostic information	137
10.4.5	Configuring the pulse/frequency/ switch output	93	12.8	Pending diagnostic events	140
10.4.6	Configuring the local display	99	12.9	Diagnostic list	141
10.4.7	Configuring the output conditioning	100	12.10	Event logbook	141
10.4.8	Configuring the low flow cut off	102	12.10.1	Reading out the event logbook	141
10.4.9	Configuring empty pipe detection	104	12.10.2	Filtering the event logbook	142
10.5	Advanced settings	105	12.10.3	Overview of information events	142
10.5.1	Carrying out a sensor adjustment . . .	106	12.11	Resetting the measuring device	144
10.5.2	Configuring the totalizer	106	12.11.1	Function scope of the "Device reset" parameter	144
10.5.3	Carrying out additional display configurations	108	12.12	Device information	144
10.5.4	Performing electrode cleaning	111	12.13	Firmware history	146
10.5.5	WLAN configuration	111			

13	Maintenance	147
13.1	Maintenance tasks	147
13.1.1	Exterior cleaning	147
13.1.2	Interior cleaning	147
13.1.3	Replacing seals	147
13.2	Measuring and test equipment	147
13.3	Endress+Hauser services	147
14	Repairs	148
14.1	General notes	148
14.1.1	Repair and conversion concept	148
14.1.2	Notes for repair and conversion	148
14.2	Spare parts	148
14.3	Endress+Hauser services	148
14.4	Return	148
14.5	Disposal	149
14.5.1	Removing the measuring device	149
14.5.2	Disposing of the measuring device ..	149
15	Accessories	150
15.1	Device-specific accessories	150
15.1.1	For the transmitter	150
15.1.2	For the sensor	150
15.2	Communication-specific accessories	150
15.3	Service-specific accessories	151
15.4	System components	152
16	Technical data	153
16.1	Application	153
16.2	Function and system design	153
16.3	Input	153
16.4	Output	157
16.5	Power supply	160
16.6	Performance characteristics	161
16.7	Installation	163
16.8	Environment	164
16.9	Process	165
16.10	Mechanical construction	167
16.11	Operability	191
16.12	Certificates and approvals	194
16.13	Application packages	196
16.14	Accessories	196
16.15	Supplementary documentation	197
Index	198	





1 About this document

1.1 Document function





These Operating Instructions contain all the information that is required in various phases of the life cycle of the device: from product identification, incoming acceptance and storage, to mounting, connection, operation and commissioning through to troubleshooting, maintenance and disposal.

1.2 Symbols used



1.2.1 Safety symbols



Symbol	Meaning
	DANGER! This symbol alerts you to a dangerous situation. Failure to avoid this situation will result in serious or fatal injury.
	WARNING! This symbol alerts you to a dangerous situation. Failure to avoid this situation can result in serious or fatal injury.
	CAUTION! This symbol alerts you to a dangerous situation. Failure to avoid this situation can result in minor or medium injury.
	NOTE! This symbol contains information on procedures and other facts which do not result in personal injury.

1.2.2 Electrical symbols



Symbol	Meaning
	Direct current
	Alternating current
	Direct current and alternating current
	Ground connection A grounded terminal which, as far as the operator is concerned, is grounded via a grounding system.
	Protective Earth (PE) A terminal which must be connected to ground prior to establishing any other connections. The ground terminals are situated inside and outside the device: <ul style="list-style-type: none"> ▪ Inner ground terminal: Connects the protective earth to the mains supply. ▪ Outer ground terminal: Connects the device to the plant grounding system.

1.2.3 Communication symbols













Symbol	Meaning
	Wireless Local Area Network (WLAN) Communication via a wireless, local network.
	Bluetooth Wireless data transmission between devices over a short distance.

Symbol	Meaning
	LED Light emitting diode is off.
	LED Light emitting diode is on.
	LED Light emitting diode is flashing.

1.2.4 Tool symbols



Symbol	Meaning
	Torx screwdriver
	Phillips head screwdriver
	Open-ended wrench

1.2.5 Symbols for certain types of information

Symbol	Meaning
	Permitted Procedures, processes or actions that are permitted.
	Preferred Procedures, processes or actions that are preferred.
	Forbidden Procedures, processes or actions that are forbidden.
	Tip Indicates additional information.
	Reference to documentation.
	Reference to page.
	Reference to graphic.
	Notice or individual step to be observed.
	Series of steps.
	Result of a step.
	Help in the event of a problem.
	Visual inspection.

1.2.6 Symbols in graphics



Symbol	Meaning
1, 2, 3, ...	Item numbers
	Series of steps
A, B, C, ...	Views
A-A, B-B, C-C, ...	Sections

Symbol	Meaning
	Hazardous area
	Safe area (non-hazardous area)
	Flow direction

1.3 Documentation

 For an overview of the scope of the associated Technical Documentation, refer to the following:

- The *W@M Device Viewer* : Enter the serial number from the nameplate (www.endress.com/deviceviewer)
- The *Endress+Hauser Operations App*: Enter the serial number from the nameplate or scan the 2-D matrix code (QR code) on the nameplate.

 For a detailed list of the individual documents along with the documentation code
→  197

1.3.1 Standard documentation

Document type	Purpose and content of the document
Technical Information	Planning aid for your device The document contains all the technical data on the device and provides an overview of the accessories and other products that can be ordered for the device.
Sensor Brief Operating Instructions	Guides you quickly to the 1st measured value - Part 1 The Sensor Brief Operating Instructions are aimed at specialists with responsibility for installing the measuring device. <ul style="list-style-type: none"> ▪ Incoming acceptance and product identification ▪ Storage and transport ▪ Installation
Transmitter Brief Operating Instructions	Guides you quickly to the 1st measured value - Part 2 The Transmitter Brief Operating Instructions are aimed at specialists with responsibility for commissioning, configuring and parameterizing the measuring device (until the first measured value). <ul style="list-style-type: none"> ▪ Product description ▪ Installation ▪ Electrical connection ▪ Operation options ▪ System integration ▪ Commissioning ▪ Diagnostic information
Description of Device Parameters	Reference for your parameters The document provides a detailed explanation of each individual parameter in the Expert operating menu. The description is aimed at those who work with the device over the entire life cycle and perform specific configurations.

1.3.2 Supplementary device-dependent documentation

Additional documents are supplied depending on the device version ordered: Always comply strictly with the instructions in the supplementary documentation. The supplementary documentation is an integral part of the device documentation.

1.4 Registered trademarks

HART®

Registered trademark of the FieldComm Group, Austin, Texas, USA

Microsoft®

Registered trademark of the Microsoft Corporation, Redmond, Washington, USA

2 Basic safety instructions

2.1 Requirements for the personnel

The personnel for installation, commissioning, diagnostics and maintenance must fulfill the following requirements:

- ▶ Trained, qualified specialists must have a relevant qualification for this specific function and task.
- ▶ Are authorized by the plant owner/operator.
- ▶ Are familiar with federal/national regulations.
- ▶ Before starting work, read and understand the instructions in the manual and supplementary documentation as well as the certificates (depending on the application).
- ▶ Follow instructions and comply with basic conditions.

The operating personnel must fulfill the following requirements:

- ▶ Are instructed and authorized according to the requirements of the task by the facility's owner-operator.
- ▶ Follow the instructions in this manual.

2.2 Designated use

Application and media

The measuring device described in these Brief Operating Instructions is intended only for flow measurement of liquids with a minimum conductivity of 5 $\mu\text{S}/\text{cm}$.

Depending on the version ordered, the measuring device can also measure potentially explosive, flammable, poisonous and oxidizing media.

Measuring devices for use in hazardous areas, in hygienic applications or where there is an increased risk due to process pressure, are labeled accordingly on the nameplate.

To ensure that the measuring device remains in proper condition for the operation time:

- ▶ Keep within the specified pressure and temperature range.
- ▶ Only use the measuring device in full compliance with the data on the nameplate and the general conditions listed in the Operating Instructions and supplementary documentation.
- ▶ Based on the nameplate, check whether the ordered device is permitted for the intended use in the hazardous area (e.g. explosion protection, pressure vessel safety).
- ▶ Use the measuring device only for media to which the process-wetted materials are sufficiently resistant.
- ▶ If the measuring device is not operated at atmospheric temperature, compliance with the relevant basic conditions specified in the associated device documentation is absolutely essential: "Documentation" section →  8.
- ▶ Protect the measuring device permanently against corrosion from environmental influences.

 The measuring device is optionally tested in accordance with OIML R49: 2006 and has an EC type-examination certificate according to Measuring Instruments Directive 2004/22/EC (MID) for service subject to legal metrological control ("custody transfer") for cold water (Annex MI-001).

The permitted fluid temperature in these applications is 0 to +50 °C (+32 to +122 °F).

Incorrect use

Non-designated use can compromise safety. The manufacturer is not liable for damage caused by improper or non-designated use.

⚠ WARNING**Danger of breakage due to corrosive or abrasive fluids!**

- ▶ Verify the compatibility of the process fluid with the sensor material.
- ▶ Ensure the resistance of all fluid-wetted materials in the process.
- ▶ Keep within the specified pressure and temperature range.

NOTICE**Verification for borderline cases:**

- ▶ For special fluids and fluids for cleaning, Endress+Hauser is glad to provide assistance in verifying the corrosion resistance of fluid-wetted materials, but does not accept any warranty or liability as minute changes in the temperature, concentration or level of contamination in the process can alter the corrosion resistance properties.

Residual risks**⚠ WARNING****The electronics and the medium may cause the surfaces to heat up. This presents a burn hazard!**

- ▶ For elevated fluid temperatures, ensure protection against contact to prevent burns.

2.3 Workplace safety

For work on and with the device:

- ▶ Wear the required personal protective equipment according to federal/national regulations.

For welding work on the piping:

- ▶ Do not ground the welding unit via the measuring device.

If working on and with the device with wet hands:

- ▶ Due to the increased risk of electric shock, gloves must be worn.

2.4 Operational safety

Risk of injury.

- ▶ Operate the device in proper technical condition and fail-safe condition only.
- ▶ The operator is responsible for interference-free operation of the device.

Conversions to the device

Unauthorized modifications to the device are not permitted and can lead to unforeseeable dangers.

- ▶ If, despite this, modifications are required, consult with Endress+Hauser.

Repair

To ensure continued operational safety and reliability,

- ▶ Carry out repairs on the device only if they are expressly permitted.
- ▶ Observe federal/national regulations pertaining to repair of an electrical device.
- ▶ Use original spare parts and accessories from Endress+Hauser only.

2.5 Product safety

This measuring device is designed in accordance with good engineering practice to meet state-of-the-art safety requirements, has been tested, and left the factory in a condition in which it is safe to operate.

It meets general safety standards and legal requirements. It also complies with the EU directives listed in the device-specific EU Declaration of Conformity. Endress+Hauser confirms this by affixing the CE mark to the device.

2.6 IT security

We only provide a warranty if the device is installed and used as described in the Operating Instructions. The device is equipped with security mechanisms to protect it against any inadvertent changes to the device settings.

IT security measures in line with operators' security standards and designed to provide additional protection for the device and device data transfer must be implemented by the operators themselves.

2.7 Device-specific IT security

The device offers a range of specific functions to support protective measures on the operator's side. These functions can be configured by the user and guarantee greater in-operation safety if used correctly. An overview of the most important functions is provided in the following section.

2.7.1 Protecting access via hardware write protection

Write access to the device parameters via the local display or operating tool (e.g. FieldCare, DeviceCare) can be disabled via a write protection switch (DIP switch on the motherboard). When hardware write protection is enabled, only read access to the parameters is possible.

2.7.2 Protecting access via a password

Different passwords are available to protect write access to the device parameters or access to the device via the WLAN interface.

- **User-specific access code**
Protect write access to the device parameters via the local display, Web browser or operating tool (e.g. FieldCare, DeviceCare). Access authorization is clearly regulated through the use of a user-specific access code.
- **WLAN passphrase**
The network key protects a connection between an operating unit (e.g. notebook or tablet) and the device via the WLAN interface which can be ordered as an option.

User-specific access code

Write access to the device parameters via the local display or operating tool (e.g. FieldCare, DeviceCare) can be protected by the modifiable, user-specific access code (→  117).

When the device is delivered, the device does not have an access code and is equivalent to 0000 (open).

WLAN passphrase

A connection between an operating unit (e.g. notebook or tablet) and the device via the WLAN interface (→  78) which can be ordered as an option is protected by the network key. The WLAN authentication of the network key complies with the IEEE 802.11 standard.

When the device is delivered, the network key is pre-defined depending on the device. It can be changed via the **WLAN settings** submenu in the **WLAN passphrase** parameter (→  112).

General notes on the use of passwords

- The access code and network key supplied with the device should be changed during commissioning.
- Follow the general rules for generating a secure password when defining and managing the access code or network key.
- The user is responsible for the management and careful handling of the access code and network key.
- For information on configuring the access code or on what to do if you lose the password, see the "Write protection via access code" section →  117

2.7.3 Access via fieldbus

When communicating via fieldbus, access to the device parameters can be restricted to "Read only" access. The option can be changed in the **Fieldbus writing access** parameter.

This does not affect cyclic measured value transmission to the higher-order system, which is always guaranteed.



For detailed information, see the "Description of Device Parameters" document pertaining to the device →  197

2.7.4 Access via Web server

The device can be operated and configured via a Web browser with the integrated Web server (→  71). The connection is via the service interface (CDI-RJ45) or the WLAN interface.

The Web server is enabled when the device is delivered. The Web server can be disabled if necessary (e.g. after commissioning) via the **Web server functionality** parameter.

The device and status information can be hidden on the login page. This prevents unauthorized access to the information.



For detailed information, see the "Description of Device Parameters" document pertaining to the device →  197

3 Product description

The device consists of a transmitter and a sensor.

Two device versions are available:

- Compact version – transmitter and sensor form a mechanical unit.
- Remote version - transmitter and sensor are mounted in separate locations.

3.1 Product design

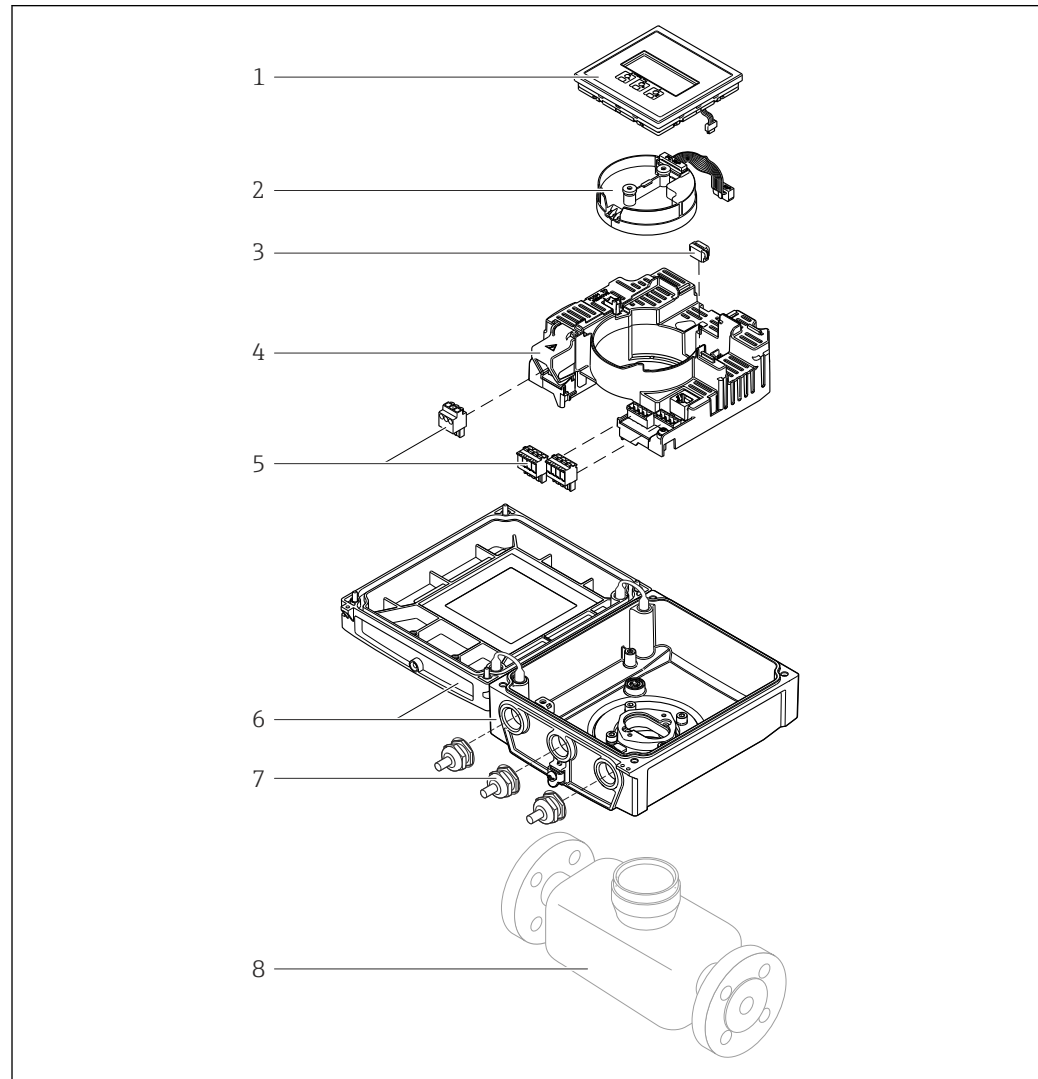

A001721B

1 Important components of the compact version

- 1 Display module
- 2 Smart sensor electronics module
- 3 HistoROM DAT (plug-in memory)
- 4 Main electronics module
- 5 Terminals (screw terminals, some available as plug-in terminals) or fieldbus connectors
- 6 Transmitter housing, compact version
- 7 Cable glands
- 8 Sensor, compact version

4 Incoming acceptance and product identification

4.1 Incoming acceptance

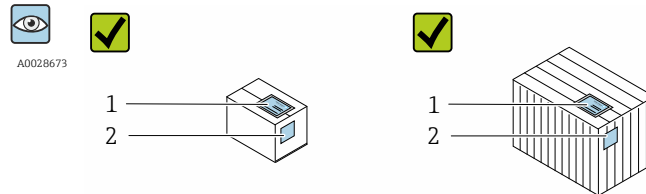

Are the order codes on the delivery note (1) and the product sticker (2) identical?

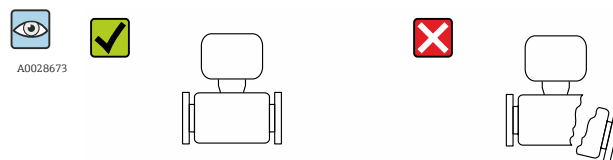
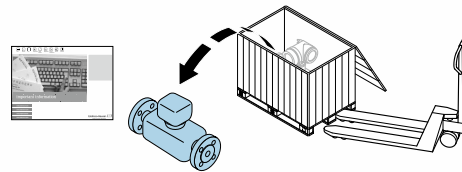

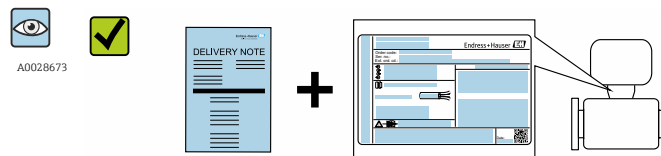

Are the goods undamaged?

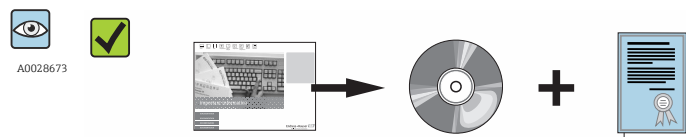

Do the nameplate data match the ordering information on the delivery note?



Is the CD-ROM with the Technical Documentation (depends on device version) and documents present?



-  If one of the conditions is not satisfied, contact your Endress+Hauser Sales Center.
- Depending on the device version, the CD-ROM might not be part of the delivery! The Technical Documentation is available via the Internet or via the *Endress+Hauser Operations App*, see the "Product identification" section →  16.

4.2 Product identification

The following options are available for identification of the measuring device:

- Nameplate specifications
- Order code with breakdown of the device features on the delivery note
- Enter serial numbers from nameplates in *W@M Device Viewer* (www.endress.com/deviceviewer): All information about the measuring device is displayed.
- Enter the serial number from the nameplates into the *Endress+Hauser Operations App* or scan the 2-D matrix code (QR code) on the nameplate with the *Endress+Hauser Operations App*: all the information for the measuring device is displayed.

For an overview of the scope of the associated Technical Documentation, refer to the following:

- The chapters "Additional standard documentation on the device" →  8 and "Supplementary device-dependent documentation" →  8
- The *W@M Device Viewer*: Enter the serial number from the nameplate (www.endress.com/deviceviewer)
- The *Endress+Hauser Operations App*: Enter the serial number from the nameplate or scan the 2-D matrix code (QR code) on the nameplate.

4.2.1 Transmitter nameplate

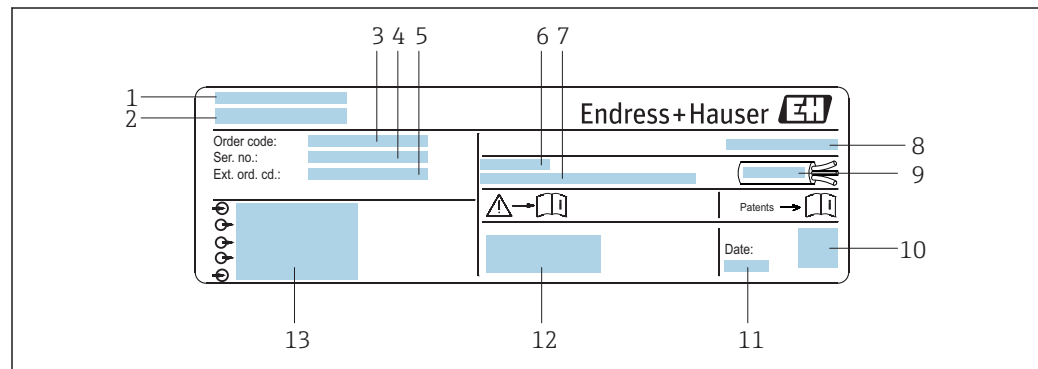

A0017346

 2 Example of a transmitter nameplate

- 1 Manufacturing location
- 2 Name of the transmitter
- 3 Order code
- 4 Serial number (ser. no.)
- 5 Extended order code (Ext. ord. cd.)
- 6 Permitted ambient temperature (T_a)
- 7 Firmware version (FW) and device revision (Dev.Rev.) from the factory
- 8 Degree of protection
- 9 Permitted temperature range for cable
- 10 2-D matrix code
- 11 Manufacturing date: year-month
- 12 CE mark, C-Tick
- 13 Electrical connection data, e.g. available inputs and outputs, supply voltage

4.2.2 Sensor nameplate

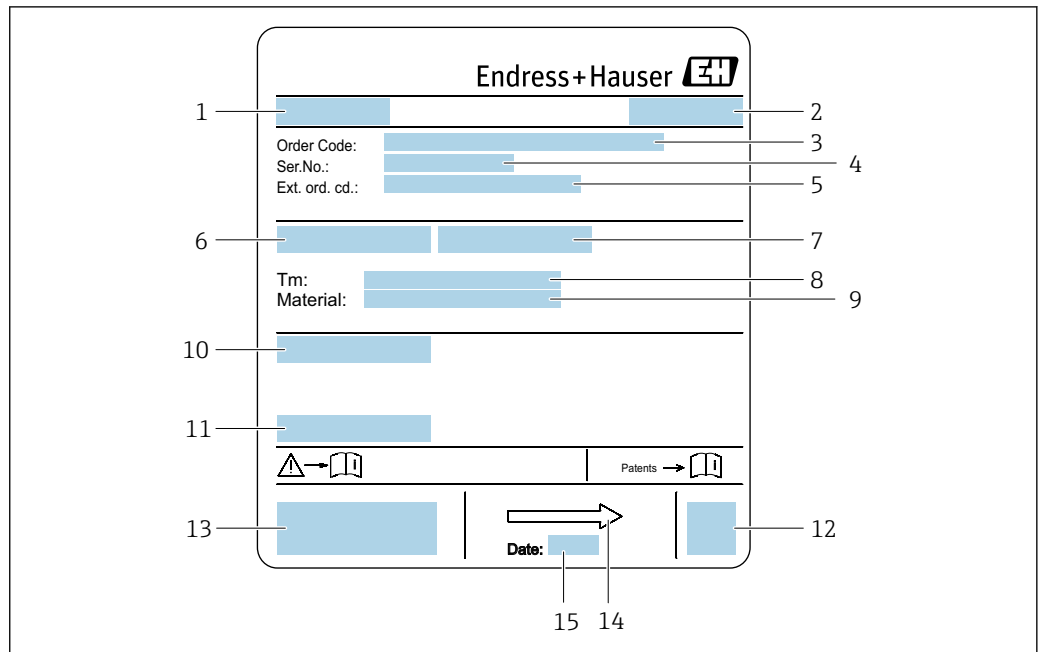

A0032085

3 Example of sensor nameplate

- 1 Name of the sensor
- 2 Manufacturing location
- 3 Order code
- 4 Serial number (ser. no.)
- 5 Extended order code (Ext. ord. cd.)
- 6 Nominal diameter of sensor
- 7 Test pressure of the sensor
- 8 Medium temperature range
- 9 Material of lining and electrodes
- 10 Degree of protection: e.g. IP, NEMA
- 11 Permitted ambient temperature (T_a)
- 12 2-D matrix code
- 13 CE mark, C-Tick
- 14 Flow direction
- 15 Manufacturing date: year-month



Order code

The measuring device is reordered using the order code.

Extended order code

- The device type (product root) and basic specifications (mandatory features) are always listed.
- Of the optional specifications (optional features), only the safety and approval-related specifications are listed (e.g. LA). If other optional specifications are also ordered, these are indicated collectively using the # placeholder symbol (e.g. #LA#).
- If the ordered optional specifications do not include any safety and approval-related specifications, they are indicated by the + placeholder symbol (e.g. XXXXXX-ABCDE+).

4.2.3 Symbols on measuring device

Symbol	Meaning
	WARNING! This symbol alerts you to a dangerous situation. Failure to avoid this situation can result in serious or fatal injury.
	Reference to documentation Refers to the corresponding device documentation.
	Protective ground connection A terminal which must be connected to ground prior to establishing any other connections.

5 Storage and transport

5.1 Storage conditions

Observe the following notes for storage:

- ▶ Store in the original packaging to ensure protection from shock.
- ▶ Do not remove protective covers or protective caps installed on process connections. They prevent mechanical damage to the sealing surfaces and contamination in the measuring tube.
- ▶ Protect from direct sunlight to avoid unacceptably high surface temperatures.
- ▶ Select a storage location where moisture cannot collect in the measuring device as fungus and bacteria infestation can damage the lining.
- ▶ Store in a dry and dust-free place.
- ▶ Do not store outdoors.

Storage temperature →  164

5.2 Transporting the product

Transport the measuring device to the measuring point in the original packaging.

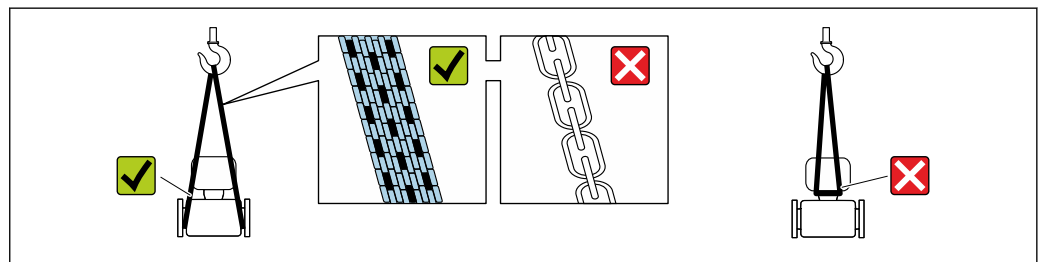

A0029252

-  Do not remove protective covers or caps installed on process connections. They prevent mechanical damage to the sealing surfaces and contamination in the measuring tube.

5.2.1 Measuring devices without lifting lugs

WARNING

Center of gravity of the measuring device is higher than the suspension points of the webbing slings.

Risk of injury if the measuring device slips.

- ▶ Secure the measuring device against slipping or turning.
- ▶ Observe the weight specified on the packaging (stick-on label).

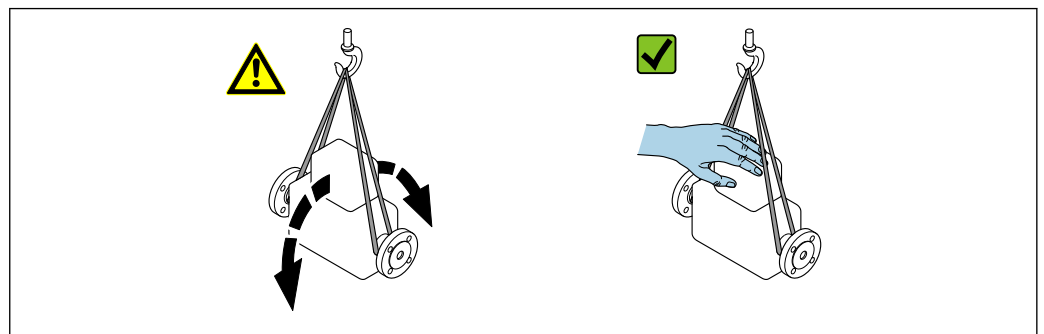

A0029214

5.2.2 Measuring devices with lifting lugs

⚠ CAUTION

Special transportation instructions for devices with lifting lugs

- ▶ Only use the lifting lugs fitted on the device or flanges to transport the device.
- ▶ The device must always be secured at two lifting lugs at least.

5.2.3 Transporting with a fork lift

If transporting in wood crates, the floor structure enables the crates to be lifted lengthwise or at both sides using a forklift.

⚠ CAUTION

Risk of damaging the magnetic coil

- ▶ If transporting by forklift, do not lift the sensor by the metal casing.
- ▶ This would buckle the casing and damage the internal magnetic coils.

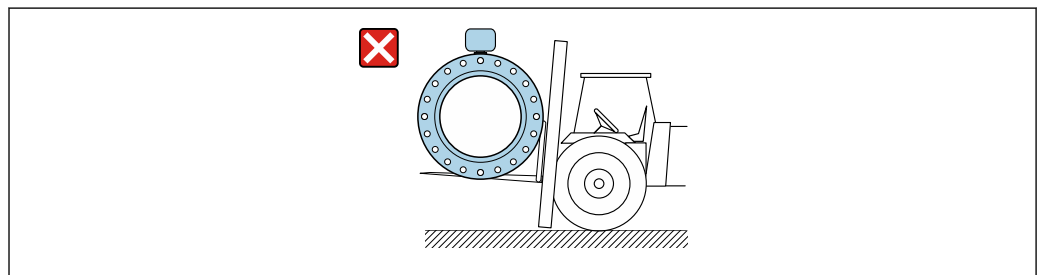

A0029319

5.3 Packaging disposal

All packaging materials are environmentally friendly and 100% recyclable:

- Measuring device secondary packaging: polymer stretch film that conforms to EC Directive 2002/95/EC (RoHS).
- Packaging:
 - Wood crate, treated in accordance with ISPM 15 standard, which is confirmed by the affixed IPPC logo.
 - or
 - Carton in accordance with European Packaging Directive 94/62EC; recyclability is confirmed by the affixed RESY symbol.
- Seaworthy packaging (optional): Wood crate, treated in accordance with ISPM 15 standard, which is confirmed by the affixed IPPC logo.
- Carrying and mounting hardware:
 - Disposable plastic pallet
 - Plastic straps
 - Plastic adhesive strips
- Dunnage: Paper cushion

6 Installation

6.1 Installation conditions

6.1.1 Mounting position

Mounting location

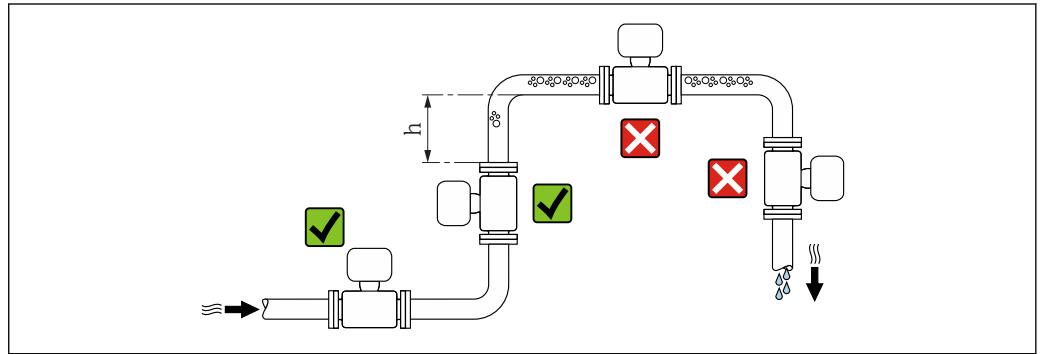

A0029343

Preferably install the sensor in an ascending pipe, and ensure a sufficient distance to the next pipe elbow: $h \geq 2 \times DN$

i Not necessary in the case of order code for "Design", option C "Insertion length short ISO/DVGW to DN300, without inlet/outlet runs, constricted meas.tube"

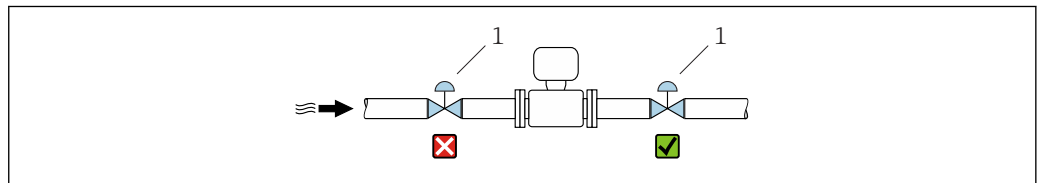

A0033017

4 Installation of the sensor after a control valve is not recommended

1 Control valve

Installation in down pipes

Install a siphon with a vent valve downstream of the sensor in down pipes whose length $h \geq 5 \text{ m}$ (16.4 ft). This precaution is to avoid low pressure and the consequent risk of damage to the measuring tube. This measure also prevents the system losing prime.

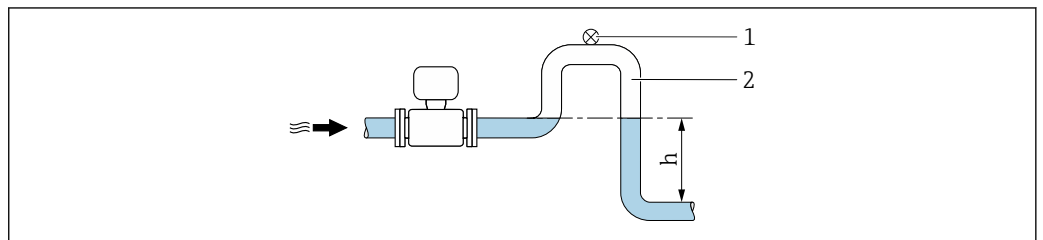

A0028981

5 Installation in a down pipe

1 Vent valve

2 Pipe siphon

h Length of down pipe

Installation in partially filled pipes

A partially filled pipe with a gradient necessitates a drain-type configuration.

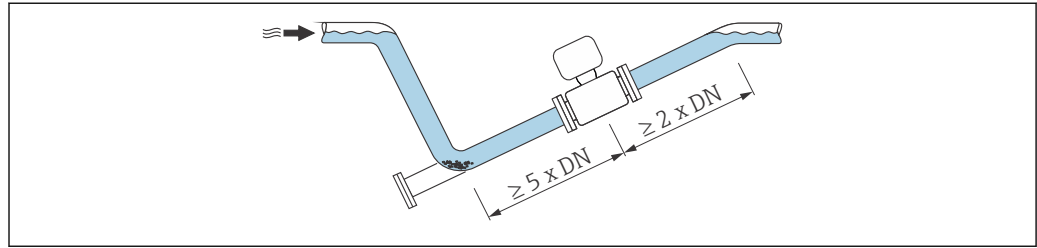

A0029257

For heavy sensors DN ≥ 350 (14")

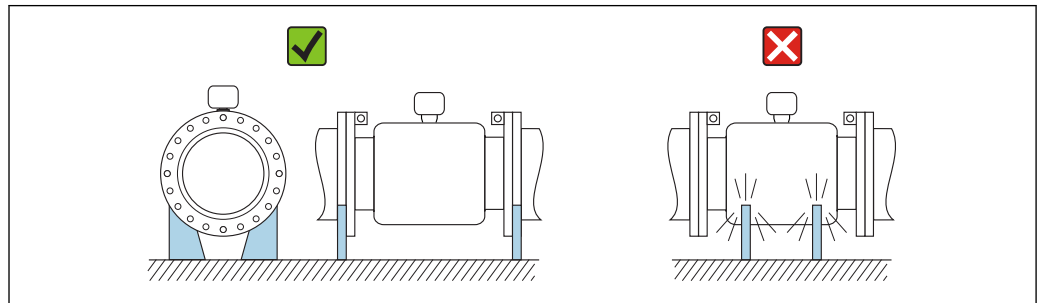

A0016276

Orientation

The direction of the arrow on the sensor nameplate helps you to install the sensor according to the flow direction (direction of medium flow through the piping).

Orientation		Recommendation	
A	Vertical orientation	 A0015591	✓✓
B	Horizontal orientation, transmitter at top	 A0015589	✓✓ ¹⁾
C	Horizontal orientation, transmitter at bottom	 A0015590	✓✓ ^{2) 3)}
D	Horizontal orientation, transmitter at side	 A0015592	✗

- 1) Applications with low process temperatures may decrease the ambient temperature. To maintain the minimum ambient temperature for the transmitter, this orientation is recommended.
- 2) Applications with high process temperatures may increase the ambient temperature. To maintain the maximum ambient temperature for the transmitter, this orientation is recommended.
- 3) To prevent the electronics module from overheating in the case of a sharp rise in temperature (e.g. CIP- or SIP processes), install the device with the transmitter component pointing downwards.

Horizontal

- Ideally, the measuring electrode plane should be horizontal. This prevents brief insulation of the two measuring electrodes by entrained air bubbles.
- Empty pipe detection only works if the transmitter housing is pointing upwards as otherwise there is no guarantee that the empty pipe detection function will actually respond to a partially filled or empty measuring tube.

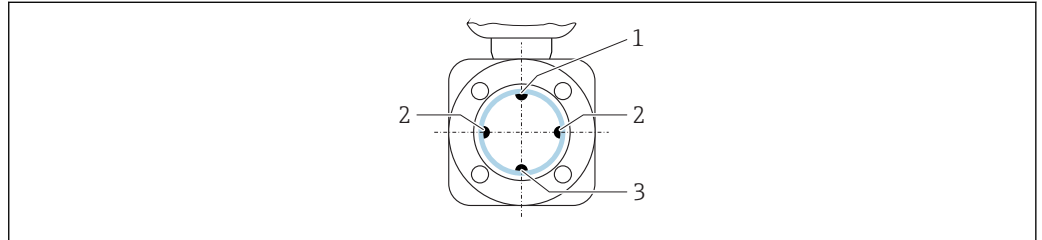

A0029344

- 1 EPD electrode for empty pipe detection
- 2 Measuring electrodes for signal detection
- 3 Reference electrode for potential equalization

Inlet and outlet runs

If possible, install the sensor upstream from fittings such as valves, T-pieces or elbows. Observe the following inlet and outlet runs to comply with accuracy specifications:

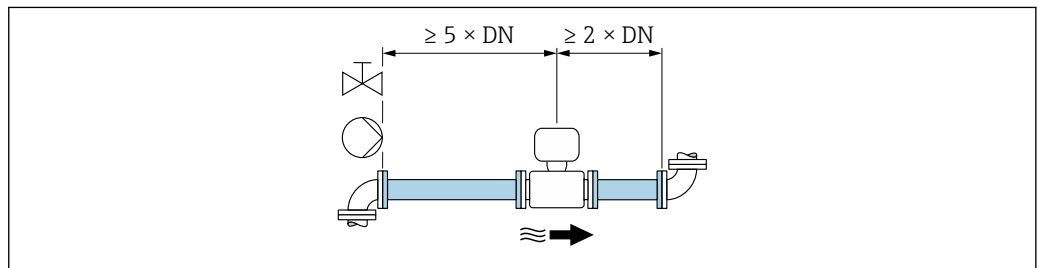

A0028997

- 6 Order code for "Design", option A "Insertion length short, ISO/DVGW until DN400, DN450-2000 1:1" and order code for "Design", option B "Insertion length long, ISO/DVGW until DN400, DN450-2000 1:1.3"

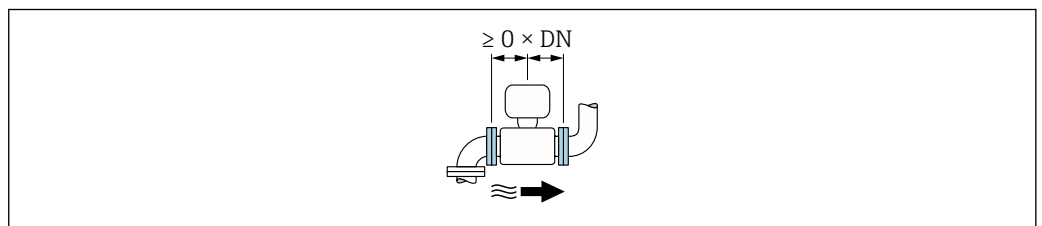

A0032859

- 7 Order code for "Design", option C "Insertion length short ISO/DVGW until DN300, w/o inlet and outlet runs, constricted meas.tube"

i To keep within the in-service maximum permissible errors for custody transfer no additional requirements apply with regard to the graphic illustrated above.

Installation dimensions

i For the dimensions and installation lengths of the device, see the "Technical Information" document, "Mechanical construction" section.



6.1.2 Requirements from environment and process

Ambient temperature range

Transmitter	-40 to +60 °C (-40 to +140 °F)
Local display	-20 to +60 °C (-4 to +140 °F), the readability of the display may be impaired at temperatures outside the temperature range.
Sensor	<ul style="list-style-type: none"> ▪ Process connection material, carbon steel: -10 to +60 °C (+14 to +140 °F) ▪ Process connection material, stainless steel: -40 to +60 °C (-40 to +140 °F)
Liner	Do not exceed or fall below the permitted temperature range of the liner .

If operating outdoors:

- Install the measuring device in a shady location.
- Avoid direct sunlight, particularly in warm climatic regions.
- Avoid direct exposure to weather conditions.
- If the compact version of the device is insulated at low temperatures, the insulation must also include the device neck.
- Protect the display against impact.
- Protect the display from abrasion by sand in desert areas.

 You can order a display guard from Endress+Hauser : →  150

Temperature tables

 Observe the interdependencies between the permitted ambient and fluid temperatures when operating the device in hazardous areas.

 For detailed information on the temperature tables, see the separate document entitled "Safety Instructions" (XA) for the device.

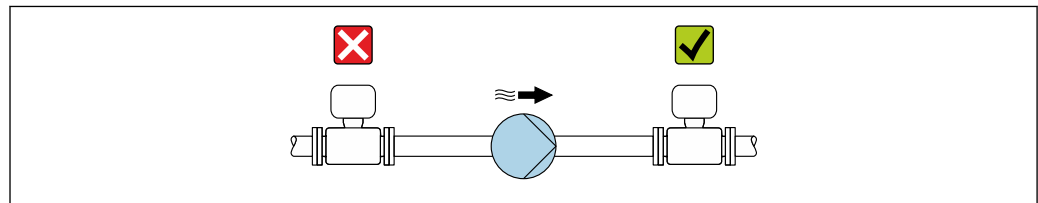

System pressure



A0028771

Never install the sensor on the pump suction side in order to avoid the risk of low pressure, and thus damage to the liner.

 Furthermore, install pulse dampers if reciprocating, diaphragm or peristaltic pumps are used.

- Information on the liner's resistance to partial vacuum →  165
- Information on the shock resistance of the measuring system →  165
- Information on the vibration resistance of the measuring system →  164

Vibrations

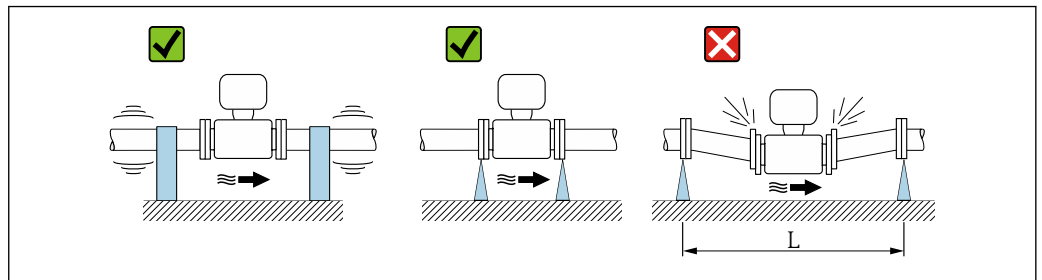

8 Measures to avoid device vibrations ($L > 10\text{ m}$ (33 ft))

In the event of very strong vibrations, the pipe and sensor must be supported and fixed. It is also advisable to mount the sensor and transmitter separately.

- i** Information on the shock resistance of the measuring system → 165
- i** Information on the vibration resistance of the measuring system → 164

Adapters

Suitable adapters to DIN EN 545 (double-flange reducers) can be used to install the sensor in larger-diameter pipes. The resultant increase in the rate of flow improves measuring accuracy with very slow-moving fluids. The nomogram shown here can be used to calculate the pressure loss caused by reducers and expanders.

i The nomogram only applies to liquids with a viscosity similar to that of water.

1. Calculate the ratio of the diameters d/D .
2. From the nomogram read off the pressure loss as a function of flow velocity (downstream from the reduction) and the d/D ratio.

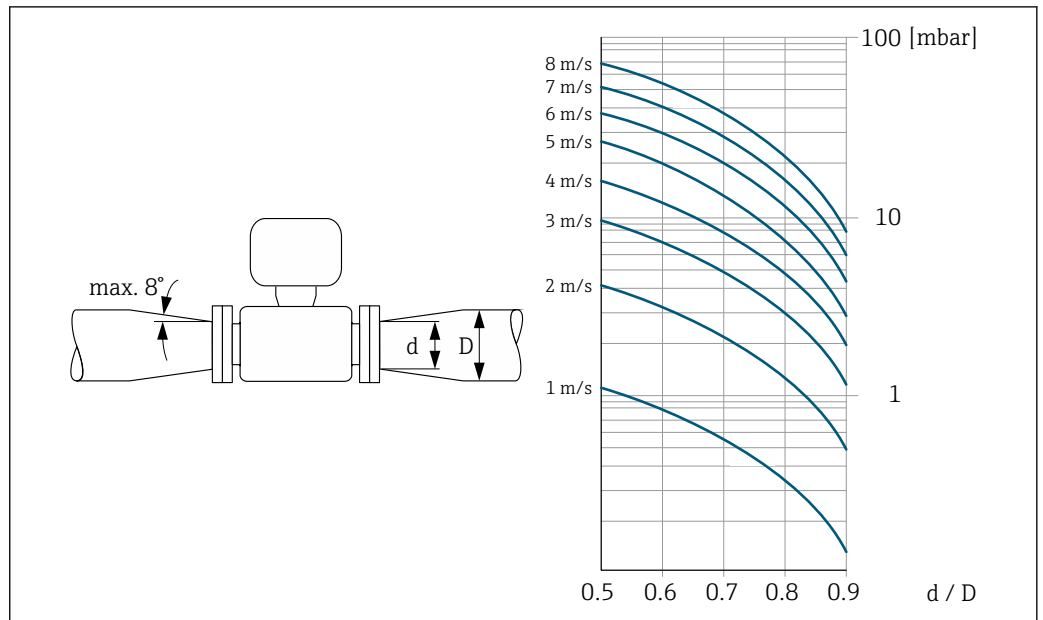

Length of connecting cable

To ensure correct measuring results when using the remote version, observe the maximum permitted length of the connecting cable L_{\max} . This length is determined by the conductivity of the fluid.

If measuring liquids in general: $5 \mu\text{S}/\text{cm}$

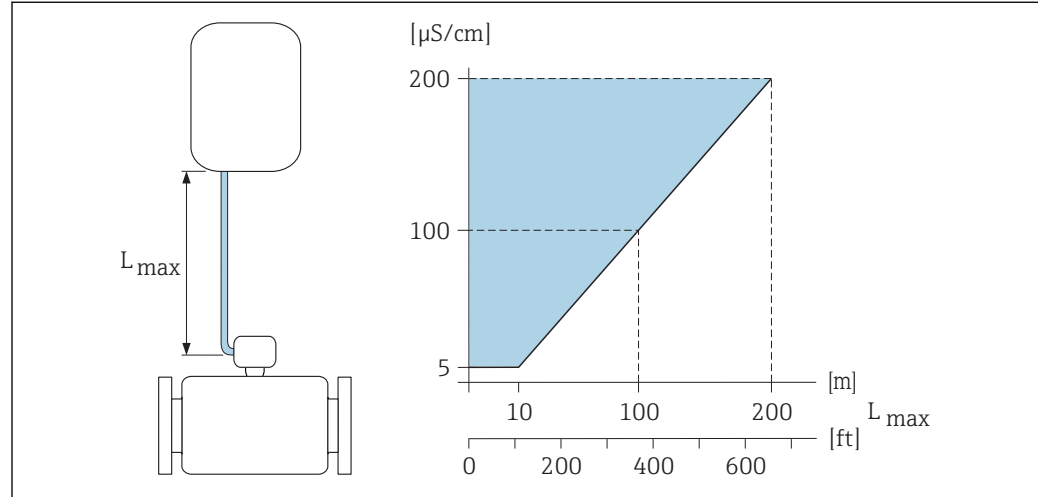

9 Permitted length of connecting cable for remote version

Colored area = permitted range

L_{\max} = length of connecting cable in [m] ([ft])

[$\mu\text{S}/\text{cm}$] = fluid conductivity

6.1.3 Special mounting instructions

Display protection

- To ensure that the optional display protection can be easily opened, maintain the following minimum head clearance: 350 mm (13.8 in)

Permanent immersion in water

A fully welded remote version with IP68 protection is optionally available for permanent immersion in water $\leq 3 \text{ m}$ (10 ft) or in exceptional cases for use for up to 48 hours at $\leq 10 \text{ m}$ (30 ft). The measuring device meets the requirements of corrosion categories C5-M and Im1/Im2/Im3. The fully welded design along with the connection compartment sealing system ensure that moisture cannot enter the measuring device.

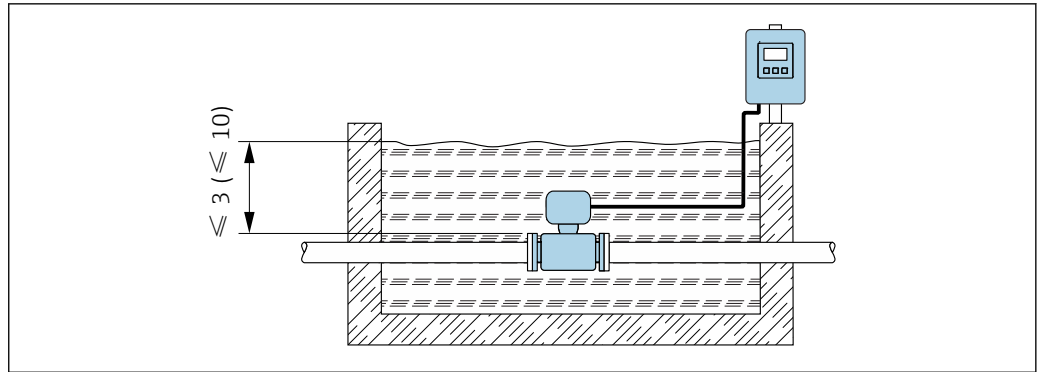

10 Engineering unit in m(ft)

i Replacement of cable gland on connection housing

Buried applications

A remote version with IP68 protection is optionally available for buried applications. The measuring device satisfies the certified corrosion protection Im1/Im2/Im3 in accordance with EN ISO 12944. It can be used directly underground without the need for additional protective measures. The device is mounted in accordance with the usual regional installation regulations (e.g. EN DIN 1610).

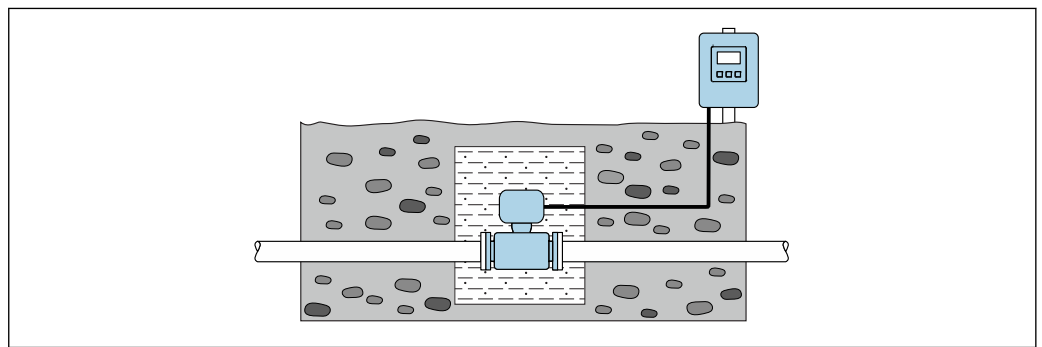

6.2 Mounting the measuring device

6.2.1 Required tools

For transmitter

- Torque wrench
- For wall mounting:
 - Open-ended wrench for hexagonal screw max. M5
- For pipe mounting:
 - Open-ended wrench AF 8
 - Phillips head screwdriver PH 2
- For turning the transmitter housing (compact version):
 - Phillips head screwdriver PH 2
 - Torx screwdriver TX 20
 - Open-ended wrench AF 7

For sensor

For flanges and other process connections: Corresponding mounting tools

6.2.2 Preparing the measuring device

1. Remove all remaining transport packaging.
2. Remove any protective covers or protective caps present from the sensor.
3. Remove stick-on label on the electronics compartment cover.

6.2.3 Mounting the sensor

⚠ WARNING

Danger due to improper process sealing!

- ▶ Ensure that the inside diameters of the gaskets are greater than or equal to that of the process connections and piping.
 - ▶ Ensure that the gaskets are clean and undamaged.
 - ▶ Install the gaskets correctly.
1. Ensure that the direction of the arrow on the sensor matches the flow direction of the medium.
 2. To ensure compliance with device specifications, install the measuring device between the pipe flanges in a way that it is centered in the measurement section.
 3. If using ground disks, comply with the Installation Instructions provided.
 4. Observe required screw tightening torques .
 5. Install the measuring device or turn the transmitter housing so that the cable entries do not point upwards.

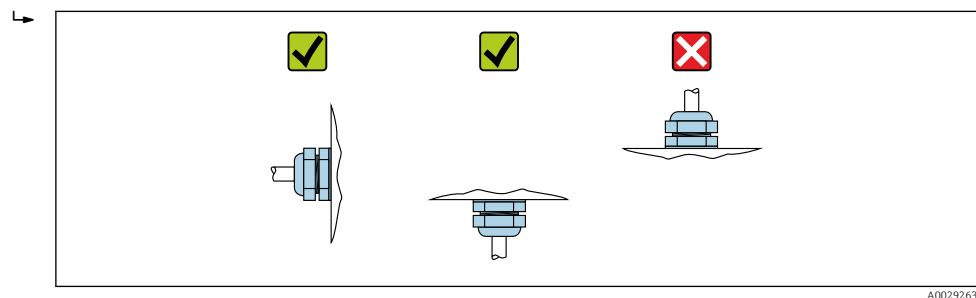

A0029263

Mounting the seals

⚠ CAUTION

An electrically conductive layer could form on the inside of the measuring tube!

Risk of measuring signal short circuit.

- ▶ Do not use electrically conductive sealing compounds such as graphite.

Comply with the following instructions when installing seals:

1. Make sure that the seals do not protrude into the piping cross-section.
2. For DIN flanges: only use seals according to DIN EN 1514-1.
3. For "hard rubber" lining: additional seals are **always** required.
4. For "polyurethane" lining: generally additional seals are **not** required.

Mounting the ground cable/ground disks

Comply with the information on potential equalization and detailed mounting instructions for the use of ground cables/ground disks .

Screw tightening torques

Please note the following:

- The screw tightening torques listed below apply only to lubricated threads and to pipes not subjected to tensile stress.
- Tighten the screws uniformly and in diagonally opposite sequence.
- Overtightening the screws will deform the sealing faces or damage the seals.

Screw tightening torques for EN 1092-1 (DIN 2501), PN 6/10/16/25/40

Nominal diameter [mm]	Pressure rating [bar]	Screws [mm]	Flange thickness [mm]	Max. screw tightening torque [Nm]	
				Hard rubber	Polyurethane
25	PN 40	4 × M12	18	-	15
32	PN 40	4 × M16	18	-	24
40	PN 40	4 × M16	18	-	31
50	PN 40	4 × M16	20	48	40
65 ¹⁾	PN 16	8 × M16	18	32	27
65	PN 40	8 × M16	22	32	27
80	PN 16	8 × M16	20	40	34
80	PN 40	8 × M16	24	40	34
100	PN 16	8 × M16	20	43	36
100	PN 40	8 × M20	24	59	50
125	PN 16	8 × M16	22	56	48
125	PN 40	8 × M24	26	83	71
150	PN 16	8 × M20	22	74	63
150	PN 40	8 × M24	28	104	88
200	PN 10	8 × M20	24	106	91
200	PN 16	12 × M20	24	70	61
200	PN 25	12 × M24	30	104	92
250	PN 10	12 × M20	26	82	71
250	PN 16	12 × M24	26	98	85
250	PN 25	12 × M27	32	150	134
300	PN 10	12 × M20	26	94	81
300	PN 16	12 × M24	28	134	118
300	PN 25	16 × M27	34	153	138
350	PN 6	12 × M20	22	111	120
350	PN 10	16 × M20	26	112	118
350	PN 16	16 × M24	30	152	165
350	PN 25	16 × M30	38	227	252
400	PN 6	16 × M20	22	90	98
400	PN 10	16 × M24	26	151	167
400	PN 16	16 × M27	32	193	215
400	PN 25	16 × M33	40	289	326
450	PN 6	16 × M20	22	112	126
450	PN 10	20 × M24	28	153	133
450	PN 16	20 × M27	40	198	196
450	PN 25	20 × M33	46	256	253

Nominal diameter [mm]	Pressure rating [bar]	Screws [mm]	Flange thickness [mm]	Max. screw tightening torque [Nm]	
				Hard rubber	Polyurethane
500	PN 6	20 × M20	24	119	123
500	PN 10	20 × M24	28	155	171
500	PN 16	20 × M30	34	275	300
500	PN 25	20 × M33	48	317	360
600	PN 6	20 × M24	30	139	147
600	PN 10	20 × M27	28	206	219
600 ¹⁾	PN 16	20 × M33	36	415	443
600	PN 25	20 × M36	58	431	516
700	PN 6	24 × M24	24	148	139
700	PN 10	24 × M27	30	246	246
700	PN 16	24 × M33	36	278	318
700	PN 25	24 × M39	46	449	507
800	PN 6	24 × M27	24	206	182
800	PN 10	24 × M30	32	331	316
800	PN 16	24 × M36	38	369	385
800	PN 25	24 × M45	50	664	721
900	PN 6	24 × M27	26	230	637
900	PN 10	28 × M30	34	316	307
900	PN 16	28 × M36	40	353	398
900	PN 25	28 × M45	54	690	716
1000	PN 6	28 × M27	26	218	208
1000	PN 10	28 × M33	34	402	405
1000	PN 16	28 × M39	42	502	518
1000	PN 25	28 × M52	58	970	971
1200	PN 6	32 × M30	28	319	299
1200	PN 10	32 × M36	38	564	568
1200	PN 16	32 × M45	48	701	753
1400	PN 6	36 × M33	32	430	398
1400	PN 10	36 × M39	42	654	618
1400	PN 16	36 × M45	52	729	762
1600	PN 6	40 × M33	34	440	417
1600	PN 10	40 × M45	46	946	893
1600	PN 16	40 × M52	58	1007	1100
1800	PN 6	44 × M36	36	547	521
1800	PN 10	44 × M45	50	961	895
1800	PN 16	44 × M52	62	1108	1003
2000	PN 6	48 × M39	38	629	605
2000	PN 10	48 × M45	54	1047	1092
2000	PN 16	48 × M56	66	1324	1261

1) Designed acc. to EN 1092-1 (not to DIN 2501)

Screw tightening torques for EN 1092-1 (DIN 2501), PN 10/16/25, P245GH/stainless;
calculated according to EN 1591-1:2014 for flanges as per EN 1092-1:2013

Nominal diameter [mm]	Pressure rating [bar]	Screws [mm]	Flange thickness [mm]	Nom. screw tightening torque [Nm]	
				PUR	HG
350	PN 6	12 × M20	22	75	60
350	PN 10	16 × M20	26	80	70
350	PN 16	16 × M24	30	135	125
350	PN 25	16 × M30	38	235	230
400	PN 6	16 × M20	22	70	65
400	PN 10	16 × M24	26	120	100
400	PN 16	16 × M27	32	190	175
400	PN 25	16 × M33	40	325	315
450	PN 6	16 × M20	22	90	70
450	PN 10	20 × M24	28	110	100
450	PN 16	20 × M27	34	190	175
450	PN 25	20 × M33	46	310	300
500	PN 6	20 × M20	24	70	65
500	PN 10	20 × M24	28	120	110
500	PN 16	20 × M30	36	235	225
500	PN 25	20 × M33	48	370	370
600	PN 6	20 × M24	30	105	105
600	PN 10	20 × M27	30	160	165
600	PN 16	20 × M33	40	340	340
600	PN 25	20 × M36	48	540	540
700	PN 6	24 × M24	30	110	110
700	PN 10	24 × M27	35	190	190
700	PN 16	24 × M33	40	340	340
700	PN 25	24 × M39	50	595	615
800	PN 6	24 × M27	30	145	145
800	PN 10	24 × M30	38	260	260
800	PN 16	24 × M36	41	455	465
800	PN 25	24 × M45	53	880	885
900	PN 6	24 × M27	34	180	170
900	PN 10	28 × M30	38	275	265
900	PN 16	28 × M36	48	475	475
900	PN 25	28 × M45	57	915	930
1000	PN 6	28 × M27	38	185	175
1000	PN 10	28 × M33	44	360	350
1000	PN 16	28 × M39	59	620	630
1000	PN 25	28 × M52	63	1290	1300
1200	PN 6	32 × M30	42	250	235
1200	PN 10	32 × M36	55	480	470
1200	PN 16	32 × M45	78	900	890

Nominal diameter [mm]	Pressure rating [bar]	Screws [mm]	Flange thickness [mm]	Nom. screw tightening torque [Nm]	
				PUR	HG
1400	PN 6	36 × M33	56	–	300
1400	PN 10	36 × M39	65	–	600
1400	PN 16	36 × M45	84	–	1050
1600	PN 6	40 × M33	63	–	340
1600	PN 10	40 × M45	75	–	810
1600	PN 16	40 × M52	102	–	1420
1800	PN 6	44 × M36	69	–	430
1800	PN 10	44 × M45	85	–	920
1800	PN 16	44 × M52	110	–	1600
2000	PN 6	48 × M39	74	–	530
2000	PN 10	48 × M45	90	–	1040
2000	PN 16	48 × M56	124	–	1900

Screw tightening torques for ASME B16.5, Class 150/300

Nominal diameter		Pressure rating [psi]	Screws [in]	Max. screw tightening torque [Nm] ([lbf · ft])	
[mm]	[in]			Hard rubber	Polyurethane
25	1	Class 150	4 × ½	–	7 (5)
25	1	Class 300	4 × 5/8	–	8 (6)
40	1 ½	Class 150	4 × ½	–	10 (7)
40	1 ½	Class 300	4 × ¾	–	15 (11)
50	2	Class 150	4 × 5/8	35 (26)	22 (16)
50	2	Class 300	8 × 5/8	18 (13)	11 (8)
80	3	Class 150	4 × 5/8	60 (44)	43 (32)
80	3	Class 300	8 × ¾	38 (28)	26 (19)
100	4	Class 150	8 × 5/8	42 (31)	31 (23)
100	4	Class 300	8 × ¾	58 (43)	40 (30)
150	6	Class 150	8 × ¾	79 (58)	59 (44)
150	6	Class 300	12 × ¾	70 (52)	51 (38)
200	8	Class 150	8 × ¾	107 (79)	80 (59)
250	10	Class 150	12 × 7/8	101 (74)	75 (55)
300	12	Class 150	12 × 7/8	133 (98)	103 (76)
350	14	Class 150	12 × 1	135 (100)	158 (117)
400	16	Class 150	16 × 1	128 (94)	150 (111)
450	18	Class 150	16 × 1 1/8	204 (150)	234 (173)
500	20	Class 150	20 × 1 1/8	183 (135)	217 (160)
600	24	Class 150	20 × 1 ¼	268 (198)	307 (226)

Screw tightening torques for AWWA C207, Class D

Nominal diameter		Screws [in]	Max. screw tightening torque [Nm] ([lbf · ft])	
[mm]	[in]		Hard rubber	Polyurethane
700	28	28 × 1 ¼	247 (182)	292 (215)
750	30	28 × 1 ¼	287 (212)	302 (223)
800	32	28 × 1 ½	394 (291)	422 (311)
900	36	32 × 1 ½	419 (309)	430 (317)
1000	40	36 × 1 ½	420 (310)	477 (352)
1050	42	36 × 1 ½	528 (389)	518 (382)
1200	48	44 × 1 ½	552 (407)	531 (392)
1350	54	44 × 1 ¾	730 (538)	–
1500	60	52 × 1 ¾	758 (559)	–
1650	66	52 × 1 ¾	946 (698)	–
1800	72	60 × 1 ¾	975 (719)	–
2000	78	64 × 2	853 (629)	–

Screw tightening torques for AS 2129, Table E

Nominal diameter [mm]	Screws [mm]	Max. screw tightening torque [Nm]	
		Hard rubber	Polyurethane
50	4 × M16	32	–
80	4 × M16	49	–
100	8 × M16	38	–
150	8 × M20	64	–
200	8 × M20	96	–
250	12 × M20	98	–
300	12 × M24	123	–
350	12 × M24	203	–
400	12 × M24	226	–
450	16 × M24	226	–
500	16 × M24	271	–
600	16 × M30	439	–
700	20 × M30	355	–
750	20 × M30	559	–
800	20 × M30	631	–
900	24 × M30	627	–
1000	24 × M30	634	–
1200	32 × M30	727	–

Screw tightening torques for AS 4087, PN 16

Nominal diameter [mm]	Screws [mm]	Max. screw tightening torque [Nm]	
		Hard rubber	Polyurethane
50	4 × M16	32	–
80	4 × M16	49	–

Nominal diameter [mm]	Screws [mm]	Max. screw tightening torque [Nm]	
		Hard rubber	Polyurethane
100	4 × M16	76	-
150	8 × M20	52	-
200	8 × M20	77	-
250	8 × M20	147	-
300	12 × M24	103	-
350	12 × M24	203	-
375	12 × M24	137	-
400	12 × M24	226	-
450	12 × M24	301	-
500	16 × M24	271	-
600	16 × M27	393	-
700	20 × M27	330	-
750	20 × M30	529	-
800	20 × M33	631	-
900	24 × M33	627	-
1000	24 × M33	595	-
1200	32 × M33	703	-

Screw tightening torques for JIS B2220, 10/20K

Nominal diameter [mm]	Pressure rating [bar]	Screws [mm]	Max. screw tightening torque [Nm]	
			Hard rubber	Polyurethane
25	10K	4 × M16	-	19
25	20K	4 × M16	-	19
32	10K	4 × M16	-	22
32	20K	4 × M16	-	22
40	10K	4 × M16	-	24
40	20K	4 × M16	-	24
50	10K	4 × M16	40	33
50	20K	8 × M16	20	17
65	10K	4 × M16	55	45
65	20K	8 × M16	28	23
80	10K	8 × M16	29	23
80	20K	8 × M20	42	35
100	10K	8 × M16	35	29
100	20K	8 × M20	56	48
125	10K	8 × M20	60	51
125	20K	8 × M22	91	79
150	10K	8 × M20	75	63
150	20K	12 × M22	81	72
200	10K	12 × M20	61	52
200	20K	12 × M22	91	80

Nominal diameter [mm]	Pressure rating [bar]	Screws [mm]	Max. screw tightening torque [Nm]	
			Hard rubber	Polyurethane
250	10K	12 × M22	100	87
250	20K	12 × M24	159	144
300	10K	16 × M22	74	63
300	20K	16 × M24	138	124

Screw tightening torques for JIS B2220, 10/20K

Nominal diameter [mm]	Pressure rating [bar]	Screws [mm]	Nom. screw tightening torque [Nm]	
			PUR	HG
350	10K	16 × M22	109	109
350	20K	16 × M30×3	217	217
400	10K	16 × M24	163	163
400	20K	16 × M30×3	258	258
450	10K	16 × M24	155	155
450	20K	16 × M30×3	272	272
500	10K	16 × M24	183	183
500	20K	16 × M30×3	315	315
600	10K	16 × M30	235	235
600	20K	16 × M36×3	381	381
700	10K	16 × M30	300	300
750	10K	16 × M30	339	339

6.2.4 Mounting the transmitter of the remote version

⚠ CAUTION

Ambient temperature too high!

Danger of electronics overheating and housing deformation.

- ▶ Do not exceed the permitted maximum ambient temperature .
- ▶ If operating outdoors: Avoid direct sunlight and exposure to weathering, particularly in warm climatic regions.

⚠ CAUTION

Excessive force can damage the housing!

- ▶ Avoid excessive mechanical stress.

The transmitter of the remote version can be mounted in the following ways:

- Wall mounting
- Pipe mounting

Wall mounting

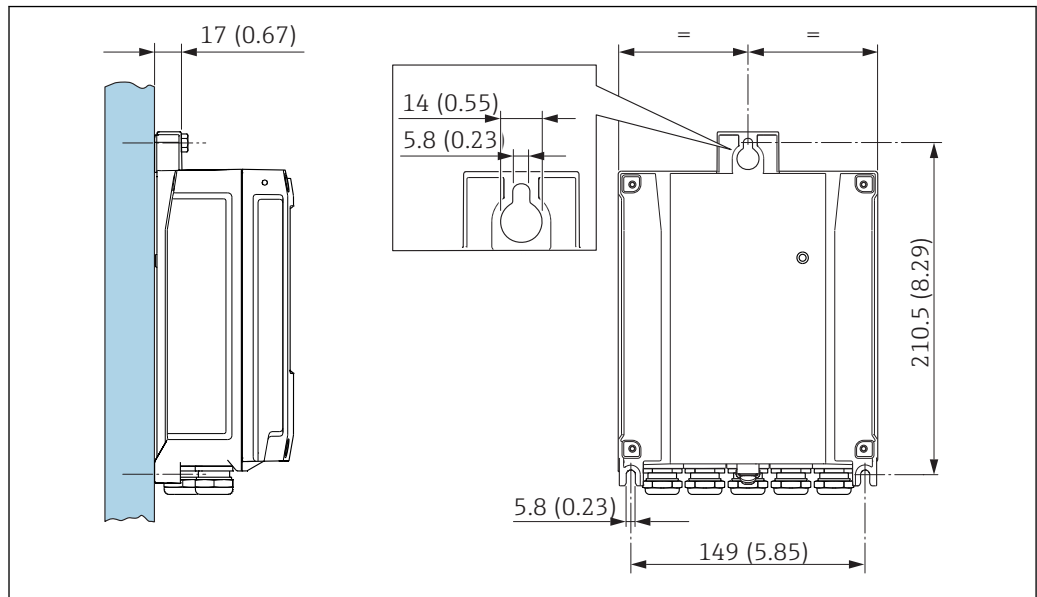

A0020523

11 Engineering unit mm (in)

1. Drill the holes.
2. Insert wall plugs into the drilled holes.
3. Screw in the securing screws slightly at first.
4. Fit the transmitter housing over the securing screws and mount in place.
5. Tighten the securing screws.

Post mounting

⚠ WARNING

Excessive tightening torque applied to the fixing screws!

Risk of damaging the plastic transmitter.

- Tighten the fixing screws as per the tightening torque:

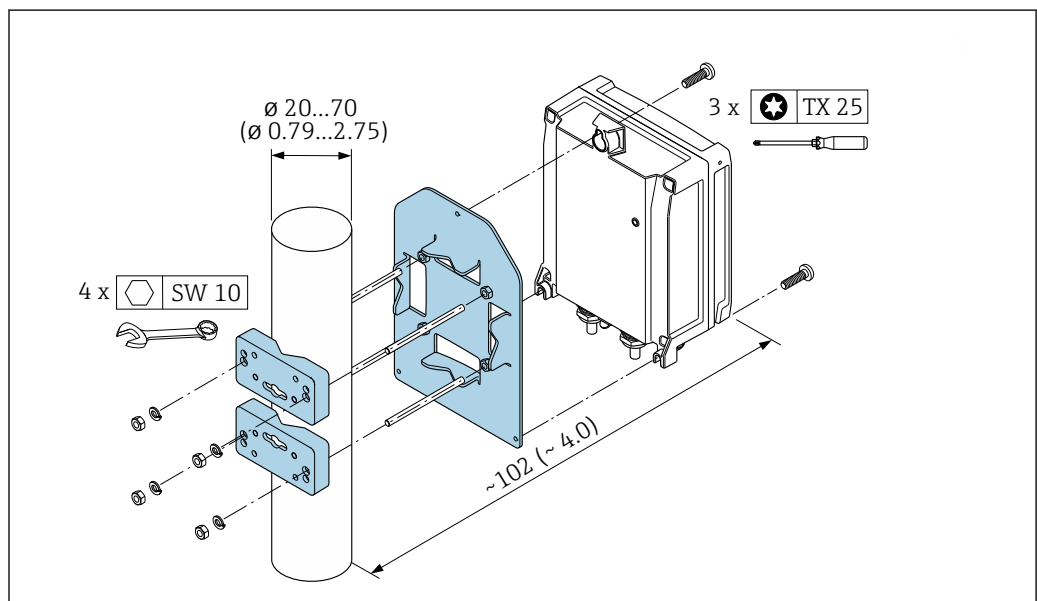

A0029051

12 Engineering unit mm (in)

6.2.5 Turning the transmitter housing

To provide easier access to the connection compartment or display module, the transmitter housing can be turned.

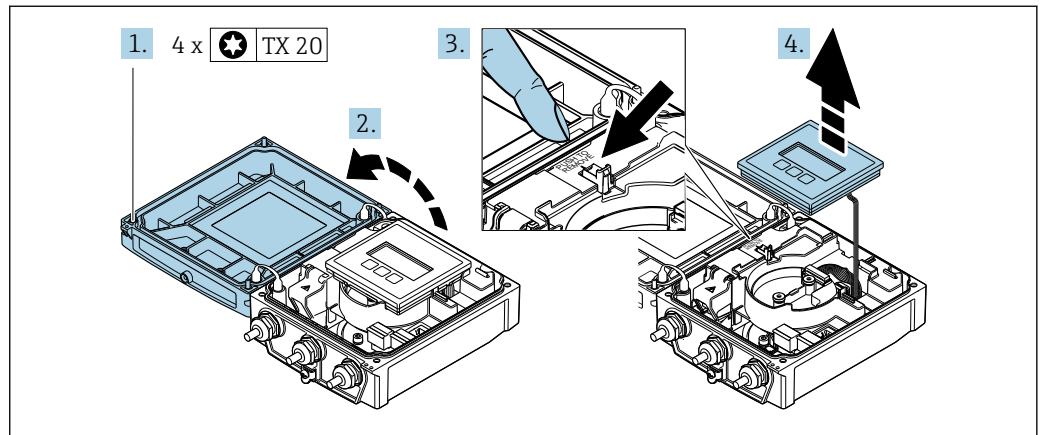

A0032086

1. Loosen the fixing screws of the housing cover (when reassembling, pay attention to the tightening torque → 38).
2. Open the housing cover.
3. Unlock the display module.
4. Remove the display module.

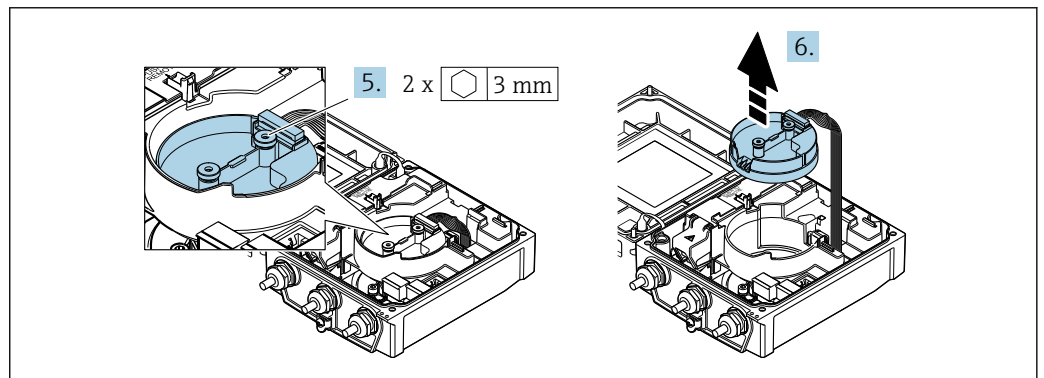

A0032087

5. Loosen the fixing screws of the smart sensor electronics module (when reassembling, pay attention to the tightening torque → 38).
6. Remove the smart sensor electronics module (when reassembling, pay attention to the coding of the plug → 38).

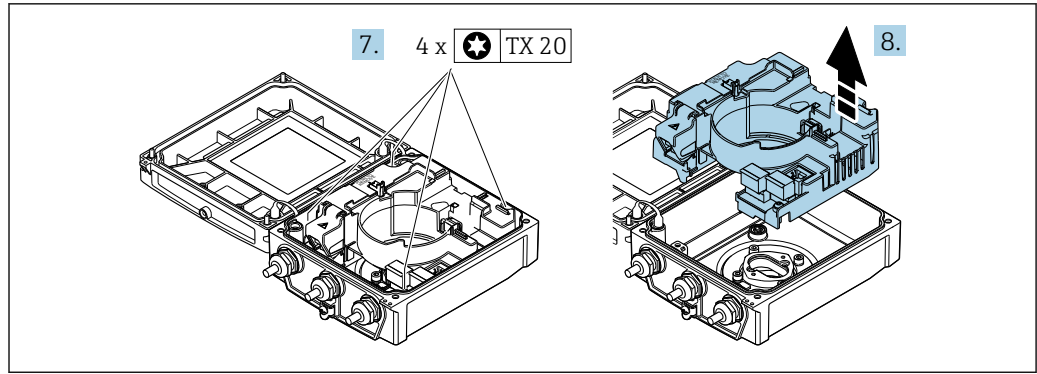

A0032088

- 7. Loosen the fixing screws of the main electronics module (when reassembling, pay attention to the tightening torque → 38).
- 8. Remove the main electronics module.

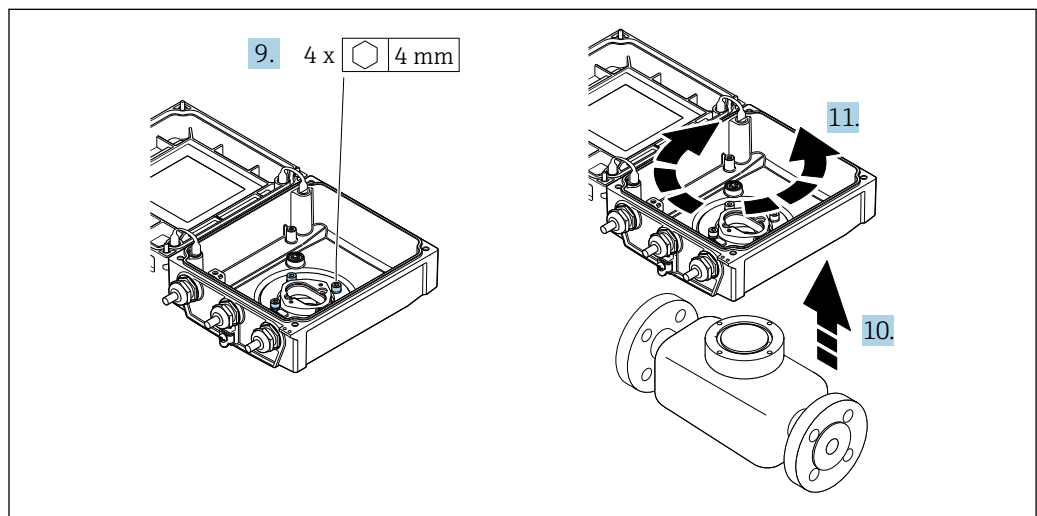

A0032089

- 9. Loosen the fixing screws of the transmitter housing (when reassembling, pay attention to the tightening torque → 38).
- 10. Lift the transmitter housing.
- 11. Turn the housing to the desired position in increments of 90°.

Reassembling the transmitter housing

⚠ WARNING

Excessive tightening torque applied to the fixing screws!

Risk of damaging the plastic transmitter.

► Tighten the fixing screws as per the tightening torque:

Step → 37	Fixing screw	Tightening torques for housing made of:	
		Aluminum	Plastic
1	Housing cover	2.5 Nm (1.8 lbf ft)	1 Nm (0.7 lbf ft)
5	Smart sensor electronics module	0.6 Nm (0.4 lbf ft)	
7	Main electronics module	1.5 Nm (1.1 lbf ft)	
9/10	Transmitter housing	5.5 Nm (4.1 lbf ft)	

NOTICE

Plug of the smart sensor electronics module connected incorrectly!

No measuring signal is output.

- ▶ Plug in the plug of the smart sensor electronics module as per the coding.

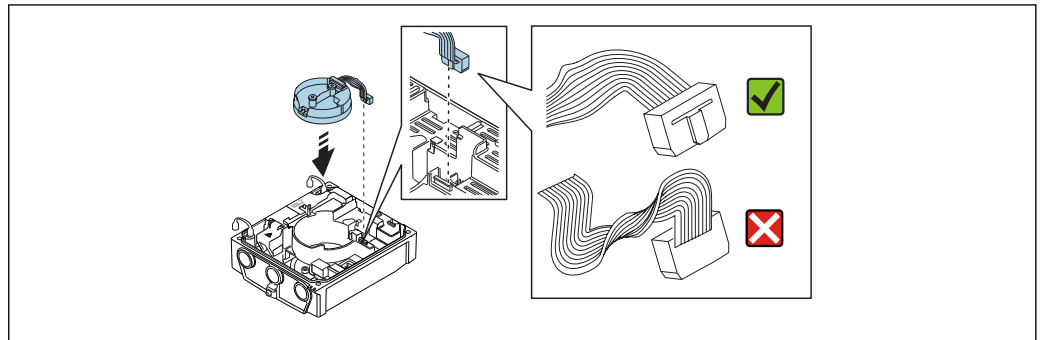

A0021585

- ▶ Reverse the procedure to reassemble the measuring device.

6.2.6 Turning the display module

The display module can be turned to optimize display readability and operability.

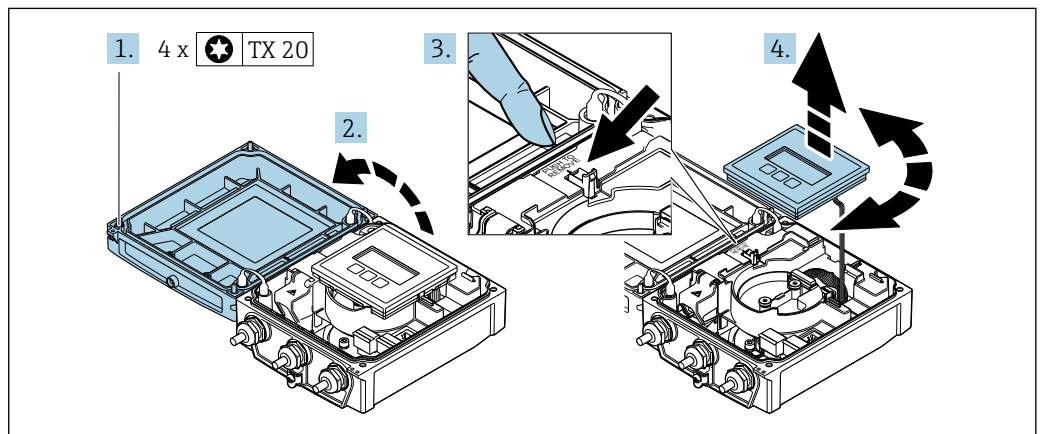

A0032091

1. Loosen the fixing screws of the housing cover (when reassembling, pay attention to the tightening torque → 39).
2. Open the housing cover.
3. Unlock the display module.
4. Pull out the display module and turn it to the desired position in increments of 90°.

Reassembling the transmitter housing

⚠ WARNING

Excessive tightening torque applied to the fixing screws!

Risk of damaging the plastic transmitter.

- ▶ Tighten the fixing screws as per the tightening torque:

Step (see graphic)	Fixing screw	Tightening torque for housing made of:	
		Aluminum	Plastic
1	Housing cover	2.5 Nm (1.8 lbf ft)	1 Nm (0.7 lbf ft)

- ▶ Reverse the procedure to reassemble the measuring device.

6.3 Post-installation check

Is the device undamaged (visual inspection)?	<input type="checkbox"/>
Does the measuring device conform to the measuring point specifications? For example: <ul style="list-style-type: none"> ▪ Process temperature ▪ Process pressure (refer to the section on "Pressure-temperature ratings" in the "Technical Information" document) ▪ Ambient temperature ▪ Measuring range 	<input type="checkbox"/>
Has the correct orientation for the sensor been selected ? <ul style="list-style-type: none"> ▪ According to sensor type ▪ According to medium temperature ▪ According to medium properties (outgassing, with entrained solids) 	<input type="checkbox"/>
Does the arrow on the sensor nameplate match the direction of flow of the fluid through the piping ?	<input type="checkbox"/>
Are the measuring point identification and labeling correct (visual inspection)?	<input type="checkbox"/>
Is the device adequately protected from precipitation and direct sunlight?	<input type="checkbox"/>
Have the fixing screws been tightened with the correct tightening torque?	<input type="checkbox"/>

7 Electrical connection

NOTICE

The measuring device does not have an internal circuit breaker.

- ▶ For this reason, assign the measuring device a switch or power-circuit breaker so that the power supply line can be easily disconnected from the mains.
- ▶ Although the measuring device is equipped with a fuse, additional overcurrent protection (maximum 16 A) should be integrated into the system installation.

7.1 Connection conditions

7.1.1 Requirements for connecting cable

The connecting cables provided by the customer must fulfill the following requirements.

Electrical safety

In accordance with applicable federal/national regulations.

Permitted temperature range

- The installation guidelines that apply in the country of installation must be observed.
- The cables must be suitable for the minimum and maximum temperatures to be expected.

Power supply cable

Standard installation cable is sufficient.

Signal cable

Current output 0/4 to 20 mA

Standard installation cable is sufficient.

Current output 4 to 20 mA HART

A shielded cable is recommended. Observe grounding concept of the plant.

Pulse/frequency/switch output

Standard installation cable is sufficient.

Status input

Standard installation cable is sufficient.

Connecting cable for remote version

Electrode cable

Standard cable	3 × 0.38 mm ² (20 AWG) with common, braided copper shield (ϕ ~9.5 mm (0.37 in)) and individual shielded cores
Cable for empty pipe detection (EPD)	4 × 0.38 mm ² (20 AWG) with common, braided copper shield (ϕ ~9.5 mm (0.37 in)) and individual shielded cores
Conductor resistance	≤ 50 Ω/km (0.015 Ω/ft)
Capacitance: core/shield	≤ 420 pF/m (128 pF/ft)
Operating temperature	-20 to +80 °C (-68 to +176 °F)

Coil current cable

Standard cable	3 × 0.75 mm ² (18 AWG) with common, braided copper shield (ϕ ~9 mm (0.35 in))
Conductor resistance	≤ 37 Ω/km (0.011 Ω/ft)
Capacitance: core/core, shield grounded	≤ 120 pF/m (37 pF/ft)
Operating temperature	-20 to +80 °C (-68 to +176 °F)
Test voltage for cable insulation	≤ AC 1433 V r.m.s. 50/60 Hz or ≥ DC 2026 V

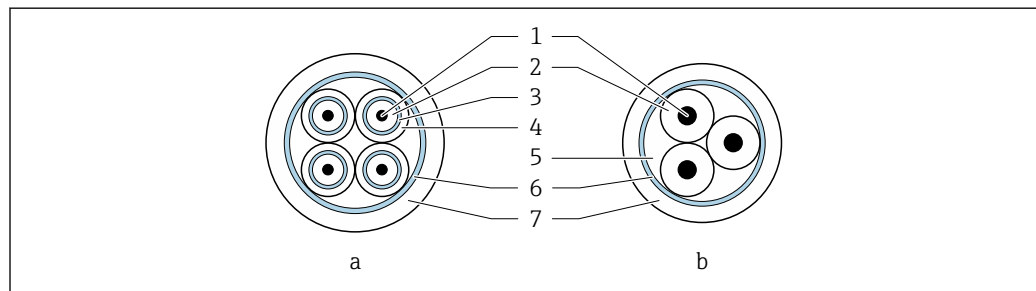

A0029151

13 Cable cross-section

- a* Electrode cable
b Coil current cable
 1 Core
 2 Core insulation
 3 Core shield
 4 Core jacket
 5 Core reinforcement
 6 Cable shield
 7 Outer jacket

Reinforced connecting cables

Reinforced connecting cables with an additional, reinforcing metal braid should be used for:

- When laying the cable directly in the ground
- Where there is a risk of damage from rodents
- If using the device below IP68 degree of protection

Operation in zones of severe electrical interference

The measuring system meets the general safety requirements → 195 and EMC specifications → 165.

Grounding is by means of the ground terminal provided for the purpose inside the connection housing. The stripped and twisted lengths of cable shield to the ground terminal must be as short as possible.

Cable diameter

- Cable glands supplied:
 - For standard cable: M20 × 1.5 with cable ϕ6 to 12 mm (0.24 to 0.47 in)
 - For reinforced cable: M20 × 1.5 with cable ϕ9.5 to 16 mm (0.37 to 0.63 in)
- (Plug-in) spring terminals for wire cross-sections 0.5 to 2.5 mm² (20 to 14 AWG)

7.1.2 Required tools

- Torque wrench
- For cable entries: Use corresponding tools
- Wire stripper
- When using stranded cables: Crimper for wire end ferrule

7.1.3 Terminal assignment

Transmitter

The sensor can be ordered with terminals.

Connection methods available		Possible options for order code "Electrical connection"
Outputs	Power supply	
terminals	terminals	<ul style="list-style-type: none"> ■ Option A: coupling M20x1 ■ Option B: thread M20x1 ■ Option C: thread G ½" ■ Option D: thread NPT ½"

Supply voltage

Order code "Power supply"	Terminal numbers	terminal voltage		Frequency range
Option L (wide range power unit)	1 (L+/L), 2 (L-/N)	DC 24 V	±25%	–
		AC 24 V	±25%	50/60 Hz, ±4 Hz
		AC 100 to 240 V	–15 to +10%	50/60 Hz, ±4 Hz

Signal transmission 0-20 mA/4-20 mA HART and additional outputs and inputs

Order code for "Output" and "Input"	Terminal numbers							
	Output 1		Output 2		Output 3		Input	
	26 (+)	27 (-)	24 (+)	25 (-)	22 (+)	23 (-)	20 (+)	21 (-)
Option H	<ul style="list-style-type: none"> ■ 4-20 mA HART (active) ■ 0-20 mA (active) 		Pulse/frequency output (passive)		Switch output (passive)		-	
Option I	<ul style="list-style-type: none"> ■ 4-20 mA HART (active) ■ 0-20 mA (active) 		Pulse/frequency/switch output (passive)		Pulse/frequency/switch output (passive)		Status input	
Option J	<ul style="list-style-type: none"> ■ 4-20 mA HART (active) ■ 0-20 mA (active) 		Permanently assigned Pulse output adjusted (passive)		Pulse/frequency/switch output (passive)		Status input	

Remote version

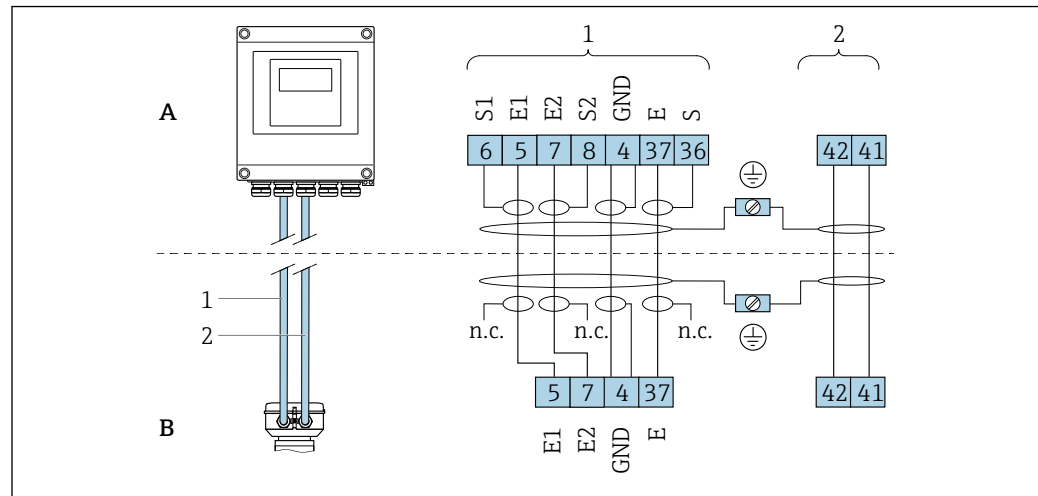

14 Remote version terminal assignment

- A Transmitter wall-mount housing
 B Sensor connection housing
 1 Electrode cable
 2 Coil current cable
 n.c. Not connected, insulated cable shields

Terminal No. and cable colors: 6/5 = brown; 7/8 = white; 4 = green; 36/37 = yellow

7.1.4 Shielding and grounding

7.1.5 Requirements for the supply unit

Supply voltage

Transmitter

Order code for "Power supply"	terminal voltage		Frequency range
Option L	DC 24 V	±25%	–
	AC 24 V	±25%	50/60 Hz, ±4 Hz
	AC 100 to 240 V	–15 to +10%	50/60 Hz, ±4 Hz

7.1.6 Preparing the measuring device

Carry out the steps in the following order:

1. Mount the sensor and transmitter.
2. Connection housing, sensor: Connect connecting cable.
3. Transmitter: Connect connecting cable.
4. Transmitter: Connect signal cable and cable for supply voltage.

NOTICE

Insufficient sealing of the housing!

Operational reliability of the measuring device could be compromised.

- Use suitable cable glands corresponding to the degree of protection.

1. Remove dummy plug if present.

- 2. If the measuring device is supplied without cable glands:
Provide suitable cable gland for corresponding connecting cable.
- 3. If the measuring device is supplied with cable glands:
Observe requirements for connecting cables → 41.

7.1.7 Preparing the connecting cable for the remote version

When terminating the connecting cable, pay attention to the following points:

- 1. In the case of the electrode cable:
Make sure that the ferrules do not touch the core shields on the sensor side.
Minimum distance = 1 mm (exception: green "GND" cable)
- 2. In the case of the coil current cable:
Insulate one core of the three-core cable at the level of the core reinforcement. You only require two cores for the connection.
- 3. For cables with fine-wire cores (stranded cables):
Fit the cores with ferrules.

Transmitter

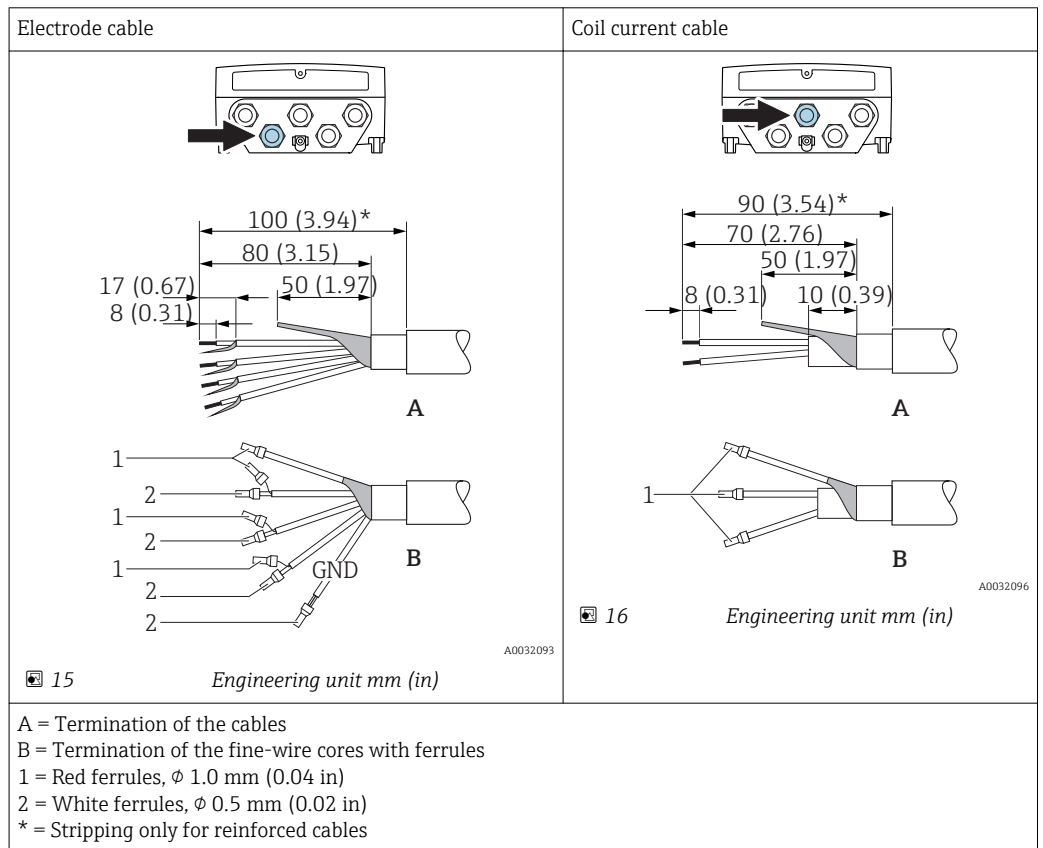

Sensor

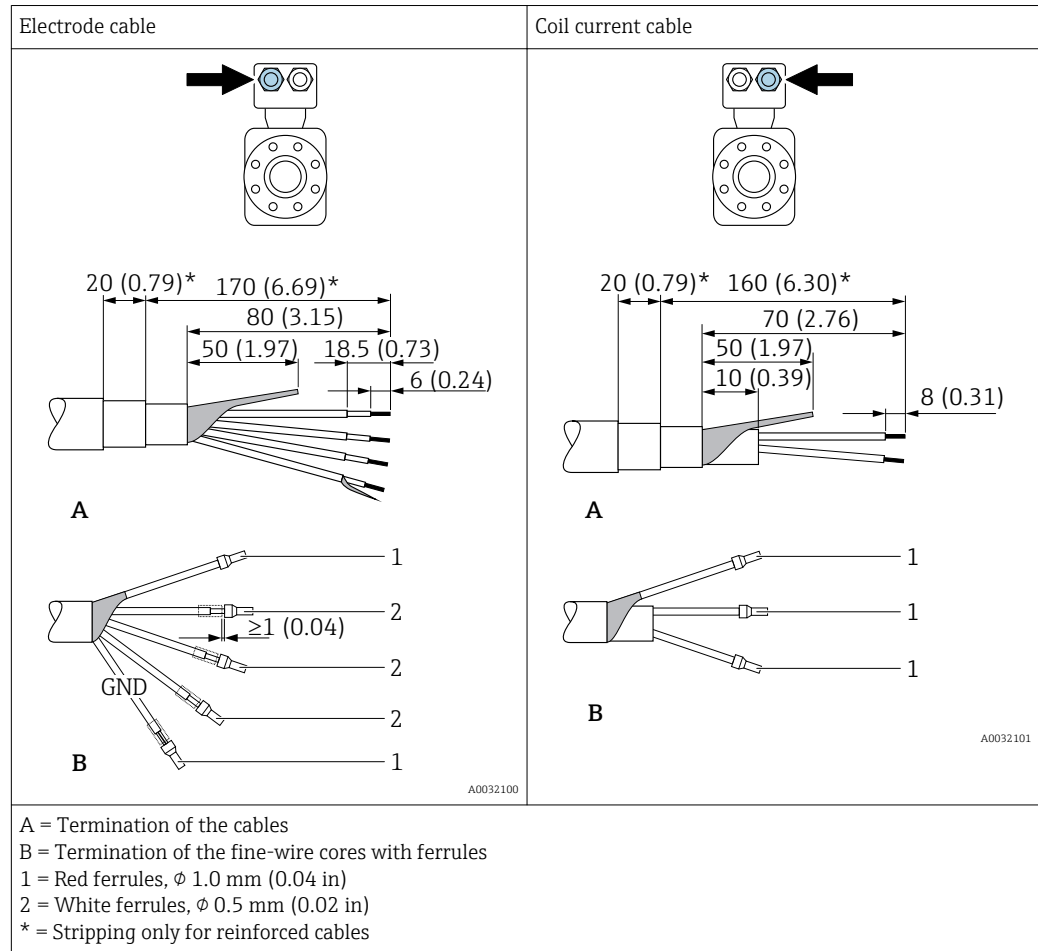

7.2 Connecting the measuring device

⚠ WARNING

Risk of electric shock! Components carry dangerous voltages!

- ▶ Have electrical connection work carried out by correspondingly trained specialists only.
- ▶ Observe applicable federal/national installation codes and regulations.
- ▶ Comply with local workplace safety regulations.
- ▶ Observe grounding concept of the plant.
- ▶ Never mount or wire the measuring device while it is connected to the supply voltage.
- ▶ Before the supply voltage is applied, connect the protective ground to the measuring device.

7.2.1 Connecting the remote version

⚠ WARNING

Risk of damaging the electronic components!

- ▶ Connect the sensor and transmitter to the same potential equalization.
- ▶ Only connect the sensor to a transmitter with the same serial number.
- ▶ Ground the connection housing of the sensor via the external screw terminal.

The following procedure (in the action sequence given) is recommended for the remote version:

1. Mount the sensor and transmitter.
2. Connect the connecting cable for the remote version.

3. Connect the transmitter.

Connecting the connecting cable to the sensor connection housing

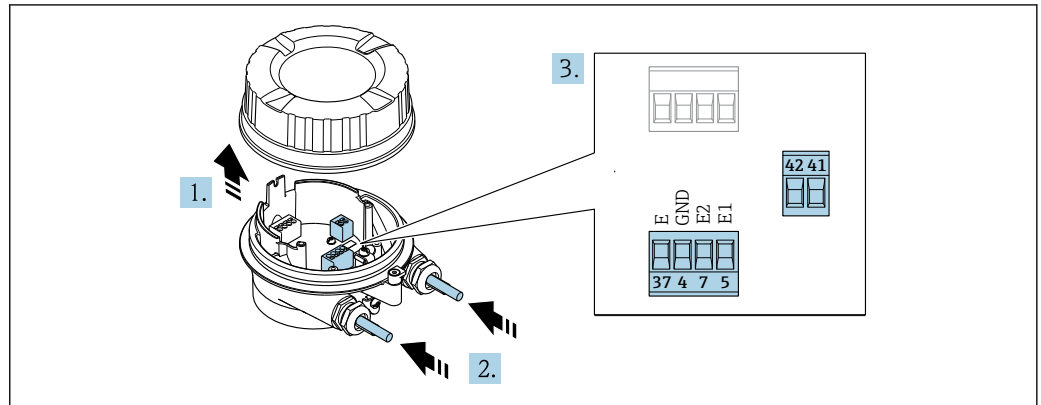

17 Sensor: connection module

1. Loosen the securing clamp of the housing cover.
2. Unscrew and lift off the housing cover.
3. **NOTICE**

For conduit extensions:

- ▶ Fit O-ring on cable and push it back sufficiently. When inserting the cable, the O-ring must be located outside the conduit extension.

Push the cable through the cable entry. To ensure tight sealing, do not remove the sealing ring from the cable entry.

4. Strip the cable and cable ends. In the case of stranded cables, also fit ferrules → 45.
5. Connect the cable in accordance with the terminal assignment → 44.
6. Firmly tighten the cable glands.

7. **WARNING**

Housing degree of protection may be voided due to insufficient sealing of the housing.

- ▶ Screw in the screw without using any lubricant. The threads on the cover are coated with a dry lubricant.

Reverse the procedure to reassemble the sensor.

Connecting the connecting cable to the transmitter

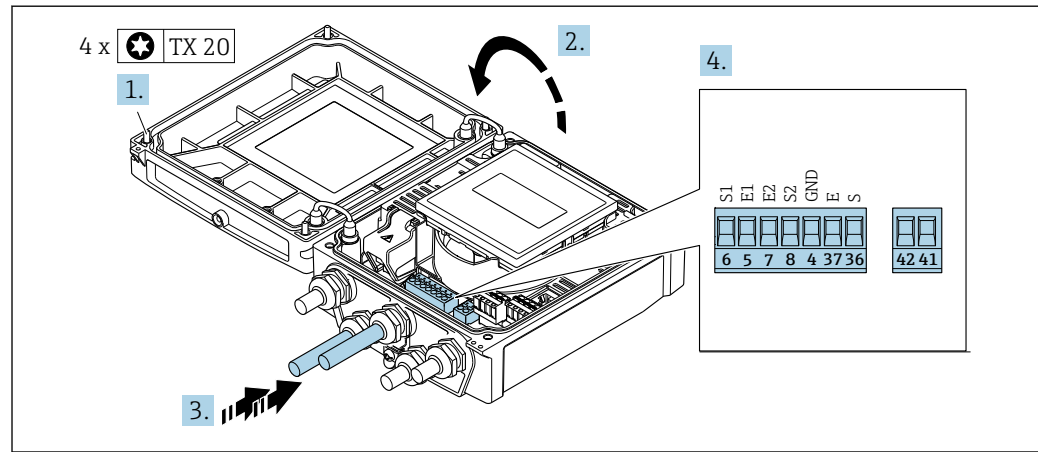

18 Transmitter: main electronics module with terminals

1. Loosen the 4 fixing screws on the housing cover.
2. Open the housing cover.
3. Push the cable through the cable entry . To ensure tight sealing, do not remove the sealing ring from the cable entry.
4. Strip the cable and cable ends. In the case of stranded cables, also fit ferrules → 45.
5. Connect the cable in accordance with the terminal assignment → 44.
6. Firmly tighten the cable glands.
7. **⚠ WARNING**
Housing degree of protection may be voided due to insufficient sealing of the housing.
 - ▶ Screw in the screw without using any lubricant.

Reverse the removal procedure to reassemble the transmitter.

7.2.2 Connecting the transmitter

⚠ WARNING

Housing degree of protection may be voided due to insufficient sealing of the housing.

- ▶ Screw in the screw without using any lubricant. The threads on the cover are coated with a dry lubricant.

Tightening torques for plastic housing

Housing cover fixing screw	1.3 Nm
Cable entry	4.5 to 5 Nm
Ground terminal	2.5 Nm

- i** For HART communication: when connecting the cable shielding to the ground terminal, observe the grounding concept of the facility.

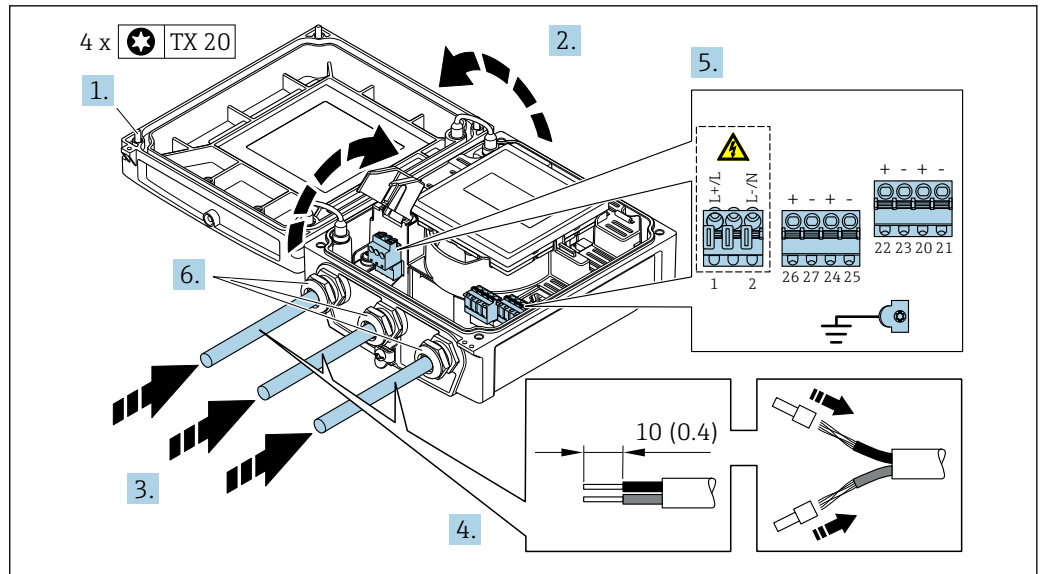

A0032104

19 Connecting the supply voltage and 0-20 mA/4-20 mA HART with additional outputs and inputs

1. Loosen the 4 fixing screws on the housing cover.
2. Open the housing cover.
3. Push the cable through the cable entry . To ensure tight sealing, do not remove the sealing ring from the cable entry.
4. Strip the cable and cable ends. In the case of stranded cables, also fit ferrules.
5. Connect the cable in accordance with the terminal assignment → 43. For supply voltage: open the shock protection cover.
6. Firmly tighten the cable glands.
7. **⚠ WARNING**
Housing degree of protection may be voided due to insufficient sealing of the housing.
 - ▶ Screw in the screw without using any lubricant.

Reverse the removal procedure to reassemble the transmitter.

7.2.3 Ensure potential equalization

Requirements

⚠ CAUTION

Electrode damage can result in the complete failure of the device!

- ▶ Same electrical potential for the medium and sensor
- ▶ Remote version: same electrical potential for the sensor and transmitter
- ▶ Company-internal grounding concepts
- ▶ Pipe material and grounding

Connection example, standard scenario

Metal, grounded pipe

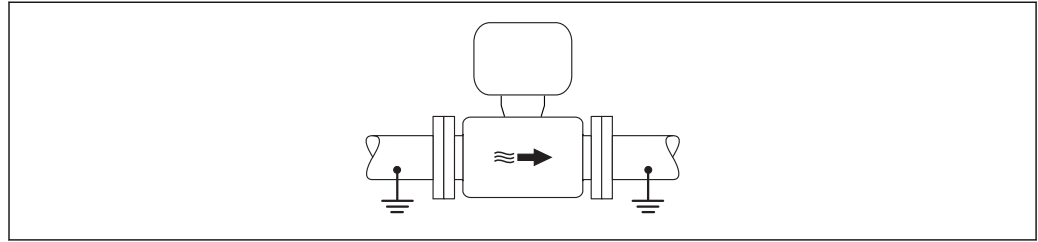

A0016315

20 Potential equalization via measuring tube

Connection example in special situations

Unlined and ungrounded metal pipe

This connection method also applies in situations where:

- The customary potential equalization is not used
- Equalizing currents are present

Ground cable	Copper wire, at least 6 mm ² (0.0093 in ²)
---------------------	---

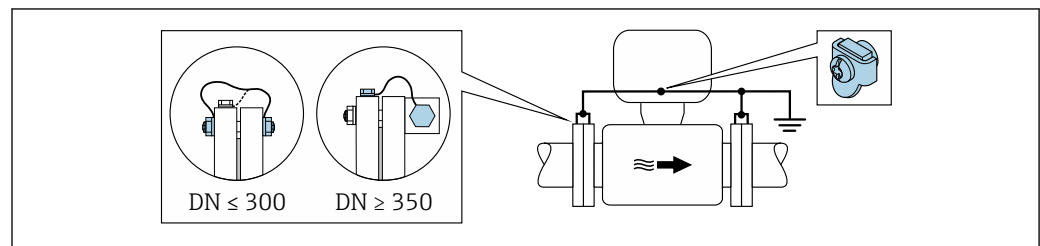

A0029338

21 Potential equalization via ground terminal and pipe flanges

1. Connect both sensor flanges to the pipe flange via a ground cable and ground them.
2. If $DN \leq 300$ (12"): Mount the ground cable directly on the conductive flange coating of the sensor with the flange screws.
3. If $DN \geq 350$ (14"): Mount the ground cable directly on the metal transport bracket. Observe screw tightening torques: see the Sensor Brief Operating Instructions.
4. Connect the connection housing of the transmitter or sensor to ground potential by means of the ground terminal provided for the purpose.

i For remote device versions, the ground terminal in the example always refers to the sensor and **not** to the transmitter.

Plastic pipe or pipe with insulating liner

This connection method also applies in situations where:

- The customary potential equalization is not used
- Equalizing currents are present

Ground cable	Copper wire, at least 6 mm ² (0.0093 in ²)
---------------------	---

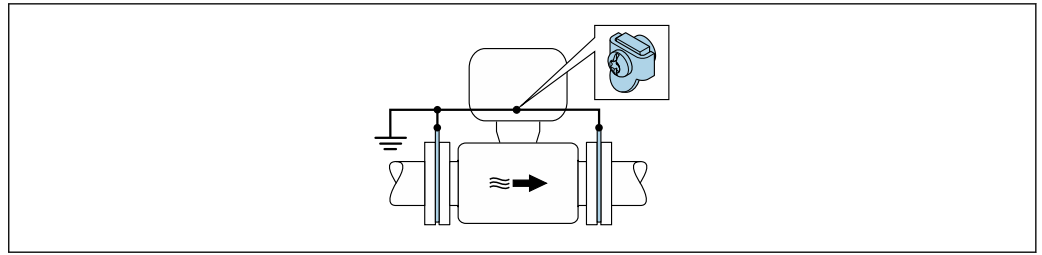

A0029339

22 Potential equalization via ground terminal and ground disks

1. Connect the ground disks to the ground terminal via the ground cable.
2. Connect the ground disks to ground potential.

i For remote device versions, the ground terminal in the example always refers to the sensor and **not** to the transmitter.

Pipe with a cathodic protection unit

This connection method is only used if the following two conditions are met:

- Metal pipe without liner or pipe with electrically conductive liner
- Cathodic protection is integrated in the personal protection equipment

Ground cable	Copper wire, at least 6 mm ² (0.0093 in ²)
---------------------	---

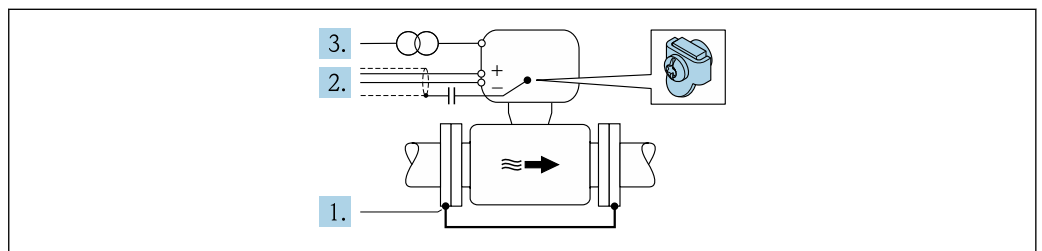

A0029340

Prerequisite: The sensor is installed in the pipe in a way that provides electrical insulation.

1. Connect the two flanges of the pipe to one another via a ground cable.
2. Guide the shield of the signal lines through a capacitor.
3. Connect the measuring device to the power supply such that it is floating in relation to the protective ground (isolation transformer).

i For remote device versions, the ground terminal in the example always refers to the sensor and **not** to the transmitter.

7.3 Special connection instructions

7.3.1 Connection examples

Current output 4 to 20 mA HART

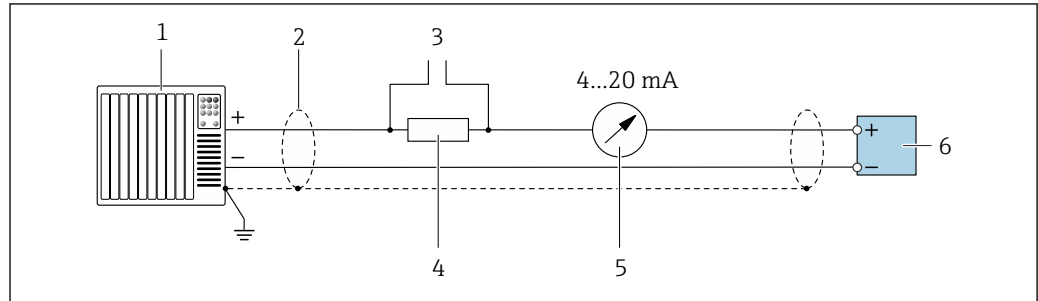

A0029055

23 Connection example for 4 to 20 mA HART current output (active)

- 1 Automation system with current input (e.g. PLC)
- 2 Cable shield: the cable shield must be grounded at both ends to comply with EMC requirements; observe cable specifications
- 3 Connection for HART operating devices
- 4 Resistor for HART communication ($\geq 250 \Omega$): observe maximum load → 157
- 5 Analog display unit: observe maximum load → 157
- 6 Transmitter

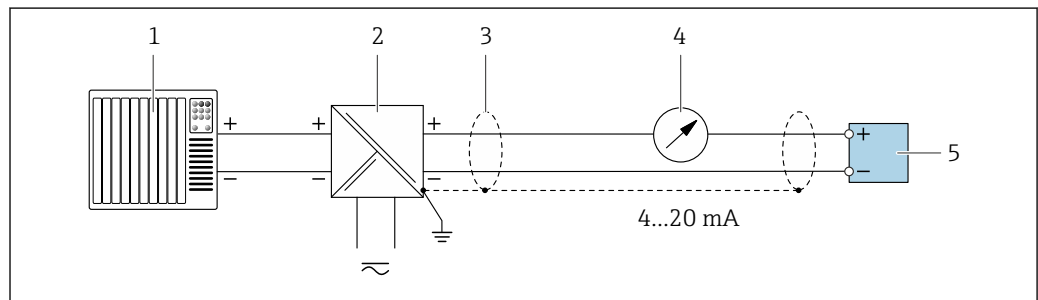

A0028762

24 Connection example for 4 to 20 mA HART current output (passive)

- 1 Automation system with current input (e.g. PLC)
- 2 Power supply
- 3 Cable shield: the cable shield must be grounded at both ends to comply with EMC requirements; observe cable specifications
- 4 Analog display unit: observe maximum load → 157
- 5 Transmitter

Pulse/frequency output

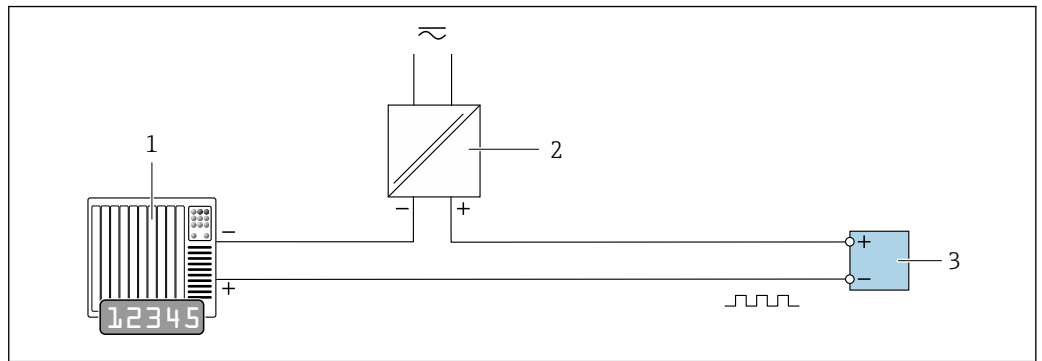

A0028761

- 25 Connection example for pulse/frequency output (passive)
- 1 Automation system with pulse/frequency input (e.g. PLC)
- 2 Power supply
- 3 Transmitter: Observe input values → 158

Switch output

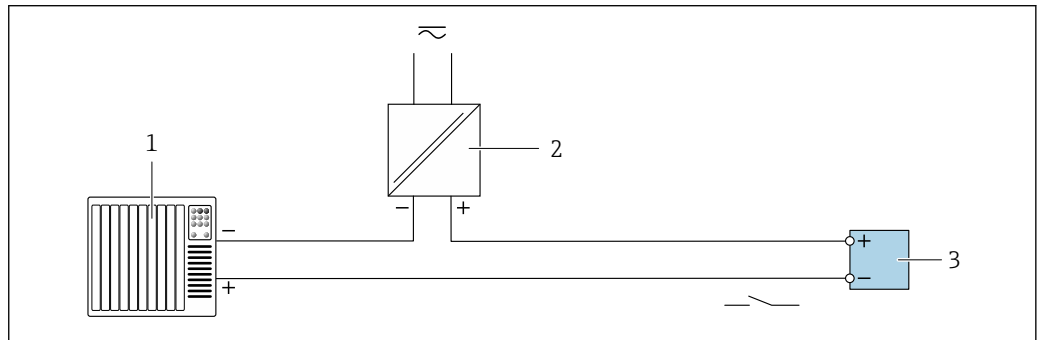

A0028760

- 26 Connection example for switch output (passive)
- 1 Automation system with switch input (e.g. PLC)
- 2 Power supply
- 3 Transmitter: Observe input values → 158

Status input

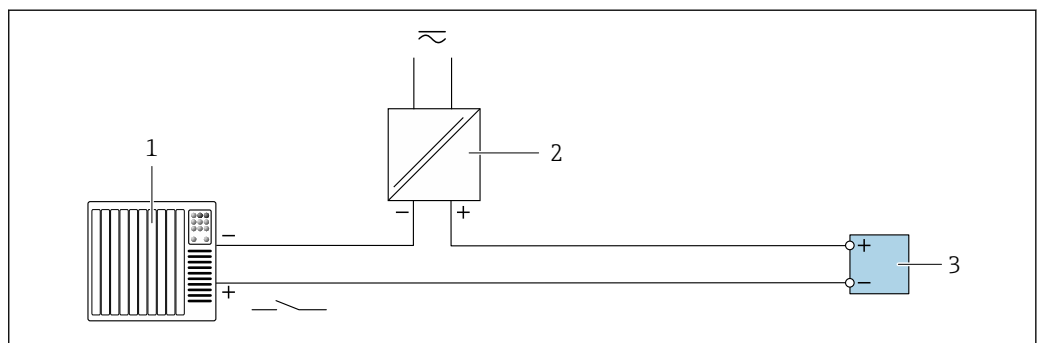

A0028764

- 27 Connection example for status input
- 1 Automation system with status output (e.g. PLC)
- 2 Power supply
- 3 Transmitter: Observe input values

7.4 Ensuring the degree of protection

7.4.1 Degree of protection IP66/67, Type 4X enclosure

The measuring device fulfills all the requirements for the IP66/67 degree of protection, Type 4X enclosure.

To guarantee IP66/67 degree of protection, Type 4X enclosure, carry out the following steps after the electrical connection:

1. Check that the housing seals are clean and fitted correctly. Dry, clean or replace the seals if necessary.
2. Tighten all housing screws and screw covers.
3. Firmly tighten the cable glands.
4. To ensure that moisture does not enter the cable entry, route the cable so that it loops down before the cable entry ("water trap").

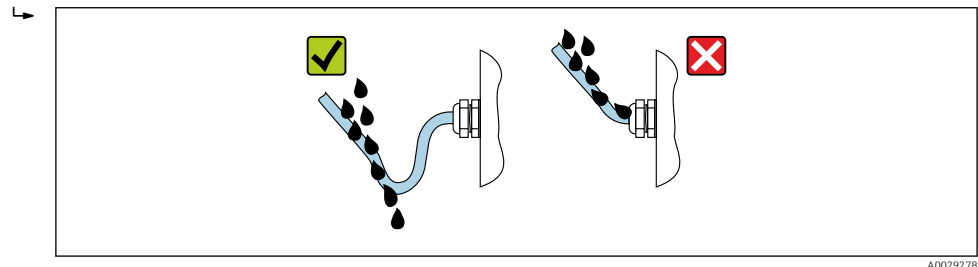

A0029278

5. Insert dummy plugs into unused cable entries.

7.4.2 Degree of protection IP68, Type 6P enclosure, with "Cust-potted" option

Depending on the version, the sensor fulfills all the requirements for the IP68 degree of protection, Type 6P enclosure and can be used as a remote version → 26.

The degree of protection of the transmitter is always only IP66/67, Type 4X enclosure and the transmitter must therefore be treated accordingly → 54.

To guarantee IP68 degree of protection, Type 6P enclosure for the "Cust-potted" options, carry out the following steps after the electrical connection:

1. Firmly tighten the cable glands (torque: 2 to 3.5 Nm) until there is no gap between the bottom of the cover and the housing support surface.
2. Firmly tighten the union nut of the cable glands.
3. Pot the field housing with a potting compound.
4. Check that the housing seals are clean and fitted correctly. Dry, clean or replace the seals if necessary.
5. Tighten all housing screws and screw covers (torque: 20 to 30 Nm).

7.5 Post-connection check

Are cables or the device undamaged (visual inspection)?	<input type="checkbox"/>
Do the cables used meet the requirements → 41?	<input type="checkbox"/>
Do the cables have adequate strain relief?	<input type="checkbox"/>
Are all the cable glands installed, firmly tightened and leak-tight? Cable run with "water trap" → 54?	<input type="checkbox"/>

Only for remote version: is the sensor connected to the right transmitter? Check the serial number on the nameplate of the sensor and transmitter.	<input type="checkbox"/>
Does the supply voltage match the specifications on the transmitter nameplate → 44?	<input type="checkbox"/>
Is the terminal assignment correct → 43?	<input type="checkbox"/>
If supply voltage is present, do values appear on the display module?	<input type="checkbox"/>
Is the potential equalization established correctly ?	<input type="checkbox"/>
Are all housing covers installed and the screws tightened with the correct tightening torque?	<input type="checkbox"/>

8 Operation options

8.1 Overview of operation options

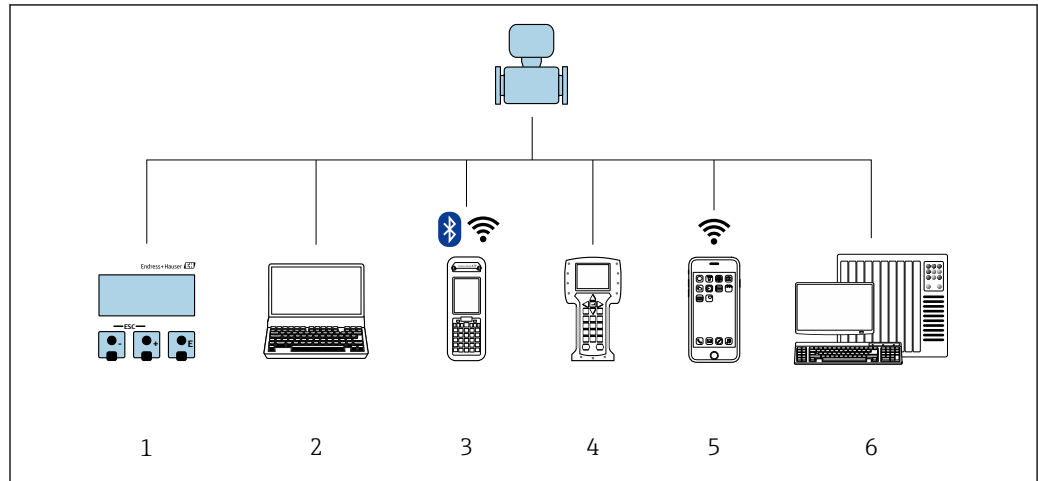



A0029295

- 1 Local operation via display module
- 2 Computer with Web browser (e.g. Internet Explorer) or with operating tool (e.g. FieldCare, DeviceCare, AMS Device Manager, SIMATIC PDM)
- 3 Field Xpert SFX350 or SFX370
- 4 Field Communicator 475
- 5 Mobile handheld terminal
- 6 Control system (e.g. PLC)

i For custody transfer, once the device has been put into circulation or sealed, its operation is restricted.

8.2 Structure and function of the operating menu

8.2.1 Structure of the operating menu

 For an overview of the operating menu for experts: "Description of Device Parameters" document supplied with the device →  197

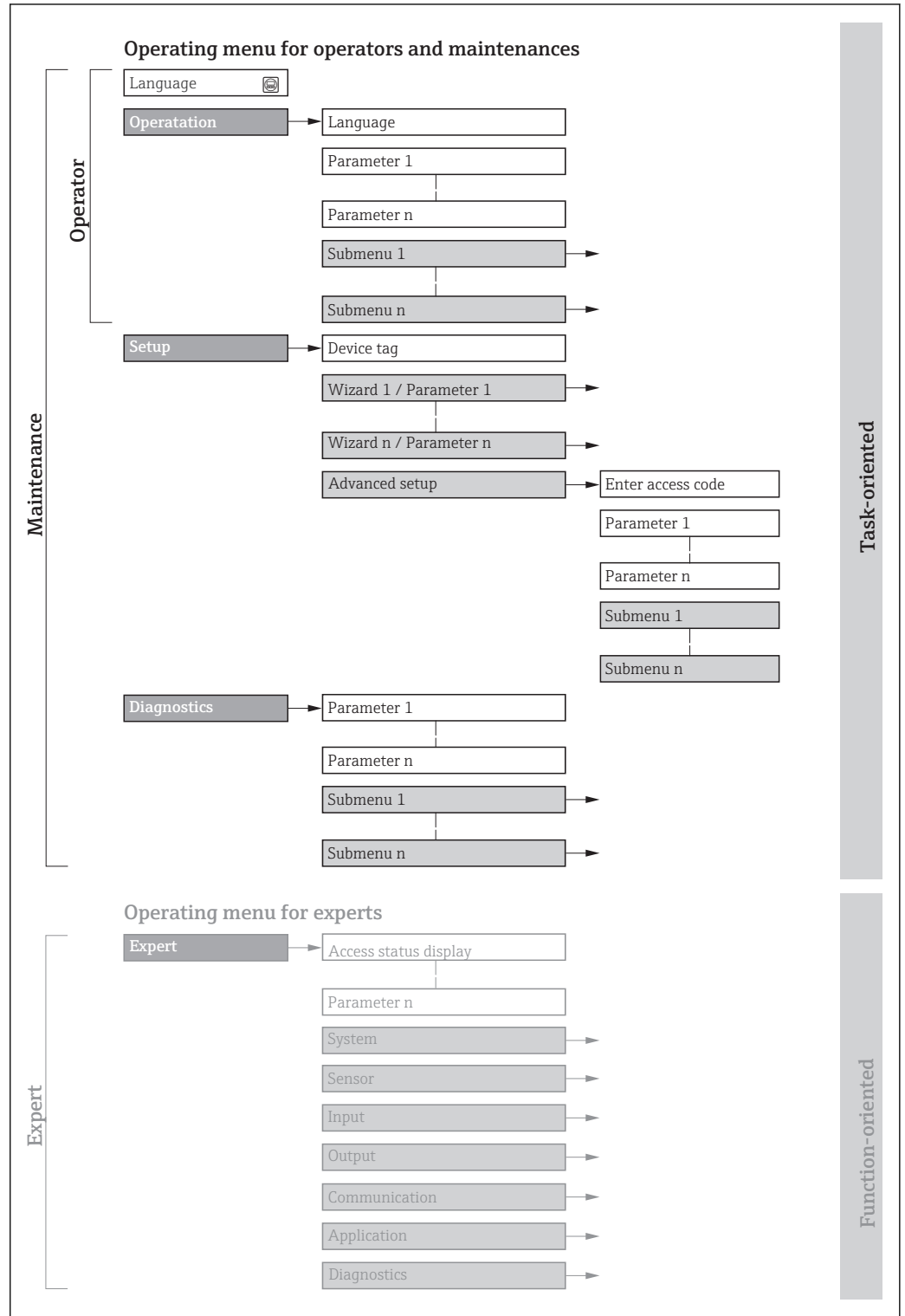

 28 Schematic structure of the operating menu

A0018237-EN

8.2.2 Operating philosophy

The individual parts of the operating menu are assigned to certain user roles (operator, maintenance etc.). Each user role contains typical tasks within the device lifecycle.

 For custody transfer, once the device has been put into circulation or sealed, its operation is restricted.

Menu/parameter		User role and tasks	Content/meaning
Language	task-oriented	Role "Operator", "Maintenance" Tasks during operation: <ul style="list-style-type: none"> ▪ Configuring the operational display ▪ Reading measured values 	<ul style="list-style-type: none"> ▪ Defining the operating language ▪ Defining the Web server operating language ▪ Resetting and controlling totalizers
Operation			<ul style="list-style-type: none"> ▪ Configuring the operational display (e.g. display format, display contrast) ▪ Resetting and controlling totalizers
Setup		"Maintenance" role Commissioning: <ul style="list-style-type: none"> ▪ Configuration of the measurement ▪ Configuration of the outputs 	Wizards for fast commissioning: <ul style="list-style-type: none"> ▪ Set the system units ▪ Set the input ▪ Configure the outputs ▪ Configuring the operational display ▪ Define the output conditioning ▪ Set the low flow cut off ▪ Configure empty pipe detection Advanced setup <ul style="list-style-type: none"> ▪ For more customized configuration of the measurement (adaptation to special measuring conditions) ▪ Configuration of totalizers ▪ Configuration of electrode cleaning (optional) ▪ Configure the WLAN settings ▪ Administration (define access code, reset measuring device)
Diagnostics		"Maintenance" role Fault elimination: <ul style="list-style-type: none"> ▪ Diagnostics and elimination of process and device errors ▪ Measured value simulation 	Contains all parameters for error detection and analyzing process and device errors: <ul style="list-style-type: none"> ▪ Diagnostic list Contains up to 5 currently pending diagnostic messages. ▪ Event logbook Contains event messages that have occurred. ▪ Device information Contains information for identifying the device. ▪ Measured values Contains all current measured values. ▪ Data logging submenu with "Extended HistoROM" order option Storage and visualization of measured values ▪ Heartbeat The functionality of the device is checked on demand and the verification results are documented. ▪ Simulation Is used to simulate measured values or output values.

Menu/parameter		User role and tasks	Content/meaning
Expert	function-oriented	<p>Tasks that require detailed knowledge of the function of the device:</p> <ul style="list-style-type: none"> ▪ Commissioning measurements under difficult conditions ▪ Optimal adaptation of the measurement to difficult conditions ▪ Detailed configuration of the communication interface ▪ Error diagnostics in difficult cases 	<p>Contains all the parameters of the device and makes it possible to access these parameters directly using an access code. The structure of this menu is based on the function blocks of the device:</p> <ul style="list-style-type: none"> ▪ System Contains all higher-order device parameters which do not concern the measurement or the communication interface. ▪ Sensor Configuration of the measurement. ▪ Input Configuring the status input. ▪ Output Configuring of the analog current outputs as well as the pulse/frequency and switch output. ▪ Communication Configuration of the digital communication interface and the Web server. ▪ Application Configure the functions that go beyond the actual measurement (e.g. totalizer). ▪ Diagnostics Error detection and analysis of process and device errors and for device simulation and Heartbeat Technology.

8.3 Access to the operating menu via the local display

8.3.1 Operational display

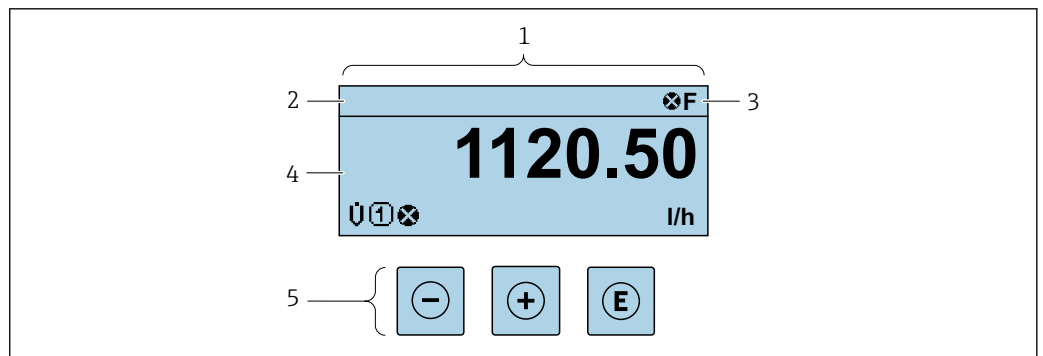

- 1 Operational display
- 2 Device tag → 88
- 3 Status area
- 4 Display area for measured values (4-line)
- 5 Operating elements → 64

Status area

The following symbols appear in the status area of the operational display at the top right:







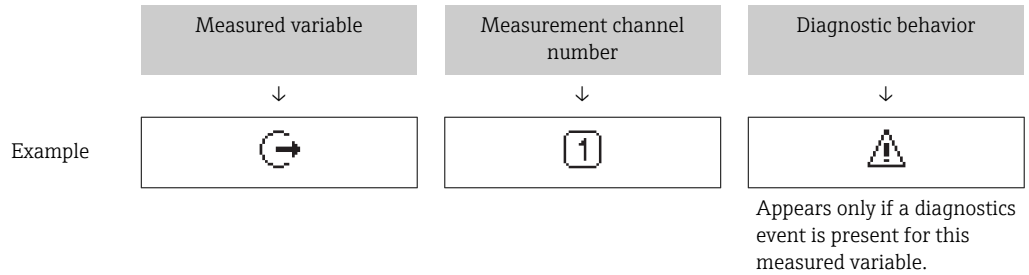

- Status signals → 131
 - F: Failure
 - C: Function check
 - S: Out of specification
 - M: Maintenance required
- Diagnostic behavior → 132
 - ☒: Alarm
 - ⚠: Warning
- 🔒: Locking (the device is locked via the hardware)
- ↔: Communication (communication via remote operation is active)

Display area

In the display area, each measured value is prefaced by certain symbol types for further description:



Measured values



Symbol	Meaning
	Volume flow
	Conductivity
	Mass flow
	Totalizer  The measurement channel number indicates which of the three totalizers is displayed.
	Output  The measurement channel number indicates which of the outputs is displayed.
	Status input

Measurement channel numbers

Symbol	Meaning
	Measurement channel 1 to 4
The measurement channel number is displayed only if more than one channel is present for the same measured variable type (e.g. Totalizer 1 to 3).	

Diagnostic behavior

The diagnostic behavior pertains to a diagnostic event that is relevant to the displayed measured variable. For information on the symbols →  132

 The number and display format of the measured values can be configured via the **Format display** parameter (→  99).

8.3.2 Navigation view

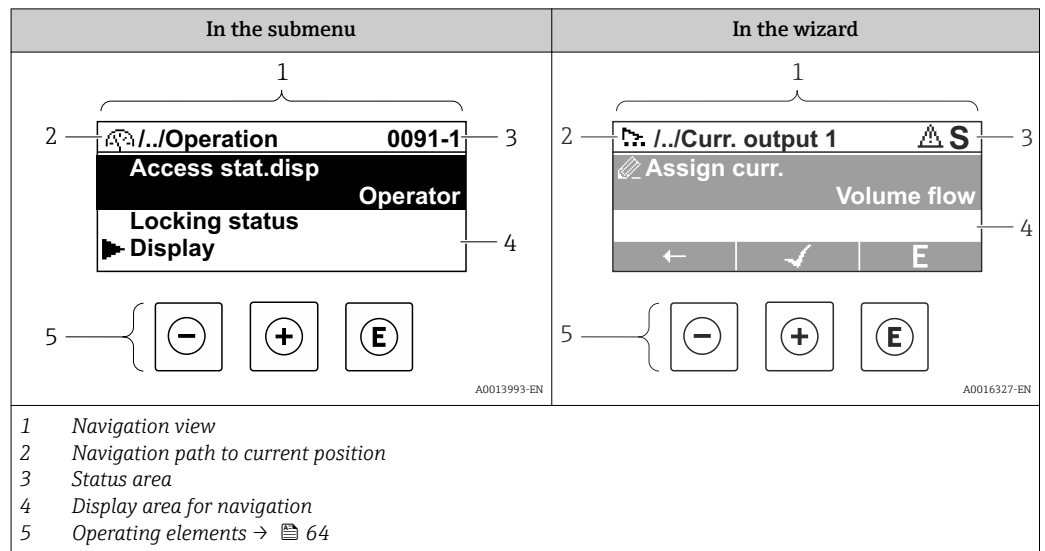

Navigation path

The navigation path - displayed at the top left in the navigation view - consists of the following elements:

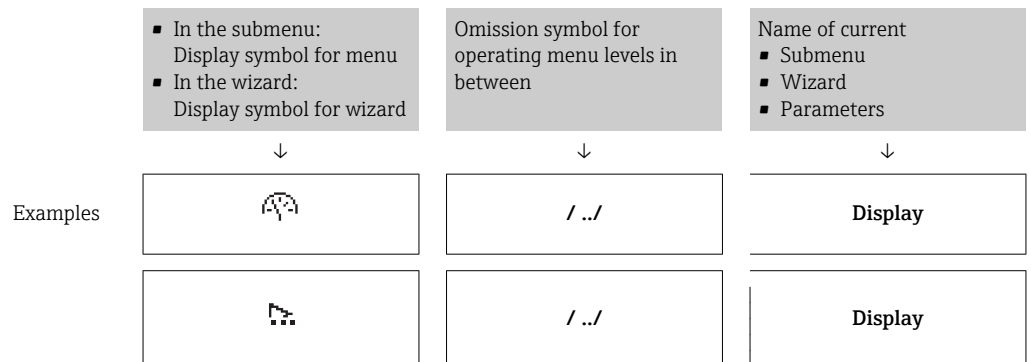

For more information about the icons in the menu, refer to the "Display area" section → 62

Status area





The following appears in the status area of the navigation view in the top right corner:

- In the submenu
 - The direct access code for the parameter you are navigating to (e.g. 0022-1)
 - If a diagnostic event is present, the diagnostic behavior and status signal
- In the wizard
 - If a diagnostic event is present, the diagnostic behavior and status signal





▪ For information on the diagnostic behavior and status signal → 131
 ▪ For information on the function and entry of the direct access code → 67

Display area

Menus

Symbol	Meaning
	Operation Appears: <ul style="list-style-type: none"> In the menu next to the "Operation" selection At the left in the navigation path in the Operation menu
	Setup Appears: <ul style="list-style-type: none"> In the menu next to the "Setup" selection At the left in the navigation path in the Setup menu
	Diagnostics Appears: <ul style="list-style-type: none"> In the menu next to the "Diagnostics" selection At the left in the navigation path in the Diagnostics menu
	Expert Appears: <ul style="list-style-type: none"> In the menu next to the "Expert" selection At the left in the navigation path in the Expert menu



Submenus, wizards, parameters

Symbol	Meaning
	Submenu
	Wizard
	Parameters within a wizard  No display symbol exists for parameters in submenus.

Locking

Symbol	Meaning
	Parameter locked When displayed in front of a parameter name, indicates that the parameter is locked. <ul style="list-style-type: none"> By a user-specific access code By the hardware write protection switch

Wizard operation

Symbol	Meaning
	Switches to the previous parameter.
	Confirms the parameter value and switches to the next parameter.
	Opens the editing view of the parameter.

8.3.3 Editing view

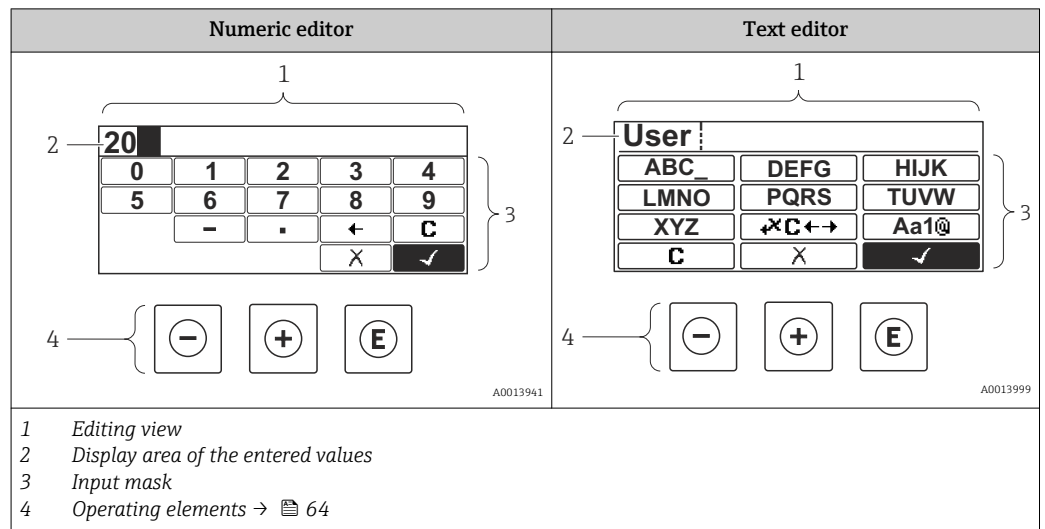

Input mask









The following input symbols are available in the input mask of the numeric and text editor:

Numeric editor



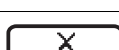

Symbol	Meaning
0 ... 9	Selection of numbers from 0 to 9.
.	Inserts decimal separator at the input position.
-	Inserts minus sign at the input position.
✓	Confirms selection.
←	Moves the input position one position to the left.
X	Exits the input without applying the changes.
C	Clears all entered characters.

Text editor

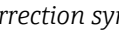

Symbol	Meaning
Aa1@ ... XYZ	Toggle <ul style="list-style-type: none"> Between upper-case and lower-case letters For entering numbers For entering special characters
ABC_ ... XYZ	Selection of letters from A to Z.

 	Selection of letters from a to z.
 	Selection of special characters.
	Confirms selection.
	Switches to the selection of the correction tools.
	Exits the input without applying the changes.
	Clears all entered characters.

Correction symbols under 

Symbol	Meaning
	Clears all entered characters.
	Moves the input position one position to the right.
	Moves the input position one position to the left.
	Deletes one character immediately to the left of the input position.

8.3.4 Operating elements

Operating key(s)	Meaning
	<p>Minus key</p> <p><i>In a menu, submenu</i> Moves the selection bar upwards in a choose list.</p> <p><i>With a Wizard</i> Confirms the parameter value and goes to the previous parameter.</p> <p><i>With a text and numeric editor</i> In the input screen, moves the selection bar to the left (backwards).</p>
	<p>Plus key</p> <p><i>In a menu, submenu</i> Moves the selection bar downwards in a choose list.</p> <p><i>With a Wizard</i> Confirms the parameter value and goes to the next parameter.</p> <p><i>With a text and numeric editor</i> Moves the selection bar to the right (forwards) in an input screen.</p>

Operating key(s)	Meaning
Ⓔ	<p>Enter key</p> <p><i>For operational display</i></p> <ul style="list-style-type: none"> ■ Pressing the key briefly opens the operating menu. ■ Pressing the key for 2 s opens the context menu including the option for activating the keypad lock. <p><i>In a menu, submenu</i></p> <ul style="list-style-type: none"> ■ Pressing the key briefly: <ul style="list-style-type: none"> - Opens the selected menu, submenu or parameter. - Starts the wizard. - If help text is open, closes the help text of the parameter. ■ Pressing the key for 2 s for parameter: <ul style="list-style-type: none"> - If present, opens the help text for the function of the parameter. <p><i>With a Wizard</i></p> <p>Opens the editing view of the parameter.</p> <p><i>With a text and numeric editor</i></p> <ul style="list-style-type: none"> ■ Pressing the key briefly: <ul style="list-style-type: none"> - Opens the selected group. - Carries out the selected action. ■ Pressing the key for 2 s confirms the edited parameter value.
⊖ + ⊕	<p>Escape key combination (press keys simultaneously)</p> <p><i>In a menu, submenu</i></p> <ul style="list-style-type: none"> ■ Pressing the key briefly: <ul style="list-style-type: none"> - Exits the current menu level and takes you to the next higher level. - If help text is open, closes the help text of the parameter. ■ Pressing the key for 2 s returns you to the operational display ("home position"). <p><i>With a Wizard</i></p> <p>Exits the wizard and takes you to the next higher level.</p> <p><i>With a text and numeric editor</i></p> <p>Closes the text or numeric editor without applying changes.</p>
⊖ + Ⓔ	<p>Minus/Enter key combination (press the keys simultaneously)</p> <p>Press the key for 3 s: deactivate the keypad lock.</p>
⊖ + ⊕ + Ⓔ	<p>Minus/Plus/Enter key combination (press the keys simultaneously)</p> <p><i>For operational display</i></p> <p>Enables or disables the keypad lock (only SD02 display module).</p>

8.3.5 Opening the context menu

Using the context menu, the user can call up the following menus quickly and directly from the operational display:

- Setup
- Simulation

Calling up and closing the context menu

The user is in the operational display.

1. Press Ⓔ for 2 s.
 - ↳ The context menu opens.

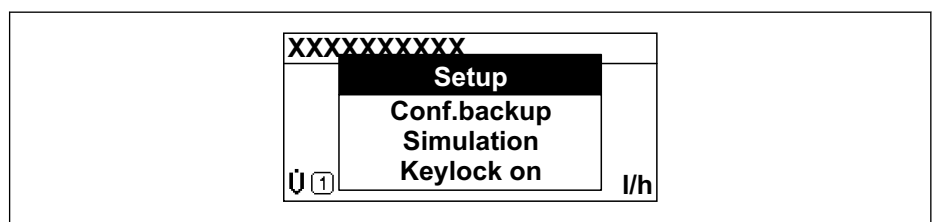

2. Press ⊖ + ⊕ simultaneously.
 - ↳ The context menu is closed and the operational display appears.

Calling up the menu via the context menu

1. Open the context menu.
2. Press \oplus to navigate to the desired menu.
3. Press \boxtimes to confirm the selection.
 - ↳ The selected menu opens.

8.3.6 Navigating and selecting from list

Different operating elements are used to navigate through the operating menu. The navigation path is displayed on the left in the header. Icons are displayed in front of the individual menus. These icons are also shown in the header during navigation.

i For an explanation of the navigation view with symbols and operating elements → 61

Example: Setting the number of displayed measured values to "2 values"

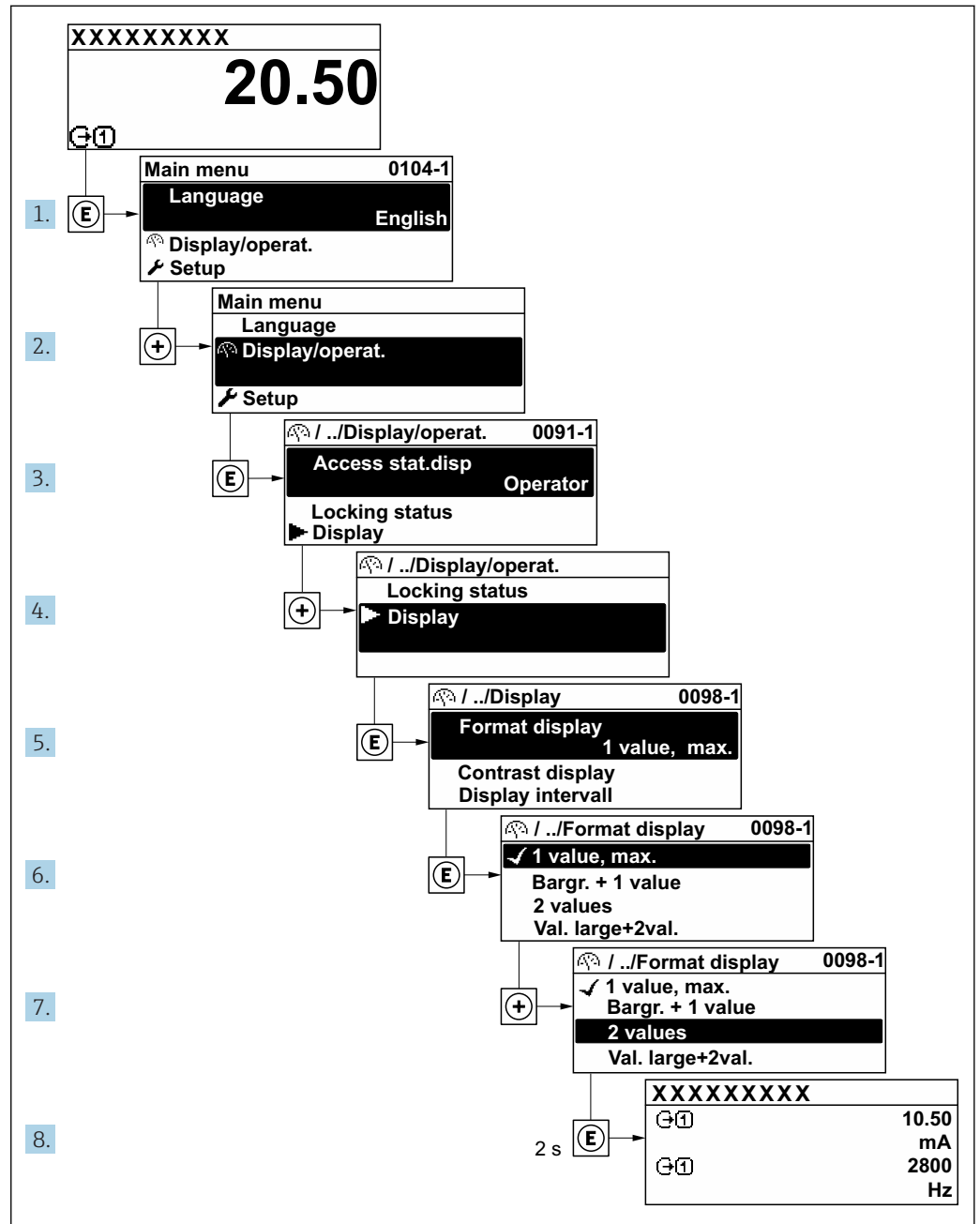

A0029562-EN

8.3.7 Calling the parameter directly

A parameter number is assigned to every parameter to be able to access a parameter directly via the onsite display. Entering this access code in the **Direct access** parameter calls up the desired parameter directly.

Navigation path

Expert → Direct access

The direct access code consists of a 5-digit number (at maximum) and the channel number, which identifies the channel of a process variable: e.g. 00914-2. In the navigation view, this appears on the right-hand side in the header of the selected parameter.

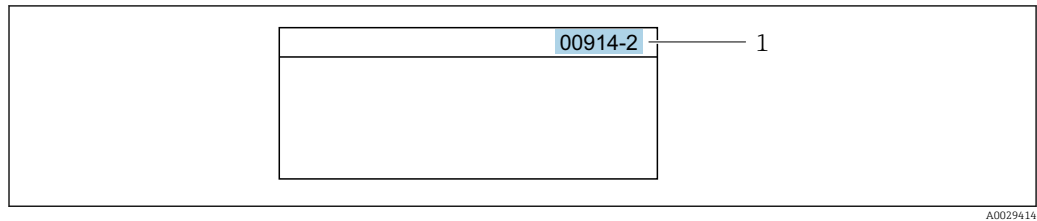

1 Direct access code

Note the following when entering the direct access code:

- The leading zeros in the direct access code do not have to be entered.
Example: Enter "914" instead of "00914"
- If no channel number is entered, channel 1 is accessed automatically.
Example: Enter 00914 → **Assign process variable** parameter
- If a different channel is accessed: Enter the direct access code with the corresponding channel number.
Example: Enter 00914-2 → **Assign process variable** parameter



For the direct access codes of the individual parameters, see the "Description of Device Parameters" document for the device

8.3.8 Calling up help text

Help text is available for some parameters and can be called up from the navigation view. The help text provides a brief explanation of the parameter function and thereby supports swift and safe commissioning.



Calling up and closing the help text

The user is in the navigation view and the selection bar is on a parameter.

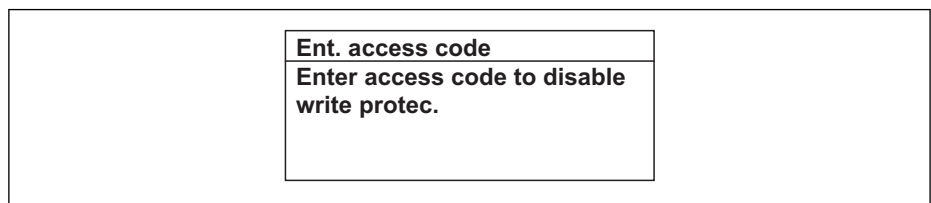
1. Press  for 2 s.
↳ The help text for the selected parameter opens.



29 Example: Help text for parameter "Enter access code"

2. Press  +  simultaneously.
↳ The help text is closed.

8.3.9 Changing the parameters

i For a description of the editing view - consisting of the text editor and numeric editor - with symbols → 63, for a description of the operating elements → 64

Example: Changing the tag name in the "Tag description" parameter from 001-FT-101 to 001-FT-102

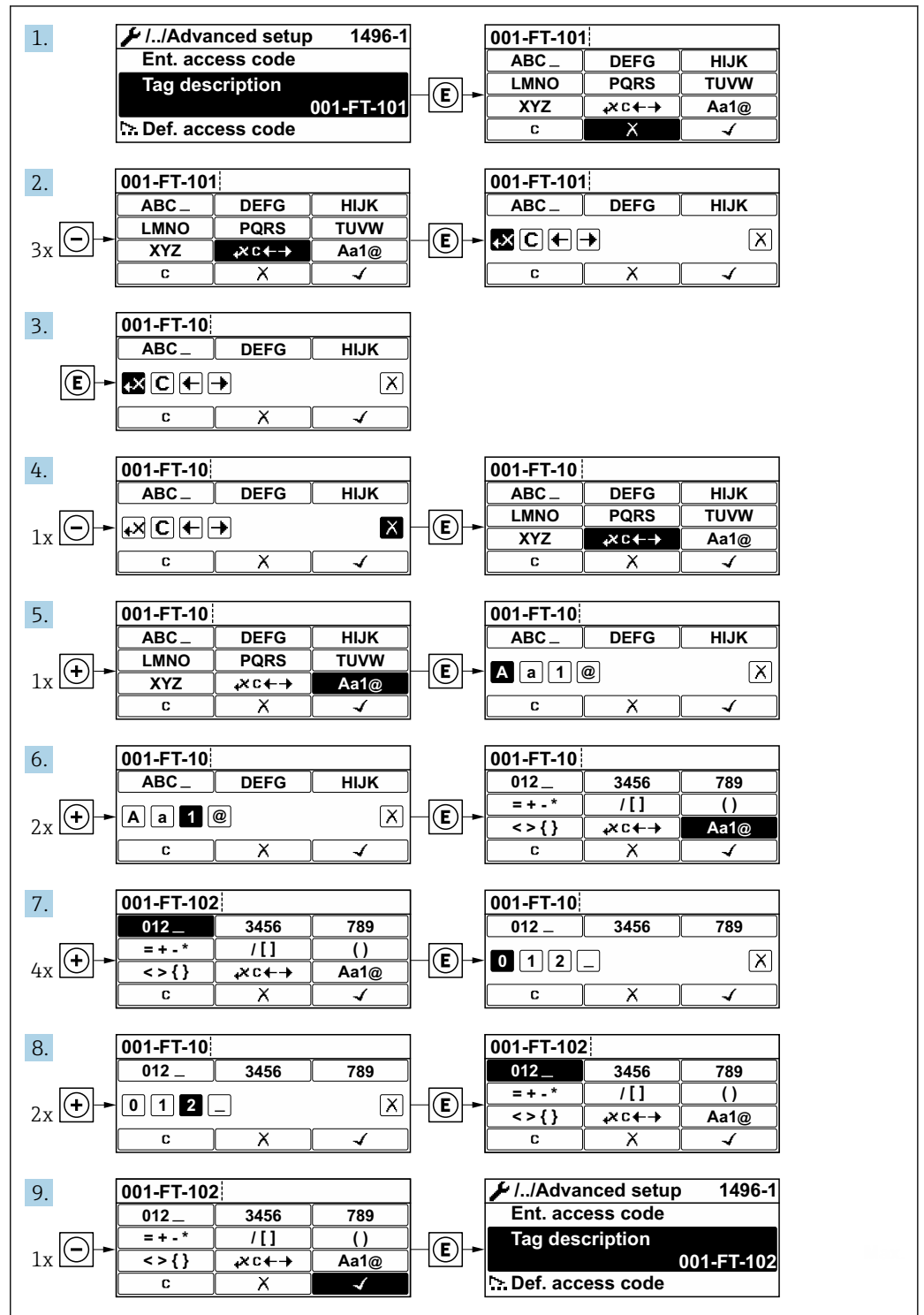

A message is displayed if the value entered is outside the permitted value range.

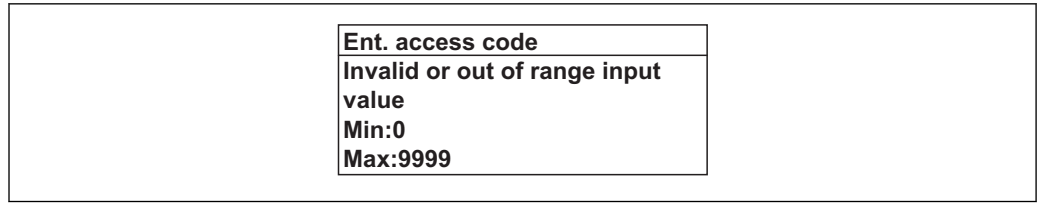

A0014049-EN

8.3.10 User roles and related access authorization

The two user roles "Operator" and "Maintenance" have different write access to the parameters if the customer defines a user-specific access code. This protects the device configuration via the local display from unauthorized access → 117.

Defining access authorization for user roles

An access code is not yet defined when the device is delivered from the factory. Access authorization (read and write access) to the device is not restricted and corresponds to the "Maintenance" user role.

- ▶ Define the access code.
 - ↳ The "Operator" user role is redefined in addition to the "Maintenance" user role. Access authorization differs for the two user roles.

Access authorization to parameters: "Maintenance" user role

Access code status	Read access	Write access
An access code has not yet been defined (factory setting).	✓	✓
After an access code has been defined.	✓	✓ ¹⁾

1) The user only has write access after entering the access code.

Access authorization to parameters: "Operator" user role

Access code status	Read access	Write access
After an access code has been defined.	✓	-- ¹⁾

1) Despite the defined access code, certain parameters can always be modified and thus are exempted from the write protection, as they do not affect the measurement. Refer to the "Write protection via access code" section

The user role with which the user is currently logged on is indicated by the **Access status display** parameter. Navigation path: Operation → Access status display

8.3.11 Disabling write protection via access code

If the -symbol appears on the local display in front of a parameter, the parameter is write-protected by a user-specific access code and its value cannot be changed at the moment using local operation → 117.

Parameter write protection via local operation can be disabled by entering the user-specific access code in the **Enter access code** parameter via the respective access option.

1. After you press , the input prompt for the access code appears.
2. Enter the access code.
 - ↳ The -symbol in front of the parameters disappears; all previously write-protected parameters are now re-enabled.

8.3.12 Enabling and disabling the keypad lock

The keypad lock makes it possible to block access to the entire operating menu via local operation. As a result, it is no longer possible to navigate through the operating menu or change the values of individual parameters. Users can only read the measured values on the operational display.

The keypad lock is switched on and off via the context menu.

Switching on the keypad lock

-  The keypad lock is switched on automatically:
- If the device has not been operated via the display for > 1 minute.
 - Each time the device is restarted.

To activate the keylock manually:

1. The device is in the measured value display.
Press  for at least 2 seconds.
↳ A context menu appears.
2. In the context menu select the **Keylock on** option.
↳ The keypad lock is switched on.

-  If the user attempts to access the operating menu while the keypad lock is active, the **Keylock on** message appears.

Switching off the keypad lock



1. The keypad lock is switched on.
Press  for at least 2 seconds.
↳ A context menu appears.
2. In the context menu select the **Keylock off** option.
↳ The keypad lock is switched off.

8.4 Access to the operating menu via the Web browser

8.4.1 Function range

Thanks to the integrated Web server, the device can be operated and configured via a Web browser and via a service interface (CDI-RJ45) or via a WLAN interface. The structure of the operating menu is the same as for the local display. In addition to the measured values, status information on the device is also displayed and allows the user to monitor the status of the device. Furthermore the device data can be managed and the network parameters can be configured.

A device that has a WLAN interface (can be ordered as an option) is required for the WLAN connection: order code for "Display", option **W1** "WLAN display": 4-line, illuminated; touch control + WLAN. The device acts as an Access Point and enables communication by computer or a mobile handheld terminal.

-  For additional information on the Web server, refer to the Special Documentation for the device →  197

8.4.2 Prerequisites



Computer hardware

Hardware	Interface	
	CDI-RJ45	WLAN
Interface	The computer must have an RJ45 interface.	The operating unit must have a WLAN interface.
Connection	Standard Ethernet cable with RJ45 connector.	Connection via Wireless LAN.
Screen	Recommended size: ≥12" (depends on the screen resolution)	

Computer software

Software	Interface	
	CDI-RJ45	WLAN
Recommended operating systems	<ul style="list-style-type: none"> ▪ Microsoft Windows 7 or higher. ▪ Mobile operating systems: <ul style="list-style-type: none"> - iOS - Android <p> Microsoft Windows XP is supported.</p>	
Web browsers supported	<ul style="list-style-type: none"> ▪ Microsoft Internet Explorer 8 or higher ▪ Microsoft Edge ▪ Mozilla Firefox ▪ Google Chrome ▪ Safari 	

Computer settings

Settings	Interface	
	CDI-RJ45	WLAN
User rights	Appropriate user rights (e.g. administrator rights) for TCP/IP and proxy server settings are necessary (for adjusting the IP address, subnet mask etc.).	
Proxy server settings of the Web browser	The Web browser setting <i>Use a Proxy Server for Your LAN</i> must be deselected .	
JavaScript	<p>JavaScript must be enabled.</p> <p> If JavaScript cannot be enabled: enter <code>http://192.168.1.212/basic.html</code> in the address line of the Web browser. A fully functional but simplified version of the operating menu structure starts in the Web browser.</p> <p> When installing a new firmware version: To enable correct data display, clear the temporary memory (cache) of the Web browser under Internet options.</p>	
Network connections	Only the active network connections to the measuring device should be used.	
	Switch off all other network connections such as WLAN.	Switch off all other network connections.

 In the event of connection problems: →  129

Measuring device: Via CDI-RJ45 service interface

Device	CDI-RJ45 service interface
Measuring device	The measuring device has an RJ45 interface.
Web server	Web server must be enabled; factory setting: ON  For information on enabling the Web server → 77

Measuring device: via WLAN interface

Device	WLAN interface
Measuring device	The measuring device has a WLAN antenna: Transmitter with integrated WLAN antenna
Web server	Web server and WLAN must be enabled; factory setting: ON  For information on enabling the Web server → 77

8.4.3 Establishing a connection

Via service interface (CDI-RJ45)

Preparing the measuring device

Configuring the Internet protocol of the computer

The following information refers to the default Ethernet settings of the device.

IP address of the device: 192.168.1.212 (factory setting)

1. Switch on the measuring device.
2. Connect to the computer using a cable .
3. If a 2nd network card is not used, close all the applications on the notebook.
 - ↳ Applications requiring Internet or a network, such as e-mail, SAP applications, Internet or Windows Explorer.
4. Close any open Internet browsers.
5. Configure the properties of the Internet protocol (TCP/IP) as defined in the table:

IP address	192.168.1.XXX; for XXX all numerical sequences except: 0, 212 and 255 → e.g. 192.168.1.213
Subnet mask	255.255.255.0
Default gateway	192.168.1.212 or leave cells empty

Via WLAN interface

Configuring the Internet protocol of the mobile terminal

NOTICE

If the WLAN connection is lost during the configuration, settings made may be lost.

- ▶ Make sure that the WLAN connection is not disconnected while configuring the device.

NOTICE

In principle, avoid simultaneous access to the measuring device via the service interface (CDI-RJ45) and the WLAN interface from the same mobile terminal. This could cause a network conflict.

- ▶ Only activate one service interface (CDI-RJ45 service interface or WLAN interface).
- ▶ If simultaneous communication is necessary: configure different IP address ranges, e.g. 192.168.0.1 (WLAN interface) and 192.168.1.212 (CDI-RJ45 service interface).

Preparing the mobile terminal

- ▶ Enable WLAN reception on the mobile terminal.

Establishing a connection from the mobile terminal to the measuring device

1. In the WLAN settings of the mobile terminal:
Select the measuring device using the SSID (e.g. EH_Promag__A802000).
2. If necessary, select the WPA2 encryption method.
3. Enter the password: serial number of the measuring device ex-works (e.g. L100A802000).
 - ↳ LED on display module flashes: it is now possible to operate the measuring device with the Web browser, FieldCare or DeviceCare.



The serial number can be found on the nameplate.



To ensure the safe and swift assignment of the WLAN network to the measuring point, it is advisable to change the SSID name. It should be possible to clearly assign the new SSID name to the measuring point (e.g. tag name) because it is displayed as the WLAN network.

Disconnecting

- ▶ After configuring the device:
Terminate the WLAN connection between the operating unit and measuring device.

Starting the Web browser

1. Start the Web browser on the computer.

2. Enter the IP address of the Web server in the address line of the Web browser:
192.168.1.212
↳ The login page appears.

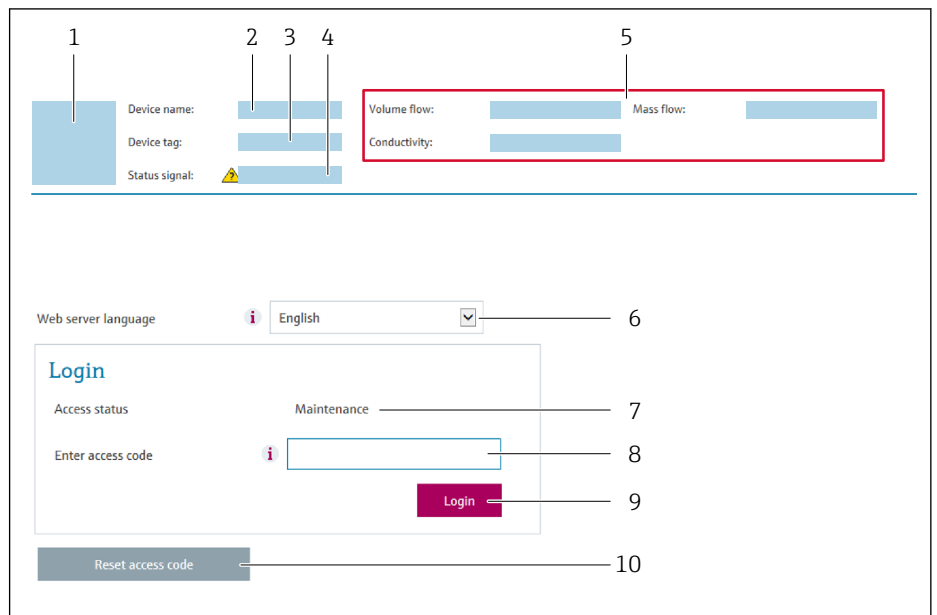

A0029417

- 1 Picture of device
- 2 Device name
- 3 Device tag (→ ⓘ 89)
- 4 Status signal
- 5 Current measured values
- 6 Operating language
- 7 User role
- 8 Access code
- 9 Login
- 10 Reset access code (→ ⓘ 114)

i If a login page does not appear, or if the page is incomplete → ⓘ 129

8.4.4 Logging on

1. Select the preferred operating language for the Web browser.
2. Enter the user-specific access code.
3. Press **OK** to confirm your entry.

Access code	0000 (factory setting); can be changed by customer
--------------------	--

i If no action is performed for 10 minutes, the Web browser automatically returns to the login page.

8.4.5 User interface

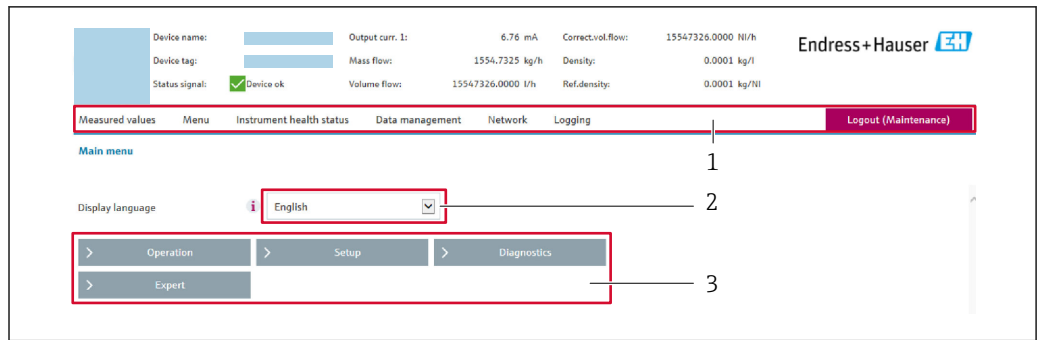

A0029418

- 1 Function row
- 2 Local display language
- 3 Navigation area

Header

The following information appears in the header:

- Device tag
- Device status with status signal → 134
- Current measured values

Function row

Functions	Meaning
Measured values	Displays the measured values of the measuring device
Menu	<ul style="list-style-type: none"> ■ Access to the operating menu from the measuring device ■ The structure of the operating menu is the same as for the local display  For detailed information on the structure of the operating menu, see the Operating Instructions for the measuring device
Device status	Displays the diagnostic messages currently pending, listed in order of priority
Data management	Data exchange between PC and measuring device: <ul style="list-style-type: none"> ■ Device configuration: <ul style="list-style-type: none"> - Load settings from the device (XML format, save configuration) - Save settings to the device (XML format, restore configuration) ■ Logbook - Export Event logbook (.csv file) ■ Documents - Export documents: <ul style="list-style-type: none"> - Export backup data record (.csv file, create documentation of the measuring point configuration) - Verification report (PDF file, only available with the "Heartbeat Verification" application package)
Network configuration	Configuration and checking of all the parameters required for establishing the connection to the measuring device: <ul style="list-style-type: none"> ■ Network settings (e.g. IP address, MAC address) ■ Device information (e.g. serial number, firmware version)
Logout	End the operation and call up the login page

Navigation area

If a function is selected in the function bar, the submenus of the function open in the navigation area. The user can now navigate through the menu structure.

Working area

Depending on the selected function and the related submenus, various actions can be performed in this area:

- Configuring parameters
- Reading measured values
- Calling up help text
- Starting an upload/download

8.4.6 Disabling the Web server

The Web server of the measuring device can be switched on and off as required using the **Web server functionality** parameter.

Navigation

"Expert" menu → Communication → Web server

Parameter overview with brief description

Parameter	Description	Selection	Factory setting
Web server functionality	Switch the Web server on and off.	<ul style="list-style-type: none"> ▪ Off ▪ On 	On

Function scope of the "Web server functionality" parameter

Option	Description
Off	<ul style="list-style-type: none"> ▪ The web server is completely disabled. ▪ Port 80 is locked.
On	<ul style="list-style-type: none"> ▪ The complete functionality of the web server is available. ▪ JavaScript is used. ▪ The password is transferred in an encrypted state. ▪ Any change to the password is also transferred in an encrypted state.

Enabling the Web server

If the Web server is disabled it can only be re-enabled with the **Web server functionality** parameter via the following operating options:

- Via local display
- Via Bedientool "FieldCare"
- Via "DeviceCare" operating tool

8.4.7 Logging out

 Before logging out, perform a data backup via the **Data management** function (upload configuration from device) if necessary.

1. Select the **Logout** entry in the function row.
 - ↳ The home page with the Login box appears.
2. Close the Web browser.
3. If no longer needed:
 - Reset modified properties of the Internet protocol (TCP/IP) →  73.

8.5 Access to the operating menu via the operating tool

The structure of the operating menu in the operating tools is the same as for operation via the local display.

8.5.1 Connecting the operating tool

Via service interface (CDI-RJ45)

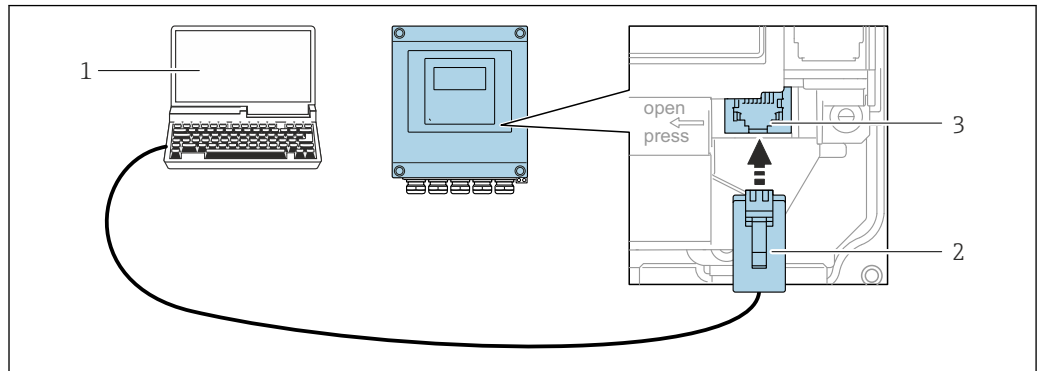

A0029163

30 Connection via service interface (CDI-RJ45)

- 1 Computer with Web browser (e.g. Microsoft Internet Explorer, Microsoft Edge) for accessing the integrated device Web server or with "FieldCare", "DeviceCare" operating tool with COM DTM "CDI Communication TCP/IP"
- 2 Standard Ethernet connecting cable with RJ45 plug
- 3 Service interface (CDI-RJ45) of the measuring device with access to the integrated Web server

Via WLAN interface

The optional WLAN interface is available on the following device version:

Order code for "Display", option **W1** "WLAN display":

4-line, illuminated, graphic display; touch control + WLAN

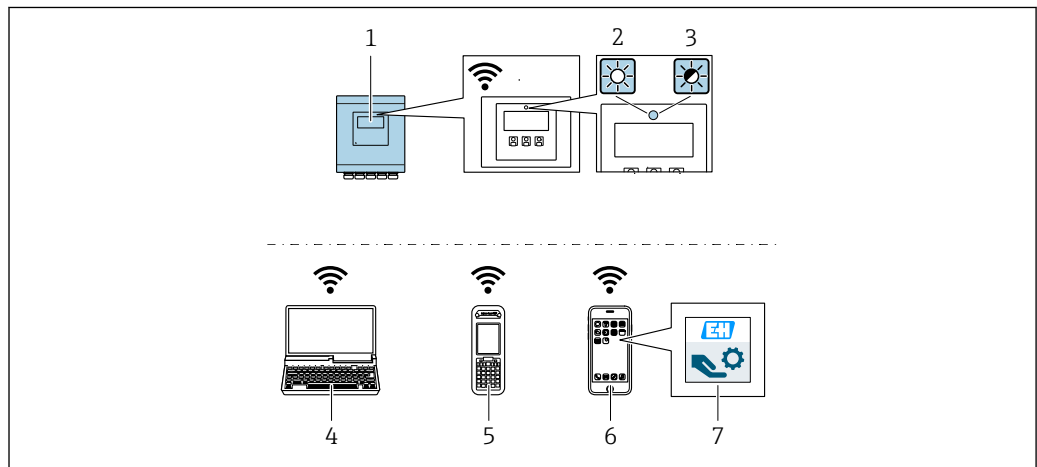

A0032079

- 1 Transmitter with integrated WLAN antenna
- 2 LED lit constantly: WLAN reception is enabled on measuring device
- 3 LED flashing: WLAN connection established between operating unit and measuring device
- 4 Computer with WLAN interface and Web browser (e.g. Microsoft Internet Explorer, Microsoft Edge) for accessing the integrated device Web server or with operating tool (e.g. FieldCare, DeviceCare)
- 5 Mobile handheld terminal with WLAN interface and Web browser (e.g. Microsoft Internet Explorer, Microsoft Edge) for accessing the integrated device Web server or operating tool (e.g. FieldCare, DeviceCare)
- 6 Smartphone or tablet
- 7 SmartBlue App

Function	WLAN: IEEE 802.11 b/g (2.4 GHz)
Encryption	WPA2-PSK/AES 128 bit
Configurable WLAN channels	1 to 11
Degree of protection	IP67

Available antennas	<ul style="list-style-type: none"> ▪ Internal antenna ▪ External antenna (optional) In the event of poor transmission/reception conditions at the place of installation. <p> Only one antenna active in each case!</p>
Max. range	50 m (164 ft)
Materials: External WLAN antenna	<ul style="list-style-type: none"> ▪ Antenna: ASA plastic (acrylic ester-styrene-acrylonitrile) and nickel-plated brass ▪ Adapter: Stainless steel and nickel-plated brass ▪ Cable: Polyethylene ▪ Connector: Nickel-plated brass ▪ Angle bracket: Stainless steel

Configuring the Internet protocol of the mobile terminal

NOTICE

If the WLAN connection is lost during the configuration, settings made may be lost.

- ▶ Make sure that the WLAN connection is not disconnected while configuring the device.

NOTICE

In principle, avoid simultaneous access to the measuring device via the service interface (CDI-RJ45) and the WLAN interface from the same mobile terminal. This could cause a network conflict.

- ▶ Only activate one service interface (CDI-RJ45 service interface or WLAN interface).
- ▶ If simultaneous communication is necessary: configure different IP address ranges, e.g. 192.168.0.1 (WLAN interface) and 192.168.1.212 (CDI-RJ45 service interface).

Preparing the mobile terminal

- ▶ Enable WLAN reception on the mobile terminal.

Establishing a connection from the mobile terminal to the measuring device

1. In the WLAN settings of the mobile terminal:
Select the measuring device using the SSID (e.g. EH_Promag__A802000).
2. If necessary, select the WPA2 encryption method.
3. Enter the password: serial number of the measuring device ex-works (e.g. L100A802000).
 - ↳ LED on display module flashes: it is now possible to operate the measuring device with the Web browser, FieldCare or DeviceCare.

 The serial number can be found on the nameplate.

 To ensure the safe and swift assignment of the WLAN network to the measuring point, it is advisable to change the SSID name. It should be possible to clearly assign the new SSID name to the measuring point (e.g. tag name) because it is displayed as the WLAN network.

Disconnecting

- ▶ After configuring the device:
Terminate the WLAN connection between the operating unit and measuring device.

8.5.2 Field Xpert SFX350, SFX370

Function range

Field Xpert SFX350 and Field Xpert SFX370 are mobile computers for commissioning and maintenance. They enable efficient device configuration and diagnostics for HART and

FOUNDATION Fieldbus devices in the **non-hazardous area** (SFX350, SFX370) and **hazardous area** (SFX370).



For details, see Operating Instructions BA01202S

Source for device description files

See information →  83

8.5.3 FieldCare

Function scope

FDT-based plant asset management tool from Endress+Hauser. It can configure all smart field devices in a system and helps you manage them. By using the status information, it is also a simple but effective way of checking their status and condition.

Access is via:

- HART protocol
- CDI-RJ45 service interface

Typical functions:

- Configuring parameters of transmitters
- Loading and saving device data (upload/download)
- Documentation of the measuring point
- Visualization of the measured value memory (line recorder) and event logbook



For additional information about FieldCare, see Operating Instructions BA00027S and BA00059S

Source for device description files

See information →  83

Establishing a connection

1. Start FieldCare and launch the project.
2. In the network: Add a device.
 - ↳ The **Add device** window opens.
3. Select the **CDI Communication TCP/IP** option from the list and press **OK** to confirm.
4. Right-click **CDI Communication TCP/IP** and select the **Add device** option in the context menu that opens.
5. Select the desired device from the list and press **OK** to confirm.
 - ↳ The **CDI Communication TCP/IP (Configuration)** window opens.
6. Enter the device address in the **IP address** field: 192.168.1.212 and press **Enter** to confirm.
7. Establish the online connection to the device.



For additional information, see Operating Instructions BA00027S and BA00059S

User interface

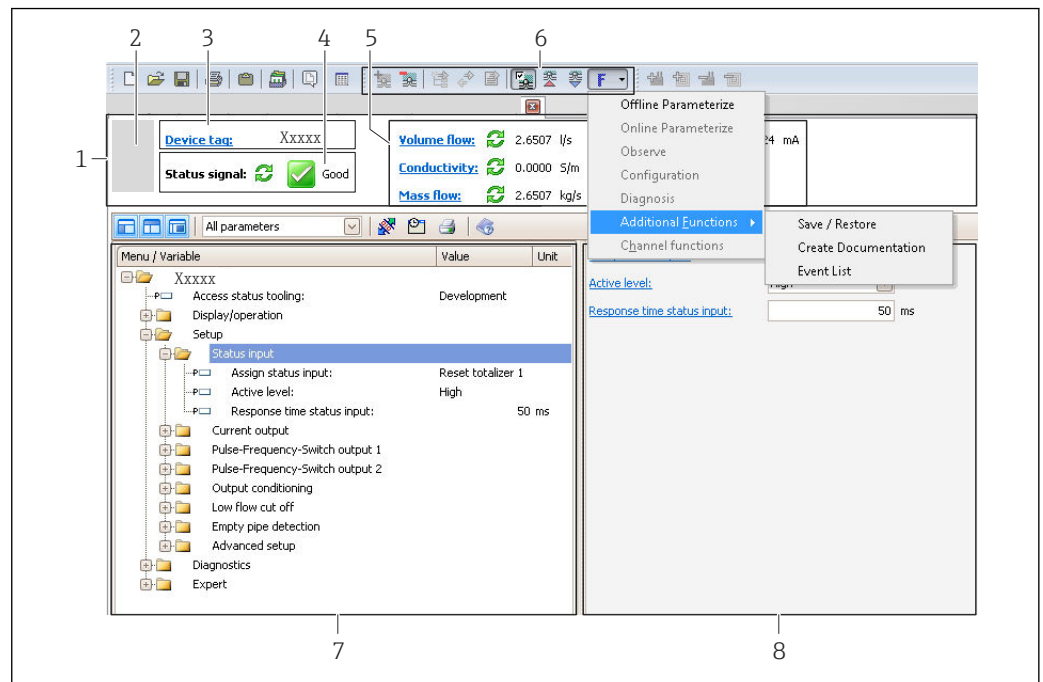

A0021053-EN

- 1 Header
- 2 Picture of device
- 3 Tag name
- 4 Status area with status signal → 134
- 6 Display area for current measured values
- 5 Edit toolbar with additional functions such as save/restore, event list and create documentation
- 7 Navigation area with operating menu structure
- 8 Working area

8.5.4 DeviceCare

Function scope

Tool to connect and configure Endress+Hauser field devices.

The fastest way to configure Endress+Hauser field devices is with the dedicated "DeviceCare" tool. Together with the device type managers (DTMs) it presents a convenient, comprehensive solution.

 For details, see Innovation Brochure IN01047S

Source for device description files

See information → 83

8.5.5 AMS Device Manager

Function scope

Program from Emerson Process Management for operating and configuring measuring devices via HART protocol.

Source for device description files

See data → 83

8.5.6 SIMATIC PDM

Function scope

SIMATIC PDM is a standardized, manufacturer-independent program from Siemens for the operation, configuration, maintenance and diagnosis of intelligent field devices via HART protocol.

Source for device description files

See data →  83

8.5.7 Field Communicator 475

Function scope

Industrial handheld terminal from Emerson Process Management for remote configuration and measured value display via HART protocol.

Source for device description files

See data →  83

9 System integration

9.1 Overview of device description files

9.1.1 Current version data for the device

Firmware version	02.00.zz	<ul style="list-style-type: none"> ▪ On the title page of the Operating instructions ▪ On the transmitter nameplate ▪ Firmware version Diagnostics → Device information → Firmware version
Release date of firmware version	11.2016	---
Manufacturer ID	0x11	Manufacturer ID Diagnostics → Device information → Manufacturer ID
Device type ID	0x69	Device type Diagnostics → Device information → Device type
HART protocol revision	7	---
Device revision	8	<ul style="list-style-type: none"> ▪ On the transmitter nameplate ▪ Device revision Diagnostics → Device information → Device revision

 For an overview of the different firmware versions for the device →  146

9.1.2 Operating tools

The suitable device description file for the individual operating tools is listed in the table below, along with information on where the file can be acquired.

Operating tool via HART protocol	Sources for obtaining device descriptions
FieldCare	<ul style="list-style-type: none"> ▪ www.endress.com → Download Area ▪ CD-ROM (contact Endress+Hauser) ▪ DVD (contact Endress+Hauser)
DeviceCare	<ul style="list-style-type: none"> ▪ www.endress.com → Download Area ▪ CD-ROM (contact Endress+Hauser) ▪ DVD (contact Endress+Hauser)
<ul style="list-style-type: none"> ▪ Field Xpert SFX350 ▪ Field Xpert SFX370 	Use update function of handheld terminal
AMS Device Manager (Emerson Process Management)	www.endress.com → Download Area
SIMATIC PDM (Siemens)	www.endress.com → Download Area
Field Communicator 475 (Emerson Process Management)	Use update function of handheld terminal

9.2 Measured variables via HART protocol

The following measured variables (HART device variables) are assigned to the dynamic variables at the factory:

Dynamic variables	Measured values (HART device variables)
Primary dynamic variable (PV)	Volume flow
Secondary dynamic variable (SV)	Totalizer 1
Tertiary dynamic variable (TV)	Totalizer 2
Quaternary dynamic variable (QV)	Totalizer 3

The assignment of the measured variables to the dynamic variables can be modified and assigned as desired via local operation and the operating tool using the following parameters:

- Expert → Communication → HART output → Output → Assign PV
- Expert → Communication → HART output → Output → Assign SV
- Expert → Communication → HART output → Output → Assign TV
- Expert → Communication → HART output → Output → Assign QV

The following measured variables can be assigned to the dynamic variables:

Measured variables for PV (primary dynamic variable)

- Off
- Volume flow
- Mass flow
- Flow velocity
- Conductivity ¹⁾
- Corrected conductivity ¹⁾
- Electronic temperature

Measured variables for SV, TV, QV (secondary, tertiary and quaternary dynamic variable)

- Volume flow
- Mass flow
- Conductivity ²⁾
- Corrected conductivity ²⁾
- Electronic temperature
- Totalizer 1
- Totalizer 2
- Totalizer 3

Device variables

The device variables are permanently assigned. A maximum of 8 device variables can be transmitted:

- 0 = volume flow
- 1 = mass flow
- 2 = corrected volume flow
- 3 = flow velocity
- 4 = conductivity
- 5 = corrected conductivity
- 6 = temperature
- 7 = electronic temperature
- 9 = totalizer 1
- 10 = totalizer 2
- 11 = totalizer 3

1) Visibility depends on order options or device settings

2) Visibility depends on order options or device settings

9.3 Other settings

Burst mode functionality in accordance with HART 7 Specification:

Navigation

"Expert" menu → Communication → HART output → Burst configuration → Burst configuration 1 to n

▶ Burst configuration

▶ Burst configuration 1 to n

Burst mode 1 to n	→ ⓘ 85
Burst command 1 to n	→ ⓘ 85
Burst variable 0	→ ⓘ 86
Burst variable 1	→ ⓘ 86
Burst variable 2	→ ⓘ 86
Burst variable 3	→ ⓘ 86
Burst variable 4	→ ⓘ 86
Burst variable 5	→ ⓘ 86
Burst variable 6	→ ⓘ 86
Burst variable 7	→ ⓘ 86
Burst trigger mode	→ ⓘ 86
Burst trigger level	→ ⓘ 86
Min. update period	→ ⓘ 86
Max. update period	→ ⓘ 86

Parameter overview with brief description

Parameter	Description	Selection / User entry	Factory setting
Burst mode 1 to n	Activate the HART burst mode for burst message X.	<ul style="list-style-type: none"> ■ Off ■ On 	Off
Burst command 1 to n	Select the HART command that is sent to the HART master.	<ul style="list-style-type: none"> ■ Command 1 ■ Command 2 ■ Command 3 ■ Command 9 ■ Command 33 ■ Command 48 	Command 2

Parameter	Description	Selection / User entry	Factory setting
Burst variable 0	For HART command 9 and 33: select the HART device variable or the process variable.	<ul style="list-style-type: none"> ■ Volume flow ■ Mass flow ■ Corrected volume flow ■ Flow velocity ■ Conductivity* ■ Corrected conductivity* ■ Electronic temperature ■ Totalizer 1 ■ Totalizer 2 ■ Totalizer 3 ■ Density ■ HART input ■ Percent of range ■ Measured current ■ Primary variable (PV) ■ Secondary variable (SV) ■ Tertiary variable (TV) ■ Quaternary variable (QV) ■ Not used 	Volume flow
Burst variable 1	For HART command 9 and 33: select the HART device variable or the process variable.	See the Burst variable 0 parameter.	Not used
Burst variable 2	For HART command 9 and 33: select the HART device variable or the process variable.	See the Burst variable 0 parameter.	Not used
Burst variable 3	For HART command 9 and 33: select the HART device variable or the process variable.	See the Burst variable 0 parameter.	Not used
Burst variable 4	For HART command 9: select the HART device variable or the process variable.	See the Burst variable 0 parameter.	Not used
Burst variable 5	For HART command 9: select the HART device variable or the process variable.	See the Burst variable 0 parameter.	Not used
Burst variable 6	For HART command 9: select the HART device variable or the process variable.	See the Burst variable 0 parameter.	Not used
Burst variable 7	For HART command 9: select the HART device variable or the process variable.	See the Burst variable 0 parameter.	Not used
Burst trigger mode	Select the event that triggers burst message X.	<ul style="list-style-type: none"> ■ Continuous ■ Window ■ Rising ■ Falling ■ On change 	Continuous
Burst trigger level	Enter the burst trigger value. Together with the option selected in the Burst trigger mode parameter the burst trigger value determines the time of burst message X.	Signed floating-point number	–
Min. update period	Enter the minimum time span between two burst commands of burst message X.	Positive integer	1 000 ms
Max. update period	Enter the maximum time span between two burst commands of burst message X.	Positive integer	2 000 ms

* Visibility depends on order options or device settings

10 Commissioning

10.1 Function check

Before commissioning the measuring device:

- ▶ Make sure that the post-installation and post-connection checks have been performed.
- "Post-installation check" checklist → 📄 40
- "Post-connection check" checklist → 📄 54

10.2 Switching on the measuring device

- ▶ After a successful function check, switch on the measuring device.
 - ↳ After a successful startup, the local display switches automatically from the startup display to the operational display.

i If nothing appears on the local display or a diagnostic message is displayed, refer to the section on "Diagnostics and troubleshooting" → 📄 128.

10.3 Setting the operating language

Factory setting: English or ordered local language

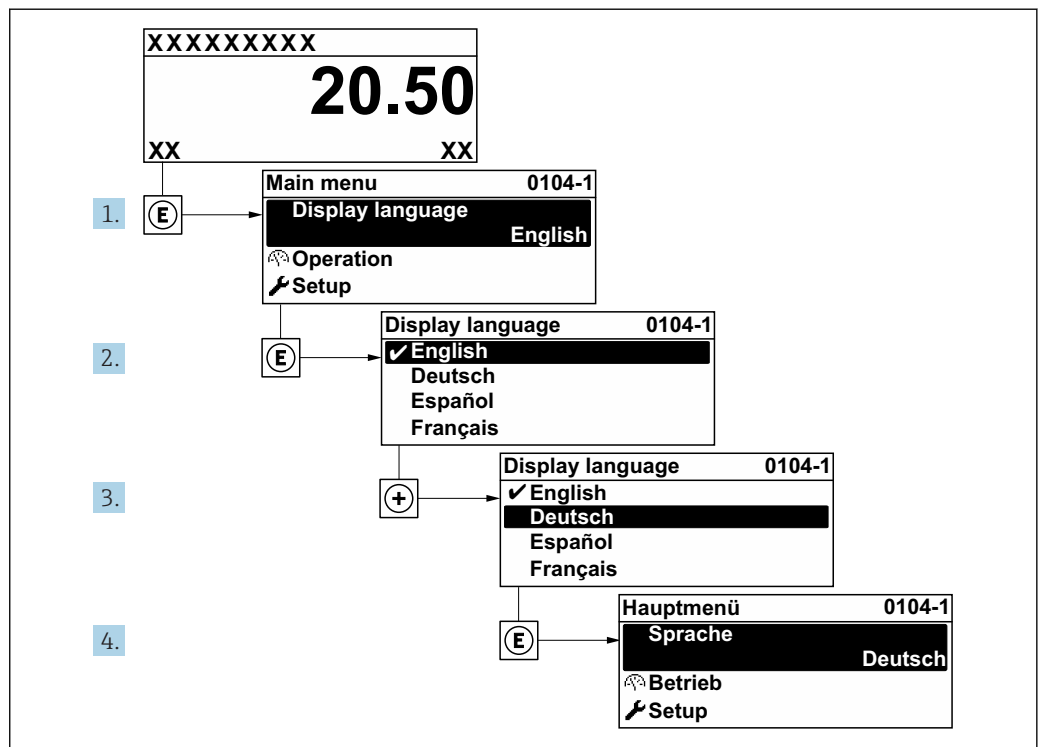

31 Taking the example of the local display

A0029420

10.4 Configuring the measuring device

- The **Setup** menu with its guided wizards contains all the parameters needed for standard operation.
- Navigation to the **Setup** menu

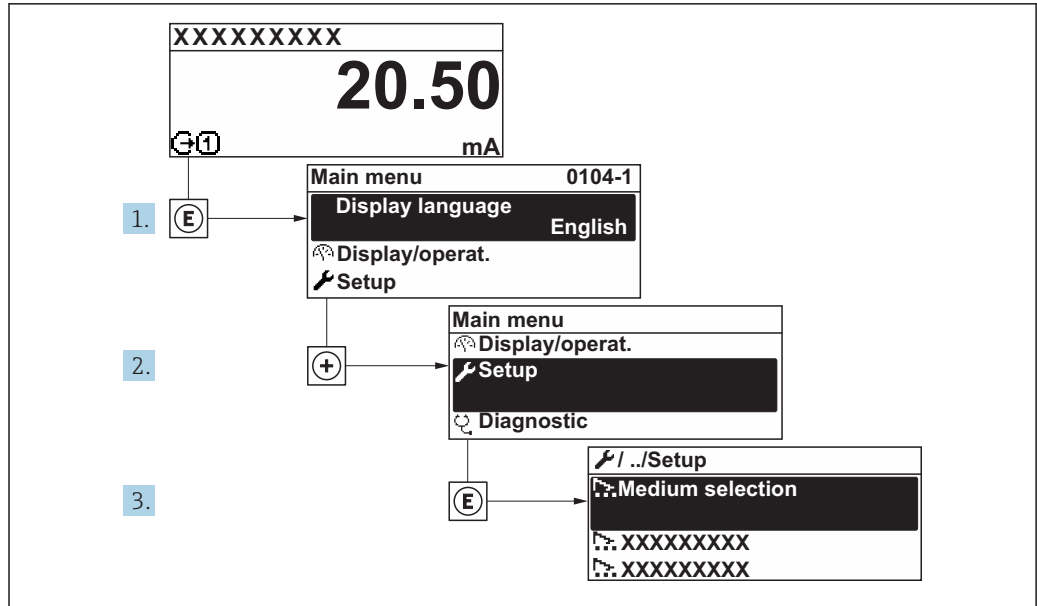

A0032222-EN

32 Taking the example of the local display

Navigation

"Setup" menu

🔧 Setup	
Device tag	→ 📖 89
▶ System units	→ 📖 89
▶ Status input 1	→ 📖 90
▶ Current output 1	→ 📖 92
▶ Pulse/frequency/switch output	→ 📖 93
▶ Display	→ 📖 99
▶ Low flow cut off	→ 📖 102
▶ Empty pipe detection	→ 📖 104
▶ Advanced setup	→ 📖 105

10.4.1 Defining the tag name

To enable fast identification of the measuring point within the system, you can enter a unique designation using the **Device tag** parameter and thus change the factory setting.

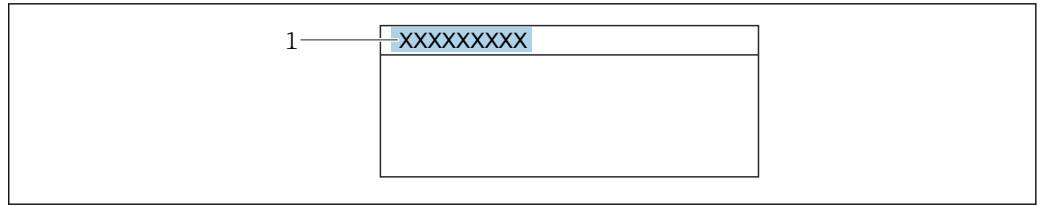

A0029422

33 Header of the operational display with tag name

1 Tag name

Enter the tag name in the "FieldCare" operating tool → 81

Navigation

"Setup" menu → Device tag

Parameter overview with brief description

Parameter	Description	User entry	Factory setting
Device tag	Enter the name for the measuring point.	Max. 32 characters, such as letters, numbers or special characters (e.g. @, %, /).	Promag

10.4.2 Setting the system units

In the **System units** submenu the units of all the measured values can be set.

Depending on the device version, not all submenus and parameters are available in every device. The selection can vary depending on the order code.

Navigation

"Setup" menu → System units

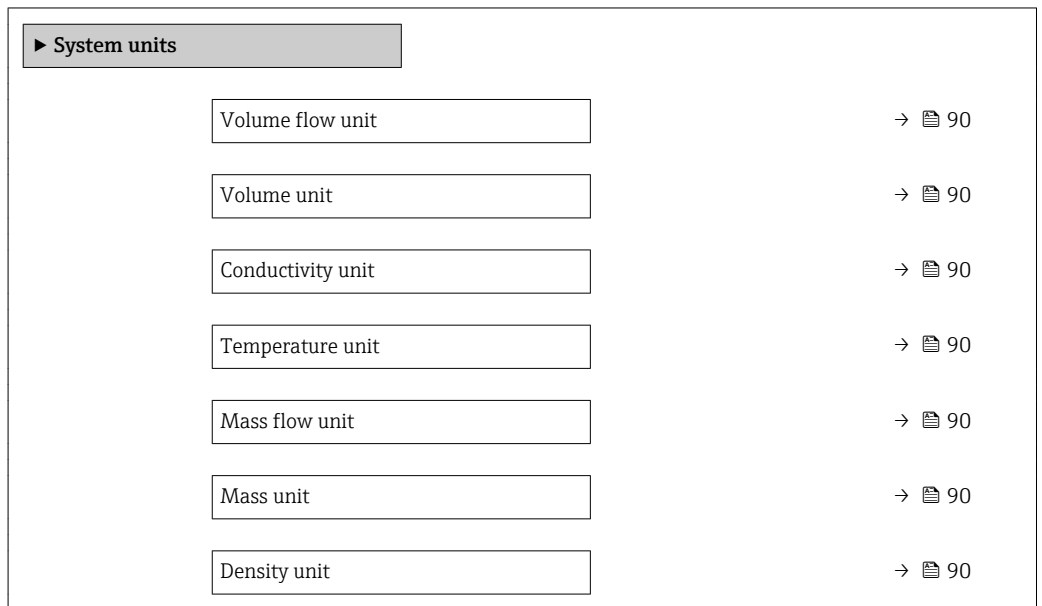

Parameter overview with brief description

Parameter	Prerequisite	Description	Selection	Factory setting
Volume flow unit	–	Select volume flow unit. <i>Result</i> The selected unit applies for: <ul style="list-style-type: none"> ▪ Output ▪ Low flow cut off ▪ Simulation process variable 	Unit choose list	Country-specific: <ul style="list-style-type: none"> ▪ l/h ▪ gal/min (us)
Volume unit	–	Select volume unit.	Unit choose list	Country-specific: <ul style="list-style-type: none"> ▪ m³ ▪ gal (us)
Conductivity unit	The On option is selected in the Conductivity measurement parameter parameter.	Select conductivity unit. <i>Effect</i> The selected unit applies for: <ul style="list-style-type: none"> ▪ Current output ▪ Frequency output ▪ Switch output ▪ Simulation process variable 	Unit choose list	µS/cm
Temperature unit	–	Select temperature unit. <i>Result</i> The selected unit applies for: <ul style="list-style-type: none"> ▪ Maximum value parameter ▪ Minimum value parameter 	Unit choose list	Country-specific: <ul style="list-style-type: none"> ▪ °C ▪ °F
Mass flow unit	–	Select mass flow unit. <i>Result</i> The selected unit applies for: <ul style="list-style-type: none"> ▪ Output ▪ Low flow cut off ▪ Simulation process variable 	Unit choose list	Country-specific: <ul style="list-style-type: none"> ▪ kg/h ▪ lb/min
Mass unit	–	Select mass unit.	Unit choose list	Country-specific: <ul style="list-style-type: none"> ▪ kg ▪ lb
Density unit	–	Select density unit. <i>Result</i> The selected unit applies for: <ul style="list-style-type: none"> ▪ Output ▪ Simulation process variable 	Unit choose list	Country-specific: <ul style="list-style-type: none"> ▪ kg/l ▪ lb/ft³

10.4.3 Configuring the status input

The **Status input** submenu guides the user systematically through all the parameters that have to be set for configuring the status input.



The submenu appears only if the device was ordered with a status input .

Navigation

"Setup" menu → Status input

Structure of the submenu

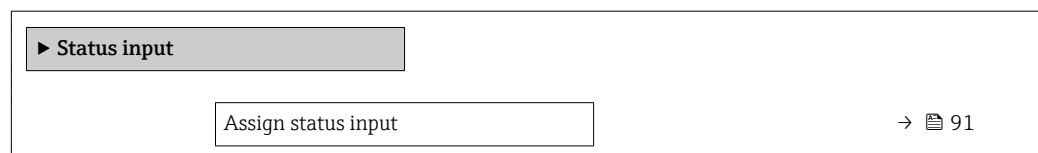

Active level	→ 91
Response time status input	→ 91

Parameter overview with brief description

Parameter	Description	Selection / User entry	Factory setting
Assign status input	Select function for the status input.	<ul style="list-style-type: none"> ▪ Off ▪ Reset totalizer 1 ▪ Reset totalizer 2 ▪ Reset totalizer 3 ▪ Reset all totalizers ▪ Flow override 	Off
Active level	Define input signal level at which the assigned function is triggered.	<ul style="list-style-type: none"> ▪ High ▪ Low 	High
Response time status input	Define the minimum amount of time the input signal level must be present before the selected function is triggered.	5 to 200 ms	50 ms

10.4.4 Configuring the current output

The **Current output** wizard guides you systematically through all the parameters that have to be set for configuring the current output.

Navigation

"Setup" menu → Current output 1

▶ Current output 1	
Assign current output 1	→ 92
Current span	→ 92
0/4 mA value	→ 92
20 mA value	→ 93
Fixed current	→ 93
Failure mode	→ 93
Failure current	→ 93

Parameter overview with brief description

Parameter	Prerequisite	Description	Selection / User entry	Factory setting
Assign current output	–	Select process variable for current output.	<ul style="list-style-type: none"> ■ Volume flow ■ Mass flow ■ Corrected volume flow ■ Flow velocity* ■ Conductivity* ■ Corrected conductivity* ■ Temperature ■ Electronic temperature 	Volume flow
Current span	–	Select current range for process value output and upper/lower level for alarm signal.	<ul style="list-style-type: none"> ■ 4...20 mA NAMUR ■ 4...20 mA US ■ 4...20 mA ■ 0...20 mA ■ Fixed current 	Country-specific: <ul style="list-style-type: none"> ■ 4...20 mA NAMUR ■ 4...20 mA US
0/4 mA value	One of the following options is selected in the Current span parameter (→ 92): <ul style="list-style-type: none"> ■ 4...20 mA NAMUR ■ 4...20 mA US ■ 4...20 mA ■ 0...20 mA 	Enter 4 mA value.	Signed floating-point number	Country-specific: <ul style="list-style-type: none"> ■ 0 l/h ■ 0 gal/min (us)

Parameter	Prerequisite	Description	Selection / User entry	Factory setting
20 mA value	One of the following options is selected in the Current span parameter (→ 92): <ul style="list-style-type: none"> ▪ 4...20 mA NAMUR ▪ 4...20 mA US ▪ 4...20 mA ▪ 0...20 mA 	Enter 20 mA value.	Signed floating-point number	Depends on country and nominal diameter
Fixed current	The Fixed current option is selected in the Current span parameter (→ 92).	Defines the fixed output current.	0 to 22.5 mA	22.5 mA
Failure mode	One of the following options is selected in the Assign current output parameter (→ 92): <ul style="list-style-type: none"> ▪ Volume flow ▪ Mass flow ▪ Flow velocity ▪ Conductivity* ▪ Corrected conductivity* ▪ Electronic temperature One of the following options is selected in the Current span parameter (→ 92): <ul style="list-style-type: none"> ▪ 4...20 mA NAMUR ▪ 4...20 mA US ▪ 4...20 mA ▪ 0...20 mA 	Define output behavior in alarm condition.	<ul style="list-style-type: none"> ▪ Min. ▪ Max. ▪ Last valid value ▪ Actual value ▪ Defined value 	Max.
Failure current	The Defined value option is selected in the Failure mode parameter.	Enter current output value in alarm condition.	0 to 22.5 mA	22.5 mA

* Visibility depends on order options or device settings

10.4.5 Configuring the pulse/frequency/switch output

The **Pulse/frequency/switch output** wizard guides you systematically through all the parameters that can be set for configuring the selected output type.



Configuring the pulse output

Navigation



"Setup" menu → Pulse/frequency/switch output 1 to n

► Pulse/frequency/switch output 1 to n

Operating mode	→ 94
Assign pulse output	→ 94
Value per pulse	→ 94
Pulse width	→ 94

Failure mode	→  94
Invert output signal	→  94



Parameter overview with brief description

Parameter	Prerequisite	Description	Selection / User entry	Factory setting
Operating mode	–	Define the output as a pulse, frequency or switch output.	<ul style="list-style-type: none"> ▪ Pulse ▪ Frequency ▪ Switch 	Pulse
Assign pulse output	The Pulse option is selected in the Operating mode parameter.	Select process variable for pulse output.	<ul style="list-style-type: none"> ▪ Off ▪ Volume flow ▪ Mass flow ▪ Corrected volume flow 	Off
Value per pulse	In the Operating mode parameter, the Pulse option is selected, and one of the following options is selected in the Assign pulse output parameter (→  94): <ul style="list-style-type: none"> ▪ Mass flow ▪ Volume flow 	Enter measured value at which a pulse is output.	Signed floating-point number	Depends on country and nominal diameter
Pulse width	In the Operating mode parameter, the Pulse option is selected, and one of the following options is selected in the Assign pulse output parameter (→  94): <ul style="list-style-type: none"> ▪ Mass flow ▪ Volume flow 	Define time width of the output pulse.	0.05 to 2 000 ms	100 ms
Failure mode	In the Operating mode parameter, the Pulse option is selected, and one of the following options is selected in the Assign pulse output parameter (→  94): <ul style="list-style-type: none"> ▪ Mass flow ▪ Volume flow 	Define output behavior in alarm condition.	<ul style="list-style-type: none"> ▪ Actual value ▪ No pulses 	No pulses
Invert output signal	–	Invert the output signal.	<ul style="list-style-type: none"> ▪ No ▪ Yes 	No

Configuring the frequency output

Navigation

"Setup" menu → Pulse/frequency/switch output 1 to n

▶ Pulse/frequency/switch output 1 to n	
Operating mode	→  95
Assign frequency output	→  95
Minimum frequency value	→  95

Maximum frequency value	→ 95
Measuring value at minimum frequency	→ 96
Measuring value at maximum frequency	→ 96
Failure mode	→ 96
Failure frequency	→ 96
Invert output signal	→ 96

Parameter overview with brief description

Parameter	Prerequisite	Description	Selection / User entry	Factory setting
Operating mode	–	Define the output as a pulse, frequency or switch output.	<ul style="list-style-type: none"> ▪ Pulse ▪ Frequency ▪ Switch 	Pulse
Assign frequency output	The Frequency option is selected in the Operating mode parameter (→ 94).	Select process variable for frequency output.	<ul style="list-style-type: none"> ▪ Off ▪ Volume flow ▪ Mass flow ▪ Corrected volume flow ▪ Flow velocity ▪ Conductivity* ▪ Corrected conductivity* ▪ Temperature ▪ Electronic temperature 	Off
Minimum frequency value	In the Operating mode parameter, the Frequency option is selected, and one of the following options is selected in the Assign frequency output parameter (→ 95): <ul style="list-style-type: none"> ▪ Volume flow ▪ Mass flow ▪ Flow velocity ▪ Conductivity* ▪ Corrected conductivity* ▪ Electronic temperature 	Enter minimum frequency.	0.0 to 12 500.0 Hz	0.0 Hz
Maximum frequency value	In the Operating mode parameter, the Frequency option is selected, and one of the following options is selected in the Assign frequency output parameter (→ 95): <ul style="list-style-type: none"> ▪ Volume flow ▪ Mass flow ▪ Flow velocity ▪ Conductivity* ▪ Corrected conductivity* ▪ Electronic temperature 	Enter maximum frequency.	0.0 to 12 500.0 Hz	12 500.0 Hz

Parameter	Prerequisite	Description	Selection / User entry	Factory setting
Measuring value at minimum frequency	In the Operating mode parameter, the Frequency option is selected, and one of the following options is selected in the Assign frequency output parameter (→ 95): <ul style="list-style-type: none"> ▪ Volume flow ▪ Mass flow ▪ Flow velocity ▪ Conductivity* ▪ Corrected conductivity* ▪ Electronic temperature 	Enter measured value for minimum frequency.	Signed floating-point number	Depends on country and nominal diameter
Measuring value at maximum frequency	In the Operating mode parameter, the Frequency option is selected, and one of the following options is selected in the Assign frequency output parameter (→ 95): <ul style="list-style-type: none"> ▪ Volume flow ▪ Mass flow ▪ Flow velocity ▪ Conductivity* ▪ Corrected conductivity* ▪ Electronic temperature 	Enter measured value for maximum frequency.	Signed floating-point number	Depends on country and nominal diameter
Failure mode	In the Operating mode parameter, the Frequency option is selected, and one of the following options is selected in the Assign frequency output parameter (→ 95): <ul style="list-style-type: none"> ▪ Volume flow ▪ Mass flow ▪ Flow velocity ▪ Conductivity* ▪ Corrected conductivity* ▪ Electronic temperature 	Define output behavior in alarm condition.	<ul style="list-style-type: none"> ▪ Actual value ▪ Defined value ▪ 0 Hz 	0 Hz
Failure frequency	In the Operating mode parameter, the Frequency option is selected, and one of the following options is selected in the Assign frequency output parameter (→ 95): <ul style="list-style-type: none"> ▪ Volume flow ▪ Mass flow ▪ Flow velocity ▪ Conductivity* ▪ Corrected conductivity* ▪ Electronic temperature 	Enter frequency output value in alarm condition.	0.0 to 12 500.0 Hz	0.0 Hz
Invert output signal	–	Invert the output signal.	<ul style="list-style-type: none"> ▪ No ▪ Yes 	No

* Visibility depends on order options or device settings

Configuring the switch output

Navigation

"Setup" menu → Pulse/frequency/switch output 1 to n

► Pulse/frequency/switch output 1 to n	
Operating mode	→ 97
Switch output function	→ 97
Assign diagnostic behavior	→ 97
Assign limit	→ 98
Assign flow direction check	→ 98
Assign status	→ 98
Switch-on value	→ 98
Switch-off value	→ 98
Switch-on delay	→ 98
Switch-off delay	→ 98
Failure mode	→ 98
Invert output signal	→ 98

Parameter overview with brief description

Parameter	Prerequisite	Description	Selection / User entry	Factory setting
Operating mode	–	Define the output as a pulse, frequency or switch output.	<ul style="list-style-type: none"> ■ Pulse ■ Frequency ■ Switch 	Pulse
Switch output function	The Switch option is selected in the Operating mode parameter.	Select function for switch output.	<ul style="list-style-type: none"> ■ Off ■ On ■ Diagnostic behavior ■ Limit ■ Flow direction check ■ Status 	Off
Assign diagnostic behavior	<ul style="list-style-type: none"> ■ In the Operating mode parameter, the Switch option is selected. ■ In the Switch output function parameter, the Diagnostic behavior option is selected. 	Select diagnostic behavior for switch output.	<ul style="list-style-type: none"> ■ Alarm ■ Alarm or warning ■ Warning 	Alarm

Parameter	Prerequisite	Description	Selection / User entry	Factory setting
Assign limit	<ul style="list-style-type: none"> ▪ The Switch option is selected in the Operating mode parameter. ▪ The Limit option is selected in the Switch output function parameter. 	Select process variable for limit function.	<ul style="list-style-type: none"> ▪ Off ▪ Volume flow ▪ Mass flow ▪ Corrected volume flow ▪ Flow velocity * ▪ Conductivity * ▪ Corrected conductivity * ▪ Totalizer 1 ▪ Totalizer 2 ▪ Totalizer 3 ▪ Temperature ▪ Electronic temperature 	Volume flow
Assign flow direction check	<ul style="list-style-type: none"> ▪ The Switch option is selected in the Operating mode parameter. ▪ The Flow direction check option is selected in the Switch output function parameter. 	Select process variable for flow direction monitoring.	<ul style="list-style-type: none"> ▪ Off ▪ Volume flow ▪ Mass flow ▪ Corrected volume flow 	Volume flow
Assign status	<ul style="list-style-type: none"> ▪ The Switch option is selected in the Operating mode parameter. ▪ The Status option is selected in the Switch output function parameter. 	Select device status for switch output.	<ul style="list-style-type: none"> ▪ Empty pipe detection ▪ Low flow cut off 	Empty pipe detection
Switch-on value	<ul style="list-style-type: none"> ▪ In the Operating mode parameter, the Switch option is selected. ▪ In the Switch output function parameter, the Limit option is selected. 	Enter measured value for the switch-on point.	Signed floating-point number	Country-specific: <ul style="list-style-type: none"> ▪ 0 l/h ▪ 0 gal/min (us)
Switch-off value	<ul style="list-style-type: none"> ▪ In the Operating mode parameter, the Switch option is selected. ▪ In the Switch output function parameter, the Limit option is selected. 	Enter measured value for the switch-off point.	Signed floating-point number	Country-specific: <ul style="list-style-type: none"> ▪ 0 l/h ▪ 0 gal/min (us)
Switch-on delay	<ul style="list-style-type: none"> ▪ The Switch option is selected in the Operating mode parameter. ▪ The Limit option is selected in the Switch output function parameter. 	Define delay for the switch-on of status output.	0.0 to 100.0 s	0.0 s
Switch-off delay	<ul style="list-style-type: none"> ▪ The Switch option is selected in the Operating mode parameter. ▪ The Limit option is selected in the Switch output function parameter. 	Define delay for the switch-off of status output.	0.0 to 100.0 s	0.0 s
Failure mode	–	Define output behavior in alarm condition.	<ul style="list-style-type: none"> ▪ Actual status ▪ Open ▪ Closed 	Open
Invert output signal	–	Invert the output signal.	<ul style="list-style-type: none"> ▪ No ▪ Yes 	No

* Visibility depends on order options or device settings

10.4.6 Configuring the local display

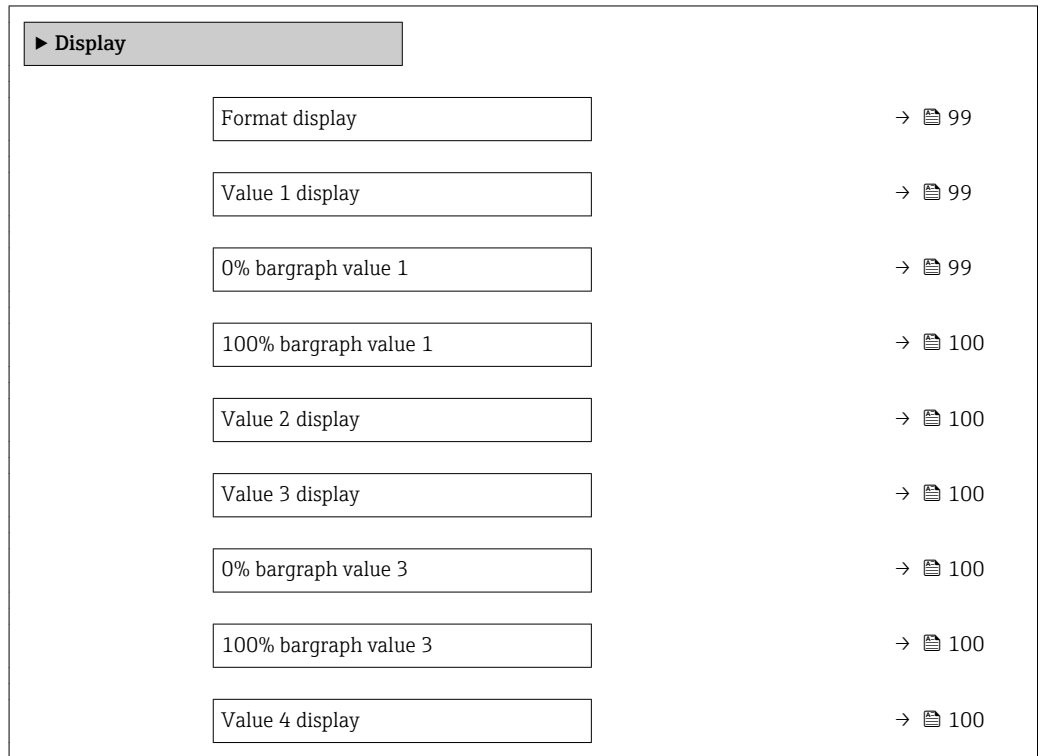

The **Display** wizard guides you systematically through all the parameters that can be configured for configuring the local display.

Navigation
 "Setup" menu → Display



Parameter overview with brief description

Parameter	Prerequisite	Description	Selection / User entry	Factory setting
Format display	A local display is provided.	Select how measured values are shown on the display.	<ul style="list-style-type: none"> ■ 1 value, max. size ■ 1 bargraph + 1 value ■ 2 values ■ 1 value large + 2 values ■ 4 values 	1 value, max. size
Value 1 display	A local display is provided.	Select the measured value that is shown on the local display.	<ul style="list-style-type: none"> ■ Volume flow ■ Mass flow ■ Corrected volume flow ■ Flow velocity ■ Conductivity ■ Corrected conductivity ■ Electronic temperature ■ Totalizer 1 ■ Totalizer 2 ■ Totalizer 3 ■ Current output 1 * 	Volume flow
0% bargraph value 1	A local display is provided.	Enter 0% value for bar graph display.	Signed floating-point number	Country-specific: <ul style="list-style-type: none"> ■ 0 l/h ■ 0 gal/min (us)

Parameter	Prerequisite	Description	Selection / User entry	Factory setting
100% bargraph value 1	A local display is provided.	Enter 100% value for bar graph display.	Signed floating-point number	Depends on country and nominal diameter
Value 2 display	A local display is provided.	Select the measured value that is shown on the local display.	<ul style="list-style-type: none"> ▪ None ▪ Volume flow ▪ Mass flow ▪ Corrected volume flow ▪ Flow velocity ▪ Conductivity ▪ Corrected conductivity ▪ Electronic temperature ▪ Totalizer 1 ▪ Totalizer 2 ▪ Custody transfer counter* ▪ Totalizer 3 ▪ Current output 1 	None
Value 3 display	A local display is provided.	Select the measured value that is shown on the local display.	For the picklist, see the Value 2 display parameter (→  100)	None
0% bargraph value 3	A selection was made in the Value 3 display parameter.	Enter 0% value for bar graph display.	Signed floating-point number	Country-specific: <ul style="list-style-type: none"> ▪ 0 l/h ▪ 0 gal/min (us)
100% bargraph value 3	A selection was made in the Value 3 display parameter.	Enter 100% value for bar graph display.	Signed floating-point number	0
Value 4 display	A local display is provided.	Select the measured value that is shown on the local display.	For the picklist, see the Value 2 display parameter (→  100)	None





* Visibility depends on order options or device settings





10.4.7 Configuring the output conditioning

The **Output conditioning** wizard guides you systematically through all the parameters that have to be set for configuring the output conditioning.

Navigation

"Setup" menu → Output conditioning

► Output conditioning	
Display damping	→  101
Assign current output 1	→  101
Damping output 1	→  101
Measuring mode output 1	→  101
Assign frequency output	→  101

Damping output 1 to n	→  101
Measuring mode output 1 to n	→  101
Assign pulse output 1 to n	→  102
Measuring mode output 1 to n	→  102

Parameter overview with brief description

Parameter	Prerequisite	Description	User entry / Selection	Factory setting
Display damping	–	Set display reaction time to fluctuations in the measured value.	0.0 to 999.9 s	0.0 s
Assign current output	–	Select process variable for current output.	<ul style="list-style-type: none"> ■ Volume flow ■ Mass flow ■ Corrected volume flow ■ Flow velocity* ■ Conductivity* ■ Corrected conductivity* ■ Temperature ■ Electronic temperature 	Volume flow
Damping output 1	–	Set reaction time for output signal to fluctuations in the measured value.	0 to 999.9 s	1 s
Measuring mode output 1	–	Select measuring mode for output.	<ul style="list-style-type: none"> ■ Forward flow ■ Forward/Reverse flow ■ Reverse flow compensation 	Forward flow
Assign frequency output	The Frequency option is selected in the Operating mode parameter (→  94).	Select process variable for frequency output.	<ul style="list-style-type: none"> ■ Off ■ Volume flow ■ Mass flow ■ Corrected volume flow ■ Flow velocity* ■ Conductivity* ■ Corrected conductivity* ■ Temperature ■ Electronic temperature 	Off
Damping output 1 to n	–	Set reaction time for output signal to fluctuations in the measured value.	0 to 999.9 s	1 s
Measuring mode output 1 to n	–	Select measuring mode for output.	<ul style="list-style-type: none"> ■ Forward flow ■ Forward/Reverse flow ■ Reverse flow ■ Reverse flow compensation 	Forward flow

Parameter	Prerequisite	Description	User entry / Selection	Factory setting
Assign pulse output	The Pulse option is selected in the Operating mode parameter.	Select process variable for pulse output.	<ul style="list-style-type: none"> ▪ Off ▪ Volume flow ▪ Mass flow ▪ Corrected volume flow 	Off
Measuring mode output 1 to n	–	Select measuring mode for output.	<ul style="list-style-type: none"> ▪ Forward flow ▪ Forward/Reverse flow ▪ Reverse flow ▪ Reverse flow compensation 	Forward flow

* Visibility depends on order options or device settings

10.4.8 Configuring the low flow cut off

The **Low flow cut off** wizard systematically guides the user through all the parameters that must be set to configure low flow cut off.



Navigation

"Setup" menu → Low flow cut off

▶ Low flow cut off	
Assign process variable	→ ⓘ 102
On value low flow cutoff	→ ⓘ 102
Off value low flow cutoff	→ ⓘ 103
Pressure shock suppression	→ ⓘ 103

Parameter overview with brief description

Parameter	Prerequisite	Description	Selection / User entry	Factory setting
Assign process variable	–	Select process variable for low flow cut off.	<ul style="list-style-type: none"> ▪ Off ▪ Volume flow ▪ Mass flow ▪ Corrected volume flow 	Volume flow
On value low flow cutoff	One of the following options is selected in the Assign process variable parameter (→ ⓘ 102): <ul style="list-style-type: none"> ▪ Volume flow ▪ Mass flow 	Enter on value for low flow cut off.	Positive floating-point number	Depends on country and nominal diameter





Parameter	Prerequisite	Description	Selection / User entry	Factory setting
Off value low flow cutoff	One of the following options is selected in the Assign process variable parameter (→  102): <ul style="list-style-type: none"> ▪ Volume flow ▪ Mass flow 	Enter off value for low flow cut off.	0 to 100.0 %	50 %
Pressure shock suppression	One of the following options is selected in the Assign process variable parameter (→  102): <ul style="list-style-type: none"> ▪ Volume flow ▪ Mass flow 	Enter time frame for signal suppression (= active pressure shock suppression).	0 to 100 s	0 s

10.4.9 Configuring empty pipe detection

The **Empty pipe detection** wizard guides you systematically through all the parameters that have to be set for configuring empty pipe detection.

Navigation

"Setup" menu → Empty pipe detection

▶ Empty pipe detection	
Empty pipe detection	→  104
New adjustment	→  104
Progress	→  104
Switch point empty pipe detection	→  104
Response time empty pipe detection	→  104

Parameter overview with brief description

Parameter	Prerequisite	Description	Selection / User interface / User entry	Factory setting
Empty pipe detection	–	Switch empty pipe detection on and off.	<ul style="list-style-type: none"> ▪ Off ▪ On 	Off
New adjustment	The On option is selected in the Empty pipe detection parameter.	Select type of adjustment.	<ul style="list-style-type: none"> ▪ Cancel ▪ Empty pipe adjust ▪ Full pipe adjust 	Cancel
Progress	The On option is selected in the Empty pipe detection parameter.	Shows the progress.	<ul style="list-style-type: none"> ▪ Ok ▪ Busy ▪ Not ok 	–
Switch point empty pipe detection	The On option is selected in the Empty pipe detection parameter.	Enter hysteresis in %, below this value the measuring tube will be detected as empty.	0 to 100 %	50 %
Response time empty pipe detection	In the Empty pipe detection parameter (→  104), the On option is selected.	Enter the time before diagnostic message S862 'Pipe empty' is displayed for empty pipe detection.	0 to 100 s	1 s

10.5 Advanced settings

The **Advanced setup** submenu together with its submenus contains parameters for specific settings.

Navigation to the "Advanced setup" submenu

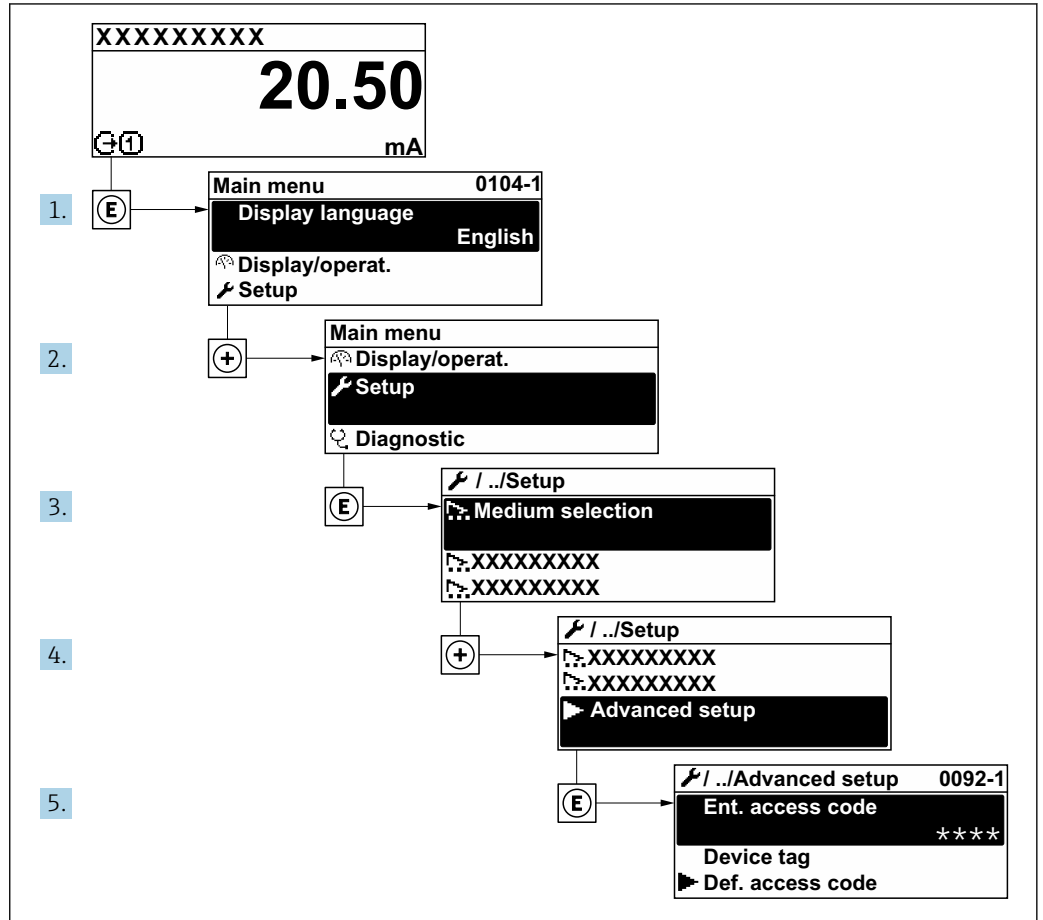

A003223-EN

i Depending on the device version, not all submenus and parameters are available in every device. The selection can vary depending on the order code.

Navigation

"Setup" menu → Advanced setup

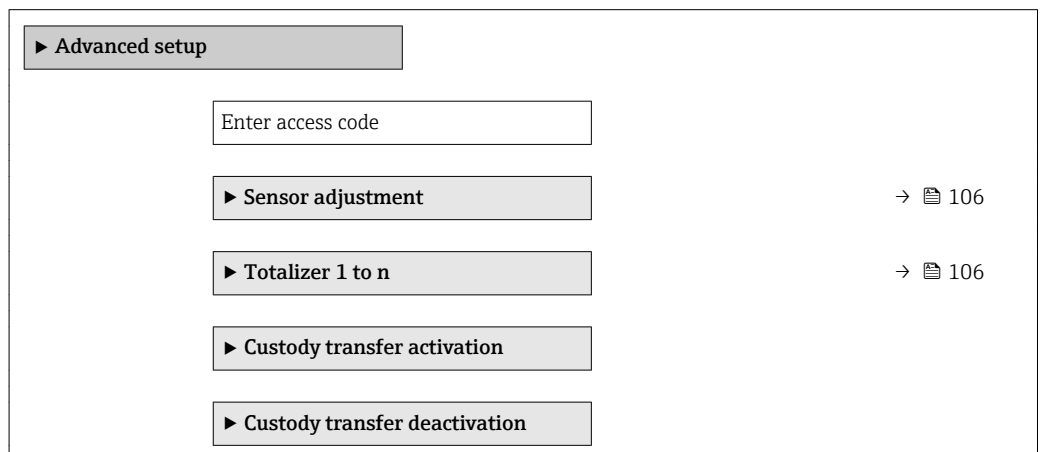

▶ Display	→ 108
▶ Electrode cleaning circuit	→ 111
▶ WLAN settings	→ 111
▶ Heartbeat setup	
▶ Administration	→ 112

10.5.1 Carrying out a sensor adjustment

The **Sensor adjustment** submenu contains parameters that pertain to the functionality of the sensor.

Navigation

"Setup" menu → Advanced setup → Sensor adjustment

▶ Sensor adjustment	
Installation direction	→ 106

Parameter overview with brief description

Parameter	Description	Selection	Factory setting
Installation direction	Set sign of flow direction to match the direction of the arrow on the sensor.	<ul style="list-style-type: none"> ▪ Flow in arrow direction ▪ Flow against arrow direction 	Flow in arrow direction

10.5.2 Configuring the totalizer



In the **"Totalizer 1 to n"** submenu the individual totalizer can be configured.

Navigation

"Setup" menu → Advanced setup → Totalizer 1 to n

▶ Totalizer 1 to n	
Assign process variable	→ 107
Unit totalizer 1 to n	→ 107
Totalizer operation mode	→ 107
Failure mode	→ 107

Parameter overview with brief description

Parameter	Prerequisite	Description	Selection	Factory setting
Assign process variable	–	Select process variable for totalizer.	<ul style="list-style-type: none"> ▪ Off ▪ Volume flow ▪ Mass flow ▪ Corrected volume flow 	Volume flow
Unit totalizer 1 to n	One of the following options is selected in the Assign process variable parameter (→  107) of the Totalizer 1 to n submenu: <ul style="list-style-type: none"> ▪ Volume flow ▪ Mass flow 	Select process variable totalizer unit.	Unit choose list	Country-specific: <ul style="list-style-type: none"> ▪ l ▪ gal (us)
Totalizer operation mode	One of the following options is selected in the Assign process variable parameter (→  107) of the Totalizer 1 to n submenu: <ul style="list-style-type: none"> ▪ Volume flow ▪ Mass flow 	Select totalizer calculation mode.	<ul style="list-style-type: none"> ▪ Net flow total ▪ Forward flow total ▪ Reverse flow total 	Net flow total
Failure mode	One of the following options is selected in the Assign process variable parameter (→  107) of the Totalizer 1 to n submenu: <ul style="list-style-type: none"> ▪ Volume flow ▪ Mass flow 	Define totalizer behavior in alarm condition.	<ul style="list-style-type: none"> ▪ Stop ▪ Actual value ▪ Last valid value 	Stop

10.5.3 Carrying out additional display configurations

In the **Display** submenu you can set all the parameters associated with the configuration of the local display.

Navigation

"Setup" menu → Advanced setup → Display

► Display	
Format display	→ 109
Value 1 display	→ 109
0% bargraph value 1	→ 109
100% bargraph value 1	→ 109
Decimal places 1	→ 109
Value 2 display	→ 109
Decimal places 2	→ 109
Value 3 display	→ 109
0% bargraph value 3	→ 110
100% bargraph value 3	→ 110
Decimal places 3	→ 110
Value 4 display	→ 110
Decimal places 4	→ 110
Display language	→ 110
Display interval	→ 110
Display damping	→ 110
Header	→ 110
Header text	→ 110
Separator	→ 110
Backlight	→ 110

Parameter overview with brief description

Parameter	Prerequisite	Description	Selection / User entry	Factory setting
Format display	A local display is provided.	Select how measured values are shown on the display.	<ul style="list-style-type: none"> ■ 1 value, max. size ■ 1 bargraph + 1 value ■ 2 values ■ 1 value large + 2 values ■ 4 values 	1 value, max. size
Value 1 display	A local display is provided.	Select the measured value that is shown on the local display.	<ul style="list-style-type: none"> ■ Volume flow ■ Mass flow ■ Corrected volume flow ■ Flow velocity ■ Conductivity ■ Corrected conductivity ■ Electronic temperature ■ Totalizer 1 ■ Totalizer 2 ■ Totalizer 3 ■ Current output 1 * 	Volume flow
0% bargraph value 1	A local display is provided.	Enter 0% value for bar graph display.	Signed floating-point number	Country-specific: <ul style="list-style-type: none"> ■ 0 l/h ■ 0 gal/min (us)
100% bargraph value 1	A local display is provided.	Enter 100% value for bar graph display.	Signed floating-point number	Depends on country and nominal diameter
Decimal places 1	A measured value is specified in the Value 1 display parameter.	Select the number of decimal places for the display value.	<ul style="list-style-type: none"> ■ x ■ x.x ■ x.xx ■ x.xxx ■ x.xxxx 	x.xx
Value 2 display	A local display is provided.	Select the measured value that is shown on the local display.	<ul style="list-style-type: none"> ■ None ■ Volume flow ■ Mass flow ■ Corrected volume flow ■ Flow velocity ■ Conductivity ■ Corrected conductivity ■ Electronic temperature ■ Totalizer 1 ■ Totalizer 2 ■ Custody transfer counter * ■ Totalizer 3 ■ Current output 1 	None
Decimal places 2	A measured value is specified in the Value 2 display parameter.	Select the number of decimal places for the display value.	<ul style="list-style-type: none"> ■ x ■ x.x ■ x.xx ■ x.xxx ■ x.xxxx 	x.xx
Value 3 display	A local display is provided.	Select the measured value that is shown on the local display.	For the picklist, see the Value 2 display parameter (→  100)	None

Parameter	Prerequisite	Description	Selection / User entry	Factory setting
0% bargraph value 3	A selection was made in the Value 3 display parameter.	Enter 0% value for bar graph display.	Signed floating-point number	Country-specific: <ul style="list-style-type: none"> ■ 0 l/h ■ 0 gal/min (us)
100% bargraph value 3	A selection was made in the Value 3 display parameter.	Enter 100% value for bar graph display.	Signed floating-point number	0
Decimal places 3	A measured value is specified in the Value 3 display parameter.	Select the number of decimal places for the display value.	<ul style="list-style-type: none"> ■ x ■ x.x ■ x.xx ■ x.xxx ■ x.xxxx 	x.xx
Value 4 display	A local display is provided.	Select the measured value that is shown on the local display.	For the picklist, see the Value 2 display parameter (→  100)	None
Decimal places 4	A measured value is specified in the Value 4 display parameter.	Select the number of decimal places for the display value.	<ul style="list-style-type: none"> ■ x ■ x.x ■ x.xx ■ x.xxx ■ x.xxxx 	x.xx
Display language	A local display is provided.	Set display language.	<ul style="list-style-type: none"> ■ English ■ Deutsch * ■ Français * ■ Español * ■ Italiano * ■ Nederlands * ■ Portuguesa * ■ Polski * ■ русский язык (Russian) * ■ Svenska * ■ Türkçe * ■ 中文 (Chinese) * ■ 日本語 (Japanese) * ■ 한국어 (Korean) * ■ العربية (Arabic) * ■ Bahasa Indonesia * ■ ภาษาไทย (Thai) * ■ tiếng Việt (Vietnamese) * ■ čeština (Czech) * 	English (alternatively, the ordered language is preset in the device)
Display interval	A local display is provided.	Set time measured values are shown on display if display alternates between values.	1 to 10 s	5 s
Display damping	A local display is provided.	Set display reaction time to fluctuations in the measured value.	0.0 to 999.9 s	0.0 s
Header	A local display is provided.	Select header contents on local display.	<ul style="list-style-type: none"> ■ Device tag ■ Free text 	Device tag
Header text	In the Header parameter, the Free text option is selected.	Enter display header text.	Max. 12 characters such as letters, numbers or special characters (e.g. @, %, /)	-----
Separator	A local display is provided.	Select decimal separator for displaying numerical values.	<ul style="list-style-type: none"> ■ . (point) ■ , (comma) 	. (point)
Backlight	A local display is provided.	Switch the local display backlight on and off.	<ul style="list-style-type: none"> ■ Disable ■ Enable 	Enable

* Visibility depends on order options or device settings

10.5.4 Performing electrode cleaning





The **Electrode cleaning circuit** wizard guides the user systematically through all the parameters that have to be set for configuring electrode cleaning.

 The wizard only appears if the device was ordered with an electrode cleaning circuit.

Navigation

"Setup" menu → Advanced setup → Electrode cleaning circuit

▶ **Electrode cleaning circuit**

Electrode cleaning circuit	→  111
ECC duration	→  111
ECC recovery time	→  111
ECC cleaning cycle	→  111
ECC Polarity	→  111

Parameter overview with brief description

Parameter	Prerequisite	Description	Selection / User entry / User interface	Factory setting
Electrode cleaning circuit	For the following order code: "Application package", option EC "ECC electrode cleaning"	Enable the cyclic electrode cleaning circuit.	<ul style="list-style-type: none"> ■ Off ■ On 	Off
ECC duration	For the following order code: "Application package", option EC "ECC electrode cleaning"	Enter the duration of electrode cleaning in seconds.	0.01 to 30 s	2 s
ECC recovery time	For the following order code: "Application package", option EC "ECC electrode cleaning"	Define recovery time after electrode cleaning. During this time the current output values will be held at last valid value.	1 to 600 s	5 s
ECC cleaning cycle	For the following order code: "Application package", option EC "ECC electrode cleaning"	Enter the pause duration between electrode cleaning cycles.	0.5 to 168 h	0.66 h
ECC Polarity	For the following order code: "Application package", option EC "ECC electrode cleaning"	Select the polarity of the electrode cleaning circuit.	<ul style="list-style-type: none"> ■ Positive ■ Negative 	Depends on the electrode material: <ul style="list-style-type: none"> ■ Platinum: Negative option ■ Tantalum, Alloy C22, stainless steel: Positive option

10.5.5 WLAN configuration



The **WLAN Settings** submenu guides the user systematically through all the parameters that have to be set for the WLAN configuration.

Navigation

"Setup" menu → Advanced setup → WLAN Settings

▶ WLAN settings	
WLAN IP address	→ ⓘ 112
Security type	→ ⓘ 112
WLAN passphrase	→ ⓘ 112
Assign SSID name	→ ⓘ 112
SSID name	→ ⓘ 112
Apply changes	→ ⓘ 112

Parameter overview with brief description

Parameter	Prerequisite	Description	User entry / Selection	Factory setting
WLAN IP address	–	Enter IP address of the device WLAN interface.	4 octet: 0 to 255 (in the particular octet)	192.168.1.212
Security type	–	Select the security type of the WLAN interface.	<ul style="list-style-type: none"> ▪ Unsecured ▪ WPA2-PSK 	WPA2-PSK
WLAN passphrase	In the Security type parameter, the WPA2-PSK option is selected.	Enter the network key (8 to 32 characters).  The network key supplied with the device should be changed during commissioning for security reasons.	8 to 32-digit character string comprising numbers, letters and special characters	Serial number of the measuring device (e.g. L100A802000)
Assign SSID name	–	Select which name will be used for SSID: device tag or user-defined name.	<ul style="list-style-type: none"> ▪ Device tag ▪ User-defined 	User-defined
SSID name	In the Assign SSID name parameter, the User-defined option is selected.	Enter the user-defined SSID name (max. 32 characters).  The user-defined SSID name may only be assigned once. If the SSID name is assigned more than once, the devices can interfere with one another.	Max. 32-digit character string comprising numbers, letters and special characters	
Apply changes	–	Use changed WLAN settings.	<ul style="list-style-type: none"> ▪ Cancel ▪ Ok 	Cancel

10.5.6 Using parameters for device administration

The **Administration** submenu systematically guides the user through all the parameters that can be used for device administration purposes.

Navigation

"Setup" menu → Advanced setup → Administration

▶ Administration

▶ Define access code → 113

Define access code → 113

Confirm access code → 113

▶ Reset access code → 114

Operating time → 114

Reset access code → 114

Device reset → 114

Using the parameter to define the access code

Navigation

"Setup" menu → Advanced setup → Administration → Define access code

▶ Define access code

Define access code → 113

Confirm access code → 113

Parameter overview with brief description

Parameter	Description	User entry
Define access code	Restrict write-access to parameters to protect the configuration of the device against unintentional changes.	Max. 16-digit character string comprising numbers, letters and special characters
Confirm access code	Confirm the entered access code.	Max. 16-digit character string comprising numbers, letters and special characters

Using the parameter to reset the access code

Navigation

"Setup" menu → Advanced setup → Administration → Reset access code

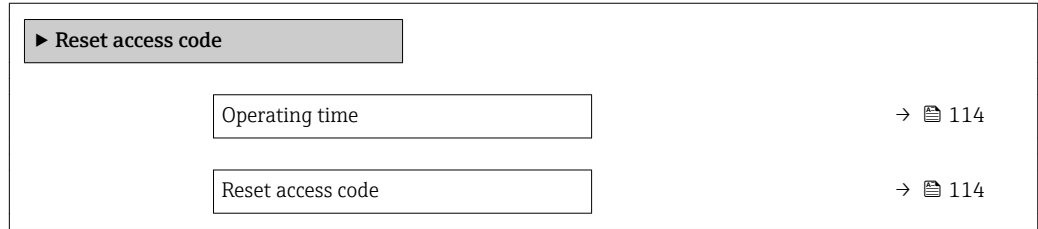

Parameter overview with brief description

Parameter	Description	User interface / User entry	Factory setting
Operating time	Indicates how long the device has been in operation.	Days (d), hours (h), minutes (m) and seconds (s)	-
Reset access code	Reset access code to factory settings.  For a reset code, contact your Endress+Hauser service organization. The reset code can only be entered via: <ul style="list-style-type: none"> ▪ Web browser ▪ DeviceCare, FieldCare (via service interface CDI-RJ45) ▪ Fieldbus 	Character string comprising numbers, letters and special characters	0x00

Using the parameter to reset the device

Navigation

"Setup" menu → Advanced setup → Administration

Parameter overview with brief description

Parameter	Description	Selection	Factory setting
Device reset	Reset the device configuration - either entirely or in part - to a defined state.	<ul style="list-style-type: none"> ▪ Cancel ▪ To delivery settings ▪ Restart device ▪ Restore S-DAT backup 	Cancel

10.6 Simulation

The **Simulation** submenu enables you to simulate, without a real flow situation, various process variables in the process and the device alarm mode and to verify downstream signal chains (switching valves or closed-control loops).



- The parameters displayed depend on:
- The selected device order
 - The set operating mode of the pulse/frequency/switch outputs

Navigation

"Diagnostics" menu → Simulation

► Simulation	
Assign simulation process variable	→ 116
Process variable value	→ 116
Status input simulation	→ 116
Input signal level	→ 116
Current output 1 simulation	→ 116
Value current output 1	→ 116
Frequency output simulation 1 to n	→ 116
Frequency value 1 to n	→ 116
Pulse output simulation 1 to n	→ 116
Pulse value 1 to n	→ 116
Switch output simulation 1 to n	→ 116
Switch status 1 to n	→ 117
Device alarm simulation	→ 117
Diagnostic event category	→ 117
Diagnostic event simulation	→ 117

Parameter overview with brief description

Parameter	Prerequisite	Description	Selection / User entry	Factory setting
Assign simulation process variable	–	Select a process variable for the simulation process that is activated.	<ul style="list-style-type: none"> ▪ Off ▪ Mass flow ▪ Volume flow ▪ Corrected volume flow ▪ Flow velocity[*] ▪ Conductivity[*] ▪ Corrected conductivity[*] ▪ Temperature 	Off
Process variable value	One of the following options is selected in the Assign simulation process variable parameter (→ 116): <ul style="list-style-type: none"> ▪ Volume flow ▪ Mass flow ▪ Corrected volume flow ▪ Flow velocity ▪ Conductivity[*] ▪ Corrected conductivity[*] ▪ Temperature 	Enter the simulation value for the selected process variable.	Depends on the process variable selected	0
Status input simulation	For the following order code: <ul style="list-style-type: none"> ▪ "Output; input", option I "4-20mA HART, 2x pul./freq./switch output; status input" ▪ "Output; input", option J "4-20mA HART, certified pulse output, switch output; status input" 	Switch simulation of the status input on and off.	<ul style="list-style-type: none"> ▪ Off ▪ On 	Off
Input signal level	In the Status input simulation parameter, the On option is selected.	Select the signal level for the simulation of the status input.	<ul style="list-style-type: none"> ▪ High ▪ Low 	High
Current output 1 simulation	–	Switch the simulation of the current output on and off.	<ul style="list-style-type: none"> ▪ Off ▪ On 	Off
Value current output 1	In the Current output simulation parameter, the On option is selected.	Enter the current value for simulation.	3.59 to 22.5 mA	3.59 mA
Frequency output simulation 1 to n	In the Operating mode parameter, the Frequency option is selected.	Switch the simulation of the frequency output on and off.	<ul style="list-style-type: none"> ▪ Off ▪ On 	Off
Frequency value 1 to n	In the Frequency output simulation 1 to n parameter, the On option is selected.	Enter the frequency value for the simulation.	0.0 to 12 500.0 Hz	0.0 Hz
Pulse output simulation 1 to n	In the Operating mode parameter, the Pulse option is selected.	Set and switch off the pulse output simulation.  For Fixed value option: Pulse width parameter (→ 94) defines the pulse width of the pulses output.	<ul style="list-style-type: none"> ▪ Off ▪ Fixed value ▪ Down-counting value 	Off
Pulse value 1 to n	In the Pulse output simulation 1 to n parameter, the Down-counting value option is selected.	Enter the number of pulses for simulation.	0 to 65 535	0
Switch output simulation 1 to n	In the Operating mode parameter, the Switch option is selected.	Switch the simulation of the switch output on and off.	<ul style="list-style-type: none"> ▪ Off ▪ On 	Off

Parameter	Prerequisite	Description	Selection / User entry	Factory setting
Switch status 1 to n	–	Select the status of the status output for the simulation.	<ul style="list-style-type: none"> ■ Open ■ Closed 	Open
Device alarm simulation	–	Switch the device alarm on and off.	<ul style="list-style-type: none"> ■ Off ■ On 	Off
Diagnostic event category	–	Select a diagnostic event category.	<ul style="list-style-type: none"> ■ Sensor ■ Electronics ■ Configuration ■ Process 	Process
Diagnostic event simulation	–	Select a diagnostic event to simulate this event.	<ul style="list-style-type: none"> ■ Off ■ Diagnostic event picklist (depends on the category selected) 	Off

* Visibility depends on order options or device settings

10.7 Protecting settings from unauthorized access

The following options exist for protecting the configuration of the measuring device from unintentional modification after commissioning:



- Write protection via access code for the local display and Web browser
- Write protection via write protection switch
- Write protection via keypad lock

10.7.1 Write protection via access code



The effects of the user-specific access code are as follows:

- Via local operation, the parameters for the measuring device configuration are write-protected and their values can no longer be changed.
- Device access is protected via the Web browser, as are the parameters for the measuring device configuration.

Defining the access code via local display

1. Navigate to the **Define access code** parameter (→  113).
2. Define a max. 16-digit character string comprising numbers, letters and special characters as the access code.
3. Enter the access code again in the to confirm the code.
 - ↳ The -symbol appears in front of all write-protected parameters.

The device automatically locks the write-protected parameters again if a key is not pressed for 10 minutes in the navigation and editing view. The device locks the write-protected parameters automatically after 60 s if the user skips back to the operational display mode from the navigation and editing view.

-  If parameter write protection is activated via an access code, it can also only be deactivated via this access code →  70.
- The user role with which the user is currently logged on via the local display is indicated by the →  70 **Access status display** parameter. Navigation path: Operation → Access status display

Parameters which can always be modified via the local display

Certain parameters that do not affect the measurement are excepted from parameter write protection via the local display. Despite the user-specific access code, they can always be modified, even if the other parameters are locked.

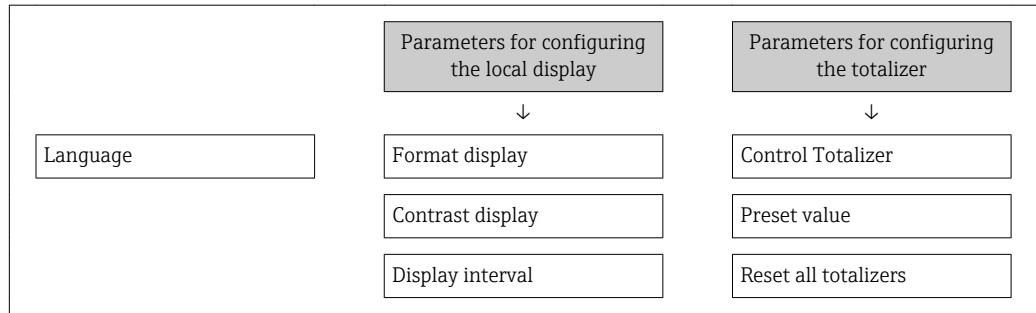

Defining the access code via the Web browser

1. Navigate to the **Define access code** parameter (→ 📄 113).
2. Define a max. 16-digit numeric code as an access code.
3. Enter the access code again in the to confirm the code.
 - ↳ The Web browser switches to the login page.

i If no action is performed for 10 minutes, the Web browser automatically returns to the login page.

- i**
- If parameter write protection is activated via an access code, it can also only be deactivated via this access code → 📄 70.
 - The user role with which the user is currently logged on via Web browser is indicated by the **Access status tooling** parameter. Navigation path: Operation → Access status tooling

10.7.2 Write protection via write protection switch

Unlike parameter write protection via a user-specific access code, this allows write access to the entire operating menu - except for the **"Contrast display" parameter** - to be locked.

The parameter values are now read only and cannot be edited any more (exception **"Contrast display" parameter**):

- Via local display
- Via service interface (CDI-RJ45)
- Via HART protocol

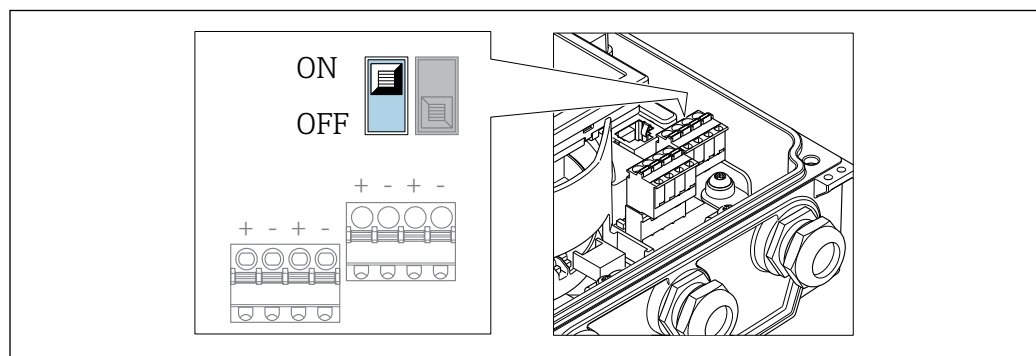

A0032092

1. Loosen the 4 fixing screws on the housing cover and open the housing cover.

2. Setting the write protection switch (WP) on the main electronics module to the **ON** position enables the hardware write protection. Setting the write protection switch (WP) on the main electronics module to the **OFF** position (factory setting) disables the hardware write protection.

↳ If the hardware write protection is enabled: The **Hardware locked** option is displayed in the **Locking status** parameter . In addition, on the local display the -symbol appears in front of the parameters in the header of the operational display and in the navigation view.

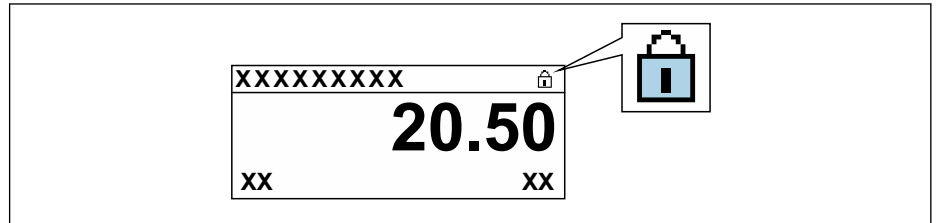

A0029425

If the hardware write protection is disabled: No option is displayed in the **Locking status** parameter . On the local display, the -symbol disappears from in front of the parameters in the header of the operational display and in the navigation view.

3. **⚠ WARNING**

Excessive tightening torque applied to the fixing screws!

Risk of damaging the plastic transmitter.

- ▶ Tighten the fixing screws as per the tightening torque .

Reverse the removal procedure to reassemble the transmitter.





11 Operation

11.1 Reading the device locking status

Device active write protection: **Locking status** parameter



Operation → Locking status

Function scope of the "Locking status" parameter

Options	Description
None	The access status displayed in the Access status display parameter applies →  70. Only appears on local display.
Hardware locked	The DIP switch for hardware locking is activated on the main electronics module. This locks write access to the parameters (e.g. via local display or operating tool) .
CT active - defined parameters	 Only available for Promag W. The DIP switch for custody transfer mode is activated on the I/O module. This locks write access to defined parameters (e.g. via local display or operating tool).  For detailed information on custody transfer mode, see the Special Documentation for the device
CT active - all parameters	 Only available for Promag W. The DIP switch for custody transfer mode is activated on the I/O module. This locks write access to all the parameters (e.g. via local display or operating tool).  For detailed information on custody transfer mode, see the Special Documentation for the device
Temporarily locked	Write access to the parameters is temporarily locked on account of internal processes running in the device (e.g. data upload/download, reset etc.). Once the internal processing has been completed, the parameters can be changed once again.



11.2 Adjusting the operating language

 Detailed information:

- To configure the operating language →  87
- For information on the operating languages supported by the measuring device →  191

11.3 Configuring the display

Detailed information:

- On the basic settings for the local display →  99
- On the advanced settings for the local display →  108

11.4 Reading measured values

With the **Measured values** submenu, it is possible to read all the measured values.

Navigation

"Diagnostics" menu → Measured values → Output values

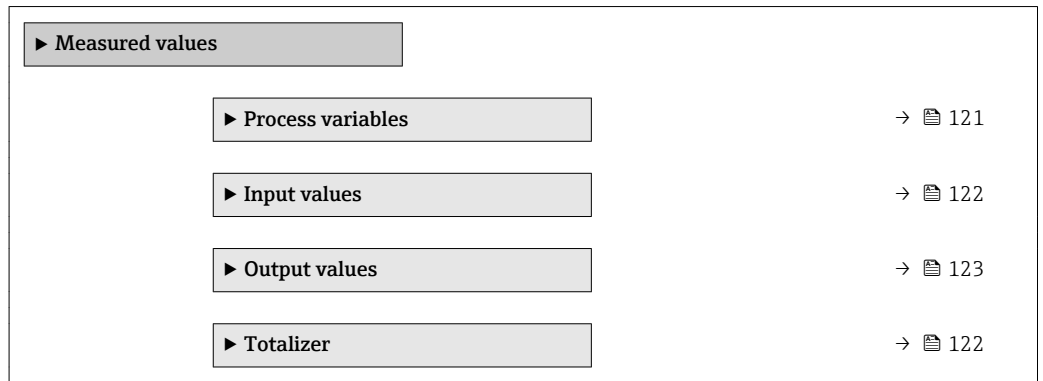

11.4.1 Process variables

The **Process variables** submenu contains all the parameters needed to display the current measured values for each process variable.

Navigation

"Diagnostics" menu → Measured values → Process variables

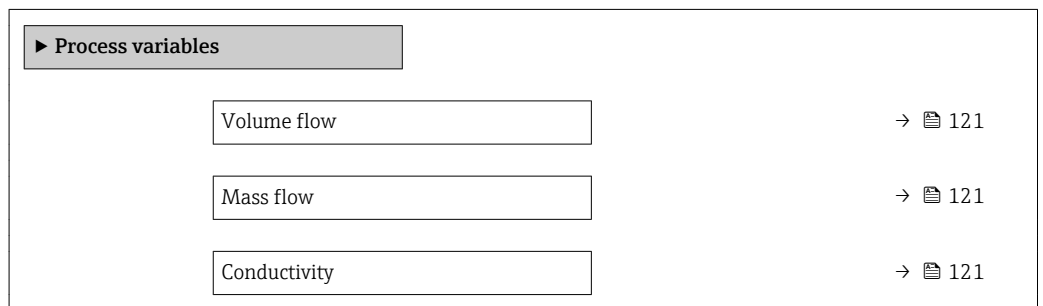

Parameter overview with brief description

Parameter	Prerequisite	Description	User interface
Volume flow	–	Displays the volume flow currently measured. <i>Dependency</i> The unit is taken from the Volume flow unit parameter (→ 90).	Signed floating-point number
Mass flow	–	Displays the mass flow currently calculated. <i>Dependency</i> The unit is taken from the Mass flow unit parameter (→ 90).	Signed floating-point number
Conductivity	The On option is selected in the Conductivity measurement parameter.	Displays the conductivity currently measured. <i>Dependency</i> The unit is taken from the Conductivity unit parameter (→ 90).	Signed floating-point number

11.4.2 "Totalizer" submenu

The **Totalizer** submenu contains all the parameters needed to display the current measured values for every totalizer.

Navigation

"Diagnostics" menu → Measured values → Totalizer

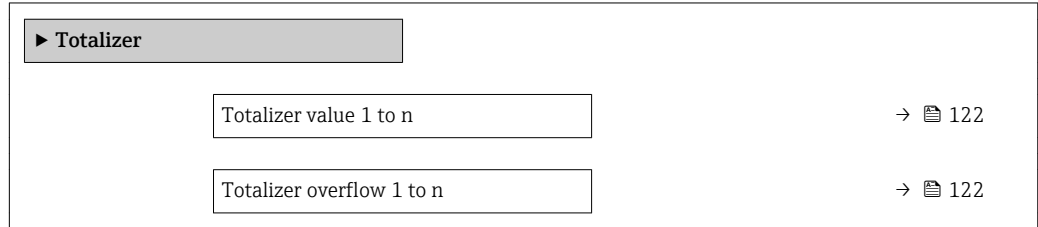

Parameter overview with brief description

Parameter	Prerequisite	Description	User interface
Totalizer value 1 to n	One of the following options is selected in the Assign process variable parameter (→ 107) of the Totalizer 1 to n submenu: <ul style="list-style-type: none"> ▪ Volume flow ▪ Mass flow 	Displays the current totalizer counter value.	Signed floating-point number
Totalizer overflow 1 to n	One of the following options is selected in the Assign process variable parameter (→ 107) of the Totalizer 1 to n submenu: <ul style="list-style-type: none"> ▪ Volume flow ▪ Mass flow 	Displays the current totalizer overflow.	Integer with sign

11.4.3 Input values

The **Input values** submenu guides you systematically to the individual input values.

 The submenu appears only if the device was ordered with a status input → 43.

Navigation

"Diagnostics" menu → Measured values → Input values

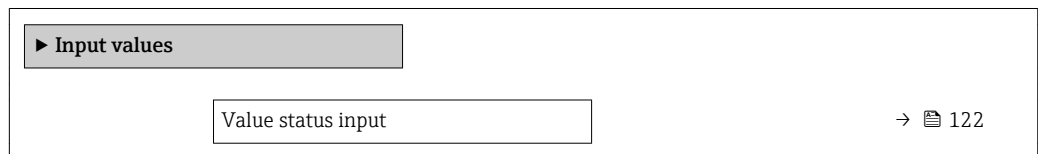

Parameter overview with brief description

Parameter	Prerequisite	Description	User interface
Value status input	For the following order code: <ul style="list-style-type: none"> ▪ "Output; input", option I"4-20mA HART, 2x pul./freq./switch output; status input" ▪ "Output; input", option J"4-20mA HART, certified pulse output, switch output; status input" 	Shows the current input signal level.	<ul style="list-style-type: none"> ▪ High ▪ Low

11.4.4 Output values

The **Output values** submenu contains all the parameters needed to display the current measured values for every output.

-  The parameters displayed depend on:
 - The selected device order
 - The set operating mode of the pulse/frequency/switch outputs

Navigation

"Diagnostics" menu → Measured values → Output values

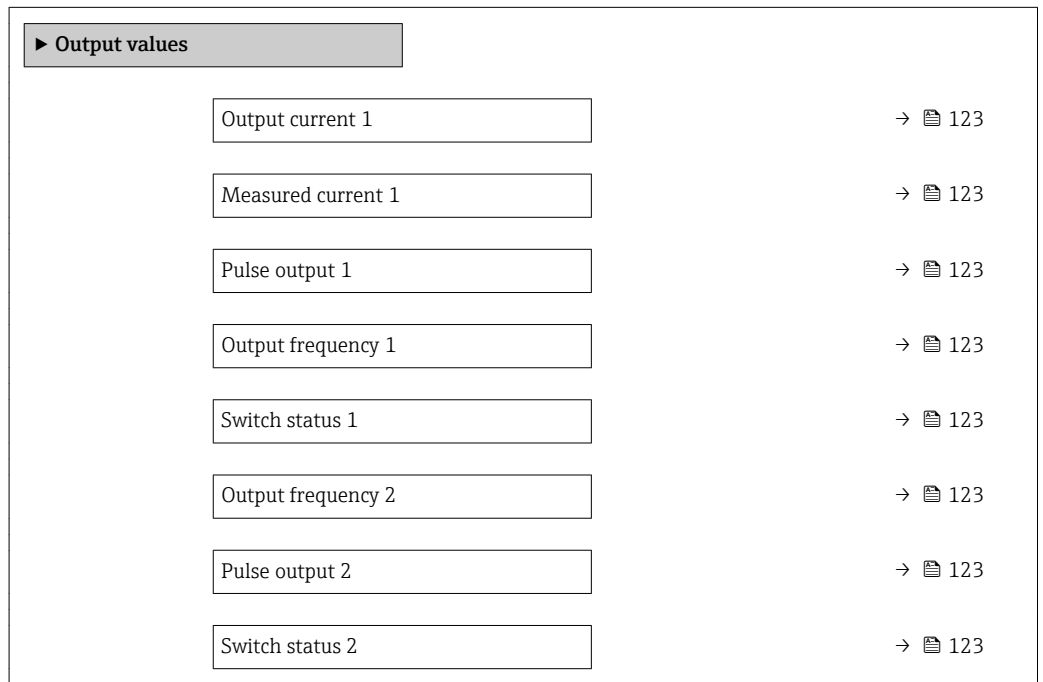



Parameter overview with brief description

Parameter	Prerequisite	Description	User interface
Output current 1	–	Displays the current value currently calculated for the current output.	3.59 to 22.5 mA
Measured current 1	–	Displays the current value currently measured for the current output.	0 to 30 mA
Pulse output 1 to n	In the Operating mode parameter, the Pulse option is selected.	Displays the pulse frequency currently output.	Positive floating-point number
Output frequency 1 to n	In the Operating mode parameter, the Frequency option is selected.	Displays the value currently measured for the frequency output.	0.0 to 12 500.0 Hz
Switch status 1 to n	In the Operating mode parameter, the Switch option is selected.	Displays the current switch output status.	<ul style="list-style-type: none"> ▪ Open ▪ Closed

11.5 Adapting the measuring device to the process conditions

The following are available for this purpose:

- Basic settings using the **Setup** menu (→  87)
- Advanced settings using the **Advanced setup** submenu (→  105)

11.6 Performing a totalizer reset

The totalizers are reset in the **Operation** submenu:

- Control Totalizer
- Reset all totalizers

Navigation

"Operation" menu → Totalizer handling

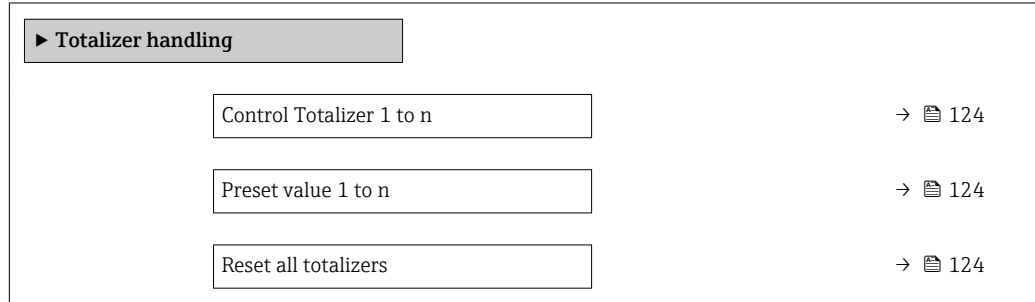

Parameter overview with brief description

Parameter	Prerequisite	Description	Selection / User entry	Factory setting
Control Totalizer 1 to n	One of the following options is selected in the Assign process variable parameter (→ 107) of the Totalizer 1 to n submenu: <ul style="list-style-type: none"> ■ Volume flow ■ Mass flow 	Control totalizer value.	<ul style="list-style-type: none"> ■ Totalize ■ Reset + hold ■ Preset + hold ■ Reset + totalize ■ Preset + totalize ■ Hold 	Totalize
Preset value 1 to n	One of the following options is selected in the Assign process variable parameter (→ 107) of the Totalizer 1 to n submenu: <ul style="list-style-type: none"> ■ Volume flow ■ Mass flow 	Specify start value for totalizer. <i>Dependency</i> The unit of the selected process variable is specified for the totalizer in the Unit totalizer parameter (→ 107).	Signed floating-point number	0 l
Reset all totalizers	-	Reset all totalizers to 0 and start.	<ul style="list-style-type: none"> ■ Cancel ■ Reset + totalize 	Cancel

11.6.1 Function scope of the "Control Totalizer" parameter



Options	Description
Totalize	The totalizer is started or continues running.
Reset + hold	The totaling process is stopped and the totalizer is reset to 0.
Preset + hold	The totaling process is stopped and the totalizer is set to its defined start value from the Preset value parameter.
Reset + totalize	The totalizer is reset to 0 and the totaling process is restarted.
Preset + totalize	The totalizer is set to the defined start value from the Preset value parameter and the totaling process is restarted.

11.6.2 Function scope of the "Reset all totalizers" parameter

Options	Description
Cancel	No action is executed and the user exits the parameter.
Reset + totalize	Resets all totalizers to 0 and restarts the totaling process. This deletes all the flow values previously totalized.

11.7 Showing data logging

The **Extended HistoROM** application package must be enabled in the device (order option) for the **Data logging** submenu to appear. This contains all the parameters for the measured value history.

-  Data logging is also available via:
 - Plant Asset Management Tool FieldCare →  80.
 - Web browser

Function range

- A total of 1000 measured values can be stored
- 4 logging channels
- Adjustable logging interval for data logging
- Display of the measured value trend for each logging channel in the form of a chart

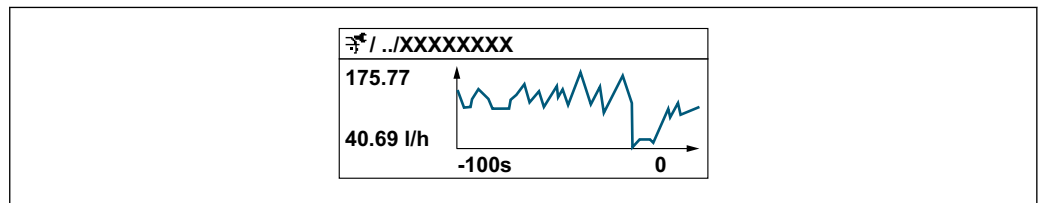

A0034352







- x-axis: depending on the number of channels selected displays 250 to 1000 measured values of a process variable.
- y-axis: displays the approximate measured value span and constantly adapts this to the ongoing measurement.

 If the length of the logging interval or the assignment of the process variables to the channels is changed, the content of the data logging is deleted.

Navigation





"Diagnostics" menu → Data logging

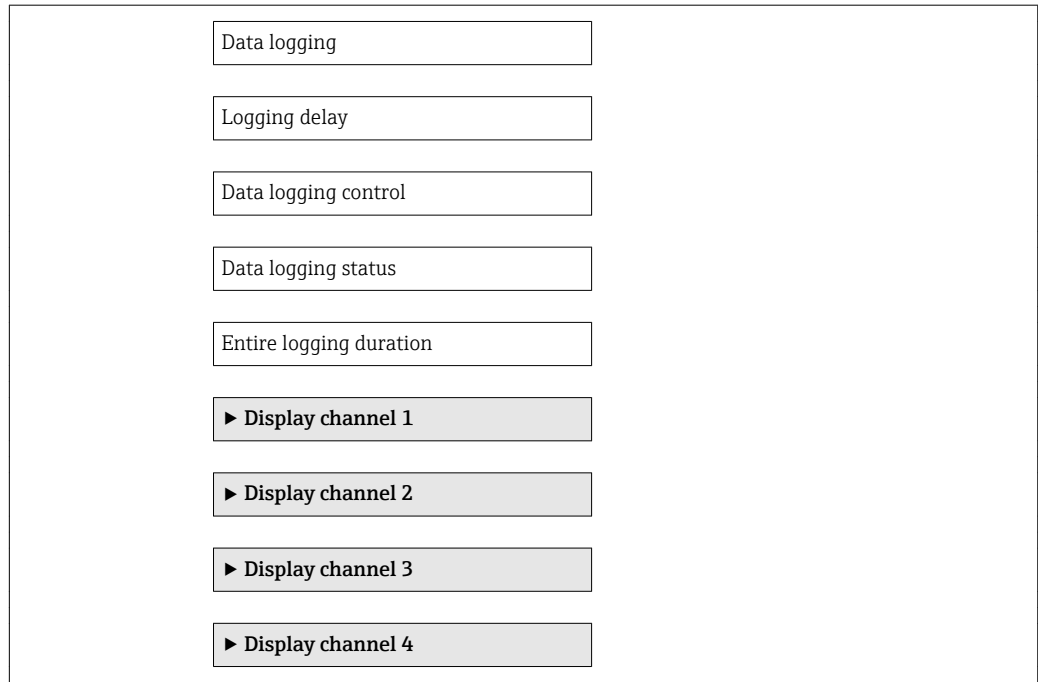

▶ Data logging

- Assign channel 1 →  126
- Assign channel 2 →  126
- Assign channel 3 →  126
- Assign channel 4 →  127
- Logging interval →  127
- Clear logging data →  127



Parameter overview with brief description

Parameter	Prerequisite	Description	Selection / User entry	Factory setting
Assign channel 1	The Extended HistoROM application package is available.  The software options currently enabled are displayed in the Software option overview parameter.	Assign a process variable to logging channel.	<ul style="list-style-type: none"> ▪ Off ▪ Volume flow ▪ Mass flow ▪ Corrected volume flow ▪ Flow velocity ▪ Conductivity * ▪ Corrected conductivity * ▪ Temperature ▪ Electronic temperature ▪ Current output 1 * 	Off
Assign channel 2	The Extended HistoROM application package is available.  The software options currently enabled are displayed in the Software option overview parameter.	Assign process variable to logging channel.	Picklist, see Assign channel 1 parameter (→  126)	Off
Assign channel 3	The Extended HistoROM application package is available.  The software options currently enabled are displayed in the Software option overview parameter.	Assign process variable to logging channel.	Picklist, see Assign channel 1 parameter (→  126)	Off











Parameter	Prerequisite	Description	Selection / User entry	Factory setting
Assign channel 4	The Extended HistoROM application package is available.  The software options currently enabled are displayed in the Software option overview parameter.	Assign process variable to logging channel.	Picklist, see Assign channel 1 parameter (→  126)	Off
Logging interval	The Extended HistoROM application package is available.	Define the logging interval for data logging. This value defines the time interval between the individual data points in the memory.	0.1 to 999.0 s	1.0 s
Clear logging data	The Extended HistoROM application package is available.	Clear the entire logging data.	<ul style="list-style-type: none"> ■ Cancel ■ Clear data 	Cancel

* Visibility depends on order options or device settings

12 Diagnostics and troubleshooting

12.1 General troubleshooting









For local display

Error	Possible causes	Solution
Local display dark and no output signals	Supply voltage does not match the value indicated on the nameplate.	Apply the correct supply voltage →  48 →  48.
Local display dark and no output signals	No contact between connecting cables and terminals.	Check the connection of the cables and correct if necessary.
Local display dark and no output signals	Terminals are not plugged into the main electronics module correctly.	Check terminals.
Local display dark and no output signals	Main electronics module is defective.	Order spare part →  148.
Local display dark and no output signals	The connector between the main electronics module and display module is not plugged in correctly.	Check the connection and correct if necessary.
Local display dark and no output signals	The connecting cable is not plugged in correctly.	1. Check the connection of the electrode cable and correct if necessary. 2. Check the connection of the coil current cable and correct if necessary.
Local display is dark, but signal output is within the valid range	Display is set too bright or too dark.	<ul style="list-style-type: none"> ▪ Set the display brighter by simultaneously pressing  + . ▪ Set the display darker by simultaneously pressing  + .
Local display is dark, but signal output is within the valid range	Display module is defective.	Order spare part →  148.
Backlighting of local display is red	Diagnostic event with "Alarm" diagnostic behavior has occurred.	Take remedial measures
Text on local display appears in a foreign language and cannot be understood.	Incorrect operating language is configured.	1. Press  +  for 2 s ("home position"). 2. Press  . 3. Set the desired language in the Display language parameter (→  110).
Message on local display: "Communication Error" "Check Electronics"	Communication between the display module and the electronics is interrupted.	<ul style="list-style-type: none"> ▪ Check the cable and the connector between the main electronics module and display module. ▪ Order spare part →  148.

For output signals

Error	Possible causes	Solution
Signal output outside the valid range	Main electronics module is defective.	Order spare part →  148.
Device shows correct value on local display, but signal output is incorrect, though in the valid range.	Configuration error	Check and correct the parameter configuration.
Device measures incorrectly.	Configuration error or device is operated outside the application.	1. Check and correct parameter configuration. 2. Observe limit values specified in the "Technical Data".

For access

Error	Possible causes	Solution
No write access to parameters	Hardware write protection enabled	Set the write protection switch on main electronics module to the OFF position →  118.
No write access to parameters	Current user role has limited access authorization	1. Check user role →  70. 2. Enter correct customer-specific access code →  70.
No connection via HART protocol	Communication resistor missing or incorrectly installed.	Install the communication resistor (250 Ω) correctly. Observe the maximum load →  157.
No connection via HART protocol	Commubox <ul style="list-style-type: none"> ▪ Connected incorrectly ▪ Configured incorrectly ▪ Drivers not installed correctly ▪ USB interface on computer configured incorrectly 	Observe the documentation for the Commubox.  FXA195 HART: Document "Technical Information" TI00404F
Not connecting to Web server	Web server disabled	Using the "FieldCare" or "DeviceCare" operating tool, check whether the Web server of the measuring device is enabled, and enable it if necessary →  77.
	Incorrect setting for the Ethernet interface of the computer	1. Check the properties of the Internet protocol (TCP/IP) →  73. 2. Check the network settings with the IT manager.
Not connecting to Web server	Incorrect IP address	Check the IP address: 192.168.1.212 →  73
Not connecting to Web server	Incorrect WLAN access data	<ul style="list-style-type: none"> ▪ Check WLAN network status. ▪ Log on to the device again using WLAN access data. ▪ Verify that WLAN is enabled on the measuring device and operating device .
	WLAN communication disabled	–
Not connecting to Web server, FieldCare or DeviceCare	No WLAN network available	<ul style="list-style-type: none"> ▪ Check if WLAN reception is present: LED on display module is lit blue ▪ Check if WLAN connection is enabled: LED on display module flashes blue ▪ Switch on instrument function.
	WLAN network is weak.	Operating device is outside of reception range: Check network status on operating device.
Network connection not present or unstable	Parallel WLAN and Ethernet communication	<ul style="list-style-type: none"> ▪ Check network settings. ▪ Temporarily enable only the WLAN as an interface.
	WLAN network is weak.	Operating device is outside of reception range: Check network status on operating device.
Web browser frozen and operation no longer possible	Data transfer active	Wait until data transfer or current action is finished.
	Connection lost	1. Check cable connection and power supply. 2. Refresh the Web browser and restart if necessary.
Content of Web browser incomplete or difficult to read	Not using optimum version of Web server.	1. Use the correct Web browser version . 2. Clear the Web browser cache and restart the Web browser.
	Unsuitable view settings.	Change the font size/display ratio of the Web browser.

Error	Possible causes	Solution
No or incomplete display of contents in the Web browser	<ul style="list-style-type: none"> ▪ JavaScript not enabled ▪ JavaScript cannot be enabled 	<ol style="list-style-type: none"> 1. Enable JavaScript. 2. Enter http://192.168.1.212/basic.html as the IP address.
Operation with FieldCare or DeviceCare via CDI-RJ45 service interface (port 8000)	Firewall of computer or network is preventing communication	Depending on the settings of the firewall used on the computer or in the network, the firewall must be adapted or disabled to allow FieldCare/DeviceCare access.
Flashing of firmware with FieldCare or DeviceCare via CDI-RJ45 service interface (via port 8000 or TFTP ports)	Firewall of computer or network is preventing communication	Depending on the settings of the firewall used on the computer or in the network, the firewall must be adapted or disabled to allow FieldCare/DeviceCare access.

12.2 Diagnostic information via light emitting diodes

12.2.1 Transmitter

Different LEDs in the transmitter provide information on the device status.

LED	Color	Meaning
Supply voltage	Off	Supply voltage is off or too low
	Green	Supply voltage is ok
Link/Activity	Orange	Link available but no activity
	Flashing orange	Activity present
Communication	Flashing white	HART communication is active.
Alarm	Green	Measuring device is ok
	Flashing green	Measuring device not configured
	Off	Firmware error
	Red	Main error
	Flashing red	Error
	Flashing red/green	Start measuring device

12.3 Diagnostic information on local display

12.3.1 Diagnostic message

Faults detected by the self-monitoring system of the measuring device are displayed as a diagnostic message in alternation with the operational display.

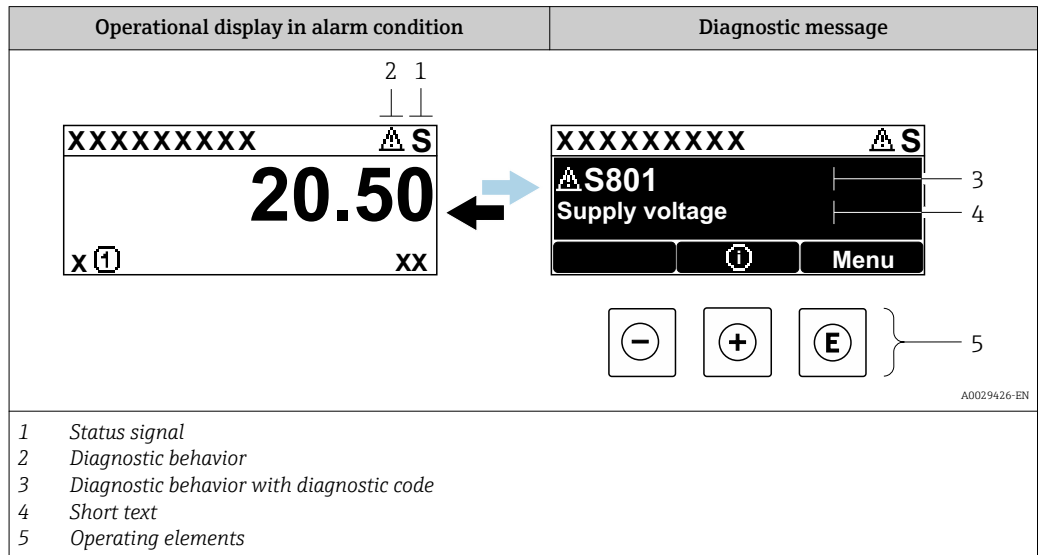

If two or more diagnostic events are pending simultaneously, only the message of the diagnostic event with the highest priority is shown.

- i** Other diagnostic events that have occurred can be displayed in the **Diagnostics** menu:
 - Via parameter
 - Via submenus → 141



Status signals

The status signals provide information on the state and reliability of the device by categorizing the cause of the diagnostic information (diagnostic event).

- i** The status signals are categorized according to VDI/VDE 2650 and NAMUR Recommendation NE 107: F = Failure, C = Function Check, S = Out of Specification, M = Maintenance Required

Symbol	Meaning
F	Failure A device error has occurred. The measured value is no longer valid.
C	Function check The device is in service mode (e.g. during a simulation).
S	Out of specification The device is operated: <ul style="list-style-type: none"> ▪ Outside its technical specification limits (e.g. outside the process temperature range) ▪ Outside of the configuration carried out by the user (e.g. maximum flow in parameter 20 mA value)
M	Maintenance required Maintenance is required. The measured value remains valid.

Diagnostic behavior



Symbol	Meaning
	Alarm <ul style="list-style-type: none"> ▪ Measurement is interrupted. ▪ Signal outputs and totalizers assume the defined alarm condition. ▪ A diagnostic message is generated. ▪ The background lighting changes to red.
	Warning Measurement is resumed. The signal outputs and totalizers are not affected. A diagnostic message is generated.

Diagnostic information

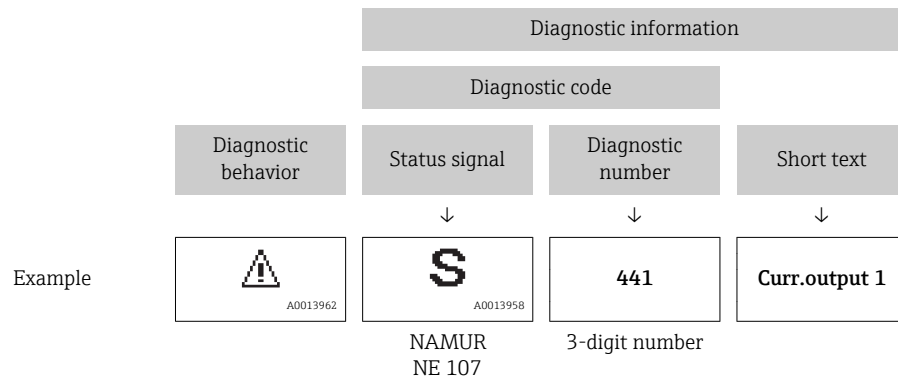
The fault can be identified using the diagnostic information. The short text helps you by providing information about the fault. In addition, the corresponding symbol for the diagnostic behavior is displayed in front of the diagnostic information on the local display.



Operating elements

Key	Meaning
	Plus key <i>In a menu, submenu</i> Opens the message about remedy information.
	Enter key <i>In a menu, submenu</i> Opens the operating menu.

12.3.2 Calling up remedial measures

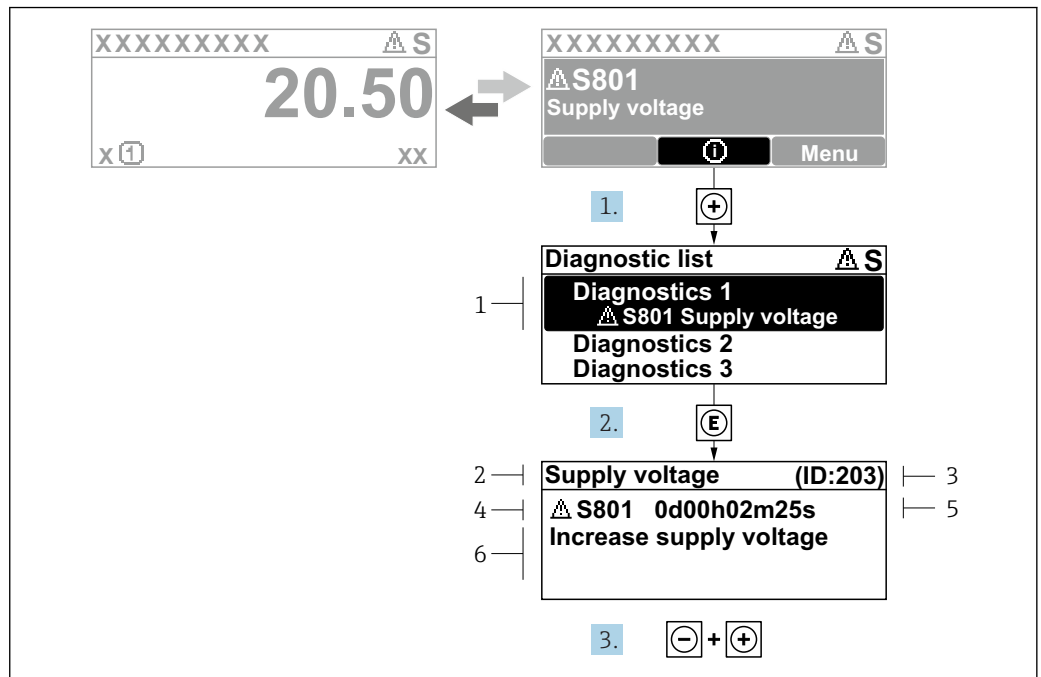

34 Message about remedial measures

- 1 Diagnostic information
- 2 Short text
- 3 Service ID
- 4 Diagnostic behavior with diagnostic code
- 5 Operation time of occurrence
- 6 Remedial measures

1. The user is in the diagnostic message.
Press \oplus ($\text{\textcircled{1}}$ symbol).
↳ The **Diagnostic list** submenu opens.
2. Select the desired diagnostic event with \oplus or \ominus and press $\text{\textcircled{E}}$.
↳ The message about the remedial measures opens.
3. Press \ominus + \oplus simultaneously.
↳ The message about the remedial measures closes.

The user is in the **Diagnostics** menu at an entry for a diagnostics event, e.g. in the **Diagnostic list** submenu or **Previous diagnostics** parameter.

1. Press $\text{\textcircled{E}}$.
↳ The message for the remedial measures for the selected diagnostic event opens.
2. Press \ominus + \oplus simultaneously.
↳ The message for the remedial measures closes.

12.4 Diagnostic information in the Web browser

12.4.1 Diagnostic options

Any faults detected by the measuring device are displayed in the Web browser on the home page once the user has logged on.

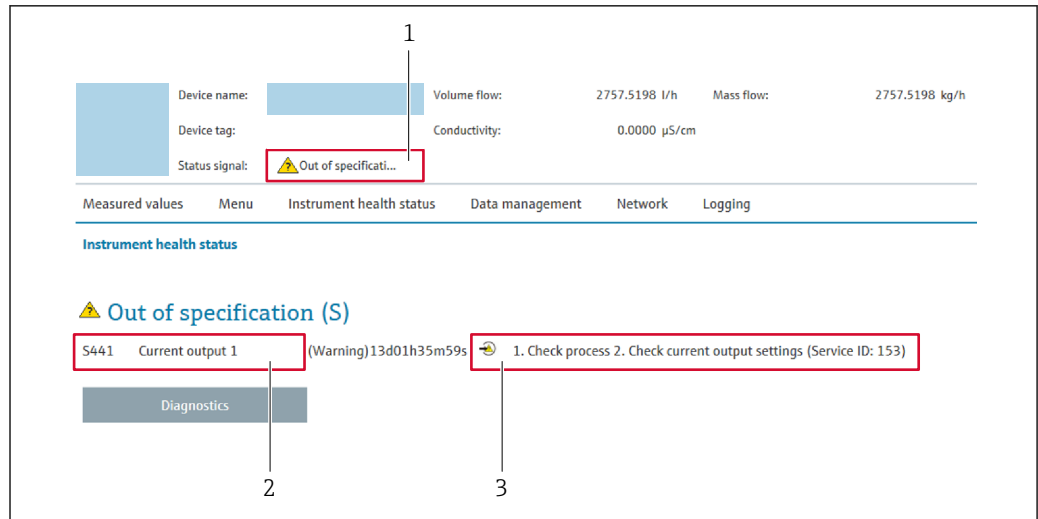

- 1 Status area with status signal
- 2 Diagnostic information → 132
- 3 Remedy information with Service ID

i In addition, diagnostic events which have occurred can be shown in the **Diagnostics** menu:

- Via parameter
- Via submenu → 141

Status signals

The status signals provide information on the state and reliability of the device by categorizing the cause of the diagnostic information (diagnostic event).

Symbol	Meaning
	Failure A device error has occurred. The measured value is no longer valid.
	Function check The device is in service mode (e.g. during a simulation).
	Out of specification The device is operated: <ul style="list-style-type: none"> ▪ Outside its technical specification limits (e.g. outside the process temperature range) ▪ Outside of the configuration carried out by the user (e.g. maximum flow in parameter 20 mA value)
	Maintenance required Maintenance is required. The measured value is still valid.

i The status signals are categorized in accordance with VDI/VDE 2650 and NAMUR Recommendation NE 107.

12.4.2 Calling up remedy information

Remedy information is provided for every diagnostic event to ensure that problems can be rectified quickly. These measures are displayed in red along with the diagnostic event and the related diagnostic information.

12.5 Diagnostic information in DeviceCare or FieldCare

12.5.1 Diagnostic options

Any faults detected by the measuring device are displayed on the home page of the operating tool once the connection has been established.

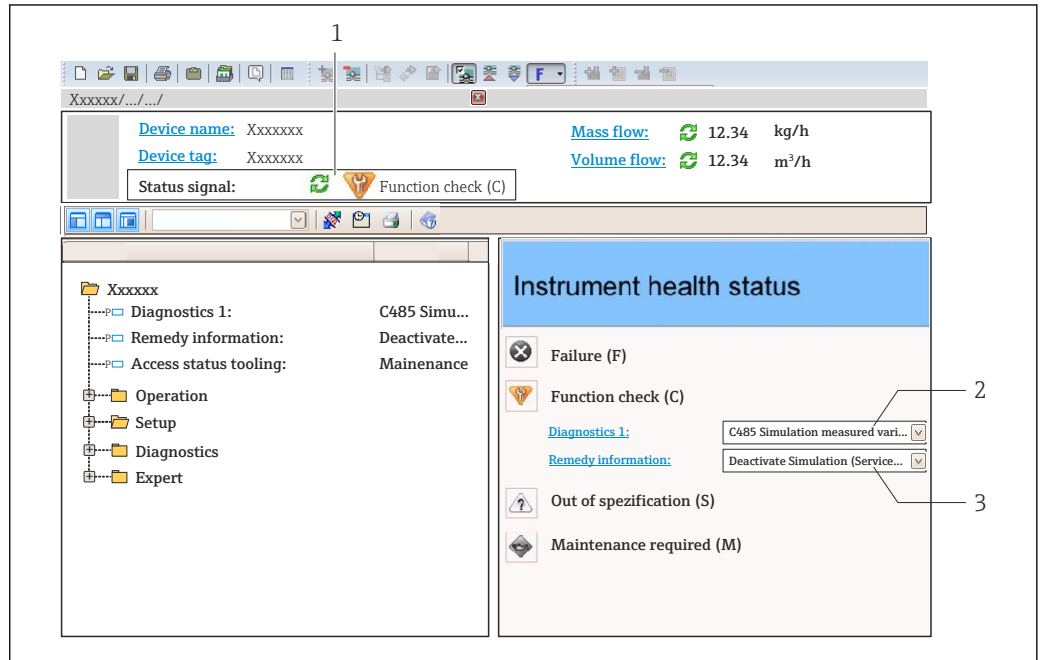

- 1 Status area with status signal → 131
- 2 Diagnostic information → 132
- 3 Remedy information with Service ID

i In addition, diagnostic events which have occurred can be shown in the **Diagnostics** menu:

- Via parameter
- Via submenu → 141

Diagnostic information

The fault can be identified using the diagnostic information. The short text helps you by providing information about the fault. In addition, the corresponding symbol for the diagnostic behavior is displayed in front of the diagnostic information on the local display.

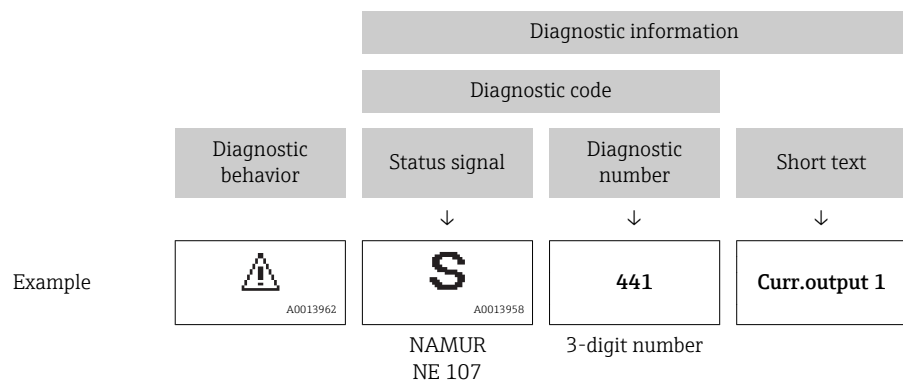

12.5.2 Calling up remedy information

Remedy information is provided for every diagnostic event to ensure that problems can be rectified quickly:

- On the home page
Remedy information is displayed in a separate field below the diagnostics information.
- In the **Diagnostics** menu
Remedy information can be called up in the working area of the user interface.

The user is in the **Diagnostics** menu.

1. Call up the desired parameter.
2. On the right in the working area, mouse over the parameter.
 - ↳ A tool tip with remedy information for the diagnostic event appears.

12.6 Adapting the diagnostic information

12.6.1 Adapting the diagnostic behavior

Each item of diagnostic information is assigned a specific diagnostic behavior at the factory. The user can change this assignment for specific diagnostic information in the **Diagnostic behavior** submenu.

Expert → System → Diagnostic handling → Diagnostic behavior

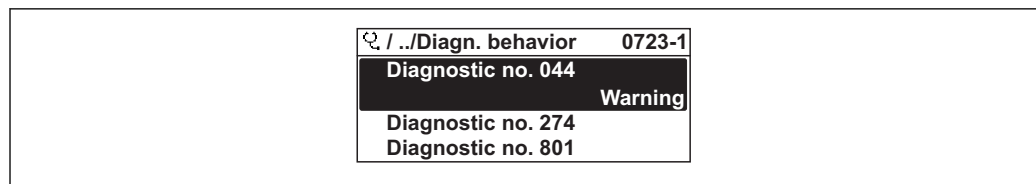

A0014048-EN

35 Taking the example of the local display

You can assign the following options to the diagnostic number as the diagnostic behavior:

Options	Description
Alarm	The device stops measurement. The signal outputs and totalizers assume the defined alarm condition. A diagnostic message is generated. The background lighting changes to red.
Warning	The device continues to measure. The signal outputs and totalizers are not affected. A diagnostic message is generated.
Logbook entry only	The device continues to measure. The diagnostic message is displayed only in the Event logbook submenu (Event list submenu) and is not displayed in alternation with the operational display.
Off	The diagnostic event is ignored, and no diagnostic message is generated or entered.

12.6.2 Adapting the status signal

Each item of diagnostic information is assigned a specific status signal at the factory. The user can change this assignment for specific diagnostic information in the **Diagnostic event category** submenu.

Expert → Communication → Diagnostic event category



Available status signals

Configuration as per HART 7 Specification (Condensed Status), in accordance with NAMUR NE107.

Symbol	Meaning
F <small>A0013956</small>	Failure A device error is present. The measured value is no longer valid.
C <small>A0013959</small>	Function check The device is in service mode (e.g. during a simulation).
S <small>A0013958</small>	Out of specification The device is being operated: <ul style="list-style-type: none"> ▪ Outside its technical specification limits (e.g. outside the process temperature range) ▪ Outside of the configuration carried out by the user (e.g. maximum flow in parameter 20 mA value)
M <small>A0013957</small>	Maintenance required Maintenance is required. The measured value is still valid.
N <small>A0023076</small>	Has no effect on the condensed status.

12.7 Overview of diagnostic information

 The amount of diagnostic information and the number of measured variables affected increase if the measuring device has one or more application packages.

 In the case of some items of diagnostic information, the status signal and the diagnostic behavior can be changed. Change the diagnostic information →  136

Diagnostic number	Short text	Remedy instructions	Status signal [from the factory]	Diagnostic behavior [from the factory]
Diagnostic of sensor				
043	Sensor short circuit	1. Check sensor cable and sensor 2. Execute Heartbeat Verification 3. Replace sensor cable or sensor	S	Warning ¹⁾
082	Data storage	1. Check module connections 2. Contact service	F	Alarm
083	Memory content	1. Restart device 2. Restore HistoROM S-DAT backup ('Device reset' parameter) 3. Replace HistoROM S-DAT	F	Alarm
170	Coil resistance	Check ambient and process temperature	F	Alarm
180	Temperature sensor defective	1. Check sensor connections 2. Replace sensor cable or sensor 3. Turn off temperature measurement	F	Warning
181	Sensor connection	1. Check sensor cable and sensor 2. Execute Heartbeat Verification 3. Replace sensor cable or sensor	F	Alarm
Diagnostic of electronic				
201	Device failure	1. Restart device 2. Contact service	F	Alarm

Diagnostic number	Short text	Remedy instructions	Status signal [from the factory]	Diagnostic behavior [from the factory]
242	Software incompatible	1. Check software 2. Flash or change main electronics module	F	Alarm
252	Modules incompatible	1. Check electronic modules 2. Change electronic modules	F	Alarm
261	Electronic modules	1. Restart device 2. Check electronic modules 3. Change I/O Modul or main electronics	F	Alarm
262	Sensor electronic connection faulty	1. Check or replace connection cable between sensor electronic module (ISEM) and main electronics 2. Check or replace ISEM or main electronics	F	Alarm
270	Main electronic failure	Change main electronic module	F	Alarm
271	Main electronic failure	1. Restart device 2. Change main electronic module	F	Alarm
272	Main electronic failure	1. Restart device 2. Contact service	F	Alarm
273	Main electronic failure	Change electronic	F	Alarm
275	I/O module defective	Change I/O module	F	Alarm
276	I/O module faulty	1. Restart device 2. Change I/O module	F	Alarm
283	Memory content	1. Reset device 2. Contact service	F	Alarm
302	Device verification active	Device verification active, please wait.	C	Warning
311	Electronic failure	1. Do not reset device 2. Contact service	M	Warning
372	Sensor electronic (ISEM) faulty	1. Restart device 2. Check if failure recurs 3. Replace sensor electronic module (ISEM)	F	Alarm
373	Sensor electronic (ISEM) faulty	1. Transfer data or reset device 2. Contact service	F	Alarm
375	I/O- communication failed	1. Restart device 2. Check if failure recurs 3. Replace module rack inclusive electronic modules	F	Alarm
376	Sensor electronic (ISEM) faulty	1. Replace sensor electronic module (ISEM) 2. Turn off diagnostic message	F	Warning ¹⁾
377	Sensor electronic (ISEM) faulty	1. Check sensor cable and sensor 2. Perform Heartbeat Verification 3. Replace sensor cable or sensor	F	Warning ¹⁾
382	Data storage	1. Insert T-DAT 2. Replace T-DAT	F	Alarm
383	Memory content	1. Restart device 2. Delete T-DAT via 'Reset device' parameter 3. Replace T-DAT	F	Alarm
512	Sensor electronic (ISEM) faulty	1. Check ECC recovery time 2. Turn off ECC	F	Alarm

Diagnostic number	Short text	Remedy instructions	Status signal [from the factory]	Diagnostic behavior [from the factory]
Diagnostic of configuration				
410	Data transfer	1. Check connection 2. Retry data transfer	F	Alarm
412	Processing download	Download active, please wait	C	Warning
431	Trim 1	Carry out trim	C	Warning
437	Configuration incompatible	1. Restart device 2. Contact service	F	Alarm
438	Dataset	1. Check data set file 2. Check device configuration 3. Up- and download new configuration	M	Warning
441	Current output	1. Check process 2. Check current output settings	S	Warning ¹⁾
442	Frequency output 1 to n	1. Check process 2. Check frequency output settings	S	Warning ¹⁾
443	Pulse output 1 to n	1. Check process 2. Check pulse output settings	S	Warning ¹⁾
453	Flow override	Deactivate flow override	C	Warning
484	Failure mode simulation	Deactivate simulation	C	Alarm
485	Measured variable simulation	Deactivate simulation	C	Warning
491	Current output 1 simulation	Deactivate simulation	C	Warning
492	Simulation frequency output 1 to n	Deactivate simulation frequency output	C	Warning
493	Simulation pulse output 1 to n	Deactivate simulation pulse output	C	Warning
494	Switch output simulation 1 to n	Deactivate simulation switch output	C	Warning
495	Diagnostic event simulation	Deactivate simulation	C	Warning
496	Status input simulation	Deactivate simulation status input	C	Warning
502	CT activation/deactivation failed	Follow the sequence of the custody transfer activation/deactivation: First authorized user login, then set the DIP switch on the main electronic module	C	Warning
511	Sensor electronic (ISEM) faulty	1. Check measuring period and integration time 2. Check sensor properties	C	Alarm
530	Electrode cleaning is running	Turn off ECC	C	Warning
531	Empty pipe detection	Execute EPD adjustment	S	Warning ¹⁾
537	Configuration	1. Check IP addresses in network 2. Change IP address	F	Warning
540	Custody transfer mode failed	1. Deactivate custody transfer mode 2. Reactivate custody transfer mode	F	Alarm
599	Custody transfer logbook full	1. Deactivate custody transfer mode 2. Clear custody transfer logbook (all 30 entries) 3. Activate custody transfer mode	F	Warning





Diagnostic number	Short text	Remedy instructions	Status signal [from the factory]	Diagnostic behavior [from the factory]
Diagnostic of process				
803	Current loop	1. Check wiring 2. Change I/O module	F	Alarm
832	Electronic temperature too high	Reduce ambient temperature	S	Warning ¹⁾
833	Electronic temperature too low	Increase ambient temperature	S	Warning ¹⁾
834	Process temperature too high	Reduce process temperature	S	Warning ¹⁾
835	Process temperature too low	Increase process temperature	S	Warning ¹⁾
842	Process limit	Low flow cut off active! 1. Check low flow cut off configuration	S	Warning
882	Input signal	1. Check input configuration 2. Check external device or process conditions	F	Alarm
937	EMC interference	1. Eliminate external magnetic field near sensor 2. Turn off diagnostic message	S	Warning ¹⁾
938	EMC interference	1. Check ambient conditions regarding EMC influence 2. Turn off diagnostic message	F	Alarm ¹⁾
962	Empty pipe	1. Perform full pipe adjustment 2. Perform empty pipe adjustment 3. Turn off empty pipe detection	S	Warning ¹⁾



1) Diagnostic behavior can be changed.

12.8 Pending diagnostic events

The **Diagnostics** menu allows the user to view the current diagnostic event and the previous diagnostic event separately.



 To call up the measures to rectify a diagnostic event:

- Via local display →  133
- Via Web browser →  134
- Via "FieldCare" operating tool →  136
- Via "DeviceCare" operating tool →  136

 Other pending diagnostic events can be displayed in the **Diagnostic list** submenu →  141

Navigation

"Diagnostics" menu

 Diagnostics	
Actual diagnostics	→  141
Previous diagnostics	→  141

Operating time from restart	→ ⓘ 141
Operating time	→ ⓘ 141

Parameter overview with brief description

Parameter	Prerequisite	Description	User interface
Actual diagnostics	A diagnostic event has occurred.	Shows the current occurred diagnostic event along with its diagnostic information. ⓘ If two or more messages occur simultaneously, the message with the highest priority is shown on the display.	Symbol for diagnostic behavior, diagnostic code and short message.
Previous diagnostics	Two diagnostic events have already occurred.	Shows the diagnostic event that occurred prior to the current diagnostic event along with its diagnostic information.	Symbol for diagnostic behavior, diagnostic code and short message.
Operating time from restart	–	Shows the time the device has been in operation since the last device restart.	Days (d), hours (h), minutes (m) and seconds (s)
Operating time	–	Indicates how long the device has been in operation.	Days (d), hours (h), minutes (m) and seconds (s)

12.9 Diagnostic list

Up to 5 currently pending diagnostic events can be displayed in the **Diagnostic list** submenu along with the associated diagnostic information. If more than 5 diagnostic events are pending, the events with the highest priority are shown on the display.

Navigation path

Diagnostics → Diagnostic list

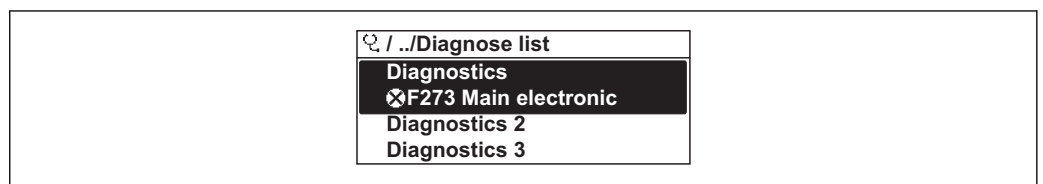

A0014006-EN

36 Taking the example of the local display

ⓘ To call up the measures to rectify a diagnostic event:

- Via local display → ⓘ 133
- Via Web browser → ⓘ 134
- Via "FieldCare" operating tool → ⓘ 136
- Via "DeviceCare" operating tool → ⓘ 136

12.10 Event logbook

12.10.1 Reading out the event logbook

A chronological overview of the event messages that have occurred is provided in the **Events list** submenu.

Navigation path

Diagnostics menu → **Event logbook** submenu → Event list

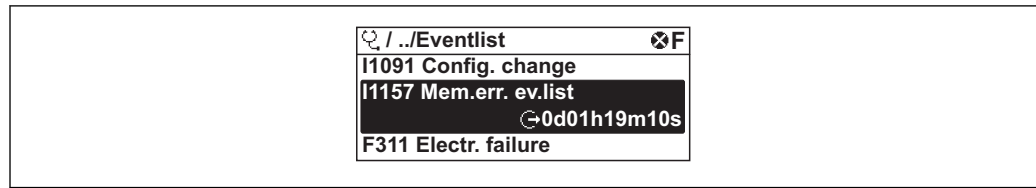

A0014008-EN

37 Taking the example of the local display

- A maximum of 20 event messages can be displayed in chronological order.
- If the **Extended HistoROM** application package (order option) is enabled in the device, the event list can contain up to 100 entries .

The event history includes entries for:

- Diagnostic events → 137
- Information events → 142

In addition to the operation time of its occurrence, each event is also assigned a symbol that indicates whether the event has occurred or is ended:

- Diagnostic event
 - : Occurrence of the event
 - : End of the event
- Information event
 - : Occurrence of the event

To call up the measures to rectify a diagnostic event:

- Via local display → 133
- Via Web browser → 134
- Via "FieldCare" operating tool → 136
- Via "DeviceCare" operating tool → 136

For filtering the displayed event messages → 142

12.10.2 Filtering the event logbook

Using the **Filter options** parameter you can define which category of event message is displayed in the **Events list** submenu.

Navigation path

Diagnostics → Event logbook → Filter options

Filter categories

- All
- Failure (F)
- Function check (C)
- Out of specification (S)
- Maintenance required (M)
- Information (I)

12.10.3 Overview of information events

Unlike a diagnostic event, an information event is displayed in the event logbook only and not in the diagnostic list.

Info number	Info name
I1000	----- (Device ok)
I1079	Sensor changed

Info number	Info name
I1089	Power on
I1090	Configuration reset
I1091	Configuration changed
I1092	Embedded HistoROM deleted
I1137	Electronic changed
I1151	History reset
I1155	Reset electronic temperature
I1156	Memory error trend
I1157	Memory error event list
I1184	Display connected
I1256	Display: access status changed
I1278	I/O module reset detected
I1335	Firmware changed
I1351	Empty pipe detection adjustment failure
I1353	Empty pipe detection adjustment ok
I1361	Web server login failed
I1397	Fieldbus: access status changed
I1398	CDI: access status changed
I1443	Coating thickness not determined
I1444	Device verification passed
I1445	Device verification failed
I1457	Measured error verification failed
I1459	I/O module verification failed
I1461	Sensor verification failed
I1462	Sensor electronic module verific. failed
I1512	Download started
I1513	Download finished
I1514	Upload started
I1515	Upload finished
I1517	Custody transfer active
I1518	Custody transfer inactive
I1622	Calibration changed
I1624	Reset all totalizers
I1625	Write protection activated
I1626	Write protection deactivated
I1627	Web server login successful
I1628	Display login successful
I1629	CDI login successful
I1631	Web server access changed
I1632	Display login failed
I1633	CDI login failed
I1634	Parameter factory reset
I1635	Parameter delivery reset

Info number	Info name
I1643	Custody transfer logbook cleared
I1649	Hardware write protection activated
I1650	Hardware write protection deactivated
I1651	Custody transfer parameter changed
I1725	Sensor electronic module (ISEM) changed

12.11 Resetting the measuring device

Using the **Device reset** parameter (→ ⓘ 114) it is possible to reset the entire device configuration or some of the configuration to a defined state.

12.11.1 Function scope of the "Device reset" parameter

Options	Description
Cancel	No action is executed and the user exits the parameter.
To delivery settings	Every parameter for which a customer-specific default setting was ordered is reset to this customer-specific value. All other parameters are reset to the factory setting.
Restart device	The restart resets every parameter whose data are in the volatile memory (RAM) to the factory setting (e.g. measured value data). The device configuration remains unchanged.

12.12 Device information

The **Device information** submenu contains all parameters that display different information for device identification.





Navigation

"Diagnostics" menu → Device information

▶ Device information	
Device tag	→ ⓘ 145
Serial number	→ ⓘ 145
Firmware version	→ ⓘ 145
Device name	→ ⓘ 145
Order code	→ ⓘ 145
Extended order code 1	→ ⓘ 145
Extended order code 2	→ ⓘ 145
Extended order code 3	→ ⓘ 145

ENP version	→ ⓘ 145
Device revision	→ ⓘ 145
Device ID	→ ⓘ 145
Device type	→ ⓘ 146
Manufacturer ID	→ ⓘ 146

Parameter overview with brief description

Parameter	Description	User interface	Factory setting
Device tag	Shows name of measuring point.	Max. 32 characters, such as letters, numbers or special characters (e.g. @, %, /).	Promag 400
Serial number	Shows the serial number of the measuring device.	A maximum of 11-digit character string comprising letters and numbers.	-
Firmware version	Shows the device firmware version installed.	Character string in the format xx.yy.zz	-
Device name	Shows the name of the transmitter.  The name can be found on the nameplate of the transmitter.	Max. 32 characters such as letters or numbers.	Promag 400
Order code	Shows the device order code.  The order code can be found on the nameplate of the sensor and transmitter in the "Order code" field.	Character string composed of letters, numbers and certain punctuation marks (e.g. /).	-
Extended order code 1	Shows the 1st part of the extended order code.  The extended order code can also be found on the nameplate of the sensor and transmitter in the "Ext. ord. cd." field.	Character string	-
Extended order code 2	Shows the 2nd part of the extended order code.  The extended order code can also be found on the nameplate of the sensor and transmitter in the "Ext. ord. cd." field.	Character string	-
Extended order code 3	Shows the 3rd part of the extended order code.  The extended order code can also be found on the nameplate of the sensor and transmitter in the "Ext. ord. cd." field.	Character string	-
ENP version	Shows the version of the electronic nameplate (ENP).	Character string	2.02.00
Device revision	Shows the device revision with which the device is registered with the HART Communication Foundation.	2-digit hexadecimal number	8
Device ID	Shows the device ID for identifying the device in a HART network.	6-digit hexadecimal number	-

Parameter	Description	User interface	Factory setting
Device type	Shows the device type with which the measuring device is registered with the HART Communication Foundation.	2-digit hexadecimal number	0x69 (for Promag 400)
Manufacturer ID	Shows the manufacturer ID device is registered with the HART Communication Foundation.	2-digit hexadecimal number	0x11 (for Endress+Hauser)

12.13 Firmware history

Release date	Firmware version	Order code for "Firmware version"	Firmware changes	Documentation type	Documentation
10.2013	01.04.00	Option 76	Original firmware	Operating Instructions	BA01063D/06/EN/02.13
05.2014	01.05.00	Option 73	<ul style="list-style-type: none"> ▪ In accordance with HART 7 Specification ▪ Integrated HART input ▪ SD03 keypad lock ▪ Modification of SIL functionality ▪ HistoROM data logging in FieldCare "HistoROM" module ▪ Simulation of diagnostic events ▪ Ability to access Heartbeat Technology application package 	Operating Instructions	BA01063D/06/EN/03.14
11.2016	02.00.00	Option 71	Device type ID: 0x69 <ul style="list-style-type: none"> ▪ Web server: current version ▪ Logbook: current concept, including parameter change ▪ Upload/download: current concept ▪ Heartbeat Technology: new hardware, diagnostics, events ▪ Security concept: encrypted password transmission ▪ WLAN ▪ Custody transfer mode 	Operating Instructions	BA01063D/06/EN/05.16

 It is possible to flash the firmware to the current version or the previous version using the service interface.

 For the compatibility of the firmware version with the previous version, the installed device description files and operating tools, observe the information about the device in the "Manufacturer's information" document.

 The manufacturer's information is available:

- In the Download Area of the Endress+Hauser web site: www.endress.com → Downloads
- Specify the following details:
 - Text search: Manufacturer's information
 - Media type: Documentation – Technical Documentation

13 Maintenance

13.1 Maintenance tasks

No special maintenance work is required.

13.1.1 Exterior cleaning

When cleaning the exterior of measuring devices, always use cleaning agents that do not attack the surface of the housing or the seals.

WARNING

Cleaning agents can damage the plastic transmitter housing!

- ▶ Do not use high-pressure steam.
- ▶ Only use the permitted cleaning agents specified.

Permitted cleaning agents for the plastic transmitter housing

- Commercially available household cleaners
- Methyl alcohol or isopropyl alcohol
- Mild soap solutions

13.1.2 Interior cleaning

No interior cleaning is planned for the device.

13.1.3 Replacing seals

The sensor's seals (particularly aseptic molded seals) must be replaced periodically.

The interval between changes depends on the frequency of the cleaning cycles, the cleaning temperature and the medium temperature.

Replacement seals (accessory part) →  196

13.2 Measuring and test equipment

Endress+Hauser offers a wide variety of measuring and test equipment, such as W@M or device tests.

 Your Endress+Hauser Sales Center can provide detailed information on the services.

List of some of the measuring and testing equipment: →  150

13.3 Endress+Hauser services

Endress+Hauser offers a wide variety of services for maintenance such as recalibration, maintenance service or device tests.

 Your Endress+Hauser Sales Center can provide detailed information on the services.

14 Repairs

14.1 General notes

14.1.1 Repair and conversion concept

The Endress+Hauser repair and conversion concept provides for the following:

- The measuring devices have a modular design.
- Spare parts are grouped into logical kits with the associated Installation Instructions.
- Repairs are carried out by Endress+Hauser Service or by appropriately trained customers.
- Certified devices can only be converted to other certified devices by Endress+Hauser Service or at the factory.

14.1.2 Notes for repair and conversion



For repair and modification of a measuring device, observe the following notes:

- ▶ Use only original Endress+Hauser spare parts.
- ▶ Carry out the repair according to the Installation Instructions.
- ▶ Observe the applicable standards, federal/national regulations, Ex documentation (XA) and certificates.
- ▶ Document every repair and each conversion and enter them into the *W@M* life cycle management database.

14.2 Spare parts

W@M Device Viewer (www.endress.com/deviceviewer):

All the spare parts for the measuring device, along with the order code, are listed here and can be ordered. If available, users can also download the associated Installation Instructions.

-  Measuring device serial number:
 - Is located on the nameplate of the device.
 - Can be read out via the **Serial number** parameter (→  145) in the **Device information** submenu.

14.3 Endress+Hauser services

Endress+Hauser offers a wide range of services.

-  Your Endress+Hauser Sales Center can provide detailed information on the services.

14.4 Return

The measuring device must be returned if it is need of repair or a factory calibration, or if the wrong measuring device has been delivered or ordered. Legal specifications require Endress+Hauser, as an ISO-certified company, to follow certain procedures when handling products that are in contact with the medium.

To ensure safe, swift and professional device returns, please refer to the procedure and conditions for returning devices provided on the Endress+Hauser website at <http://www.endress.com/support/return-material>

14.5 Disposal

14.5.1 Removing the measuring device

1. Switch off the device.

⚠ WARNING

Danger to persons from process conditions.

- ▶ Beware of hazardous process conditions such as pressure in the measuring device, high temperatures or aggressive fluids.

2. Carry out the mounting and connection steps from the "Mounting the measuring device" and "Connecting the measuring device" sections in reverse order. Observe the safety instructions.

14.5.2 Disposing of the measuring device

⚠ WARNING

Danger to personnel and environment from fluids that are hazardous to health.

- ▶ Ensure that the measuring device and all cavities are free of fluid residues that are hazardous to health or the environment, e.g. substances that have permeated into crevices or diffused through plastic.

Observe the following notes during disposal:

- ▶ Observe valid federal/national regulations.
- ▶ Ensure proper separation and reuse of the device components.

15 Accessories

Various accessories, which can be ordered with the device or subsequently from Endress+Hauser, are available for the device. Detailed information on the order code in question is available from your local Endress+Hauser sales center or on the product page of the Endress+Hauser website: www.endress.com.

15.1 Device-specific accessories





15.1.1 For the transmitter





Accessories	Description
Display protection	Is used to protect the display against impact or scoring from sand in desert areas.  For details, see Special Documentation SD00333F
Connecting cable for remote version	Coil current and electrode cables, various lengths, reinforced cables available on request.
Ground cable	Set, consisting of two ground cables for potential equalization.
Post mounting kit	Post mounting kit for transmitter.
Compact → Remote conversion kit	For converting a compact device version to a remote device version.
Conversion kit Promag 50/53 → Promag 400	For converting a Promag with transmitter 50/53 to a Promag 400.

15.1.2 For the sensor



Accessories	Description
Ground disks	Are used to ground the medium in lined measuring tubes to ensure proper measurement.  For details, see Installation Instructions EA00070D

15.2 Communication-specific accessories

Accessories	Description
Commubox FXA195 HART	For intrinsically safe HART communication with FieldCare via the USB interface.  For details, see "Technical Information" TI00404F
Commubox FXA291	Connects Endress+Hauser field devices with a CDI interface (= Endress+Hauser Common Data Interface) and the USB port of a computer or laptop.  For details, see the "Technical Information" document TI405C/07
HART Loop Converter HMX50	Is used to evaluate and convert dynamic HART process variables to analog current signals or limit values.  For details, see "Technical Information" TI00429F and Operating Instructions BA00371F
Wireless HART adapter SWA70	Is used for the wireless connection of field devices. The WirelessHART adapter can be easily integrated into field devices and existing infrastructures, offers data protection and transmission safety and can be operated in parallel with other wireless networks with minimum cabling complexity.  For details, see Operating Instructions BA00061S

Fieldgate FXA320	Gateway for the remote monitoring of connected 4 to 20 mA measuring devices via a Web browser.  For details, see "Technical Information" TI00025S and Operating Instructions BA00053S
Fieldgate FXA520	Gateway for the remote diagnostics and remote configuration of connected HART measuring devices via a Web browser.  For details, see "Technical Information" TI00025S and Operating Instructions BA00051S
Field Xpert SFX350	Field Xpert SFX350 is a mobile computer for commissioning and maintenance. It enables efficient device configuration and diagnostics for HART devices and can be used in non-hazardous areas.  For details, see Operating Instructions BA01202S
Field Xpert SFX370	Field Xpert SFX370 is a mobile computer for commissioning and maintenance. It enables efficient device configuration and diagnostics for HART devices and can be used in the non-hazardous area and in the hazardous area.  For details, see Operating Instructions BA01202S

15.3 Service-specific accessories

Accessories	Description
Applicator	Software for selecting and sizing Endress+Hauser measuring devices: <ul style="list-style-type: none"> Choice of measuring devices for industrial requirements Calculation of all the necessary data for identifying the optimum flowmeter: e.g. nominal diameter, pressure loss, flow velocity and accuracy. Graphic illustration of the calculation results Determination of the partial order code, administration, documentation and access to all project-related data and parameters over the entire life cycle of a project. Applicator is available: <ul style="list-style-type: none"> Via the Internet: https://wapps.endress.com/applicator As a downloadable DVD for local PC installation.
W@M	W@M Life Cycle Management Improved productivity with information at your fingertips. Data relevant to a plant and its components is generated from the first stages of planning and during the asset's complete life cycle. W@M Life Cycle Management is an open and flexible information platform with online and on-site tools. Instant access for your staff to current, in-depth data shortens your plant's engineering time, speeds up procurement processes and increases plant uptime. Combined with the right services, W@M Life Cycle Management boosts productivity in every phase. For more information, visit www.endress.com/lifecyclemanagement
FieldCare	FDT-based plant asset management tool from Endress+Hauser. It can configure all smart field units in your system and helps you manage them. By using the status information, it is also a simple but effective way of checking their status and condition.  For details, see Operating Instructions BA00027S and BA00059S
DeviceCare	Tool for connecting and configuring Endress+Hauser field devices.  For details, see Innovation brochure IN01047S

15.4 System components

Accessories	Description
Memograph M graphic data manager	<p>The Memograph M graphic data manager provides information on all the relevant measured variables. Measured values are recorded correctly, limit values are monitored and measuring points analyzed. The data are stored in the 256 MB internal memory and also on a SD card or USB stick.</p> <p> For details, see "Technical Information" TI00133R and Operating Instructions BA00247R</p>

16 Technical data

16.1 Application

The measuring device is only suitable for flow measurement of liquids with a minimum conductivity of 5 $\mu\text{S}/\text{cm}$.

Depending on the version ordered, the measuring device can also measure potentially explosive, flammable, poisonous and oxidizing media.

To ensure that the device remains in proper operating condition for its service life, use the measuring device only for media against which the process-wetted materials are sufficiently resistant.

16.2 Function and system design

Measuring principle Electromagnetic flow measurement on the basis of *Faraday's law of magnetic induction*.

Measuring system The device consists of a transmitter and a sensor.
Two device versions are available:

- Compact version – transmitter and sensor form a mechanical unit.
- Remote version - transmitter and sensor are mounted in separate locations.

For information on the structure of the device

16.3 Input

Measured variable **Direct measured variables**

- Volume flow (proportional to induced voltage)
- Electrical conductivity

 In custody transfer: only volume flow

Calculated measured variables

Mass flow

Measuring range Typically $v = 0.01$ to 10 m/s (0.03 to 33 ft/s) with the specified accuracy
Electrical conductivity: ≥ 5 $\mu\text{S}/\text{cm}$ for liquids in general

Flow characteristic values in SI units ¹⁾

Nominal diameter		Recommended flow min./max. full scale value ($v \sim 0.3/10$ m/s) [m ³ /h]	Factory settings		
[mm]	[in]		Full scale value current output ($v \sim 2.5$ m/s) [m ³ /h]	Pulse value (~ 2 pulse/s) [m ³]	Low flow cut off ($v \sim 0.04$ m/s) [m ³ /h]
25	1	9 to 300 dm ³ /min	75 dm ³ /min	0.5 dm ³	1 dm ³ /min
32	–	15 to 500 dm ³ /min	125 dm ³ /min	1 dm ³	2 dm ³ /min
40	1 ½	25 to 700 dm ³ /min	200 dm ³ /min	1.5 dm ³	3 dm ³ /min

Nominal diameter		Recommended flow min./max. full scale value (v ~ 0.3/10 m/s) [m ³ /h]	Factory settings		
[mm]	[in]		Full scale value current output (v ~ 2.5 m/s) [m ³ /h]	Pulse value (~ 2 pulse/s) [m ³]	Low flow cut off (v ~ 0.04 m/s) [m ³ /h]
50	2	35 to 1 100 dm ³ /min	300 dm ³ /min	2.5 dm ³	5 dm ³ /min
65	-	60 to 2 000 dm ³ /min	500 dm ³ /min	5 dm ³	8 dm ³ /min
80	3	90 to 3 000 dm ³ /min	750 dm ³ /min	5 dm ³	12 dm ³ /min
100	4	145 to 4 700 dm ³ /min	1 200 dm ³ /min	10 dm ³	20 dm ³ /min
125	-	220 to 7 500 dm ³ /min	1 850 dm ³ /min	15 dm ³	30 dm ³ /min
150	6	20 to 600	150	0.025	2.5
200	8	35 to 1 100	300	0.05	5
250	10	55 to 1 700	500	0.05	7.5
300	12	80 to 2 400	750	0.1	10
350	14	110 to 3 300	1 000	0.1	15
375	15	140 to 4 200	1 200	0.15	20
400	16	140 to 4 200	1 200	0.15	20
450	18	180 to 5 400	1 500	0.25	25
500	20	220 to 6 600	2 000	0.25	30
600	24	310 to 9 600	2 500	0.3	40
700	28	420 to 13 500	3 500	0.5	50
750	30	480 to 15 000	4 000	0.5	60
800	32	550 to 18 000	4 500	0.75	75
900	36	690 to 22 500	6 000	0.75	100
1 000	40	850 to 28 000	7 000	1	125
-	42	950 to 30 000	8 000	1	125
1 200	48	1 250 to 40 000	10 000	1.5	150
-	54	1 550 to 50 000	13 000	1.5	200
1 400	-	1 700 to 55 000	14 000	2	225
-	60	1 950 to 60 000	16 000	2	250
1 600	-	2 200 to 70 000	18 000	2.5	300
-	66	2 500 to 80 000	20 500	2.5	325
1 800	72	2 800 to 90 000	23 000	3	350
-	78	3 300 to 100 000	28 500	3.5	450
2 000	-	3 400 to 110 000	28 500	3.5	450

1) Order code for "Design", option A "Insertion length short ISO/DVGW until DN400, DN450-2000 1:1" and order code for "Design", option B "Insertion length long ISO/DVGW until DN400, DN450-2000 1:1.3"

Flow characteristic values in SI units¹⁾

Nominal diameter		Recommended flow min./max. full scale value (v ~ 0.12/5 m/s)	Factory settings		
[mm]	[in]		Full scale value current output (v ~ 2.5 m/s)	Pulse value (~ 4 pulse/s)	Low flow cut off (v ~ 0.01 m/s)
		[m ³ /h]	[m ³ /h]	[m ³]	[m ³ /h]
50	2	15 to 600 dm ³ /min	300 dm ³ /min	1.25 dm ³	1.25 dm ³ /min
65	–	25 to 1000 dm ³ /min	500 dm ³ /min	2 dm ³	2 dm ³ /min
80	3	35 to 1500 dm ³ /min	750 dm ³ /min	3 dm ³	3.25 dm ³ /min
100	4	60 to 2400 dm ³ /min	1200 dm ³ /min	5 dm ³	4.75 dm ³ /min
125	–	90 to 3700 dm ³ /min	1850 dm ³ /min	8 dm ³	7.5 dm ³ /min
150	6	145 to 5400 dm ³ /min	2500 dm ³ /min	10 dm ³	11 dm ³ /min
200	8	220 to 9400 dm ³ /min	5000 dm ³ /min	20 dm ³	19 dm ³ /min
250	10	20 to 850	500	0.03	1.75
300	12	35 to 1300	750	0.05	2.75

- 1) Order code for "Design", option C "Insertion length short ISO/DVGW until DN300, w/o inlet and outlet runs, constricted meas.tube"

Flow characteristic values in US units¹⁾

Nominal diameter		Recommended flow min./max. full scale value (v ~ 0.3/10 m/s)	Factory settings		
[in]	[mm]		Full scale value current output (v ~ 2.5 m/s)	Pulse value (~ 2 pulse/s)	Low flow cut off (v ~ 0.04 m/s)
		[gal/min]	[gal/min]	[gal]	[gal/min]
1	25	2.5 to 80	18	0.2	0.25
–	32	4 to 130	30	0.2	0.5
1 ½	40	7 to 190	50	0.5	0.75
2	50	10 to 300	75	0.5	1.25
–	65	16 to 500	130	1	2
3	80	24 to 800	200	2	2.5
4	100	40 to 1250	300	2	4
–	125	60 to 1950	450	5	7
6	150	90 to 2650	600	5	12
8	200	155 to 4850	1200	10	15
10	250	250 to 7500	1500	15	30
12	300	350 to 10600	2400	25	45
14	350	500 to 15000	3600	30	60
15	375	600 to 19000	4800	50	60
16	400	600 to 19000	4800	50	60
18	450	800 to 24000	6000	50	90
20	500	1000 to 30000	7500	75	120
24	600	1400 to 44000	10500	100	180
28	700	1900 to 60000	13500	125	210
30	750	2150 to 67000	16500	150	270

Nominal diameter		Recommended flow min./max. full scale value (v ~ 0.3/10 m/s)	Factory settings		
			Full scale value current output (v ~ 2.5 m/s)	Pulse value (~ 2 pulse/s)	Low flow cut off (v ~ 0.04 m/s)
[in]	[mm]	[gal/min]	[gal/min]	[gal]	[gal/min]
32	800	2 450 to 80 000	19 500	200	300
36	900	3 100 to 100 000	24 000	225	360
40	1 000	3 800 to 125 000	30 000	250	480
42	-	4 200 to 135 000	33 000	250	600
48	1 200	5 500 to 175 000	42 000	400	600
54	-	9 to 300 Mgal/d	75 Mgal/d	0.0005 Mgal/d	1.3 Mgal/d
-	1 400	10 to 340 Mgal/d	85 Mgal/d	0.0005 Mgal/d	1.3 Mgal/d
60	-	12 to 380 Mgal/d	95 Mgal/d	0.0005 Mgal/d	1.3 Mgal/d
-	1 600	13 to 450 Mgal/d	110 Mgal/d	0.0008 Mgal/d	1.7 Mgal/d
66	-	14 to 500 Mgal/d	120 Mgal/d	0.0008 Mgal/d	2.2 Mgal/d
72	1 800	16 to 570 Mgal/d	140 Mgal/d	0.0008 Mgal/d	2.6 Mgal/d
78	-	18 to 650 Mgal/d	175 Mgal/d	0.0010 Mgal/d	3.0 Mgal/d
-	2 000	20 to 700 Mgal/d	175 Mgal/d	0.0010 Mgal/d	2.9 Mgal/d

- 1) Order code for "Design", option A "Insertion length short ISO/DVGW until DN400, DN450-2000 1:1" and order code for "Design", option B "Insertion length long ISO/DVGW until DN400, DN450-2000 1:1.3"

Flow characteristic values in US units ¹⁾

Nominal diameter		Recommended flow min./max. full scale value (v ~ 0.12/5 m/s)	Factory settings		
			Full scale value current output (v ~ 2.5 m/s)	Pulse value (~ 4 pulse/s)	Low flow cut off (v ~ 0.01 m/s)
[in]	[mm]	[gal/min]	[gal/min]	[gal]	[gal/min]
2	50	4 to 160	75	0.3	0.35
-	65	7 to 260	130	0.5	0.6
3	80	10 to 400	200	0.8	0.8
4	100	16 to 650	300	1.2	1.25
-	125	24 to 1 000	450	1.8	2
6	150	40 to 1 400	600	2.5	3
8	200	60 to 2 500	1 200	5	5
10	250	90 to 3 700	1 500	6	8
12	300	155 to 5 700	2 400	9	12

- 1) Order code for "Design", option C "Insertion length short ISO/DVGW until DN300, w/o inlet and outlet runs, constricted meas.tube"

Recommended measuring range



"Flow limit" section →  166

 For custody transfer, the applicable approval determines the permitted measuring range, the pulse value and the low flow cut off.

Operable flow range Over 1000 : 1

 For custody transfer, the operable flow range is 100 : 1 to 250 : 1, depending on the nominal diameter. Further details are specified by the applicable approval.

Input signal **External measured values**

 Various pressure transmitters and temperature measuring devices can be ordered from Endress+Hauser: see "Accessories" section →  152

It is recommended to read in external measured values to calculate the following measured variables:

Corrected volume flow

HART protocol

The measured values are written from the automation system to the measuring device via the HART protocol. The pressure transmitter must support the following protocol-specific functions:

- HART protocol
- Burst mode

Status input

Maximum input values	<ul style="list-style-type: none"> ▪ DC 30 V ▪ 6 mA
Response time	Adjustable: 5 to 200 ms
Input signal level	<ul style="list-style-type: none"> ▪ Low signal: DC -3 to +5 V ▪ High signal: DC 12 to 30 V
Assignable functions	<ul style="list-style-type: none"> ▪ Off ▪ Reset totalizers 1-3 separately ▪ Reset all totalizers ▪ Flow override

16.4 Output

Output signal **Current output**

Current output	Can be set as: <ul style="list-style-type: none"> ▪ 4-20 mA NAMUR ▪ 4-20 mA US ▪ 4-20 mA HART ▪ 0-20 mA
Maximum output values	<ul style="list-style-type: none"> ▪ DC 24 V (no flow) ▪ 22.5 mA
Load	0 to 700 Ω
Resolution	0.5 μA
Damping	Adjustable: 0.07 to 999 s
Assignable measured variables	<ul style="list-style-type: none"> ▪ Volume flow ▪ Mass flow ▪ Flow velocity ▪ Conductivity ▪ Electronic temperature

Pulse/frequency/switch output

Function	<ul style="list-style-type: none"> ▪ With the order code for "Output; Input", option H: output 2 can be set as a pulse or frequency output ▪ With the order code for "Output; Input", option I: output 2 and 3 can be set as a pulse, frequency or switch output ▪ With the order code for "Output; Input", option J: output 2 firmly assigned as certified pulse output
Version	Passive, open collector
Maximum input values	<ul style="list-style-type: none"> ▪ DC 30 V ▪ 250 mA
Voltage drop	For 25 mA: ≤ DC 2 V
Pulse output	
Pulse width	Adjustable: 0.05 to 2 000 ms
Maximum pulse rate	10 000 Impulse/s
Pulse value	Adjustable
Assignable measured variables	<ul style="list-style-type: none"> ▪ Volume flow ▪ Mass flow
Frequency output	
Output frequency	Adjustable: 0 to 12 500 Hz
Damping	Adjustable: 0 to 999 s
Pulse/pause ratio	1:1
Assignable measured variables	<ul style="list-style-type: none"> ▪ Volume flow ▪ Mass flow ▪ Conductivity ▪ Flow velocity ▪ Electronic temperature
Switch output	
Switching behavior	Binary, conductive or non-conductive
Switching delay	Adjustable: 0 to 100 s
Number of switching cycles	Unlimited
Assignable functions	<ul style="list-style-type: none"> ▪ Off ▪ On ▪ Diagnostic behavior ▪ Limit value: <ul style="list-style-type: none"> - Off - Volume flow - Mass flow - Conductivity - Flow velocity - Totalizer 1-3 - Electronic temperature ▪ Flow direction monitoring ▪ Status <ul style="list-style-type: none"> - Empty pipe detection - Low flow cut off

Signal on alarm

Depending on the interface, failure information is displayed as follows:

Current output 4 to 20 mA

4 to 20 mA

Failure mode	Choose from: <ul style="list-style-type: none"> ▪ 4 to 20 mA in accordance with NAMUR recommendation NE 43 ▪ 4 to 20 mA in accordance with US ▪ Min. value: 3.59 mA ▪ Max. value: 22.5 mA ▪ Freely definable value between: 3.59 to 22.5 mA ▪ Actual value ▪ Last valid value
---------------------	--

0 to 20 mA

Failure mode	Choose from: <ul style="list-style-type: none"> ▪ Maximum alarm: 22 mA ▪ Freely definable value between: 0 to 22.5 mA
---------------------	---

HART current output

Device diagnostics	Device condition can be read out via HART Command 48
---------------------------	--

Pulse/frequency/switch output

Pulse output	
Failure mode	Choose from: <ul style="list-style-type: none"> ▪ Actual value ▪ No pulses
Frequency output	
Failure mode	Choose from: <ul style="list-style-type: none"> ▪ Actual value ▪ 0 Hz ▪ Defined value: 0 to 12 500 Hz
Switch output	
Failure mode	Choose from: <ul style="list-style-type: none"> ▪ Current status ▪ Open ▪ Closed

Local display

Plain text display	With information on cause and remedial measures
Backlight	Red backlighting indicates a device error.

 Status signal as per NAMUR recommendation NE 107

Interface/protocol

- Via digital communication:
 - HART protocol
- Via service interface
 - CDI-RJ45 service interface
 - WLAN interface

Plain text display	With information on cause and remedial measures
--------------------	---

Web server

Plain text display	With information on cause and remedial measures
--------------------	---

Light emitting diodes (LED)

Status information	<p>Status indicated by various light emitting diodes</p> <p>The following information is displayed depending on the device version:</p> <ul style="list-style-type: none"> ▪ Supply voltage active ▪ Data transmission active ▪ Device alarm/error has occurred <p> Diagnostic information via light emitting diodes</p>
---------------------------	--

Low flow cut off The switch points for low flow cut off are user-selectable.

Galvanic isolation The following connections are galvanically isolated from each other:

- Inputs
- Outputs
- Power supply

Protocol-specific data **HART**

- For information on the device description files
- For information on the dynamic variables and measured variables (HART device variables) →  83

16.5 Power supply

Terminal assignment →  43

Supply voltage **Transmitter**

Order code for "Power supply"	terminal voltage		Frequency range
Option L	DC 24 V	±25%	–
	AC 24 V	±25%	50/60 Hz, ±4 Hz
	AC 100 to 240 V	–15 to +10%	50/60 Hz, ±4 Hz

Power consumption

Order code for "Output"	Maximum power consumption
Option H: 4-20mA HART, pulse/frequency/switch output, switch output	30 VA/8 W
Option I: 4-20mA HART, 2 x pulse/frequency/switch output, status input	30 VA/8 W
Option J: 4-20mA HART, certified pulse output, pulse/frequency/switch output, status input	30 VA/8 W

Current consumption

Transmitter

Order code for "Power supply"	Maximum Current consumption	Maximum switch-on current
Option L: AC 100 to 240 V	145 mA	25 A (< 5 ms)
Option L: AC/DC 24 V	350 mA	27 A (< 5 ms)

Power supply failure

- Totalizers stop at the last value measured.
- Configuration is retained in the plug-in memory (HistoROM DAT).
- Error messages (incl. total operated hours) are stored.

Electrical connection

→  46

Potential equalization

→  49

terminals

Transmitter

- Supply voltage cable: plug-in spring terminals for wire cross-sections 0.5 to 2.5 mm² (20 to 14 AWG)
- Signal cable: plug-in spring terminals for wire cross-sections 0.5 to 2.5 mm² (20 to 14 AWG)
- Electrode cable: spring terminals for wire cross-sections 0.5 to 2.5 mm² (20 to 14 AWG)
- Coil current cable: spring terminals for wire cross-sections 0.5 to 2.5 mm² (20 to 14 AWG)

Sensor connection housingSpring terminals for wire cross-sections 0.5 to 2.5 mm² (20 to 14 AWG)

Cable entries

Cable entry thread

- M20 x 1.5
- Via adapter:
 - NPT ½"
 - G ½"

Cable gland

- For standard cable: M20 × 1.5 with cable ϕ 6 to 12 mm (0.24 to 0.47 in)
- For reinforced cable: M20 × 1.5 with cable ϕ 9.5 to 16 mm (0.37 to 0.63 in)

 If metal cable entries are used, use a grounding plate.

Cable specification

→  41

16.6 Performance characteristics

Reference operating conditions

- Error limits following DIN EN 29104, in future ISO 20456
- Water, typically +15 to +45 °C (+59 to +113 °F); 0.5 to 7 bar (73 to 101 psi)
- Data as indicated in the calibration protocol
- Accuracy based on accredited calibration rigs according to ISO 17025

Maximum measured error

Error limits under reference operating conditions

o.r. = of reading

Volume flow

- $\pm 0.5\%$ o.r. ± 1 mm/s (0.04 in/s)
- Optional: $\pm 0.2\%$ o.r. ± 2 mm/s (0.08 in/s)

i Fluctuations in the supply voltage do not have any effect within the specified range.

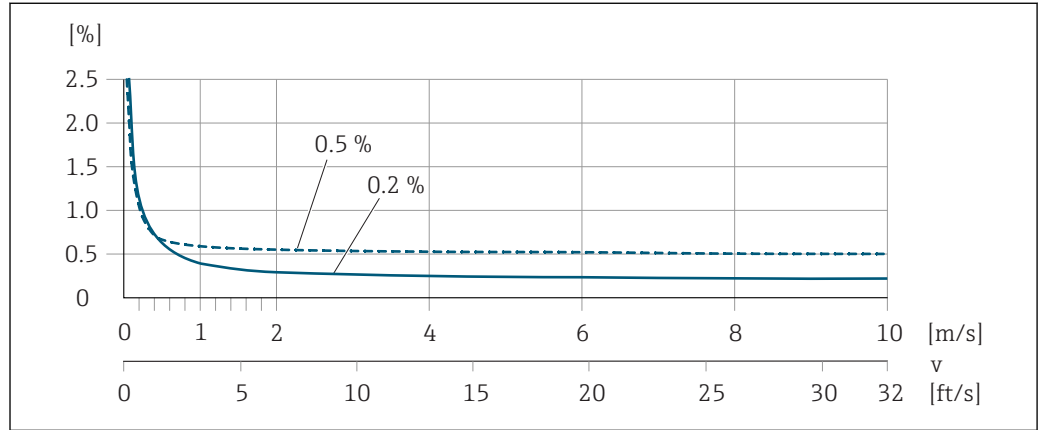

38 Maximum measured error in % o.r.

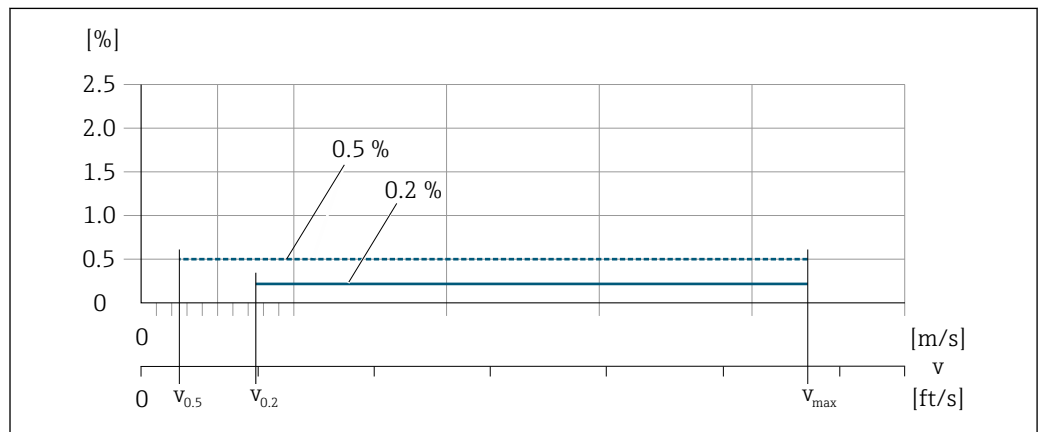

39 Flat Spec in % o.r.

Flat Spec flow values 0.5 %

Nominal diameter		$v_{0.5}$		v_{max}	
[mm]	[in]	[m/s]	[ft/s]	[m/s]	[ft/s]
25 to 600 ¹⁾	1 to 24	0.5	1.64	10	32
50 to 300 ²⁾	2 to 12	0.25	0.82	5	16

- 1) Order code for "Design", option A "Insertion length short, ISO/DVGW to DN400, DN450-2000 1:1" and order code for "Design", option B "Insertion length long, ISO/DVGW to DN400, DN450-2000 1:1.3"
- 2) Order code for "Design", option C "Insertion length short ISO/DVGW to DN300, without inlet/outlet runs, constricted meas.tube"

Flat Spec flow values 0.2 %

Nominal diameter		v _{0.2}		v _{max}	
[mm]	[in]	[m/s]	[ft/s]	[m/s]	[ft/s]
25 to 600 ¹⁾	1 to 24	1.5	4.92	10	32
50 to 300 ²⁾	2 to 12	0.6	1.97	4	13

- 1) Order code for "Design", option A "Insertion length short, ISO/DVGW to DN400, DN450-2000 1:1" and order code for "Design", option B "Insertion length long, ISO/DVGW to DN400, DN450-2000 1:1.3"
- 2) Order code for "Design", option C "Insertion length short ISO/DVGW to DN300, without inlet/outlet runs, constricted meas.tube"

Electrical conductivity

Max. measured error not specified.

Accuracy of outputs

The outputs have the following base accuracy specifications.

Current output

Accuracy	Max. $\pm 5 \mu\text{A}$
----------	--------------------------

Pulse/frequency output

o.r. = of reading

Accuracy	Max. $\pm 50 \text{ ppm o.r.}$ (over the entire ambient temperature range)
----------	--

Repeatability

o.r. = of reading

Volume flow

max. $\pm 0.1 \%$ o.r. $\pm 0.5 \text{ mm/s}$ (0.02 in/s)

Electrical conductivity

Max. $\pm 5 \%$ o.r.

Influence of ambient temperature

Current output

o.r. = of reading

Temperature coefficient	Max. $\pm 0.005 \%$ o.r./°C
-------------------------	-----------------------------



Pulse/frequency output

Temperature coefficient	No additional effect. Included in accuracy.
-------------------------	---

16.7 Installation





"Mounting requirements"

16.8 Environment

Ambient temperature range	→  24
Storage temperature	<p>The storage temperature corresponds to the operating temperature range of the measuring transmitter and the appropriate measuring sensors. →  24</p> <ul style="list-style-type: none"> ■ Protect the measuring device against direct sunlight during storage in order to avoid unacceptably high surface temperatures. ■ Select a storage location where moisture cannot collect in the measuring device as fungus or bacteria infestation can damage the liner. ■ If protection caps or protective covers are mounted these should never be removed before installing the measuring device.
Atmosphere	<p>If a plastic transmitter housing is permanently exposed to certain steam and air mixtures, this can damage the housing.</p> <p> If you are unsure, please contact your Endress+Hauser Sales Center for clarification.</p>
Degree of protection	<p>Transmitter</p> <ul style="list-style-type: none"> ■ As standard: IP66/67, type 4X enclosure ■ When housing is open: IP20, type 1 enclosure <p>Sensor</p> <ul style="list-style-type: none"> ■ As standard: IP66/67, type 4X enclosure ■ Optionally available for remote version: <ul style="list-style-type: none"> – IP66/67, type 4X enclosure; fully welded, with protective varnish EN ISO 12944 C5-M. Suitable for use in corrosive atmospheres. – IP68, type 6P enclosure; fully welded, with protective varnish as per EN ISO 12944 C5-M. Suitable for permanent immersion in water ≤ 3 m (10 ft) or up to 48 hours at depths ≤ 10 m (30 ft). – IP68, type 6P enclosure; fully welded, with protective varnish as per EN ISO 12944 Im1/Im2/Im3. Suitable for permanent immersion in saline water ≤ 3 m (10 ft) or up to 48 hours at depths ≤ 10 m (30 ft) or in buried applications.
Vibration resistance	<p>Compact version</p> <ul style="list-style-type: none"> ■ Vibration, sinusoidal according to IEC 60068-2-6 <ul style="list-style-type: none"> – 2 to 8.4 Hz, 3.5 mm peak – 8.4 to 2 000 Hz, 1 g peak ■ Vibration broad-band random, according to IEC 60068-2-64 <ul style="list-style-type: none"> – 10 to 200 Hz, 0.003 g²/Hz – 200 to 2 000 Hz, 0.001 g²/Hz – Total: 1.54 g rms <p>Remote version</p> <ul style="list-style-type: none"> ■ Vibration, sinusoidal according to IEC 60068-2-6 <ul style="list-style-type: none"> – 2 to 8.4 Hz, 7.5 mm peak – 8.4 to 2 000 Hz, 2 g peak ■ Vibration broad-band random, according to IEC 60068-2-64 <ul style="list-style-type: none"> – 10 to 200 Hz, 0.01 g²/Hz – 200 to 2 000 Hz, 0.003 g²/Hz – Total: 2.70 g rms
Shock resistance	Shock, half-sine according to IEC 60068-2-27 6 ms 50 g

Impact resistance	Rough handling shocks according to IEC 60068-2-31
Mechanical load	<ul style="list-style-type: none"> Protect the transmitter housing against mechanical effects, such as shock or impact; the use of the remote version is sometimes preferable. Never use the transmitter housing as a ladder or climbing aid.
Electromagnetic compatibility (EMC)	<ul style="list-style-type: none"> As per IEC/EN 61326 and NAMUR Recommendation 21 (NE 21) Complies with emission limits for industry as per EN 55011 (Class A) <p> Details are provided in the Declaration of Conformity.</p>

16.9 Process

Medium temperature range	<ul style="list-style-type: none"> 0 to +80 °C (+32 to +176 °F) for hard rubber, DN 50 to 2000 (2 to 78") -20 to +50 °C (-4 to +122 °F) for polyurethane, DN 25 to 1200 (1 to 48") <p> In custody transfer mode, the permitted fluid temperature is 0 to +50 °C (+32 to +122 °F).</p>
Conductivity	<p>≥ 5 µS/cm for liquids in general. Stronger filter damping is required for very low conductivity values.</p> <p> Note that in the case of the remote version, the requisite minimum conductivity also depends on the cable length →  26.</p>
Pressure-temperature ratings	<p> An overview of the pressure-temperature ratings for the process connections is provided in the "Technical Information" document</p>

Pressure tightness

Liner: hard rubber

Nominal diameter		Limit values for absolute pressure in [mbar] ([psi]) for fluid temperatures:		
[mm]	[in]	+25 °C (+77 °F)	+50 °C (+122 °F)	+80 °C (+176 °F)
50...2000	2...78	0 (0)	0 (0)	0 (0)

Liner: polyurethane

Nominal diameter		Limit values for absolute pressure in [mbar] ([psi]) for fluid temperatures:	
[mm]	[in]	+25 °C (+77 °F)	+50 °C (+122 °F)
25...1200	1...48	0 (0)	0 (0)

Flow limit

The diameter of the pipe and the flow rate determine the nominal diameter of the sensor. The optimum flow velocity is between 2 to 3 m/s (6.56 to 9.84 ft/s). Also match the velocity of flow (v) to the physical properties of the fluid:

- $v < 2 \text{ m/s}$ (6.56 ft/s): for abrasive fluids (e.g. potter's clay, lime milk, ore slurry)
- $v > 2 \text{ m/s}$ (6.56 ft/s): for fluids producing buildup (e.g. wastewater sludge)

i A necessary increase in the flow velocity can be achieved by reducing the sensor nominal diameter.

i For an overview of the full scale values for the measuring range, see the "Measuring range" section →  153

i For custody transfer, the applicable approval determines the permitted measuring range.

Pressure loss

- No pressure loss occurs if the sensor is installed in a pipe with the same nominal diameter.
- Pressure losses for configurations incorporating adapters according to DIN EN 545 →  25

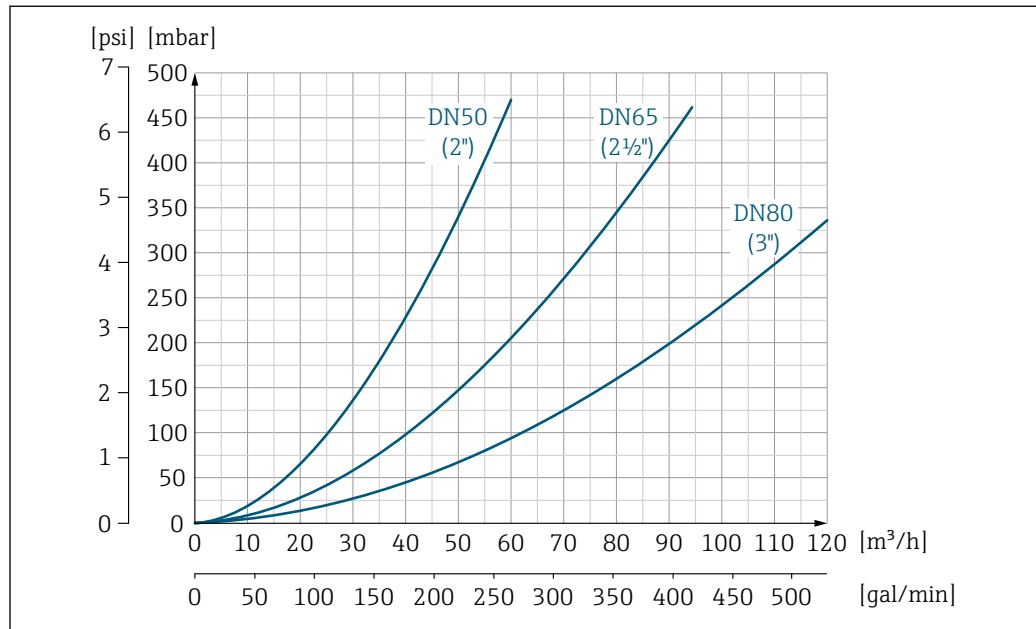

A0032667-EN

 40 Pressure loss DN 50 to 80 (2 to 3") in the case of order code for "Design", option C "Insertion length short ISO/DVGW to DN300, without inlet/outlet runs, constricted meas.tube"

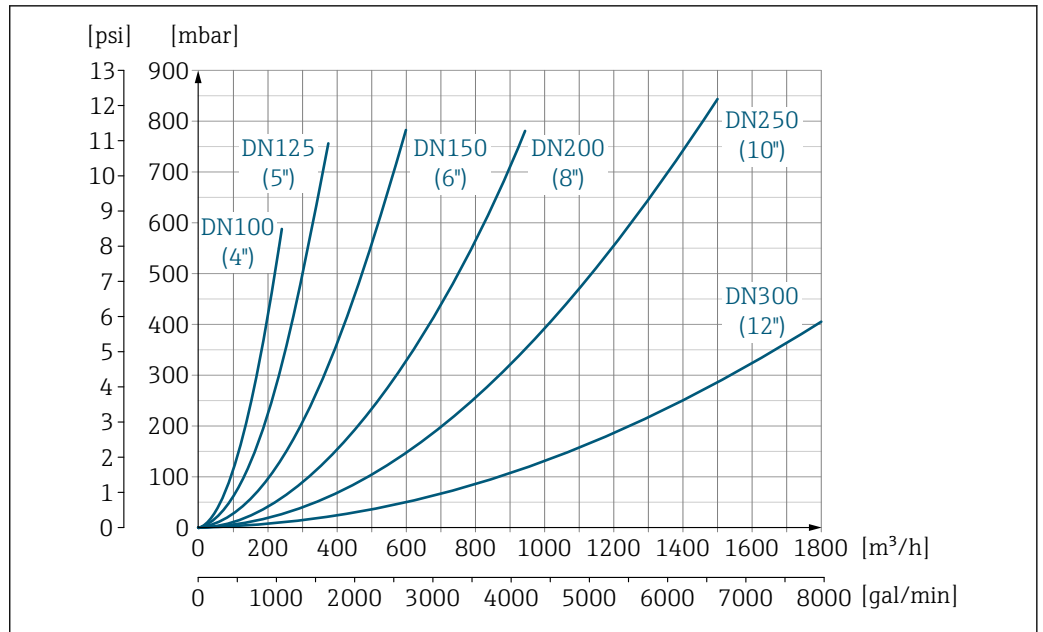

41 Pressure loss DN 100 to 300 (4 to 12") in the case of order code for "Design", option C "Insertion length short ISO/DVGW to DN300, without inlet/outlet runs, constricted meas.tube"

System pressure → 24

Vibrations → 25

16.10 Mechanical construction

Design, dimensions  For the dimensions and installation lengths of the device, see the "Technical Information" document, "Mechanical construction" section.

Weight All values (weight exclusive of packaging material) refer to devices for standard pressure ratings.

Different values due to different transmitter versions:

Compact version

Weight data:

- Including the transmitter
 - Order code for "Housing", option **M, Q**: 1.3 kg (2.9 lb)
 - Order code for "Housing", option **A, R**: 2.0 kg (4.4 lb)
- Excluding packaging material

Weight in SI units

Standard version

Order code for "Design", option A "Insertion length short, ISO/DVGW to DN400, DN450-2000 1:1" and order code for "Design", option B "Insertion length long, ISO/DVGW to DN400, DN450-2000 1:1.3"

EN 1092-1		
DN [mm]	Pressure rating	Weight [kg] Order code for "Housing", option M, Q Polycarbonate plastic ¹⁾
25	PN 40	5
32	PN 40	6
40	PN 40	8
50	PN 40	9
65	PN 16	10
80	PN 16	12
100	PN 16	14
125	PN 16	20
150	PN 16	24
200	PN 10	43
250	PN 10	63
300	PN 10	68
350	PN 6	105
375	PN 6	120
400	PN 6	120
450	PN 6	161
500	PN 6	156
600	PN 6	208
700	PN 6	304
800	PN 6	357
900	PN 6	485
1000	PN 6	589
1200	PN 6	850
1400	PN 6	1300
1600	PN 6	1700
1800	PN 6	2200
2000	PN 6	2800

1) Values for aluminum transmitter, AlSi10Mg, coated: + 0.7 kg

Order code for "Design", option C "Insertion length short ISO/DVGW to DN300, without inlet/outlet runs, constricted meas.tube"

EN 1092-1 (DIN 2501)		
DN [mm]	Pressure rating	Weight [kg] Order code for "Housing", option M, Q Polycarbonate plastic ¹⁾
50	PN 40	9.6
65	PN 16	11.0
80	PN 16	13.4
100	PN 16	15.0
125	PN 16	24.0
150	PN 16	29.3
200	PN 16	51.3
250	PN 16	80.1
300	PN 16	93.7

1) Values for aluminum transmitter, AlSi10Mg, coated: + 0.7 kg

Order code for "Design", option A "Insertion length short, ISO/DVGW to DN400, DN450-2000 1:1" and order code for "Design", option B "Insertion length long, ISO/DVGW to DN400, DN450-2000 1:1.3"

AS 4087, PN 16	
DN [mm]	Weight [kg] Order code for "Housing", option M, Q Polycarbonate plastic ¹⁾
80	12
100	14
150	24

1) Values for aluminum transmitter, AlSi10Mg, coated: + 0.7 kg

Order code for "Design", option C "Insertion length short ISO/DVGW to DN300, without inlet/outlet runs, constricted meas.tube"

AS 4087, PN 16	
DN [mm]	Weight [kg] Order code for "Housing", option M, Q Polycarbonate plastic ¹⁾
80	13.4
100	15.0
150	29.3

1) Values for aluminum transmitter, AlSi10Mg, coated: + 0.7 kg

Order code for "Design", option A "Insertion length short, ISO/DVGW to DN400, DN450-2000 1:1" and order code for "Design", option B "Insertion length long, ISO/DVGW to DN400, DN450-2000 1:1.3"

JIS B2220, 10K	
DN [mm]	Weight [kg] Order code for "Housing", option M, Q Polycarbonate plastic ¹⁾
25	5
32	5
40	6
50	7
65	9
80	11
100	13
125	19
150	23
200	40
250	68
300	70
350	79
400	100
450	128
500	142
600	188
700	280
750	331

1) Values for aluminum transmitter, AlSi10Mg, coated: + 0.7 kg

Order code for "Design", option C "Insertion length short ISO/DVGW to DN300, without inlet/outlet runs, constricted meas.tube"

JIS B2220, 10K	
DN [mm]	Weight [kg] Order code for "Housing", option M, Q Polycarbonate plastic ¹⁾
50	7.6
65	10.0
80	12.4
100	14.8
125	23.4
150	30.0
200	49.2
250	82.9
300	88.2

1) Values for aluminum transmitter, AlSi10Mg, coated: + 0.7 kg

Order code for "Design", option A

Option A "Insertion length short; ISO/DVGW to DN400, DN450-2000 1:1"

EN 1092-1			
DN [mm]	Order code for "Housing", option M, Q Polycarbonate plastic ¹⁾		
	Weight [kg]		
	PN 6	PN 10	PN 16
450	100	115	145
500	115	133	185
600	156	166	274
700	198	253	307
800	262	343	416
900	345	431	525
1000	446	560	725
1200	639	837	1192
1400	1036	1348	1713
1600	1384	1985	2448
1800	1829	2570	3300
2000	2506	3178	4168

1) Values for aluminum transmitter, AlSi10Mg, coated: + 0.7 kg

AS 2129, Table E	
DN [mm]	Weight [kg]
	Order code for "Housing", option M, Q Polycarbonate plastic ¹⁾
450	147
500	183
600	267
700	347
750	434
800	494
900	691
1000	786
1200	1246

1) Values for aluminum transmitter, AlSi10Mg, coated: + 0.7 kg

AS 4087, PN 16	
DN [mm]	Weight [kg]
	Order code for "Housing", option M, Q Polycarbonate plastic ¹⁾
450	137
500	185
600	265

AS 4087, PN 16	
DN [mm]	Weight [kg] Order code for "Housing", option M, Q Polycarbonate plastic ¹⁾
700	368
750	446
800	523
900	703
1000	784
1200	1228

1) Values for aluminum transmitter, AlSi10Mg, coated: + 0.7 kg

Order code for "Calibration flow", options H and K, or options H/K or order code for "Sensor option", option CA

Option	Description
H	MID Type Examination Cert MI-001
K	OIML R49 Class 2
CA	IP66/67, Type 4X, fully welded; corrosion protection EN ISO 12944 C5-M

Order code for "Design", option A "Insertion length short, ISO/DVGW to DN400, DN450-2000 1:1" and order code for "Design", option B "Insertion length long, ISO/DVGW to DN400, DN450-2000 1:1.3"

EN 1092-1		
DN [mm]	Pressure rating	Weight [kg] Order code for "Housing", option M, Q Polycarbonate plastic ¹⁾
25	PN 40	9
32	PN 40	10
40	PN 40	11
50	PN 40	12
65	PN 16	13
80	PN 16	15
100	PN 16	17
125	PN 16	22
150	PN 16	27
200	PN 10	38
250	PN 10	51
300	PN 10	60

1) Values for aluminum transmitter, AlSi10Mg, coated: + 0.7 kg

Order code for "Design", option C "Insertion length short ISO/DVGW to DN300, without inlet/outlet runs, constricted meas.tube"

EN 1092-1 (DIN 2501)		
DN [mm]	Pressure rating	Weight [kg] Order code for "Housing", option M, Q Polycarbonate plastic ¹⁾
50	PN 40	12.6
65	PN 16	14.0
80	PN 16	16.4
100	PN 16	18.0
125	PN 16	26.0
150	PN 16	32.3
200	PN 16	46.3
250	PN 16	68.1
300	PN 16	85.7

1) Values for aluminum transmitter, AlSi10Mg, coated: + 0.7 kg

Order code for "Design", option A "Insertion length short, ISO/DVGW to DN400, DN450-2000 1:1" and order code for "Design", option B "Insertion length long, ISO/DVGW to DN400, DN450-2000 1:1.3"

AS 2129, PN 16	
DN [mm]	Weight [kg] Order code for "Housing", option M, Q Polycarbonate plastic ¹⁾
80	15
100	17
150	27

1) Values for aluminum transmitter, AlSi10Mg, coated: + 0.7 kg

Order code for "Design", option C "Insertion length short ISO/DVGW to DN300, without inlet/outlet runs, constricted meas.tube"

AS 2129, PN 16	
DN [mm]	Weight [kg] Order code for "Housing", option M, Q Polycarbonate plastic ¹⁾
80	16.4
100	18.0
150	32.3

1) Values for aluminum transmitter, AlSi10Mg, coated: + 0.7 kg

Order code for "Design", option A "Insertion length short, ISO/DVGW to DN400, DN450-2000 1:1" and order code for "Design", option B "Insertion length long, ISO/DVGW to DN400, DN450-2000 1:1.3"

JIS B2220, 10K	
DN [mm]	Weight [kg] Order code for "Housing", option M, Q Polycarbonate plastic ¹⁾
25	9
32	10
40	10
50	11
65	12
80	13
100	15
125	20
150	25
200	34
250	50
300	57
350	79
400	100
450	128
500	142
600	188
700	280
750	331

1) Values for aluminum transmitter, AlSi10Mg, coated: + 0.7 kg

Order code for "Design", option C "Insertion length short ISO/DVGW to DN300, without inlet/outlet runs, constricted meas.tube"

JIS B2220, 10K	
DN [mm]	Weight [kg] Order code for "Housing", option M, Q Polycarbonate plastic ¹⁾
50	11.6
65	13.0
80	14.4
100	16.8
125	24.4
150	32.0
200	43.2
250	64.9
300	75.2

1) Values for aluminum transmitter, AlSi10Mg, coated: + 0.7 kg

Weight in US units

Standard version

Order code for "Design", option A "Insertion length short, ISO/DVGW to DN400, DN450-2000 1:1" and order code for "Design", option B "Insertion length long, ISO/DVGW to DN400, DN450-2000 1:1.3"

ASME B16.5, Class 150	
DN [in]	Weight [lbs] Order code for "Housing", option M, Q Polycarbonate plastic ¹⁾
1	11
1½	18
2	20
3	26
4	31
6	53
8	95
10	161
12	238
14	386
16	452
18	562
20	628
24	893

1) Values for aluminum transmitter, AlSi10Mg, coated: + 1.5 lbs

Order code for "Design", option C "Insertion length short ISO/DVGW to DN300, without inlet/outlet runs, constricted meas.tube"

ASME B16.5, Class 150	
DN [in]	Weight [lbs] Order code for "Housing", option M, Q Polycarbonate plastic ¹⁾
2	21.3
3	29.1
4	35.6
6	68.4
8	116.2
10	198.9
12	285.2

1) Values for aluminum transmitter, AlSi10Mg, coated: + 1.5 lbs

AWWA C207, Class D	
DN [in]	Weight [lbs] Order code for "Housing", option M, Q Polycarbonate plastic ¹⁾
28	882
30	1014
32	1213
36	1764
40	1985
42	2426
48	3087
54	4851
60	5954
66	8159
72	9041
78	10143

1) Values for aluminum transmitter, AlSi10Mg, coated: + 1.5 lbs

Order code for "Design", option A

Option A "Insertion length short; ISO/DVGW to DN400, DN450-2000 1:1"

ASME B16.5, Class 150	
DN [in]	Weight [lbs] Order code for "Housing", option M, Q Polycarbonate plastic ¹⁾
18	423
20	505
24	668

1) Values for aluminum transmitter, AlSi10Mg, coated: + 1.5 lbs

AWWA C207, Class D	
DN [in]	Weight [lbs] Order code for "Housing", option M, Q Polycarbonate plastic ¹⁾
28	589
30	703
32	847
36	1039
40	1346
42	1567
48	2062
54	2895
60	3595
66	4931

AWWA C207, Class D	
DN [in]	Weight [lbs] Order code for "Housing", option M, Q Polycarbonate plastic ¹⁾
72	5 709
78	6 928

1) Values for aluminum transmitter, AlSi10Mg, coated: + 1.5 lbs

Order code for "Sensor option", option CA

Option CA "IP66/67, Type 4X, fully welded; corrosion protection EN ISO 12944 C5-M

Order code for "Design", option A "Insertion length short, ISO/DVGW to DN400, DN450-2000 1:1" and order code for "Design", option B "Insertion length long, ISO/DVGW to DN400, DN450-2000 1:1.3"

ASME B16.5, Class 150	
DN [in]	Weight [lbs]
1	17.6
1½	19.8
2	24.3
3	33.1
4	41.9
6	61.7
8	97.0
10	134.5
12	189.6

Order code for "Design", option C "Insertion length short ISO/DVGW to DN300, without inlet/outlet runs, constricted meas.tube"

ASME B16.5, Class 150	
DN [in]	Weight [lbs]
2	25.6
3	36.2
4	46.5
6	77.1
8	118.2
10	172.4
12	236.8

Transmitter remote version

Wall-mount housing

Depends on the material of the wall-mount housing:

- Polycarbonate plastic: 1.3 kg (2.9 lb)
- Aluminum, AlSi10Mg, coated: 2.0 kg (4.4 lb)

Sensor remote version

Weight data:

- Including sensor connection housing
- Excluding the connecting cable
- Excluding packaging material

Weight in SI units

Standard version

Order code for "Design", option A "Insertion length short, ISO/DVGW to DN400, DN450-2000 1:1" and order code for "Design", option B "Insertion length long, ISO/DVGW to DN400, DN450-2000 1:1.3"

EN 1092-1		
DN [mm]	Pressure rating	Weight [kg]
25	PN 40	5
32	PN 40	6
40	PN 40	7
50	PN 40	9
65	PN 16	10
80	PN 16	12
100	PN 16	14
125	PN 16	20
150	PN 16	24
200	PN 10	43
250	PN 10	63
300	PN 10	68
350	PN 6	103
375	PN 6	118
400	PN 6	118
450	PN 6	159
500	PN 6	154
600	PN 6	206
700	PN 6	302
800	PN 6	355
900	PN 6	483
1000	PN 6	587
1200	PN 6	848
1400	PN 6	1298
1600	PN 6	1698
1800	PN 6	2198
2000	PN 6	2798

Order code for "Design", option C "Insertion length short ISO/DVGW to DN300, without inlet/outlet runs, constricted meas.tube"

EN 1092-1		
DN [mm]	Pressure rating	Weight [kg]
50	PN 40	9.6
65	PN 16	11.0
80	PN 16	13.4
100	PN 16	15.0
125	PN 16	24.0
150	PN 16	29.3
200	PN 16	51.3
250	PN 16	80.1
300	PN 16	93.7

Order code for "Design", option A "Insertion length short, ISO/DVGW to DN400, DN450-2000 1:1" and order code for "Design", option B "Insertion length long, ISO/DVGW to DN400, DN450-2000 1:1.3"

AS 4087, PN 16	
DN [mm]	Weight [kg]
80	12
100	14
150	24

Order code for "Design", option C "Insertion length short ISO/DVGW to DN300, without inlet/outlet runs, constricted meas.tube"

AS 4087, PN 16	
DN [mm]	Weight [kg]
80	13.4
100	15.0
150	29.3

Order code for "Design", option A "Insertion length short, ISO/DVGW to DN400, DN450-2000 1:1" and order code for "Design", option B "Insertion length long, ISO/DVGW to DN400, DN450-2000 1:1.3"

JIS B2220, 10K	
DN [mm]	Weight [kg]
25	5
32	5
40	6
50	7
65	9
80	11

JIS B2220, 10K	
DN [mm]	Weight [kg]
100	13
125	19
150	23
200	40
250	67
300	70
350	79
400	100
450	128
500	142
600	188
700	280
750	331

Order code for "Design", option C "Insertion length short ISO/DVGW to DN300, without inlet/outlet runs, constricted meas.tube"

JIS B2220, 10K	
DN [mm]	Weight [kg]
50	7.6
65	10.0
80	12.4
100	14.8
125	23.4
150	30.0
200	49.2
250	81.9
300	88.2

Order code for "Design", option A

Option A "Insertion length short; ISO/DVGW to DN400, DN450-2000 1:1"

EN 1092-1			
DN [mm]	Weight [kg]		
	PN 6	PN 10	PN 16
450	98	115	145
500	113	131	188
600	154	166	274
700	198	253	307
800	262	343	416
900	345	431	525
1000	446	560	725

EN 1092-1			
DN [mm]	Weight [kg]		
	PN 6	PN 10	PN 16
1200	639	837	1192
1400	1036	1348	1713
1600	1384	1985	2448
1800	1829	2570	3300
2000	2506	3178	4168

AS 2129, Table E	
DN [mm]	Weight [kg]
450	147
500	181
600	263
700	345
750	432
800	492
900	689
1000	786
1200	1246

AS 4087, PN 16	
DN [mm]	Weight [kg]
450	137
500	185
600	265
700	366
750	444
800	523
900	701
1000	784
1200	1228

Order code for "Calibration flow", options H and K or order code for "Sensor option", option CA

Option	Description
H	MID Type Examination Cert MI-001
K	OIML R49 Class 2
CA	IP66/67, Type 4X, fully welded; corrosion protection EN ISO 12944 C5-M

Order code for "Design", option A "Insertion length short, ISO/DVGW to DN400, DN450-2000 1:1" and order code for "Design", option B "Insertion length long, ISO/DVGW to DN400, DN450-2000 1:1.3"

EN 1092-1		
DN [mm]	Pressure rating	[kg]
25	PN 40	6.5
32	PN 40	8
40	PN 40	8.5
50	PN 40	10
65	PN 16	11
80	PN 16	13
100	PN 16	15
125	PN 16	20
150	PN 16	25
200	PN 10	36
250	PN 10	49
300	PN 10	58

Order code for "Design", option C "Insertion length short ISO/DVGW to DN300, without inlet/outlet runs, constricted meas.tube"

EN 1092-1		
DN [mm]	Pressure rating	[kg]
50	PN 40	10.6
65	PN 16	12.0
80	PN 16	14.4
100	PN 16	16.0
125	PN 16	24.0
150	PN 16	30.3
200	PN 16	44.3
250	PN 16	66.1
300	PN 16	83.7

Order code for "Design", option A "Insertion length short, ISO/DVGW to DN400, DN450-2000 1:1" and order code for "Design", option B "Insertion length long, ISO/DVGW to DN400, DN450-2000 1:1.3"

AS 4087, PN 16	
DN [mm]	[kg]
80	13
100	15
150	25

Order code for "Design", option C "Insertion length short ISO/DVGW to DN300, without inlet/outlet runs, constricted meas.tube"

AS 4087, PN 16	
DN [mm]	[kg]
80	14.4
100	16.0
150	30.3

Order code for "Design", option A "Insertion length short, ISO/DVGW to DN400, DN450-2000 1:1" and order code for "Design", option B "Insertion length long, ISO/DVGW to DN400, DN450-2000 1:1.3"

JIS B2220, 10K	
DN [mm]	Weight [kg]
25	6.5
32	7.5
40	7.5
50	9
65	10
80	11
100	13
125	18
150	23
200	32
250	48
300	55
350	79
400	100
450	128
500	142
600	188
700	280
750	331

Order code for "Design", option C "Insertion length short ISO/DVGW to DN300, without inlet/outlet runs, constricted meas.tube"

JIS B2220, 10K	
DN [mm]	Weight [kg]
50	9.6
65	11.0
80	12.4
100	14.8
125	22.4

JIS B2220, 10K	
DN [mm]	Weight [kg]
150	30.0
200	41.2
250	62.9
300	73.2

Weight in US units

Standard version

Order code for "Design", option A "Insertion length short, ISO/DVGW to DN400, DN450-2000 1:1" and order code for "Design", option B "Insertion length long, ISO/DVGW to DN400, DN450-2000 1:1.3"

ASME B16.5, Class 150	
DN [in]	Weight [lbs]
1	11
1½	15
2	20
3	26
4	31
6	53
8	95
10	161
12	238
14	381
16	448
18	558
20	624
24	889

Order code for "Design", option C "Insertion length short ISO/DVGW to DN300, without inlet/outlet runs, constricted meas.tube"

ASME B16.5, Class 150	
DN [in]	Weight [lbs]
2	21.3
3	29.1
4	35.6
6	68.4
8	116.2
10	198.9
12	285.2

AWWA C207, Class D	
DN [in]	Weight [lbs]
28	878
30	1010
32	1208
36	1760
40	1980
42	2421
48	3083
54	4847
60	5949
66	8154
72	9036
78	10139

Order code for "Design", option A

Option A "Insertion length short; ISO/DVGW to DN400, DN450-2000 1:1"

ASME B16.5, Class 150	
DN [in]	Weight [lbs]
18	420
20	501
24	721

AWWA C207, Class D	
DN [in]	Weight [lbs]
28	606
30	740
32	881
36	1093
40	1463
42	1695
48	2277
54	3165
60	3930
66	5425
72	6295
78	7782

Order code for "Sensor option", option CA

Option CA "IP66/67, Type 4X, fully welded; corrosion protection EN ISO 12944 C5-M"

Order code for "Design", option A "Insertion length short, ISO/DVGW to DN400, DN450-2000 1:1" and order code for "Design", option B "Insertion length long, ISO/DVGW to DN400, DN450-2000 1:1.3"

ASME B16.5, Class 150	
DN [in]	Weight [lbs]
1	13
1½	15.5
2	20
3	29
4	37
6	57
8	93
10	130
12	185

Order code for "Design", option C "Insertion length short ISO/DVGW to DN300, without inlet/outlet runs, constricted meas.tube"

ASME B16.5, Class 150	
DN [in]	Weight [lbs]
2	21.3
3	32.1
4	41.6
6	72.4
8	114.2
10	167.9
12	232.2

Measuring tube specification

Nominal diameter		Pressure rating				Measuring tube internal diameter			
		EN (DIN)	ASME AWWA	AS 2129 AS 4087	JIS	Hard rubber		Polyurethane	
[mm]	[in]					[mm]	[in]	[mm]	[in]
25	1	PN 40	Class 150	-	20K	-	-	24	0.94
32	-	PN 40	-	-	20K	-	-	32	1.26
40	1 ½	PN 40	Class 150	-	20K	-	-	38	1.50
50	2	PN 40	Class 150	Table E, PN 16	10K	50	1.97	50	1.97
65	-	PN 16	-	-	10K	66	2.60	66	2.60
80	3	PN 16	Class 150	Table E, PN 16	10K	79	3.11	79	3.11
100	4	PN 16	Class 150	Table E, PN 16	10K	102	4.02	102	4.02
125	-	PN 16	-	-	10K	127	5.00	127	5.00
150	6	PN 16	Class 150	Table E, PN 16	10K	156	6.14	156	6.14

Nominal diameter		Pressure rating				Measuring tube internal diameter			
		EN (DIN)	ASME AWWA	AS 2129 AS 4087	JIS	Hard rubber		Polyurethane	
[mm]	[in]					[mm]	[in]	[mm]	[in]
200 ¹⁾	8	PN 10	Class 150	Table E, PN 16	10K	204	8.03	204	8.03
200 ²⁾	8	PN 16	Class 150	Table E, PN 16	10K	201	7.91	-	-
250 ¹⁾	10	PN 10	Class 150	Table E, PN 16	10K	258	10.2	258	10.2
250 ²⁾	10	PN 16	Class 150	Table E, PN 16	10K	251	9.88	-	-
300 ¹⁾	12	PN 10	Class 150	Table E, PN 16	10K	309	12.2	309	12.2
300 ²⁾	12	PN 16	Class 150	Table E, PN 16	10K	309	12.2	-	-
350	14	PN 6	Class 150	Table E, PN 16	10K	337	13.3	342	13.5
375	15	-	-	PN 16	10K	389	15.3	-	-
400	16	PN 6	Class 150	Table E, PN 16	10K	387	15.2	392	15.4
450	18	PN 6	Class 150	-	10K	436	17.1	437	17.2
500	20	PN 6	Class 150	Table E, PN 16	10K	487	19.1	492	19.4
600	24	PN 6	Class 150	Table E, PN 16	10K	585	23.0	594	23.4
700	28	PN 6	Class D	Table E, PN 16	10K	690	27.1	692	27.2
750	30	-	Class D	Table E, PN 16	10K	741	29.1	742	29.2
800	32	PN 6	Class D	Table E, PN 16	-	788	31.0	794	31.3
900	36	PN 6	Class D	Table E, PN 16	-	889	35.0	891	35.1
1000	40	PN 6	Class D	Table E, PN 16	-	991	39.0	994	39.1
-	42	-	Class D	-	-	1043	41.1	1043	41.1
1200	48	PN 6	Class D	Table E, PN 16	-	1191	46.9	1197	47.1
-	54	-	Class D	-	-	1339	52.7	-	-
1400	-	PN 6	-	-	-	1402	55.2	-	-
-	60	-	Class D	-	-	1492	58.7	-	-
1600	-	PN 6	-	-	-	1600	63.0	-	-
-	66	-	Class D	-	-	1638	64.5	-	-
1800	72	PN 6	Class D	-	-	1786	70.3	-	-
2000	78	PN 6	Class D	-	-	1989	78.3	-	-

- 1) Order code for "Design", option A "Insertion length short, ISO/DVGW to DN400, DN450-2000 1:1" and order code for "Design", option B "Insertion length long, ISO/DVGW to DN400, DN450-2000 1:1.3"
- 2) Order code for "Design", option C "Insertion length short ISO/DVGW to DN300, without inlet/outlet runs, constricted meas.tube"

Materials

Transmitter housing

Compact version, standard

- Order code for "Housing", option **A** "Compact, aluminum coated":
Aluminum, AlSi10Mg, coated
- Order code for "Housing", option **M**: polycarbonate plastic
- Window material:
 - For order code for "Housing", option **A**: glass
 - For order code for "Housing", option **M**: plastic

Compact version, inclined

- Order code for "Housing", option **R** "Compact, aluminum coated":
Aluminum, AlSi10Mg, coated
- Order code for "Housing", option **Q**: polycarbonate plastic
- Window material:
 - For order code for "Housing", option **R**: glass
 - For order code for "Housing", option **Q**: plastic

Remote version (wall-mount housing)

- Order code for "Housing", option **P** "Compact, aluminum coated":
Aluminum, AlSi10Mg, coated
- Order code for "Housing", option **N**: polycarbonate plastic
- Window material:
 - For order code for "Housing", option **P**: glass
 - For order code for "Housing", option **N**: plastic

Cable entries/cable glands

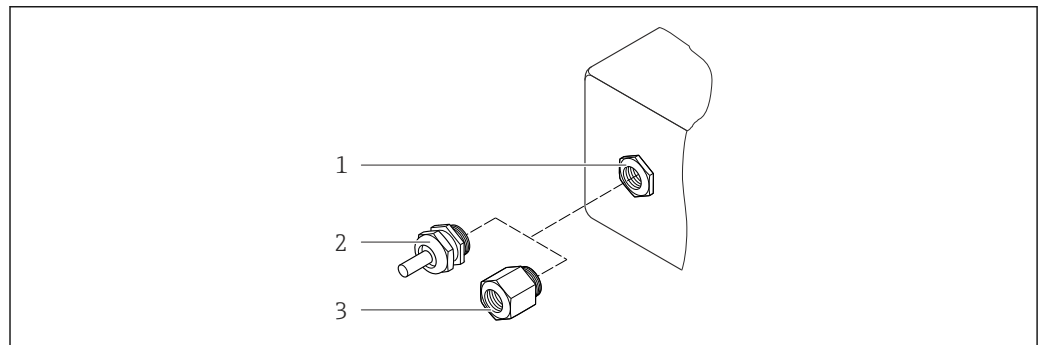

A0020640

42 Possible cable entries/cable glands

- 1 Female thread M20 × 1.5
- 2 Cable gland M20 × 1.5
- 3 Adapter for cable entry with internal thread G ½" or NPT ½"

Compact and remote versions and sensor connection housing

Cable entry/cable gland	Material
Cable gland M20 × 1.5	Plastic
Remote version: cable gland M20 × 1.5 Option of reinforced connecting cable	<ul style="list-style-type: none"> ■ Sensor connection housing: Nickel-plated brass ■ Transmitter wall-mount housing: Plastic
Adapter for cable entry with internal thread G ½" or NPT ½"	Nickel-plated brass

Connecting cable for remote version

Electrode and coil current cable

- Standard cable: PVC cable with copper shield
- Reinforced cable: PVC cable with copper shield and additional steel wire braided jacket

Sensor connection housing

- Standard: aluminum, AlSi10Mg, coated (IP66/67)
- Option:
 - Polycarbonate for IP68 with DN 50 to 300 (2 to 12")
 - Polycarbonate for order code "Sensor option", option CA...CE "Corrosion protection" with DN 350 to 2000 (14 to 78")

Sensor housing

- DN 25 to 300 (1 to 12"):
 - Aluminum, AlSi10Mg, coated
 - Carbon steel with Al/Zn protective coating
- DN 25 to 300 (1 to 12"):
 - Carbon steel with protective varnish (IP68)
- DN 350 to 2000 (14 to 78"):
 - Carbon steel with protective varnish

Measuring tubes

- DN 25 to 300 (1 to 12")³⁾: stainless steel, 1.4301/1.4306/304/304L
- DN 350 to 1200 (14 to 48")³⁾: stainless steel, 1.4301/304
- DN 1350 to 2000 (54 to 78")³⁾: stainless steel, 1.4301 similar to 304

Liner

- DN 25 to 1200 (1 to 48"): polyurethane
- DN 50 to 2000 (2 to 78"): hard rubber

Electrodes

- Stainless steel, 1.4435 (316L)
- Alloy C22, 2.4602 (UNS N06022)
- Tantalum

Process connections*EN 1092-1 (DIN 2501)*

- DN 25 to 300³⁾:
 - Stainless steel, 1.4571/F316L
 - Carbon steel, S235JRG2/S235JR+N/P250GH/E250C
- DN 350 to 600³⁾:
 - Stainless steel, 1.4571/F316L
 - Carbon steel, P245GH
- >DN 600⁴⁾:
 - Stainless steel, 1.4404/F316L
 - Carbon steel, P245GH

ASME B16.5

- DN 25 to 1200 (1 to 48"):
 - Stainless steel, F316L similar to 1.4404
- DN 25 to 300 (1 to 12")⁴⁾:
 - Carbon steel, A105 similar to 1.0432
- DN 350 to 1200 (14 to 48")⁴⁾:
 - Carbon steel, A105

3) For carbon steel flange material with Al/Zn protective coating (DN 25 to 300 (1 to 12")), protective varnish (IP68) (DN 50 to 300 (2 to 12")) or protective varnish ≥ DN 350 (14")

4) Order code for "Design", option A "Insertion length short"

AWWA C207

DN 48 to 78⁴⁾:

Carbon steel, P265GH/S275JR/A105/A181 Class 70/E250C

AS 2129

■ DN 50 to 1200:

Carbon steel, A105/S235JRG2

■ DN 350 to 1200⁴⁾:

Carbon steel, P235GH/P265GH/A105

AS 4087

■ DN 50 to 1200:

Carbon steel, A105/S275JR

■ DN 350 to 1200⁴⁾:

Carbon steel, A105/P265GH/S275JR

JIS B2220

■ Stainless steel, F316L similar to 1.4404

■ Carbon steel, A105/A350LF2³⁾

Seals

As per DIN EN 1514-1, form IBC

Accessories

Display protection

Stainless steel, 1.4301 (304L)

Ground disks

■ Stainless steel, 1.4435 (316L)

■ Alloy C22, 2.4602 (UNS N06022)

■ Tantalum

Fitted electrodes

Measurement, reference and empty pipe detection electrodes available as standard with:

■ 1.4435 (316L)

■ Alloy C22, 2.4602 (UNS N06022)

■ Tantalum

Process connections

■ EN 1092-1 (DIN 2501)⁵⁾

- DN ≤ 300: fixed flange (PN 10/16/25/40) = form A

- DN ≥ 350: fixed flange (PN 6/10/16/25) = flat face

- DN 450 to 2000⁶⁾: fixed flange (PN 6/10/16) = flat face

■ ASME B16.5

- DN 25 to 600 (1 to 24"): fixed flange (Class 150)

- DN 350 to 2000 (14 to 78")⁶⁾: fixed flange (Class 150)

- DN 25 to 150 (1 to 6"): fixed flange (Class 300)

■ AWWA C207

- DN 48 to 72": fixed flange (Class D)

- DN 48 to 78"⁶⁾: fixed flange (Class D)

5) Dimensions as per DIN 2501, DN 65 (2 1/2") PN 16 and DN 600 (24") PN 16 only as per EN 1092-1

6) Order code for "Design", option A "Insertion length short"

- AS 2129
 - DN 50 to 1200: fixed flange (Table E)
 - DN 350 to 1200⁶⁾: fixed flange (Table E)
- AS 4087
 - DN 50 to 1200): fixed flange (PN 16)
 - DN 350 to 1200⁶⁾: fixed flange (PN 16)
- JIS B2220
 - DN 50 to 750: fixed flange (10K)
 - DN 25 to 600: fixed flange (20K)

 For information on the different materials used in the process connections

Surface roughness Electrodes with 1.4435 (316L); Alloy C22, 2.4602 (UNS N06022); tantalum:
 ≤ 0.3 to $0.5 \mu\text{m}$ (11.8 to $19.7 \mu\text{in}$)
 (All data relate to parts in contact with fluid)

16.11 Operability

Languages Can be operated in the following languages:

- Via local operation:
 - English, German, French, Spanish, Italian, Dutch, Portuguese, Polish, Russian, Turkish, Chinese, Japanese, Bahasa (Indonesian), Vietnamese, Czech, Swedish
- Via "FieldCare", "DeviceCare" operating tool:
 - English, German, French, Spanish, Italian, Chinese, Japanese
- Via Web browser
 - English, German, French, Spanish, Italian, Dutch, Portuguese, Polish, Russian, Turkish, Chinese, Japanese, Bahasa (Indonesian), Vietnamese, Czech, Swedish

Local display

Via display module

Two display modules are available:

- Standard:
 - 4-line, illuminated, graphic display; touch control
- Optionally via order code for "Display", option **W1** "WLAN display":
 - 4-line, illuminated, graphic display; touch control + WLAN

 Information about WLAN interface →  78

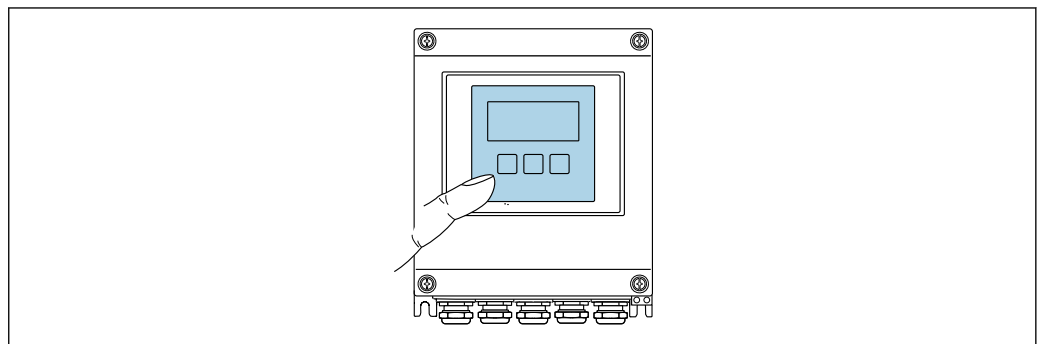



 43 Operation with touch control

A0032074

Display elements

- 4-line, illuminated, graphic display
- White background lighting; switches to red in event of device errors
- Format for displaying measured variables and status variables can be individually configured
- Permitted ambient temperature for the display: -20 to +60 °C (-4 to +140 °F)
The readability of the display may be impaired at temperatures outside the temperature range.



Operating elements

- External operation via touch control (3 optical keys) without opening the housing: , , 
- Operating elements also accessible in the various zones of the hazardous area

Remote operation →  78

Service interface →  78

Supported operating tools Different operating tools can be used for local or remote access to the measuring device. Depending on the operating tool used, access is possible with different operating units and via a variety of interfaces.

Supported operating tools	Operating unit	Interface	Additional information
Web browser	Notebook, PC or tablet with Web browser	<ul style="list-style-type: none"> ■ CDI-RJ45 service interface ■ WLAN interface 	Special Documentation for device
DeviceCare SFE100	Notebook, PC or tablet with Microsoft Windows system	<ul style="list-style-type: none"> ■ CDI-RJ45 service interface ■ WLAN interface ■ Fieldbus protocol 	→  151
FieldCare SFE500	Notebook, PC or tablet with Microsoft Windows system	<ul style="list-style-type: none"> ■ CDI-RJ45 service interface ■ WLAN interface ■ Fieldbus protocol 	→  151
Device Xpert	Field Xpert SFX 100/350/370	HART and FOUNDATION Fieldbus fieldbus protocol	Operating Instructions BA01202S Device description files: Use update function of handheld terminal

 Other operating tools based on FDT technology with a device driver such as DTM/ iDTM or DD/EDD can be used for device operation. These operating tools are available from the individual manufacturers. Integration into the following operating tools, among others, is supported:

- FactoryTalk AssetCentre (FTAC) by Rockwell Automation → www.rockwellautomation.com
- Process Device Manager (PDM) by Siemens → www.siemens.com
- Asset Management Solutions (AMS) by Emerson → www.emersonprocess.com
- FieldCommunicator 375/475 by Emerson → www.emersonprocess.com
- Field Device Manager (FDM) by Honeywell → www.honeywellprocess.com
- FieldMate by Yokogawa → www.yokogawa.com
- PACTWare → www.pactware.com

The associated device description files are available at: www.endress.com → Downloads

Web server

Thanks to the integrated Web server, the device can be operated and configured via a Web browser and via a service interface (CDI-RJ45) or via a WLAN interface. The structure of the operating menu is the same as for the local display. In addition to the measured values, status information on the device is also displayed and allows the user to monitor the status of the device. Furthermore the device data can be managed and the network parameters can be configured.

A device that has a WLAN interface (can be ordered as an option) is required for the WLAN connection: order code for "Display", option **W1** "WLAN display": 4-line, illuminated; touch control + WLAN. The device acts as an Access Point and enables communication by computer or a mobile handheld terminal.

Supported functions

Data exchange between the operating unit (such as a notebook for example) and the measuring device:

- Upload the configuration from the measuring device (XML format, configuration backup)
- Save the configuration to the measuring device (XML format, restore configuration)
- Export event list (.csv file)
- Export parameter settings (.csv file or PDF file, document the measuring point configuration)
- Export the Heartbeat verification log (PDF file, only available with the "Heartbeat Verification" application package)
- Flash firmware version for device firmware upgrade, for instance
- Download driver for system integration
- Visualize up to 1000 saved measured values (only available with the **Extended HistoROM** application package → 📄 196)

 Webservice special documentation

HistoROM data management

The measuring device features HistoROM data management. HistoROM data management comprises both the storage and import/export of key device and process data, making operation and servicing far more reliable, secure and efficient.

 When the device is delivered, the factory settings of the configuration data are stored as a backup in the device memory. This memory can be overwritten with an updated data record, for example after commissioning.

Additional information on the data storage concept

There are different types of data storage units in which device data are stored and used by the device:

	Device memory	T-DAT	S-DAT
Available data	<ul style="list-style-type: none"> ▪ Device firmware package ▪ Driver for system integration e.g.: DD for HART 	<ul style="list-style-type: none"> ▪ Event history, such as diagnostic events ▪ Measured value memory ("Extended HistoROM" order option) ▪ Current parameter data record (used by firmware at run time) ▪ Maximum indicators (min/max values) ▪ Totalizer values 	<ul style="list-style-type: none"> ▪ Sensor data: diameter etc. ▪ Serial number ▪ User-specific access code (to use the "Maintenance" user role) ▪ Calibration data ▪ Device configuration (e.g. SW options, fixed I/O or multi I/O)
Storage location	Fixed on the user interface board in the connection compartment	Can be plugged into the user interface board in the connection compartment	In the sensor plug in the transmitter neck part

Data backup**Automatic**

- The most important device data (sensor and transmitter) are automatically saved in the DAT modules
- If the transmitter or measuring device is replaced: once the T-DAT containing the previous device data has been exchanged, the new measuring device is ready for operation again immediately without any errors
- If the sensor is replaced: once the sensor has been replaced, new sensor data are transferred from the S-DAT in the measuring device and the measuring device is ready for operation again immediately without any errors

Data transfer**Manual**

Transfer of a device configuration to another device using the export function of the specific operating tool, e.g. with FieldCare, DeviceCare or Web server: to duplicate the configuration or to store in an archive (e.g. for backup purposes)

Event list**Automatic**

- Chronological display of up to 20 event messages in the events list
- If the **Extended HistoROM** application package (order option) is enabled: up to 100 event messages are displayed in the events list along with a time stamp, plain text description and remedial measures
- The events list can be exported and displayed via a variety of interfaces and operating tools e.g. DeviceCare, FieldCare or Web server

Data logging**Manual**

If the **Extended HistoROM** application package (order option) is enabled:

- Record up to 1 000 measured values via 1 to 4 channels
- User configurable recording interval
- Record up to 250 measured values via each of the 4 memory channels
- Export the measured value log via a variety of interfaces and operating tools e.g. FieldCare, DeviceCare or web server

16.12 Certificates and approvals

CE mark

The measuring system is in conformity with the statutory requirements of the applicable EU Directives. These are listed in the corresponding EU Declaration of Conformity along with the standards applied.



Endress+Hauser confirms successful testing of the device by affixing to it the CE mark.

C-Tick symbol

The measuring system meets the EMC requirements of the "Australian Communications and Media Authority (ACMA)".

Ex approval

The devices are certified for use in hazardous areas and the relevant safety instructions are provided in the separate "Control Drawing" document. Reference is made to this document on the nameplate.

Drinking water approval	<ul style="list-style-type: none"> ■ ACS ■ KTW/W270 ■ NSF 61 ■ WRAS BS 6920
HART certification	<p>HART interface</p> <p>The measuring device is certified and registered by the FieldComm Group. The measuring system meets all the requirements of the following specifications:</p> <ul style="list-style-type: none"> ■ Certified according to HART 7 ■ The device can also be operated with certified devices of other manufacturers (interoperability)
Radio approval	<p>The measuring device has radio approval.</p> <p> For detailed information on the radio approval, see the Special Documentation →  197</p>
Measuring instrument approval	<p>The measuring device is (optionally) approved as a cold water meter (MI-001) for volume measurement in service subject to legal metrological control in accordance with the European Measuring Instruments Directive 2004/22/EC (MID).</p> <p>The measuring device is qualified to OIML R49: 2006 and has an OIML Certificate of Conformity (optional).</p>
Other standards and guidelines	<ul style="list-style-type: none"> ■ EN 60529 Degrees of protection provided by enclosures (IP code) ■ EN 61010-1 Safety requirements for electrical equipment for measurement, control and laboratory use - general requirements ■ IEC/EN 61326 Emission in accordance with Class A requirements. Electromagnetic compatibility (EMC requirements). ■ ANSI/ISA-61010-1 (82.02.01): 2004 Safety Requirements for Electrical Equipment for Measurement, Control and Laboratory Use - Part 1 General Requirements ■ CAN/CSA-C22.2 No. 61010-1-04 Safety Requirements for Electrical Equipment for Measurement, Control and Laboratory Use - Part 1 General Requirements ■ NAMUR NE 21 Electromagnetic compatibility (EMC) of industrial process and laboratory control equipment ■ NAMUR NE 32 Data retention in the event of a power failure in field and control instruments with microprocessors ■ NAMUR NE 43 Standardization of the signal level for the breakdown information of digital transmitters with analog output signal. ■ NAMUR NE 53 Software of field devices and signal-processing devices with digital electronics ■ NAMUR NE 105 Specifications for integrating fieldbus devices in engineering tools for field devices ■ NAMUR NE 107 Self-monitoring and diagnosis of field devices ■ NAMUR NE 131 Requirements for field devices for standard applications

16.13 Application packages

Many different application packages are available to enhance the functionality of the device. Such packages might be needed to address safety aspects or specific application requirements.

The application packages can be ordered with the device or subsequently from Endress+Hauser. Detailed information on the order code in question is available from your local Endress+Hauser sales center or on the product page of the Endress+Hauser website: www.endress.com.

Cleaning

Package	Description
Electrode cleaning circuit (ECC)	The electrode cleaning circuit (ECC) function has been developed to have a solution for applications where magnetite (Fe ₃ O ₄) deposits frequently occur (e.g. hot water). Since magnetite is highly conductive this build up leads to measuring errors and ultimately to the loss of signal. The application package is designed to AVOID build up of highly conductive matter and thin layers (typical of magnetite).



Diagnostics functions

Package	Description
Extended HistoROM	Comprises extended functions concerning the event log and the activation of the measured value memory. Event log: Memory volume is extended from 20 message entries (standard version) to up to 100 entries. Data logging (line recorder): <ul style="list-style-type: none"> ▪ Memory capacity for up to 1000 measured values is activated. ▪ 250 measured values can be output via each of the 4 memory channels. The recording interval can be defined and configured by the user. ▪ Measured value logs can be accessed via the local display or operating tool e.g. FieldCare, DeviceCare or Web server.

Heartbeat Technology

Package	Description
Heartbeat Verification +Monitoring	<p>Heartbeat Verification Meets the requirement for traceable verification to DIN ISO 9001:2008 Chapter 7.6 a) "Control of monitoring and measuring equipment".</p> <ul style="list-style-type: none"> ▪ Functional testing in the installed state without interrupting the process. ▪ Traceable verification results on request, including a report. ▪ Simple testing process via local operation or other operating interfaces. ▪ Clear measuring point assessment (pass/fail) with high test coverage within the framework of manufacturer specifications. ▪ Extension of calibration intervals according to operator's risk assessment. <p>Heartbeat Monitoring Continuously supplies data, which are characteristic of the measuring principle, to an external condition monitoring system for the purpose of preventive maintenance or process analysis. These data enable the operator to:</p> <ul style="list-style-type: none"> ▪ Draw conclusions - using these data and other information - about the impact process influences (such as corrosion, abrasion, buildup etc.) have on the measuring performance over time. ▪ Schedule servicing in time. ▪ Monitor the process or product quality, e.g. gas pockets.

16.14 Accessories

 Overview of accessories available for order →  150

16.15 Supplementary documentation

 For an overview of the scope of the associated Technical Documentation, refer to the following:

- The *W@M Device Viewer* : Enter the serial number from the nameplate (www.endress.com/deviceviewer)
- The *Endress+Hauser Operations App*: Enter the serial number from the nameplate or scan the 2-D matrix code (QR code) on the nameplate.

Standard documentation

Technical Information

Measuring device	Documentation code
Promag W 400	TI01046D

Brief Operating Instructions

Brief Operating Instructions for the sensor

Measuring device	Documentation code
Proline Promag W	KA01266D

Measuring device	Documentation code
Promag 400	KA01263D

Description of device parameters



Measuring device	Documentation code
Promag 400	GP01043D

Supplementary device-dependent documentation

Special Documentation

Content	Documentation code
Web server	SD01811D
Heartbeat Technology	SD01847D
Display modules A309/A310	SD01793D
Information on Custody Transfer Measurement	SD01230D

Installation Instructions

Contents	Comment
Installation instructions for spare part sets and accessories	<ul style="list-style-type: none"> ▪ Access the overview of all the available spare part sets via <i>W@M Device Viewer</i> →  148 ▪ Accessories available for order with Installation Instructions →  150

Index

A

Access authorization to parameters	
Read access	70
Write access	70
Access code	70
Incorrect input	70
Adapters	25
Adapting the diagnostic behavior	136
Adapting the status signal	136
Ambient temperature	
Influence	163
Ambient temperature range	24
AMS Device Manager	81
Function	81
Application	153
Applicator	153
Approvals	194

B

Buried applications	27
Burst Mode	85

C

C-Tick symbol	194
Cable entries	
Technical data	161
Cable entry	
Degree of protection	54
CE mark	11, 194
Certificates	194
Checklist	
Post-connection check	54
Post-installation check	40
Cleaning	
Exterior cleaning	147
Interior cleaning	147
Commissioning	87
Advanced settings	105
Configuring the measuring device	87
Communication-specific data	83
Conductivity	165
Connecting cable	41
Connecting the measuring device	46
Connection	
see Electrical connection	
Connection examples, potential equalization	50
Connection preparations	44
Connection tools	43
Context menu	
Calling up	65
Closing	65
Explanation	65
Current consumption	161

D

Declaration of Conformity	11
---------------------------	----

Define access code	117, 118
Degree of protection	54, 164
Design	
Measuring device	14
Designated use	10
Device components	14
Device description files	83
Device documentation	
Supplementary documentation	8
Device locking, status	120
Device name	
Sensor	17
Transmitter	16
Device repair	148
Device revision	83
Device type ID	83
DeviceCare	81
Device description file	83
Diagnostic behavior	
Explanation	132
Symbols	132
Diagnostic information	
Design, description	132, 135
DeviceCare	135
FieldCare	135
Light emitting diodes	130
Onsite display	131
Overview	137
Remedial measures	137
Web browser	133
Diagnostic list	141
Diagnostic message	131
Diagnostics	
Symbols	131
DIP switch	
see Write protection switch	
Direct access	67
Direct access code	61
Disabling write protection	117
Display	
see Local display	
Display area	
For operational display	60
In the navigation view	62
Display values	
For locking status	120
Disposal	149
Document	
Function	6
Symbols used	6
Document function	6
Down pipe	21
Drinking water approval	195

E

ECC	111
-----	-----

- Electrical connection
 - Degree of protection 54
 - Measuring device 41
 - Operating tools
 - Via service interface (CDI-RJ45) 78
 - Via WLAN interface 78
 - Web server 78
 - WLAN interface 78
- Electromagnetic compatibility 165
- Enabling write protection 117
- Enabling/disabling the keypad lock 71
- Endress+Hauser services
 - Maintenance 147
 - Repair 148
- Environment
 - Ambient temperature 24
 - Impact resistance 165
 - Mechanical load 165
 - Shock resistance 164
 - Storage temperature 164
 - Vibration resistance 164
- Error messages
 - see Diagnostic messages
- Event list 141
- Event logbook 141
- Ex approval 194
- Extended order code
 - Sensor 17
 - Transmitter 16
- Exterior cleaning 147
- F**
- Field Communicator
 - Function 82
- Field Communicator 475 82
- Field of application
 - Residual risks 11
- Field Xpert
 - Function 79
- Field Xpert SFX350 79
- FieldCare 80
 - Device description file 83
 - Establishing a connection 80
 - Function 80
 - User interface 81
- Filtering the event logbook 142
- Firmware
 - Release date 83
 - Version 83
- Firmware history 146
- Fitted electrodes 190
- Flow direction 22
- Flow limit 166
- Function check 87
- Function range
 - Field Xpert 79
- Function scope
 - AMS Device Manager 81
 - Field Communicator 82
- Field Communicator 475 82
- SIMATIC PDM 82
- Functions
 - see Parameter
- G**
- Galvanic isolation 160
- H**
- Hardware write protection 118
- HART certification 195
- HART protocol
 - Device variables 83
 - Measured values 83
- Heavy sensors 22
- Help text
 - Calling up 68
 - Closing 68
 - Explanation 68
- I**
- I/O electronics module 14, 48
- Identifying the measuring device 15
- Immersion in water 26
- Impact resistance 165
- Incoming acceptance 15
- Influence
 - Ambient temperature 163
- Information on the document 6
- Inlet runs 23
- Input 153
- Input mask 63
- Inspection
 - Installation 40
 - Received goods 15
- Inspection check
 - Connection 54
- Installation 21
- Installation conditions
 - Adapters 25
 - Buried applications 27
 - Down pipe 21
 - Heavy sensors 22
 - Immersion in water 26
 - Inlet and outlet runs 23
 - Installation dimensions 23
 - Length of connecting cable 26
 - Mounting location 21
 - Orientation 22
 - Partially filled pipe 22
 - System pressure 24
 - Vibrations 25
- Installation dimensions 23
- Interior cleaning 147
- L**
- Languages, operation options 191
- Length of connecting cable 26
- Line recorder 125

Local display 191
 Editing view 63
 Navigation view 61
 see Operational display
 Low flow cut off 160

M

Main electronics module 14
 Maintenance tasks 147
 Replacing seals 147
 Manufacturer ID 83
 Manufacturing date 16, 17
 Materials 187
 Maximum measured error 161
 Measured variables
 Calculated 153
 Measured 153
 see Process variables
 Measuring and test equipment 147
 Measuring device
 Configuration 87
 Conversion 148
 Design 14
 Disposal 149
 Integrating via communication protocol 83
 Mounting the sensor 28
 Mounting the ground cable/ground disks 28
 Mounting the seals 28
 Screw tightening torques 29
 Preparing for electrical connection 44
 Preparing for mounting 28
 Removing 149
 Repairs 148
 Switch-on 87
 Measuring instrument approval 195
 Measuring principle 153
 Measuring range 153
 Measuring system 153
 Measuring tube specification 186
 Mechanical load 165
 Medium temperature range 165
 Menu
 Diagnostics 140
 Setup 87, 88
 Menus
 For measuring device configuration 87
 For specific settings 105
 Mounting dimensions
 see Installation dimensions
 Mounting location 21
 Mounting preparations 28
 Mounting tools 27

N

Nameplate
 Sensor 17
 Transmitter 16
 Navigation path (navigation view) 61

Navigation view
 In the submenu 61
 In the wizard 61
 Numeric editor 63

O

Onsite display
 see Diagnostic message
 see In alarm condition
 Operable flow range 157
 Operating elements 64, 132
 Operating keys
 see Operating elements
 Operating menu
 Menus, submenus 57
 Structure 57
 Submenus and user roles 58
 Operating philosophy 58
 Operation 120
 Operation options 56
 Operational display 59
 Operational safety 11
 Order code 16, 17
 Orientation (vertical, horizontal) 22
 Outlet runs 23
 Output 157
 Output signal 157

P

Packaging disposal 20
 Parameter
 Changing 69
 Entering a value 69
 Parameter settings
 Administration (Submenu) 114
 Burst configuration 1 to n (Submenu) 85
 Current output 1 (Wizard) 92
 Data logging (Submenu) 125
 Define access code (Wizard) 113
 Device information (Submenu) 144
 Diagnostics (Menu) 140
 Display (Submenu) 108
 Display (Wizard) 99
 Electrode cleaning circuit (Submenu) 111
 Empty pipe detection (Wizard) 104
 For the status input 90
 Input values (Submenu) 122
 Low flow cut off (Wizard) 102
 Output conditioning (Wizard) 100
 Output values (Submenu) 123
 Process variables (Submenu) 121
 Pulse/frequency/switch output 1 to n (Wizard)
 93, 94, 97
 Reset access code (Submenu) 114
 Sensor adjustment (Submenu) 106
 Setup (Menu) 88
 Simulation (Submenu) 114
 Status input (Submenu) 90
 System units (Submenu) 89

- Totalizer (Submenu) 122
- Totalizer 1 to n (Submenu) 106
- Totalizer handling (Submenu) 124
- Web server (Submenu) 77
- WLAN Settings (Submenu) 111
- Partially filled pipe 22
- Performance characteristics 161
- Post-connection check (checklist) 54
- Post-installation check 87
- Post-installation check (checklist) 40
- Potential equalization 49
- Power consumption 160
- Power supply failure 161
- Pressure loss 166
- Pressure tightness 165
- Pressure-temperature ratings 165
- Process conditions
 - Conductivity 165
 - Flow limit 166
 - Medium temperature 165
 - Pressure loss 166
 - Pressure tightness 165
- Process connections 190
- Product safety 11
- Protecting parameter settings 117
- R**
- Radio approval 195
- Read access 70
- Reading measured values 120
- Recalibration 147
- Reference operating conditions 161
- Registered trademarks 9
- Remedial measures
 - Calling up 133
 - Closing 133
- Remote operation 192
- Remote version
 - Connecting the signal cables 46
- Repair of a device 148
- Repairs 148
 - Notes 148
- Repeatability 163
- Replacement
 - Device components 148
- Replacing seals 147
- Requirements for personnel 10
- Return 148
- S**
- Safety 10
- Screw tightening torques 29
- Sensor
 - Mounting 28
- Serial number 16, 17
- Setting the operating language 87
- Settings
 - Adapting the measuring device to the process conditions 123
 - Administration 112
 - Advanced display configurations 108
 - Current output 92
 - Device reset 144
 - Device tag 88
 - Electrode cleaning circuit (ECC) 111
 - Empty pipe detection (EPD) 104
 - Low flow cut off 102
 - Onsite display 99
 - Operating language 87
 - Output conditioning 100
 - Pulse output 93
 - Pulse/frequency/switch output 93, 94
 - Resetting the totalizer 124
 - Sensor adjustment 106
 - Simulation 114
 - Status input 90
 - Switch output 97
 - System units 89
 - Totalizer 106
 - Totalizer reset 124
 - WLAN 111
- Shock resistance 164
- Showing data logging 125
- Signal on alarm 158
- SIMATIC PDM 82
 - Function 82
- Software release 83
- Spare part 148
- Spare parts 148
- Special connection instructions 52
- Standards and guidelines 195
- Status area
 - For operational display 59
 - In the navigation view 61
- Status signals 131, 134
- Storage conditions 19
- Storage temperature 19
- Storage temperature range 164
- Structure
 - Operating menu 57
- Submenu
 - Administration 112, 114
 - Advanced setup 105
 - Burst configuration 1 to n 85
 - Data logging 125
 - Device information 144
 - Display 108
 - Electrode cleaning circuit 111
 - Event list 141
 - Input values 122
 - Output values 120, 123
 - Overview 58
 - Process variables 121
 - Reset access code 114
 - Sensor adjustment 106
 - Simulation 114
 - Status input 90
 - System units 89

Totalizer 122
 Totalizer 1 to n 106
 Totalizer handling 124
 Web server 77
 WLAN Settings 111
 Supplementary documentation 197
 Supply unit
 Requirements 44
 Supply voltage 44, 160
 Surface roughness 191
 Symbols
 For communication 59
 For correction 63
 For diagnostic behavior 59
 For locking 59
 For measured variable 60
 For measurement channel number 60
 For menus 62
 For parameters 62
 For status signal 59
 For submenu 62
 For wizard 62
 In the status area of the local display 59
 In the text and numeric editor 63
 System design
 Measuring system 153
 see Measuring device design
 System integration 83
 System pressure 24
T
 Technical data, overview 153
 Temperature range
 Ambient temperature range for display 191
 Storage temperature 19
 Terminal assignment 43, 46, 48
 terminals 161
 Text editor 63
 Tool tip
 see Help text
 Tools
 Electrical connection 43
 For mounting 27
 Transport 19
 Totalizer
 Configuration 106
 Transmitter
 Connecting the signal cables 48
 Turning the display module 39
 Turning the housing 37
 Transporting the measuring device 19
 Troubleshooting
 General 128
 Turning the display module 39
 Turning the electronics housing
 see Turning the transmitter housing
 Turning the transmitter housing 37

U

Use of the measuring device
 Borderline cases 10
 Incorrect use 10
 see Designated use
 User interface
 Current diagnostic event 140
 Previous diagnostic event 140
 User roles 58

V

Version data for the device 83
 Vibration resistance 164
 Vibrations 25

W

W@M 147, 148
 W@M Device Viewer 15, 148
 Weight
 Compact version 167
 Sensor remote version 178
 Transport (notes) 19
 Wizard
 Current output 1 92
 Define access code 113
 Display 99
 Empty pipe detection 104
 Low flow cut off 102
 Output conditioning 100
 Pulse/frequency/switch output 1 to n 93, 94, 97
 WLAN settings 111
 Workplace safety 11
 Write access 70
 Write protection
 Via access code 117
 Via write protection switch 118
 Write protection switch 118

www.addresses.endress.com
