

# Operating Instructions

## Proline Promag D 400

### HART

Electromagnetic flowmeter

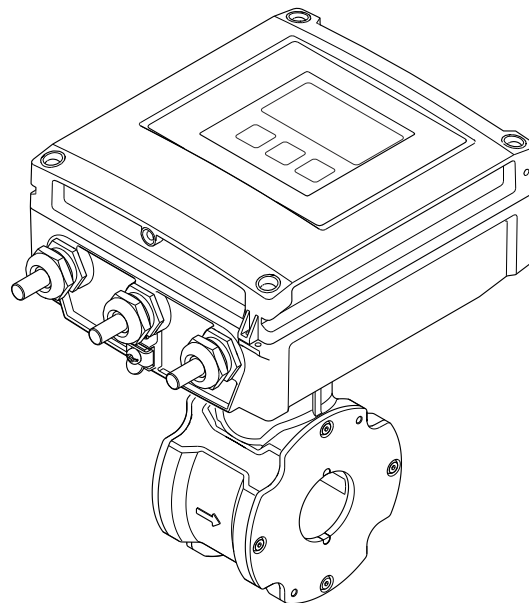

- Make sure the document is stored in a safe place such that it is always available when working on or with the device.
- To avoid danger to individuals or the facility, read the "Basic safety instructions" section carefully, as well as all other safety instructions in the document that are specific to working procedures.
- The manufacturer reserves the right to modify technical data without prior notice. Your Endress+Hauser Sales Center will supply you with current information and updates to these instructions.

## Table of contents

<b>1</b>	<b>Document information</b>	<b>6</b>	<b>6</b>	<b>6</b>	<b>Installation</b>	<b>19</b>
1.1	Document function	6	6.1	19	Installation conditions	19
1.2	Symbols used	6	6.1.1	19	Mounting position	19
1.2.1	Safety symbols	6	6.1.2	21	Requirements from environment and process	21
1.2.2	Electrical symbols	6	6.1.3	23	Special mounting instructions	23
1.2.3	Tool symbols	7	6.2	23	Mounting the measuring device	23
1.2.4	Symbols for certain types of information	7	6.2.1	23	Required tools	23
1.2.5	Symbols in graphics	7	6.2.2	23	Preparing the measuring device	23
1.3	Documentation	8	6.2.3	24	Mounting the sensor	24
1.3.1	Standard documentation	8	6.2.4	27	Mounting the transmitter of the remote version	27
1.3.2	Supplementary device-dependent documentation	8	6.2.5	28	Turning the transmitter housing	28
1.4	Registered trademarks	8	6.2.6	31	Turning the display module	31
<b>2</b>	<b>Basic safety instructions</b>	<b>9</b>	6.3	32	Post-installation check	32
2.1	Requirements for the personnel	9	<b>7</b>	<b>33</b>	<b>Electrical connection</b>	<b>33</b>
2.2	Designated use	9	7.1	33	Connection conditions	33
2.3	Workplace safety	10	7.1.1	33	Requirements for connecting cable	33
2.4	Operational safety	10	7.1.2	34	Required tools	34
2.5	Product safety	10	7.1.3	35	Terminal assignment	35
2.6	IT security	11	7.1.4	36	Shielding and grounding	36
2.7	Device-specific IT security	11	7.1.5	36	Requirements for the supply unit	36
2.7.1	Protecting access via hardware write protection	11	7.1.6	36	Preparing the measuring device	36
2.7.2	Protecting access via a password	11	7.1.7	37	Preparing the connecting cable for the remote version	37
2.7.3	Access via fieldbus	12	7.2	38	Connecting the measuring device	38
2.7.4	Access via Web server	12	7.2.1	38	Connecting the remote version	38
<b>3</b>	<b>Product description</b>	<b>13</b>	7.2.2	40	Connecting the transmitter	40
3.1	Product design	13	7.2.3	41	Ensuring potential equalization	41
<b>4</b>	<b>Incoming acceptance and product identification</b>	<b>14</b>	7.3	43	Special connection instructions	43
4.1	Incoming acceptance	14	7.3.1	43	Connection examples	43
4.2	Product identification	14	7.4	45	Ensuring the degree of protection	45
4.2.1	Transmitter nameplate	15	7.4.1	45	Degree of protection IP66/67, Type 4X enclosure	45
4.2.2	Sensor nameplate	16	7.5	45	Post-connection check	45
4.2.3	Symbols on measuring device	16	<b>8</b>	<b>46</b>	<b>Operation options</b>	<b>46</b>
<b>5</b>	<b>Storage and transport</b>	<b>17</b>	8.1	46	Overview of operation options	46
5.1	Storage conditions	17	8.2	47	Structure and function of the operating menu	47
5.2	Transporting the product	17	8.2.1	47	Structure of the operating menu	47
5.2.1	Measuring devices without lifting lugs	17	8.2.2	48	Operating philosophy	48
5.2.2	Measuring devices with lifting lugs	18	8.3	49	Access to the operating menu via the local display	49
5.2.3	Transporting with a fork lift	18	8.3.1	49	Operational display	49
5.3	Packaging disposal	18	8.3.2	50	Navigation view	50
			8.3.3	52	Editing view	52
			8.3.4	54	Operating elements	54
			8.3.5	54	Opening the context menu	54
			8.3.6	56	Navigating and selecting from list	56
			8.3.7	56	Calling the parameter directly	56
			8.3.8	57	Calling up help text	57
			8.3.9	58	Changing the parameters	58

8.3.10	User roles and related access authorization .....	59	10.7	Protecting settings from unauthorized access .....	103
8.3.11	Disabling write protection via access code .....	59	10.7.1	Write protection via access code ...	103
8.3.12	Enabling and disabling the keypad lock .....	59	10.7.2	Write protection via write protection switch .....	104
8.4	Access to the operating menu via the Web browser .....	60	<b>11</b>	<b>Operation .....</b>	<b>106</b>
8.4.1	Function range .....	60	11.1	Reading the device locking status .....	106
8.4.2	Prerequisites .....	60	11.2	Adjusting the operating language .....	106
8.4.3	Establishing a connection .....	62	11.3	Configuring the display .....	106
8.4.4	Logging on .....	63	11.4	Reading measured values .....	106
8.4.5	User interface .....	64	11.4.1	Process variables .....	107
8.4.6	Disabling the Web server .....	65	11.4.2	"Totalizer" submenu .....	107
8.4.7	Logging out .....	65	11.4.3	Input values .....	108
8.5	Access to the operating menu via the operating tool .....	65	11.4.4	Output values .....	108
8.5.1	Connecting the operating tool .....	66	11.5	Adapting the measuring device to the process conditions .....	109
8.5.2	Field Xpert SFX350, SFX370 .....	67	11.6	Performing a totalizer reset .....	109
8.5.3	FieldCare .....	67	11.6.1	Function scope of the "Control Totalizer" parameter .....	110
8.5.4	DeviceCare .....	69	11.6.2	Function scope of the "Reset all totalizers" parameter .....	110
8.5.5	AMS Device Manager .....	69	11.7	Showing data logging .....	110
8.5.6	SIMATIC PDM .....	70	<b>12</b>	<b>Diagnostics and troubleshooting ..</b>	<b>113</b>
8.5.7	Field Communicator 475 .....	70	12.1	General troubleshooting .....	113
<b>9</b>	<b>System integration .....</b>	<b>71</b>	12.2	Diagnostic information via light emitting diodes .....	115
9.1	Overview of device description files .....	71	12.2.1	Transmitter .....	115
9.1.1	Current version data for the device ...	71	12.3	Diagnostic information on local display .....	116
9.1.2	Operating tools .....	71	12.3.1	Diagnostic message .....	116
9.2	Measured variables via HART protocol .....	71	12.3.2	Calling up remedial measures .....	118
9.3	Other settings .....	72	12.4	Diagnostic information in the Web browser ..	118
<b>10</b>	<b>Commissioning .....</b>	<b>75</b>	12.4.1	Diagnostic options .....	118
10.1	Function check .....	75	12.4.2	Calling up remedy information .....	119
10.2	Switching on the measuring device .....	75	12.5	Diagnostic information in DeviceCare or FieldCare .....	120
10.3	Setting the operating language .....	75	12.5.1	Diagnostic options .....	120
10.4	Configuring the measuring device .....	75	12.5.2	Calling up remedy information .....	121
10.4.1	Defining the tag name .....	76	12.6	Adapting the diagnostic information .....	121
10.4.2	Setting the system units .....	77	12.6.1	Adapting the diagnostic behavior ...	121
10.4.3	Configuring the status input .....	78	12.6.2	Adapting the status signal .....	121
10.4.4	Configuring the current output .....	80	12.7	Overview of diagnostic information .....	122
10.4.5	Configuring the pulse/frequency/switch output .....	81	12.8	Pending diagnostic events .....	125
10.4.6	Configuring the local display .....	86	12.9	Diagnostic list .....	126
10.4.7	Configuring the output conditioning .....	88	12.10	Event logbook .....	126
10.4.8	Configuring the low flow cut off .....	89	12.10.1	Event history .....	126
10.4.9	Configuring empty pipe detection ...	91	12.10.2	Filtering the event logbook .....	127
10.5	Advanced settings .....	92	12.10.3	Overview of information events .....	127
10.5.1	Carrying out a sensor adjustment ...	93	12.11	Resetting the measuring device .....	129
10.5.2	Configuring the totalizer .....	93	12.11.1	Function scope of the "Device reset" parameter .....	129
10.5.3	Carrying out additional display configurations .....	95	12.12	Device information .....	129
10.5.4	Performing electrode cleaning .....	97	12.13	Firmware history .....	131
10.5.5	WLAN configuration .....	98			
10.5.6	Using parameters for device administration .....	99			
10.6	Simulation .....	101			

---

<b>13</b>	<b>Maintenance</b> .....	<b>132</b>
13.1	Maintenance tasks .....	132
13.1.1	Exterior cleaning .....	132
13.1.2	Interior cleaning .....	132
13.1.3	Replacing seals .....	132
13.2	Measuring and test equipment .....	132
13.3	Endress+Hauser services .....	132
<b>14</b>	<b>Repairs</b> .....	<b>133</b>
14.1	General notes .....	133
14.1.1	Repair and conversion concept .....	133
14.1.2	Notes for repair and conversion .....	133
14.2	Spare parts .....	133
14.3	Endress+Hauser services .....	133
14.4	Return .....	133
14.5	Disposal .....	134
14.5.1	Removing the measuring device .....	134
14.5.2	Disposing of the measuring device .....	134
<b>15</b>	<b>Accessories</b> .....	<b>135</b>
15.1	Device-specific accessories .....	135
15.1.1	For the transmitter .....	135
15.1.2	For the sensor .....	135
15.2	Communication-specific accessories .....	135
15.3	Service-specific accessories .....	136
15.4	System components .....	137
<b>16</b>	<b>Technical data</b> .....	<b>138</b>
16.1	Application .....	138
16.2	Function and system design .....	138
16.3	Input .....	138
16.4	Output .....	140
16.5	Power supply .....	142
16.6	Performance characteristics .....	144
16.7	Installation .....	145
16.8	Environment .....	145
16.9	Process .....	146
16.10	Mechanical construction .....	147
16.11	Operability .....	152
16.12	Certificates and approvals .....	155
16.13	Application packages .....	156
16.14	Accessories .....	157
16.15	Supplementary documentation .....	157
<b>Index</b> .....	<b>159</b>	





# 1 Document information

## 1.1 Document function







These Operating Instructions contain all the information that is required in various phases of the life cycle of the device: from product identification, incoming acceptance and storage, to mounting, connection, operation and commissioning through to troubleshooting, maintenance and disposal.

## 1.2 Symbols used



### 1.2.1 Safety symbols

Symbol	Meaning
	<b>DANGER!</b> This symbol alerts you to a dangerous situation. Failure to avoid this situation will result in serious or fatal injury.
	<b>WARNING!</b> This symbol alerts you to a dangerous situation. Failure to avoid this situation can result in serious or fatal injury.
	<b>CAUTION!</b> This symbol alerts you to a dangerous situation. Failure to avoid this situation can result in minor or medium injury.
	<b>NOTE!</b> This symbol contains information on procedures and other facts which do not result in personal injury.













### 1.2.2 Electrical symbols

Symbol	Meaning
	Direct current
	Alternating current
	Direct current and alternating current
	<b>Ground connection</b> A grounded terminal which, as far as the operator is concerned, is grounded via a grounding system.
	<b>Protective ground connection</b> A terminal which must be connected to ground prior to establishing any other connections.
	<b>Equipotential connection</b> A connection that has to be connected to the plant grounding system: This may be a potential equalization line or a star grounding system depending on national or company codes of practice.



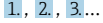

### 1.2.3 Tool symbols

Symbol	Meaning
	Torx screwdriver
	Phillips head screwdriver
	Open-ended wrench

### 1.2.4 Symbols for certain types of information

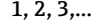
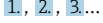
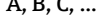
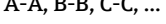
Symbol	Meaning
	<b>Permitted</b> Procedures, processes or actions that are permitted.
	<b>Preferred</b> Procedures, processes or actions that are preferred.
	<b>Forbidden</b> Procedures, processes or actions that are forbidden.
	<b>Tip</b> Indicates additional information.
	Reference to documentation
	Reference to page
	Reference to graphic
	Notice or individual step to be observed
	Series of steps
	Result of a step
	Help in the event of a problem
	Visual inspection



### 1.2.5 Symbols in graphics

Symbol	Meaning
	Item numbers
	Series of steps
	Views
	Sections
	Hazardous area
	Safe area (non-hazardous area)
	Flow direction

## 1.3 Documentation

 For an overview of the scope of the associated Technical Documentation, refer to the following:

- The *W@M Device Viewer* : Enter the serial number from the nameplate ([www.endress.com/deviceviewer](http://www.endress.com/deviceviewer))
- The *Endress+Hauser Operations App*: Enter the serial number from the nameplate or scan the 2-D matrix code (QR code) on the nameplate.

 For a detailed list of the individual documents along with the documentation code →  157

### 1.3.1 Standard documentation

Document type	Purpose and content of the document
Technical Information	<b>Planning aid for your device</b> The document contains all the technical data on the device and provides an overview of the accessories and other products that can be ordered for the device.
Sensor Brief Operating Instructions	<b>Guides you quickly to the 1st measured value - Part 1</b> The Sensor Brief Operating Instructions are aimed at specialists with responsibility for installing the measuring device. <ul style="list-style-type: none"> <li>▪ Incoming acceptance and product identification</li> <li>▪ Storage and transport</li> <li>▪ Installation</li> </ul>
Transmitter Brief Operating Instructions	<b>Guides you quickly to the 1st measured value - Part 2</b> The Transmitter Brief Operating Instructions are aimed at specialists with responsibility for commissioning, configuring and parameterizing the measuring device (until the first measured value). <ul style="list-style-type: none"> <li>▪ Product description</li> <li>▪ Installation</li> <li>▪ Electrical connection</li> <li>▪ Operation options</li> <li>▪ System integration</li> <li>▪ Commissioning</li> <li>▪ Diagnostic information</li> </ul>
Description of Device Parameters	<b>Reference for your parameters</b> The document provides a detailed explanation of each individual parameter in the Expert operating menu. The description is aimed at those who work with the device over the entire life cycle and perform specific configurations.

### 1.3.2 Supplementary device-dependent documentation

Additional documents are supplied depending on the device version ordered: Always comply strictly with the instructions in the supplementary documentation. The supplementary documentation is an integral part of the device documentation.

## 1.4 Registered trademarks

### HART®

Registered trademark of the FieldComm Group, Austin, Texas, USA

### Microsoft®

Registered trademark of the Microsoft Corporation, Redmond, Washington, USA

### Applicator®, FieldCare®, DeviceCare®, Field Xpert™, HistoROM®, Heartbeat Technology™

Registered or registration-pending trademarks of the Endress+Hauser Group



## 2 Basic safety instructions

### 2.1 Requirements for the personnel

The personnel for installation, commissioning, diagnostics and maintenance must fulfill the following requirements:

- ▶ Trained, qualified specialists must have a relevant qualification for this specific function and task.
- ▶ Are authorized by the plant owner/operator.
- ▶ Are familiar with federal/national regulations.
- ▶ Before starting work, read and understand the instructions in the manual and supplementary documentation as well as the certificates (depending on the application).
- ▶ Follow instructions and comply with basic conditions.

The operating personnel must fulfill the following requirements:

- ▶ Are instructed and authorized according to the requirements of the task by the facility's owner-operator.
- ▶ Follow the instructions in this manual.

### 2.2 Designated use

#### Application and media

The measuring device described in this manual is intended only for flow measurement of liquids with a minimum conductivity of 5  $\mu\text{S}/\text{cm}$ .

Depending on the version ordered, the measuring device can also measure potentially explosive, flammable, poisonous and oxidizing media.

Measuring devices for use in hazardous areas, in hygienic applications or where there is an increased risk due to process pressure, are labeled accordingly on the nameplate.

To ensure that the measuring device remains in proper condition for the operation time:

- ▶ Only use the measuring device in full compliance with the data on the nameplate and the general conditions listed in the Operating Instructions and supplementary documentation.
- ▶ Based on the nameplate, check whether the ordered device is permitted for the intended use in the hazardous area (e.g. explosion protection, pressure vessel safety).
- ▶ Use the measuring device only for media to which the process-wetted materials are sufficiently resistant.
- ▶ If the measuring device is not operated at atmospheric temperature, compliance with the relevant basic conditions specified in the associated device documentation is absolutely essential: "Documentation" section. →  8.
- ▶ Protect the measuring device permanently against corrosion from environmental influences.

#### Incorrect use

Non-designated use can compromise safety. The manufacturer is not liable for damage caused by improper or non-designated use.

#### **WARNING**

#### **Danger of breakage due to corrosive or abrasive fluids!**

- ▶ Verify the compatibility of the process fluid with the sensor material.
- ▶ Ensure the resistance of all fluid-wetted materials in the process.
- ▶ Keep within the specified pressure and temperature range.

**NOTICE****Verification for borderline cases:**

- ▶ For special fluids and fluids for cleaning, Endress+Hauser is glad to provide assistance in verifying the corrosion resistance of fluid-wetted materials, but does not accept any warranty or liability as minute changes in the temperature, concentration or level of contamination in the process can alter the corrosion resistance properties.

**Residual risks****⚠ WARNING**

**The electronics and the medium may cause the surfaces to heat up. This presents a burn hazard!**

- ▶ For elevated fluid temperatures, ensure protection against contact to prevent burns.

## 2.3 Workplace safety

For work on and with the device:

- ▶ Wear the required personal protective equipment according to federal/national regulations.

For welding work on the piping:

- ▶ Do not ground the welding unit via the measuring device.

If working on and with the device with wet hands:

- ▶ Due to the increased risk of electric shock, gloves must be worn.

## 2.4 Operational safety

Risk of injury.

- ▶ Operate the device in proper technical condition and fail-safe condition only.
- ▶ The operator is responsible for interference-free operation of the device.

**Conversions to the device**

Unauthorized modifications to the device are not permitted and can lead to unforeseeable dangers.

- ▶ If, despite this, modifications are required, consult with Endress+Hauser.

**Repair**

To ensure continued operational safety and reliability,

- ▶ Carry out repairs on the device only if they are expressly permitted.
- ▶ Observe federal/national regulations pertaining to repair of an electrical device.
- ▶ Use original spare parts and accessories from Endress+Hauser only.

## 2.5 Product safety

This measuring device is designed in accordance with good engineering practice to meet state-of-the-art safety requirements, has been tested, and left the factory in a condition in which it is safe to operate.

It meets general safety standards and legal requirements. It also complies with the EU directives listed in the device-specific EU Declaration of Conformity. Endress+Hauser confirms this by affixing the CE mark to the device.

## 2.6 IT security

We only provide a warranty if the device is installed and used as described in the Operating Instructions. The device is equipped with security mechanisms to protect it against any inadvertent changes to the device settings.

IT security measures in line with operators' security standards and designed to provide additional protection for the device and device data transfer must be implemented by the operators themselves.

## 2.7 Device-specific IT security

The device offers a range of specific functions to support protective measures on the operator's side. These functions can be configured by the user and guarantee greater in-operation safety if used correctly. An overview of the most important functions is provided in the following section.

### 2.7.1 Protecting access via hardware write protection

Write access to the device parameters via the local display, Web browser or operating tool (e.g. FieldCare, DeviceCare) can be disabled via a write protection switch (DIP switch on the motherboard). When hardware write protection is enabled, only read access to the parameters is possible.

### 2.7.2 Protecting access via a password

Different passwords are available to protect write access to the device parameters or access to the device via the WLAN interface.

- **User-specific access code**  
Protect write access to the device parameters via the local display, Web browser or operating tool (e.g. FieldCare, DeviceCare). Is equivalent to hardware write protection in terms of functionality.
- **WLAN passphrase**  
The network key protects a connection between an operating unit (e.g. notebook or tablet) and the device via the WLAN interface which can be ordered as an option.

#### **User-specific access code**

Write access to the device parameters via the local display, Web browser or operating tool (e.g. FieldCare, DeviceCare) can be protected by the modifiable, user-specific access code (→  103).

When the device is delivered, the device does not have an access code and is equivalent to 0000 (open).

#### **WLAN passphrase**

A connection between an operating unit (e.g. notebook or tablet) and the device via the WLAN interface (→  66) which can be ordered as an option is protected by the network key. The WLAN authentication of the network key complies with the IEEE 802.11 standard.

When the device is delivered, the network key is pre-defined depending on the device. It can be changed via the **WLAN settings** submenu in the **WLAN passphrase** parameter (→  99).

### General notes on the use of passwords

- The access code and network key supplied with the device should be changed during commissioning.
- Follow the general rules for generating a secure password when defining and managing the access code or network key.
- The user is responsible for the management and careful handling of the access code and network key.

### 2.7.3 Access via fieldbus

When communicating via fieldbus, access to the device parameters can be restricted to "Read only" access. The option can be changed in the **Fieldbus writing access** parameter.

This does not affect cyclic measured value transmission to the higher-order system, which is always guaranteed.



For detailed information, see the "Description of Device Parameters" document pertaining to the device →  157

### 2.7.4 Access via Web server

The device can be operated and configured via a Web browser with the integrated Web server (). The connection is via the service interface (CDI-RJ45) or the WLAN interface.

The Web server is enabled when the device is delivered. The Web server can be disabled if necessary (e.g. after commissioning) via the **Web server functionality** parameter.

The device and status information can be hidden on the login page. This prevents unauthorized access to the information.



For detailed information, see the "Description of Device Parameters" document pertaining to the device →  157

### 3 Product description

The device consists of a transmitter and a sensor.

Two device versions are available:

- Compact version – transmitter and sensor form a mechanical unit.
- Remote version - transmitter and sensor are mounted in separate locations.

#### 3.1 Product design

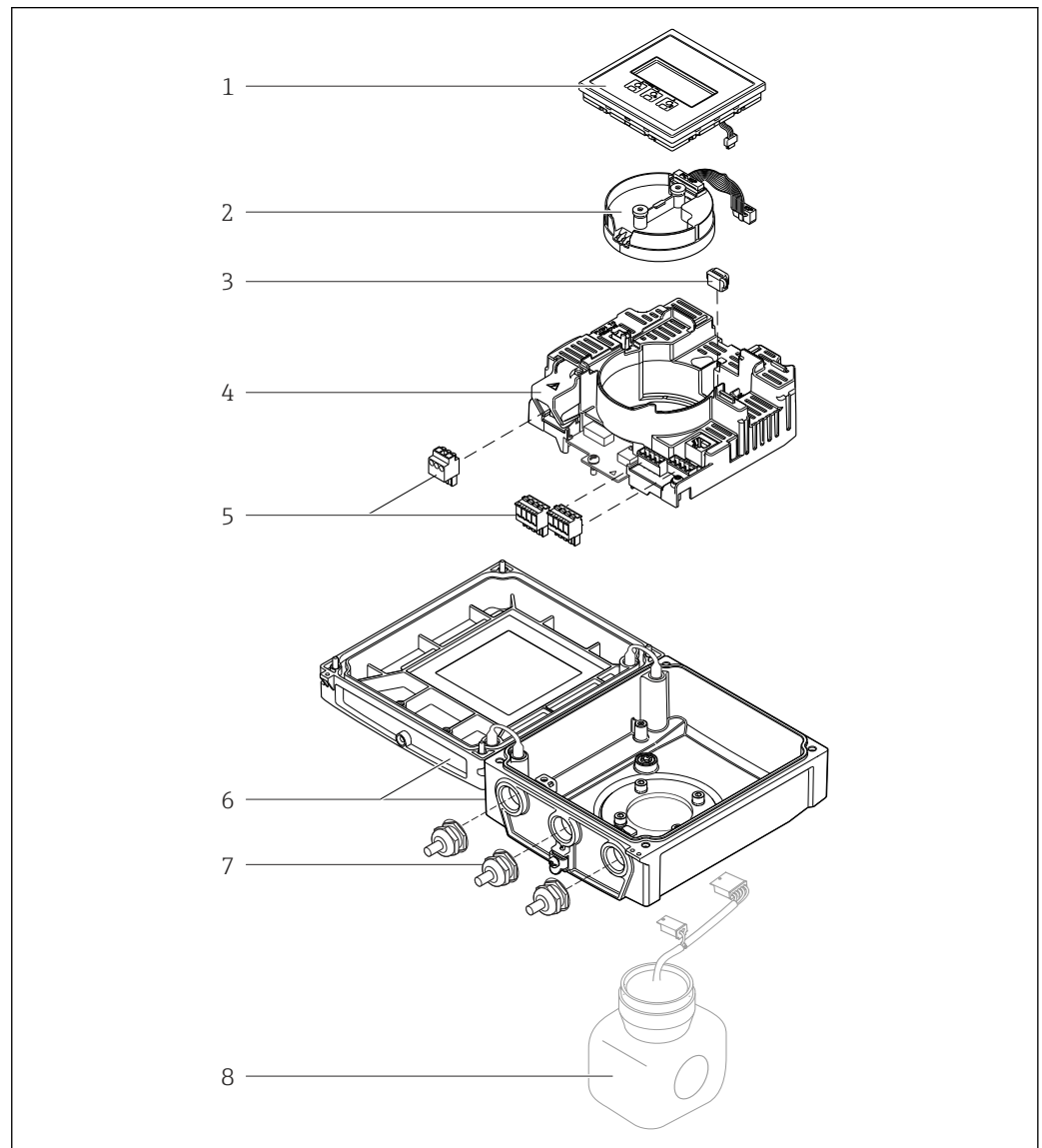

A0021563

#### 1 Important components of the compact version

- 1 Display module
- 2 Smart sensor electronics module
- 3 HistoROM DAT (plug-in memory)
- 4 Main electronics module
- 5 Terminals (screw terminals, some available as plug-in terminals) or fieldbus connectors
- 6 Transmitter housing, compact version
- 7 Cable glands
- 8 Sensor, compact version

## 4 Incoming acceptance and product identification

### 4.1 Incoming acceptance



A0028673

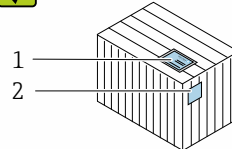
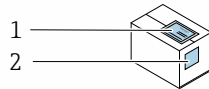

Are the order codes on the delivery note (1) and the product sticker (2) identical?

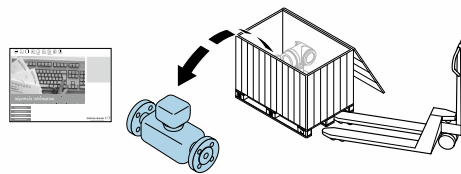

A0028673

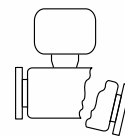
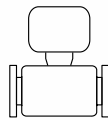

Are the goods undamaged?



A0028673

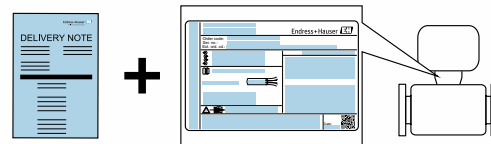



Do the nameplate data match the ordering information on the delivery note?

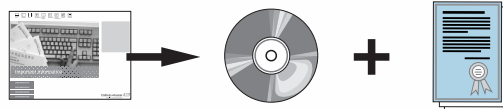

A0028673



Is the CD-ROM with the Technical Documentation (depends on device version) and documents present?



-  If one of the conditions is not satisfied, contact your Endress+Hauser Sales Center.
- Depending on the device version, the CD-ROM might not be part of the delivery! The Technical Documentation is available via the Internet or via the *Endress+Hauser Operations App*, see the "Product identification" section →  15.

### 4.2 Product identification

The following options are available for identification of the measuring device:

- Nameplate specifications
- Order code with breakdown of the device features on the delivery note
- Enter serial numbers from nameplates in *W@M Device Viewer* ([www.endress.com/deviceviewer](http://www.endress.com/deviceviewer)): All information about the measuring device is displayed.
- Enter the serial number from the nameplates into the *Endress+Hauser Operations App* or scan the 2-D matrix code (QR code) on the nameplate with the *Endress+Hauser Operations App*: all the information for the measuring device is displayed.

For an overview of the scope of the associated Technical Documentation, refer to the following:

- The chapters "Additional standard documentation on the device" →  8 and "Supplementary device-dependent documentation" →  8
- The *W@M Device Viewer*: Enter the serial number from the nameplate ([www.endress.com/deviceviewer](http://www.endress.com/deviceviewer))
- The *Endress+Hauser Operations App*: Enter the serial number from the nameplate or scan the 2-D matrix code (QR code) on the nameplate.

### 4.2.1 Transmitter nameplate

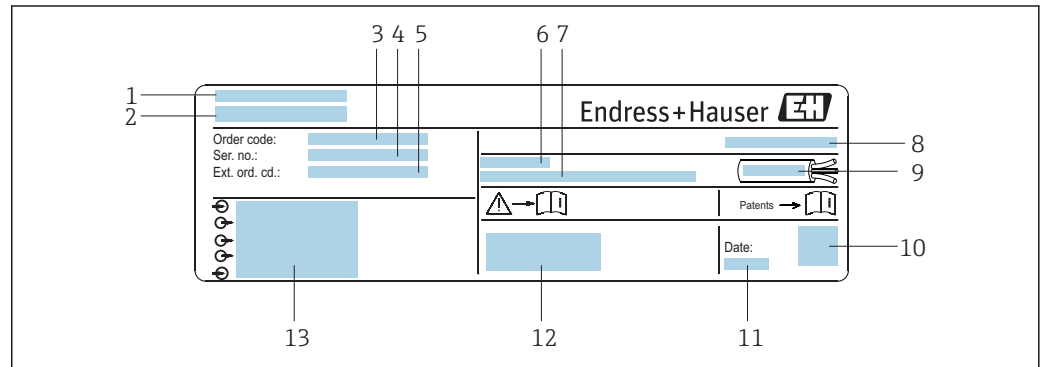

A0017346

 2 Example of a transmitter nameplate

- 1 Manufacturing location
- 2 Name of the transmitter
- 3 Order code
- 4 Serial number (ser. no.)
- 5 Extended order code (Ext. ord. cd.)
- 6 Permitted ambient temperature ( $T_a$ )
- 7 Firmware version (FW) and device revision (Dev.Rev.) from the factory
- 8 Degree of protection
- 9 Permitted temperature range for cable
- 10 2-D matrix code
- 11 Manufacturing date: year-month
- 12 CE mark, C-Tick
- 13 Electrical connection data, e.g. available inputs and outputs, supply voltage

### 4.2.2 Sensor nameplate

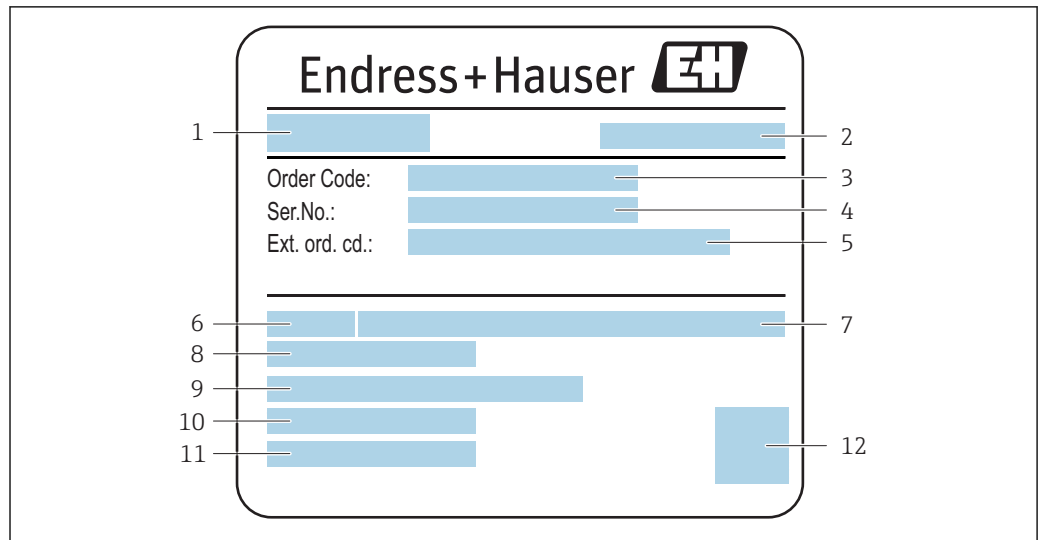

A0017224

3 Example of sensor nameplate

- 1 Name of the sensor
- 2 Manufacturing location
- 3 Order code
- 4 Serial number (ser. no.)
- 5 Extended order code (Ext. ord. cd.)
- 6 Nominal diameter of sensor
- 7 Nominal pressure
- 8 Medium temperature range
- 9 Material of lining and electrodes
- 10 Permitted ambient temperature range
- 11 Degree of protection
- 12 2-D matrix code

#### **i** Order code

The measuring device is reordered using the order code.

##### Extended order code

- The device type (product root) and basic specifications (mandatory features) are always listed.
- Of the optional specifications (optional features), only the safety and approval-related specifications are listed (e.g. LA). If other optional specifications are also ordered, these are indicated collectively using the # placeholder symbol (e.g. #LA#).
- If the ordered optional specifications do not include any safety and approval-related specifications, they are indicated by the + placeholder symbol (e.g. XXXXXX-ABCDE+).

### 4.2.3 Symbols on measuring device

Symbol	Meaning
	<b>WARNING!</b> This symbol alerts you to a dangerous situation. Failure to avoid this situation can result in serious or fatal injury.
	<b>Reference to documentation</b> Refers to the corresponding device documentation.
	<b>Protective ground connection</b> A terminal which must be connected to ground prior to establishing any other connections.



## 5 Storage and transport

### 5.1 Storage conditions

Observe the following notes for storage:

- Store in the original packaging to ensure protection from shock.
- Do not remove protective covers or protective caps installed on process connections. They prevent mechanical damage to the sealing surfaces and contamination in the measuring tube.
- Protect from direct sunlight to avoid unacceptably high surface temperatures.
- Select a storage location where moisture cannot collect in the measuring device as fungus and bacteria infestation can damage the lining.
- Store in a dry and dust-free place.
- Do not store outdoors.

Storage temperature →  145

### 5.2 Transporting the product

Transport the measuring device to the measuring point in the original packaging.

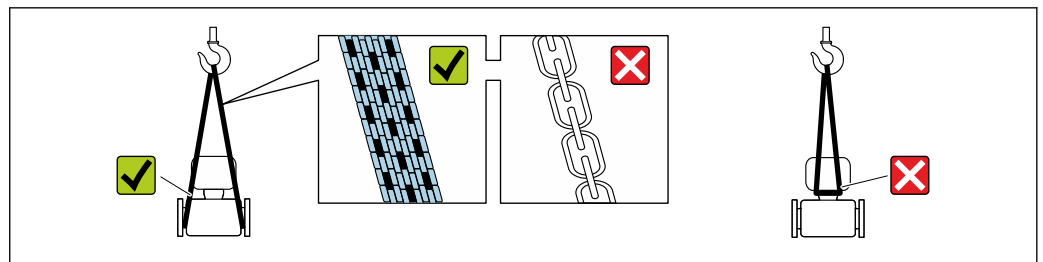

A0029252

-  Do not remove protective covers or caps installed on process connections. They prevent mechanical damage to the sealing surfaces and contamination in the measuring tube.

#### 5.2.1 Measuring devices without lifting lugs

##### WARNING

**Center of gravity of the measuring device is higher than the suspension points of the webbing slings.**

Risk of injury if the measuring device slips.

- ▶ Secure the measuring device against slipping or turning.
- ▶ Observe the weight specified on the packaging (stick-on label).

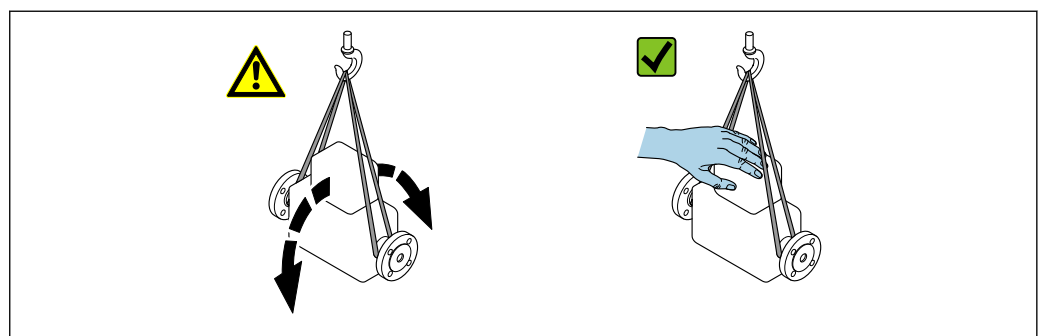

A0029214

## 5.2.2 Measuring devices with lifting lugs

### ⚠ CAUTION

#### Special transportation instructions for devices with lifting lugs

- ▶ Only use the lifting lugs fitted on the device or flanges to transport the device.
- ▶ The device must always be secured at two lifting lugs at least.

## 5.2.3 Transporting with a fork lift

If transporting in wood crates, the floor structure enables the crates to be lifted lengthwise or at both sides using a forklift.

### ⚠ CAUTION

#### Risk of damaging the magnetic coil

- ▶ If transporting by forklift, do not lift the sensor by the metal casing.
- ▶ This would buckle the casing and damage the internal magnetic coils.

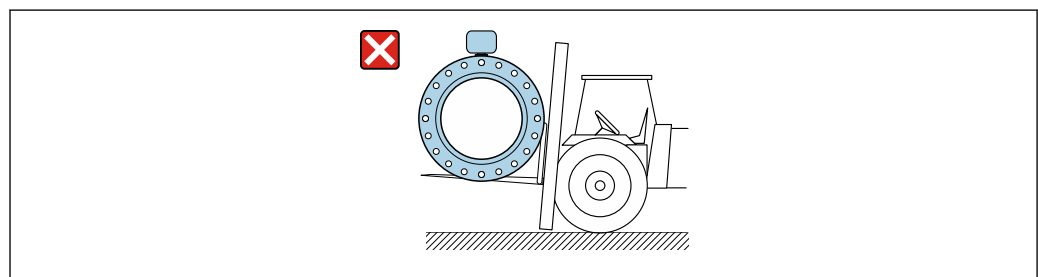

A0029319

## 5.3 Packaging disposal

All packaging materials are environmentally friendly and 100% recyclable:

- Measuring device secondary packaging: polymer stretch film that conforms to EC Directive 2002/95/EC (RoHS).
- Packaging:
  - Wood crate, treated in accordance with ISPM 15 standard, which is confirmed by the affixed IPPC logo.
  - or
  - Carton in accordance with European Packaging Directive 94/62EC; recyclability is confirmed by the affixed RESY symbol.
- Seaworthy packaging (optional): Wood crate, treated in accordance with ISPM 15 standard, which is confirmed by the affixed IPPC logo.
- Carrying and mounting hardware:
  - Disposable plastic pallet
  - Plastic straps
  - Plastic adhesive strips
- Dunnage: Paper cushion

## 6 Installation

### 6.1 Installation conditions

#### 6.1.1 Mounting position

##### Mounting location

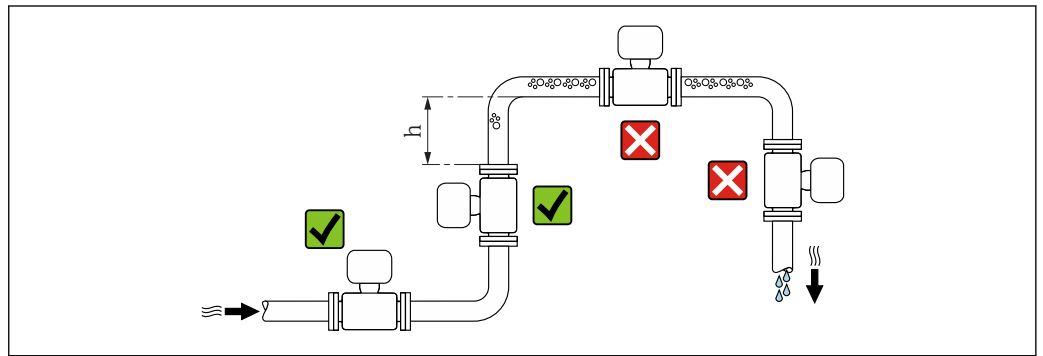

A0029343

Preferably install the sensor in an ascending pipe, and ensure a sufficient distance to the next pipe elbow:  $h \geq 2 \times DN$

To prevent measuring errors arising from accumulation of gas bubbles in the measuring tube, avoid the following mounting locations in the pipe:

- Highest point of a pipeline.
- Directly upstream of a free pipe outlet in a down pipe.

##### Installation in down pipes

Install a siphon with a vent valve downstream of the sensor in down pipes whose length  $h \geq 5 \text{ m}$  (16.4 ft). This precaution is to avoid low pressure and the consequent risk of damage to the measuring tube. This measure also prevents the system losing prime.

 For information on the liner's resistance to partial vacuum

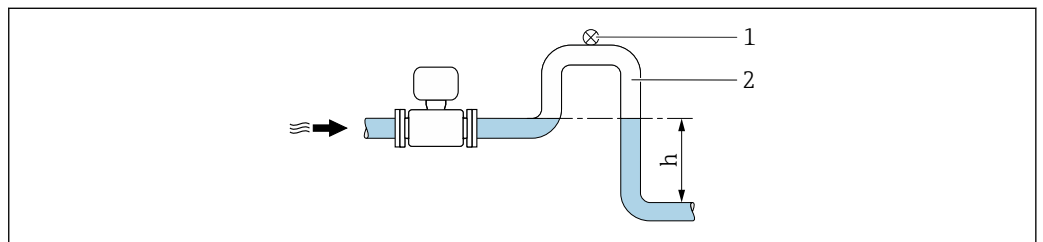

A0028981

##### 4 Installation in a down pipe

- 1 Vent valve
- 2 Pipe siphon
- h Length of down pipe

##### Installation in partially filled pipes

A partially filled pipe with a gradient necessitates a drain-type configuration. The empty pipe detection (EPD) function offers additional protection by detecting empty or partially filled pipes.

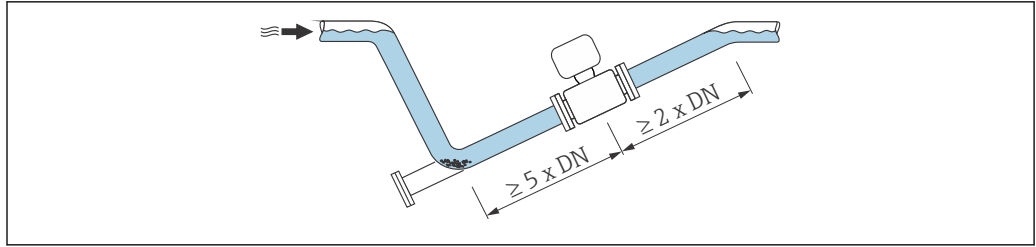

A0029257

**Orientation**

The direction of the arrow on the sensor nameplate helps you to install the sensor according to the flow direction (direction of medium flow through the piping).

An optimum orientation position helps avoid gas and air accumulations and deposits in the measuring tube.

*Vertical*

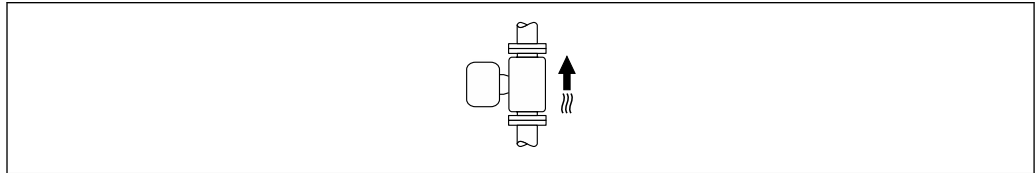

A0015591

Optimum for self-emptying pipe systems.

*Horizontal*

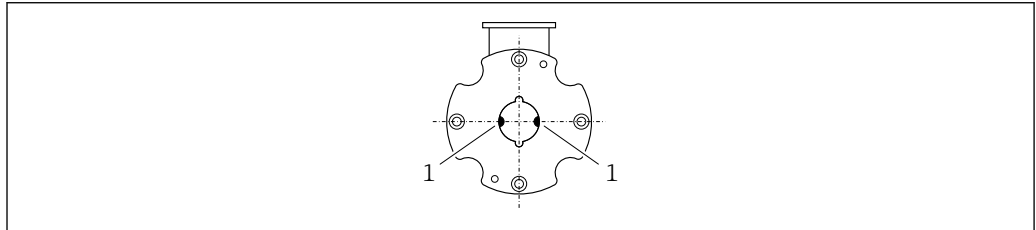

A0017195

1 Measuring electrodes for signal detection

**i** Ideally, the measuring electrode plane should be horizontal. This prevents brief insulation of the two measuring electrodes by entrained air bubbles.

**Inlet and outlet runs**

If possible, install the sensor upstream from fittings such as valves, T-pieces or elbows.

Observe the following inlet and outlet runs to comply with accuracy specifications:

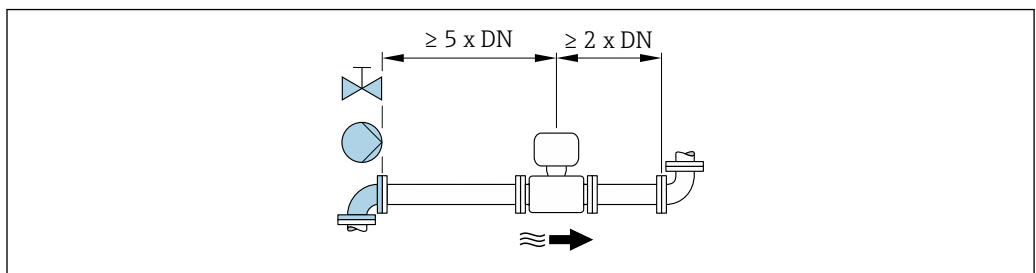

A0028997

*Installation dimensions*

For the dimensions and installation lengths of the device, see the "Technical Information" document, "Mechanical construction" section.

**6.1.2 Requirements from environment and process****Ambient temperature range**

Transmitter	-40 to +60 °C (-40 to +140 °F)
Local display	-20 to +60 °C (-4 to +140 °F), the readability of the display may be impaired at temperatures outside the temperature range.
Sensor	-20 to +60 °C (-4 to +140 °F)
Liner	Do not exceed or fall below the permitted temperature range of the liner .

If operating outdoors:

- Install the measuring device in a shady location.
- Avoid direct sunlight, particularly in warm climatic regions.
- Avoid direct exposure to weather conditions.
- If the compact version of the device is insulated at low temperatures, the insulation must also include the device neck.
- Protect the display against impact.
- Protect the display from abrasion by sand in desert areas.



You can order a display guard from Endress+Hauser : → 135

*Temperature tables*

Observe the interdependencies between the permitted ambient and fluid temperatures when operating the device in hazardous areas.

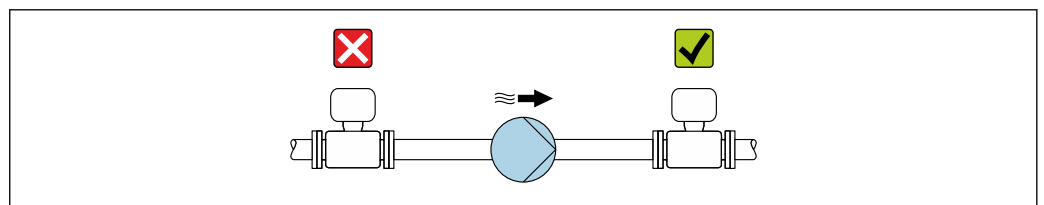

For detailed information on the temperature tables, see the separate document entitled "Safety Instructions" (XA) for the device.

**System pressure**

A0028777

Never install the sensor on the pump suction side in order to avoid the risk of low pressure, and thus damage to the liner.



Furthermore, install pulse dampers if reciprocating, diaphragm or peristaltic pumps are used.



- For information on the liner's resistance to partial vacuum → 146
- For information on the shock resistance of the measuring system
- For information on the vibration resistance of the measuring system

**Vibrations**

In the event of very strong vibrations, the pipe and sensor must be supported and fixed.

It is also advisable to mount the sensor and transmitter separately.

- i** For information on the shock resistance of the measuring system
- For information on the vibration resistance of the measuring system

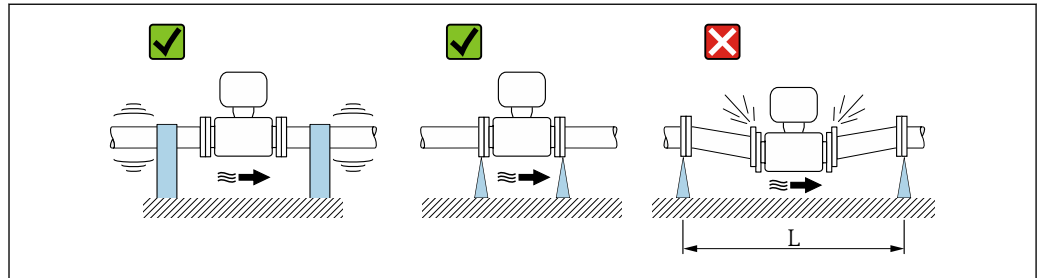

5 Measures to avoid device vibrations ( $L > 10\text{ m (33 ft)}$ )

### Adapters

Suitable adapters to DIN EN 545 (double-flange reducers) can be used to install the sensor in larger-diameter pipes. The resultant increase in the rate of flow improves measuring accuracy with very slow-moving fluids. The nomogram shown here can be used to calculate the pressure loss caused by reducers and expanders.

**i** The nomogram only applies to liquids with a viscosity similar to that of water.

1. Calculate the ratio of the diameters  $d/D$ .
2. From the nomogram read off the pressure loss as a function of flow velocity (downstream from the reduction) and the  $d/D$  ratio.

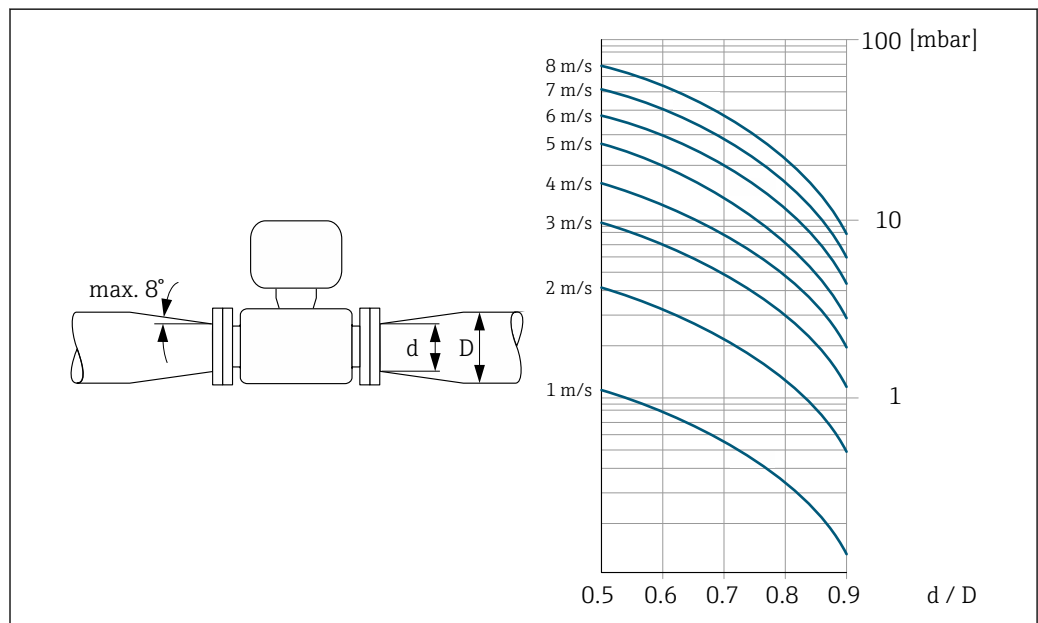

### Length of connecting cable

To ensure correct measuring results when using the remote version, observe the maximum permitted length of the connecting cable  $L_{max}$ . This length is determined by the conductivity of the fluid.

If measuring liquids in general:  $5\ \mu\text{S/cm}$

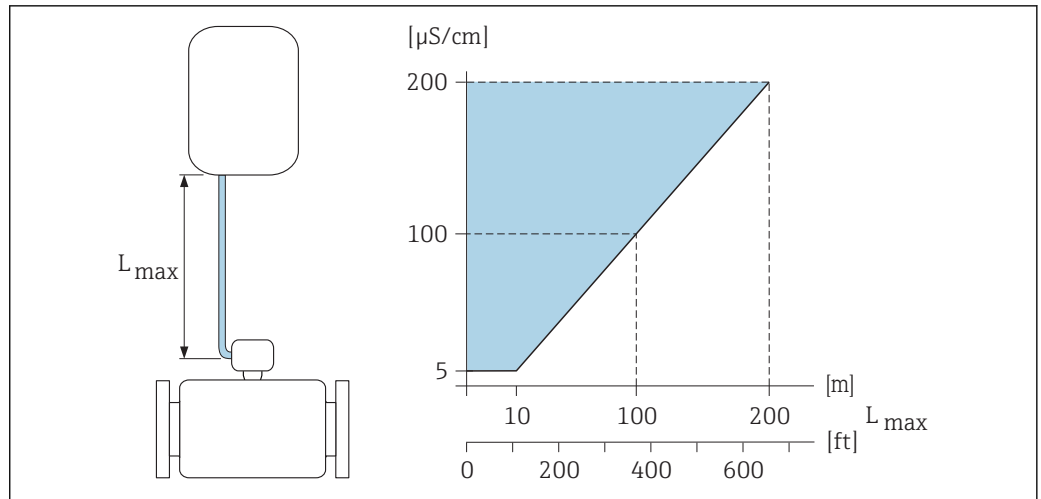

6 Permitted length of connecting cable for remote version

Colored area = permitted range

$L_{max}$  = length of connecting cable in [m] ([ft])

[ $\mu\text{S}/\text{cm}$ ] = fluid conductivity

A0016539

### 6.1.3 Special mounting instructions

#### Display protection

- To ensure that the optional display protection can be easily opened, maintain the following minimum head clearance: 350 mm (13.8 in)

## 6.2 Mounting the measuring device

### 6.2.1 Required tools

#### For transmitter

- Torque wrench
- For wall mounting:
  - Open-ended wrench for hexagonal screw max. M5
- For pipe mounting:
  - Open-ended wrench AF 8
  - Phillips head screwdriver PH 2
- For turning the transmitter housing (compact version):
  - Phillips head screwdriver PH 2
  - Torx screwdriver TX 20
  - Open-ended wrench AF 7

#### For sensor

For flanges and other process connections: Corresponding mounting tools

### 6.2.2 Preparing the measuring device

1. Remove all remaining transport packaging.
2. Remove any protective covers or protective caps present from the sensor.
3. Remove stick-on label on the electronics compartment cover.

### 6.2.3 Mounting the sensor

#### Mounting kit

The sensor is installed between the pipe flanges using a mounting kit. The device is centered using the recesses on the sensor. Centering sleeves are also provided depending on the flange standard or the diameter of the pitch circle.

**i** A mounting kit – consisting of mounting bolts, seals, nuts and washers – can be ordered separately (see "Accessories" section → 135).

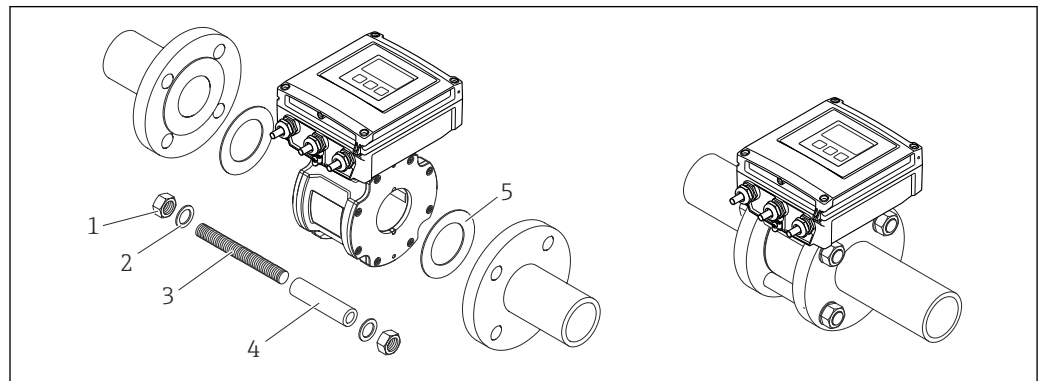

A0018060

**7** Mounting the sensor

- 1 Nut
- 2 Washer
- 3 Mounting bolts
- 4 Centering sleeve
- 5 Seal

#### Arranging the mounting bolts and centering sleeves

The device is centered using recesses on the sensor. The arrangement of the mounting bolts and the use of the centering sleeves supplied depend on the nominal diameter, the flange standard and the diameter of the pitch circle.

Nominal diameter		Process connection		
[mm]	[in]5	EN 1092-1 (DIN 2501)	ASME B16.5	JIS B2220
25...40	1...1 ½	<p>A0029490</p>	<p>A0029491</p>	<p>A0029490</p>
50	2	<p>A0029492</p>	<p>A0029493</p>	<p>A0029493</p>
65	2 ½	<p>A0029494</p>	—	<p>A0029495</p>

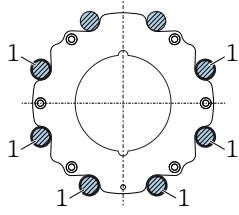
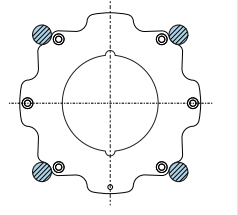
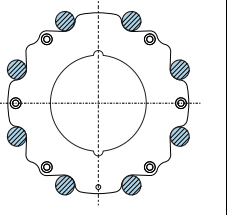
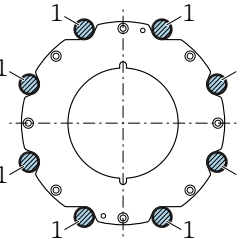
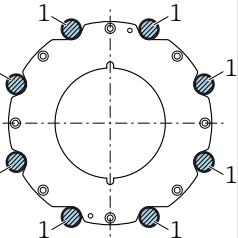
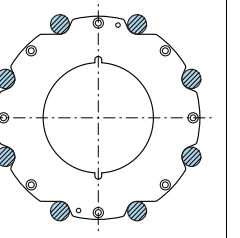

Nominal diameter		Process connection		
[mm]	[in]5	EN 1092-1 (DIN 2501)	ASME B16.5	JIS B2220
80	3	 A0029496	 A0029497	 A0029498
100	4	 A0029499	 A0029499	 A0029500
<p>1 = Mounting bolts with centering sleeves  2 = EN (DIN) flange: 4-hole → with centering sleeves  3 = EN (DIN) flange: 8-hole → without centering sleeves</p>				

### Mounting the seals

#### **CAUTION**

**An electrically conductive layer could form on the inside of the measuring tube!**

Risk of measuring signal short circuit.

- ▶ Do not use electrically conductive sealing compounds such as graphite.

Comply with the following instructions when installing seals:

1. Make sure that the seals do not protrude into the piping cross-section.
2. For DIN flanges: only use seals according to DIN EN 1514-1.
3. Use seals with a hardness rating of 70° Shore.

### Mounting the ground cable/ground disks

Comply with the information on potential equalization and detailed mounting instructions for the use of ground cables/ground disks →  41.

### Screw tightening torques

Please note the following:

- The screw tightening torques listed below apply only to lubricated threads and to pipes not subjected to tensile stress.
- Tighten the screws uniformly and in diagonally opposite sequence.
- Overtightening the screws will deform the sealing faces or damage the seals.

The tightening torques apply to situations where an EPDM soft material flat seal (e.g. 70° Shore) is used.

*Screw tightening torques, mounting bolts and centering sleeves for EN 1092-1 (DIN 2501), PN 16*

Nominal diameter [mm]	Mounting bolts [mm]	Length Centering sleeve [mm]	Max. screw tightening torque [Nm] for a process flange with ...	
			smooth seal face	Raised face
25	4 × M12 × 145	54	19	19
40	4 × M16 × 170	68	33	33
50	4 × M16 × 185	82	41	41
65 <sup>1)</sup>	4 × M16 × 200	92	44	44
65 <sup>2)</sup>	8 × M16 × 200	– <sup>3)</sup>	29	29
80	8 × M16 × 225	116	36	36
100	8 × M16 × 260	147	40	40

- 1) EN (DIN) flange: 4-hole → with centering sleeves
- 2) EN (DIN) flange: 8-hole → without centering sleeves
- 3) A centering sleeve is not required. The device is centered directly via the sensor housing.

*Screw tightening torques, mounting bolts and centering sleeves for ASME B16.5, Class 150*

Nominal diameter		Mounting bolts [in]	Length Centering sleeve [in]	Max. screw tightening torque [Nm] ([lbf · ft]) for a process flange with ...	
[mm]	[in]			smooth seal face	Raised face
25	1	4 × UNC ½" × 5.70	– <sup>1)</sup>	19 (14)	10 (7)
40	1 ½	4 × UNC ½" × 6.50	– <sup>1)</sup>	29 (21)	19 (14)
50	2	4 × UNC 5/8" × 7.50	– <sup>1)</sup>	41 (30)	37 (27)
80	3	4 × UNC 5/8" × 9.25	– <sup>1)</sup>	43 (31)	43 (31)
100	4	8 × UNC 5/8" × 10.4	5.79	38 (28)	38 (28)

- 1) A centering sleeve is not required. The device is centered directly via the sensor housing.

*Screw tightening torques, mounting bolts and centering sleeves for JIS B2220, 10K*

Nominal diameter [mm]	Mounting bolts [mm]	Length Centering sleeve [mm]	Max. screw tightening torque [Nm] for a process flange with ...	
			smooth seal face	Raised face
25	4 × M16 × 170	54	24	24
40	4 × M16 × 170	68	32	25
50	4 × M16 × 185	– <sup>1)</sup>	38	30
65	4 × M16 × 200	– <sup>1)</sup>	42	42
80	8 × M16 × 225	– <sup>1)</sup>	36	28
100	8 × M16 × 260	– <sup>1)</sup>	39	37

- 1) A centering sleeve is not required. The device is centered directly via the sensor housing.

### 6.2.4 Mounting the transmitter of the remote version

#### ⚠ CAUTION

##### Ambient temperature too high!

Danger of electronics overheating and housing deformation.

- ▶ Do not exceed the permitted maximum ambient temperature .
- ▶ If operating outdoors: Avoid direct sunlight and exposure to weathering, particularly in warm climatic regions.

#### ⚠ CAUTION

##### Excessive force can damage the housing!

- ▶ Avoid excessive mechanical stress.

The transmitter of the remote version can be mounted in the following ways:

- Wall mounting
- Pipe mounting

#### Wall mounting

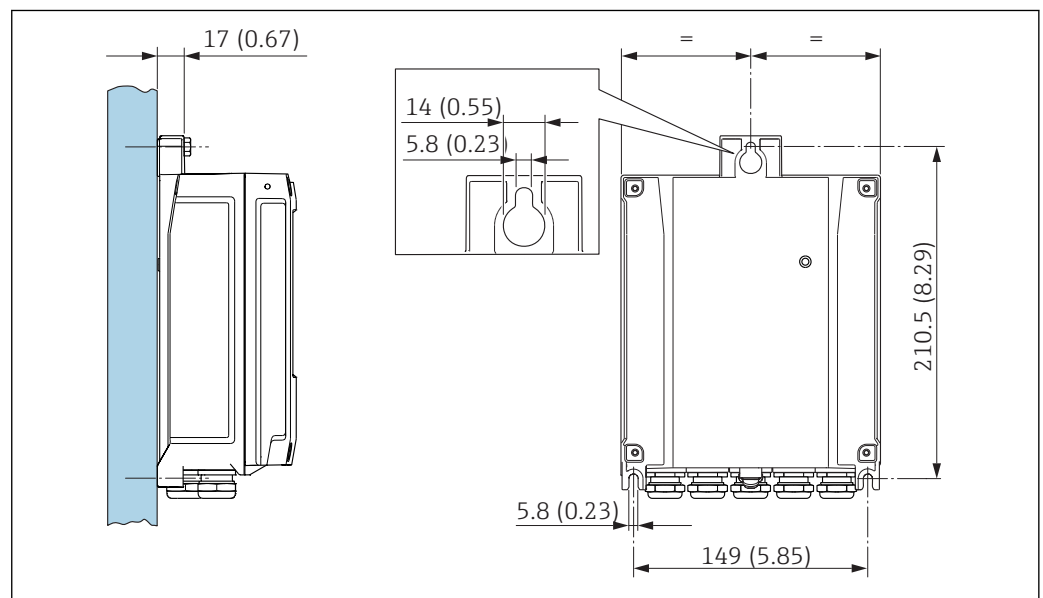

8 Engineering unit mm (in)

1. Drill the holes.
2. Insert wall plugs into the drilled holes.
3. Screw in the securing screws slightly at first.
4. Fit the transmitter housing over the securing screws and mount in place.
5. Tighten the securing screws.

#### Post mounting

#### ⚠ WARNING

##### Excessive tightening torque applied to the fixing screws!

Risk of damaging the plastic transmitter.

- ▶ Tighten the fixing screws as per the tightening torque:

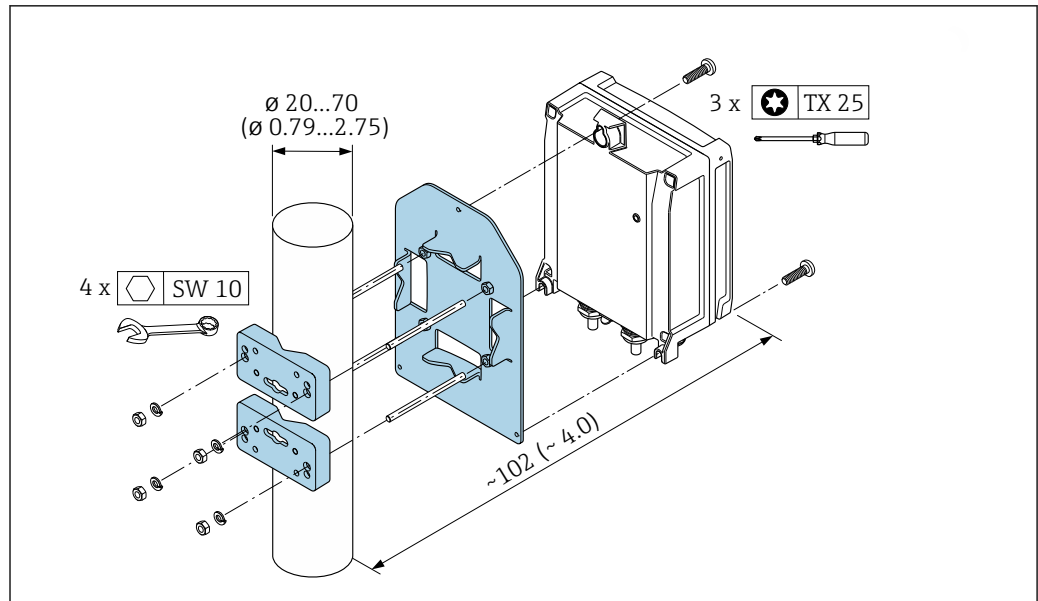

A0029051

9 Engineering unit mm (in)

### 6.2.5 Turning the transmitter housing

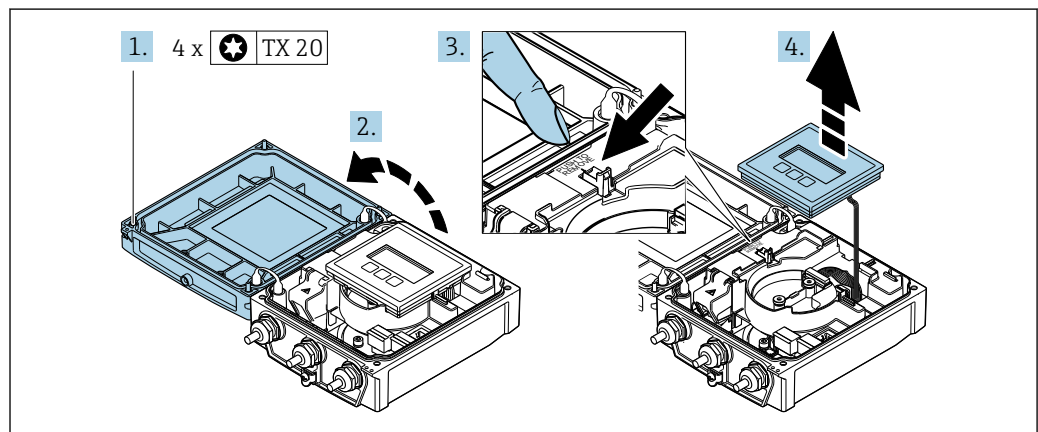

To provide easier access to the connection compartment or display module, the transmitter housing can be turned.



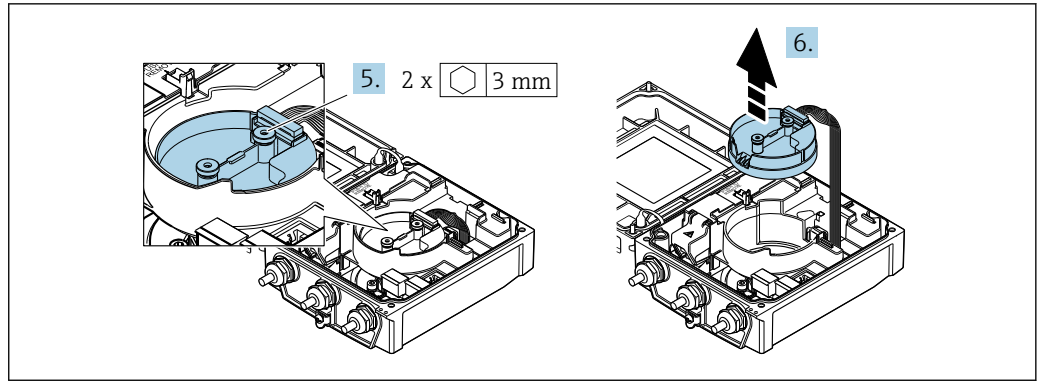

A0032086

1. Loosen the fixing screws of the housing cover (when reassembling, pay attention to the tightening torque → 30).
2. Open the housing cover.
3. Unlock the display module.
4. Remove the display module.

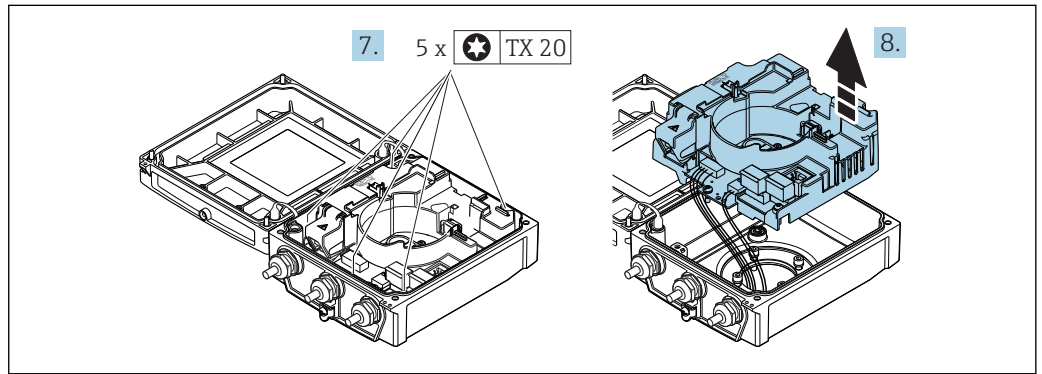

5. Loosen the fixing screws of the smart sensor electronics module (when reassembling, pay attention to the tightening torque →  30).
6. Remove the smart sensor electronics module (when reassembling, pay attention to the coding of the plug →  30).



7. Loosen the fixing screws of the main electronics module (when reassembling, pay attention to the tightening torque →  30).
8. Remove the main electronics module.

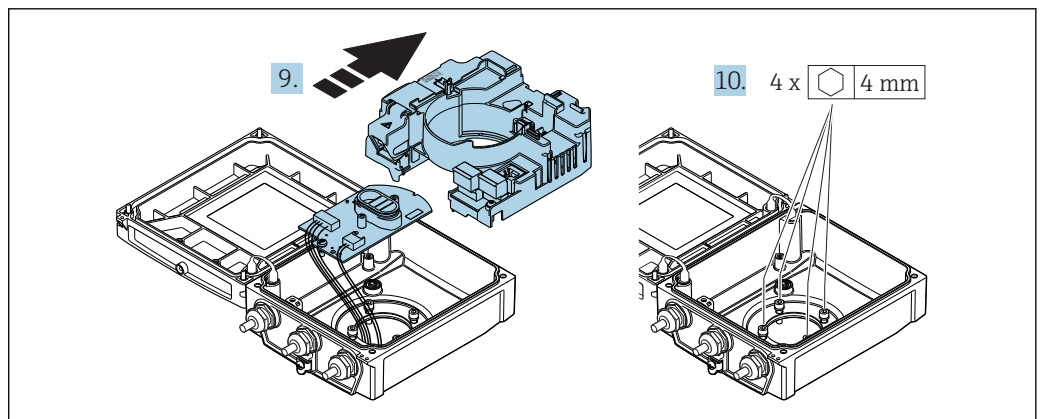

9. Remove the electronics module from the main electronics module.
10. Loosen the fixing screws of the transmitter housing (when reassembling, pay attention to the tightening torque →  30).

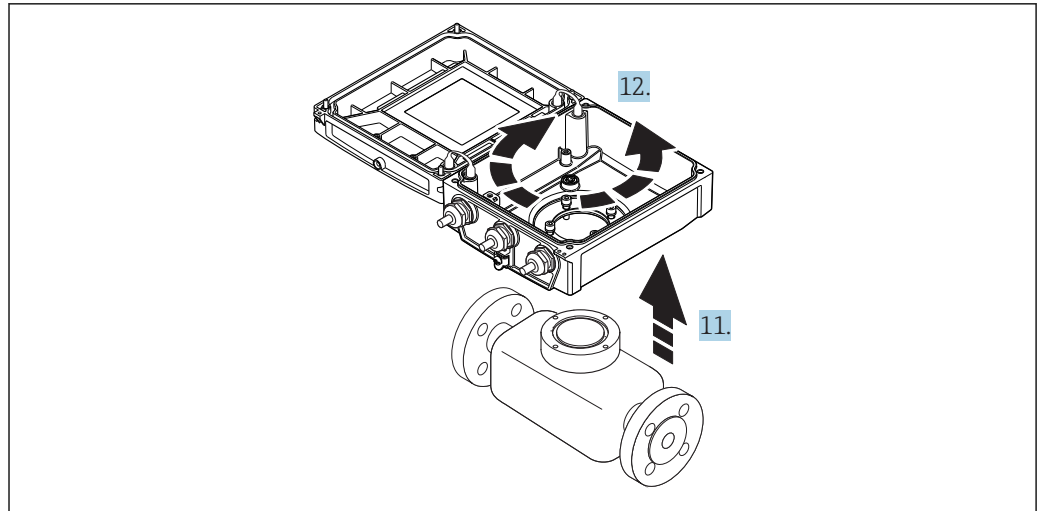

A0032132

- 11. Lift the transmitter housing.
- 12. Turn the housing to the desired position in increments of 90°.

**Reassembling the transmitter housing**

**⚠ WARNING**

**Excessive tightening torque applied to the fixing screws!**

Risk of damaging the plastic transmitter.

- ▶ Tighten the fixing screws as per the tightening torque:

Step → 28	Fixing screw	Tightening torques for housing made of:	
		Aluminum	Plastic
1	Housing cover	2.5 Nm (1.8 lbf ft)	1 Nm (0.7 lbf ft)
5	Smart sensor electronics module	0.6 Nm (0.4 lbf ft)	
7	Main electronics module	1.5 Nm (1.1 lbf ft)	
9/10	Transmitter housing	5.5 Nm (4.1 lbf ft)	

**NOTICE**

**Plug of the smart sensor electronics module connected incorrectly!**

No measuring signal is output.

- ▶ Plug in the plug of the smart sensor electronics module as per the coding.

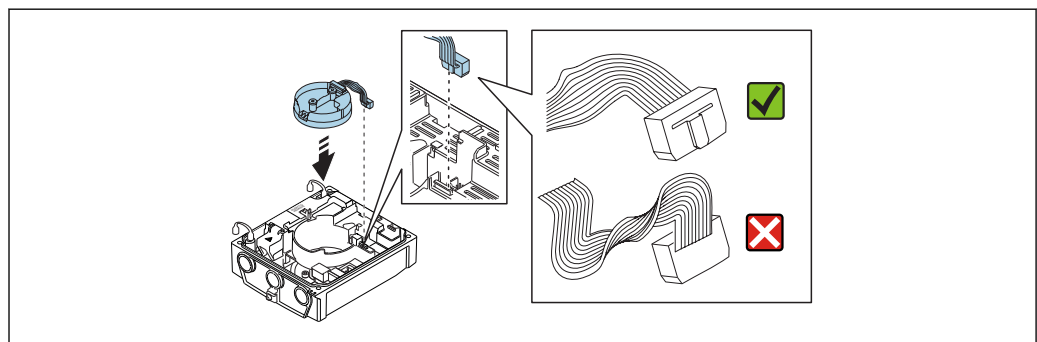

A0021585

**NOTICE**

**Incorrect routing of the connecting cables between the sensor and transmitter in the transmitter housing!**

This can interfere with the measuring signal.

- ▶ Route the connecting cables directly at the level of the plugs.
- ▶ Reverse the procedure to reassemble the measuring device.

**6.2.6 Turning the display module**

The display module can be turned to optimize display readability and operability.

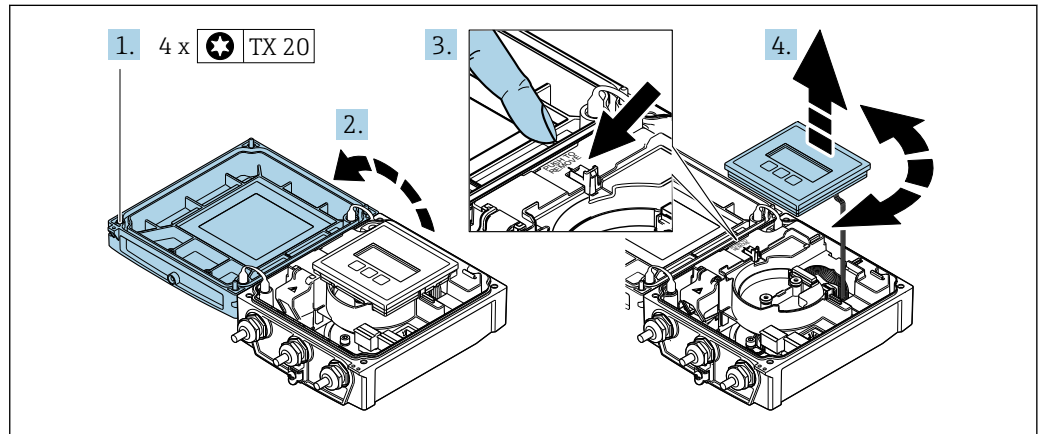

1. Loosen the fixing screws of the housing cover (when reassembling, pay attention to the tightening torque → 31).
2. Open the housing cover.
3. Unlock the display module.
4. Pull out the display module and turn it to the desired position in increments of 90°.

**Reassembling the transmitter housing**

**⚠ WARNING**

**Excessive tightening torque applied to the fixing screws!**

Risk of damaging the plastic transmitter.

- ▶ Tighten the fixing screws as per the tightening torque:

Step (see graphic)	Fixing screw	Tightening torque for housing made of:	
		Aluminum	Plastic
1	Housing cover	2.5 Nm (1.8 lbf ft)	1 Nm (0.7 lbf ft)

- ▶ Reverse the procedure to reassemble the measuring device.

### 6.3 Post-installation check

Is the device undamaged (visual inspection)?	<input type="checkbox"/>
Does the measuring device conform to the measuring point specifications? For example: <ul style="list-style-type: none"> <li>▪ Process temperature</li> <li>▪ Process pressure (refer to the section on "Pressure-temperature ratings" in the "Technical Information" document)</li> <li>▪ Ambient temperature</li> <li>▪ Measuring range</li> </ul>	<input type="checkbox"/>
Has the correct orientation for the sensor been selected ? <ul style="list-style-type: none"> <li>▪ According to sensor type</li> <li>▪ According to medium temperature</li> <li>▪ According to medium properties (outgassing, with entrained solids)</li> </ul>	<input type="checkbox"/>
Does the arrow on the sensor nameplate match the direction of flow of the fluid through the piping ?	<input type="checkbox"/>
Are the measuring point identification and labeling correct (visual inspection)?	<input type="checkbox"/>
Is the device adequately protected from precipitation and direct sunlight?	<input type="checkbox"/>
Have the fixing screws been tightened with the correct tightening torque?	<input type="checkbox"/>



## 7 Electrical connection

### NOTICE

The measuring device does not have an internal circuit breaker.

- ▶ For this reason, assign the measuring device a switch or power-circuit breaker so that the power supply line can be easily disconnected from the mains.
- ▶ Although the measuring device is equipped with a fuse, additional overcurrent protection (maximum 16 A) should be integrated into the system installation.

### 7.1 Connection conditions

#### 7.1.1 Requirements for connecting cable

The connecting cables provided by the customer must fulfill the following requirements.

##### Electrical safety

In accordance with applicable federal/national regulations.

##### Permitted temperature range

Minimum requirement: cable temperature range  $\geq$  ambient temperature +20 K

##### Power supply cable

Standard installation cable is sufficient.

##### Signal cable

*Current output 0/4 to 20 mA*

Standard installation cable is sufficient.

*Current output 4 to 20 mA HART*

A shielded cable is recommended. Observe grounding concept of the plant.

*Pulse/frequency/switch output*

Standard installation cable is sufficient.

*Status input*

Standard installation cable is sufficient.

##### Connecting cable for remote version

*Electrode cable*

<b>Standard cable</b>	3 $\times$ 0.38 mm <sup>2</sup> (20 AWG) with common, braided copper shield ( $\phi$ ~9.5 mm (0.37 in)) and individual shielded cores
<b>Conductor resistance</b>	$\leq$ 50 $\Omega$ /km (0.015 $\Omega$ /ft)
<b>Capacitance: core/shield</b>	$\leq$ 420 pF/m (128 pF/ft)
<b>Operating temperature</b>	-20 to +80 °C (-68 to +176 °F)

*Coil current cable*

<b>Standard cable</b>	3 × 0.75 mm <sup>2</sup> (18 AWG) with common, braided copper shield (ϕ ~9 mm (0.35 in))
<b>Conductor resistance</b>	≤ 37 Ω/km (0.011 Ω/ft)
<b>Capacitance: core/core, shield grounded</b>	≤ 120 pF/m (37 pF/ft)
<b>Operating temperature</b>	-20 to +80 °C (-68 to +176 °F)
<b>Test voltage for cable insulation</b>	≤ AC 1433 V r.m.s. 50/60 Hz or ≥ DC 2026 V

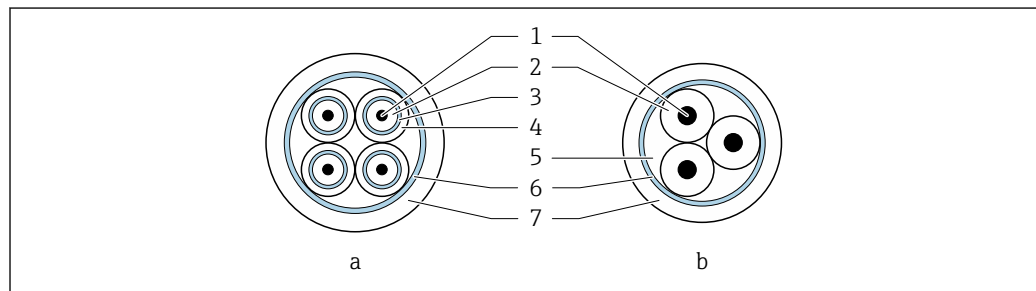

A0029151

10 Cable cross-section

- a* Electrode cable
- b* Coil current cable
- 1 Core
- 2 Core insulation
- 3 Core shield
- 4 Core jacket
- 5 Core reinforcement
- 6 Cable shield
- 7 Outer jacket

*Operation in zones of severe electrical interference*

The measuring system meets the general safety requirements → 156 and EMC specifications → 146.

Grounding is by means of the ground terminal provided for the purpose inside the connection housing. The stripped and twisted lengths of cable shield to the ground terminal must be as short as possible.

**Cable diameter**

- Cable glands supplied:
  - For standard cable: M20 × 1.5 with cable ϕ6 to 12 mm (0.24 to 0.47 in)
  - For reinforced cable: M20 × 1.5 with cable ϕ9.5 to 16 mm (0.37 to 0.63 in)
- (Plug-in) spring terminals for wire cross-sections 0.5 to 2.5 mm<sup>2</sup> (20 to 14 AWG)

**7.1.2 Required tools**

- Torque wrench
- For cable entries: Use corresponding tools
- Wire stripper
- When using stranded cables: Crimper for wire end ferrule

### 7.1.3 Terminal assignment

#### Transmitter

The sensor can be ordered with terminals.

Connection methods available		Possible options for order code "Electrical connection"
Outputs	Power supply	
Terminals	Terminals	<ul style="list-style-type: none"> <li>■ Option A: coupling M20x1</li> <li>■ Option B: thread M20x1</li> <li>■ Option C: thread G ½"</li> <li>■ Option D: thread NPT ½"</li> </ul>

#### Supply voltage

Order code for "Power supply"	Terminal numbers	
	1 (L+/L)	2 (L-/N)
Option L (wide range power unit)	AC100 to 240 V	
	AC/DC24 V	

#### Signal transmission 0-20 mA/4-20 mA HART and additional outputs and inputs

Order code for "Output" and "Input"	Terminal numbers							
	Output 1		Output 2		Output 3		Input	
	26 (+)	27 (-)	24 (+)	25 (-)	22 (+)	23 (-)	20 (+)	21 (-)
Option H	<ul style="list-style-type: none"> <li>■ 4-20 mA HART (active)</li> <li>■ 0-20 mA (active)</li> </ul>		Pulse/frequency output (passive)		Switch output (passive)		-	
Option I	<ul style="list-style-type: none"> <li>■ 4-20 mA HART (active)</li> <li>■ 0-20 mA (active)</li> </ul>		Pulse/frequency/switch output (passive)		Pulse/frequency/switch output (passive)		Status input	

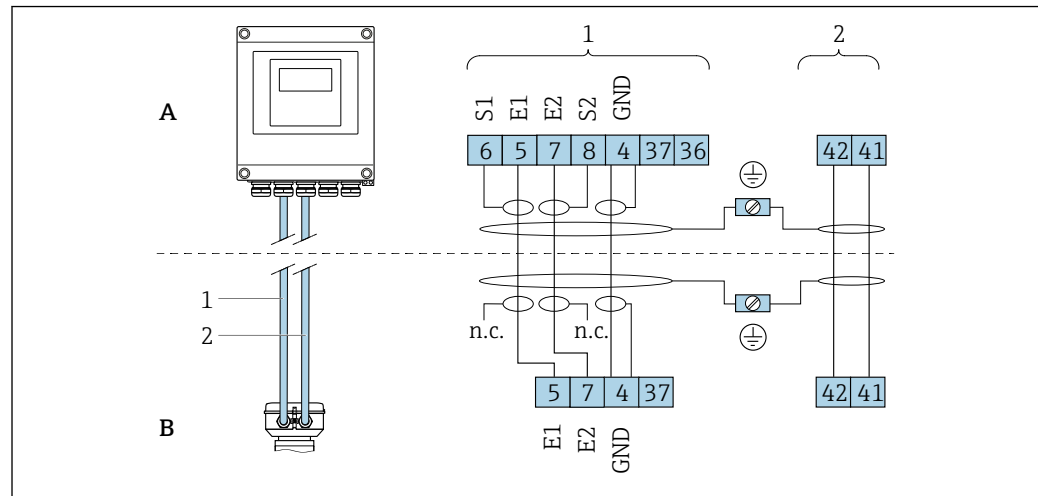
**Remote version**

11 Remote version terminal assignment

- A Transmitter wall-mount housing  
 B Sensor connection housing  
 1 Electrode cable  
 2 Coil current cable  
 n.c. Not connected, insulated cable shields

Terminal No. and cable colors: 6/5 = brown; 7/8 = white; 4 = green

**7.1.4 Shielding and grounding****7.1.5 Requirements for the supply unit****Supply voltage***Transmitter*

Order code for "Power supply"	Terminal voltage	Frequency range
Option L	AC100 to 240 V	50/ 60 Hz, $\pm 4$ Hz
	AC/DC24 V	50/ 60 Hz, $\pm 4$ Hz

**7.1.6 Preparing the measuring device**

Carry out the steps in the following order:

1. Mount the sensor and transmitter.
2. Connection housing, sensor: Connect connecting cable.
3. Transmitter: Connect connecting cable.
4. Transmitter: Connect signal cable and cable for supply voltage.

**NOTICE****Insufficient sealing of the housing!**

Operational reliability of the measuring device could be compromised.

- Use suitable cable glands corresponding to the degree of protection.

1. Remove dummy plug if present.
2. If the measuring device is supplied without cable glands:  
Provide suitable cable gland for corresponding connecting cable.

- 3. If the measuring device is supplied with cable glands:  
Observe requirements for connecting cables → 33.

### 7.1.7 Preparing the connecting cable for the remote version

When terminating the connecting cable, pay attention to the following points:

- 1. In the case of the electrode cable:  
Make sure that the ferrules do not touch the core shields on the sensor side.  
Minimum distance = 1 mm (exception: green “GND” cable)
- 2. In the case of the coil current cable:  
Insulate one core of the three-core cable at the level of the core reinforcement. You only require two cores for the connection.
- 3. For cables with fine-wire cores (stranded cables):  
Fit the cores with ferrules.

#### Transmitter

Electrode cable	Coil current cable
<p style="text-align: center;">A</p> <p style="text-align: center;">B</p> <p style="text-align: center;">12 Engineering unit mm (in)</p> <p style="text-align: right; font-size: small;">A0032093</p>	<p style="text-align: center;">A</p> <p style="text-align: center;">B</p> <p style="text-align: center;">13 Engineering unit mm (in)</p> <p style="text-align: right; font-size: small;">A0032096</p>
<p>A = Termination of the cables                      B = Termination of the fine-wire cores with ferrules                      1 = Red ferrules, <math>\phi</math> 1.0 mm (0.04 in)                      2 = White ferrules, <math>\phi</math> 0.5 mm (0.02 in)                      * = Stripping only for reinforced cables</p>	

## Sensor

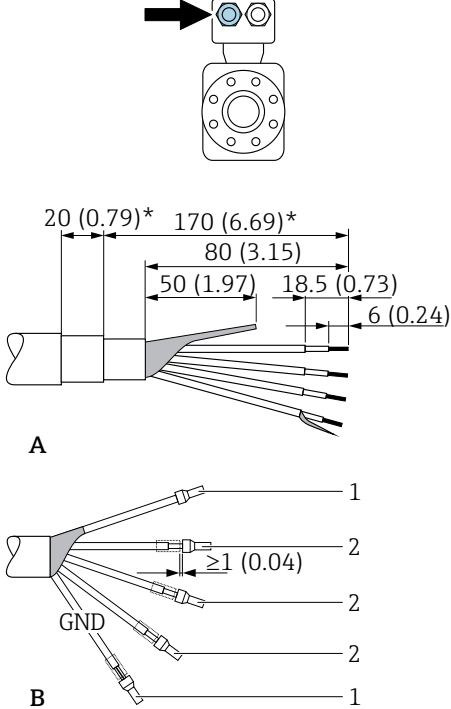
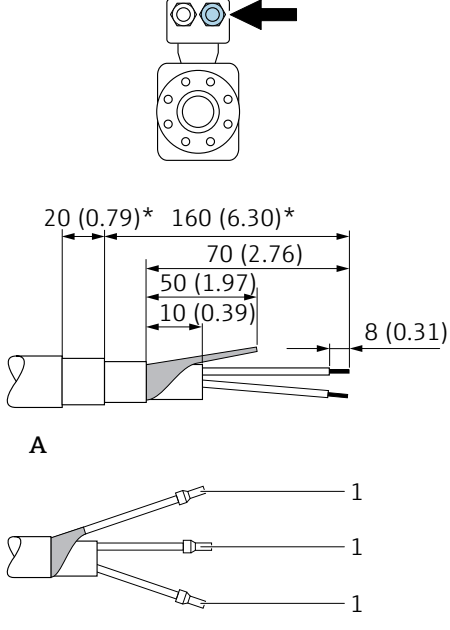
Electrode cable	Coil current cable
 <p>A</p> <p>B</p> <p>A0032100</p>	 <p>A</p> <p>B</p> <p>A0032101</p>
<p>A = Termination of the cables            B = Termination of the fine-wire cores with ferrules            1 = Red ferrules, <math>\phi</math> 1.0 mm (0.04 in)            2 = White ferrules, <math>\phi</math> 0.5 mm (0.02 in)            * = Stripping only for reinforced cables</p>	

## 7.2 Connecting the measuring device

### **⚠ WARNING**

#### **Risk of electric shock! Components carry dangerous voltages!**

- ▶ Have electrical connection work carried out by correspondingly trained specialists only.
- ▶ Observe applicable federal/national installation codes and regulations.
- ▶ Comply with local workplace safety regulations.
- ▶ Observe grounding concept of the plant.
- ▶ Never mount or wire the measuring device while it is connected to the supply voltage.
- ▶ Before the supply voltage is applied, connect the protective ground to the measuring device.

### 7.2.1 Connecting the remote version

#### **⚠ WARNING**

#### **Risk of damaging the electronic components!**

- ▶ Connect the sensor and transmitter to the same potential equalization.
- ▶ Only connect the sensor to a transmitter with the same serial number.
- ▶ Ground the connection housing of the sensor via the external screw terminal.

The following procedure (in the action sequence given) is recommended for the remote version:

1. Mount the sensor and transmitter.
2. Connect the connecting cable.

3. Connect the transmitter.

### Connecting the connecting cable to the sensor connection housing

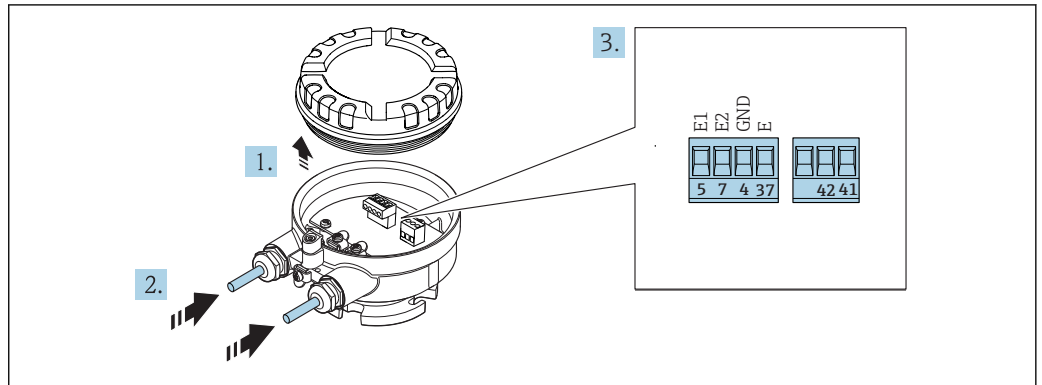

A0032134

14 Sensor: connection module

1. Loosen the securing clamp of the housing cover.
2. Unscrew and lift off the housing cover.
3. Push the cable through the cable entry . To ensure tight sealing, do not remove the sealing ring from the cable entry.
4. Strip the cable and cable ends. In the case of stranded cables, also fit ferrules → 37.
5. Connect the cable in accordance with the terminal assignment → 36.
6. Firmly tighten the cable glands.
7. **⚠ WARNING**  
**Housing degree of protection may be voided due to insufficient sealing of the housing.**
  - ▶ Screw in the screw without using any lubricant. The threads on the cover are coated with a dry lubricant.

Reverse the procedure to reassemble the sensor.

### Connecting the connecting cable to the transmitter

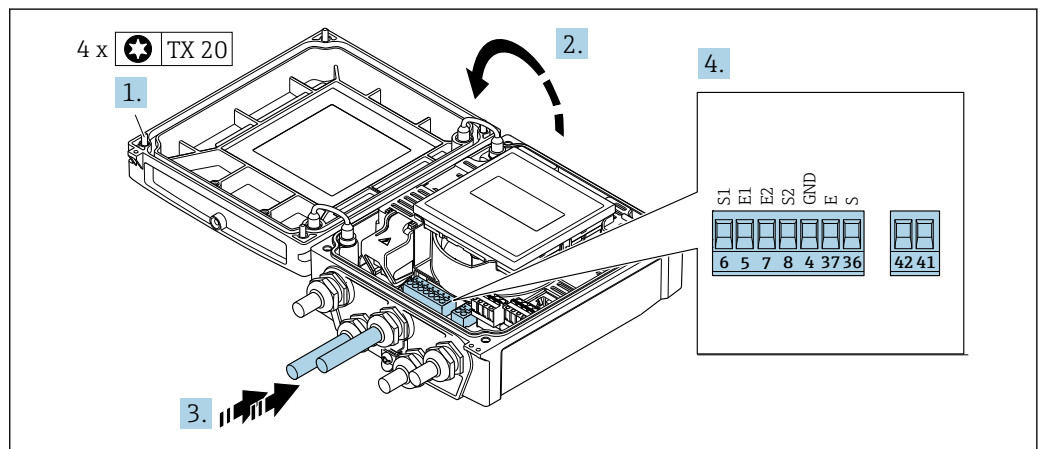

A0032102

15 Transmitter: main electronics module with terminals

1. Loosen the 4 fixing screws on the housing cover.
2. Open the housing cover.

3. Push the cable through the cable entry . To ensure tight sealing, do not remove the sealing ring from the cable entry.
4. Strip the cable and cable ends. In the case of stranded cables, also fit ferrules → 37.
5. Connect the cable in accordance with the terminal assignment → 36.
6. Firmly tighten the cable glands.
7. **⚠ WARNING**  
**Housing degree of protection may be voided due to insufficient sealing of the housing.**
  - ▶ Screw in the screw without using any lubricant.

Reverse the removal procedure to reassemble the transmitter.

### 7.2.2 Connecting the transmitter

**⚠ WARNING**

**Housing degree of protection may be voided due to insufficient sealing of the housing.**

- ▶ Screw in the screw without using any lubricant. The threads on the cover are coated with a dry lubricant.

*Tightening torques for plastic housing*

Housing cover fixing screw	1.3 Nm
Cable entry	4.5 to 5 Nm
Ground terminal	2.5 Nm

**i** For HART communication: when connecting the cable shielding to the ground terminal, observe the grounding concept of the facility.

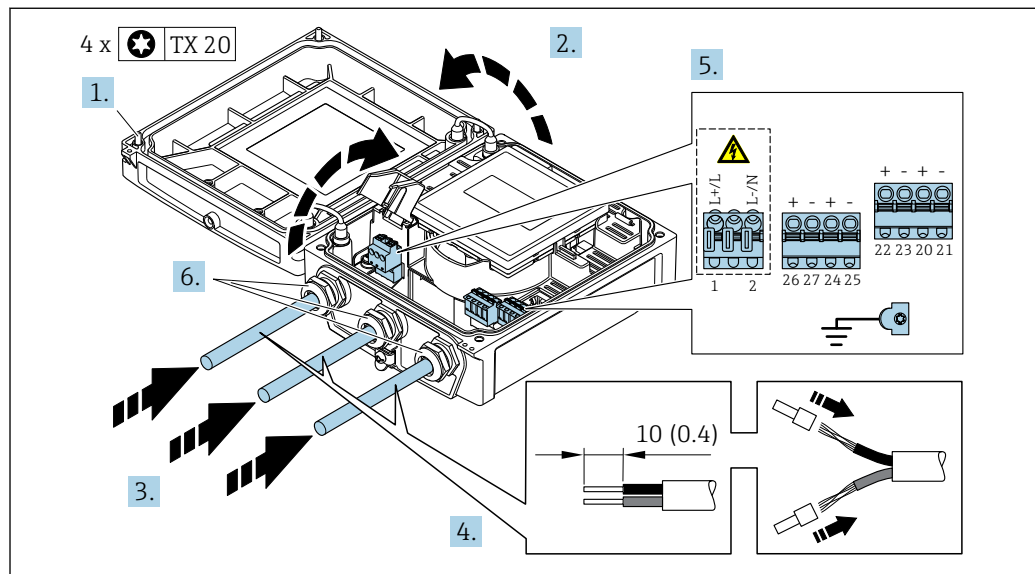

16 Connecting the supply voltage and 0-20 mA/4-20 mA HART with additional outputs and inputs

1. Loosen the 4 fixing screws on the housing cover.
2. Open the housing cover.
3. Push the cable through the cable entry . To ensure tight sealing, do not remove the sealing ring from the cable entry.
4. Strip the cable and cable ends. In the case of stranded cables, also fit ferrules.



5. Connect the cable in accordance with the terminal assignment → 35. For supply voltage: open the shock protection cover.

6. Firmly tighten the cable glands.

7. **⚠ WARNING**

**Housing degree of protection may be voided due to insufficient sealing of the housing.**

- ▶ Screw in the screw without using any lubricant.

Reverse the removal procedure to reassemble the transmitter.

### 7.2.3 Ensuring potential equalization

#### Requirements

**⚠ CAUTION**

**Electrode damage can result in the complete failure of the device!**

- ▶ Same electrical potential for the fluid and sensor
- ▶ Remote version: same electrical potential for the sensor and transmitter
- ▶ Company-internal grounding concepts
- ▶ Pipe material and grounding

#### Connection example, standard scenario

*Metal, grounded pipe*

This connection method also applies:

- For plastic pipes
- For pipes with insulating liner

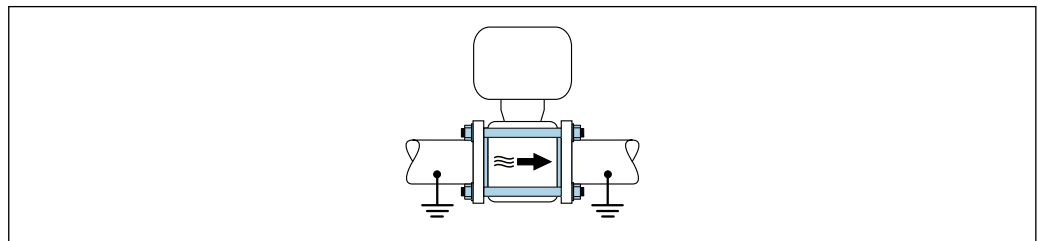

A0032048

#### Connection example in special situations

*Unlined and ungrounded metal pipe*

This connection method also applies in situations where:

- The customary potential equalization is not used
- Equalizing currents are present

<b>Ground cable</b>	Copper wire, at least 6 mm <sup>2</sup> (0.0093 in <sup>2</sup> )
---------------------	---

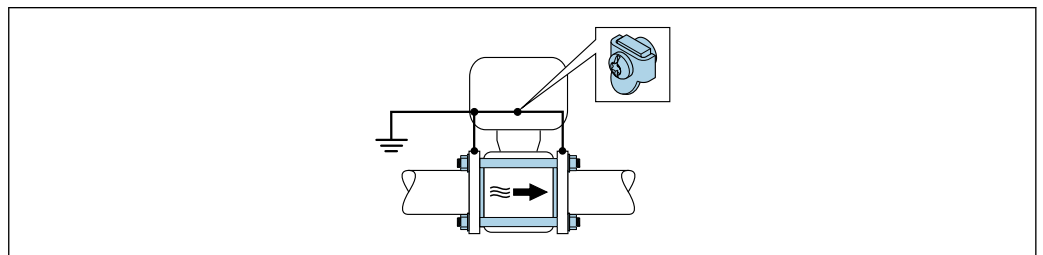

A0032049

Note the following when installing:

- Connect both pipe flanges to one another via a ground cable and ground them.
- Connect the connection housing of the transmitter or sensor to ground potential by means of the ground terminal provided for the purpose. Mount the ground cable directly on the conductive flange coating of the pipe with the flange screws.

**i** For remote device versions, the ground terminal in the example always refers to the sensor and **not** to the transmitter.

**i** You can order the necessary ground cable from Endress+Hauser: →  135.

#### *Pipe with a cathodic protection unit*

This connection method is only used if the following two conditions are met:

- Metal pipe without liner or pipe with electrically conductive liner
- Cathodic protection is integrated in the personal protection equipment

<b>Ground cable</b>	Copper wire, at least 6 mm <sup>2</sup> (0.0093 in <sup>2</sup> )
---------------------	---

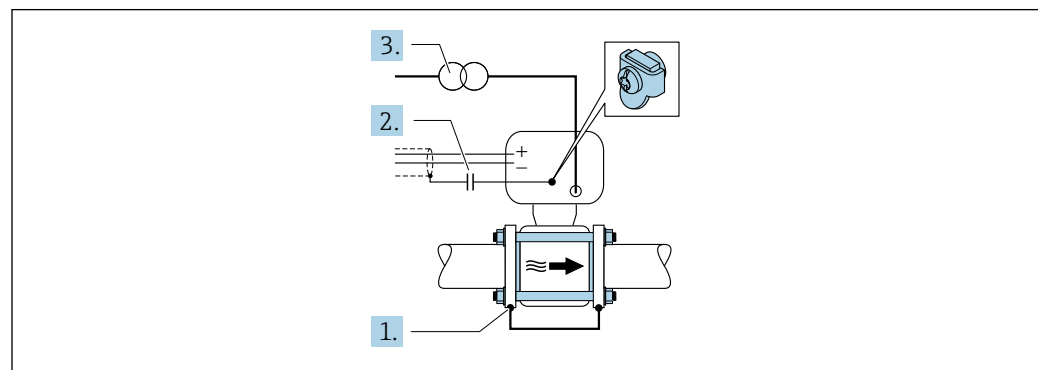

A0032050

Note the following when installing:

The sensor is installed in the pipe in a way that provides electrical insulation.

**i** For remote device versions, the ground terminal in the example always refers to the sensor and **not** to the transmitter.

**i** You can order the necessary ground cable from Endress+Hauser: →  135.

### 7.3 Special connection instructions

#### 7.3.1 Connection examples

##### Current output 4 to 20 mA HART

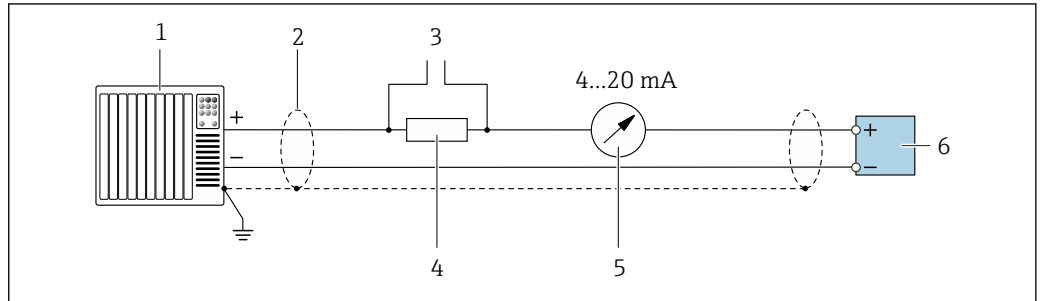

A0029055

17 Connection example for 4 to 20 mA HART current output (active)

- 1 Automation system with current input (e.g. PLC)
- 2 Cable shield: the cable shield must be grounded at both ends to comply with EMC requirements; observe cable specifications
- 3 Connection for HART operating devices
- 4 Resistor for HART communication ( $\geq 250 \Omega$ ): observe maximum load  $\rightarrow$  140
- 5 Analog display unit: observe maximum load  $\rightarrow$  140
- 6 Transmitter

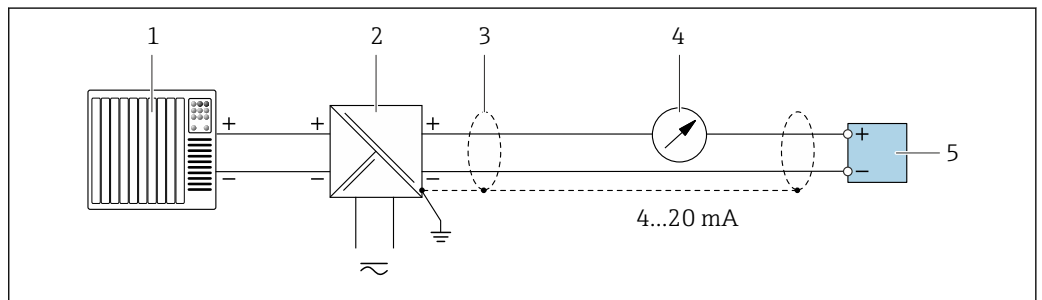

A0028762

18 Connection example for 4 to 20 mA HART current output (passive)

- 1 Automation system with current input (e.g. PLC)
- 2 Power supply
- 3 Cable shield: the cable shield must be grounded at both ends to comply with EMC requirements; observe cable specifications
- 4 Analog display unit: observe maximum load  $\rightarrow$  140
- 5 Transmitter

### Pulse/frequency output

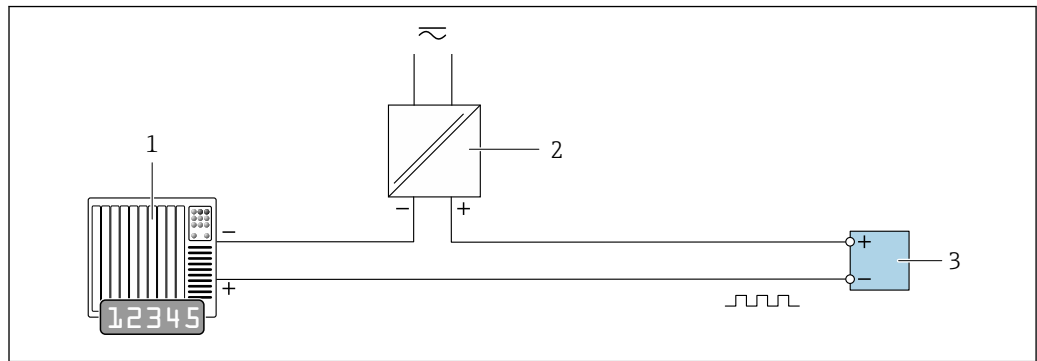

A0028761

19 Connection example for pulse/frequency output (passive)

- 1 Automation system with pulse/frequency input (e.g. PLC)
- 2 Power supply
- 3 Transmitter: Observe input values → 140

### Switch output

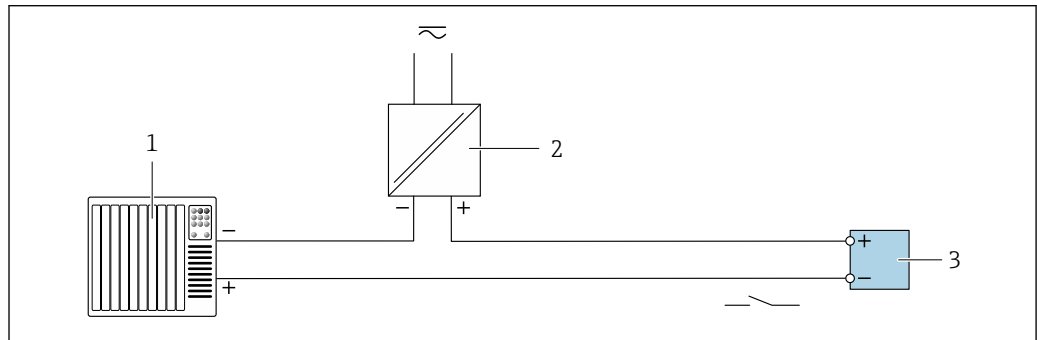

A0028760

20 Connection example for switch output (passive)

- 1 Automation system with switch input (e.g. PLC)
- 2 Power supply
- 3 Transmitter: Observe input values → 140

### Status input

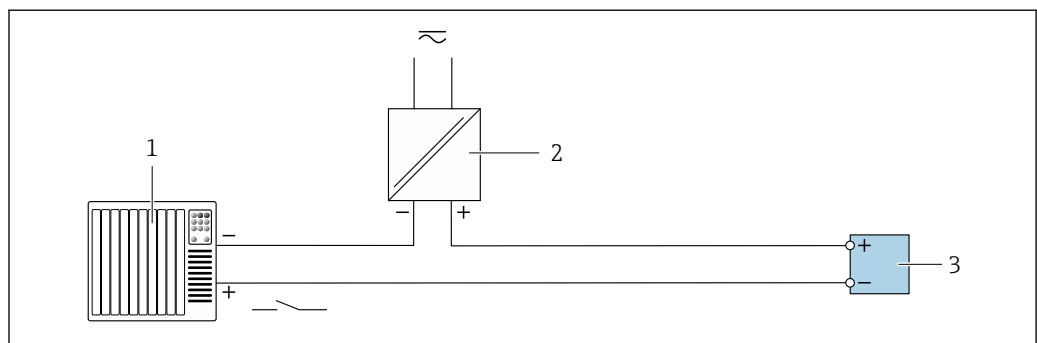

A0028764

21 Connection example for status input

- 1 Automation system with status output (e.g. PLC)
- 2 Power supply
- 3 Transmitter: Observe input values

## 7.4 Ensuring the degree of protection

### 7.4.1 Degree of protection IP66/67, Type 4X enclosure

The measuring device fulfills all the requirements for the IP66/67 degree of protection, Type 4X enclosure.

To guarantee IP66/67 degree of protection, Type 4X enclosure, carry out the following steps after the electrical connection:

1. Check that the housing seals are clean and fitted correctly. Dry, clean or replace the seals if necessary.
2. Tighten all housing screws and screw covers.
3. Firmly tighten the cable glands.
4. To ensure that moisture does not enter the cable entry, route the cable so that it loops down before the cable entry ("water trap").

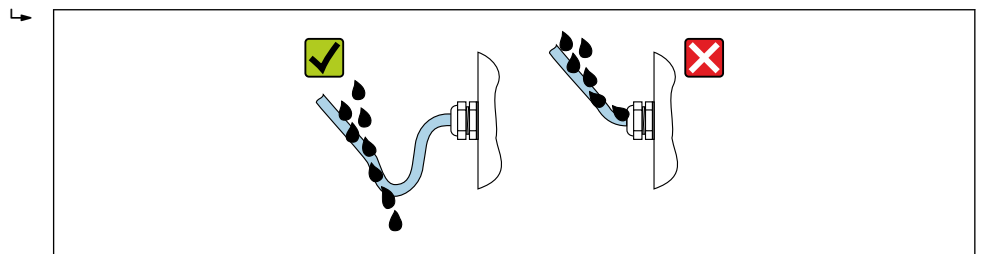

A0029278

5. Insert dummy plugs into unused cable entries.

## 7.5 Post-connection check

Are cables or the device undamaged (visual inspection)?	<input type="checkbox"/>
Do the cables used meet the requirements → 33?	<input type="checkbox"/>
Do the cables have adequate strain relief?	<input type="checkbox"/>
Are all the cable glands installed, firmly tightened and leak-tight? Cable run with "water trap" → 45?	<input type="checkbox"/>
Only for remote version: is the sensor connected to the right transmitter? Check the serial number on the nameplate of the sensor and transmitter.	<input type="checkbox"/>
Does the supply voltage match the specifications on the transmitter nameplate → 36?	<input type="checkbox"/>
Is the terminal assignment correct → 35?	<input type="checkbox"/>
If supply voltage is present, do values appear on the display module?	<input type="checkbox"/>
Is the potential equalization established correctly → 41?	<input type="checkbox"/>
Are all housing covers installed and the screws tightened with the correct tightening torque?	<input type="checkbox"/>

## 8 Operation options

### 8.1 Overview of operation options

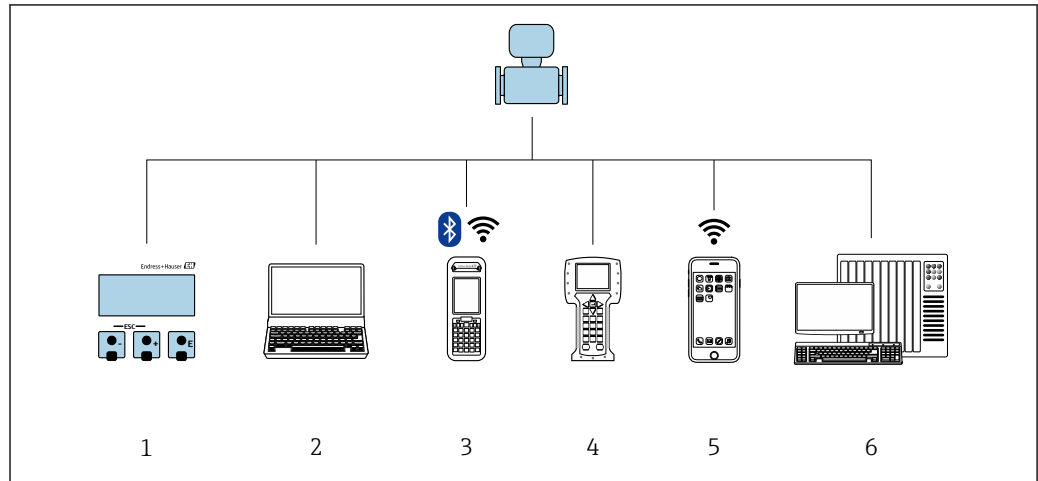



A0029295

- 1 Local operation via display module
- 2 Computer with Web browser (e.g. Internet Explorer) or with operating tool (e.g. FieldCare, DeviceCare, AMS Device Manager, SIMATIC PDM)
- 3 Field Xpert SFX350 or SFX370
- 4 Field Communicator 475
- 5 Mobile handheld terminal
- 6 Control system (e.g. PLC)

## 8.2 Structure and function of the operating menu

### 8.2.1 Structure of the operating menu

 For an overview of the operating menu for experts: "Description of Device Parameters" document supplied with the device →  157

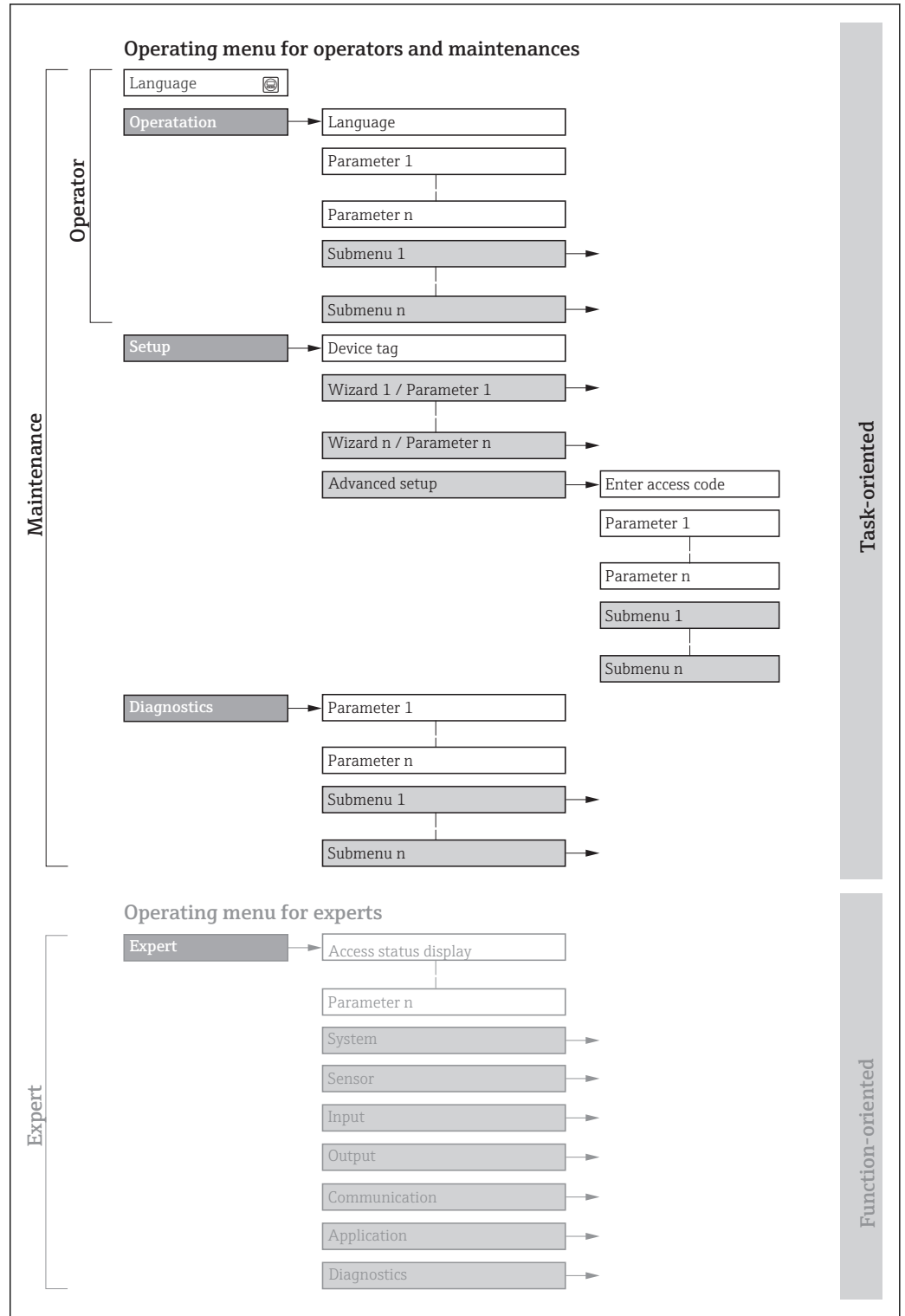

 22 Schematic structure of the operating menu

A0018237-EN

### 8.2.2 Operating philosophy

The individual parts of the operating menu are assigned to certain user roles (operator, maintenance etc.). Each user role contains typical tasks within the device lifecycle.

Menu/parameter		User role and tasks	Content/meaning
Language	task-oriented	<b>Role "Operator", "Maintenance"</b> Tasks during operation: <ul style="list-style-type: none"> <li>▪ Configuring the operational display</li> <li>▪ Reading measured values</li> </ul>	<ul style="list-style-type: none"> <li>▪ Defining the operating language</li> <li>▪ Defining the Web server operating language</li> <li>▪ Resetting and controlling totalizers</li> </ul>
Operation			<ul style="list-style-type: none"> <li>▪ Configuring the operational display (e.g. display format, display contrast)</li> <li>▪ Resetting and controlling totalizers</li> </ul>
Setup		<b>"Maintenance" role</b> Commissioning: <ul style="list-style-type: none"> <li>▪ Configuration of the measurement</li> <li>▪ Configuration of the outputs</li> </ul>	Wizards for fast commissioning: <ul style="list-style-type: none"> <li>▪ Set the system units</li> <li>▪ Set the input</li> <li>▪ Configure the outputs</li> <li>▪ Configuring the operational display</li> <li>▪ Define the output conditioning</li> <li>▪ Set the low flow cut off</li> <li>▪ Configure empty pipe detection</li> </ul> Advanced setup <ul style="list-style-type: none"> <li>▪ For more customized configuration of the measurement (adaptation to special measuring conditions)</li> <li>▪ Configuration of totalizers</li> <li>▪ Configuration of electrode cleaning (optional)</li> <li>▪ Configure the WLAN settings</li> <li>▪ Administration (define access code, reset measuring device)</li> </ul>
Diagnostics		<b>"Maintenance" role</b> Fault elimination: <ul style="list-style-type: none"> <li>▪ Diagnostics and elimination of process and device errors</li> <li>▪ Measured value simulation</li> </ul>	Contains all parameters for error detection and analyzing process and device errors: <ul style="list-style-type: none"> <li>▪ Diagnostic list Contains up to 5 currently pending diagnostic messages.</li> <li>▪ Event logbook Contains event messages that have occurred.</li> <li>▪ Device information Contains information for identifying the device.</li> <li>▪ Measured values Contains all current measured values.</li> <li>▪ <b>Data logging</b> submenu with "Extended HistoROM" order option Storage and visualization of measured values</li> <li>▪ Heartbeat The functionality of the device is checked on demand and the verification results are documented.</li> <li>▪ Simulation Is used to simulate measured values or output values.</li> </ul>
Expert	function-oriented	Tasks that require detailed knowledge of the function of the device: <ul style="list-style-type: none"> <li>▪ Commissioning measurements under difficult conditions</li> <li>▪ Optimal adaptation of the measurement to difficult conditions</li> <li>▪ Detailed configuration of the communication interface</li> <li>▪ Error diagnostics in difficult cases</li> </ul>	Contains all the parameters of the device and makes it possible to access these parameters directly using an access code. The structure of this menu is based on the function blocks of the device: <ul style="list-style-type: none"> <li>▪ System Contains all higher-order device parameters which do not concern the measurement or the communication interface.</li> <li>▪ Sensor Configuration of the measurement.</li> <li>▪ Input Configuring the status input.</li> <li>▪ Output Configuring of the analog current outputs as well as the pulse/frequency and switch output.</li> <li>▪ Communication Configuration of the digital communication interface and the Web server.</li> <li>▪ Application Configure the functions that go beyond the actual measurement (e.g. totalizer).</li> <li>▪ Diagnostics Error detection and analysis of process and device errors and for device simulation and Heartbeat Technology.</li> </ul>



### 8.3 Access to the operating menu via the local display

#### 8.3.1 Operational display

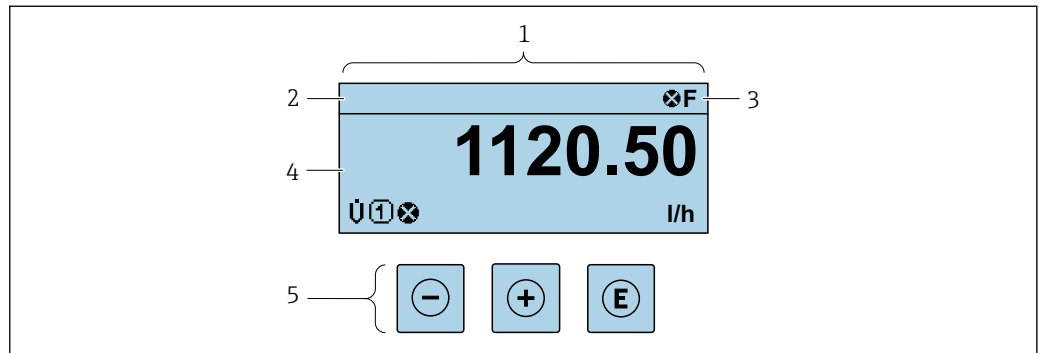

A0029346

- 1 Operational display
- 2 Device tag → 76
- 3 Status area
- 4 Display area for measured values (4-line)
- 5 Operating elements → 54

#### Status area

The following symbols appear in the status area of the operational display at the top right:

- Status signals → 116
  - **F**: Failure
  - **C**: Function check
  - **S**: Out of specification
  - **M**: Maintenance required
- Diagnostic behavior → 117
  - : Alarm
  - : Warning
- : Locking (the device is locked via the hardware )
- : Communication (communication via remote operation is active)

#### Display area

In the display area, each measured value is prefaced by certain symbol types for further description:

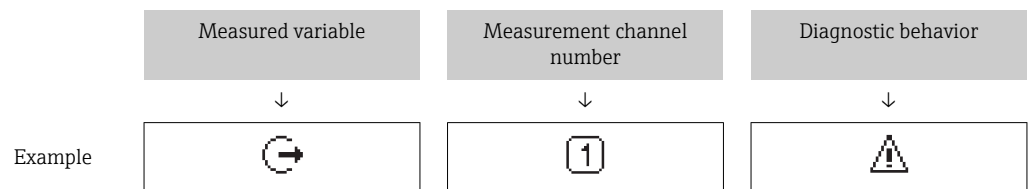

Appears only if a diagnostics event is present for this measured variable.

#### Measured values

Symbol	Meaning
	Volume flow
	Mass flow

	Totalizer The measurement channel number indicates which of the three totalizers is displayed.
	Output The measurement channel number indicates which of the outputs is displayed.
	Status input

*Measurement channel numbers*

Symbol	Meaning
	Measurement channel 1 to 4
The measurement channel number is displayed only if more than one channel is present for the same measured variable type (e.g. Totalizer 1 to 3).	

*Diagnostic behavior*

The diagnostic behavior pertains to a diagnostic event that is relevant to the displayed measured variable. For information on the symbols → 117

The number and display format of the measured values can be configured via the **Format display** parameter (→ 87).

### 8.3.2 Navigation view



In the submenu	In the wizard
1 Navigation view 2 Navigation path to current position 3 Status area 4 Display area for navigation 5 Operating elements →  54	

#### Navigation path

The navigation path - displayed at the top left in the navigation view - consists of the following elements:

<ul style="list-style-type: none"> <li>▪ In the submenu: Display symbol for menu</li> <li>▪ In the wizard: Display symbol for wizard</li> </ul>	Omission symbol for operating menu levels in between	Name of current <ul style="list-style-type: none"> <li>▪ Submenu</li> <li>▪ Wizard</li> <li>▪ Parameters</li> </ul>			
↓	↓	↓			
Examples					
			/ .. /	/ .. /	Display
			/ .. /	/ .. /	Display





 For more information about the icons in the menu, refer to the "Display area" section →  51

**Status area**





The following appears in the status area of the navigation view in the top right corner:

- In the submenu
  - The direct access code for the parameter you are navigating to (e.g. 0022-1)
  - If a diagnostic event is present, the diagnostic behavior and status signal
- In the wizard
  - If a diagnostic event is present, the diagnostic behavior and status signal





- For information on the diagnostic behavior and status signal →  116
- For information on the function and entry of the direct access code →  56

**Display area**

*Menus*

Symbol	Meaning
	<b>Operation</b> Appears: <ul style="list-style-type: none"> <li>▪ In the menu next to the "Operation" selection</li> <li>▪ At the left in the navigation path in the <b>Operation</b> menu</li> </ul>
	<b>Setup</b> Appears: <ul style="list-style-type: none"> <li>▪ In the menu next to the "Setup" selection</li> <li>▪ At the left in the navigation path in the <b>Setup</b> menu</li> </ul>
	<b>Diagnostics</b> Appears: <ul style="list-style-type: none"> <li>▪ In the menu next to the "Diagnostics" selection</li> <li>▪ At the left in the navigation path in the <b>Diagnostics</b> menu</li> </ul>
	<b>Expert</b> Appears: <ul style="list-style-type: none"> <li>▪ In the menu next to the "Expert" selection</li> <li>▪ At the left in the navigation path in the <b>Expert</b> menu</li> </ul>



*Submenus, wizards, parameters*

Symbol	Meaning
	Submenu
	Wizard
	Parameters within a wizard  No display symbol exists for parameters in submenus.

*Locking*

Symbol	Meaning
	<b>Parameter locked</b> When displayed in front of a parameter name, indicates that the parameter is locked. <ul style="list-style-type: none"> <li>▪ By a user-specific access code</li> <li>▪ By the hardware write protection switch</li> </ul>

Wizard operation

Symbol	Meaning
	Switches to the previous parameter.
	Confirms the parameter value and switches to the next parameter.
	Opens the editing view of the parameter.



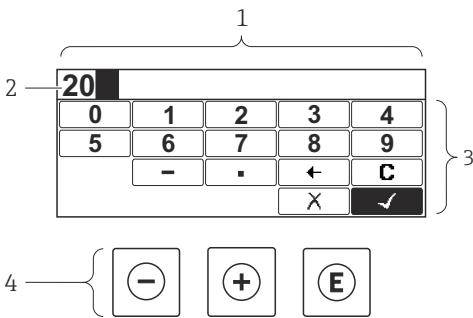
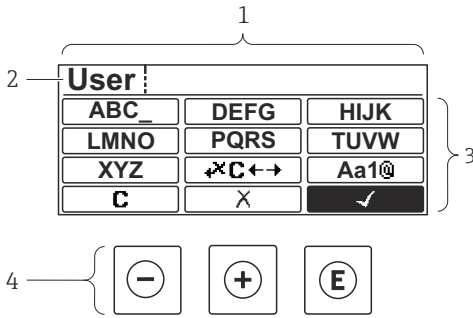



8.3.3 Editing view

Numeric editor	Text editor
	
<p>1 Editing view</p> <p>2 Display area of the entered values</p> <p>3 Input mask</p> <p>4 Operating elements → 54</p>	<p>1 Editing view</p> <p>2 Display area of the entered values</p> <p>3 Input mask</p> <p>4 Operating elements → 54</p>

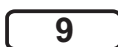









Input mask

The following input symbols are available in the input mask of the numeric and text editor:





Numeric editor

Symbol	Meaning
	Selection of numbers from 0 to 9.
	
	Inserts decimal separator at the input position.
	Inserts minus sign at the input position.
	Confirms selection.
	Moves the input position one position to the left.
	Exits the input without applying the changes.
	Clears all entered characters.







## Text editor

Symbol	Meaning
	Toggle <ul style="list-style-type: none"> <li>Between upper-case and lower-case letters</li> <li>For entering numbers</li> <li>For entering special characters</li> </ul>
 ... 	Selection of letters from A to Z.
 ... 	Selection of letters from a to z.
 ... 	Selection of special characters.
	Confirms selection.
	Switches to the selection of the correction tools.
	Exits the input without applying the changes.
	Clears all entered characters.

Correction symbols under 

Symbol	Meaning
	Clears all entered characters.
	Moves the input position one position to the right.
	Moves the input position one position to the left.
	Deletes one character immediately to the left of the input position.

### 8.3.4 Operating elements

Key	Meaning
	<p><b>Minus key</b></p> <p><i>In a menu, submenu</i> Moves the selection bar upwards in a choose list.</p> <p><i>With a Wizard</i> Confirms the parameter value and goes to the previous parameter.</p> <p><i>With a text and numeric editor</i> In the input mask, moves the selection bar to the left (backwards).</p>
	<p><b>Plus key</b></p> <p><i>In a menu, submenu</i> Moves the selection bar downwards in a choose list.</p> <p><i>With a Wizard</i> Confirms the parameter value and goes to the next parameter.</p> <p><i>With a text and numeric editor</i> Moves the selection bar to the right (forwards) in an input screen.</p>
	<p><b>Enter key</b></p> <p><i>For operational display</i></p> <ul style="list-style-type: none"> <li>■ Pressing the key briefly opens the operating menu.</li> <li>■ Pressing the key for 2 s opens the context menu.</li> </ul> <p><i>In a menu, submenu</i></p> <ul style="list-style-type: none"> <li>■ Pressing the key briefly:                             <ul style="list-style-type: none"> <li>- Opens the selected menu, submenu or parameter.</li> <li>- Starts the wizard.</li> <li>- If help text is open, closes the help text of the parameter.</li> </ul> </li> <li>■ Pressing the key for 2 s for parameter:                             <ul style="list-style-type: none"> <li>- If present, opens the help text for the function of the parameter.</li> </ul> </li> </ul> <p><i>With a Wizard</i> Opens the editing view of the parameter.</p> <p><i>With a text and numeric editor</i></p> <ul style="list-style-type: none"> <li>■ Pressing the key briefly:                             <ul style="list-style-type: none"> <li>- Opens the selected group.</li> <li>- Carries out the selected action.</li> </ul> </li> <li>■ Pressing the key for 2 s confirms the edited parameter value.</li> </ul>
	<p><b>Escape key combination (press keys simultaneously)</b></p> <p><i>In a menu, submenu</i></p> <ul style="list-style-type: none"> <li>■ Pressing the key briefly:                             <ul style="list-style-type: none"> <li>- Exits the current menu level and takes you to the next higher level.</li> <li>- If help text is open, closes the help text of the parameter.</li> </ul> </li> <li>■ Pressing the key for 2 s returns you to the operational display ("home position").</li> </ul> <p><i>With a Wizard</i> Exits the wizard and takes you to the next higher level.</p> <p><i>With a text and numeric editor</i> Closes the text or numeric editor without applying changes.</p>
	<p><b>Minus/Enter key combination (press the keys simultaneously)</b></p> <p>Reduces the contrast (brighter setting).</p>
	<p><b>Plus/Enter key combination (press and hold down the keys simultaneously)</b></p> <p>Increases the contrast (darker setting).</p>
	<p><b>Minus/Plus/Enter key combination (press the keys simultaneously)</b></p> <p><i>For operational display</i> Enables or disables the keypad lock (only SD02 display module).</p>

### 8.3.5 Opening the context menu

Using the context menu, the user can call up the following menus quickly and directly from the operational display:

- Setup
- Simulation



### Calling up and closing the context menu

The user is in the operational display.

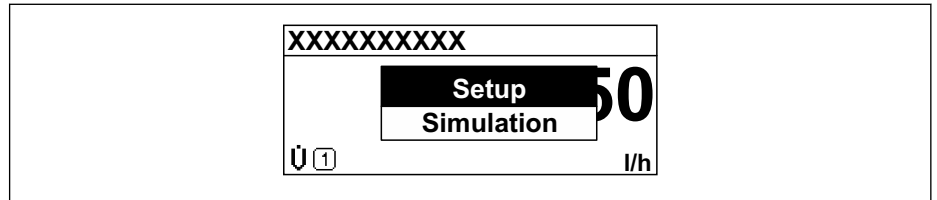

1. Press  for 2 s.
  - ↳ The context menu opens.



A0017421-EN

2. Press  +  simultaneously.
  - ↳ The context menu is closed and the operational display appears.

### Calling up the menu via the context menu

1. Open the context menu.
2. Press  to navigate to the desired menu.
3. Press  to confirm the selection.
  - ↳ The selected menu opens.

### 8.3.6 Navigating and selecting from list

Different operating elements are used to navigate through the operating menu. The navigation path is displayed on the left in the header. Icons are displayed in front of the individual menus. These icons are also shown in the header during navigation.

**i** For an explanation of the navigation view with symbols and operating elements → 50

**Example: Setting the number of displayed measured values to "2 values"**

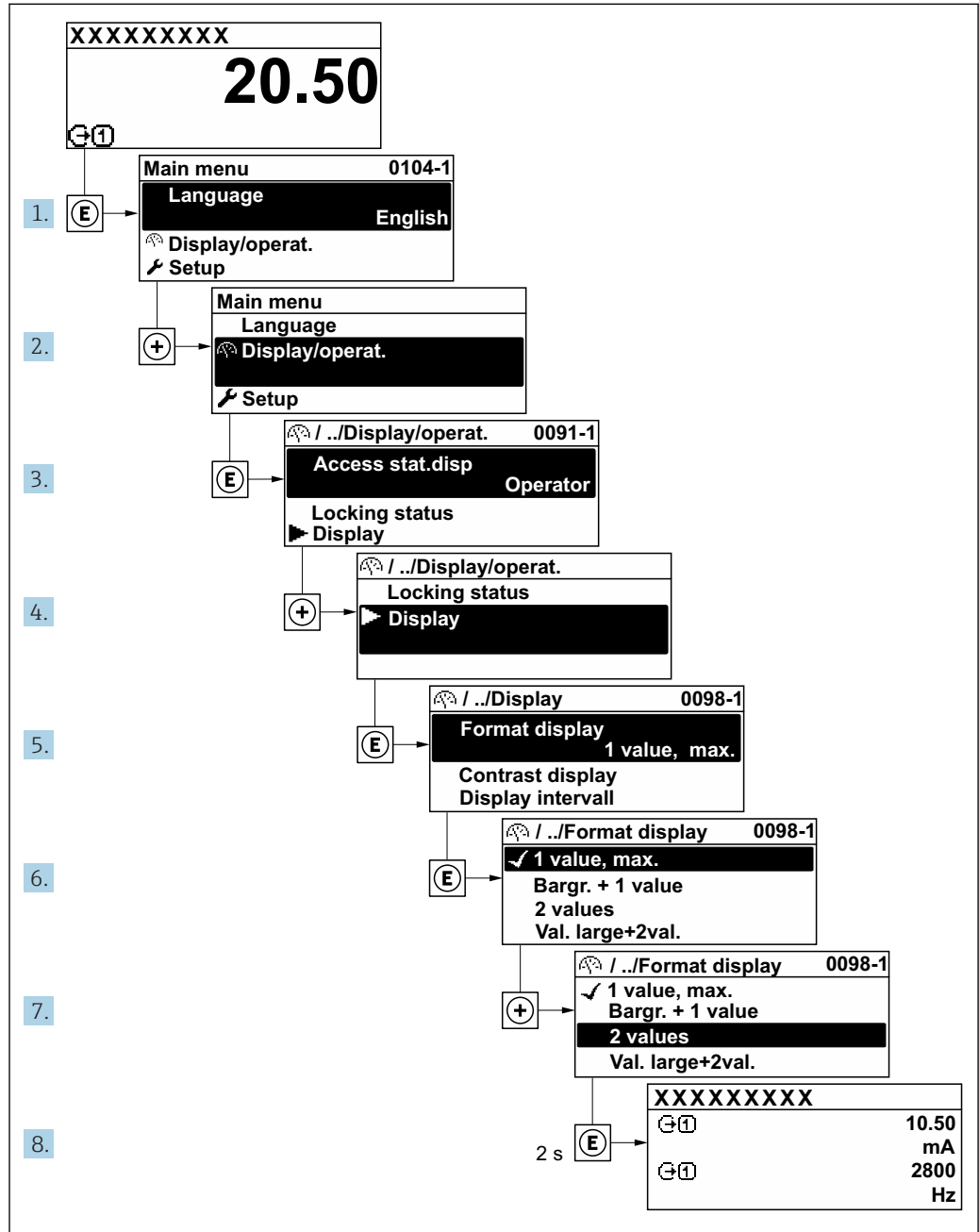

A0029562-EN

### 8.3.7 Calling the parameter directly

A parameter number is assigned to every parameter to be able to access a parameter directly via the onsite display. Entering this access code in the **Direct access** parameter calls up the desired parameter directly.

#### Navigation path

Expert → Direct access



The direct access code consists of a 4-digit number and the channel number, which identifies the channel of a process variable: e.g. 0914-1. In the navigation view, this appears on the right-hand side in the header of the selected parameter.

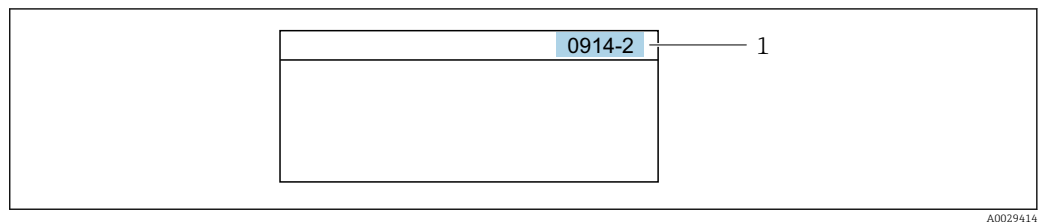

1 Direct access code

Note the following when entering the direct access code:

- The leading zeros in the direct access code do not have to be entered.  
Example: Input of "914" instead of "0914"
- If no channel number is entered, channel 1 is jumped to automatically.  
Example: Enter 0914 → **Assign process variable** parameter
- If a different channel is jumped to: Enter the direct access code with the corresponding channel number.  
Example: Enter 0914-2 → **Assign process variable** parameter



For the direct access codes of the individual parameters, see the "Description of Device Parameters" document for the device

### 8.3.8 Calling up help text

Help text is available for some parameters and can be called up from the navigation view. The help text provides a brief explanation of the parameter function and thereby supports swift and safe commissioning.



#### Calling up and closing the help text

The user is in the navigation view and the selection bar is on a parameter.

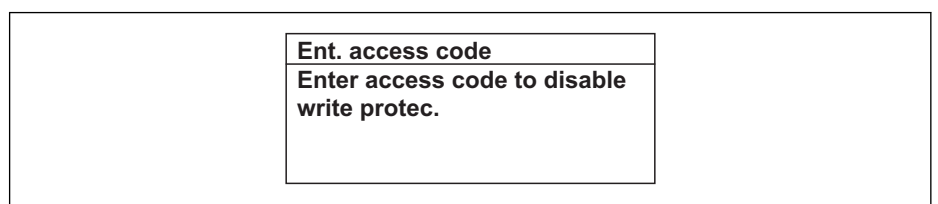
1. Press  for 2 s.  
↳ The help text for the selected parameter opens.



23 Example: Help text for parameter "Enter access code"

2. Press  +  simultaneously.  
↳ The help text is closed.

### 8.3.9 Changing the parameters

**i** For a description of the editing display - consisting of text editor and numeric editor - with symbols → 52, for a description of the operating elements → 54

**Example:** Changing the tag name in the "Tag description" parameter from 001-FT-101 to 001-FT-102

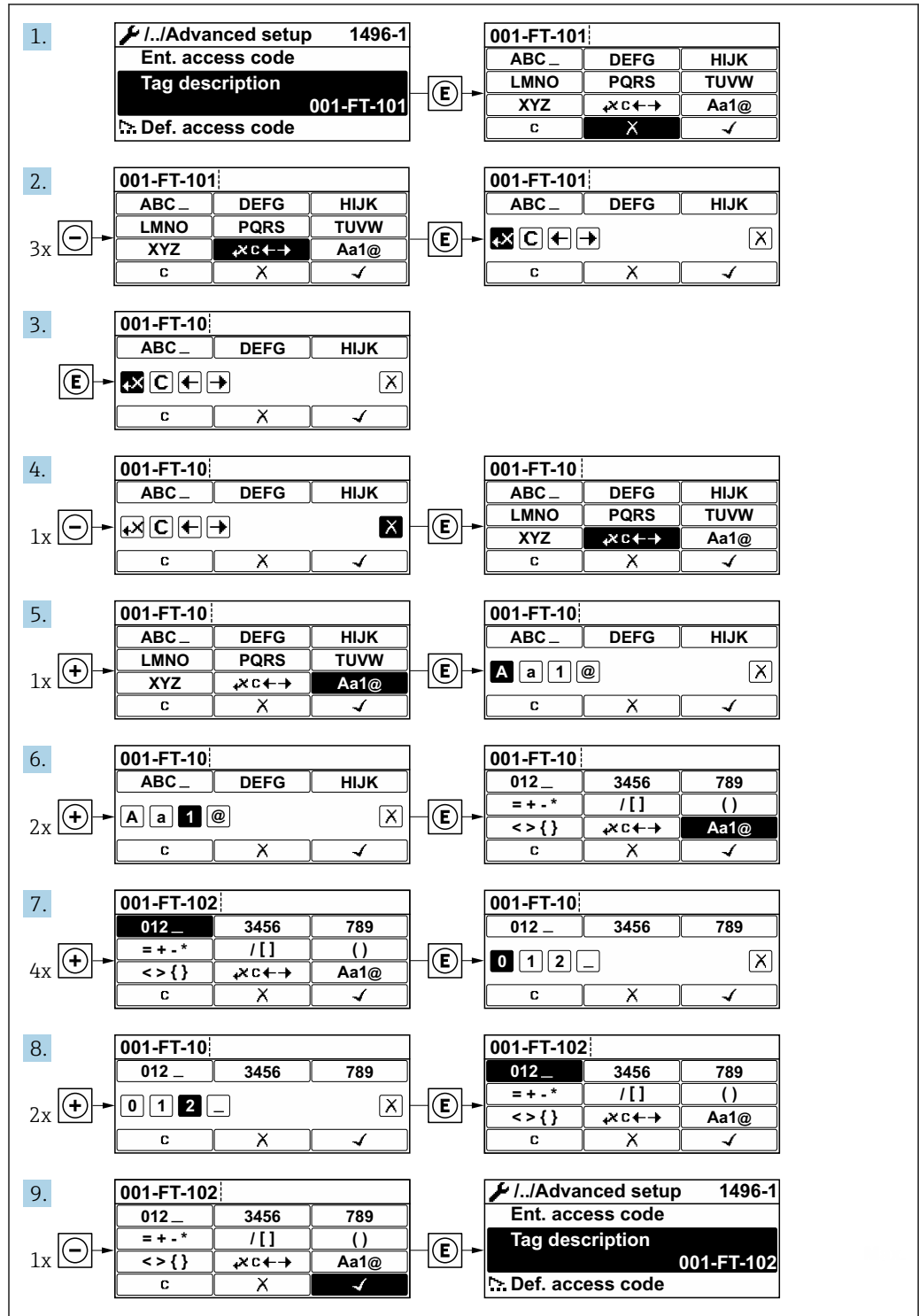

A0029563-EN

A message is displayed if the value entered is outside the permitted value range.

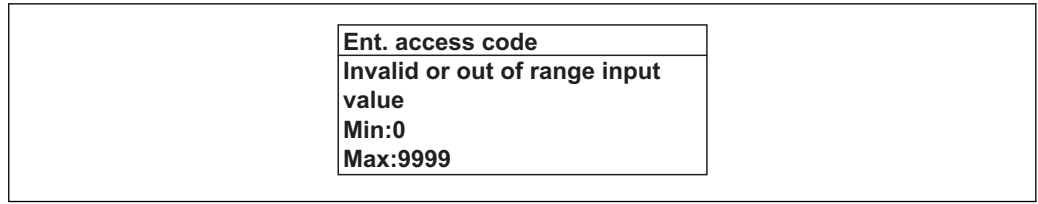

A0014049-EN

### 8.3.10 User roles and related access authorization

The two user roles "Operator" and "Maintenance" have different write access to the parameters if the customer defines a user-specific access code. This protects the device configuration via the local display from unauthorized access → 103.

*Access authorization to parameters: "Operator" user role*

Access code status	Read access	Write access
An access code has not yet been defined (factory setting).	✓	✓
After an access code has been defined.	✓	-- <sup>1)</sup>

- 1) Despite the defined access code, certain parameters can always be modified and thus are excepted from the write protection, as they do not affect the measurement. Refer to the "Write protection via access code" section

*Access authorization to parameters: "Maintenance" user role*

Access code status	Read access	Write access
An access code has not yet been defined (factory setting).	✓	✓
After an access code has been defined.	✓	✓ <sup>1)</sup>

- 1) If an incorrect access code is entered, the user obtains the access rights of the "Operator" user role.

The user role with which the user is currently logged on is indicated by the **Access status display** parameter. Navigation path: Operation → Access status display

### 8.3.11 Disabling write protection via access code

If the -symbol appears on the local display in front of a parameter, the parameter is write-protected by a user-specific access code and its value cannot be changed at the moment using local operation → 103.

Parameter write protection via local operation can be disabled by entering the user-specific access code in the **Enter access code** parameter via the respective access option.

1. After you press , the input prompt for the access code appears.
2. Enter the access code.
  - ↳ The -symbol in front of the parameters disappears; all previously write-protected parameters are now re-enabled.

### 8.3.12 Enabling and disabling the keypad lock

The keypad lock makes it possible to block access to the entire operating menu via local operation. As a result, it is no longer possible to navigate through the operating menu or change the values of individual parameters. Users can only read the measured values on the operational display.

### Local operation with touch control

The keypad lock is switched on and off via the context menu.

#### Switching on the keypad lock

The keypad lock is switched on automatically:

- Each time the device is restarted.
- If the device has not been operated for longer than one minute in the measured value display.

1. The device is in the measured value display.  
Press  for at least 2 seconds.  
↳ A context menu appears.
2. In the context menu, select the **Keylock on** option.  
↳ The keypad lock is switched on.

 If the user attempts to access the operating menu while the keypad lock is active, the message **Keylock on** appears.

#### Switching off the keypad lock



1. The keypad lock is switched on.  
Press  for at least 2 seconds.  
↳ A context menu appears.
2. In the context menu, select the **Keylock off** option.  
↳ The keypad lock is switched off.

## 8.4 Access to the operating menu via the Web browser

### 8.4.1 Function range

Thanks to the integrated Web server, the device can be operated and configured via a Web browser and via a service interface (CDI-RJ45) or via a WLAN interface. The structure of the operating menu is the same as for the local display. In addition to the measured values, status information on the device is also displayed and allows the user to monitor the status of the device. Furthermore the device data can be managed and the network parameters can be configured.

A device that has a WLAN interface (can be ordered as an option) is required for the WLAN connection: order code for "Display", option **W1** "WLAN display": 4-line, illuminated; touch control + WLAN. The device acts as an Access Point and enables communication by computer or a mobile handheld terminal.

 For additional information on the Web server, refer to the Special Documentation for the device →  158

### 8.4.2 Prerequisites



#### Computer hardware

Hardware	Interface	
	CDI-RJ45	WLAN
Interface	The computer must have an RJ45 interface.	The operating unit must have a WLAN interface.
Connection	Standard Ethernet cable with RJ45 connector.	Connection via Wireless LAN.
Screen	Recommended size: ≥12" (depends on the screen resolution)	

Computer software





Software	Interface	
	CDI-RJ45	WLAN
Recommended operating systems	<ul style="list-style-type: none"> <li>▪ Microsoft Windows 7 or higher.</li> <li>▪ Mobile operating systems:                             <ul style="list-style-type: none"> <li>- iOS</li> <li>- Android</li> </ul> </li> </ul> <p> Microsoft Windows XP is supported.</p>	
Web browsers supported	<ul style="list-style-type: none"> <li>▪ Microsoft Internet Explorer 8 or higher</li> <li>▪ Microsoft Edge</li> <li>▪ Mozilla Firefox</li> <li>▪ Google Chrome</li> <li>▪ Safari</li> </ul>	

Computer settings

Settings	Interface	
	CDI-RJ45	WLAN
User rights	Appropriate user rights (e.g. administrator rights) for TCP/IP and proxy server settings are necessary (for adjusting the IP address, subnet mask etc.).	
Proxy server settings of the Web browser	The Web browser setting <i>Use a Proxy Server for Your LAN</i> must be <b>deselected</b> .	
JavaScript	<p>JavaScript must be enabled.</p> <p> If JavaScript cannot be enabled: enter <code>http://192.168.1.212/basic.html</code> in the address line of the Web browser. A fully functional but simplified version of the operating menu structure starts in the Web browser.</p> <p> When installing a new firmware version: To enable correct data display, clear the temporary memory (cache) of the Web browser under <b>Internet options</b>.</p>	
Network connections	Only the active network connections to the measuring device should be used.	
	Switch off all other network connections such as WLAN.	Switch off all other network connections.

 In the event of connection problems: →  114

Measuring device

Device	Interface	
	CDI-RJ45	WLAN
Measuring device	The measuring device has an RJ45 interface.	The measuring device has a WLAN antenna: Transmitter with integrated WLAN antenna
Web server	<p>Web server must be enabled; factory setting: ON</p> <p> For information on enabling the Web server →  65</p>	<p>Web server and WLAN must be enabled; factory setting: ON</p> <p> For information on enabling the Web server →  65</p>

### 8.4.3 Establishing a connection

#### Via service interface (CDI-RJ45)

*Preparing the measuring device*

*Configuring the Internet protocol of the computer*

The following information refers to the default Ethernet settings of the device.

IP address of the device: 192.168.1.212 (factory setting)

1. Switch on the measuring device.
2. Connect to the computer using a cable .
3. If a 2nd network card is not used, close all the applications on the notebook.
  - ↳ Applications requiring Internet or a network, such as e-mail, SAP applications, Internet or Windows Explorer.
4. Close any open Internet browsers.
5. Configure the properties of the Internet protocol (TCP/IP) as defined in the table:

<b>IP address</b>	192.168.1.XXX; for XXX all numerical sequences except: 0, 212 and 255 → e.g. 192.168.1.213
<b>Subnet mask</b>	255.255.255.0
<b>Default gateway</b>	192.168.1.212 or leave cells empty

#### Via WLAN interface

*Configuring the Internet protocol of the mobile terminal*

##### **NOTICE**

**If the WLAN connection is lost during the configuration, settings made may be lost.**

- ▶ Make sure that the WLAN connection is not disconnected while configuring the device.

##### **NOTICE**

**In principle, avoid simultaneous access to the measuring device via the service interface (CDI-RJ45) and the WLAN interface from the same mobile terminal. This could cause a network conflict.**

- ▶ Only activate one service interface (CDI-RJ45 service interface or WLAN interface).
- ▶ If simultaneous communication is necessary: configure different IP address ranges, e.g. 192.168.0.1 (WLAN interface) and 192.168.1.212 (CDI-RJ45 service interface).

*Preparing the mobile terminal*

- ▶ Enable WLAN reception on the mobile terminal.

*Establishing a connection from the mobile terminal to the measuring device*

1. In the WLAN settings of the mobile terminal:  
Select the measuring device using the SSID (e.g. EH\_Promag\_\_A802000).
2. If necessary, select the WPA2 encryption method.
3. Enter the password: serial number of the measuring device ex-works (e.g. L100A802000).
  - ↳ LED on display module flashes: it is now possible to operate the measuring device with the Web browser, FieldCare or DeviceCare.

 The serial number can be found on the nameplate.

*Disconnecting*

- ▶ After configuring the device:  
 Terminate the WLAN connection between the operating unit and measuring device.

**Starting the Web browser**

1. Start the Web browser on the computer.
2. Enter the IP address of the Web server in the address line of the Web browser:  
 192.168.1.212  
 ↳ The login page appears.

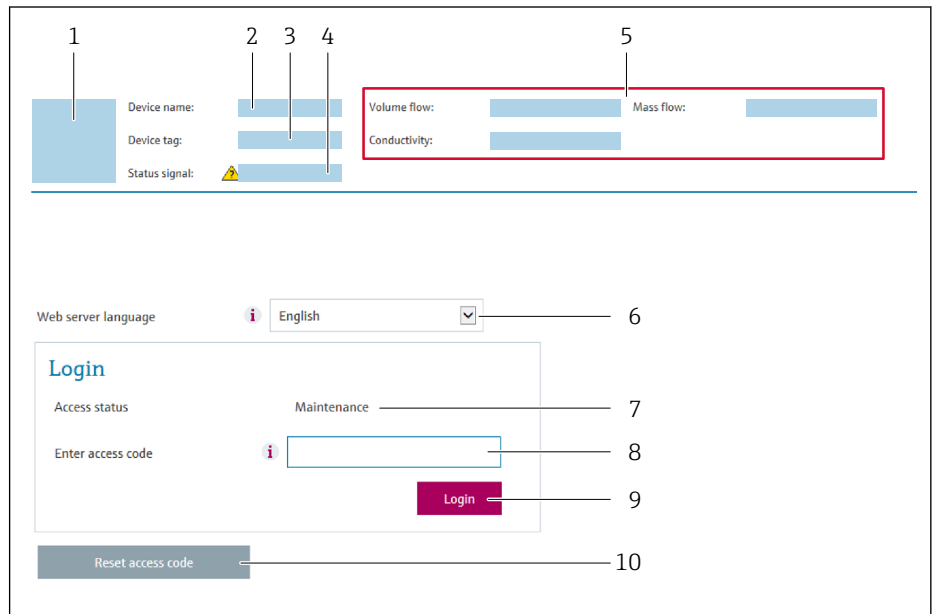

A0029417

- 1 Picture of device
- 2 Device name
- 3 Device tag (→ 77)
- 4 Status signal
- 5 Current measured values
- 6 Operating language
- 7 User role
- 8 Access code
- 9 Login
- 10 Reset access code (→ 100)

**i** If a login page does not appear, or if the page is incomplete → 114

**8.4.4 Logging on**

1. Select the preferred operating language for the Web browser.
2. Enter the user-specific access code.
3. Press **OK** to confirm your entry.

<b>Access code</b>	0000 (factory setting); can be changed by customer
--------------------	--

**i** If no action is performed for 10 minutes, the Web browser automatically returns to the login page.

### 8.4.5 User interface

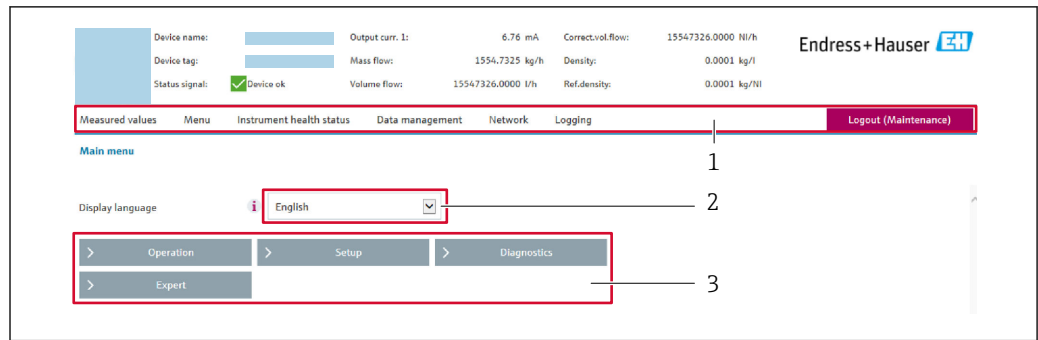

A0029418

- 1 Function row
- 2 Operating language
- 3 Navigation area

#### Header

The following information appears in the header:

- Device tag
- Device status with status signal → 119
- Current measured values

#### Function row

Functions	Meaning
Measured values	Displays the measured values of the measuring device
Menu	<ul style="list-style-type: none"> <li>■ Access to the operating menu from the measuring device</li> <li>■ The structure of the operating menu is the same as for the local display</li> </ul> For detailed information on the structure of the operating menu, see the Operating Instructions for the measuring device
Device status	Displays the diagnostic messages currently pending, listed in order of priority
Data management	<ul style="list-style-type: none"> <li>■ Data exchange between PC and measuring device:                             <ul style="list-style-type: none"> <li>- Load the configuration from the measuring device (XML format, save configuration)</li> <li>- Save the configuration to the measuring device (XML format, restore configuration)</li> <li>- Export the event list (.csv file)</li> <li>- Export parameter settings (.csv file, create documentation of the measuring point configuration)</li> <li>- Export the Heartbeat verification log (PDF file, only available with the "Heartbeat Verification" application package)</li> </ul> </li> <li>■ Flashing a firmware version</li> </ul>
Network configuration	Configuration and checking of all the parameters required for establishing the connection to the measuring device: <ul style="list-style-type: none"> <li>■ Network settings (e.g. IP address, MAC address)</li> <li>■ Device information (e.g. serial number, firmware version)</li> </ul>
Logout	End the operation and call up the login page

#### Navigation area

If a function is selected in the function bar, the submenus of the function open in the navigation area. The user can now navigate through the menu structure.



**Working area**

Depending on the selected function and the related submenus, various actions can be performed in this area:

- Configuring parameters
- Reading measured values
- Calling up help text
- Starting an upload/download

**8.4.6 Disabling the Web server**

The Web server of the measuring device can be switched on and off as required using the **Web server functionality** parameter.

**Navigation**

"Expert" menu → Communication → Web server

**Parameter overview with brief description**

Parameter	Description	Selection	Factory setting
Web server functionality	Switch the Web server on and off.	<ul style="list-style-type: none"> <li>▪ Off</li> <li>▪ On</li> </ul>	On

**Function scope of the "Web server functionality" parameter**

Option	Description
Off	<ul style="list-style-type: none"> <li>▪ The web server is completely disabled.</li> <li>▪ Port 80 is locked.</li> </ul>
On	<ul style="list-style-type: none"> <li>▪ The complete functionality of the web server is available.</li> <li>▪ JavaScript is used.</li> <li>▪ The password is transferred in an encrypted state.</li> <li>▪ Any change to the password is also transferred in an encrypted state.</li> </ul>

**Enabling the Web server**

If the Web server is disabled it can only be re-enabled with the **Web server functionality** parameter via the following operating options:

- Via local display
- Via Bedientool "FieldCare"
- Via "DeviceCare" operating tool

**8.4.7 Logging out**

 Before logging out, perform a data backup via the **Data management** function (upload configuration from device) if necessary.

1. Select the **Logout** entry in the function row.
  - ↳ The home page with the Login box appears.
2. Close the Web browser.
3. If no longer needed:
  - Reset modified properties of the Internet protocol (TCP/IP) →  62.

**8.5 Access to the operating menu via the operating tool**

The structure of the operating menu in the operating tools is the same as for operation via the local display.

### 8.5.1 Connecting the operating tool

#### Via service interface (CDI-RJ45)

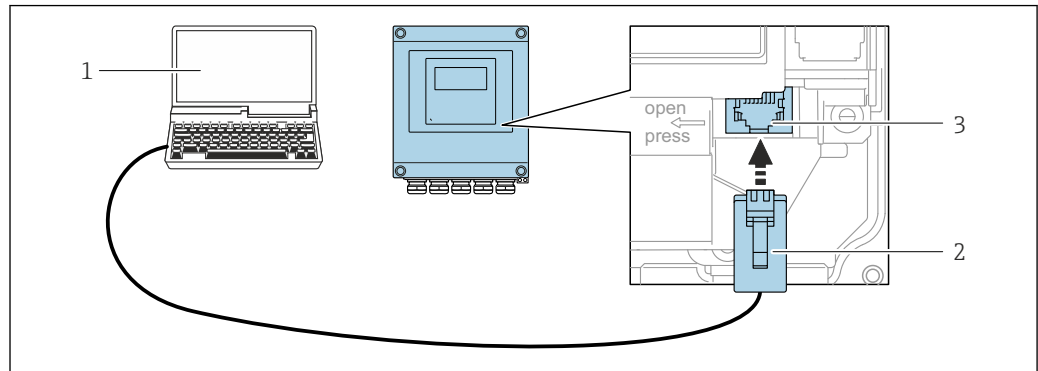

A0029163

24 Connection via service interface (CDI-RJ45)

- 1 Computer with Web browser (e.g. Microsoft Internet Explorer, Microsoft Edge) for accessing the integrated device Web server or with "FieldCare", "DeviceCare" operating tool with COM DTM "CDI Communication TCP/IP"
- 2 Standard Ethernet connecting cable with RJ45 plug
- 3 Service interface (CDI-RJ45) of the measuring device with access to the integrated Web server

#### Via WLAN interface

The optional WLAN interface is available on the following device version:

Order code for "Display", option **W1** "WLAN display":

4-line, illuminated, graphic display; touch control + WLAN

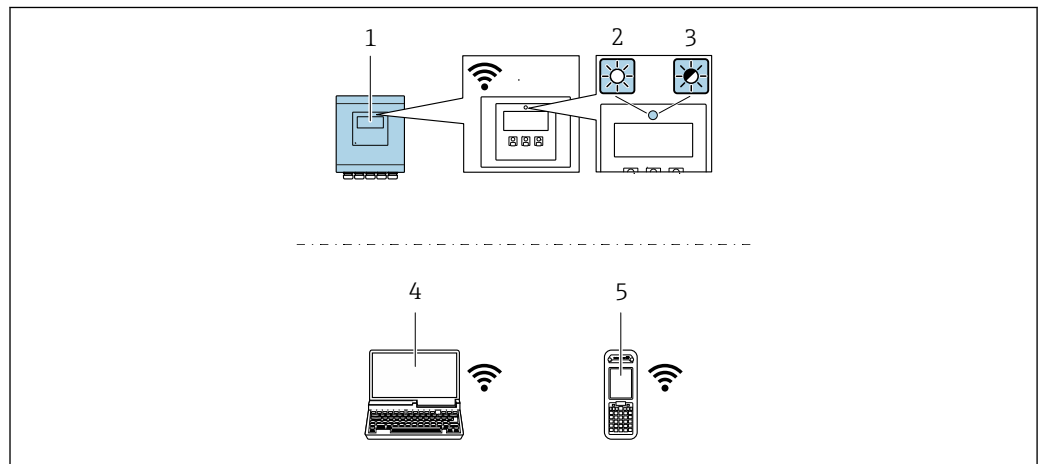

A0032079

- 1 Transmitter with integrated WLAN antenna
- 2 LED lit constantly: WLAN reception is enabled on measuring device
- 3 LED flashing: WLAN connection established between operating unit and measuring device
- 4 Computer with WLAN interface and Web browser (e.g. Microsoft Internet Explorer, Microsoft Edge) for accessing the integrated device Web server or with operating tool (e.g. FieldCare, DeviceCare)
- 5 Mobile handheld terminal with WLAN interface and Web browser (e.g. Microsoft Internet Explorer, Microsoft Edge) for accessing the integrated device Web server or operating tool (e.g. FieldCare, DeviceCare)

<b>Wireless LAN</b>	IEEE 802.11 b/g (2.4 GHz) WLAN
<b>Encryption</b>	WPA2 PSK/TKIP AES-128
<b>Configurable channels</b>	1 to 11
<b>Function</b>	Access point with DHCP
<b>Range with integrated antenna</b>	Max. 10 m (32 ft)

*Configuring the Internet protocol of the mobile terminal***NOTICE**

**If the WLAN connection is lost during the configuration, settings made may be lost.**

- ▶ Make sure that the WLAN connection is not disconnected while configuring the device.

**NOTICE**

**In principle, avoid simultaneous access to the measuring device via the service interface (CDI-RJ45) and the WLAN interface from the same mobile terminal. This could cause a network conflict.**

- ▶ Only activate one service interface (CDI-RJ45 service interface or WLAN interface).
- ▶ If simultaneous communication is necessary: configure different IP address ranges, e.g. 192.168.0.1 (WLAN interface) and 192.168.1.212 (CDI-RJ45 service interface).

*Preparing the mobile terminal*

- ▶ Enable WLAN reception on the mobile terminal.

*Establishing a connection from the mobile terminal to the measuring device*

1. In the WLAN settings of the mobile terminal:  
Select the measuring device using the SSID (e.g. EH\_Promag\_\_A802000).
2. If necessary, select the WPA2 encryption method.
3. Enter the password: serial number of the measuring device ex-works (e.g. L100A802000).  
↳ LED on display module flashes: it is now possible to operate the measuring device with the Web browser, FieldCare or DeviceCare.



The serial number can be found on the nameplate.

*Disconnecting*

- ▶ After configuring the device:  
Terminate the WLAN connection between the operating unit and measuring device.

**8.5.2 Field Xpert SFX350, SFX370****Function scope**

Field Xpert SFX350 and Field Xpert SFX370 are mobile computers for commissioning and maintenance. They enable efficient device configuration and diagnostics for HART and FOUNDATION fieldbus devices in the **non-Ex area** (SFX350, SFX370) and the **Ex area** (SFX370).



For details, see Operating Instructions BA01202S

**Source for device description files**

See data → 71

**8.5.3 FieldCare****Function scope**

FDT-based plant asset management tool from Endress+Hauser. It can configure all smart field devices in a system and helps you manage them. By using the status information, it is also a simple but effective way of checking their status and condition.

Access is via:

- HART protocol
- CDI-RJ45 service interface

Typical functions:

- Configuring parameters of transmitters
- Loading and saving device data (upload/download)
- Documentation of the measuring point
- Visualization of the measured value memory (line recorder) and event logbook



For additional information about FieldCare, see Operating Instructions BA00027S and BA00059S

### Source for device description files

See information →  71

### Establishing a connection

1. Start FieldCare and launch the project.
2. In the network: Add a device.
  - ↳ The **Add device** window opens.
3. Select the **CDI Communication TCP/IP** option from the list and press **OK** to confirm.
4. Right-click **CDI Communication TCP/IP** and select the **Add device** option in the context menu that opens.
5. Select the desired device from the list and press **OK** to confirm.
  - ↳ The **CDI Communication TCP/IP (Configuration)** window opens.
6. Enter the device address in the **IP address** field: 192.168.1.212 and press **Enter** to confirm.
7. Establish the online connection to the device.



For additional information, see Operating Instructions BA00027S and BA00059S

User interface

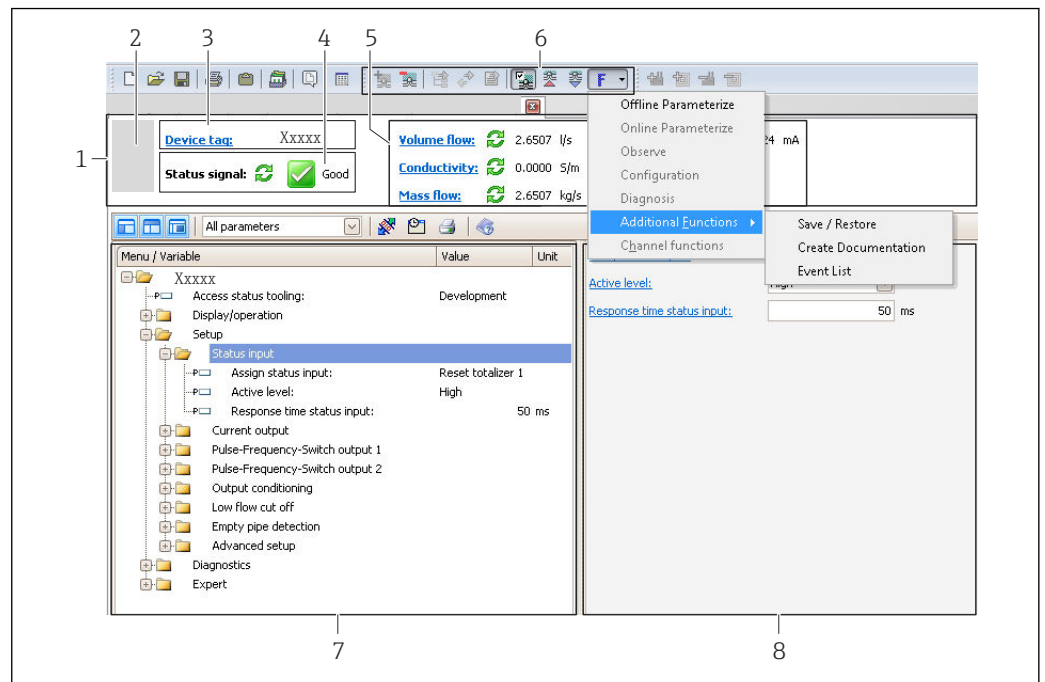

A0021053-EN

- 1 Header
- 2 Picture of device
- 3 Tag name
- 4 Status area with status signal → 119
- 6 Display area for current measured values
- 5 Edit toolbar with additional functions such as save/restore, event list and create documentation
- 7 Navigation area with operating menu structure
- 8 Working area

### 8.5.4 DeviceCare

#### Function scope

Tool to connect and configure Endress+Hauser field devices.

The fastest way to configure Endress+Hauser field devices is with the dedicated "DeviceCare" tool. Together with the device type managers (DTMs) it presents a convenient, comprehensive solution.

 For details, see Innovation Brochure IN01047S

#### Source for device description files

See information →  71

### 8.5.5 AMS Device Manager

#### Function scope

Program from Emerson Process Management for operating and configuring measuring devices via HART protocol.

#### Source for device description files

See data →  71

## 8.5.6 SIMATIC PDM

### Function scope

SIMATIC PDM is a standardized, manufacturer-independent program from Siemens for the operation, configuration, maintenance and diagnosis of intelligent field devices via HART protocol.

### Source for device description files

See data →  71

## 8.5.7 Field Communicator 475

### Function scope

Industrial handheld terminal from Emerson Process Management for remote configuration and measured value display via HART protocol.

### Source for device description files

See data →  71

## 9 System integration

### 9.1 Overview of device description files

#### 9.1.1 Current version data for the device

Firmware version	02.00.zz	<ul style="list-style-type: none"> <li>▪ On the title page of the Operating instructions</li> <li>▪ On the transmitter nameplate</li> <li>▪ Firmware version Diagnostics → Device information → Firmware version</li> </ul>
Release date of firmware version	11.2016	---
Manufacturer ID	0x11	Manufacturer ID Diagnostics → Device information → Manufacturer ID
Device type ID	0x69	Device type Diagnostics → Device information → Device type
HART protocol revision	7	---
Device revision	8	<ul style="list-style-type: none"> <li>▪ On the transmitter nameplate</li> <li>▪ Device revision Diagnostics → Device information → Device revision</li> </ul>

 For an overview of the different firmware versions for the device →  131

#### 9.1.2 Operating tools

The suitable device description file for the individual operating tools is listed in the table below, along with information on where the file can be acquired.

Operating tool via HART protocol	Sources for obtaining device descriptions
FieldCare	<ul style="list-style-type: none"> <li>▪ <a href="http://www.endress.com">www.endress.com</a> → Download Area</li> <li>▪ CD-ROM (contact Endress+Hauser)</li> <li>▪ DVD (contact Endress+Hauser)</li> </ul>
DeviceCare	<ul style="list-style-type: none"> <li>▪ <a href="http://www.endress.com">www.endress.com</a> → Download Area</li> <li>▪ CD-ROM (contact Endress+Hauser)</li> <li>▪ DVD (contact Endress+Hauser)</li> </ul>
<ul style="list-style-type: none"> <li>▪ Field Xpert SFX350</li> <li>▪ Field Xpert SFX370</li> </ul>	Use update function of handheld terminal
AMS Device Manager (Emerson Process Management)	<a href="http://www.endress.com">www.endress.com</a> → Download Area
SIMATIC PDM (Siemens)	<a href="http://www.endress.com">www.endress.com</a> → Download Area
Field Communicator 475 (Emerson Process Management)	Use update function of handheld terminal

## 9.2 Measured variables via HART protocol

The following measured variables (HART device variables) are assigned to the dynamic variables at the factory:

Dynamic variables	Measured values (HART device variables)
Primary dynamic variable (PV)	Volume flow
Secondary dynamic variable (SV)	Totalizer 1
Tertiary dynamic variable (TV)	Totalizer 2
Quaternary dynamic variable (QV)	Totalizer 3

The assignment of the measured variables to the dynamic variables can be modified and assigned as desired via local operation and the operating tool using the following parameters:

- Expert → Communication → HART output → Output → Assign PV
- Expert → Communication → HART output → Output → Assign SV
- Expert → Communication → HART output → Output → Assign TV
- Expert → Communication → HART output → Output → Assign QV

The following measured variables can be assigned to the dynamic variables:

#### Measured variables for PV (primary dynamic variable)

- Off
- Volume flow
- Mass flow
- Flow velocity
- Electronic temperature

#### Measured variables for SV, TV, QV (secondary, tertiary and quaternary dynamic variable)

- Volume flow
- Mass flow
- Electronic temperature
- Totalizer 1
- Totalizer 2
- Totalizer 3

#### Device variables

The device variables are permanently assigned. A maximum of 8 device variables can be transmitted:

- 0 = volume flow
- 1 = mass flow
- 2 = corrected volume flow
- 3 = flow velocity
- 6 = temperature
- 7 = electronic temperature
- 9 = totalizer 1
- 10 = totalizer 2
- 11 = totalizer 3

## 9.3 Other settings

Burst mode functionality in accordance with HART 7 Specification:



**Navigation**

"Expert" menu → Communication → HART output → Burst configuration → Burst configuration 1 to n

▶ Burst configuration

▶ Burst configuration 1 to n

Burst mode 1 to n	→  73
Burst command 1 to n	→  73
Burst variable 0	→  74
Burst variable 1	→  74
Burst variable 2	→  74
Burst variable 3	→  74
Burst variable 4	→  74
Burst variable 5	→  74
Burst variable 6	→  74
Burst variable 7	→  74
Burst trigger mode	→  74
Burst trigger level	→  74
Min. update period	→  74
Max. update period	→  74

**Parameter overview with brief description**

Parameter	Description	Selection / User entry	Factory setting
Burst mode 1 to n	Activate the HART burst mode for burst message X.	<ul style="list-style-type: none"> <li>■ Off</li> <li>■ On</li> </ul>	Off
Burst command 1 to n	Select the HART command that is sent to the HART master.	<ul style="list-style-type: none"> <li>■ Command 1</li> <li>■ Command 2</li> <li>■ Command 3</li> <li>■ Command 9</li> <li>■ Command 33</li> <li>■ Command 48</li> </ul>	Command 2

Parameter	Description	Selection / User entry	Factory setting
Burst variable 0	For HART command 9 and 33: select the HART device variable or the process variable.	<ul style="list-style-type: none"> <li>■ Volume flow</li> <li>■ Mass flow</li> <li>■ Corrected volume flow</li> <li>■ Flow velocity</li> <li>■ Electronic temperature</li> <li>■ Totalizer 1</li> <li>■ Totalizer 2</li> <li>■ Totalizer 3</li> <li>■ Density</li> <li>■ HART input</li> <li>■ Percent of range</li> <li>■ Measured current</li> <li>■ Primary variable (PV)</li> <li>■ Secondary variable (SV)</li> <li>■ Tertiary variable (TV)</li> <li>■ Quaternary variable (QV)</li> <li>■ Not used</li> </ul>	Volume flow
Burst variable 1	For HART command 9 and 33: select the HART device variable or the process variable.	See the <b>Burst variable 0</b> parameter.	Not used
Burst variable 2	For HART command 9 and 33: select the HART device variable or the process variable.	See the <b>Burst variable 0</b> parameter.	Not used
Burst variable 3	For HART command 9 and 33: select the HART device variable or the process variable.	See the <b>Burst variable 0</b> parameter.	Not used
Burst variable 4	For HART command 9 and 33: select the HART device variable or the process variable.	See the <b>Burst variable 0</b> parameter.	Not used
Burst variable 5	For HART command 9 and 33: select the HART device variable or the process variable.	See the <b>Burst variable 0</b> parameter.	Not used
Burst variable 6	For HART command 9 and 33: select the HART device variable or the process variable.	See the <b>Burst variable 0</b> parameter.	Not used
Burst variable 7	For HART command 9 and 33: select the HART device variable or the process variable.	See the <b>Burst variable 0</b> parameter.	Not used
Burst trigger mode	Select the event that triggers burst message X.	<ul style="list-style-type: none"> <li>■ Continuous</li> <li>■ Window</li> <li>■ Rising</li> <li>■ Falling</li> <li>■ On change</li> </ul>	Continuous
Burst trigger level	Enter the burst trigger value. Together with the option selected in the <b>Burst trigger mode</b> parameter the burst trigger value determines the time of burst message X.	Signed floating-point number	–
Min. update period	Enter the minimum time span between two burst commands of burst message X.	Positive integer	1 000 ms
Max. update period	Enter the maximum time span between two burst commands of burst message X.	Positive integer	2 000 ms

## 10 Commissioning

### 10.1 Function check

Before commissioning the measuring device:

- ▶ Make sure that the post-installation and post-connection checks have been performed.
- "Post-installation check" checklist → 32
- "Post-connection check" checklist → 45

### 10.2 Switching on the measuring device

- ▶ After a successful function check, switch on the measuring device.
  - ↳ After a successful startup, the local display switches automatically from the startup display to the operational display.

If nothing appears on the local display or a diagnostic message is displayed, refer to the section on "Diagnostics and troubleshooting" → 113.

### 10.3 Setting the operating language

Factory setting: English or ordered local language

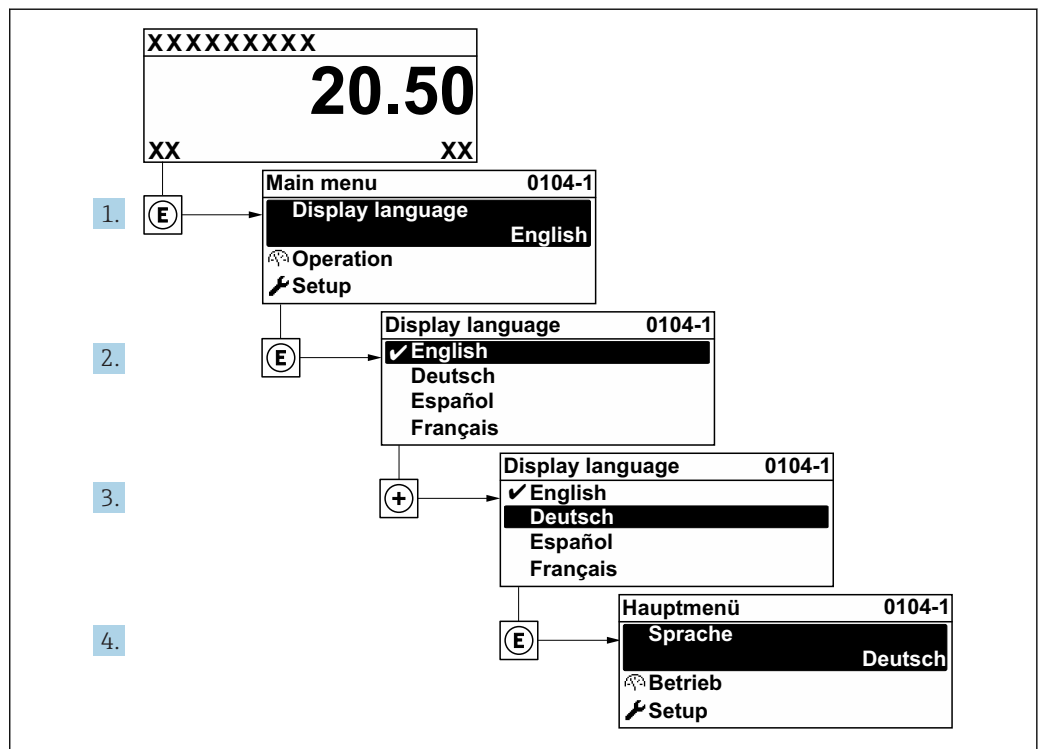

25 Taking the example of the local display

A0029420

### 10.4 Configuring the measuring device

- The **Setup** menu with its guided wizards contains all the parameters needed for standard operation.
- Navigation to the **Setup** menu

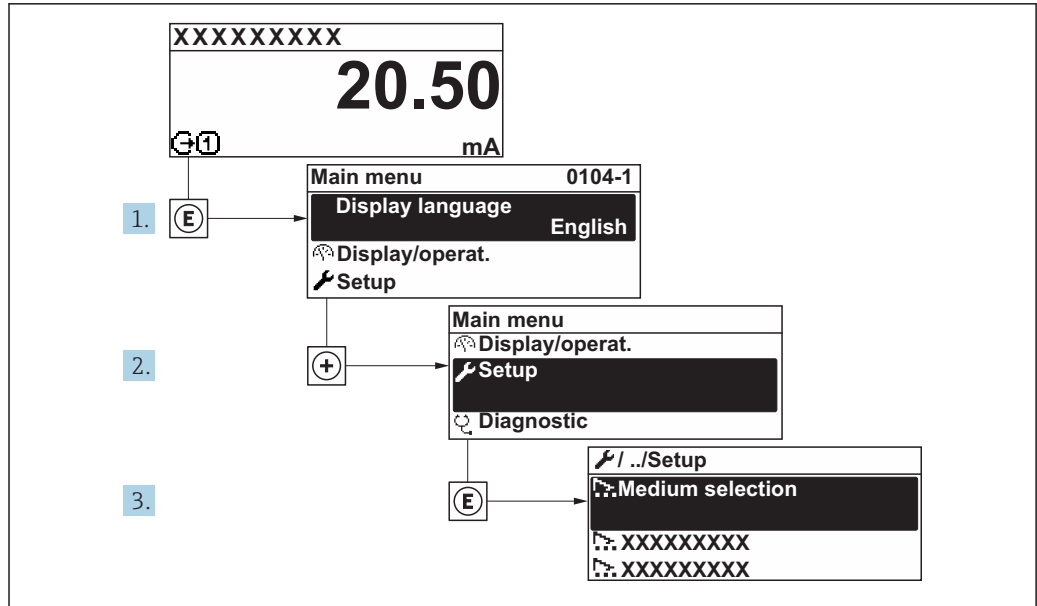

A0032222-EN

26 Taking the example of the local display

### Navigation

"Setup" menu

**Setup**

Device tag	→ 77
▶ System units	→ 77
▶ Status input 1	→ 78
▶ Current output 1	→ 80
▶ Pulse/frequency/switch output	→ 81
▶ Display	→ 86
▶ Low flow cut off	→ 89
▶ Empty pipe detection	→ 91
▶ Advanced setup	→ 92

#### 10.4.1 Defining the tag name

To enable fast identification of the measuring point within the system, you can enter a unique designation using the **Device tag** parameter and thus change the factory setting.

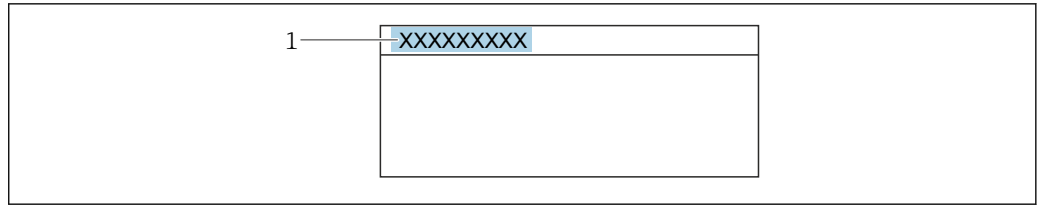

A0029422

27 Header of the operational display with tag name

1 Tag name

**i** Enter the tag name in the "FieldCare" operating tool → 69

**Navigation**

"Setup" menu → Device tag

**Parameter overview with brief description**

Parameter	Description	User entry	Factory setting
Device tag	Enter the name for the measuring point.	Max. 32 characters, such as letters, numbers or special characters (e.g. @, %, /).	Promag

**10.4.2 Setting the system units**

In the **System units** submenu the units of all the measured values can be set.

**i** Depending on the device version, not all submenus and parameters are available in every device. The selection can vary depending on the order code.

**Navigation**

"Setup" menu → System units

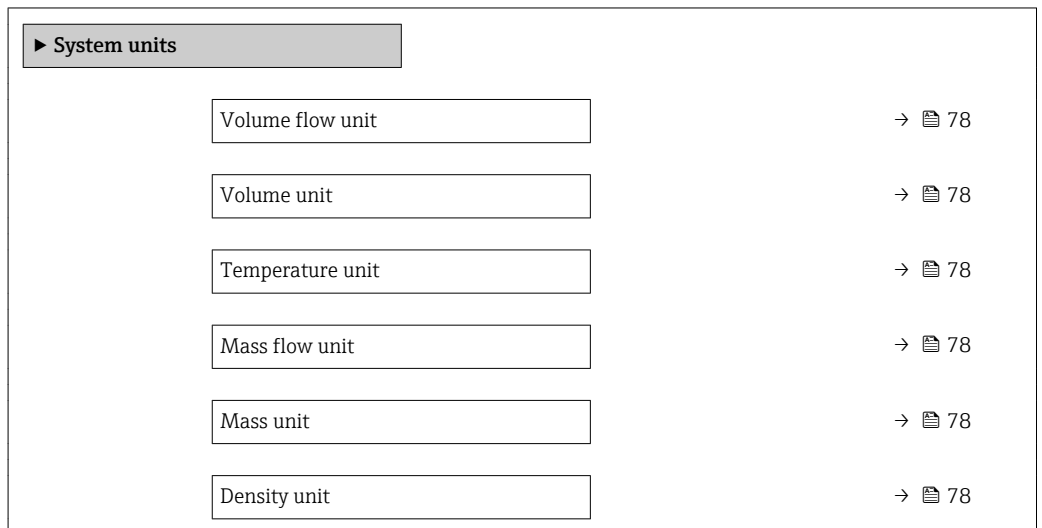

### Parameter overview with brief description

Parameter	Description	Selection	Factory setting
Volume flow unit	Select volume flow unit. <i>Result</i> The selected unit applies for: <ul style="list-style-type: none"> <li>▪ Output</li> <li>▪ Low flow cut off</li> <li>▪ Simulation process variable</li> </ul>	Unit choose list	Country-specific: <ul style="list-style-type: none"> <li>▪ l/h</li> <li>▪ gal/min (us)</li> </ul>
Volume unit	Select volume unit.	Unit choose list	Country-specific: <ul style="list-style-type: none"> <li>▪ m<sup>3</sup></li> <li>▪ gal (us)</li> </ul>
Temperature unit	Select temperature unit. <i>Result</i> The selected unit applies for: <ul style="list-style-type: none"> <li>▪ <b>Maximum value</b> parameter</li> <li>▪ <b>Minimum value</b> parameter</li> </ul>	Unit choose list	Country-specific: <ul style="list-style-type: none"> <li>▪ °C</li> <li>▪ °F</li> </ul>
Mass flow unit	Select mass flow unit. <i>Result</i> The selected unit applies for: <ul style="list-style-type: none"> <li>▪ Output</li> <li>▪ Low flow cut off</li> <li>▪ Simulation process variable</li> </ul>	Unit choose list	Country-specific: <ul style="list-style-type: none"> <li>▪ kg/h</li> <li>▪ lb/min</li> </ul>
Mass unit	Select mass unit.	Unit choose list	Country-specific: <ul style="list-style-type: none"> <li>▪ kg</li> <li>▪ lb</li> </ul>
Density unit	Select density unit. <i>Result</i> The selected unit applies for: <ul style="list-style-type: none"> <li>▪ Output</li> <li>▪ Simulation process variable</li> </ul>	Unit choose list	Country-specific: <ul style="list-style-type: none"> <li>▪ kg/l</li> <li>▪ lb/ft<sup>3</sup></li> </ul>

### 10.4.3 Configuring the status input

The **Status input** submenu guides the user systematically through all the parameters that have to be set for configuring the status input.



The submenu appears only if the device was ordered with a status input .

#### Navigation

"Setup" menu → Status input

#### Structure of the submenu

► Status input	
Assign status input	→ 79
Active level	→ 79
Response time status input	→ 79

**Parameter overview with brief description**

Parameter	Description	Selection / User entry	Factory setting
Assign status input	Select function for the status input.	<ul style="list-style-type: none"> <li>▪ Off</li> <li>▪ Reset totalizer 1</li> <li>▪ Reset totalizer 2</li> <li>▪ Reset totalizer 3</li> <li>▪ Reset all totalizers</li> <li>▪ Flow override</li> </ul>	Off
Active level	Define input signal level at which the assigned function is triggered.	<ul style="list-style-type: none"> <li>▪ High</li> <li>▪ Low</li> </ul>	High
Response time status input	Define the minimum amount of time the input signal level must be present before the selected function is triggered.	5 to 200 ms	50 ms

### 10.4.4 Configuring the current output

The **Current output** wizard guides you systematically through all the parameters that have to be set for configuring the current output.

#### Navigation

"Setup" menu → Current output 1

▶ Current output 1	
Assign current output 1	→ ⓘ 80
Current span	→ ⓘ 80
0/4 mA value	→ ⓘ 80
20 mA value	→ ⓘ 80
Fixed current	→ ⓘ 81
Failure mode	→ ⓘ 81
Failure current	→ ⓘ 81

#### Parameter overview with brief description

Parameter	Prerequisite	Description	Selection / User entry	Factory setting
Assign current output	–	Select process variable for current output.	<ul style="list-style-type: none"> <li>▪ Volume flow</li> <li>▪ Mass flow</li> <li>▪ Corrected volume flow</li> <li>▪ Flow velocity</li> <li>▪ Temperature</li> <li>▪ Electronic temperature</li> </ul>	Volume flow
Current span	–	Select current range for process value output and upper/lower level for alarm signal.	<ul style="list-style-type: none"> <li>▪ 4...20 mA NAMUR</li> <li>▪ 4...20 mA US</li> <li>▪ 4...20 mA</li> <li>▪ 0...20 mA</li> <li>▪ Fixed current</li> </ul>	Country-specific: <ul style="list-style-type: none"> <li>▪ 4...20 mA NAMUR</li> <li>▪ 4...20 mA US</li> </ul>
0/4 mA value	One of the following options is selected in the <b>Current span</b> parameter (→ ⓘ 80): <ul style="list-style-type: none"> <li>▪ 4...20 mA NAMUR</li> <li>▪ 4...20 mA US</li> <li>▪ 4...20 mA</li> <li>▪ 0...20 mA</li> </ul>	Enter 4 mA value.	Signed floating-point number	Country-specific: <ul style="list-style-type: none"> <li>▪ 0 l/h</li> <li>▪ 0 gal/min (us)</li> </ul>
20 mA value	One of the following options is selected in the <b>Current span</b> parameter (→ ⓘ 80): <ul style="list-style-type: none"> <li>▪ 4...20 mA NAMUR</li> <li>▪ 4...20 mA US</li> <li>▪ 4...20 mA</li> <li>▪ 0...20 mA</li> </ul>	Enter 20 mA value.	Signed floating-point number	Depends on country and nominal diameter



Parameter	Prerequisite	Description	Selection / User entry	Factory setting
Fixed current	In the <b>Current span</b> parameter (→ 80), the <b>Fixed current</b> option is selected.	Defines the fixed output current.	0 to 22.5 mA	22.5 mA
Failure mode	One of the following options is selected in the <b>Assign current output</b> parameter (→ 80): <ul style="list-style-type: none"> <li>▪ Volume flow</li> <li>▪ Mass flow</li> <li>▪ Flow velocity</li> <li>▪ Electronic temperature</li> </ul> One of the following options is selected in the <b>Current span</b> parameter (→ 80): <ul style="list-style-type: none"> <li>▪ 4...20 mA NAMUR</li> <li>▪ 4...20 mA US</li> <li>▪ 4...20 mA</li> <li>▪ 0...20 mA</li> </ul>	Define output behavior in alarm condition.	<ul style="list-style-type: none"> <li>▪ Min.</li> <li>▪ Max.</li> <li>▪ Last valid value</li> <li>▪ Actual value</li> <li>▪ Defined value</li> </ul>	Max.
Failure current	In the <b>Failure mode</b> parameter, the <b>Defined value</b> option is selected.	Enter current output value in alarm condition.	0 to 22.5 mA	22.5 mA

### 10.4.5 Configuring the pulse/frequency/switch output

The **Pulse/frequency/switch output** wizard guides you systematically through all the parameters that can be set for configuring the selected output type.

#### Configuring the pulse output

##### Navigation

"Setup" menu → Pulse/frequency/switch output 1 to n

**► Pulse/frequency/switch output 1 to n**

Operating mode	→ 82
Assign pulse output	→ 82
Value per pulse	→ 82
Pulse width	→ 82
Failure mode	→ 82
Invert output signal	→ 82

### Parameter overview with brief description





Parameter	Prerequisite	Description	Selection / User entry	Factory setting
Operating mode	–	Define the output as a pulse, frequency or switch output.	<ul style="list-style-type: none"> <li>▪ Pulse</li> <li>▪ Frequency</li> <li>▪ Switch</li> </ul>	Pulse
Assign pulse output	In the <b>Operating mode</b> parameter, the <b>Pulse</b> option is selected.	Select process variable for pulse output.	<ul style="list-style-type: none"> <li>▪ Off</li> <li>▪ Volume flow</li> <li>▪ Mass flow</li> <li>▪ Corrected volume flow</li> </ul>	Off
Value per pulse	In the <b>Operating mode</b> parameter, the <b>Pulse</b> option is selected and one of the following options is selected in the <b>Assign pulse output</b> parameter (→ 82): <ul style="list-style-type: none"> <li>▪ Mass flow</li> <li>▪ Volume flow</li> </ul>	Enter measured value at which a pulse is output.	Signed floating-point number	Depends on country and nominal diameter
Pulse width	In the <b>Operating mode</b> parameter, the <b>Pulse</b> option is selected and one of the following options is selected in the <b>Assign pulse output</b> parameter (→ 82): <ul style="list-style-type: none"> <li>▪ Mass flow</li> <li>▪ Volume flow</li> </ul>	Define time width of the output pulse.	0.05 to 2 000 ms	100 ms
Failure mode	In the <b>Operating mode</b> parameter, the <b>Pulse</b> option is selected and one of the following options is selected in the <b>Assign pulse output</b> parameter (→ 82): <ul style="list-style-type: none"> <li>▪ Mass flow</li> <li>▪ Volume flow</li> </ul>	Define output behavior in alarm condition.	<ul style="list-style-type: none"> <li>▪ Actual value</li> <li>▪ No pulses</li> </ul>	No pulses
Invert output signal	–	Invert the output signal.	<ul style="list-style-type: none"> <li>▪ No</li> <li>▪ Yes</li> </ul>	No

### Configuring the frequency output





#### Navigation

"Setup" menu → Pulse/frequency/switch output 1 to n

► Pulse/frequency/switch output 1 to n	
Operating mode	→ 83
Assign frequency output	→ 83
Minimum frequency value	→ 83
Maximum frequency value	→ 83
Measuring value at minimum frequency	→ 83

Measuring value at maximum frequency	→  84
Failure mode	→  84
Failure frequency	→  84
Invert output signal	→  84

**Parameter overview with brief description**

Parameter	Prerequisite	Description	Selection / User entry	Factory setting
Operating mode	–	Define the output as a pulse, frequency or switch output.	<ul style="list-style-type: none"> <li>▪ Pulse</li> <li>▪ Frequency</li> <li>▪ Switch</li> </ul>	Pulse
Assign frequency output	In the <b>Operating mode</b> parameter (→  82), the <b>Frequency</b> option is selected.	Select process variable for frequency output.	<ul style="list-style-type: none"> <li>▪ Off</li> <li>▪ Volume flow</li> <li>▪ Mass flow</li> <li>▪ Corrected volume flow</li> <li>▪ Flow velocity</li> <li>▪ Temperature</li> <li>▪ Electronic temperature</li> </ul>	Off
Minimum frequency value	In the <b>Operating mode</b> parameter the <b>Frequency</b> option is selected and in the <b>Assign frequency output</b> parameter (→  83) one of the following options is selected: <ul style="list-style-type: none"> <li>▪ Volume flow</li> <li>▪ Mass flow</li> <li>▪ Flow velocity</li> <li>▪ Electronic temperature</li> </ul>	Enter minimum frequency.	0.0 to 12 500.0 Hz	0.0 Hz
Maximum frequency value	In the <b>Operating mode</b> parameter the <b>Frequency</b> option is selected and in the <b>Assign frequency output</b> parameter (→  83) one of the following options is selected: <ul style="list-style-type: none"> <li>▪ Volume flow</li> <li>▪ Mass flow</li> <li>▪ Flow velocity</li> <li>▪ Electronic temperature</li> </ul>	Enter maximum frequency.	0.0 to 12 500.0 Hz	12 500.0 Hz
Measuring value at minimum frequency	In the <b>Operating mode</b> parameter the <b>Frequency</b> option is selected and in the <b>Assign frequency output</b> parameter (→  83) one of the following options is selected: <ul style="list-style-type: none"> <li>▪ Volume flow</li> <li>▪ Mass flow</li> <li>▪ Flow velocity</li> <li>▪ Electronic temperature</li> </ul>	Enter measured value for minimum frequency.	Signed floating-point number	Depends on country and nominal diameter

Parameter	Prerequisite	Description	Selection / User entry	Factory setting
Measuring value at maximum frequency	In the <b>Operating mode</b> parameter the <b>Frequency</b> option is selected and in the <b>Assign frequency output</b> parameter (→ 83) one of the following options is selected: <ul style="list-style-type: none"> <li>▪ Volume flow</li> <li>▪ Mass flow</li> <li>▪ Flow velocity</li> <li>▪ Electronic temperature</li> </ul>	Enter measured value for maximum frequency.	Signed floating-point number	Depends on country and nominal diameter
Failure mode	In the <b>Operating mode</b> parameter the <b>Frequency</b> option is selected and in the <b>Assign frequency output</b> parameter (→ 83) one of the following options is selected: <ul style="list-style-type: none"> <li>▪ Volume flow</li> <li>▪ Mass flow</li> <li>▪ Flow velocity</li> <li>▪ Electronic temperature</li> </ul>	Define output behavior in alarm condition.	<ul style="list-style-type: none"> <li>▪ Actual value</li> <li>▪ Defined value</li> <li>▪ 0 Hz</li> </ul>	0 Hz
Failure frequency	In the <b>Operating mode</b> parameter the <b>Frequency</b> option is selected and in the <b>Assign frequency output</b> parameter (→ 83) one of the following options is selected: <ul style="list-style-type: none"> <li>▪ Volume flow</li> <li>▪ Mass flow</li> <li>▪ Flow velocity</li> <li>▪ Electronic temperature</li> </ul>	Enter frequency output value in alarm condition.	0.0 to 12 500.0 Hz	0.0 Hz
Invert output signal	–	Invert the output signal.	<ul style="list-style-type: none"> <li>▪ No</li> <li>▪ Yes</li> </ul>	No

### Configuring the switch output

#### Navigation

"Setup" menu → Pulse/frequency/switch output 1 to n

▶ Pulse/frequency/switch output 1 to n	
Operating mode	→ 85
Switch output function	→ 85
Assign diagnostic behavior	→ 85
Assign limit	→ 85
Assign flow direction check	→ 85
Assign status	→ 85

Switch-on value	→ 86
Switch-off value	→ 86
Switch-on delay	→ 86
Switch-off delay	→ 86
Failure mode	→ 86
Invert output signal	→ 86

**Parameter overview with brief description**

Parameter	Prerequisite	Description	Selection / User entry	Factory setting
Operating mode	–	Define the output as a pulse, frequency or switch output.	<ul style="list-style-type: none"> <li>▪ Pulse</li> <li>▪ Frequency</li> <li>▪ Switch</li> </ul>	Pulse
Switch output function	In the <b>Operating mode</b> parameter the <b>Switch</b> option is selected.	Select function for switch output.	<ul style="list-style-type: none"> <li>▪ Off</li> <li>▪ On</li> <li>▪ Diagnostic behavior</li> <li>▪ Limit</li> <li>▪ Flow direction check</li> <li>▪ Status</li> </ul>	Off
Assign diagnostic behavior	<ul style="list-style-type: none"> <li>▪ In the <b>Operating mode</b> parameter, the <b>Switch</b> option is selected.</li> <li>▪ In the <b>Switch output function</b> parameter, the <b>Diagnostic behavior</b> option is selected.</li> </ul>	Select diagnostic behavior for switch output.	<ul style="list-style-type: none"> <li>▪ Alarm</li> <li>▪ Alarm or warning</li> <li>▪ Warning</li> </ul>	Alarm
Assign limit	<ul style="list-style-type: none"> <li>▪ In the <b>Operating mode</b> parameter, the <b>Switch</b> option is selected.</li> <li>▪ In the <b>Switch output function</b> parameter, the <b>Limit</b> option is selected.</li> </ul>	Select process variable for limit function.	<ul style="list-style-type: none"> <li>▪ Off</li> <li>▪ Volume flow</li> <li>▪ Mass flow</li> <li>▪ Corrected volume flow</li> <li>▪ Flow velocity</li> <li>▪ Totalizer 1</li> <li>▪ Totalizer 2</li> <li>▪ Totalizer 3</li> <li>▪ Temperature</li> <li>▪ Electronic temperature</li> </ul>	Volume flow
Assign flow direction check	<ul style="list-style-type: none"> <li>▪ The <b>Switch</b> option is selected in the <b>Operating mode</b> parameter.</li> <li>▪ The <b>Flow direction check</b> option is selected in the <b>Switch output function</b> parameter.</li> </ul>	Select process variable for flow direction monitoring.	<ul style="list-style-type: none"> <li>▪ Off</li> <li>▪ Volume flow</li> <li>▪ Mass flow</li> <li>▪ Corrected volume flow</li> </ul>	Volume flow
Assign status	<ul style="list-style-type: none"> <li>▪ The <b>Switch</b> option is selected in the <b>Operating mode</b> parameter.</li> <li>▪ The <b>Status</b> option is selected in the <b>Switch output function</b> parameter.</li> </ul>	Select device status for switch output.	<ul style="list-style-type: none"> <li>▪ Empty pipe detection</li> <li>▪ Low flow cut off</li> </ul>	Empty pipe detection

Parameter	Prerequisite	Description	Selection / User entry	Factory setting
Switch-on value	<ul style="list-style-type: none"> <li>In the <b>Operating mode</b> parameter, the <b>Switch</b> option is selected.</li> <li>In the <b>Switch output function</b> parameter, the <b>Limit</b> option is selected.</li> </ul>	Enter measured value for the switch-on point.	Signed floating-point number	Country-specific: <ul style="list-style-type: none"> <li>0 l/h</li> <li>0 gal/min (us)</li> </ul>
Switch-off value	<ul style="list-style-type: none"> <li>In the <b>Operating mode</b> parameter, the <b>Switch</b> option is selected.</li> <li>In the <b>Switch output function</b> parameter, the <b>Limit</b> option is selected.</li> </ul>	Enter measured value for the switch-off point.	Signed floating-point number	Country-specific: <ul style="list-style-type: none"> <li>0 l/h</li> <li>0 gal/min (us)</li> </ul>
Switch-on delay	<ul style="list-style-type: none"> <li>The <b>Switch</b> option is selected in the <b>Operating mode</b> parameter.</li> <li>The <b>Limit</b> option is selected in the <b>Switch output function</b> parameter.</li> </ul>	Define delay for the switch-on of status output.	0.0 to 100.0 s	0.0 s
Switch-off delay	<ul style="list-style-type: none"> <li>The <b>Switch</b> option is selected in the <b>Operating mode</b> parameter.</li> <li>The <b>Limit</b> option is selected in the <b>Switch output function</b> parameter.</li> </ul>	Define delay for the switch-off of status output.	0.0 to 100.0 s	0.0 s
Failure mode	–	Define output behavior in alarm condition.	<ul style="list-style-type: none"> <li>Actual status</li> <li>Open</li> <li>Closed</li> </ul>	Open
Invert output signal	–	Invert the output signal.	<ul style="list-style-type: none"> <li>No</li> <li>Yes</li> </ul>	No



### 10.4.6 Configuring the local display

The **Display** wizard guides you systematically through all the parameters that can be configured for configuring the local display.



#### Navigation

"Setup" menu → Display

► Display	
Format display	→ 87
Value 1 display	→ 87
0% bargraph value 1	→ 87
100% bargraph value 1	→ 87
Value 2 display	→ 87
Value 3 display	→ 87
0% bargraph value 3	→ 87

100% bargraph value 3	→  87
Value 4 display	→  87

**Parameter overview with brief description**

Parameter	Prerequisite	Description	Selection / User entry	Factory setting
Format display	A local display is provided.	Select how measured values are shown on the display.	<ul style="list-style-type: none"> <li>■ 1 value, max. size</li> <li>■ 1 bargraph + 1 value</li> <li>■ 2 values</li> <li>■ 1 value large + 2 values</li> <li>■ 4 values</li> </ul>	1 value, max. size
Value 1 display	A local display is provided.	Select the measured value that is shown on the local display.	<ul style="list-style-type: none"> <li>■ Volume flow</li> <li>■ Mass flow</li> <li>■ Corrected volume flow</li> <li>■ Flow velocity</li> <li>■ Electronic temperature</li> <li>■ Totalizer 1</li> <li>■ Totalizer 2</li> <li>■ Totalizer 3</li> <li>■ Current output 1 *</li> </ul>	Volume flow
0% bargraph value 1	A local display is provided.	Enter 0% value for bar graph display.	Signed floating-point number	Country-specific: <ul style="list-style-type: none"> <li>■ 0 l/h</li> <li>■ 0 gal/min (us)</li> </ul>
100% bargraph value 1	A local display is provided.	Enter 100% value for bar graph display.	Signed floating-point number	Depends on country and nominal diameter
Value 2 display	A local display is provided.	Select the measured value that is shown on the local display.	<ul style="list-style-type: none"> <li>■ None</li> <li>■ Volume flow</li> <li>■ Mass flow</li> <li>■ Corrected volume flow</li> <li>■ Flow velocity</li> <li>■ Electronic temperature</li> <li>■ Totalizer 1</li> <li>■ Totalizer 2</li> <li>■ Totalizer 3</li> <li>■ Current output 1</li> </ul>	None
Value 3 display	A local display is provided.	Select the measured value that is shown on the local display.	For the picklist, see the <b>Value 2 display</b> parameter (→  87)	None
0% bargraph value 3	A selection was made in the <b>Value 3 display</b> parameter.	Enter 0% value for bar graph display.	Signed floating-point number	Country-specific: <ul style="list-style-type: none"> <li>■ 0 l/h</li> <li>■ 0 gal/min (us)</li> </ul>
100% bargraph value 3	A selection was made in the <b>Value 3 display</b> parameter.	Enter 100% value for bar graph display.	Signed floating-point number	0
Value 4 display	A local display is provided.	Select the measured value that is shown on the local display.	For the picklist, see the <b>Value 2 display</b> parameter (→  87)	None

\* Visibility depends on order options or device settings

## 10.4.7 Configuring the output conditioning

The **Output conditioning** wizard guides you systematically through all the parameters that have to be set for configuring the output conditioning.

### Navigation

"Setup" menu → Output conditioning

► Output conditioning	
Display damping	→ 88
Assign current output 1	→ 88
Damping output 1	→ 88
Measuring mode output 1	→ 88
Assign frequency output	→ 89
Damping output 1 to n	→ 89
Measuring mode output 1 to n	→ 89
Assign pulse output 1 to n	→ 89
Measuring mode output 1 to n	→ 89

### Parameter overview with brief description

Parameter	Prerequisite	Description	User entry / Selection	Factory setting
Display damping	-	Set display reaction time to fluctuations in the measured value.	0.0 to 999.9 s	0.0 s
Assign current output	-	Select process variable for current output.	<ul style="list-style-type: none"> <li>▪ Volume flow</li> <li>▪ Mass flow</li> <li>▪ Corrected volume flow</li> <li>▪ Flow velocity</li> <li>▪ Temperature</li> <li>▪ Electronic temperature</li> </ul>	Volume flow
Damping output 1	-	Set reaction time for output signal to fluctuations in the measured value.	0 to 999.9 s	1 s
Measuring mode output 1	-	Select measuring mode for output.	<ul style="list-style-type: none"> <li>▪ Forward flow</li> <li>▪ Forward/Reverse flow</li> <li>▪ Reverse flow compensation</li> </ul>	Forward flow



Parameter	Prerequisite	Description	User entry / Selection	Factory setting
Assign frequency output	In the <b>Operating mode</b> parameter (→ 82), the <b>Frequency</b> option is selected.	Select process variable for frequency output.	<ul style="list-style-type: none"> <li>▪ Off</li> <li>▪ Volume flow</li> <li>▪ Mass flow</li> <li>▪ Corrected volume flow</li> <li>▪ Flow velocity</li> <li>▪ Temperature</li> <li>▪ Electronic temperature</li> </ul>	Off
Damping output 1 to n	–	Set reaction time for output signal to fluctuations in the measured value.	0 to 999.9 s	1 s
Measuring mode output 1 to n	–	Select measuring mode for output.	<ul style="list-style-type: none"> <li>▪ Forward flow</li> <li>▪ Forward/Reverse flow</li> <li>▪ Reverse flow</li> <li>▪ Reverse flow compensation</li> </ul>	Forward flow
Assign pulse output	In the <b>Operating mode</b> parameter, the <b>Pulse</b> option is selected.	Select process variable for pulse output.	<ul style="list-style-type: none"> <li>▪ Off</li> <li>▪ Volume flow</li> <li>▪ Mass flow</li> <li>▪ Corrected volume flow</li> </ul>	Off
Measuring mode output 1 to n	–	Select measuring mode for output.	<ul style="list-style-type: none"> <li>▪ Forward flow</li> <li>▪ Forward/Reverse flow</li> <li>▪ Reverse flow</li> <li>▪ Reverse flow compensation</li> </ul>	Forward flow

### 10.4.8 Configuring the low flow cut off

The **Low flow cut off** wizard systematically guides the user through all the parameters that must be set to configure low flow cut off.

#### Navigation

"Setup" menu → Low flow cut off

▶ **Low flow cut off**

Assign process variable	→ 90
On value low flow cutoff	→ 90
Off value low flow cutoff	→ 90
Pressure shock suppression	→ 90

## Parameter overview with brief description

Parameter	Prerequisite	Description	Selection / User entry	Factory setting
Assign process variable	–	Select process variable for low flow cut off.	<ul style="list-style-type: none"> <li>▪ Off</li> <li>▪ Volume flow</li> <li>▪ Mass flow</li> <li>▪ Corrected volume flow</li> </ul>	Volume flow
On value low flow cutoff	One of the following options is selected in the <b>Assign process variable</b> parameter (→ 90): <ul style="list-style-type: none"> <li>▪ Volume flow</li> <li>▪ Mass flow</li> </ul>	Enter on value for low flow cut off.	Positive floating-point number	Depends on country and nominal diameter
Off value low flow cutoff	One of the following options is selected in the <b>Assign process variable</b> parameter (→ 90): <ul style="list-style-type: none"> <li>▪ Volume flow</li> <li>▪ Mass flow</li> </ul>	Enter off value for low flow cut off.	0 to 100.0 %	50 %
Pressure shock suppression	One of the following options is selected in the <b>Assign process variable</b> parameter (→ 90): <ul style="list-style-type: none"> <li>▪ Volume flow</li> <li>▪ Mass flow</li> </ul>	Enter time frame for signal suppression (= active pressure shock suppression).	0 to 100 s	0 s

### 10.4.9 Configuring empty pipe detection

The **Empty pipe detection** wizard guides you systematically through all the parameters that have to be set for configuring empty pipe detection.

#### Navigation

"Setup" menu → Empty pipe detection

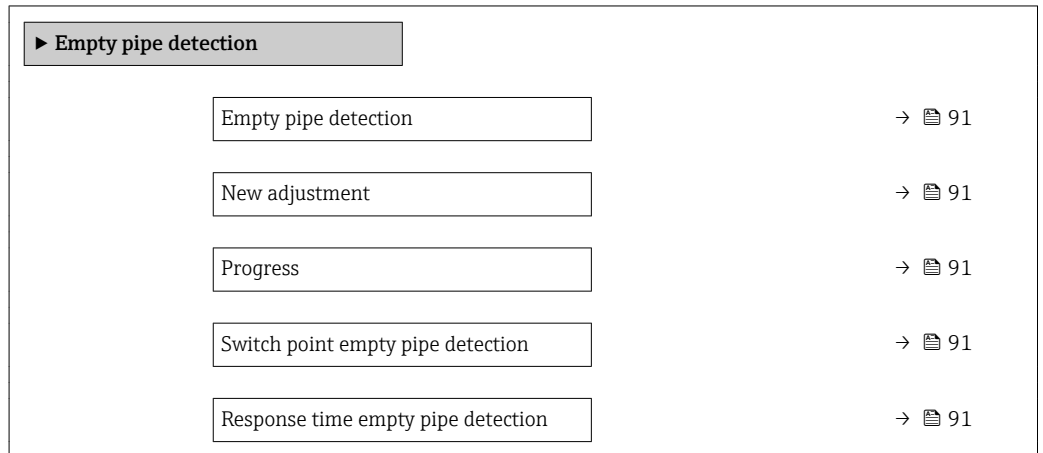

#### Parameter overview with brief description

Parameter	Prerequisite	Description	Selection / User interface / User entry	Factory setting
Empty pipe detection	–	Switch empty pipe detection on and off.	<ul style="list-style-type: none"> <li>■ Off</li> <li>■ On</li> </ul>	Off
New adjustment	The <b>On</b> option is selected in the <b>Empty pipe detection</b> parameter.	Select type of adjustment.	<ul style="list-style-type: none"> <li>■ Cancel</li> <li>■ Empty pipe adjust</li> <li>■ Full pipe adjust</li> </ul>	Cancel
Progress	The <b>On</b> option is selected in the <b>Empty pipe detection</b> parameter.	Shows the progress.	<ul style="list-style-type: none"> <li>■ Ok</li> <li>■ Busy</li> <li>■ Not ok</li> </ul>	–
Switch point empty pipe detection	The <b>On</b> option is selected in the <b>Empty pipe detection</b> parameter.	Enter hysteresis in %, below this value the measuring tube will detected as empty.	0 to 100 %	50 %
Response time empty pipe detection	In the <b>Empty pipe detection</b> parameter (→ 91), the <b>On</b> option is selected.	Enter the time before diagnostic message S862 'Pipe empty' is displayed for empty pipe detection.	0 to 100 s	1 s

## 10.5 Advanced settings

The **Advanced setup** submenu together with its submenus contains parameters for specific settings.

*Navigation to the "Advanced setup" submenu*

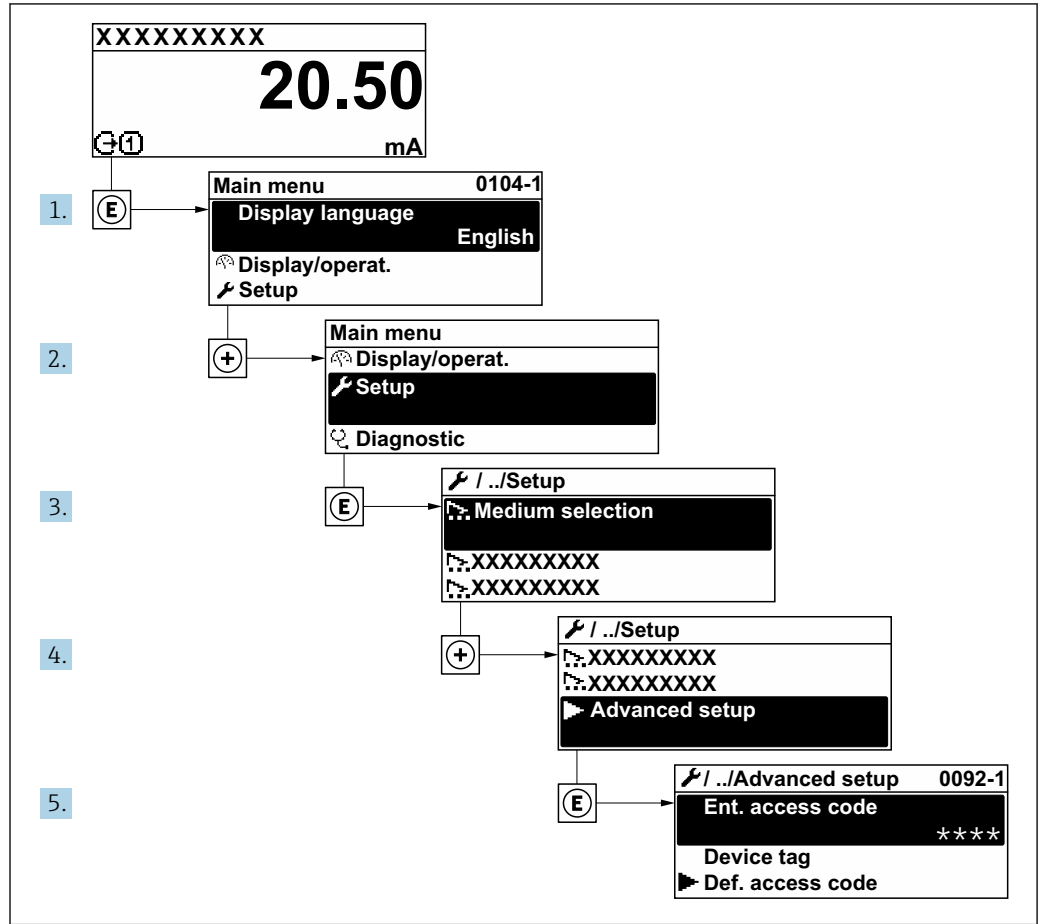

A0032223-EN

**i** Depending on the device version, not all submenus and parameters are available in every device. The selection can vary depending on the order code.

### Navigation

"Setup" menu → Advanced setup

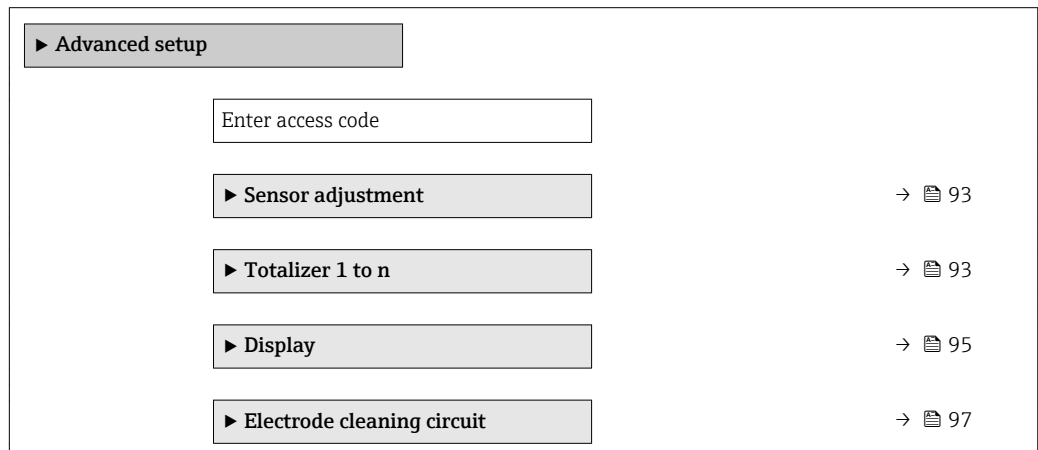

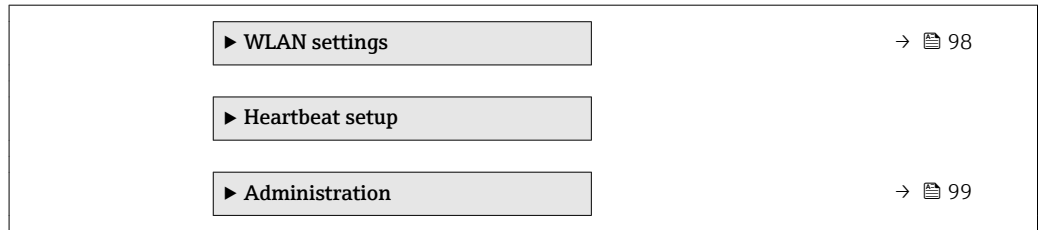

### 10.5.1 Carrying out a sensor adjustment

The **Sensor adjustment** submenu contains parameters that pertain to the functionality of the sensor.

#### Navigation

"Setup" menu → Advanced setup → Sensor adjustment

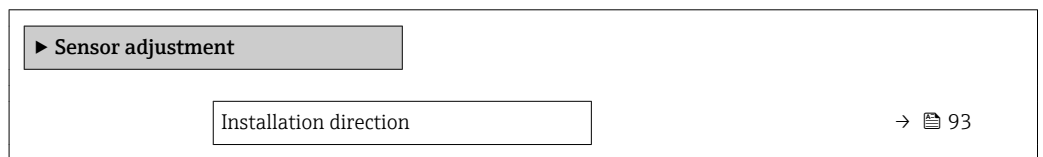

#### Parameter overview with brief description

Parameter	Description	Selection	Factory setting
Installation direction	Set sign of flow direction to match the direction of the arrow on the sensor.	<ul style="list-style-type: none"> <li>▪ Flow in arrow direction</li> <li>▪ Flow against arrow direction</li> </ul>	Flow in arrow direction

### 10.5.2 Configuring the totalizer



In the "**Totalizer 1 to n**" submenu the individual totalizer can be configured.

#### Navigation

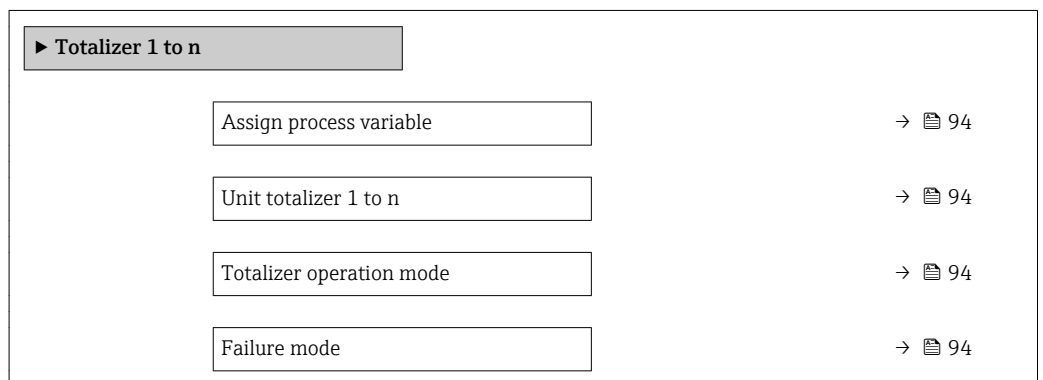
"Setup" menu → Advanced setup → Totalizer 1 to n



## Parameter overview with brief description

Parameter	Prerequisite	Description	Selection	Factory setting
Assign process variable	–	Select process variable for totalizer.	<ul style="list-style-type: none"> <li>▪ Off</li> <li>▪ Volume flow</li> <li>▪ Mass flow</li> <li>▪ Corrected volume flow</li> </ul>	Volume flow
Unit totalizer 1 to n	One of the following options is selected in the <b>Assign process variable</b> parameter (→  94) <b>Totalizer 1 to n</b> submenu: <ul style="list-style-type: none"> <li>▪ Volume flow</li> <li>▪ Mass flow</li> </ul>	Select process variable totalizer unit.	Unit choose list	Country-specific: <ul style="list-style-type: none"> <li>▪ l</li> <li>▪ gal (us)</li> </ul>
Totalizer operation mode	One of the following options is selected in the <b>Assign process variable</b> parameter (→  94) <b>Totalizer 1 to n</b> submenu: <ul style="list-style-type: none"> <li>▪ Volume flow</li> <li>▪ Mass flow</li> </ul>	Select totalizer calculation mode.	<ul style="list-style-type: none"> <li>▪ Net flow total</li> <li>▪ Forward flow total</li> <li>▪ Reverse flow total</li> </ul>	Net flow total
Failure mode	One of the following options is selected in the <b>Assign process variable</b> parameter (→  94) <b>Totalizer 1 to n</b> submenu: <ul style="list-style-type: none"> <li>▪ Volume flow</li> <li>▪ Mass flow</li> </ul>	Define totalizer behavior in alarm condition.	<ul style="list-style-type: none"> <li>▪ Stop</li> <li>▪ Actual value</li> <li>▪ Last valid value</li> </ul>	Stop

### 10.5.3 Carrying out additional display configurations

In the **Display** submenu you can set all the parameters associated with the configuration of the local display.

#### Navigation

"Setup" menu → Advanced setup → Display

► Display	
Format display	→ 96
Value 1 display	→ 96
0% bargraph value 1	→ 96
100% bargraph value 1	→ 96
Decimal places 1	→ 96
Value 2 display	→ 96
Decimal places 2	→ 96
Value 3 display	→ 96
0% bargraph value 3	→ 96
100% bargraph value 3	→ 96
Decimal places 3	→ 96
Value 4 display	→ 97
Decimal places 4	→ 97
Display language	→ 97
Display interval	→ 97
Display damping	→ 97
Header	→ 97
Header text	→ 97
Separator	→ 97
Backlight	→ 97

## Parameter overview with brief description

Parameter	Prerequisite	Description	Selection / User entry	Factory setting
Format display	A local display is provided.	Select how measured values are shown on the display.	<ul style="list-style-type: none"> <li>▪ 1 value, max. size</li> <li>▪ 1 bargraph + 1 value</li> <li>▪ 2 values</li> <li>▪ 1 value large + 2 values</li> <li>▪ 4 values</li> </ul>	1 value, max. size
Value 1 display	A local display is provided.	Select the measured value that is shown on the local display.	<ul style="list-style-type: none"> <li>▪ Volume flow</li> <li>▪ Mass flow</li> <li>▪ Corrected volume flow</li> <li>▪ Flow velocity</li> <li>▪ Electronic temperature</li> <li>▪ Totalizer 1</li> <li>▪ Totalizer 2</li> <li>▪ Totalizer 3</li> <li>▪ Current output 1 *</li> </ul>	Volume flow
0% bargraph value 1	A local display is provided.	Enter 0% value for bar graph display.	Signed floating-point number	Country-specific: <ul style="list-style-type: none"> <li>▪ 0 l/h</li> <li>▪ 0 gal/min (us)</li> </ul>
100% bargraph value 1	A local display is provided.	Enter 100% value for bar graph display.	Signed floating-point number	Depends on country and nominal diameter
Decimal places 1	A measured value is specified in the <b>Value 1 display</b> parameter.	Select the number of decimal places for the display value.	<ul style="list-style-type: none"> <li>▪ x</li> <li>▪ x.x</li> <li>▪ x.xx</li> <li>▪ x.xxx</li> <li>▪ x.xxxx</li> </ul>	x.xx
Value 2 display	A local display is provided.	Select the measured value that is shown on the local display.	<ul style="list-style-type: none"> <li>▪ None</li> <li>▪ Volume flow</li> <li>▪ Mass flow</li> <li>▪ Corrected volume flow</li> <li>▪ Flow velocity</li> <li>▪ Electronic temperature</li> <li>▪ Totalizer 1</li> <li>▪ Totalizer 2</li> <li>▪ Totalizer 3</li> <li>▪ Current output 1</li> </ul>	None
Decimal places 2	A measured value is specified in the <b>Value 2 display</b> parameter.	Select the number of decimal places for the display value.	<ul style="list-style-type: none"> <li>▪ x</li> <li>▪ x.x</li> <li>▪ x.xx</li> <li>▪ x.xxx</li> <li>▪ x.xxxx</li> </ul>	x.xx
Value 3 display	A local display is provided.	Select the measured value that is shown on the local display.	For the picklist, see the <b>Value 2 display</b> parameter (→ 87)	None
0% bargraph value 3	A selection was made in the <b>Value 3 display</b> parameter.	Enter 0% value for bar graph display.	Signed floating-point number	Country-specific: <ul style="list-style-type: none"> <li>▪ 0 l/h</li> <li>▪ 0 gal/min (us)</li> </ul>
100% bargraph value 3	A selection was made in the <b>Value 3 display</b> parameter.	Enter 100% value for bar graph display.	Signed floating-point number	0
Decimal places 3	A measured value is specified in the <b>Value 3 display</b> parameter.	Select the number of decimal places for the display value.	<ul style="list-style-type: none"> <li>▪ x</li> <li>▪ x.x</li> <li>▪ x.xx</li> <li>▪ x.xxx</li> <li>▪ x.xxxx</li> </ul>	x.xx



Parameter	Prerequisite	Description	Selection / User entry	Factory setting
Value 4 display	A local display is provided.	Select the measured value that is shown on the local display.	For the picklist, see the <b>Value 2 display</b> parameter (→  87)	None
Decimal places 4	A measured value is specified in the <b>Value 4 display</b> parameter.	Select the number of decimal places for the display value.	<ul style="list-style-type: none"> <li>■ x</li> <li>■ x.x</li> <li>■ x.xx</li> <li>■ x.xxx</li> <li>■ x.xxxx</li> </ul>	x.xx
Display language	A local display is provided.	Set display language.	<ul style="list-style-type: none"> <li>■ English</li> <li>■ Deutsch *</li> <li>■ Français *</li> <li>■ Español *</li> <li>■ Italiano</li> <li>■ Nederlands *</li> <li>■ Portuguesa *</li> <li>■ Polski</li> <li>■ русский язык (Russian) *</li> <li>■ Svenska *</li> <li>■ Türkçe *</li> <li>■ 中文 (Chinese) *</li> <li>■ 日本語 (Japanese) *</li> <li>■ 한국어 (Korean) *</li> <li>■ العربية (Arabic) *</li> <li>■ Bahasa Indonesia *</li> <li>■ ภาษาไทย (Thai) *</li> <li>■ tiếng Việt (Vietnamese) *</li> <li>■ čeština (Czech) *</li> </ul>	English (alternatively, the ordered language is preset in the device)
Display interval	A local display is provided.	Set time measured values are shown on display if display alternates between values.	1 to 10 s	5 s
Display damping	A local display is provided.	Set display reaction time to fluctuations in the measured value.	0.0 to 999.9 s	0.0 s
Header	A local display is provided.	Select header contents on local display.	<ul style="list-style-type: none"> <li>■ Device tag</li> <li>■ Free text</li> </ul>	Device tag
Header text	In the <b>Header</b> parameter, the <b>Free text</b> option is selected.	Enter display header text.	Max. 12 characters such as letters, numbers or special characters (e.g. @, %, /)	-----
Separator	A local display is provided.	Select decimal separator for displaying numerical values.	<ul style="list-style-type: none"> <li>■ . (point)</li> <li>■ , (comma)</li> </ul>	. (point)
Backlight	A local display is provided.	Switch the local display backlight on and off.	<ul style="list-style-type: none"> <li>■ Disable</li> <li>■ Enable</li> </ul>	Enable

\* Visibility depends on order options or device settings

### 10.5.4 Performing electrode cleaning

The **Electrode cleaning circuit** wizard guides the user systematically through all the parameters that have to be set for configuring electrode cleaning.



The wizard only appears if the device was ordered with an electrode cleaning circuit.

**Navigation**

"Setup" menu → Advanced setup → Electrode cleaning circuit

▶ Electrode cleaning circuit	
Electrode cleaning circuit	→ 98
ECC duration	→ 98
ECC recovery time	→ 98
ECC cleaning cycle	→ 98
ECC Polarity	→ 98

**Parameter overview with brief description**

Parameter	Prerequisite	Description	Selection / User entry / User interface	Factory setting
Electrode cleaning circuit	For the following order code: "Application package", option <b>EC</b> "ECC electrode cleaning"	Enable the cyclic electrode cleaning circuit.	<ul style="list-style-type: none"> <li>▪ Off</li> <li>▪ On</li> </ul>	Off
ECC duration	For the following order code: "Application package", option <b>EC</b> "ECC electrode cleaning"	Enter the duration of electrode cleaning in seconds.	0.01 to 30 s	2 s
ECC recovery time	For the following order code: "Application package", option <b>EC</b> "ECC electrode cleaning"	Define recovery time after electrode cleaning. During this time the current output values will be held at last valid value.	1 to 600 s	60 s
ECC cleaning cycle	For the following order code: "Application package", option <b>EC</b> "ECC electrode cleaning"	Enter the pause duration between electrode cleaning cycles.	0.5 to 168 h	0.5 h
ECC Polarity	For the following order code: "Application package", option <b>EC</b> "ECC electrode cleaning"	Select the polarity of the electrode cleaning circuit.	<ul style="list-style-type: none"> <li>▪ Positive</li> <li>▪ Negative</li> </ul>	Depends on the electrode material: <ul style="list-style-type: none"> <li>▪ Platinum: <b>Negative</b> option</li> <li>▪ Tantalum, Alloy C22, stainless steel: <b>Positive</b> option</li> </ul>

**10.5.5 WLAN configuration**

The **WLAN Settings** submenu guides the user systematically through all the parameters that have to be set for the WLAN configuration.



**Navigation**

"Setup" menu → Advanced setup → WLAN Settings

▶ WLAN settings	
WLAN IP address	→ 99

Security type	→ ⓘ 99
WLAN passphrase	→ ⓘ 99
Assign SSID name	→ ⓘ 99
SSID name	→ ⓘ 99
Apply changes	→ ⓘ 99

**Parameter overview with brief description**

Parameter	Prerequisite	Description	User entry / Selection	Factory setting
WLAN IP address	–	Enter IP address of the device WLAN interface.	4 octet: 0 to 255 (in the particular octet)	192.168.1.212
Security type	–	Select the security type of the WLAN interface.	<ul style="list-style-type: none"> <li>■ Unsecured</li> <li>■ WPA2-PSK</li> </ul>	WPA2-PSK
WLAN passphrase	In the <b>Security type</b> parameter, the <b>WPA2-PSK</b> option is selected.	Enter the network key (8 to 32 characters).  The network key supplied with the device should be changed during commissioning for security reasons.	8 to 32-digit character string comprising numbers, letters and special characters	Serial number of the measuring device (e.g. L100A802000)
Assign SSID name	–	Select which name will be used for SSID: device tag or user-defined name.	<ul style="list-style-type: none"> <li>■ Device tag</li> <li>■ User-defined</li> </ul>	User-defined
SSID name	In the <b>Assign SSID name</b> parameter, the <b>User-defined</b> option is selected.	Enter the user-defined SSID name (max. 32 characters).  The user-defined SSID name may only be assigned once. If the SSID name is assigned more than once, the devices can interfere with one another.	Max. 32-digit character string comprising numbers, letters and special characters	
Apply changes	–	Use changed WLAN settings.	<ul style="list-style-type: none"> <li>■ Cancel</li> <li>■ Ok</li> </ul>	Cancel

**10.5.6 Using parameters for device administration**

The **Administration** submenu systematically guides the user through all the parameters that can be used for device administration purposes.

**Navigation**

"Setup" menu → Advanced setup → Administration

▶ Administration	
▶ Define access code	→ ⓘ 100

<b>▶ Reset access code</b>	→  100
Device reset	→  101

**Using the parameter to define the access code**

**Navigation**

"Setup" menu → Advanced setup → Administration → Define access code

<b>▶ Define access code</b>	
Define access code	→  100
Confirm access code	→  100

**Parameter overview with brief description**

Parameter	Description	User entry
Define access code	Restrict write-access to parameters to protect the configuration of the device against unintentional changes.	Max. 16-digit character string comprising numbers, letters and special characters
Confirm access code	Confirm the entered access code.	Max. 16-digit character string comprising numbers, letters and special characters

**Using the parameter to reset the access code**

**Navigation**

"Setup" menu → Advanced setup → Administration → Reset access code

<b>▶ Reset access code</b>	
Operating time	→  100
Reset access code	→  100

**Parameter overview with brief description**

Parameter	Description	User interface / User entry	Factory setting
Operating time	Indicates how long the device has been in operation.	Days (d), hours (h), minutes (m) and seconds (s)	–
Reset access code	Reset access code to factory settings. For a reset code, contact your Endress+Hauser service organization.  The reset code can only be entered via: <ul style="list-style-type: none"> <li>▪ Web browser</li> <li>▪ DeviceCare, FieldCare (via service interface CDI-RJ45)</li> <li>▪ Fieldbus</li> </ul>	Character string comprising numbers, letters and special characters	0x00

**Using the parameter to reset the device**

**Navigation**

"Setup" menu → Advanced setup → Administration

**Parameter overview with brief description**

Parameter	Description	Selection	Factory setting
Device reset	Reset the device configuration - either entirely or in part - to a defined state.	<ul style="list-style-type: none"> <li>▪ Cancel</li> <li>▪ To delivery settings</li> <li>▪ Restart device</li> <li>▪ Restore S-DAT backup</li> </ul>	Cancel

## 10.6 Simulation

The **Simulation** submenu enables you to simulate, without a real flow situation, various process variables in the process and the device alarm mode and to verify downstream signal chains (switching valves or closed-control loops).



The parameters displayed depend on:



- The selected device order
- The set operating mode of the pulse/frequency/switch outputs

**Navigation**



"Diagnostics" menu → Simulation

▶ **Simulation**

Assign simulation process variable	→ ⓘ 102
Process variable value	→ ⓘ 102
Status input simulation	→ ⓘ 102
Input signal level	→ ⓘ 102
Current output 1 simulation	→ ⓘ 102
Value current output 1	→ ⓘ 102
Frequency output simulation 1 to n	→ ⓘ 102
Frequency value 1 to n	→ ⓘ 102
Pulse output simulation 1 to n	→ ⓘ 102
Pulse value 1 to n	→ ⓘ 102
Switch output simulation 1 to n	→ ⓘ 102
Switch status 1 to n	→ ⓘ 103

Device alarm simulation	→  103
Diagnostic event category	→  103
Diagnostic event simulation	→  103

### Parameter overview with brief description

Parameter	Prerequisite	Description	Selection / User entry	Factory setting
Assign simulation process variable	–	Select a process variable for the simulation process that is activated.	<ul style="list-style-type: none"> <li>▪ Off</li> <li>▪ Mass flow</li> <li>▪ Volume flow</li> <li>▪ Corrected volume flow</li> <li>▪ Flow velocity</li> <li>▪ Temperature</li> </ul>	Off
Process variable value	One of the following options is selected in the <b>Assign simulation process variable</b> parameter (→  102): <ul style="list-style-type: none"> <li>▪ Volume flow</li> <li>▪ Mass flow</li> <li>▪ Corrected volume flow</li> <li>▪ Flow velocity</li> <li>▪ Temperature</li> </ul>	Enter the simulation value for the selected process variable.	Depends on the process variable selected	0
Status input simulation	For the following order code: "Output; input", option I "4-20mA HART, 2x pul./freq./switch output; status input"	Switch simulation of the status input on and off.	<ul style="list-style-type: none"> <li>▪ Off</li> <li>▪ On</li> </ul>	Off
Input signal level	In the <b>Status input simulation</b> parameter, the <b>On</b> option is selected.	Select the signal level for the simulation of the status input.	<ul style="list-style-type: none"> <li>▪ High</li> <li>▪ Low</li> </ul>	High
Current output 1 simulation	–	Switch the simulation of the current output on and off.	<ul style="list-style-type: none"> <li>▪ Off</li> <li>▪ On</li> </ul>	Off
Value current output 1	In the <b>Current output simulation</b> parameter, the <b>On</b> option is selected.	Enter the current value for simulation.	3.59 to 22.5 mA	3.59 mA
Frequency output simulation 1 to n	In the <b>Operating mode</b> parameter, the <b>Frequency</b> option is selected.	Switch the simulation of the frequency output on and off.	<ul style="list-style-type: none"> <li>▪ Off</li> <li>▪ On</li> </ul>	Off
Frequency value 1 to n	In the <b>Frequency output simulation 1 to n</b> parameter, the <b>On</b> option is selected.	Enter the frequency value for the simulation.	0.0 to 12 500.0 Hz	0.0 Hz
Pulse output simulation 1 to n	In the <b>Operating mode</b> parameter, the <b>Pulse</b> option is selected.	Set and switch off the pulse output simulation.  For <b>Fixed value</b> option: <b>Pulse width</b> parameter (→  82) defines the pulse width of the pulses output.	<ul style="list-style-type: none"> <li>▪ Off</li> <li>▪ Fixed value</li> <li>▪ Down-counting value</li> </ul>	Off
Pulse value 1 to n	In the <b>Pulse output simulation 1 to n</b> parameter, the <b>Down-counting value</b> option is selected.	Enter the number of pulses for simulation.	0 to 65 535	0
Switch output simulation 1 to n	In the <b>Operating mode</b> parameter, the <b>Switch</b> option is selected.	Switch the simulation of the switch output on and off.	<ul style="list-style-type: none"> <li>▪ Off</li> <li>▪ On</li> </ul>	Off

Parameter	Prerequisite	Description	Selection / User entry	Factory setting
Switch status 1 to n	–	Select the status of the status output for the simulation.	<ul style="list-style-type: none"> <li>▪ Open</li> <li>▪ Closed</li> </ul>	Open
Device alarm simulation	–	Switch the device alarm on and off.	<ul style="list-style-type: none"> <li>▪ Off</li> <li>▪ On</li> </ul>	Off
Diagnostic event category	–	Select a diagnostic event category.	<ul style="list-style-type: none"> <li>▪ Sensor</li> <li>▪ Electronics</li> <li>▪ Configuration</li> <li>▪ Process</li> </ul>	Process
Diagnostic event simulation	–	Select a diagnostic event to simulate this event.	<ul style="list-style-type: none"> <li>▪ Off</li> <li>▪ Diagnostic event picklist (depends on the category selected)</li> </ul>	Off

## 10.7 Protecting settings from unauthorized access

The following options exist for protecting the configuration of the measuring device from unintentional modification after commissioning:



- Write protection via access code for the local display and Web browser
- Write protection via write protection switch
- Write protection via keypad lock →  59

### 10.7.1 Write protection via access code



The effects of the user-specific access code are as follows:

- Via local operation, the parameters for the measuring device configuration are write-protected and their values can no longer be changed.
- Device access is protected via the Web browser, as are the parameters for the measuring device configuration.

#### Defining the access code via local display

1. Navigate to the **Define access code** parameter (→  100).
2. Define a max. 16-digit character string comprising numbers, letters and special characters as the access code.
3. Enter the access code again in the to confirm the code.
  - ↳ The -symbol appears in front of all write-protected parameters.

The device automatically locks the write-protected parameters again if a key is not pressed for 10 minutes in the navigation and editing view. The device locks the write-protected parameters automatically after 60 s if the user skips back to the operational display mode from the navigation and editing view.

-  If parameter write protection is activated via an access code, it can also only be deactivated via this access code →  59.
- The user role with which the user is currently logged on via the local display is indicated by the →  59 **Access status display** parameter. Navigation path: Operation → Access status display

#### Parameters which can always be modified via the local display

Certain parameters that do not affect the measurement are excepted from parameter write protection via the local display. Despite the user-specific access code, they can always be modified, even if the other parameters are locked.

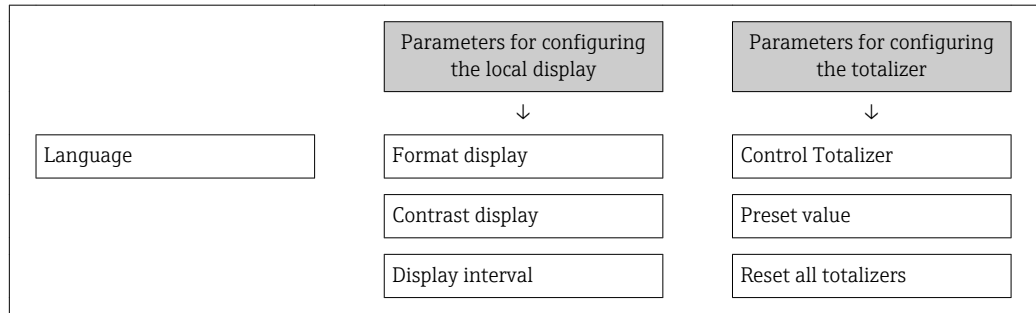

### Defining the access code via the Web browser

1. Navigate to the **Define access code** parameter (→ 📄 100).
2. Max. Define a max. 4-digit numeric code as an access code.
3. Enter the access code again in the to confirm the code.
  - ↳ The Web browser switches to the login page.

**i** If no action is performed for 10 minutes, the Web browser automatically returns to the login page.

- i**
- If parameter write protection is activated via an access code, it can also only be deactivated via this access code → 📄 59.
  - The user role with which the user is currently logged on via Web browser is indicated by the **Access status tooling** parameter. Navigation path: Operation → Access status tooling

### 10.7.2 Write protection via write protection switch

Unlike parameter write protection via a user-specific access code, this allows write access to the entire operating menu - except for the **"Contrast display" parameter** - to be locked.

The parameter values are now read only and cannot be edited any more (exception **"Contrast display" parameter**):

- Via local display
- Via service interface (CDI-RJ45)
- Via HART protocol

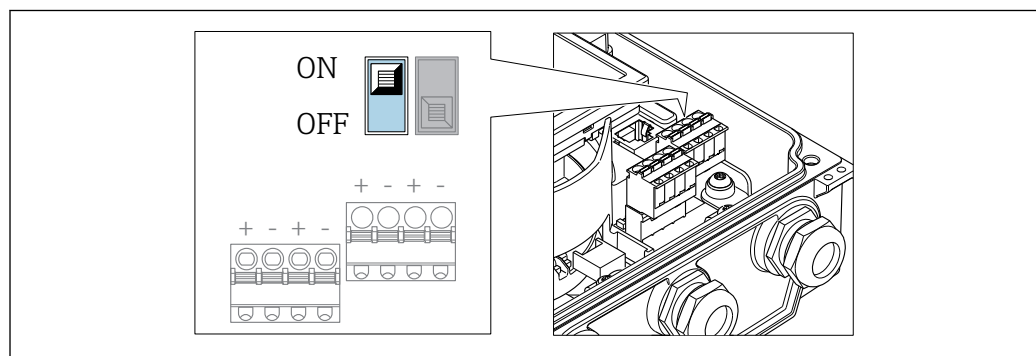

A0032092

1. Loosen the 4 fixing screws on the housing cover and open the housing cover.



2. Setting the write protection switch (WP) on the main electronics module to the **ON** position enables the hardware write protection. Setting the write protection switch (WP) on the main electronics module to the **OFF** position (factory setting) disables the hardware write protection.

↳ If the hardware write protection is enabled: The **Hardware locked** option is displayed in the **Locking status** parameter . In addition, on the local display the -symbol appears in front of the parameters in the header of the operational display and in the navigation view.

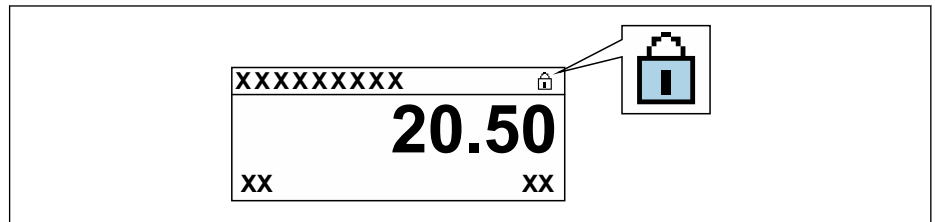

A0029425

If the hardware write protection is disabled: No option is displayed in the **Locking status** parameter . On the local display, the -symbol disappears from in front of the parameters in the header of the operational display and in the navigation view.

3. **⚠ WARNING**

**Excessive tightening torque applied to the fixing screws!**

Risk of damaging the plastic transmitter.

- ▶ Tighten the fixing screws as per the tightening torque .

Reverse the removal procedure to reassemble the transmitter.

# 11 Operation

## 11.1 Reading the device locking status

Device active write protection: **Locking status** parameter



Operation → Locking status

*Function scope of the "Locking status" parameter*

Options	Description
None	The access status displayed in the <b>Access status display</b> parameter applies →  59. Only appears on local display.
Hardware locked	The DIP switch for hardware locking is activated on the main electronics module. This locks write access to the parameters (e.g. via local display or operating tool).
Temporarily locked	Write access to the parameters is temporarily locked on account of internal processes running in the device (e.g. data upload/download, reset etc.). Once the internal processing has been completed, the parameters can be changed once again.



## 11.2 Adjusting the operating language

 Detailed information:

- To configure the operating language →  75
- For information on the operating languages supported by the measuring device →  152

## 11.3 Configuring the display

Detailed information:





- On the basic settings for the local display →  86
- On the advanced settings for the local display →  95

## 11.4 Reading measured values

With the **Measured values** submenu, it is possible to read all the measured values.

### Navigation

"Diagnostics" menu → Measured values → Output values

▶ Measured values	
▶ Process variables	→  107
▶ Input values	→  108
▶ Output values	→  108
▶ Totalizer	→  107

### 11.4.1 Process variables

The **Process variables** submenu contains all the parameters needed to display the current measured values for each process variable.

#### Navigation

"Diagnostics" menu → Measured values → Process variables

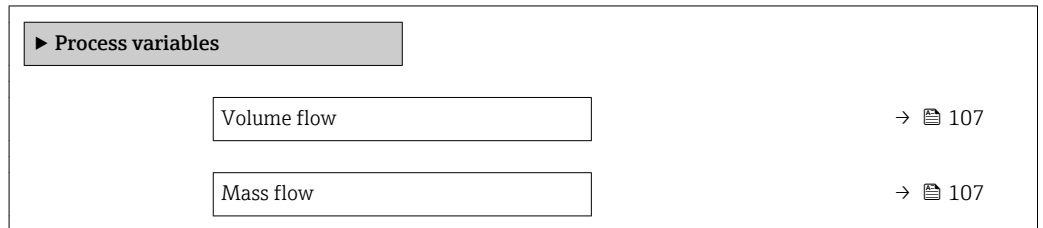

#### Parameter overview with brief description

Parameter	Description	User interface
Volume flow	Displays the volume flow currently measured. <i>Dependency</i> The unit is taken from the <b>Volume flow unit</b> parameter (→ 78).	Signed floating-point number
Mass flow	Displays the mass flow currently calculated. <i>Dependency</i> The unit is taken from the <b>Mass flow unit</b> parameter (→ 78).	Signed floating-point number

### 11.4.2 "Totalizer" submenu

The **Totalizer** submenu contains all the parameters needed to display the current measured values for every totalizer.

#### Navigation

"Diagnostics" menu → Measured values → Totalizer

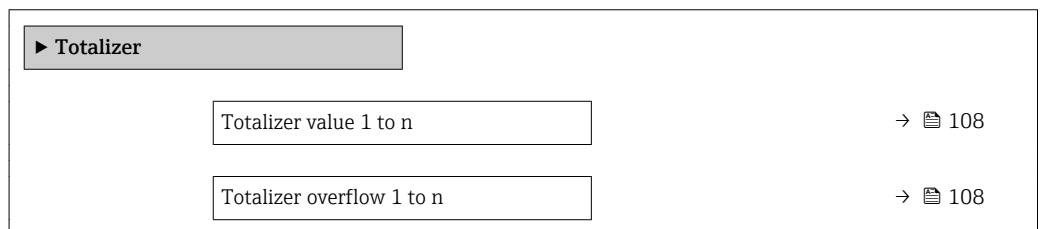

**Parameter overview with brief description**

Parameter	Prerequisite	Description	User interface
Totalizer value 1 to n	One of the following options is selected in the <b>Assign process variable</b> parameter (→ ⓘ 94) <b>Totalizer 1 to n</b> submenu: <ul style="list-style-type: none"> <li>▪ Volume flow</li> <li>▪ Mass flow</li> </ul>	Displays the current totalizer counter value.	Signed floating-point number
Totalizer overflow 1 to n	One of the following options is selected in the <b>Assign process variable</b> parameter (→ ⓘ 94) <b>Totalizer 1 to n</b> submenu: <ul style="list-style-type: none"> <li>▪ Volume flow</li> <li>▪ Mass flow</li> </ul>	Displays the current totalizer overflow.	Integer with sign

**11.4.3 Input values**

The **Input values** submenu guides you systematically to the individual input values.

 The submenu appears only if the device was ordered with a status input → ⓘ 35.

**Navigation**

"Diagnostics" menu → Measured values → Input values

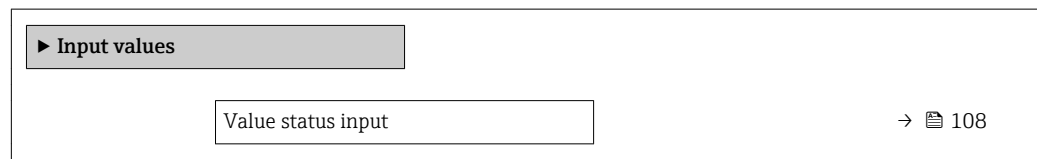

**Parameter overview with brief description**

Parameter	Prerequisite	Description	User interface
Value status input	For the following order code: <ul style="list-style-type: none"> <li>▪ "Output; input", option I "4-20mA HART, 2x pul./freq./switch output; status input"</li> <li>▪ "Output; input", option J "4-20mA HART, certified pulse output, switch output; status input"</li> </ul>	Shows the current input signal level.	<ul style="list-style-type: none"> <li>▪ High</li> <li>▪ Low</li> </ul>

**11.4.4 Output values**

The **Output values** submenu contains all the parameters needed to display the current measured values for every output.

 The parameters displayed depend on:  

- The selected device order
- The set operating mode of the pulse/frequency/switch outputs

**Navigation**

"Diagnostics" menu → Measured values → Output values

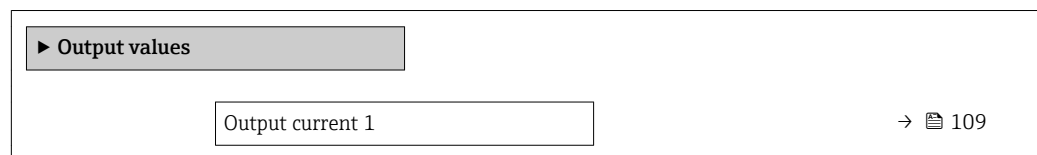

Measured current 1	→ ⓘ 109
Pulse output 1	→ ⓘ 109
Output frequency 1	→ ⓘ 109
Switch status 1	→ ⓘ 109
Output frequency 2	→ ⓘ 109
Pulse output 2	→ ⓘ 109
Switch status 2	→ ⓘ 109

**Parameter overview with brief description**

Parameter	Prerequisite	Description	User interface
Output current 1	–	Displays the current value currently calculated for the current output.	3.59 to 22.5 mA
Measured current 1	–	Displays the current value currently measured for the current output.	0 to 30 mA
Pulse output 1 to n	In the <b>Operating mode</b> parameter, the <b>Pulse</b> option is selected.	Displays the pulse frequency currently output.	Positive floating-point number
Output frequency 1 to n	In the <b>Operating mode</b> parameter, the <b>Frequency</b> option is selected.	Displays the value currently measured for the frequency output.	0.0 to 12 500.0 Hz
Switch status 1 to n	In the <b>Operating mode</b> parameter, the <b>Switch</b> option is selected.	Displays the current switch output status.	<ul style="list-style-type: none"> <li>■ Open</li> <li>■ Closed</li> </ul>

### 11.5 Adapting the measuring device to the process conditions

The following are available for this purpose:

- Basic settings using the **Setup** menu (→ ⓘ 75)
- Advanced settings using the **Advanced setup** submenu (→ ⓘ 92)

### 11.6 Performing a totalizer reset



The totalizers are reset in the **Operation** submenu:

- Control Totalizer
- Reset all totalizers





**Navigation**

"Operation" menu → Totalizer handling

▶ Totalizer handling	
Control Totalizer 1 to n	→ ⓘ 110

Preset value 1 to n	→  110
Reset all totalizers	→  110

### Parameter overview with brief description

Parameter	Prerequisite	Description	Selection / User entry	Factory setting
Control Totalizer 1 to n	One of the following options is selected in the <b>Assign process variable</b> parameter (→  94) <b>Totalizer 1 to n</b> submenu: <ul style="list-style-type: none"> <li>▪ Volume flow</li> <li>▪ Mass flow</li> </ul>	Control totalizer value.	<ul style="list-style-type: none"> <li>▪ Totalize</li> <li>▪ Reset + hold</li> <li>▪ Preset + hold</li> <li>▪ Reset + totalize</li> <li>▪ Preset + totalize</li> <li>▪ Hold</li> </ul>	Totalize
Preset value 1 to n	One of the following options is selected in the <b>Assign process variable</b> parameter (→  94) <b>Totalizer 1 to n</b> submenu: <ul style="list-style-type: none"> <li>▪ Volume flow</li> <li>▪ Mass flow</li> </ul>	Specify start value for totalizer. <i>Dependency</i>  The unit of the selected process variable is specified for the totalizer in the <b>Unit totalizer</b> parameter (→  94).	Signed floating-point number	0 l
Reset all totalizers	-	Reset all totalizers to 0 and start.	<ul style="list-style-type: none"> <li>▪ Cancel</li> <li>▪ Reset + totalize</li> </ul>	Cancel

#### 11.6.1 Function scope of the "Control Totalizer" parameter



Options	Description
Totalize	The totalizer is started or continues running.
Reset + hold	The totaling process is stopped and the totalizer is reset to 0.
Preset + hold	The totaling process is stopped and the totalizer is set to its defined start value from the <b>Preset value</b> parameter.
Reset + totalize	The totalizer is reset to 0 and the totaling process is restarted.
Preset + totalize	The totalizer is set to the defined start value from the <b>Preset value</b> parameter and the totaling process is restarted.

#### 11.6.2 Function scope of the "Reset all totalizers" parameter

Options	Description
Cancel	No action is executed and the user exits the parameter.
Reset + totalize	Resets all totalizers to 0 and restarts the totaling process. This deletes all the flow values previously totalized.

### 11.7 Showing data logging

The **Extended HistoROM** application package must be enabled in the device (order option) for the **Data logging** submenu to appear. This contains all the parameters for the measured value history.

-  Data logging is also available via:
- Plant Asset Management Tool FieldCare →  67.
  - Web browser

**Function range**

- A total of 1000 measured values can be stored
- 4 logging channels
- Adjustable logging interval for data logging
- Display of the measured value trend for each logging channel in the form of a chart

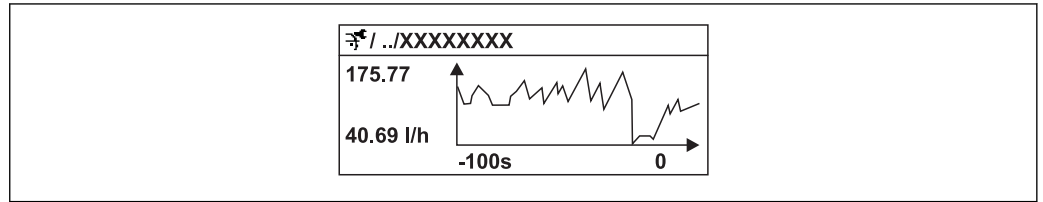

A0016222

28 Chart of a measured value trend

- x-axis: depending on the number of channels selected displays 250 to 1000 measured values of a process variable.
- y-axis: displays the approximate measured value span and constantly adapts this to the ongoing measurement.

**i** If the length of the logging interval or the assignment of the process variables to the channels is changed, the content of the data logging is deleted.

**Navigation**

"Diagnostics" menu → Data logging

► Data logging	
Assign channel 1...4	→ 112
Logging interval	→ 112
Clear logging data	→ 112
Data logging	→ 112
Logging delay	→ 112
Data logging control	→ 112
Data logging status	→ 112
Entire logging duration	→ 112

## Parameter overview with brief description

Parameter	Prerequisite	Description	Selection / User entry / User interface	Factory setting
Assign channel 1 to n	The <b>Extended HistorOM</b> application package is available.	Assign process variable to logging channel.	<ul style="list-style-type: none"> <li>▪ Off</li> <li>▪ Volume flow</li> <li>▪ Mass flow</li> <li>▪ Corrected volume flow</li> <li>▪ Flow velocity</li> <li>▪ Temperature</li> <li>▪ Electronic temperature</li> <li>▪ Current output 1 *</li> </ul>	Off
Logging interval	The <b>Extended HistorOM</b> application package is available.	Define the logging interval for data logging. This value defines the time interval between the individual data points in the memory.	0.1 to 999.0 s	1.0 s
Clear logging data	The <b>Extended HistorOM</b> application package is available.	Clear the entire logging data.	<ul style="list-style-type: none"> <li>▪ Cancel</li> <li>▪ Clear data</li> </ul>	Cancel
Data logging	–	Select the data logging method.	<ul style="list-style-type: none"> <li>▪ Overwriting</li> <li>▪ Not overwriting</li> </ul>	Overwriting
Logging delay	In the <b>Data logging</b> parameter, the <b>Not overwriting</b> option is selected.	Enter the time delay for measured value logging.	0 to 999 h	0 h
Data logging control	In the <b>Data logging</b> parameter, the <b>Not overwriting</b> option is selected.	Start and stop measured value logging.	<ul style="list-style-type: none"> <li>▪ None</li> <li>▪ Delete + start</li> <li>▪ Stop</li> </ul>	None
Data logging status	In the <b>Data logging</b> parameter, the <b>Not overwriting</b> option is selected.	Displays the measured value logging status.	<ul style="list-style-type: none"> <li>▪ Done</li> <li>▪ Delay active</li> <li>▪ Active</li> <li>▪ Stopped</li> </ul>	Done
Entire logging duration	In the <b>Data logging</b> parameter, the <b>Not overwriting</b> option is selected.	Displays the total logging duration.	Positive floating-point number	0 s

\* Visibility depends on order options or device settings



## 12 Diagnostics and troubleshooting

### 12.1 General troubleshooting





*For local display*

Error	Possible causes	Solution
Local display dark and no output signals	Supply voltage does not match the value indicated on the nameplate.	Apply the correct supply voltage → 40 → 40.
Local display dark and no output signals	No contact between connecting cables and terminals.	Check the connection of the cables and correct if necessary.
Local display dark and no output signals	Terminals are not plugged into the main electronics module correctly.	Check terminals.
Local display dark and no output signals	Main electronics module is defective.	Order spare part → 133.
Local display dark and no output signals	The connector between the main electronics module and display module is not plugged in correctly.	Check the connection and correct if necessary.
Local display dark and no output signals	The connecting cable is not plugged in correctly.	<ol style="list-style-type: none"> <li>1. Check the connection of the electrode cable and correct if necessary.</li> <li>2. Check the connection of the coil current cable and correct if necessary.</li> </ol>
Local display is dark, but signal output is within the valid range	Display is set too bright or too dark.	<ul style="list-style-type: none"> <li>▪ Set the display brighter by simultaneously pressing <math>\oplus</math> + <math>\boxtimes</math>.</li> <li>▪ Set the display darker by simultaneously pressing <math>\ominus</math> + <math>\boxtimes</math>.</li> </ul>
Local display is dark, but signal output is within the valid range	Display module is defective.	Order spare part → 133.
Backlighting of local display is red	Diagnostic event with "Alarm" diagnostic behavior has occurred.	Take remedial measures
Text on local display appears in a foreign language and cannot be understood.	Incorrect operating language is configured.	<ol style="list-style-type: none"> <li>1. Press <math>\ominus</math> + <math>\oplus</math> for 2 s ("home position").</li> <li>2. Press <math>\boxtimes</math>.</li> <li>3. Set the desired language in the <b>Display language</b> parameter (→ 97).</li> </ol>
Message on local display: "Communication Error" "Check Electronics"	Communication between the display module and the electronics is interrupted.	<ul style="list-style-type: none"> <li>▪ Check the cable and the connector between the main electronics module and display module.</li> <li>▪ Order spare part → 133.</li> </ul>

*For output signals*

Error	Possible causes	Solution
Signal output outside the valid range	Main electronics module is defective.	Order spare part → 133.
Device shows correct value on local display, but signal output is incorrect, though in the valid range.	Configuration error	Check and correct the parameter configuration.
Device measures incorrectly.	Configuration error or device is operated outside the application.	<ol style="list-style-type: none"> <li>1. Check and correct parameter configuration.</li> <li>2. Observe limit values specified in the "Technical Data".</li> </ol>

*For access*

Error	Possible causes	Solution
No write access to parameters	Hardware write protection enabled	Set the write protection switch on main electronics module to the <b>OFF</b> position →  104.
No write access to parameters	Current user role has limited access authorization	1. Check user role →  59. 2. Enter correct customer-specific access code →  59.
No connection via HART protocol	Communication resistor missing or incorrectly installed.	Install the communication resistor (250 Ω) correctly. Observe the maximum load →  140.
No connection via HART protocol	Commbobox <ul style="list-style-type: none"> <li>▪ Connected incorrectly</li> <li>▪ Configured incorrectly</li> <li>▪ Drivers not installed correctly</li> <li>▪ USB interface on computer configured incorrectly</li> </ul>	Observe the documentation for the Commbobox.  FXA195 HART: Document "Technical Information" TI00404F
Not connecting to Web server	Web server disabled	Using the "FieldCare" or "DeviceCare" operating tool, check whether the Web server of the measuring device is enabled, and enable it if necessary →  65.
	Incorrect setting for the Ethernet interface of the computer	1. Check the properties of the Internet protocol (TCP/IP) . 2. Check the network settings with the IT manager.
Not connecting to Web server	Incorrect IP address	Check the IP address: 192.168.1.212
Not connecting to Web server	Incorrect WLAN access data	<ul style="list-style-type: none"> <li>▪ Check WLAN network status.</li> <li>▪ Log on to the device again using WLAN access data.</li> <li>▪ Verify that WLAN is enabled on the measuring device and operating device .</li> </ul>
	WLAN communication disabled	–
Not connecting to Web server, FieldCare or DeviceCare	No WLAN network available	<ul style="list-style-type: none"> <li>▪ Check if WLAN reception is present: LED on display module is lit blue</li> <li>▪ Check if WLAN connection is enabled: LED on display module flashes blue</li> <li>▪ Switch on instrument function.</li> </ul>
	WLAN network is weak.	Operating device is outside of reception range: Check network status on operating device.
Network connection not present or unstable	Parallel WLAN and Ethernet communication	<ul style="list-style-type: none"> <li>▪ Check network settings.</li> <li>▪ Temporarily enable only the WLAN as an interface.</li> </ul>
Web browser frozen and operation no longer possible	Data transfer active	Wait until data transfer or current action is finished.
	Connection lost	1. Check cable connection and power supply. 2. Refresh the Web browser and restart if necessary.
Content of Web browser incomplete or difficult to read	Not using optimum version of Web server.	1. Use the correct Web browser version . 2. Clear the Web browser cache and restart the Web browser.
	Unsuitable view settings.	Change the font size/display ratio of the Web browser.

Error	Possible causes	Solution
No or incomplete display of contents in the Web browser	<ul style="list-style-type: none"> <li>▪ JavaScript not enabled</li> <li>▪ JavaScript cannot be enabled</li> </ul>	<ol style="list-style-type: none"> <li>1. Enable JavaScript.</li> <li>2. Enter <code>http://192.168.1.212/basic.html</code> as the IP address.</li> </ol>
Operation with FieldCare or DeviceCare via CDI-RJ45 service interface (port 8000)	Firewall of computer or network is preventing communication	Depending on the settings of the firewall used on the computer or in the network, the firewall must be adapted or disabled to allow FieldCare/DeviceCare access.
Flashing of firmware with FieldCare or DeviceCare via CDI-RJ45 service interface (via port 8000 or TFTP ports)	Firewall of computer or network is preventing communication	Depending on the settings of the firewall used on the computer or in the network, the firewall must be adapted or disabled to allow FieldCare/DeviceCare access.

## 12.2 Diagnostic information via light emitting diodes

### 12.2.1 Transmitter

Different LEDs in the transmitter provide information on the device status.

LED	Color	Meaning
Supply voltage	Off	Supply voltage is off or too low
	Green	Supply voltage is ok
Link/Activity	Orange	Link available but no activity
	Flashing orange	Activity present
Communication	Flashing white	HART communication is active.
Alarm	Green	Measuring device is ok
	Flashing green	Measuring device not configured
	Off	Firmware error
	Red	Main error
	Flashing red	Error
	Flashing red/green	Start measuring device

## 12.3 Diagnostic information on local display

### 12.3.1 Diagnostic message

Faults detected by the self-monitoring system of the measuring device are displayed as a diagnostic message in alternation with the operational display.

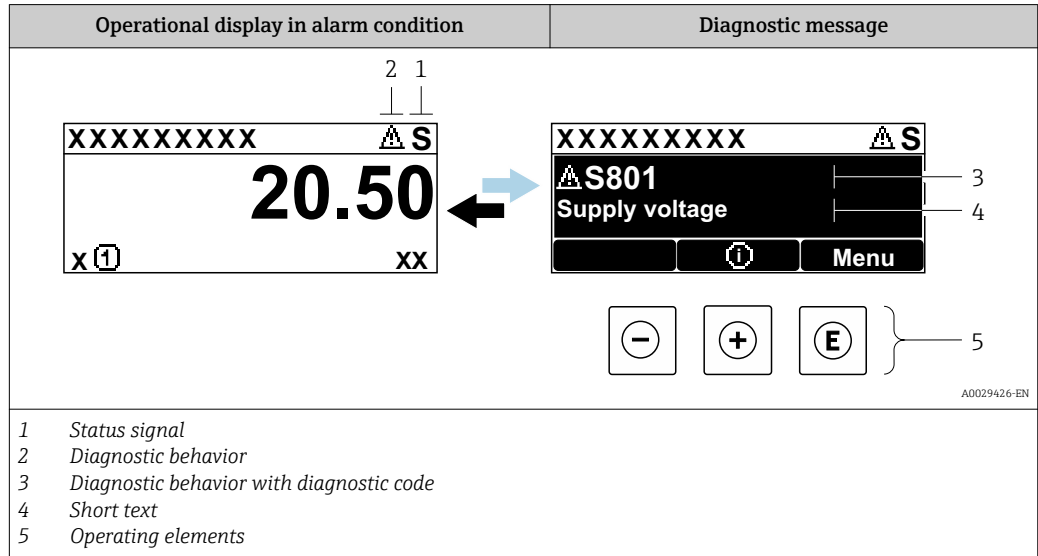

If two or more diagnostic events are pending simultaneously, only the message of the diagnostic event with the highest priority is shown.

- i** Other diagnostic events that have occurred can be displayed in the **Diagnostics** menu:
  - Via parameter
  - Via submenus → 126



#### Status signals

The status signals provide information on the state and reliability of the device by categorizing the cause of the diagnostic information (diagnostic event).

- i** The status signals are categorized according to VDI/VDE 2650 and NAMUR Recommendation NE 107: F = Failure, C = Function Check, S = Out of Specification, M = Maintenance Required

Symbol	Meaning
<b>F</b>	<b>Failure</b> A device error has occurred. The measured value is no longer valid.
<b>C</b>	<b>Function check</b> The device is in service mode (e.g. during a simulation).
<b>S</b>	<b>Out of specification</b> The device is operated: <ul style="list-style-type: none"> <li>▪ Outside its technical specification limits (e.g. outside the process temperature range)</li> <li>▪ Outside of the configuration carried out by the user (e.g. maximum flow in parameter 20 mA value)</li> </ul>
<b>M</b>	<b>Maintenance required</b> Maintenance is required. The measured value remains valid.

### Diagnostic behavior



Symbol	Meaning
	<b>Alarm</b> <ul style="list-style-type: none"> <li>Measurement is interrupted.</li> <li>Signal outputs and totalizers assume the defined alarm condition.</li> <li>A diagnostic message is generated.</li> <li>The background lighting changes to red.</li> </ul>
	<b>Warning</b> Measurement is resumed. The signal outputs and totalizers are not affected. A diagnostic message is generated.

### Diagnostic information

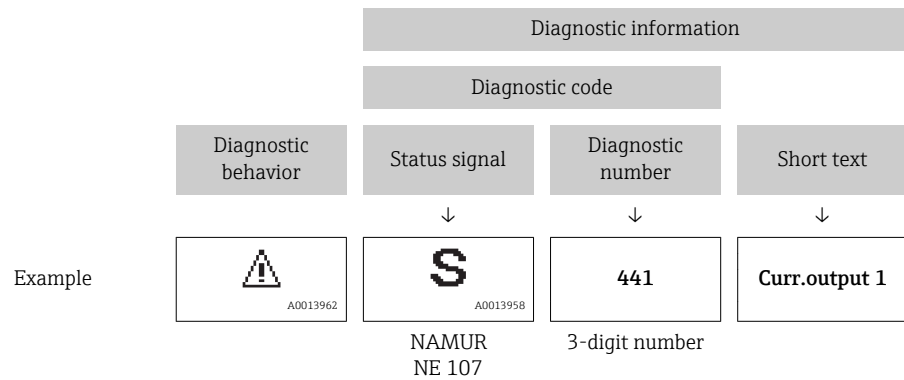
The fault can be identified using the diagnostic information. The short text helps you by providing information about the fault. In addition, the corresponding symbol for the diagnostic behavior is displayed in front of the diagnostic information on the local display.



### Operating elements

Key	Meaning
	<b>Plus key</b> <i>In a menu, submenu</i> Opens the message about remedy information.
	<b>Enter key</b> <i>In a menu, submenu</i> Opens the operating menu.

### 12.3.2 Calling up remedial measures

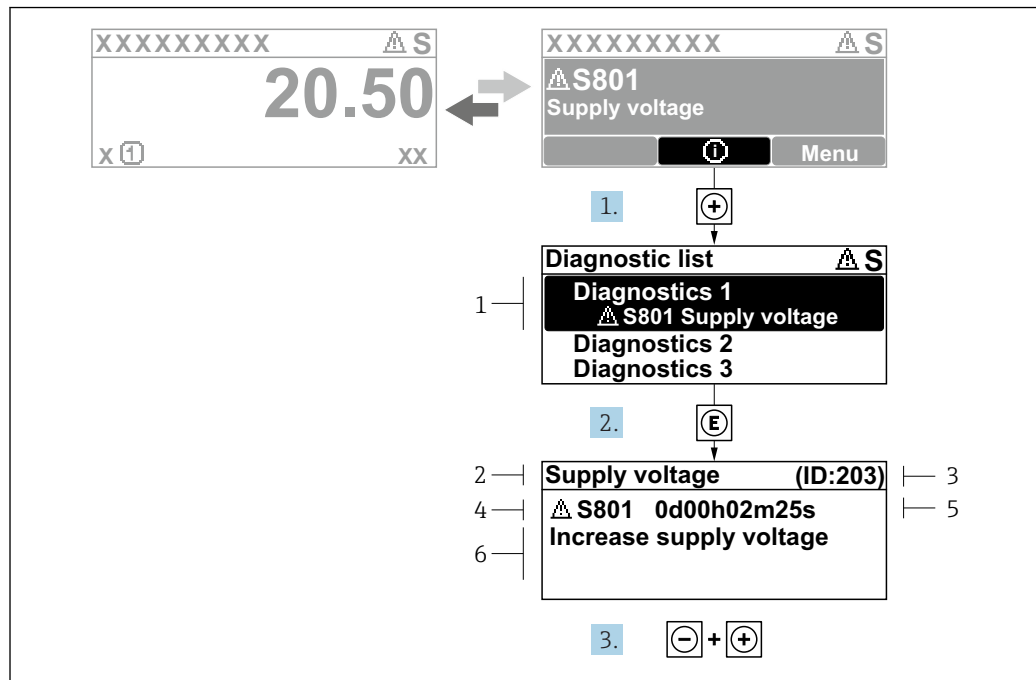

29 Message for remedial measures

- 1 Diagnostic information
- 2 Short text
- 3 Service ID
- 4 Diagnostic behavior with diagnostic code
- 5 Operation time of occurrence
- 6 Remedial measures

The user is in the diagnostic message.

1. Press  $\oplus$  ( $\textcircled{1}$  symbol).
  - ↳ The **Diagnostic list** submenu opens.
2. Select the desired diagnostic event with  $\oplus$  or  $\ominus$  and press  $\textcircled{E}$ .
  - ↳ The message for the remedial measures for the selected diagnostic event opens.
3. Press  $\ominus + \oplus$  simultaneously.
  - ↳ The message for the remedial measures closes.

The user is in the **Diagnostics** menu at an entry for a diagnostics event, e.g. in the **Diagnostic list** submenu or **Previous diagnostics** parameter.

1. Press  $\textcircled{E}$ .
  - ↳ The message for the remedial measures for the selected diagnostic event opens.
2. Press  $\ominus + \oplus$  simultaneously.
  - ↳ The message for the remedial measures closes.

## 12.4 Diagnostic information in the Web browser

### 12.4.1 Diagnostic options

Any faults detected by the measuring device are displayed in the Web browser on the home page once the user has logged on.

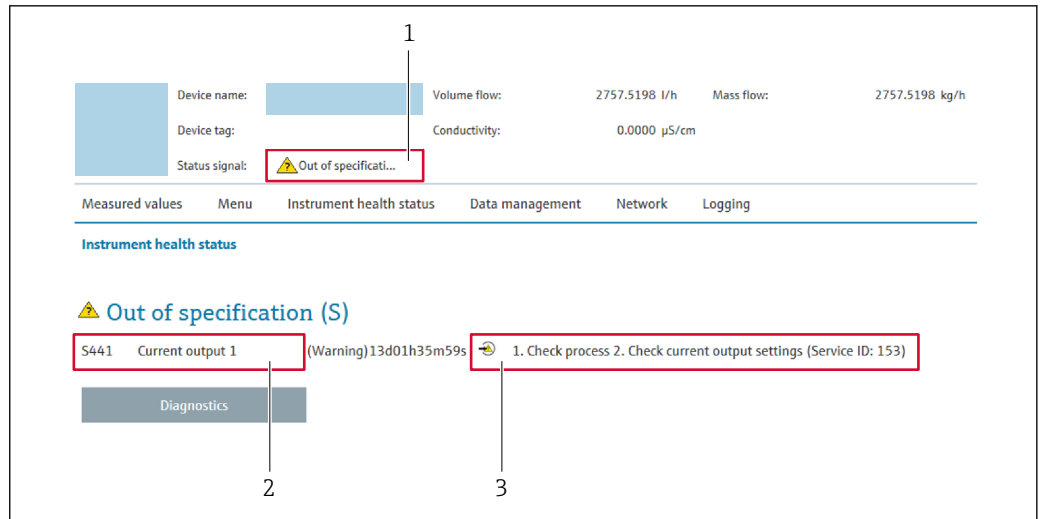

- 1 Status area with status signal
- 2 Diagnostic information → 117
- 3 Remedy information with Service ID

**i** In addition, diagnostic events which have occurred can be shown in the **Diagnostics** menu:

- Via parameter
- Via submenu → 126

### Status signals

The status signals provide information on the state and reliability of the device by categorizing the cause of the diagnostic information (diagnostic event).

Symbol	Meaning
	<b>Failure</b> A device error has occurred. The measured value is no longer valid.
	<b>Function check</b> The device is in service mode (e.g. during a simulation).
	<b>Out of specification</b> The device is operated: <ul style="list-style-type: none"> <li>▪ Outside its technical specification limits (e.g. outside the process temperature range)</li> <li>▪ Outside of the configuration carried out by the user (e.g. maximum flow in parameter <b>20 mA value</b>)</li> </ul>
	<b>Maintenance required</b> Maintenance is required. The measured value is still valid.

**i** The status signals are categorized in accordance with VDI/VDE 2650 and NAMUR Recommendation NE 107.

### 12.4.2 Calling up remedy information

Remedy information is provided for every diagnostic event to ensure that problems can be rectified quickly. These measures are displayed in red along with the diagnostic event and the related diagnostic information.

## 12.5 Diagnostic information in DeviceCare or FieldCare

### 12.5.1 Diagnostic options

Any faults detected by the measuring device are displayed on the home page of the operating tool once the connection has been established.

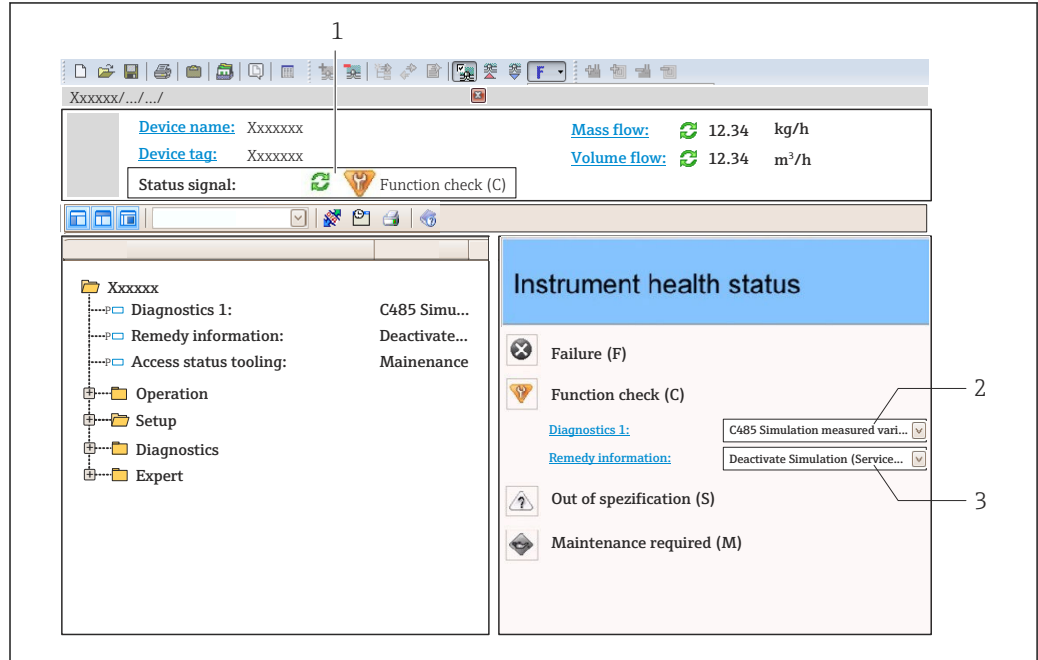

A0021799-EN

- 1 Status area with status signal → 116
- 2 Diagnostic information → 117
- 3 Remedy information with Service ID

**i** In addition, diagnostic events which have occurred can be shown in the **Diagnostics** menu:

- Via parameter
- Via submenu → 126

### Diagnostic information

The fault can be identified using the diagnostic information. The short text helps you by providing information about the fault. In addition, the corresponding symbol for the diagnostic behavior is displayed in front of the diagnostic information on the local display.

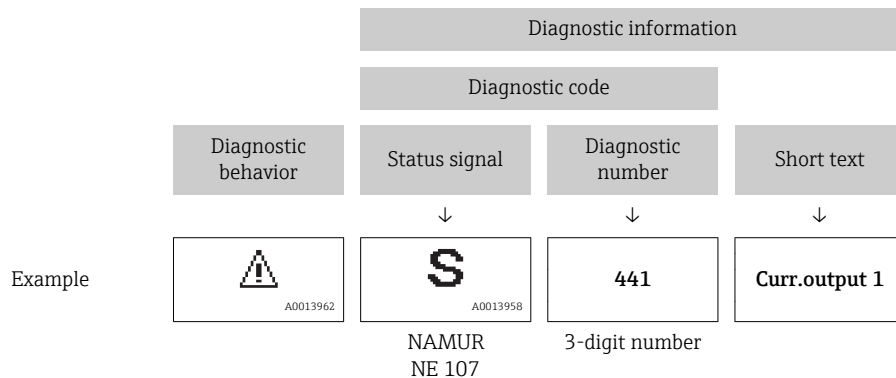



### 12.5.2 Calling up remedy information

Remedy information is provided for every diagnostic event to ensure that problems can be rectified quickly:

- On the home page  
Remedy information is displayed in a separate field below the diagnostics information.
- In the **Diagnostics** menu  
Remedy information can be called up in the working area of the user interface.

The user is in the **Diagnostics** menu.

1. Call up the desired parameter.
2. On the right in the working area, mouse over the parameter.
  - ↳ A tool tip with remedy information for the diagnostic event appears.

## 12.6 Adapting the diagnostic information

### 12.6.1 Adapting the diagnostic behavior

Each item of diagnostic information is assigned a specific diagnostic behavior at the factory. The user can change this assignment for specific diagnostic information in the **Diagnostic behavior** submenu.

Expert → System → Diagnostic handling → Diagnostic behavior

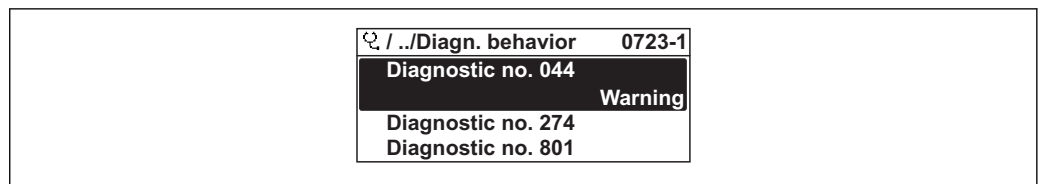

A0014048-EN

30 Taking the example of the local display

You can assign the following options to the diagnostic number as the diagnostic behavior:

Options	Description
Alarm	The device stops measurement. The signal outputs and totalizers assume the defined alarm condition. A diagnostic message is generated. The background lighting changes to red.
Warning	The device continues to measure. The signal outputs and totalizers are not affected. A diagnostic message is generated.
Logbook entry only	The device continues to measure. The diagnostic message is displayed only in the <b>Event logbook</b> submenu ( <b>Event list</b> submenu) and is not displayed in alternation with the operational display.
Off	The diagnostic event is ignored, and no diagnostic message is generated or entered.

### 12.6.2 Adapting the status signal

Each item of diagnostic information is assigned a specific status signal at the factory. The user can change this assignment for specific diagnostic information in the **Diagnostic event category** submenu.

Expert → Communication → Diagnostic event category



### Available status signals

Configuration as per HART 7 Specification (Condensed Status), in accordance with NAMUR NE107.

Symbol	Meaning
<b>F</b> <small>A0013956</small>	<b>Failure</b> A device error is present. The measured value is no longer valid.
<b>C</b> <small>A0013959</small>	<b>Function check</b> The device is in service mode (e.g. during a simulation).
<b>S</b> <small>A0013958</small>	<b>Out of specification</b> The device is being operated: <ul style="list-style-type: none"> <li>▪ Outside its technical specification limits (e.g. outside the process temperature range)</li> <li>▪ Outside of the configuration carried out by the user (e.g. maximum flow in parameter <b>20 mA value</b>)</li> </ul>
<b>M</b> <small>A0013957</small>	<b>Maintenance required</b> Maintenance is required. The measured value is still valid.
<b>N</b> <small>A0023076</small>	Has no effect on the condensed status.

## 12.7 Overview of diagnostic information

 The amount of diagnostic information and the number of measured variables affected increase if the measuring device has one or more application packages.

 In the case of some items of diagnostic information, the status signal and the diagnostic behavior can be changed. Change the diagnostic information →  12.1

Diagnostic number	Short text	Remedy instructions	Status signal [from the factory]	Diagnostic behavior [from the factory]
<b>Diagnostic of sensor</b>				
043	Sensor short circuit	1. Check sensor cable and sensor 2. Execute Heartbeat Verification 3. Replace sensor cable or sensor	S	Warning <sup>1)</sup>
082	Data storage	1. Check module connections 2. Contact service	F	Alarm
083	Memory content	1. Restart device 2. Restore HistoROM S-DAT backup ('Device reset' parameter) 3. Replace HistoROM S-DAT	F	Alarm
170	Coil resistance	Check ambient and process temperature	F	Alarm
180	Temperature sensor defective	1. Check sensor connections 2. Replace sensor cable or sensor 3. Turn off temperature measurement	F	Warning
181	Sensor connection	1. Check sensor cable and sensor 2. Execute Heartbeat Verification 3. Replace sensor cable or sensor	F	Alarm
<b>Diagnostic of electronic</b>				
201	Device failure	1. Restart device 2. Contact service	F	Alarm

Diagnostic number	Short text	Remedy instructions	Status signal [from the factory]	Diagnostic behavior [from the factory]
242	Software incompatible	1. Check software 2. Flash or change main electronics module	F	Alarm
252	Modules incompatible	1. Check electronic modules 2. Change electronic modules	F	Alarm
261	Electronic modules	1. Restart device 2. Check electronic modules 3. Change I/O Modul or main electronics	F	Alarm
262	Sensor electronic connection faulty	1. Check or replace connection cable between sensor electronic module (ISEM) and main electronics 2. Check or replace ISEM or main electronics	F	Alarm
270	Main electronic failure	Change main electronic module	F	Alarm
271	Main electronic failure	1. Restart device 2. Change main electronic module	F	Alarm
272	Main electronic failure	1. Restart device 2. Contact service	F	Alarm
273	Main electronic failure	Change electronic	F	Alarm
275	I/O module defective	Change I/O module	F	Alarm
276	I/O module faulty	1. Restart device 2. Change I/O module	F	Alarm
283	Memory content	1. Reset device 2. Contact service	F	Alarm
302	Device verification active	Device verification active, please wait.	C	Warning
311	Electronic failure	1. Do not reset device 2. Contact service	M	Warning
372	Sensor electronic (ISEM) faulty	1. Restart device 2. Check if failure recurs 3. Replace sensor electronic module (ISEM)	F	Alarm
373	Sensor electronic (ISEM) faulty	1. Transfer data or reset device 2. Contact service	F	Alarm
375	I/O- communication failed	1. Restart device 2. Check if failure recurs 3. Replace module rack inclusive electronic modules	F	Alarm
376	Sensor electronic (ISEM) faulty	1. Replace sensor electronic module (ISEM) 2. Turn off diagnostic message	F	Warning <sup>1)</sup>
377	Sensor electronic (ISEM) faulty	1. Check sensor cable and sensor 2. Perform Heartbeat Verification 3. Replace sensor cable or sensor	F	Warning <sup>1)</sup>
382	Data storage	1. Insert T-DAT 2. Replace T-DAT	F	Alarm
383	Memory content	1. Restart device 2. Delete T-DAT via 'Reset device' parameter 3. Replace T-DAT	F	Alarm
512	Sensor electronic (ISEM) faulty	1. Check ECC recovery time 2. Turn off ECC	F	Alarm

Diagnostic number	Short text	Remedy instructions	Status signal [from the factory]	Diagnostic behavior [from the factory]
<b>Diagnostic of configuration</b>				
410	Data transfer	1. Check connection 2. Retry data transfer	F	Alarm
412	Processing download	Download active, please wait	C	Warning
431	Trim 1	Carry out trim	C	Warning
437	Configuration incompatible	1. Restart device 2. Contact service	F	Alarm
438	Dataset	1. Check data set file 2. Check device configuration 3. Up- and download new configuration	M	Warning
441	Current output	1. Check process 2. Check current output settings	S	Warning <sup>1)</sup>
442	Frequency output 1 to n	1. Check process 2. Check frequency output settings	S	Warning <sup>1)</sup>
443	Pulse output 1 to n	1. Check process 2. Check pulse output settings	S	Warning <sup>1)</sup>
453	Flow override	Deactivate flow override	C	Warning
484	Failure mode simulation	Deactivate simulation	C	Alarm
485	Measured variable simulation	Deactivate simulation	C	Warning
491	Current output 1 simulation	Deactivate simulation	C	Warning
492	Simulation frequency output 1 to n	Deactivate simulation frequency output	C	Warning
493	Simulation pulse output 1 to n	Deactivate simulation pulse output	C	Warning
494	Switch output simulation 1 to n	Deactivate simulation switch output	C	Warning
495	Diagnostic event simulation	Deactivate simulation	C	Warning
496	Status input simulation	Deactivate simulation status input	C	Warning
502	CT activation/ deactivation failed	Follow the sequence of the custody transfer activation/deactivation: First authorized user login, then set the DIP switch on the main electronic module	C	Warning
511	Sensor electronic (ISEM) faulty	1. Check measuring period and integration time 2. Check sensor properties	C	Alarm
530	Electrode cleaning is running	Turn off ECC	C	Warning
531	Empty pipe detection	Execute EPD adjustment	S	Warning <sup>1)</sup>
537	Configuration	1. Check IP addresses in network 2. Change IP address	F	Warning
540	Custody transfer mode failed	1. Deactivate custody transfer mode 2. Reactivate custody transfer mode	F	Alarm
599	Custody transfer logbook full	1. Deactivate custody transfer mode 2. Clear custody transfer logbook (all 30 entries) 3. Activate custody transfer mode	F	Warning





Diagnostic number	Short text	Remedy instructions	Status signal [from the factory]	Diagnostic behavior [from the factory]
<b>Diagnostic of process</b>				
803	Current loop	1. Check wiring 2. Change I/O module	F	Alarm
832	Electronic temperature too high	Reduce ambient temperature	S	Warning <sup>1)</sup>
833	Electronic temperature too low	Increase ambient temperature	S	Warning <sup>1)</sup>
834	Process temperature too high	Reduce process temperature	S	Warning <sup>1)</sup>
835	Process temperature too low	Increase process temperature	S	Warning <sup>1)</sup>
842	Process limit	Low flow cut off active! 1. Check low flow cut off configuration	S	Warning
882	Input signal	1. Check input configuration 2. Check external device or process conditions	F	Alarm
937	EMC interference	1. Eliminate external magnetic field near sensor 2. Turn off diagnostic message	S	Warning <sup>1)</sup>
938	EMC interference	1. Check ambient conditions regarding EMC influence 2. Turn off diagnostic message	F	Alarm <sup>1)</sup>
962	Empty pipe	1. Perform full pipe adjustment 2. Perform empty pipe adjustment 3. Turn off empty pipe detection	S	Warning <sup>1)</sup>



1) Diagnostic behavior can be changed.

## 12.8 Pending diagnostic events

The **Diagnostics** menu allows the user to view the current diagnostic event and the previous diagnostic event separately.



 To call up the measures to rectify a diagnostic event:

- Via local display →  118
- Via Web browser →  119
- Via "FieldCare" operating tool →  121
- Via "DeviceCare" operating tool →  121

 Other pending diagnostic events can be displayed in the **Diagnostic list** submenu →  126

### Navigation

"Diagnostics" menu

 <b>Diagnostics</b>	
Actual diagnostics	→  126
Previous diagnostics	→  126

Operating time from restart	→ ⓘ 126
Operating time	→ ⓘ 126

### Parameter overview with brief description

Parameter	Prerequisite	Description	User interface
Actual diagnostics	A diagnostic event has occurred.	Shows the current occurred diagnostic event along with its diagnostic information.  ⓘ If two or more messages occur simultaneously, the message with the highest priority is shown on the display.	Symbol for diagnostic behavior, diagnostic code and short message.
Previous diagnostics	Two diagnostic events have already occurred.	Shows the diagnostic event that occurred prior to the current diagnostic event along with its diagnostic information.	Symbol for diagnostic behavior, diagnostic code and short message.
Operating time from restart	–	Shows the time the device has been in operation since the last device restart.	Days (d), hours (h), minutes (m) and seconds (s)
Operating time	–	Indicates how long the device has been in operation.	Days (d), hours (h), minutes (m) and seconds (s)

## 12.9 Diagnostic list

Up to 5 currently pending diagnostic events can be displayed in the **Diagnostic list** submenu along with the associated diagnostic information. If more than 5 diagnostic events are pending, the events with the highest priority are shown on the display.

### Navigation path

Diagnostics → Diagnostic list

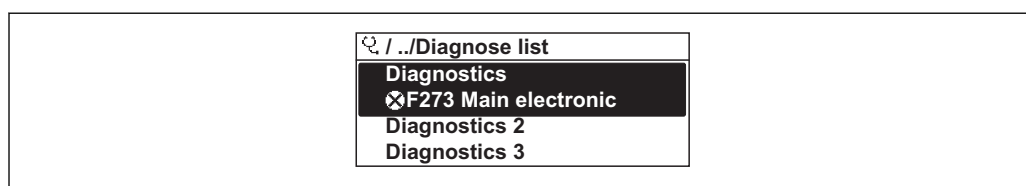

A0014006-EN

31 Taking the example of the local display

ⓘ To call up the measures to rectify a diagnostic event:

- Via local display → ⓘ 118
- Via Web browser → ⓘ 119
- Via "FieldCare" operating tool → ⓘ 121
- Via "DeviceCare" operating tool → ⓘ 121

## 12.10 Event logbook

### 12.10.1 Event history

A chronological overview of the event messages that have occurred is provided in the **Events list** submenu.

**Navigation path**

**Diagnostics** menu → **Event logbook** submenu → Event list

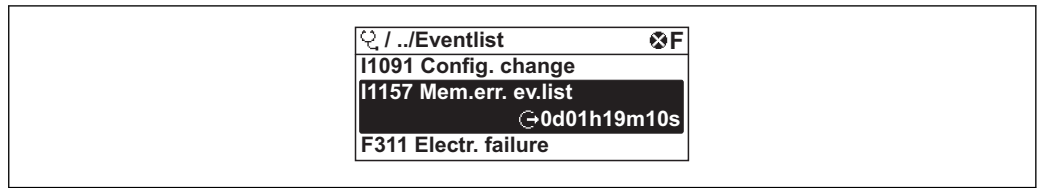

A0014008-EN

32 Taking the example of the local display

- Max. 20 event messages can be displayed in chronological order.
- If the **Extended HistoROM** application package (order option) is enabled in the device, the event list can contain up to 100 entries .

The event history includes entries for:

- Diagnostic events → 122
- Information events → 127

In addition to the operation time of its occurrence, each event is also assigned a symbol that indicates whether the event has occurred or is ended:

- Diagnostic event
  - ⌚: Occurrence of the event
  - ⌚: End of the event
- Information event
  - ⌚: Occurrence of the event

**i** To call up the measures to rectify a diagnostic event:

- Via local display → 118
- Via Web browser → 119
- Via "FieldCare" operating tool → 121
- Via "DeviceCare" operating tool → 121

**i** For filtering the displayed event messages → 127

**12.10.2 Filtering the event logbook**

Using the **Filter options** parameter you can define which category of event message is displayed in the **Events list** submenu.

**Navigation path**

Diagnostics → Event logbook → Filter options

**Filter categories**

- All
- Failure (F)
- Function check (C)
- Out of specification (S)
- Maintenance required (M)
- Information (I)

**12.10.3 Overview of information events**

Unlike a diagnostic event, an information event is displayed in the event logbook only and not in the diagnostic list.

Info number	Info name
I1000	----- (Device ok)
I1079	Sensor changed

Info number	Info name
I1089	Power on
I1090	Configuration reset
I1091	Configuration changed
I1092	Embedded HistoROM deleted
I1137	Electronic changed
I1151	History reset
I1155	Reset electronic temperature
I1156	Memory error trend
I1157	Memory error event list
I1184	Display connected
I1256	Display: access status changed
I1278	I/O module reset detected
I1335	Firmware changed
I1351	Empty pipe detection adjustment failure
I1353	Empty pipe detection adjustment ok
I1361	Web server login failed
I1397	Fieldbus: access status changed
I1398	CDI: access status changed
I1443	Coating thickness not determined
I1444	Device verification passed
I1445	Device verification failed
I1457	Measured error verification failed
I1459	I/O module verification failed
I1461	Sensor verification failed
I1462	Sensor electronic module verific. failed
I1512	Download started
I1513	Download finished
I1514	Upload started
I1515	Upload finished
I1517	Custody transfer active
I1518	Custody transfer inactive
I1622	Calibration changed
I1624	Reset all totalizers
I1625	Write protection activated
I1626	Write protection deactivated
I1627	Web server login successful
I1628	Display login successful
I1629	CDI login successful
I1631	Web server access changed
I1632	Display login failed
I1633	CDI login failed
I1634	Parameter factory reset
I1635	Parameter delivery reset



Info number	Info name
I1643	Custody transfer logbook cleared
I1649	Hardware write protection activated
I1650	Hardware write protection deactivated
I1651	Custody transfer parameter changed
I1725	Sensor electronic module (ISEM) changed

## 12.11 Resetting the measuring device

Using the **Device reset** parameter (→ ⓘ 101) it is possible to reset the entire device configuration or some of the configuration to a defined state.

### 12.11.1 Function scope of the "Device reset" parameter

Options	Description
Cancel	No action is executed and the user exits the parameter.
To delivery settings	Every parameter for which a customer-specific default setting was ordered is reset to this customer-specific value. All other parameters are reset to the factory setting.
Restart device	The restart resets every parameter whose data are in the volatile memory (RAM) to the factory setting (e.g. measured value data). The device configuration remains unchanged.

## 12.12 Device information

The **Device information** submenu contains all parameters that display different information for device identification.





### Navigation

"Diagnostics" menu → Device information

▶ Device information	
Device tag	→ ⓘ 130
Serial number	→ ⓘ 130
Firmware version	→ ⓘ 130
Device name	→ ⓘ 130
Order code	→ ⓘ 130
Extended order code 1	→ ⓘ 130
Extended order code 2	→ ⓘ 130
Extended order code 3	→ ⓘ 130

ENP version	→ ⓘ 130
Device revision	→ ⓘ 130
Device ID	→ ⓘ 130
Device type	→ ⓘ 131
Manufacturer ID	→ ⓘ 131

### Parameter overview with brief description

Parameter	Description	User interface	Factory setting
Device tag	Shows name of measuring point.	Max. 32 characters, such as letters, numbers or special characters (e.g. @, %, /).	Promag 400
Serial number	Shows the serial number of the measuring device.	A maximum of 11-digit character string comprising letters and numbers.	–
Firmware version	Shows the device firmware version installed.	Character string in the format xx.yy.zz	–
Device name	Shows the name of the transmitter.  The name can be found on the nameplate of the transmitter.	Max. 32 characters such as letters or numbers.	Promag 400
Order code	Shows the device order code.  The order code can be found on the nameplate of the sensor and transmitter in the "Order code" field.	Character string composed of letters, numbers and certain punctuation marks (e.g. /).	–
Extended order code 1	Shows the 1st part of the extended order code.  The extended order code can also be found on the nameplate of the sensor and transmitter in the "Ext. ord. cd." field.	Character string	–
Extended order code 2	Shows the 2nd part of the extended order code.  The extended order code can also be found on the nameplate of the sensor and transmitter in the "Ext. ord. cd." field.	Character string	–
Extended order code 3	Shows the 3rd part of the extended order code.  The extended order code can also be found on the nameplate of the sensor and transmitter in the "Ext. ord. cd." field.	Character string	–
ENP version	Shows the version of the electronic nameplate (ENP).	Character string	2.02.00
Device revision	Shows the device revision with which the device is registered with the HART Communication Foundation.	2-digit hexadecimal number	8
Device ID	Shows the device ID for identifying the device in a HART network.	6-digit hexadecimal number	–

Parameter	Description	User interface	Factory setting
Device type	Shows the device type with which the measuring device is registered with the HART Communication Foundation.	2-digit hexadecimal number	0x69 (for Promag 400)
Manufacturer ID	Shows the manufacturer ID device is registered with the HART Communication Foundation.	2-digit hexadecimal number	0x11 (for Endress+Hauser)

## 12.13 Firmware history

Release date	Firmware version	Order code for "Firmware version"	Firmware changes	Documentation type	Documentation
10.2013	01.04.00	Option 76	Original firmware	Operating Instructions	BA01061D/06/EN/02.13
05.2014	01.05.00	Option 73	<ul style="list-style-type: none"> <li>▪ In accordance with HART 7 Specification</li> <li>▪ Integrated HART input</li> <li>▪ SD03 keypad lock</li> <li>▪ Modification of SIL functionality</li> <li>▪ HistoROM data logging in FieldCare "HistoROM" module</li> <li>▪ Simulation of diagnostic events</li> <li>▪ Ability to access Heartbeat Technology application package</li> </ul>	Operating Instructions	BA01061D/06/EN/03.14
11.2016	02.00.00	Option 71	Device type ID: 0x69 <ul style="list-style-type: none"> <li>▪ Web server: current version</li> <li>▪ Logbook: current concept, including Parameter Change</li> <li>▪ Upload/download: current concept</li> <li>▪ Heartbeat Technology: new hardware, diagnostics, events</li> <li>▪ Security concept: encrypted password transmission</li> <li>▪ WLAN</li> </ul>	Operating Instructions	BA01061D/06/EN/04.16

 It is possible to flash the firmware to the current version or the previous version using the service interface.

 For the compatibility of the firmware version with the previous version, the installed device description files and operating tools, observe the information about the device in the "Manufacturer's information" document.

 The manufacturer's information is available:

- In the Download Area of the Endress+Hauser web site: [www.endress.com](http://www.endress.com) → Downloads
- Specify the following details:
  - Text search: Manufacturer's information
  - Media type: Documentation – Technical Documentation

## 13 Maintenance

### 13.1 Maintenance tasks

No special maintenance work is required.

#### 13.1.1 Exterior cleaning

When cleaning the exterior of measuring devices, always use cleaning agents that do not attack the surface of the housing or the seals.

##### **WARNING**

**Cleaning agents can damage the plastic transmitter housing!**

- ▶ Do not use high-pressure steam.
- ▶ Only use the permitted cleaning agents specified.

**Permitted cleaning agents for the plastic transmitter housing**

- Commercially available household cleaners
- Methyl alcohol or isopropyl alcohol
- Mild soap solutions

#### 13.1.2 Interior cleaning

No interior cleaning is planned for the device.

#### 13.1.3 Replacing seals

The sensor's seals (particularly aseptic molded seals) must be replaced periodically.

The interval between changes depends on the frequency of the cleaning cycles, the cleaning temperature and the medium temperature.

Replacement seals (accessory) →  157

### 13.2 Measuring and test equipment

Endress+Hauser offers a wide variety of measuring and test equipment, such as W@M or device tests.

 Your Endress+Hauser Sales Center can provide detailed information on the services.

List of some of the measuring and testing equipment: →  135

### 13.3 Endress+Hauser services

Endress+Hauser offers a wide variety of services for maintenance such as recalibration, maintenance service or device tests.

 Your Endress+Hauser Sales Center can provide detailed information on the services.

## 14 Repairs

### 14.1 General notes

#### 14.1.1 Repair and conversion concept

The Endress+Hauser repair and conversion concept provides for the following:

- The measuring devices have a modular design.
- Spare parts are grouped into logical kits with the associated Installation Instructions.
- Repairs are carried out by Endress+Hauser Service or by appropriately trained customers.
- Certified devices can only be converted to other certified devices by Endress+Hauser Service or at the factory.

#### 14.1.2 Notes for repair and conversion

For repair and modification of a measuring device, observe the following notes:

- ▶ Use only original Endress+Hauser spare parts.
- ▶ Carry out the repair according to the Installation Instructions.
- ▶ Observe the applicable standards, federal/national regulations, Ex documentation (XA) and certificates.
- ▶ Document every repair and each conversion and enter them into the *W@M* life cycle management database.

### 14.2 Spare parts

*W@M Device Viewer* ([www.endress.com/deviceviewer](http://www.endress.com/deviceviewer)):

All the spare parts for the measuring device, along with the order code, are listed here and can be ordered. If available, users can also download the associated Installation Instructions.



Measuring device serial number:

- Is located on the nameplate of the device.
- Can be read out via the **Serial number** parameter (→  130) in the **Device information** submenu.

### 14.3 Endress+Hauser services

Endress+Hauser offers a wide range of services.



Your Endress+Hauser Sales Center can provide detailed information on the services.

### 14.4 Return

The measuring device must be returned if it is need of repair or a factory calibration, or if the wrong measuring device has been delivered or ordered. Legal specifications require Endress+Hauser, as an ISO-certified company, to follow certain procedures when handling products that are in contact with the medium.

To ensure safe, swift and professional device returns, please refer to the procedure and conditions for returning devices provided on the Endress+Hauser website at

<http://www.endress.com/support/return-material>

## 14.5 Disposal

### 14.5.1 Removing the measuring device

1. Switch off the device.

**⚠ WARNING**

**Danger to persons from process conditions.**

- ▶ Beware of hazardous process conditions such as pressure in the measuring device, high temperatures or aggressive fluids.

2. Carry out the mounting and connection steps from the "Mounting the measuring device" and "Connecting the measuring device" sections in reverse order. Observe the safety instructions.

### 14.5.2 Disposing of the measuring device

**⚠ WARNING**

**Danger to personnel and environment from fluids that are hazardous to health.**

- ▶ Ensure that the measuring device and all cavities are free of fluid residues that are hazardous to health or the environment, e.g. substances that have permeated into crevices or diffused through plastic.

Observe the following notes during disposal:

- ▶ Observe valid federal/national regulations.
- ▶ Ensure proper separation and reuse of the device components.

## 15 Accessories

Various accessories, which can be ordered with the device or subsequently from Endress+Hauser, are available for the device. Detailed information on the order code in question is available from your local Endress+Hauser sales center or on the product page of the Endress+Hauser website: [www.endress.com](http://www.endress.com).

### 15.1 Device-specific accessories





#### 15.1.1 For the transmitter



Accessories	Description
Display protection	Is used to protect the display against impact or scoring from sand in desert areas.  For details, see Special Documentation SD00333F
Connecting cable for remote version	Coil current and electrode cables, various lengths, reinforced cables available on request.
Post mounting kit	Post mounting kit for transmitter.
Compact → Remote conversion kit	For converting a compact device version to a remote device version.

#### 15.1.2 For the sensor



Accessories	Description
Mounting kit	Consists of: <ul style="list-style-type: none"> <li>▪ 2 process connections</li> <li>▪ Screws</li> <li>▪ Seals</li> </ul>

### 15.2 Communication-specific accessories

Accessories	Description
Commubox FXA195 HART	For intrinsically safe HART communication with FieldCare via the USB interface.  For details, see "Technical Information" TI00404F
Commubox FXA291	Connects Endress+Hauser field devices with a CDI interface (= Endress+Hauser Common Data Interface) and the USB port of a computer or laptop.  For details, see the "Technical Information" document TI405C/07
HART Loop Converter HMX50	Is used to evaluate and convert dynamic HART process variables to analog current signals or limit values.  For details, see "Technical Information" TI00429F and Operating Instructions BA00371F
Wireless HART adapter SWA70	Is used for the wireless connection of field devices. The WirelessHART adapter can be easily integrated into field devices and existing infrastructures, offers data protection and transmission safety and can be operated in parallel with other wireless networks with minimum cabling complexity.  For details, see Operating Instructions BA00061S
Fieldgate FXA320	Gateway for the remote monitoring of connected 4 to 20 mA measuring devices via a Web browser.  For details, see "Technical Information" TI00025S and Operating Instructions BA00053S

Fieldgate FXA520	Gateway for the remote diagnostics and remote configuration of connected HART measuring devices via a Web browser.  For details, see "Technical Information" TI00025S and Operating Instructions BA00051S
Field Xpert SFX350	Field Xpert SFX350 is a mobile computer for commissioning and maintenance. It enables efficient device configuration and diagnostics for HART and FOUNDATION Fieldbus devices in the <b>non-Ex area</b> .  For details, see Operating Instructions BA01202S
Field Xpert SFX370	Field Xpert SFX370 is a mobile computer for commissioning and maintenance. It enables efficient device configuration and diagnostics for HART and FOUNDATION Fieldbus devices in the <b>non-Ex area</b> and the <b>Ex area</b> .  For details, see Operating Instructions BA01202S

### 15.3 Service-specific accessories

Accessories	Description
Applicator	Software for selecting and sizing Endress+Hauser measuring devices: <ul style="list-style-type: none"> <li>Choice of measuring devices for industrial requirements</li> <li>Calculation of all the necessary data for identifying the optimum flowmeter: e.g. nominal diameter, pressure loss, flow velocity and accuracy.</li> <li>Graphic illustration of the calculation results</li> <li>Determination of the partial order code, administration, documentation and access to all project-related data and parameters over the entire life cycle of a project.</li> </ul> Applicator is available: <ul style="list-style-type: none"> <li>Via the Internet: <a href="https://wapps.endress.com/applicator">https://wapps.endress.com/applicator</a></li> <li>As a downloadable DVD for local PC installation.</li> </ul>
W@M	W@M Life Cycle Management Improved productivity with information at your fingertips. Data relevant to a plant and its components is generated from the first stages of planning and during the asset's complete life cycle. W@M Life Cycle Management is an open and flexible information platform with online and on-site tools. Instant access for your staff to current, in-depth data shortens your plant's engineering time, speeds up procurement processes and increases plant uptime. Combined with the right services, W@M Life Cycle Management boosts productivity in every phase. For more information, visit <a href="http://www.endress.com/lifecyclemanagement">www.endress.com/lifecyclemanagement</a>
FieldCare	FDT-based plant asset management tool from Endress+Hauser. It can configure all smart field units in your system and helps you manage them. By using the status information, it is also a simple but effective way of checking their status and condition.  For details, see Operating Instructions BA00027S and BA00059S
DeviceCare	Tool for connecting and configuring Endress+Hauser field devices.  For details, see Innovation brochure IN01047S



## 15.4 System components

Accessories	Description
Memograph M graphic display recorder	<p>The Memograph M graphic display recorder provides information on all relevant measured variables. Measured values are recorded correctly, limit values are monitored and measuring points analyzed. The data are stored in the 256 MB internal memory and also on a SD card or USB stick.</p> <p> For details, see "Technical Information" TI00133R and Operating Instructions BA00247R</p>

## 16 Technical data

### 16.1 Application

The measuring device described in this manual is intended only for flow measurement of liquids with a minimum conductivity of 5  $\mu\text{S/cm}$ .

Depending on the version ordered, the measuring device can also measure potentially explosive, flammable, poisonous and oxidizing media.

To ensure that the device remains in proper operating condition for its service life, use the measuring device only for media against which the process-wetted materials are sufficiently resistant.

### 16.2 Function and system design

Measuring principle Electromagnetic flow measurement on the basis of *Faraday's law of magnetic induction*.

Measuring system The device consists of a transmitter and a sensor.  
 Two device versions are available:  
 ■ Compact version – transmitter and sensor form a mechanical unit.  
 ■ Remote version - transmitter and sensor are mounted in separate locations.  
 For information on the structure of the device

### 16.3 Input

Measured variable **Direct measured variables**  
 Volume flow (proportional to induced voltage)

**Calculated measured variables**  
 Mass flow

Measuring range Typically  $v = 0.01$  to  $10$  m/s ( $0.03$  to  $33$  ft/s) with the specified accuracy  
 Electrical conductivity:  $\geq 5$   $\mu\text{S/cm}$  for liquids in general

*Flow characteristic values in SI units*

Nominal diameter		Recommended flow min./max. full scale value ( $v \sim 0.3/10$ m/s) [dm <sup>3</sup> /min]	Factory settings		
[mm]	[in]		Full scale value current output ( $v \sim 2.5$ m/s) [dm <sup>3</sup> /min]	Pulse value ( $\sim 2$ pulse/s) [dm <sup>3</sup> ]	Low flow cut off ( $v \sim 0.04$ m/s) [dm <sup>3</sup> /min]
25	1	9 to 300	75	0.5	1
40	1 ½	25 to 700	200	1.5	3
50	2	35 to 1100	300	2.5	5
65	–	60 to 2000	500	5	8
80	3	90 to 3000	750	5	12
100	4	145 to 4700	1200	10	20

*Flow characteristic values in US units*

Nominal diameter		Recommended flow min./max. full scale value (v ~ 0.3/10 m/s)	Factory settings		
[in]	[mm]		Full scale value current output (v ~ 2.5 m/s)	Pulse value (~ 2 pulse/s)	Low flow cut off (v ~ 0.04 m/s)
		[gal/min]	[gal/min]	[gal]	[gal/min]
1	25	2.5 to 80	18	0.2	0.25
1 ½	40	7 to 190	50	0.5	0.75
2	50	10 to 300	75	0.5	1.25
–	65	16 to 500	130	1	2
3	80	24 to 800	200	2	2.5
4	100	40 to 1250	300	2	4

**Recommended measuring range**

"Flow limit" section →  146

Operable flow range Over 1000 : 1

**Input signal****External measured values**

 Various pressure transmitters and temperature measuring devices can be ordered from Endress+Hauser: see "Accessories" section →  137

It is recommended to read in external measured values to calculate the following measured variables:

Corrected volume flow

*HART protocol*

The measured values are written from the automation system to the measuring device via the HART protocol. The pressure transmitter must support the following protocol-specific functions:

- HART protocol
- Burst mode

**Status input**

<b>Maximum input values</b>	<ul style="list-style-type: none"> <li>■ DC 30 V</li> <li>■ 6 mA</li> </ul>
<b>Response time</b>	Adjustable: 5 to 200 ms
<b>Input signal level</b>	<ul style="list-style-type: none"> <li>■ Low signal: DC -3 to +5 V</li> <li>■ High signal: DC 12 to 30 V</li> </ul>
<b>Assignable functions</b>	<ul style="list-style-type: none"> <li>■ Off</li> <li>■ Reset totalizers 1-3 separately</li> <li>■ Reset all totalizers</li> <li>■ Flow override</li> </ul>

## 16.4 Output

Output signal

### Current output

Current output	Can be set as: <ul style="list-style-type: none"> <li>■ 4-20 mA NAMUR</li> <li>■ 4-20 mA US</li> <li>■ 4-20 mA HART</li> <li>■ 0-20 mA</li> </ul>
Maximum output values	<ul style="list-style-type: none"> <li>■ DC 24 V (no flow)</li> <li>■ 22.5 mA</li> </ul>
Load	0 to 700 Ω
Resolution	0.5 μA
Damping	Adjustable: 0.07 to 999 s
Assignable measured variables	<ul style="list-style-type: none"> <li>■ Volume flow</li> <li>■ Mass flow</li> <li>■ Flow velocity</li> <li>■ Electronic temperature</li> </ul>

### Pulse/frequency/switch output

Function	<ul style="list-style-type: none"> <li>■ With the order code for "Output; Input", option <b>H</b>: output 2 can be set as a pulse or frequency output</li> <li>■ With the order code for "Output; Input", option <b>I</b>: output 2 and 3 can be set as a pulse, frequency or switch output</li> </ul>
Version	Passive, open collector
Maximum input values	<ul style="list-style-type: none"> <li>■ DC 30 V</li> <li>■ 250 mA</li> </ul>
Voltage drop	For 25 mA: ≤ DC 2 V
<b>Pulse output</b>	
Pulse width	Adjustable: 0.05 to 2 000 ms
Maximum pulse rate	10 000 Impulse/s
Pulse value	Adjustable
Assignable measured variables	<ul style="list-style-type: none"> <li>■ Volume flow</li> <li>■ Mass flow</li> </ul>
<b>Frequency output</b>	
Output frequency	Adjustable: 0 to 12 500 Hz
Damping	Adjustable: 0 to 999 s
Pulse/pause ratio	1:1
Assignable measured variables	<ul style="list-style-type: none"> <li>■ Volume flow</li> <li>■ Mass flow</li> <li>■ Flow velocity</li> <li>■ Electronic temperature</li> </ul>
<b>Switch output</b>	
Switching behavior	Binary, conductive or non-conductive
Switching delay	Adjustable: 0 to 100 s

<b>Number of switching cycles</b>	Unlimited
<b>Assignable functions</b>	<ul style="list-style-type: none"> <li>▪ Off</li> <li>▪ On</li> <li>▪ Diagnostic behavior</li> <li>▪ Limit value:                             <ul style="list-style-type: none"> <li>- Off</li> <li>- Volume flow</li> <li>- Mass flow</li> <li>- Flow velocity</li> <li>- Totalizer 1-3</li> <li>- Electronic temperature</li> </ul> </li> <li>▪ Flow direction monitoring</li> <li>▪ Status                             <ul style="list-style-type: none"> <li>- Empty pipe detection</li> <li>- Low flow cut off</li> </ul> </li> </ul>

Signal on alarm

Depending on the interface, failure information is displayed as follows:

**Current output 4 to 20 mA**

*4 to 20 mA*

<b>Failure mode</b>	Choose from: <ul style="list-style-type: none"> <li>▪ 4 to 20 mA in accordance with NAMUR recommendation NE 43</li> <li>▪ 4 to 20 mA in accordance with US</li> <li>▪ Min. value: 3.59 mA</li> <li>▪ Max. value: 22.5 mA</li> <li>▪ Freely definable value between: 3.59 to 22.5 mA</li> <li>▪ Actual value</li> <li>▪ Last valid value</li> </ul>
---------------------	--

*0 to 20 mA*

<b>Failure mode</b>	Choose from: <ul style="list-style-type: none"> <li>▪ Maximum alarm: 22 mA</li> <li>▪ Freely definable value between: 0 to 22.5 mA</li> </ul>
---------------------	---

**HART current output**

<b>Device diagnostics</b>	Device condition can be read out via HART Command 48
---------------------------	--

**Pulse/frequency/switch output**

<b>Pulse output</b>	
<b>Failure mode</b>	Choose from: <ul style="list-style-type: none"> <li>▪ Actual value</li> <li>▪ No pulses</li> </ul>
<b>Frequency output</b>	
<b>Failure mode</b>	Choose from: <ul style="list-style-type: none"> <li>▪ Actual value</li> <li>▪ 0 Hz</li> <li>▪ Defined value: 0 to 12 500 Hz</li> </ul>
<b>Switch output</b>	
<b>Failure mode</b>	Choose from: <ul style="list-style-type: none"> <li>▪ Current status</li> <li>▪ Open</li> <li>▪ Closed</li> </ul>

**Local display**

Plain text display	With information on cause and remedial measures
Backlight	Red backlighting indicates a device error.

 Status signal as per NAMUR recommendation NE 107

**Interface/protocol**

- Via digital communication:  
HART protocol
- Via service interface

Plain text display	With information on cause and remedial measures
--------------------	---

**Web server**

Plain text display	With information on cause and remedial measures
--------------------	---

**Light emitting diodes (LED)**

<b>Status information</b>	<p>Status indicated by various light emitting diodes</p> <p>The following information is displayed depending on the device version:</p> <ul style="list-style-type: none"> <li>▪ Supply voltage active</li> <li>▪ Data transmission active</li> <li>▪ Device alarm/error has occurred</li> </ul> <p> Diagnostic information via light emitting diodes</p>
---------------------------	--

Low flow cut off                      The switch points for low flow cut off are user-selectable.

Galvanic isolation                    The following connections are galvanically isolated from each other:

- Inputs
- Outputs
- Power supply

Protocol-specific data                **HART**

- For information on the device description files
- For information on the dynamic variables and measured variables (HART device variables) →  71

**16.5 Power supply**

Terminal assignment                 →  35

## Supply voltage

**Transmitter**

Order code for "Power supply"	Terminal voltage	Frequency range
Option L	AC100 to 240 V	50/ 60 Hz, ±4 Hz
	AC/DC24 V	50/ 60 Hz, ±4 Hz

## Power consumption

Order code for "Output"	Maximum power consumption
Option H: 4-20mA HART, pulse/frequency/switch output, switch output	30 VA/8 W
Option I: 4-20mA HART, 2 x pulse/frequency/switch output, status input	30 VA/8 W

## Current consumption

**Transmitter**

Order code for "Power supply"	Maximum Current consumption	Maximum switch-on current
Option L: AC 100 to 240 V	145 mA	25 A (< 5 ms)
Option L: AC/DC 24 V	350 mA	27 A (< 5 ms)

## Power supply failure

- Totalizers stop at the last value measured.
- Configuration is retained in the plug-in memory (HistoROM DAT).
- Error messages (incl. total operated hours) are stored.

## Electrical connection

→  38

## Potential equalization

→  41

## Terminals

**Transmitter**

- Supply voltage cable: plug-in spring terminals for wire cross-sections 0.5 to 2.5 mm<sup>2</sup> (20 to 14 AWG)
- Signal cable: plug-in spring terminals for wire cross-sections 0.5 to 2.5 mm<sup>2</sup> (20 to 14 AWG)
- Electrode cable: spring terminals for wire cross-sections 0.5 to 2.5 mm<sup>2</sup> (20 to 14 AWG)
- Coil current cable: spring terminals for wire cross-sections 0.5 to 2.5 mm<sup>2</sup> (20 to 14 AWG)

**Sensor connection housing**Spring terminals for wire cross-sections 0.5 to 2.5 mm<sup>2</sup> (20 to 14 AWG)

## Cable entries

**Cable entry thread**

- M20 x 1.5
- Via adapter:
  - NPT ½"
  - G ½"

**Cable gland**

- For standard cable: M20 × 1.5 with cable  $\phi$ 6 to 12 mm (0.24 to 0.47 in)
- For reinforced cable: M20 × 1.5 with cable  $\phi$ 9.5 to 16 mm (0.37 to 0.63 in)

 If metal cable entries are used, use a grounding plate.

Cable specification →  33

## 16.6 Performance characteristics

- Reference operating conditions
- Error limits following DIN EN 29104, in future ISO 20456
  - Water, typically +15 to +45 °C (+59 to +113 °F); 0.5 to 7 bar (73 to 101 psi)
  - Data as indicated in the calibration protocol
  - Accuracy based on accredited calibration rigs according to ISO 17025

Maximum measured error **Error limits under reference operating conditions**

o.r. = of reading

**Volume flow**

±0.5 % o.r. ± 1 mm/s (0.04 in/s)

 Fluctuations in the supply voltage do not have any effect within the specified range.

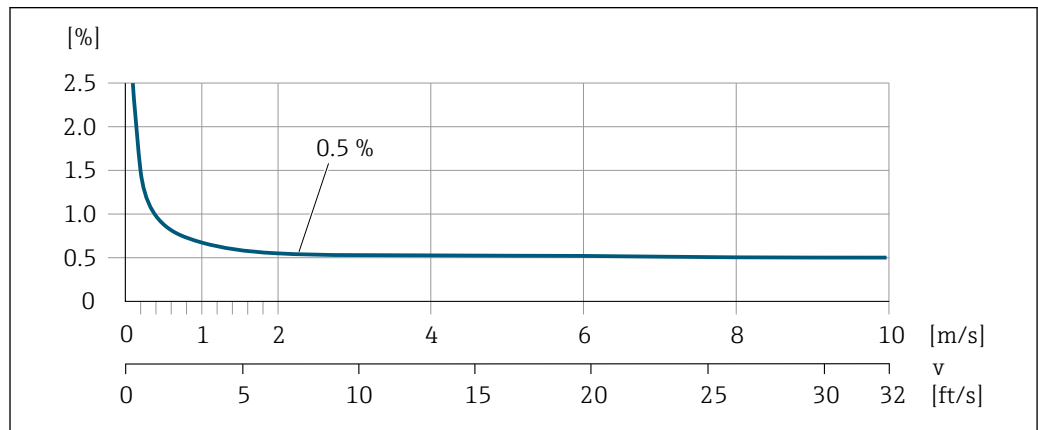

 33 Maximum measured error in % o.r.

**Accuracy of outputs**

The outputs have the following base accuracy specifications.

*Current output*

<b>Accuracy</b>	Max. ±5 µA
-----------------	------------

*Pulse/frequency output*

o.r. = of reading

<b>Accuracy</b>	Max. ±50 ppm o.r. (across the entire ambient temperature range)
-----------------	---

Repeatability o.r. = of reading

**Volume flow**

max. ±0.1 % o.r. ± 0.5 mm/s (0.02 in/s)

Influence of ambient temperature **Current output**  
o.r. = of reading



<b>Temperature coefficient</b>	Max. $\pm 0.005$ % o.r./°C
--------------------------------	----------------------------

### Pulse/frequency output

<b>Temperature coefficient</b>	No additional effect. Included in accuracy.
--------------------------------	---

## 16.7 Installation

"Mounting requirements"

## 16.8 Environment

Ambient temperature range →  21

Storage temperature The storage temperature corresponds to the operating temperature range of the measuring transmitter and the appropriate measuring sensors. →  21

- Protect the measuring device against direct sunlight during storage in order to avoid unacceptably high surface temperatures.
- Select a storage location where moisture cannot collect in the measuring device as fungus or bacteria infestation can damage the liner.
- If protection caps or protective covers are mounted these should never be removed before installing the measuring device.

Atmosphere If a plastic transmitter housing is permanently exposed to certain steam and air mixtures, this can damage the housing.



If you are unsure, please contact your Endress+Hauser Sales Center for clarification.

Degree of protection **Transmitter**

- As standard: IP66/67, type 4X enclosure
- When housing is open: IP20, type 1 enclosure

#### Sensor

As standard: IP66/67, type 4X enclosure

Vibration resistance **Compact version**

- Vibration, sinusoidal according to IEC 60068-2-6
  - 2 to 8.4 Hz, 3.5 mm peak
  - 8.4 to 2 000 Hz, 1 g peak
- Vibration broad-band random, according to IEC 60068-2-64
  - 10 to 200 Hz, 0.003 g<sup>2</sup>/Hz
  - 200 to 2 000 Hz, 0.001 g<sup>2</sup>/Hz
  - Total: 1.54 g rms

**Remote version**

- Vibration, sinusoidal according to IEC 60068-2-6
  - 2 to 8.4 Hz, 7.5 mm peak
  - 8.4 to 2 000 Hz, 2 g peak
- Vibration broad-band random, according to IEC 60068-2-64
  - 10 to 200 Hz, 0.01 g<sup>2</sup>/Hz
  - 200 to 2 000 Hz, 0.003 g<sup>2</sup>/Hz
  - Total: 1.54 g rms

---

Shock resistance                      Shock, half-sine according to IEC 60068-2-27  
6 ms 50 g

---

Impact resistance                      Rough handling shocks according to IEC 60068-2-31

---

Mechanical load                      ■ Protect the transmitter housing against mechanical effects, such as shock or impact; the use of the remote version is sometimes preferable.  
■ Never use the transmitter housing as a ladder or climbing aid.

---

Electromagnetic compatibility (EMC)                      ■ As per IEC/EN 61326 and NAMUR Recommendation 21 (NE 21)  
■ Complies with emission limits for industry as per EN 55011 (Class A)  
 For details, refer to the Declaration of Conformity.

## 16.9 Process

---

Medium temperature range                      0 to +60 °C (+32 to +140 °F) for polyamide



---

Pressure-temperature ratings                       An overview of the pressure-temperature ratings for the process connections is provided in the "Technical Information" document

---

Pressure tightness                      Measuring tube: 0 mbar abs. (0 psi abs.) at a medium temperature of ≤ +60 °C (+140 °F)

---

Flow limit                      The diameter of the pipe and the flow rate determine the nominal diameter of the sensor. The optimum velocity of flow is between 2 to 3 m/s (6.56 to 9.84 ft/s). Also match the velocity of flow (v) to the physical properties of the fluid:  
■ v < 2 m/s (6.56 ft/s): for abrasive fluids (e.g. potter's clay, lime milk, ore slurry)  
■ v > 2 m/s (6.56 ft/s): for fluids producing buildup (e.g. wastewater sludge)  
 A necessary increase in the flow velocity can be achieved by reducing the sensor nominal diameter.  
 For an overview of the full scale values for the measuring range, see the "Measuring range" section →  138

---

Pressure loss                      ■ No pressure loss occurs if the sensor is installed in a pipe with the same nominal diameter.  
■ Pressure losses for configurations incorporating adapters according to DIN EN 545 →  22

---

System pressure                      →  21

Vibrations →  21

## 16.10 Mechanical construction

Design, dimensions



For the dimensions and installation lengths of the device, see the "Technical Information" document, "Mechanical construction" section.

Weight

### Compact version

Weight data:

- Including the transmitter
  - Order code for "Housing", option M, Q: 1.3 kg (2.9 lbs)
  - Order code for "Housing", option A, R: 2.0 kg (4.4 lbs)
- Excluding packaging material

*Weight in SI units*

EN 1092-1 (DIN 2501), JIS B2220		
DN [mm]	Weight [kg]	
	Order code for "Housing", option M, Q: Polycarbonate plastic	Order code for "Housing", option A, R: Aluminum, AlSi10Mg, coated
25	2.50	3.20
40	3.10	3.80
50	3.90	4.60
65	4.70	5.40
80	5.70	6.40
100	8.40	9.10

*Weight in US units*

ASME B16.5		
DN [in]	Weight [lbs]	
	Order code for "Housing", option M, Q: Polycarbonate plastic	Order code for "Housing", option A, R: Aluminum, AlSi10Mg, coated
1	5.51	7.06
1½	6.84	8.40
2	8.60	10.1
3	12.6	14.1
4	18.5	20.1

### Transmitter remote version

*Wall-mount housing*

Depends on the material of the wall-mount housing:

- Polycarbonate plastic: 1.3 kg (2.9 lb)
- Aluminum, AlSi10Mg, coated: 2.0 kg (4.4 lb)

**Sensor remote version**

Weight data:

- Including sensor connection housing
- Excluding the connecting cable
- Excluding packaging material

*Weight in SI units*

EN 1092-1 (DIN 2501), JIS B2220	
DN [mm]	Weight [kg]
25	2.5
40	3.1
50	3.9
65	4.7
80	5.7
100	8.4

*Weight in US units*

ASME B16.5	
DN [in]	Weight [lbs]
1	5.5
1½	6.8
2	8.6
3	12.6
4	18.5

Measuring tube  
specification

**Pressure rating EN (DIN)**

Pressure rating PN 16								
DN		Mounting bolts			Length Centering sleeves		internal diameter Measuring tube	
[mm]	[in]		[mm]	[in]	[mm]	[in]	[mm]	[in]
25	1	4 × M12 ×	145	5.71	54	2.13	24	0.94
40	1 ½	4 × M16 ×	170	6.69	68	2.68	38	1.50
50	2	4 × M16 ×	185	7.28	82	3.23	50	1.97
65 <sup>1)</sup>	–	4 × M16 ×	200	7.87	92	3.62	60	2.36
65 <sup>2)</sup>	–	8 × M16 ×	200	7.87	– <sup>3)</sup>	–	60	2.36
80	3	8 × M16 ×	225	8.86	116	4.57	76	2.99
100	4	8 × M16 ×	260	10.24	147	5.79	97	3.82

- 1) EN (DIN) flange: 4-hole → with centering sleeves
- 2) EN (DIN) flange: 8-hole → without centering sleeves
- 3) A centering sleeve is not required. The device is centered directly via the sensor housing.

**ASME pressure rating**

Pressure rating Class 150								
DN		Mounting bolts			Length		internal diameter	
[mm]	[in]		[mm]	[in]	Centering sleeves		Measuring tube	
					[mm]	[in]	[mm]	[in]
25	1	4 × UNC ½" ×	145	5.70	– <sup>1)</sup>	–	24	0.94
40	1 ½	4 × UNC ½" ×	165	6.50	–	–	38	1.50
50	2	4 × UNC 5/8" ×	190.5	7.50	–	–	50	1.97
80	3	8 × UNC 5/8" ×	235	9.25	–	–	76	2.99
100	4	8 × UNC 5/8" ×	264	10.4	147	5.79	97	3.82

1) A centering sleeve is not required. The device is centered directly via the sensor housing.

**Pressure rating JIS**

Pressure rating 10K								
DN		Mounting bolts			Length		internal diameter	
[mm]	[in]		[mm]	[in]	Centering sleeves		Measuring tube	
					[mm]	[in]	[mm]	[in]
25	1	4 × M16 ×	170	6.69	54	2.13	24	0.94
40	1 ½	4 × M16 ×	170	6.69	68	2.68	38	1.50
50	2	4 × M16 ×	185	7.28	– <sup>1)</sup>	–	50	1.97
65	–	4 × M16 ×	200	7.87	–	–	60	2.36
80	3	8 × M16 ×	225	8.86	–	–	76	2.99
100	4	8 × M16 ×	260	10.24	–	–	97	3.82

1) A centering sleeve is not required. The device is centered directly via the sensor housing.

**Materials****Transmitter housing***Compact version, standard*

- Order code for "Housing", option **A** "Compact, aluminum coated":  
Aluminum, AlSi10Mg, coated
- Order code for "Housing", option **M**: polycarbonate plastic
- Window material:
  - For order code for "Housing", option **A**: glass
  - For order code for "Housing", option **M**: plastic

*Compact version, inclined*

- Order code for "Housing", option **R** "Compact, aluminum coated":  
Aluminum, AlSi10Mg, coated
- Order code for "Housing", option **Q**: polycarbonate plastic
- Window material:
  - For order code for "Housing", option **R**: glass
  - For order code for "Housing", option **Q**: plastic

*Remote version (wall-mount housing)*

- Order code for "Housing", option **P** "Compact, aluminum coated":  
Aluminum, AlSi10Mg, coated
- Order code for "Housing", option **N**: polycarbonate plastic
- Window material:
  - For order code for "Housing", option **P**: glass
  - For order code for "Housing", option **N**: plastic

**Cable entries/cable glands**

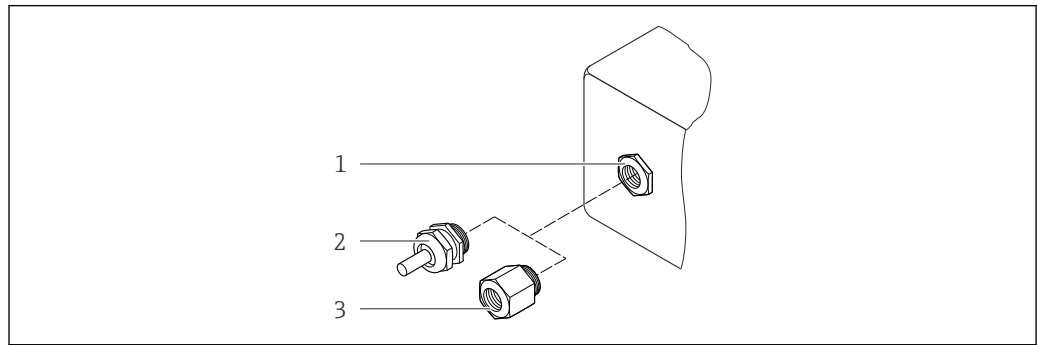

34 Possible cable entries/cable glands

- 1 Cable entry with M20 × 1.5 internal thread
- 2 Cable gland M20 × 1.5
- 3 Adapter for cable entry with internal thread G ½" or NPT ½"

Cable entries and adapters	Material
Cable gland M20 × 1.5	Plastic
<ul style="list-style-type: none"> <li>■ Adapter for cable entry with internal thread G ½"</li> <li>■ Adapter for cable entry with internal thread NPT ½"</li> </ul> <p><b>i</b> Only available for certain device versions:</p> <ul style="list-style-type: none"> <li>■ Order code for "Transmitter housing": Option <b>A</b> "Aluminum, coated"</li> <li>■ Order code for "Sensor connection housing":</li> </ul>	Nickel-plated brass

**Device plug**

Electrical connection	Material
Plug M12x1	<ul style="list-style-type: none"> <li>■ Socket: Stainless steel, 1.4404 (316L)</li> <li>■ Contact housing: Polyamide</li> <li>■ Contacts: Gold-plated brass</li> </ul>

**Connecting cable for remote version**

Electrode and coil current cable

- Standard cable: PVC cable with copper shield
- Reinforced cable: PVC cable with copper shield and additional steel wire braided jacket

**Sensor housing**

Aluminum, AlSi10Mg, coated

**Sensor connection housing**

Aluminum, AlSi10Mg, coated

**Sensor cable entries**

Order code for "Housing", option N "Remote, polycarbonate" or option P "Remote, coated aluminum"

The various cable entries are suitable for hazardous and non-hazardous areas.

Electrical connection	Material
Cable gland M20 × 1.5	Nickel-plated brass
Thread G ½" via adapter	Nickel-plated brass
Thread NPT ½" via adapter	Nickel-plated brass

**Liner**

Polyamide

**Electrodes**

Stainless steel, 1.4435/F316L

**Process connections**

- EN 1092-1 (DIN 2501)
- ASME B16.5
- JIS B2220

 List of all available process connections →  151

**Seals**

O-rings made from EPDM

**Accessories**

*Display protection*

Stainless steel, 1.4301 (304L)

*Ground disks*

Stainless steel, 1.4301/304

---

Mounting bolts

**Tensile strength**

- Galvanized steel mounting bolts: strength category 5.6 or 5.8
- Stainless steel mounting bolts: strength category A2-70

---



Fitted electrodes

2 measuring electrodes made of 1.4435 (316L)

---

Process connections

- EN 1092-1 (DIN 2501)
- ASME B16.5
- JIS B2220

 For information on the different materials used in the process connections →  151

## 16.11 Operability

### Languages

Can be operated in the following languages:



- Via local operation:  
English, German, French, Spanish, Italian, Dutch, Portuguese, Polish, Russian, Turkish, Chinese, Japanese, Bahasa (Indonesian), Vietnamese, Czech, Swedish
- Via "FieldCare", "DeviceCare" operating tool:  
English, German, French, Spanish, Italian, Chinese, Japanese
- Via Web browser  
English, German, French, Spanish, Italian, Dutch, Portuguese, Polish, Russian, Turkish, Chinese, Japanese, Bahasa (Indonesian), Vietnamese, Czech, Swedish

### Local display

#### Via display module

Two display modules are available:

- Standard:  
4-line, illuminated, graphic display; touch control
- Optionally via order code for "Display", option **W1** "WLAN display":  
4-line, illuminated, graphic display; touch control + WLAN

 Information about WLAN interface →  66

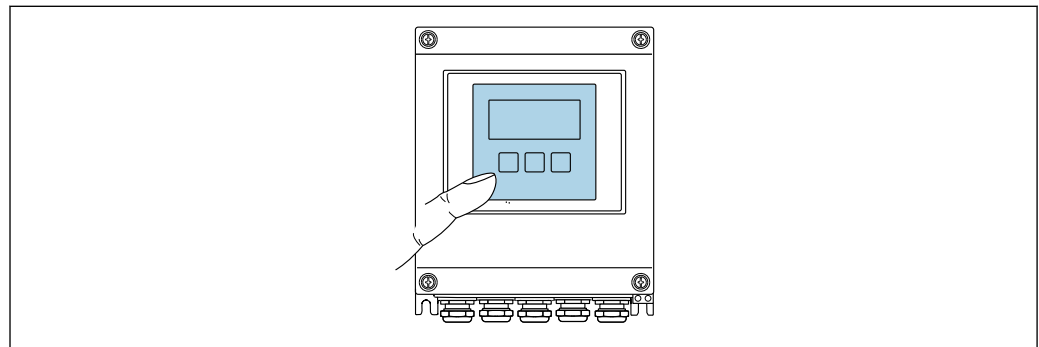



 35 Operation with touch control

#### Display elements

- 4-line, illuminated, graphic display
- White background lighting; switches to red in event of device errors
- Format for displaying measured variables and status variables can be individually configured
- Permitted ambient temperature for the display:  $-20$  to  $+60$  °C ( $-4$  to  $+140$  °F)  
The readability of the display may be impaired at temperatures outside the temperature range.

#### Operating elements

- External operation via touch control (3 optical keys) without opening the housing: , , 
- Operating elements also accessible in various hazardous areas

### Remote operation



→  66

### Service interface

→  66



Supported operating tools Different operating tools can be used for local or remote access to the measuring device. Depending on the operating tool used, access is possible with different operating units and via a variety of interfaces.

Supported operating tools	Operating unit	Interface	Additional information
Web browser	Notebook, PC or tablet with Web browser	<ul style="list-style-type: none"> <li>▪ CDI-RJ45 service interface</li> <li>▪ WLAN interface</li> </ul>	Special Documentation for the device
DeviceCare SFE100	Notebook, PC or tablet with Microsoft Windows system	<ul style="list-style-type: none"> <li>▪ CDI-RJ45 service interface</li> <li>▪ WLAN interface</li> <li>▪ Fieldbus protocol</li> </ul>	→  136
FieldCare SFE500	Notebook, PC or tablet with Microsoft Windows system	<ul style="list-style-type: none"> <li>▪ CDI-RJ45 service interface</li> <li>▪ WLAN interface</li> <li>▪ Fieldbus protocol</li> </ul>	→  136
Device Xpert	Field Xpert SFX 100/350/370	HART and FOUNDATION Fieldbus fieldbus protocol	Operating Instructions BA01202S Device description files: Use update function of handheld terminal



Other operating tools based on FDT technology with a device driver such as DTM/iDTM or DD/EDD can be used for device operation. These operating tools are available from the individual manufacturers. Integration into the following operating tools, among others, is supported:

- Process Device Manager (PDM) by Siemens → [www.siemens.com](http://www.siemens.com)
- Asset Management Solutions (AMS) by Emerson → [www.emersonprocess.com](http://www.emersonprocess.com)
- FieldCommunicator 375/475 by Emerson → [www.emersonprocess.com](http://www.emersonprocess.com)
- Field Device Manager (FDM) by Honeywell → [www.honeywellprocess.com](http://www.honeywellprocess.com)
- FieldMate by Yokogawa → [www.yokogawa.com](http://www.yokogawa.com)
- PACTWare → [www.pactware.com](http://www.pactware.com)

The associated device description files are available at: [www.endress.com](http://www.endress.com) → Downloads

### Web server

Thanks to the integrated Web server, the device can be operated and configured via a Web browser and via a service interface (CDI-RJ45) or via a WLAN interface. The structure of the operating menu is the same as for the local display. In addition to the measured values, status information on the device is also displayed and allows the user to monitor the status of the device. Furthermore the device data can be managed and the network parameters can be configured.

A device that has a WLAN interface (can be ordered as an option) is required for the WLAN connection: order code for "Display", option **W1** "WLAN display": 4-line, illuminated; touch control + WLAN. The device acts as an Access Point and enables communication by computer or a mobile handheld terminal.

### Supported functions

Data exchange between the operating unit (such as a notebook for example) and the measuring device:

- Uploading the configuration from the measuring device (XML format, configuration backup)
- Save the configuration to the measuring device (XML format, restore configuration)
- Export event list (.csv file)
- Export parameter settings (.csv file, create documentation of the measuring point configuration)

- Export the Heartbeat verification log (PDF file, only available with the "Heartbeat Verification" application package)
- Flash firmware version for device firmware upgrade, for instance
- Download driver for system integration

HistoROM data management

The measuring device features HistoROM data management. HistoROM data management comprises both the storage and import/export of key device and process data, making operation and servicing far more reliable, secure and efficient.

 When the device is delivered, the factory settings of the configuration data are stored as a backup in the device memory. This memory can be overwritten with an updated data record, for example after commissioning.

**Additional information on the data storage concept**

*There are different types of data storage units in which device data are stored and used by the device:*

	Device memory	T-DAT	S-DAT
<b>Available data</b>	<ul style="list-style-type: none"> <li>▪ Device firmware package</li> <li>▪ Driver for system integration e.g.: DD for HART</li> </ul>	<ul style="list-style-type: none"> <li>▪ Event history, such as diagnostic events</li> <li>▪ Measured value memory ("Extended HistoROM" order option)</li> <li>▪ Current parameter data record (used by firmware at run time)</li> <li>▪ Maximum indicators (min/max values)</li> <li>▪ Totalizer values</li> </ul>	<ul style="list-style-type: none"> <li>▪ Sensor data: diameter etc.</li> <li>▪ Serial number</li> <li>▪ User-specific access code (to use the "Maintenance" user role)</li> <li>▪ Calibration data</li> <li>▪ Device configuration (e.g. SW options, fixed I/O or multi I/O)</li> </ul>
<b>Storage location</b>	Fixed on the user interface board in the connection compartment	Can be plugged into the user interface board in the connection compartment	In the sensor plug in the transmitter neck part

**Data backup**

**Automatic**

- The most important device data (sensor and transmitter) are automatically saved in the DAT modules
- If the transmitter or measuring device is replaced: once the T-DAT containing the previous device data has been exchanged, the new measuring device is ready for operation again immediately without any errors
- If the sensor is replaced: once the sensor has been replaced, new sensor data are transferred from the S-DAT in the measuring device and the measuring device is ready for operation again immediately without any errors

**Data transfer**

**Manual**

Transfer of a device configuration to another device using the export function of the specific operating tool, e.g. with FieldCare, DeviceCare or Web server: to duplicate the configuration or to store in an archive (e.g. for backup purposes)

**Event list**

**Automatic**

- Chronological display of up to 20 event messages in the events list
- If the **Extended HistoROM** application package (order option) is enabled: up to 100 event messages are displayed in the events list along with a time stamp, plain text description and remedial measures
- The events list can be exported and displayed via a variety of interfaces and operating tools e.g. DeviceCare, FieldCare or Web server

**Data logging****Manual**

If the **Extended HistoROM** application package (order option) is enabled:

- Record up to 1 000 measured values via 1 to 4 channels
- User configurable recording interval
- Record up to 250 measured values via each of the 4 memory channels
- Export the measured value log via a variety of interfaces and operating tools e.g. FieldCare, DeviceCare or Web server
- Use the recorded measured value data in the integrated device simulation function in the **Diagnostics** submenu (→  125).

**16.12 Certificates and approvals**

CE mark	<p>The measuring system is in conformity with the statutory requirements of the applicable EU Directives. These are listed in the corresponding EU Declaration of Conformity along with the standards applied.</p> <p>Endress+Hauser confirms successful testing of the device by affixing to it the CE mark.</p>
C-Tick symbol	<p>The measuring system meets the EMC requirements of the "Australian Communications and Media Authority (ACMA)".</p>
Ex approval	<p>The devices are certified for use in hazardous areas and the relevant safety instructions are provided in the separate "Control Drawing" document. Reference is made to this document on the nameplate.</p>
Drinking water approval	<ul style="list-style-type: none"> <li>■ ACS</li> <li>■ KTW/W270</li> <li>■ NSF 61</li> <li>■ WRAS BS 6920</li> </ul>
HART certification	<p><b>HART interface</b></p> <p>The measuring device is certified and registered by the FieldComm Group. The measuring system meets all the requirements of the following specifications:</p> <ul style="list-style-type: none"> <li>■ Certified according to HART 7</li> <li>■ The device can also be operated with certified devices of other manufacturers (interoperability)</li> </ul>
Radio approval	<p>Europe: RED 2014/53/EU</p> <p>United States of America: CFR Title 47, FCC Part 15.247</p> <p>Canada: RSS-247 Issue 1</p> <p>Japan: Article 2 clause 1 item 19</p> <p> Additional country-specific approvals on request.</p>

Other standards and guidelines

- EN 60529  
Degrees of protection provided by enclosures (IP code)
- EN 61010-1  
Safety requirements for electrical equipment for measurement, control and laboratory use - general requirements
- IEC/EN 61326  
Emission in accordance with Class A requirements. Electromagnetic compatibility (EMC requirements).
- ANSI/ISA-61010-1 (82.02.01): 2004  
Safety Requirements for Electrical Equipment for Measurement, Control and Laboratory Use - Part 1 General Requirements
- CAN/CSA-C22.2 No. 61010-1-04  
Safety Requirements for Electrical Equipment for Measurement, Control and Laboratory Use - Part 1 General Requirements
- NAMUR NE 21  
Electromagnetic compatibility (EMC) of industrial process and laboratory control equipment
- NAMUR NE 32  
Data retention in the event of a power failure in field and control instruments with microprocessors
- NAMUR NE 43  
Standardization of the signal level for the breakdown information of digital transmitters with analog output signal.
- NAMUR NE 53  
Software of field devices and signal-processing devices with digital electronics
- NAMUR NE 105  
Specifications for integrating fieldbus devices in engineering tools for field devices
- NAMUR NE 107  
Self-monitoring and diagnosis of field devices
- NAMUR NE 131  
Requirements for field devices for standard applications

### 16.13 Application packages

Many different application packages are available to enhance the functionality of the device. Such packages might be needed to address safety aspects or specific application requirements.

The application packages can be ordered with the device or subsequently from Endress+Hauser. Detailed information on the order code in question is available from your local Endress+Hauser sales center or on the product page of the Endress+Hauser website: [www.endress.com](http://www.endress.com).



Diagnostics functions

Package	Description
Extended HistoROM	<p>Comprises extended functions concerning the event log and the activation of the measured value memory.</p> <p>Event log: Memory volume is extended from 20 message entries (standard version) to up to 100 entries.</p> <p>Data logging (line recorder):</p> <ul style="list-style-type: none"> <li>■ Memory capacity for up to 1000 measured values is activated.</li> <li>■ 250 measured values can be output via each of the 4 memory channels. The recording interval can be defined and configured by the user.</li> <li>■ Measured value logs can be accessed via the local display or operating tool e.g. FieldCare, DeviceCare or Web server.</li> </ul>

## Heartbeat Technology

Package	Description
Heartbeat Verification +Monitoring	<p><b>Heartbeat Monitoring</b> Continuously supplies data, which are characteristic of the measuring principle, to an external condition monitoring system for the purpose of preventive maintenance or process analysis. These data enable the operator to:</p> <ul style="list-style-type: none"> <li>▪ Draw conclusions - using these data and other information - about the impact process influences (such as corrosion, abrasion, buildup etc.) have on the measuring performance over time.</li> <li>▪ Schedule servicing in time.</li> <li>▪ Monitor the process or product quality, e.g. gas pockets.</li> </ul> <p><b>Heartbeat Verification</b> Meets the requirement for traceable verification to DIN ISO 9001:2008 Chapter 7.6 a) "Control of monitoring and measuring equipment".</p> <ul style="list-style-type: none"> <li>▪ Functional testing in the installed state without interrupting the process.</li> <li>▪ Traceable verification results on request, including a report.</li> <li>▪ Simple testing process via local operation or other operating interfaces.</li> <li>▪ Clear measuring point assessment (pass/fail) with high test coverage within the framework of manufacturer specifications.</li> <li>▪ Extension of calibration intervals according to operator's risk assessment.</li> </ul>

## 16.14 Accessories

 Overview of accessories available for order →  135

## 16.15 Supplementary documentation

 For an overview of the scope of the associated Technical Documentation, refer to the following:

- The *W@M Device Viewer* : Enter the serial number from the nameplate ([www.endress.com/deviceviewer](http://www.endress.com/deviceviewer))
- The *Endress+Hauser Operations App*: Enter the serial number from the nameplate or scan the 2-D matrix code (QR code) on the nameplate.

## Standard documentation

### Technical Information

Measuring device	Documentation code
Promag D 400	TI01044D

### Brief Operating Instructions

*Part 1 of 2: Sensor*

Measuring device	Documentation code
Promag D 400	KA01264D

*Part 2 of 2: Transmitter*

Measuring device	Documentation code
Promag 400	KA01263D

### Description of device parameters



Measuring device	Documentation code
Promag 400	GP01043D

Supplementary device-  
dependent documentation

**Special Documentation**

Content	Documentation code
Websserver	SD01811D
Heartbeat Technology	SD01847D

**Installation Instructions**

Contents	Documentation code
Installation Instructions for spare part sets	 Overview of accessories available for order →  135

# Index

## A

- Access authorization to parameters
  - Read access . . . . . 59
  - Write access . . . . . 59
- Access code . . . . . 59
  - Incorrect input . . . . . 59
- Adapters . . . . . 22
- Adapting the diagnostic behavior . . . . . 121
- Adapting the status signal . . . . . 121
- Ambient temperature range . . . . . 21
  - Influence . . . . . 144
- AMS Device Manager . . . . . 69
  - Function . . . . . 69
- Application . . . . . 138
- Applicator . . . . . 138
- Approvals . . . . . 155

## B

- Burst mode . . . . . 72

## C

- C-Tick symbol . . . . . 155
- Cable entries
  - Technical data . . . . . 143
- Cable entry
  - Degree of protection . . . . . 45
- CE mark . . . . . 10, 155
- Certificates . . . . . 155
- Checklist
  - Post-connection check . . . . . 45
  - Post-installation check . . . . . 32
- Cleaning
  - Exterior cleaning . . . . . 132
  - Interior cleaning . . . . . 132
- Commissioning . . . . . 75
  - Advanced settings . . . . . 92
  - Configuring the measuring device . . . . . 75
- Communication-specific data . . . . . 71
- Connecting cable . . . . . 33
- Connecting the measuring device . . . . . 38
- Connection
  - see Electrical connection
- Connection examples, potential equalization . . . . . 41
- Connection preparations . . . . . 36
- Connection tools . . . . . 34
- Context menu
  - Calling up . . . . . 54
  - Closing . . . . . 54
  - Explanation . . . . . 54
- Current consumption . . . . . 143

## D

- Declaration of Conformity . . . . . 10
- Define access code . . . . . 103, 104
- Degree of protection . . . . . 45, 145

## Design

- Measuring device . . . . . 13
- Designated use . . . . . 9
- Device components . . . . . 13
- Device description files . . . . . 71
- Device documentation
  - Supplementary documentation . . . . . 8
- Device locking, status . . . . . 106
- Device name
  - Sensor . . . . . 16
  - Transmitter . . . . . 15
- Device repair . . . . . 133
- Device revision . . . . . 71
- Device type ID . . . . . 71
- DeviceCare . . . . . 69
  - Device description file . . . . . 71
- Diagnostic behavior
  - Explanation . . . . . 117
  - Symbols . . . . . 117
- Diagnostic information
  - Design, description . . . . . 117, 120
  - DeviceCare . . . . . 120
  - FieldCare . . . . . 120
  - Light emitting diodes . . . . . 115
  - Local display . . . . . 116
  - Overview . . . . . 122
  - Remedial measures . . . . . 122
  - Web browser . . . . . 118
- Diagnostic list . . . . . 126
- Diagnostic message . . . . . 116
- Diagnostics
  - Symbols . . . . . 116
- DIP switch
  - see Write protection switch
- Direct access . . . . . 56
- Direct access code . . . . . 51
- Disabling write protection . . . . . 103
- Display
  - see Local display
- Display area
  - For operational display . . . . . 49
  - In the navigation view . . . . . 51
- Display values
  - For locking status . . . . . 106
- Disposal . . . . . 134
- Document
  - Function . . . . . 6
  - Symbols used . . . . . 6
- Document function . . . . . 6
- Down pipe . . . . . 19
- Drinking water approval . . . . . 155

## E

- ECC . . . . . 97
- Electrical connection
  - Degree of protection . . . . . 45

Measuring device . . . . . 33

Operating tools

- Via service interface (CDI-RJ45) . . . . . 66
- Via WLAN interface . . . . . 66

Web server . . . . . 66

WLAN interface . . . . . 66

Electromagnetic compatibility . . . . . 146

Enabling write protection . . . . . 103

Endress+Hauser services

- Maintenance . . . . . 132
- Repair . . . . . 133

Environment

- Ambient temperature . . . . . 21
- Impact resistance . . . . . 146
- Mechanical load . . . . . 146
- Shock resistance . . . . . 146
- Storage temperature . . . . . 145
- Vibration resistance . . . . . 145

Error messages

- see Diagnostic messages

Event history . . . . . 126

Event list . . . . . 126

Ex approval . . . . . 155

Extended order code

- Sensor . . . . . 16
- Transmitter . . . . . 15

Exterior cleaning . . . . . 132

**F**

Field Communicator

- Function . . . . . 70

Field Communicator 475 . . . . . 70

Field of application

- Residual risks . . . . . 10

Field Xpert

- Function . . . . . 67

Field Xpert SFX350 . . . . . 67

FieldCare . . . . . 67

- Device description file . . . . . 71
- Establishing a connection . . . . . 68
- Function . . . . . 67
- User interface . . . . . 69

Filtering the event logbook . . . . . 127

Firmware

- Release date . . . . . 71
- Version . . . . . 71

Firmware history . . . . . 131

Fitted electrodes . . . . . 151

Flow direction . . . . . 20

Flow limit . . . . . 146

Function check . . . . . 75

Function scope

- AMS Device Manager . . . . . 69
- Field Communicator . . . . . 70
- Field Communicator 475 . . . . . 70
- Field Xpert . . . . . 67
- SIMATIC PDM . . . . . 70

Functions

- see Parameter

**G**

Galvanic isolation . . . . . 142

**H**

Hardware write protection . . . . . 104

HART certification . . . . . 155

HART protocol

- Device variables . . . . . 71
- Measured values . . . . . 71

Help text

- Calling up . . . . . 57
- Closing . . . . . 57
- Explanation . . . . . 57

**I**

I/O electronics module . . . . . 13, 40

Identifying the measuring device . . . . . 14

Impact resistance . . . . . 146

Incoming acceptance . . . . . 14

Influence

- Ambient temperature range . . . . . 144

Information on the document . . . . . 6

Inlet runs . . . . . 20

Input . . . . . 138

Input mask . . . . . 52

Inspection

- Installation . . . . . 32
- Received goods . . . . . 14

Inspection check

- Connection . . . . . 45

Installation . . . . . 19

Installation conditions

- Adapters . . . . . 22
- Down pipe . . . . . 19
- Inlet and outlet runs . . . . . 20
- Installation dimensions . . . . . 21
- Length of connecting cable . . . . . 22
- Mounting kit . . . . . 24
- Mounting location . . . . . 19
- Orientation . . . . . 20
- Partially filled pipe . . . . . 19
- System pressure . . . . . 21
- Vibrations . . . . . 21

Installation dimensions . . . . . 21

Interior cleaning . . . . . 132

**K**

Keypad lock

- Disabling . . . . . 59
- Enabling . . . . . 59

**L**

Languages, operation options . . . . . 152

Length of connecting cable . . . . . 22

Line recorder . . . . . 110

Local display . . . . . 152

- Editing view . . . . . 52
- Navigation view . . . . . 50
- see Diagnostic message



- see In alarm condition
- see Operational display
- Low flow cut off . . . . . 142
- M**
- Main electronics module . . . . . 13
- Maintenance tasks . . . . . 132
  - Replacing seals . . . . . 132
- Manufacturer ID . . . . . 71
- Manufacturing date . . . . . 15, 16
- Materials . . . . . 149
- Maximum measured error . . . . . 144
- Measured variables
  - Calculated . . . . . 138
  - Measured . . . . . 138
  - see Process variables
- Measuring and test equipment . . . . . 132
- Measuring device
  - Configuration . . . . . 75
  - Conversion . . . . . 133
  - Design . . . . . 13
  - Disposal . . . . . 134
  - Integrating via communication protocol . . . . . 71
  - Mounting the sensor . . . . . 24
    - Arranging the mounting bolts and centering sleeves . . . . . 24
    - Mounting the ground cable/ground disks . . . . . 25
    - Mounting the seals . . . . . 25
    - Screw tightening torques . . . . . 25
  - Preparing for electrical connection . . . . . 36
  - Preparing for mounting . . . . . 23
  - Removing . . . . . 134
  - Repairs . . . . . 133
  - Switch-on . . . . . 75
- Measuring principle . . . . . 138
- Measuring range . . . . . 138
- Measuring system . . . . . 138
- Measuring tube specification . . . . . 148
- Mechanical load . . . . . 146
- Medium temperature range . . . . . 146
- Menu
  - Diagnostics . . . . . 125
  - Setup . . . . . 75, 76
- Menus
  - For measuring device configuration . . . . . 75
  - For specific settings . . . . . 92
- Mounting bolts . . . . . 151
- Mounting dimensions
  - see Installation dimensions
- Mounting kit . . . . . 24
- Mounting location . . . . . 19
- Mounting preparations . . . . . 23
- Mounting tools . . . . . 23
- N**
- Nameplate
  - Sensor . . . . . 16
  - Transmitter . . . . . 15
- Navigation path (navigation view) . . . . . 50
- Navigation view
  - In the submenu . . . . . 50
  - In the wizard . . . . . 50
- Numeric editor . . . . . 52
- O**
- Operable flow range . . . . . 139
- Operating elements . . . . . 54, 117
- Operating keys
  - see Operating elements
- Operating menu
  - Menus, submenus . . . . . 47
  - Structure . . . . . 47
  - Submenus and user roles . . . . . 48
- Operating philosophy . . . . . 48
- Operation . . . . . 106
- Operation options . . . . . 46
- Operational display . . . . . 49
- Operational safety . . . . . 10
- Order code . . . . . 15, 16
- Orientation (vertical, horizontal) . . . . . 20
- Outlet runs . . . . . 20
- Output . . . . . 140
- Output signal . . . . . 140
- P**
- Packaging disposal . . . . . 18
- Parameter settings
  - Administration (Submenu) . . . . . 101
  - Burst configuration 1 to n (Submenu) . . . . . 72
  - Current output 1 (Wizard) . . . . . 80
  - Data logging (Submenu) . . . . . 110
  - Define access code (Wizard) . . . . . 100
  - Device information (Submenu) . . . . . 129
  - Diagnostics (Menu) . . . . . 125
  - Display (Submenu) . . . . . 95
  - Display (Wizard) . . . . . 86
  - Electrode cleaning circuit (Submenu) . . . . . 97
  - Empty pipe detection (Wizard) . . . . . 91
  - For the status input . . . . . 78
  - Input values (Submenu) . . . . . 108
  - Low flow cut off (Wizard) . . . . . 89
  - Output conditioning (Wizard) . . . . . 88
  - Output values (Submenu) . . . . . 108
  - Process variables (Submenu) . . . . . 107
  - Pulse/frequency/switch output 1 to n (Wizard)
    - 81, . . . . . 84
    - 82, . . . . . 84
  - Reset access code (Submenu) . . . . . 100
  - Sensor adjustment (Submenu) . . . . . 93
  - Setup (Menu) . . . . . 76
  - Simulation (Submenu) . . . . . 101
  - Status input (Submenu) . . . . . 78
  - System units (Submenu) . . . . . 77
  - Totalizer (Submenu) . . . . . 107
  - Totalizer 1 to n (Submenu) . . . . . 93
  - Totalizer handling (Submenu) . . . . . 109
  - Web server (Submenu) . . . . . 65
  - WLAN Settings (Submenu) . . . . . 98

- Parameters
  - Changing . . . . . 58
  - Enter a value . . . . . 58
- Partially filled pipe . . . . . 19
- Performance characteristics . . . . . 144
- Post-connection check (checklist) . . . . . 45
- Post-installation check . . . . . 75
- Post-installation check (checklist) . . . . . 32
- Potential equalization . . . . . 41
- Power consumption . . . . . 143
- Power supply failure . . . . . 143
- Pressure loss . . . . . 146
- Pressure tightness . . . . . 146
- Pressure-temperature ratings . . . . . 146
- Process conditions
  - Flow limit . . . . . 146
  - Medium temperature . . . . . 146
  - Pressure loss . . . . . 146
  - Pressure tightness . . . . . 146
- Process connections . . . . . 151
- Product safety . . . . . 10
- Protecting parameter settings . . . . . 103
- R**
- Radio approval . . . . . 155
- Read access . . . . . 59
- Reading measured values . . . . . 106
- Recalibration . . . . . 132
- Reference operating conditions . . . . . 144
- Registered trademarks . . . . . 8
- Remedial measures
  - Calling up . . . . . 118
  - Closing . . . . . 118
- Remote operation . . . . . 152
- Remote version
  - Connecting the signal cables . . . . . 38
- Repair of a device . . . . . 133
- Repairs . . . . . 133
  - Notes . . . . . 133
- Repeatability . . . . . 144
- Replacement
  - Device components . . . . . 133
- Replacing seals . . . . . 132
- Requirements for personnel . . . . . 9
- Return . . . . . 133
- S**
- Safety . . . . . 9
- Screw tightening torques . . . . . 25
- Sensor
  - Mounting . . . . . 24
- Serial number . . . . . 15, 16
- Setting the operating language . . . . . 75
- Settings
  - Adapting the measuring device to the process conditions . . . . . 109
  - Administration . . . . . 99
  - Advanced display configurations . . . . . 95
  - Current output . . . . . 80
  - Device reset . . . . . 129
  - Device tag . . . . . 76
  - Electrode cleaning circuit (ECC) . . . . . 97
  - Empty pipe detection (EPD) . . . . . 91
  - Local display . . . . . 86
  - Low flow cut off . . . . . 89
  - Operating language . . . . . 75
  - Output conditioning . . . . . 88
  - Pulse output . . . . . 81
  - Pulse/frequency/switch output . . . . . 81, 82
  - Resetting the totalizer . . . . . 109
  - Sensor adjustment . . . . . 93
  - Simulation . . . . . 101
  - Status input . . . . . 78
  - Switch output . . . . . 84
  - System units . . . . . 77
  - Totalizer . . . . . 93
  - Totalizer reset . . . . . 109
  - WLAN . . . . . 98
- Shock resistance . . . . . 146
- Showing data logging . . . . . 110
- Signal on alarm . . . . . 141
- SIMATIC PDM . . . . . 70
  - Function . . . . . 70
- Software release . . . . . 71
- Spare part . . . . . 133
- Spare parts . . . . . 133
- Special connection instructions . . . . . 43
- Standards and guidelines . . . . . 156
- Status area
  - For operational display . . . . . 49
  - In the navigation view . . . . . 51
- Status signals . . . . . 116, 119
- Storage conditions . . . . . 17
- Storage temperature . . . . . 17
- Storage temperature range . . . . . 145
- Structure
  - Operating menu . . . . . 47
- Submenu
  - Administration . . . . . 99, 101
  - Advanced setup . . . . . 92
  - Burst configuration 1 to n . . . . . 72
  - Data logging . . . . . 110
  - Device information . . . . . 129
  - Display . . . . . 95
  - Electrode cleaning circuit . . . . . 97
  - Event list . . . . . 126
  - Input values . . . . . 108
  - Output values . . . . . 106, 108
  - Overview . . . . . 48
  - Process variables . . . . . 107
  - Reset access code . . . . . 100
  - Sensor adjustment . . . . . 93
  - Simulation . . . . . 101
  - Status input . . . . . 78
  - System units . . . . . 77
  - Totalizer . . . . . 107
  - Totalizer 1 to n . . . . . 93
  - Totalizer handling . . . . . 109

- Web server . . . . . 65
- WLAN Settings . . . . . 98
- Supplementary documentation . . . . . 157
- Supply unit
  - Requirements . . . . . 36
- Supply voltage . . . . . 36, 143
- Symbols
  - For communication . . . . . 49
  - For correction . . . . . 52
  - For diagnostic behavior . . . . . 49
  - For locking . . . . . 49
  - For measured variable . . . . . 49
  - For measurement channel number . . . . . 49
  - For menus . . . . . 51
  - For parameters . . . . . 51
  - For status signal . . . . . 49
  - For submenu . . . . . 51
  - For wizard . . . . . 51
  - In the status area of the local display . . . . . 49
  - In the text and numeric editor . . . . . 52
- System design
  - Measuring system . . . . . 138
  - see Measuring device design
- System integration . . . . . 71
- System pressure . . . . . 21
- T**
- Technical data, overview . . . . . 138
- Temperature range
  - Ambient temperature range for display . . . . . 152
  - Storage temperature . . . . . 17
- Terminal assignment . . . . . 35, 38, 40
- Terminals . . . . . 143
- Text editor . . . . . 52
- Tool tip
  - see Help text
- Tools
  - Electrical connection . . . . . 34
  - For mounting . . . . . 23
  - Transport . . . . . 17
- Totalizer
  - Configuration . . . . . 93
- Transmitter
  - Connecting the signal cables . . . . . 40
  - Turning the display module . . . . . 31
  - Turning the housing . . . . . 28
- Transporting the measuring device . . . . . 17
- Troubleshooting
  - General . . . . . 113
- Turning the display module . . . . . 31
- Turning the electronics housing
  - see Turning the transmitter housing
- Turning the transmitter housing . . . . . 28
- U**
- Use of the measuring device
  - Borderline cases . . . . . 9
  - Incorrect use . . . . . 9
  - see Designated use
- User interface
  - Current diagnostic event . . . . . 125
  - Previous diagnostic event . . . . . 125
- User roles . . . . . 48
- V**
- Version data for the device . . . . . 71
- Vibration resistance . . . . . 145
- Vibrations . . . . . 21
- W**
- W@M . . . . . 132, 133
- W@M Device Viewer . . . . . 14, 133
- Weight
  - Compact version . . . . . 147
  - Sensor remote version . . . . . 148
  - Transport (notes) . . . . . 17
- Wizard
  - Current output 1 . . . . . 80
  - Define access code . . . . . 100
  - Display . . . . . 86
  - Empty pipe detection . . . . . 91
  - Low flow cut off . . . . . 89
  - Output conditioning . . . . . 88
  - Pulse/frequency/switch output 1 to n . . . . . 81, 82, 84
- WLAN settings . . . . . 98
- Workplace safety . . . . . 10
- Write access . . . . . 59
- Write protection
  - Via access code . . . . . 103
  - Via write protection switch . . . . . 104
- Write protection switch . . . . . 104

[www.addresses.endress.com](http://www.addresses.endress.com)

---