

Brief Operating Instructions

Proline Promag W 800

Electromagnetic flowmeter

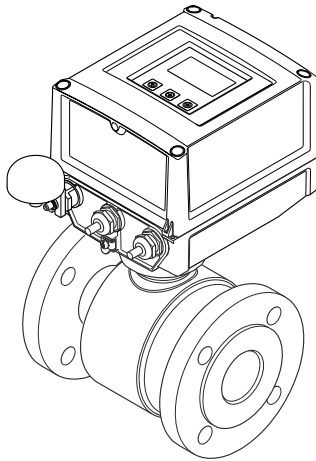

These Instructions are Brief Operating Instructions; they are not a substitute for the Operating Instructions pertaining to the device.

Detailed information about the device can be found in the Operating Instructions and the other documentation:

- On the CD-ROM supplied (is not included in the delivery for all device versions).
- Available for all device versions via:
 - Internet: www.endress.com/deviceviewer
 - Smart phone/tablet: *Endress+Hauser Operations App*

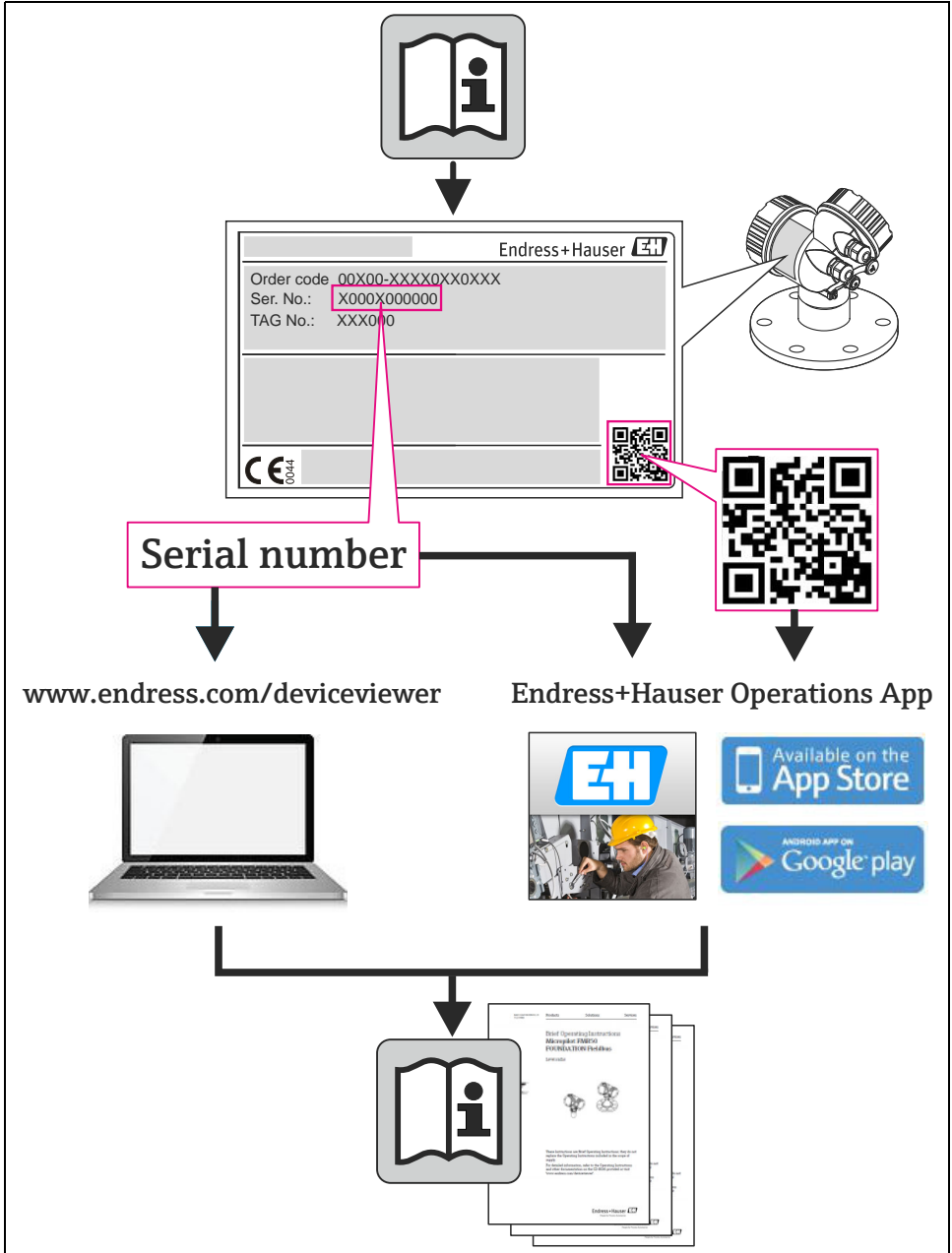

A0023555



Inhaltsverzeichnis

| | | |
|-----|---|----|
| 1 | Document information | 4 |
| 1.1 | Document conventions | 4 |
| 2 | Basic safety instructions | 6 |
| 2.1 | Personnel requirements | 6 |
| 2.2 | Designated use | 6 |
| 2.3 | Occupational safety | 7 |
| 2.4 | Operational safety | 8 |
| 2.5 | Product safety | 8 |
| 3 | Product description | 9 |
| 3.1 | Product structure | 9 |
| 4 | Incoming acceptance and product identification | 10 |
| 4.1 | Incoming acceptance | 10 |
| 4.2 | Product identification | 11 |
| 5 | Storage, transport and disposal of packaging | 12 |
| 5.1 | Storage conditions | 12 |
| 5.2 | Transporting the product | 12 |
| 5.3 | Disposing of the packaging | 13 |
| 6 | Installation | 14 |
| 6.1 | Installation conditions | 14 |
| 6.2 | Installing the measuring device | 22 |
| 6.3 | Post-installation check | 27 |
| 7 | Electrical connection | 28 |
| 7.1 | Preparing the measuring device | 28 |
| 7.2 | Connecting the measuring device | 33 |
| 7.3 | Connecting the external power supply (optional) | 36 |
| 7.4 | Inserting and connecting the batteries | 38 |
| 7.5 | Potential equalization | 42 |
| 7.6 | Guaranteeing the degree of protection of the measuring device | 45 |
| 7.7 | Post-connection check | 45 |
| 8 | Operating options | 46 |
| 8.1 | Overview of operating options | 46 |
| 8.2 | Structure and function of the operating menu | 47 |
| 8.3 | Access to the operating menu via the onsite display | 48 |
| 8.4 | Access to the operating menu via the operating tool | 51 |
| 9 | Commissioning | 52 |
| 9.1 | Commissioning with the GSM/GPRS modem | 52 |
| 9.2 | Commissioning without the GSM/GPRS modem | 52 |
| 9.3 | Inserting the SIM card | 52 |
| 9.4 | Switching on the measuring device | 53 |
| 9.5 | Establishing wireless communication | 54 |
| 9.6 | Troubleshooting | 54 |





1 Document information

1.1 Document conventions

1.1.1 Safety symbols

| Symbol | Device particularities and document content |
|--|--|
|  Caution! | "Caution" indicates an action or procedure which, if not performed correctly, can result in incorrect operation or destruction of the device. Comply strictly with the instructions. |
|  Warning! | "Warning" indicates an action or procedure which, if not performed correctly, can result in injury or a safety hazard. Comply strictly with the instructions and proceed with care. |
| Note! | "Note" indicates an action or procedure which, if not performed correctly, can have an indirect effect on operation or trigger an unexpected response on the part of the device. |









1.1.2 Electrical symbols

| Symbol | Meaning |
|--|--|
|  A0011197 | Direct current A terminal at which DC voltage is present or through which direct current flows. |
|  A0011198 | Alternating current A terminal at which alternating voltage (sinusoidal) is present or through which alternating current flows. |
|  A0011200 | Ground connection A grounded terminal which, from the viewpoint of the user, is grounded via a grounding system. |
|  A0011199 | Protective ground connection A terminal which must be connected to ground prior to establishing any other connections. |
|  A0011201 | Equipotential connection A connection that must be connected to the plant grounding system: This may be a potential equalization line or a star grounding system depending on national or company codes of practice. |



1.1.3 Tool symbols

| | | | | |
|--|---|---|---|---|
|  A0013442 |  A0011220 |  A0011219 |  A0011221 |  A0011222 |
| Torx screwdriver | Slotted screwdriver | Phillips head screwdriver | Allen screw | Open-ended wrench |

1.1.4 Symbols for types of information

| Symbol | Meaning |
|---|--|
|  A0011182 | Permitted Indicates procedures, processes or actions that are permitted. |
|  A0011183 | Preferred Indicates procedures, processes or actions that are preferred. |
|  A0011200 | Forbidden Indicates procedures, processes or actions that are forbidden. |
|  A0011193 | Tip Indicates additional information. |
|  A0011194 | Reference to documentation Refers to the corresponding device documentation. |
|  A0011195 | Reference to page Refers to the corresponding page number. |
| 1., 2., 3. ... | Series of steps |
|  | Result of a sequence of actions |
|  A0013562 | Help in the event of a problem |

1.1.5 Symbols for graphics

| Symbol | Meaning |
|---|--|
| 1, 2, 3 ... | Item numbers |
| A, B, C etc. | Views |
| A-A, B-B, C-C etc. | Item numbers |
|  A0013441 | Flow direction |
|  A0011187 | Hazardous area Indicates the hazardous area. |
|  A0011187 | Safe area (non-hazardous area) Indicates the non-hazardous area. |

2 Basic safety instructions

2.1 Personnel requirements

The operating personnel must fulfill the following requirements in their work:

- Trained, qualified specialists
 - must have a relevant qualification for this specific function and task.
- Are authorized by the plant owner/operator.
- Are familiar with federal/national regulations.
- Before beginning work, the specialist staff must have read and understood the instructions in the Operating Instructions and supplementary documentation as well as in the certificates (depending on the application).
- Follow instructions and comply with conditions.

2.2 Designated use

Application and fluids

The measuring device described in this manual is to be used only for measuring the flow rate of conductive liquids in closed pipes.

A minimum conductivity of 50 $\mu\text{S}/\text{cm}$ is required for measuring purposes.

The measuring device is designed to measure the following fluids:

- Drinking water
- Rain water
- Spring water

In compliance with the limit values specified in the "Technical data" section and the general conditions indicated in the manual and supplementary documentation, the measuring device may only be used for the following measurements:

- Measured measured variables: volume flow
- Calculated measured variables: mass flow

To ensure that the measuring device remains in proper operating condition for its service life:

- Only use the measuring device for fluids to which the process-wetted materials are adequately resistant.
- Comply with the limit values in the "Technical data" section.

Note!

As an option, Promag W 800 is tested in accordance with OIML R49 and has an EC type-examination certificate as per Measuring Instruments Directive 2004/22/EC (MID) for service subject to legal metrological control ("custody transfer") for cold water (Annex MI-001).

The permitted fluid temperature in these applications is 0 to +50 °C (+32 to +122 °F).

Incorrect use

The manufacturer is not liable for damage resulting from improper or non-designated use. An improper or non-designated use can affect the safety.

Clarification of borderline cases:

- With regard to special fluids and media used for cleaning, Endress+Hauser will be happy to assist in clarifying the corrosion-resistant properties of wetted materials but gives no guarantee or warranty as to the suitability of the materials.

Residual risks

 Warning!

Due to the power throughput in the electronic components, the outer housing surfaces can heat up by a maximum of 20 K. When hot fluid passes through the measuring tube, the surface temperature of the housing increases. In the case of the sensor, in particular, users should expect temperatures that can be close to the fluid temperature.

Hot fluids can present a burn hazard!

- For elevated fluid temperatures, ensure adequate protection against contact to prevent burns.

2.3 Occupational safety

When working on or with the device:

- Always wear the necessary personal protective equipment as defined in national regulations.

When performing welding work on the pipe:

- Do not ground the welding equipment via the measuring device.

When working with batteries:

- The device is powered by lithium-thionyl chloride high-power batteries. This has implications for occupational safety and device storage.

 Warning!

Lithium-thionyl chloride high-power batteries are categorized as Class 9: "Miscellaneous Hazardous Materials". Comply strictly with the hazardous material regulations described in the safety data sheet.

You can request the safety data sheet from your Endress+Hauser Sales Center.

2.4 Operational safety

Risk of injury.

- Only operate the device if it is in a perfect technical condition free from errors and faults.
- The operator is responsible for the trouble-free operation of the device.

Conversions to the device

Unauthorized modifications to the device are not permitted and can lead to unforeseeable dangers:

- If, despite this, modifications are required, consult with Endress+Hauser.

Repair

To ensure operational safety:

- Only perform repair work on the device if this is expressly permitted.
- Comply strictly with national regulations concerning the repair of electrical equipment.
- Only use genuine Endress+Hauser spare parts and accessories.

Hazardous area

To exclude any risks to individuals or the facility when operating the device in the hazardous areas:

- Based on the nameplate, check whether the ordered device is permitted for the intended use in the hazardous area.

2.5 Product safety

This measuring device is designed to meet state-of-the-art safety requirements in accordance with sound engineering practice, has been tested and left the factory in a condition in which it is safe to operate.

It meets the general safety requirements and legal requirements. Furthermore, it complies with the EC directives which are listed in the device-specific EC Declaration of Conformity.

Endress+Hauser confirms this by affixing the CE mark to the device.

3 Product description

3.1 Product structure

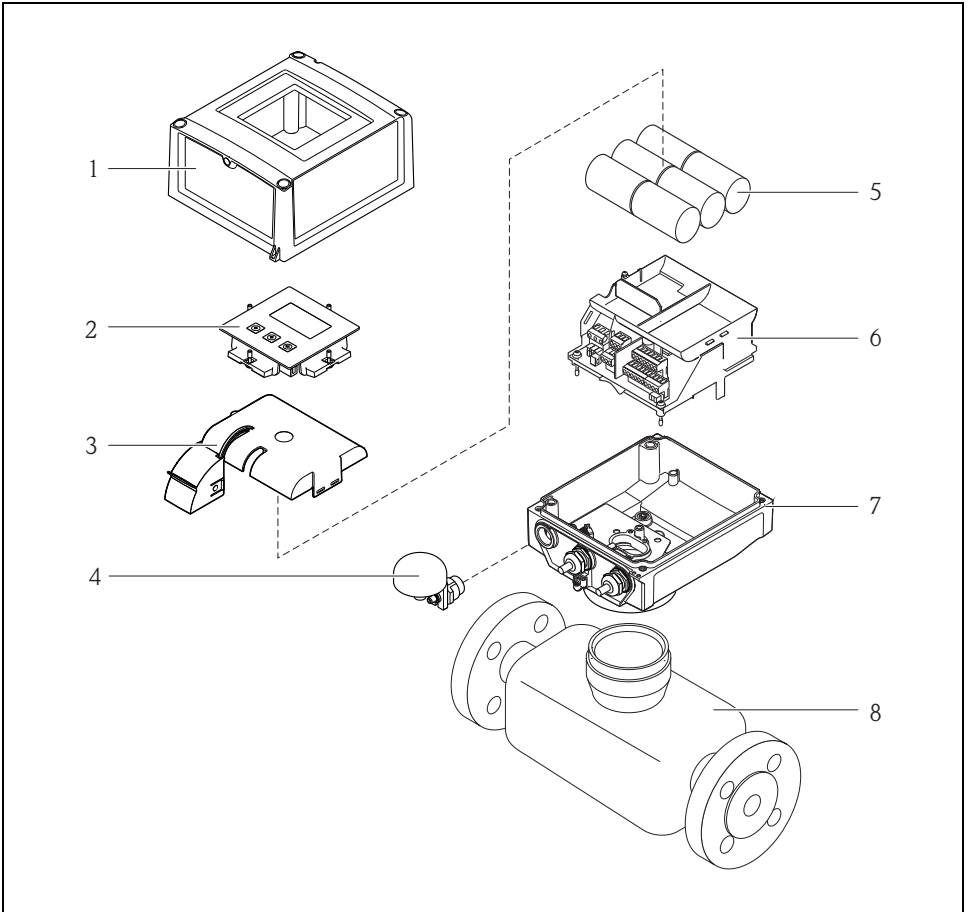

Fig. 1: Primary components of the measuring device

A0016254

- 1 Transmitter housing cover
- 2 Display and operating module
- 3 Battery cover
- 4 GSM antenna
- 5 Batteries
- 6 Electronics board carrier incl. battery compartment
- 7 Transmitter housing
- 8 Sensor

4 Incoming acceptance and product identification

4.1 Incoming acceptance

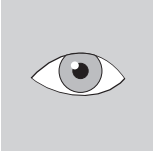

A0013696

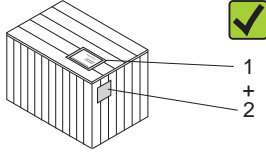
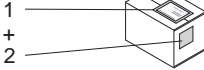

A0013843

Is the order code in the delivery note (1) identical to the order code on the product sticker (2)?

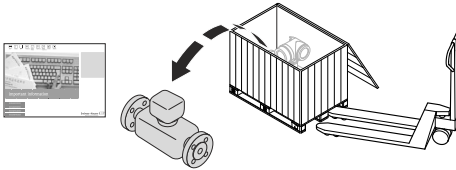

A0013695

Note! The lithium-thionyl chloride high-power batteries are provided in a separate package. Pay attention to the occupational safety instructions when handling batteries → 7.

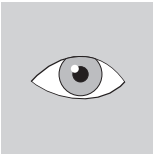

A0013696

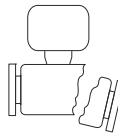
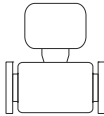

A0013698

Goods undamaged?

Caution!

If batteries are damaged, comply strictly with the hazardous material regulations described in the safety data sheet. You can request the safety data sheet from your Endress+Hauser Sales Center.

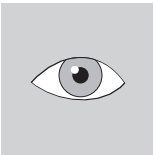

A0013696

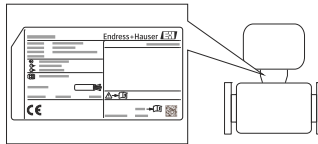

A0013699

Do the data on the nameplate correspond to the order data on the delivery note?

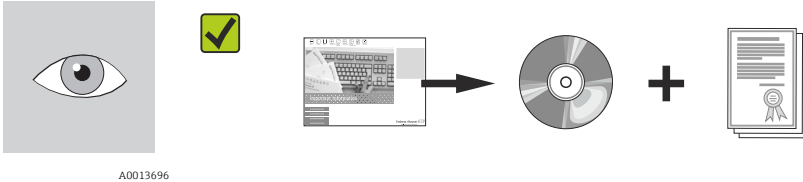

- If one of the conditions is not satisfied, contact your Endress+Hauser Sales Center.
- Depending on the device version, the CD-ROM might not be part of the delivery! The Technical Documentation is available via the Internet or via the *Endress+Hauser Operations App*.

4.2 Product identification

The following options are available for identification of the measuring device:

- Nameplate specifications
- Order code with breakdown of the device features on the delivery note
- Enter serial numbers from nameplates in *W@M Device Viewer* (www.endress.com/deviceviewer): All information about the measuring device is displayed.
- Enter the serial number from the nameplates into the *Endress +Hauser Operations App* or scan the 2-D matrix code (QR code) on the nameplate with the *Endress +Hauser Operations App*: all the information for the measuring device is displayed.

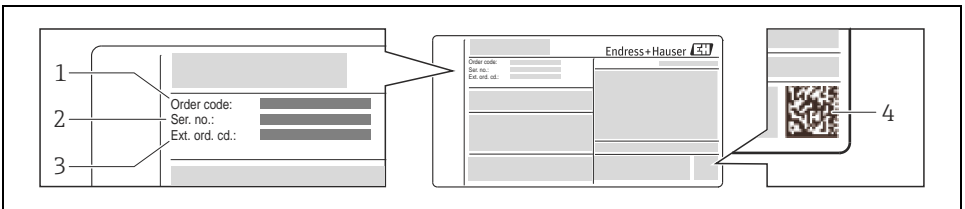

Fig. 2: Example of a nameplate

- 1 Order code
- 2 Serial number (Ser. no.)
- 3 Extended order code (Ext. ord. cd.)
- 4 2-D matrix code (QR code)



For detailed information on the breakdown of the specifications on the nameplate, see Operating Instructions for the device.

5 Storage, transport and disposal of packaging

5.1 Storage conditions

Note the following when storing the device:

- Store in the original packaging to protect against impact.
- Do not remove protective covers or protection caps mounted on process connections.
 - They prevent mechanical damage to the sealing surfaces and fouling in the measuring pipe.
- Protect from sunlight to avoid impermissibly high surface temperatures.
- Choose a storage location where moisture does not collect in the measuring device. This will help prevent fungus and bacteria infestation which can damage the liner.
- Store in a dry, dust-free atmosphere.
- Do not store outdoors.
- Storage temperature:
 - Transmitter: -20 to $+60$ °C (-4 to $+140$ °F)
 - Sensor:
 - Flange material carbon steel: -10 to $+60$ °C (14 to $+140$ °F)
 - Flange material stainless steel: -40 to $+60$ °C (-40 to $+140$ °F)
- Also be mindful of the following when storing the batteries:
 - Avoid any short-circuiting of the battery poles.
 - The storage temperature should preferably be ≤ 21 °C (70 °F).
 - Store in a dry, dust-free atmosphere that is not subject to large fluctuations in temperature.
 - Protect from sunlight.
 - Do not store near heaters.

5.2 Transporting the product

 Warning!

Risk of injury if the measuring device slips.

The center of gravity of the measuring device is higher than the points around which the webbing slings are slung.

- Secure the measuring device so that it does not turn around its axis or slip.

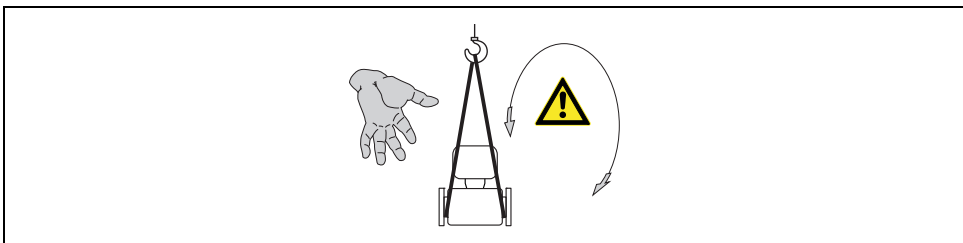



Fig. 3: Risk of injury if the measuring device slips when transporting sensors

A0015606

 **Caution!**

Note the following when transporting the device:

- Transport the measuring device to the measuring point in its original packaging.
- Do not remove protective covers or protection caps mounted on process connections. They prevent mechanical damage to the sealing surfaces and fouling in the measuring pipe.
- Pay attention to the weight information on the packaging (adhesive label).
- Observe the transportation instructions on the adhesive label on the electronics compartment cover.
- Do not lift the measuring device by the transmitter housing or the connection housing of the remote version.
- Lifting tool
 - Use webbing slings (avoid chains as these could damage the housing).
 - For wood crates, the floor structure enables these to be loaded lengthwise or broadside using a forklift.
- Using the webbing slings, lift the measuring device by the process connections, not by the transmitter housing.

5.3 Disposing of the packaging



Detailed information on the disposal of packaging material:

Operating Instructions for the device on the enclosed CD-ROM

6 Installation

6.1 Installation conditions

No special measures such as supports are necessary. External forces are absorbed by the construction of the device.

6.1.1 Mounting position

Mounting location

Preferably install the sensor in an ascending pipe, and ensure a sufficient distance ($\geq 2 \times \text{DN}$) to the next pipe elbow.

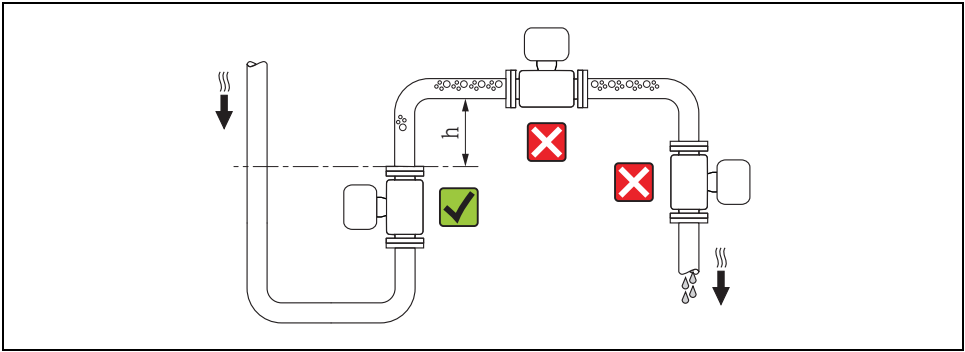



Fig. 4: Selecting the mounting location

A0017061

To prevent measuring errors from gas bubbles accumulating in the measuring tube, avoid the following mounting locations in the pipe:

- Highest point of a pipeline
- Directly upstream of a free pipe outlet in a down pipe

Installation in down pipes

Install a siphon or a vent valve downstream of the sensor in down pipes whose length $h \geq 5$ m (16.4 ft), (\rightarrow  5). This precaution is to avoid low pressure and the consequent risk of damage to the lining of the measuring tube. This measure also prevents the system losing prime, which could cause air pockets.



Detailed information on the lining's resistance to partial vacuum:
Operating Instructions for the device on the enclosed CD-ROM

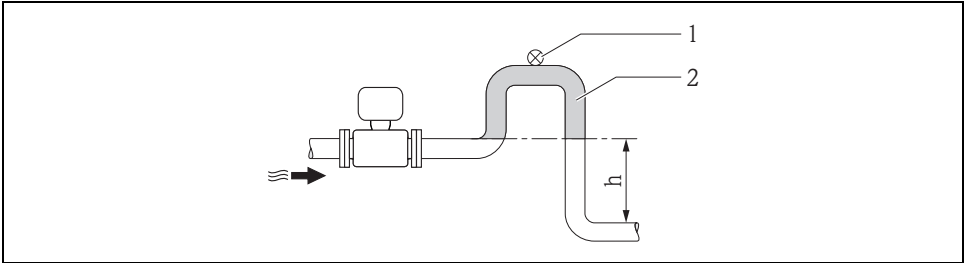

Fig. 5: Measures for installation in a down pipe

A0017064

- 1 Vent valve
- 2 Pipe siphon
- h Length of down pipe, $h \geq 5$ m (16.4 ft)

Installation in partially filled pipes with a gradient

Partially filled pipes with gradients necessitate a drain-type configuration.



Caution!

Risk of solids accumulating.

- Do not install the sensor at the lowest point in the drain.
- It is advisable to install a cleaning valve.

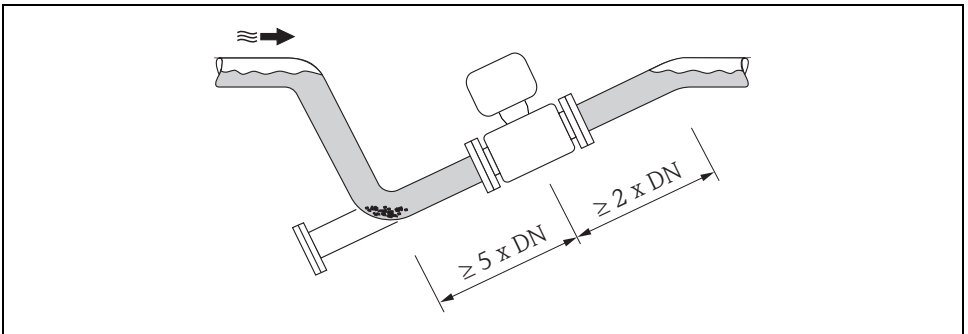



Fig. 6: Installation in a partially filled pipe

A0017063

If using pumps

- If pumps are used, do not install the sensor on the intake side of a pump. This precaution is to avoid low pressure and the consequent risk of damage to the lining of the measuring tube. Information on the lining's resistance to partial vacuum can be found on →  20.
- If reciprocating, diaphragm or peristaltic pumps are used, it might be necessary to install pulse dampers.



Detailed information on the measuring system's resistance to vibration and shock: Operating Instructions for the device on the enclosed CD-ROM

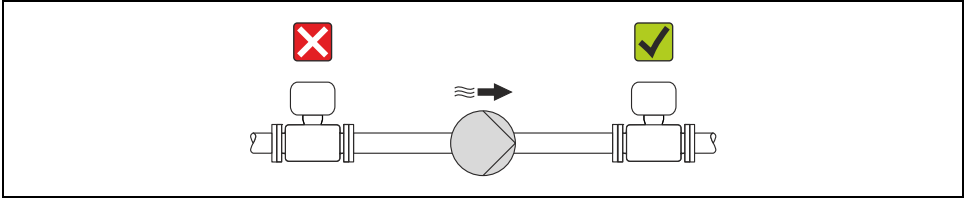

A0015594

Fig. 7: Installation if using pumps

For permanent immersion in water

The fully welded remote version of the measuring device can be immersed permanently in water to a depth of ≤ 3 m (10 ft) or 48 h at ≤ 10 m (30 ft). The measuring device satisfies diverse corrosion protection categories in accordance with EN ISO 12944. The fully welded design along with the connection compartment sealing system ensure that moisture cannot enter the measuring device.

The connecting cables of the remote version can be ordered:

- With pre-terminated cables that are already connected to the sensor.
- **Optionally:** With pre-terminated cables, where the cables are connected by the customer onsite (incl. tools for sealing the connection compartment).

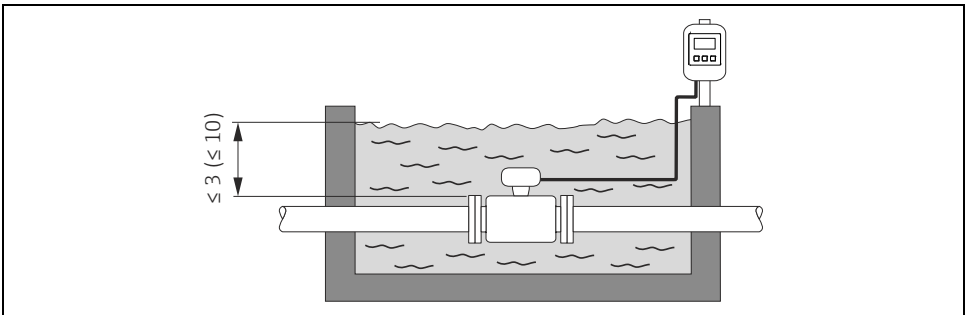

A0017296

Fig. 8: Installation for permanent immersion in water

For buried applications

The fully welded remote version of the measuring device can be used for buried applications. The measuring device satisfies the certified corrosion protection Im3 in accordance with EN ISO 12944.

It can be used directly underground without the need for additional protective measures. The device is installed in accordance with the usual regional installation regulations (e.g. EN DIN 1610).

The connecting cables of the remote version can be ordered:

- With pre-terminated cables that are already connected to the sensor.
- **Optionally:** With pre-terminated cables, where the cables are connected by the customer onsite (incl. tools for sealing the connection compartment).

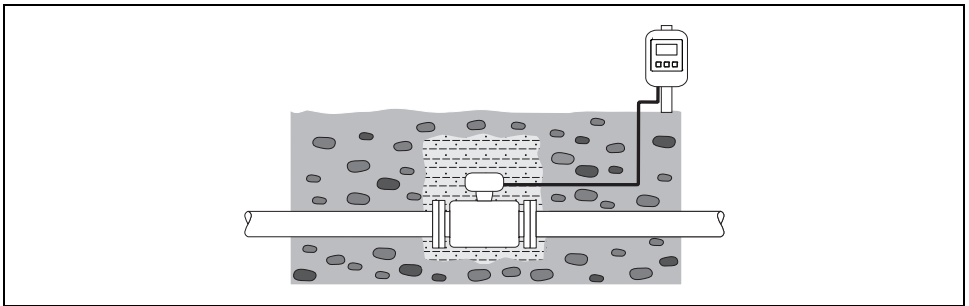

Fig. 9: Installation for buried applications

A0017298

Orientation

An optimum orientation position helps avoid gas and air accumulations and deposits in the measuring tube.

Vertical orientation

Vertical orientation is optimal in the following scenarios:

- For self-emptying piping systems.
- For sludge containing sand or stones where the solids tend to settle at the bottom.

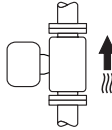

Fig. 10: Vertical orientation

A0015591

Horizontal orientation

The measuring electrode plane should be horizontal in the case of horizontal orientation. This prevents brief insulation of the two measuring electrodes by entrained air bubbles.

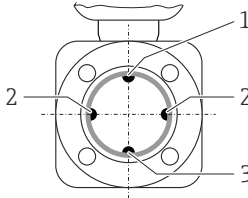

Fig. 11: Horizontal orientation

A0016260

- 1 EPD electrode for the detection of empty pipes (not supported by the transmitter)
- 2 Measuring electrodes used for measuring signal pick up and empty pipe detection (EPD). An EPD alarm is triggered if there is no fluid between electrodes.
- 3 Reference electrode for potential equalization

Inlet and outlet runs

If possible, install the sensor upstream from fittings such as valves, T-pieces, elbows, etc. Observe the following inlet and outlet runs in order to meet accuracy specifications:

- Inlet run $\geq 5 \times \text{DN}$
- Outlet run $\geq 2 \times \text{DN}$

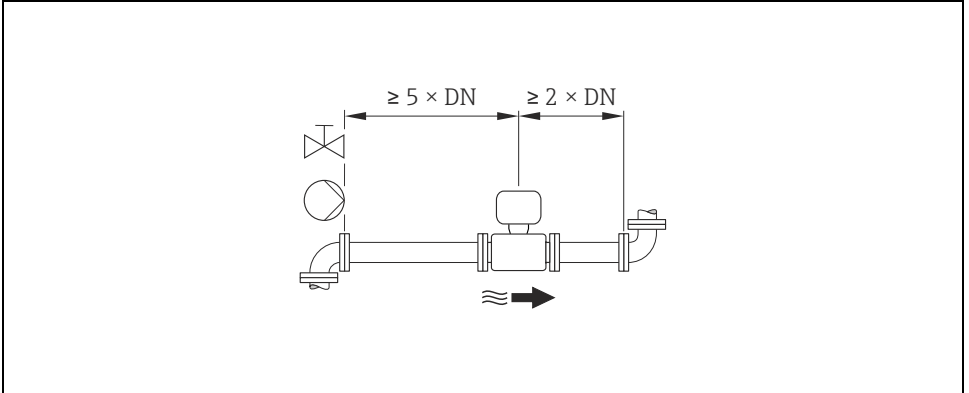

Fig. 12: Inlet and outlet runs

A0016275



No special requirements must be observed at the inlet and outlet runs to keep within the in-service maximum permissible errors for custody transfer.

6.1.2 Environmental and process-specific requirements

Ambient temperature range

Transmitter

-20 to +60 °C (-4 to +140 °F)

Sensor

- Flange material carbon steel: -10 to +60 °C (14 to +140 °F)
- Flange material stainless steel: -40 to +60 °C (-40 to +140 °F)

Pressure tightness

Promag W (Liner: polyurethane, hard rubber)

| Nominal diameter | | Measuring tube liner | Liner pressure tightness: limit values for absolute pressure at different fluid temperatures | | |
|------------------|----------|----------------------|--|--------------------------------|--------------------------------|
| [mm] | [inch] | | 25 °C (77 °F) [mbar]/[psi] | 50 °C (122 °F) [mbar]/[psi] | 80 °C (176 °F) [mbar]/[psi] |
| 25 to 300 | 1 to 12" | Polyurethane | 0 | 0 | - |
| 50 to 300 | 2 to 12" | Hard rubber | 0 | 0 | 0 |

Corrosive environment

The fully welded remote version of the measuring device can be immersed permanently in in corrosive (saline) environments. The measuring device satisfies the certified corrosion protection in accordance with EN ISO 12944 C5M. The fully welded design along with the varnish finish ensure that the device can be used in saline environments.

Vibrations

In the event of strong vibrations: support and fix the pipe and sensor.

 Caution!

If vibrations are too severe, we recommend the sensor and transmitter be mounted separately.

 Detailed information on the measuring system's resistance to vibration and shock: Operating Instructions for the device on the enclosed CD-ROM

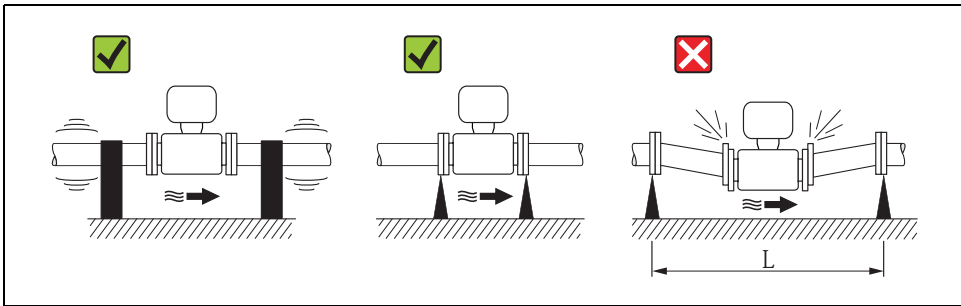

Fig. 13: Measures to prevent vibration of the device (L > 10 m (33 ft))

A0016266

6.1.3 Special installation

Adapters

Suitable adapters to DIN EN 545 (double-flange reducers) can be used to install the sensor in larger-diameter pipes. The resultant increase in the rate of flow improves measuring accuracy with very slow-moving fluids. The nomogram shown here can be used to calculate the pressure loss caused by reducers and expanders.

Note! The nomogram only applies to liquids of viscosity similar to water.

Determining the pressure loss:

1. Calculate the ratio of the diameters d/D .
2. From the nomogram read off the pressure loss as a function of flow velocity (downstream from the reduction) and the d/D ratio.

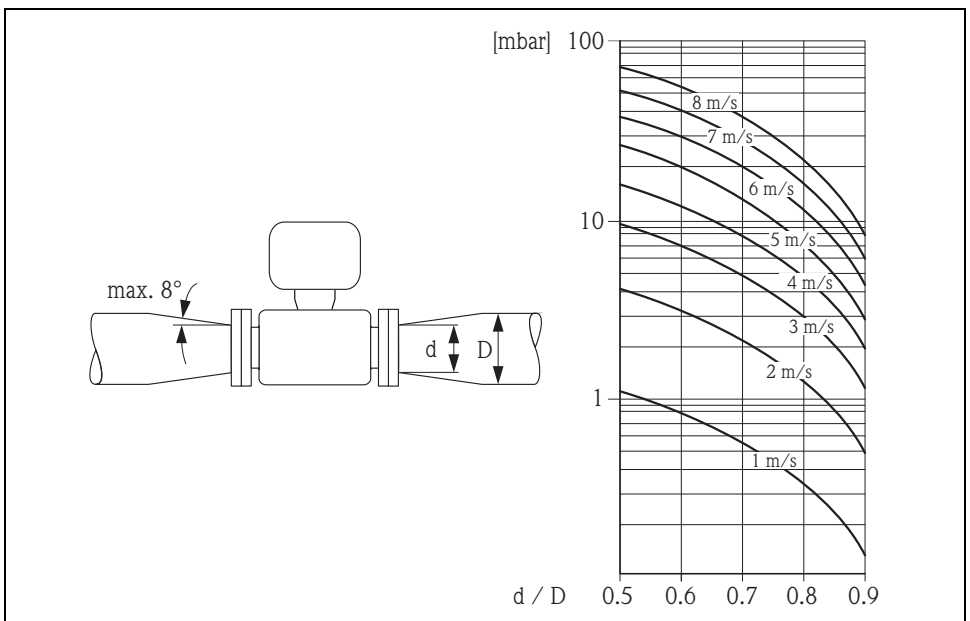

Fig. 14: Pressure loss due to adapters

A0016359

Nominal diameter and flow rate



Detailed information on the nominal diameter and flow rate:
Operating Instructions for the device on the enclosed CD-ROM

Connecting cable

In order to ensure measuring accuracy, comply with the following instructions when installing a remote version:

- Fix the cable run or route it in an armored conduit. Cable movements can falsify the measuring signal especially in the case of low fluid conductivities.
- Route the cable well clear of electrical machines and switching elements.
- Ensure potential equalization between sensor and transmitter, if necessary.
- The maximum connecting cable length is 20 m (35.6 ft).

GSM/GPRS antenna

Check the signal strength of the mobile communications network before mounting the GSM/GPRS antenna.



Detailed information on checking the mobile communications network:
Operating Instructions for the device on the enclosed CD-ROM

6.2 Installing the measuring device

6.2.1 Installing the Promag W sensor

Required mounting tools

For flange and other process connections:

- Bolts, nuts, seals, etc. These items are not included in the scope of supply and must be supplied by the customer.
- Appropriate mounting tools

Installing the sensor

Mount the sensor between the pipe flanges.

In doing so, please note the following:

- Required screw tightening torques →  23.
- If using ground disks:

Comply with the Installation Instructions provided with the ground disks.

Mounting the seals



Caution!

Risk of short circuit!

Do not use electrically conductive sealing compounds such as graphite! An electrically conductive layer could form on the inside of the measuring tube and short-circuit the measuring signal.

Comply with the following instructions when installing seals:

- For hard rubber lining: additional seals are **always** required.
- For polyurethane lining: generally additional seals are **not** required.
- For DIN flanges: only use seals according to EN 1514-1.

- Make sure that the seals do not protrude into the piping cross-section.

Mounting the ground cable

Comply with the following instructions when installing the ground cable:





- Comply with the information on potential equalization and detailed mounting instructions for the use of ground cables on →  42
- If necessary, you can order special ground cables for potential equalization as an accessory.

Screw tightening torques for mounting the Promag W sensor

Please note the following:

- The tightening torques listed below are for lubricated threads only.
- Tighten the screws uniformly and in diagonally opposite sequence.
- Overtightening the screws will deform the sealing faces or damage the seals.
- The tightening torques listed below apply only to pipes not subjected to tensile stress.

Tightening torques for:

- EN (DIN) →  23
- ASME →  24
- AS →  24
- JIS →  25

Promag W tightening torques for EN (DIN)

| Nominal diameter [mm] | EN (DIN) Pressure rating [bar] | Threaded fasteners | Max. tightening torque [Nm] | |
|--------------------------|-----------------------------------|--------------------|-----------------------------|--------------|
| | | | Hard rubber | Polyurethane |
| 25 | PN 40 | 4 × M 12 | – | 15 |
| 32 | PN 40 | 4 × M 16 | – | 24 |
| 40 | PN 40 | 4 × M 16 | – | 31 |
| 50 | PN 40 | 4 × M 16 | 48 | 40 |
| 65* | PN 16 | 8 × M 16 | 32 | 27 |
| 65 | PN 40 | 8 × M 16 | 32 | 27 |
| 80 | PN 16 | 8 × M 16 | 40 | 34 |
| 80 | PN 40 | 8 × M 16 | 40 | 34 |
| 100 | PN 16 | 8 × M 16 | 43 | 36 |
| 100 | PN 40 | 8 × M 20 | 59 | 50 |
| 125 | PN 16 | 8 × M 16 | 56 | 48 |
| 125 | PN 40 | 8 × M 24 | 83 | 71 |
| 150 | PN 16 | 8 × M 20 | 74 | 63 |
| 150 | PN 40 | 8 × M 24 | 104 | 88 |
| 200 | PN 10 | 8 × M 20 | 106 | 91 |
| 200 | PN 16 | 12 × M 20 | 70 | 61 |
| 200 | PN 25 | 12 × M 24 | 104 | 92 |
| 250 | PN 10 | 12 × M 20 | 82 | 71 |
| 250 | PN 16 | 12 × M 24 | 98 | 85 |

| Nominal diameter [mm] | EN (DIN) | | Max. tightening torque [Nm] | |
|--------------------------|-----------------------|--------------------|-----------------------------|--------------|
| | Pressure rating [bar] | Threaded fasteners | Hard rubber | Polyurethane |
| 250 | PN 25 | 12 × M 27 | 150 | 134 |
| 300 | PN 10 | 12 × M 20 | 94 | 81 |
| 300 | PN 16 | 12 × M 24 | 134 | 118 |
| 300 | PN 25 | 16 × M 27 | 153 | 138 |

* Designed acc. to EN 1092-1 (not to DIN 2501)

Promag W tightening torques for ASME

| Nominal diameter | | ASME Pressure rating [lbs] | Threaded fasteners | Max. tightening torque | | | |
|------------------|-------|-------------------------------|--------------------|------------------------|------------|----------------------|------------|
| [mm] | [in.] | | | Hard rubber [Nm] | [lbf · ft] | Polyurethane [Nm] | [lbf · ft] |
| 25 | 1" | Class 150 | 4 × ½" | - | - | 7 | 5 |
| 25 | 1" | Class 300 | 4 × 5/8" | - | - | 8 | 6 |
| 50 | 2" | Class 150 | 4 × 5/8" | 35 | 26 | 22 | 16 |
| 50 | 2" | Class 300 | 8 × 5/8" | 18 | 13 | 11 | 8 |
| 80 | 3" | Class 150 | 4 × 5/8" | 60 | 44 | 43 | 32 |
| 80 | 3" | Class 300 | 8 × ¾" | 38 | 28 | 26 | 19 |
| 100 | 4" | Class 150 | 8 × 5/8" | 42 | 31 | 31 | 23 |
| 100 | 4" | Class 300 | 8 × ¾" | 58 | 43 | 40 | 30 |
| 150 | 6" | Class 150 | 8 × ¾" | 79 | 58 | 59 | 44 |
| 150 | 6" | Class 300 | 12 × ¾" | 70 | 52 | 51 | 38 |
| 200 | 8" | Class 150 | 8 × ¾" | 107 | 79 | 80 | 59 |
| 250 | 10" | Class 150 | 12 × 7/8" | 101 | 74 | 75 | 55 |
| 300 | 12" | Class 150 | 12 × 7/8" | 133 | 98 | 103 | 76 |

Promag W tightening torques for AS

| Nominal diameter [mm] | AS | | Max. tightening torque [Nm] | |
|--------------------------|-----------------|--------------------|-----------------------------|--------------|
| | Pressure rating | Threaded fasteners | Hard rubber | Polyurethane |
| 80 | Table E | 4 × M 16 | 49 | - |
| 80 | PN 16 | 4 × M 16 | 49 | - |
| 100 | Table E | 8 × M 16 | 38 | - |
| 100 | PN 16 | 4 × M 16 | 76 | - |
| 150 | Table E | 8 × M 20 | 64 | - |
| 150 | PN 16 | 8 × M 20 | 52 | - |
| 200 | Table E | 8 × M 20 | 96 | - |
| 200 | PN 16 | 8 × M 20 | 77 | - |
| 250 | Table E | 12 × M 20 | 98 | - |
| 250 | PN 16 | 8 × M 20 | 147 | - |
| 300 | Table E | 12 × M 24 | 123 | - |

| Nominal diameter [mm] | AS | Threaded fasteners | Max. tightening torque [Nm] | |
|--------------------------|-----------------|--------------------|-----------------------------|--------------|
| | Pressure rating | | Hard rubber | Polyurethane |
| 300 | PN 16 | 12 × M 24 | 103 | - |

Promag W tightening torques for JIS

| Nominal diameter [mm] | JIS | Threaded fasteners | Max. tightening torque [Nm] | |
|--------------------------|-----------------|--------------------|-----------------------------|--------------|
| | Pressure rating | | Hard rubber | Polyurethane |
| 25 | 20K | 4 × M 16 | - | 19 |
| 32 | 20K | 4 × M 16 | - | 22 |
| 40 | 20K | 4 × M 16 | - | 24 |
| 50 | 10K | 4 × M 16 | 40 | 33 |
| 50 | 20K | 8 × M 16 | 20 | 17 |
| 65 | 10K | 4 × M 16 | 55 | 45 |
| 65 | 20K | 8 × M 16 | 28 | 23 |
| 80 | 10K | 8 × M 16 | 29 | 23 |
| 80 | 20K | 8 × M 20 | 42 | 35 |
| 100 | 10K | 8 × M 16 | 35 | 29 |
| 100 | 20K | 8 × M 20 | 56 | 48 |
| 125 | 10K | 8 × M 20 | 60 | 51 |
| 125 | 20K | 8 × M 22 | 91 | 79 |
| 150 | 10K | 8 × M 20 | 75 | 63 |
| 150 | 20K | 12 × M 22 | 81 | 72 |
| 200 | 10K | 12 × M 20 | 61 | 52 |
| 200 | 20K | 12 × M 22 | 91 | 80 |
| 250 | 10K | 12 × M 22 | 100 | 87 |
| 250 | 20K | 12 × M 24 | 159 | 144 |
| 300 | 10K | 16 × M 22 | 74 | 63 |
| 300 | 20K | 16 × M 24 | 138 | 124 |

Pipe mounting

The assembly should be performed by following the instructions in the graphic.

 Caution!

If using a warm pipe, make sure that temperatures do not exceed the permitted ambient temperature range .

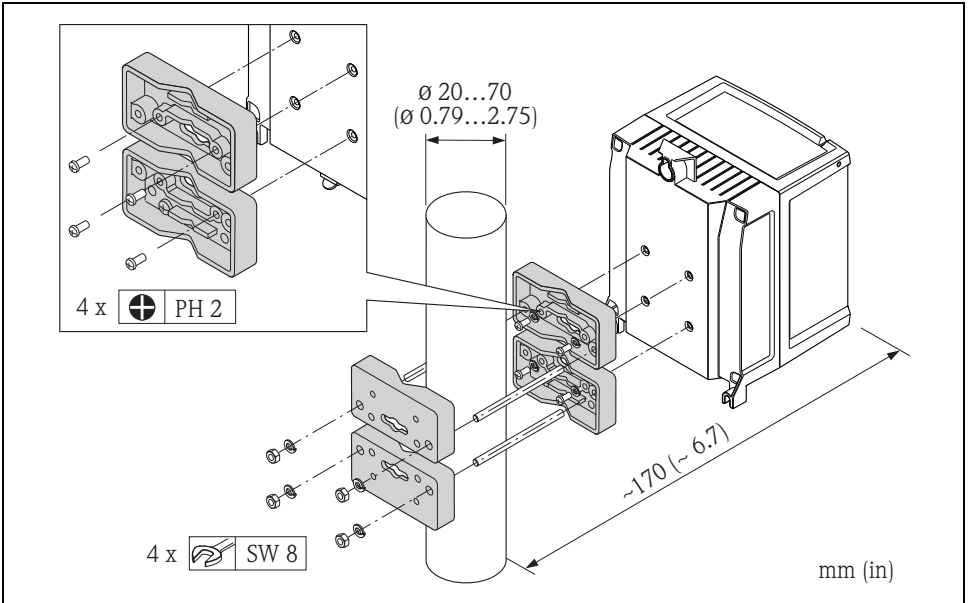



Fig. 16: Pipe mounting (wall-mount housing)

A0016412

6.3 Post-installation check

| | |
|---|--------------------------|
| Is the measuring device undamaged (visual inspection)? | <input type="checkbox"/> |
| Does the measuring device meet the specifications of the measuring point? For example, process temperature, process pressure, ambient temperature, measuring range etc. | <input type="checkbox"/> |
| Has the correct orientation been selected for the sensor →  14? <ul style="list-style-type: none"> ■ According to sensor type ■ According to fluid temperature ■ According to fluid properties (outgassing, with entrained solids) | <input type="checkbox"/> |
| Does the arrow on the sensor nameplate match the actual direction of fluid flow through the pipe? | <input type="checkbox"/> |
| Are the measuring point identification and labeling correct (visual inspection)? | <input type="checkbox"/> |
| Is the device adequately protected from precipitation and direct sunlight? | <input type="checkbox"/> |
| Have the fastening elements been tightened with the correct tightening torque? | <input type="checkbox"/> |

7 Electrical connection

7.1 Preparing the measuring device

7.1.1 Required mounting tools

- For cable entries: use an appropriate tool.
- For the housing cover: use a Phillips head screwdriver.
- Cable stripper.
- For stranded cables: use a crimper for wire end ferrules.
- To remove cables from terminals: use a slotted screwdriver ≤ 3 mm (0.12 in).

7.1.2 Connecting cable requirements

The connecting cables provided by the customer must meet the following criteria:

Electrical safety

According to national regulations.

Cable specification

- Permitted temperature range: -40 to 80 °C (-40 to 176 °F);
Minimum ambient temperature: $+20$ K
- A shielded cable is recommended.
- Stripped length: 6 mm
- Strand (flexible): 2.5 mm²
- Cable diameter
 - With cable glands supplied:
M20 \times 1.5 with cable \varnothing 6 to 12 mm (0.24 to 0.47 in)
 - Plug-in screw terminals: core cross-sections 0.5 to 2.5 mm² (20 to 14 AWG)

7.1.3 Connecting cable requirements for the remote version

The connecting cables for the remote version provided by the customer must meet the following criteria:

Cable specifications

Electrode cable

- 3×0.38 mm² PVC cable with common, braided copper shield ($\varnothing \sim 7$ mm) and individually shielded cores
- Conductor resistance: ≤ 50 Ω /km
- Capacitance: core/shield: ≤ 420 pF/m
- Operating temperature: -20 to $+80$ °C (-4 to 176 °F)
- Cable cross-section: max. 2.5 mm²

Coil current cable

- $2 \times 0.75 \text{ mm}^2$ PVC cable with common, braided copper shield ($\varnothing \sim 7 \text{ mm}$)
- Conductor resistance: $\leq 37 \text{ } \Omega/\text{km}$
- Capacitance: core/core, shield grounded: $\leq 120 \text{ pF/m}$
- Operating temperature: -20 to $+80 \text{ } ^\circ\text{C}$ (-4 to $176 \text{ } ^\circ\text{F}$)
- Cable cross-section: max. 2.5 mm^2
- Test voltage for cable insulation: $\geq 1433 \text{ V AC r.m.s } 50/60 \text{ Hz}$ or $\geq 2026 \text{ V DC}$

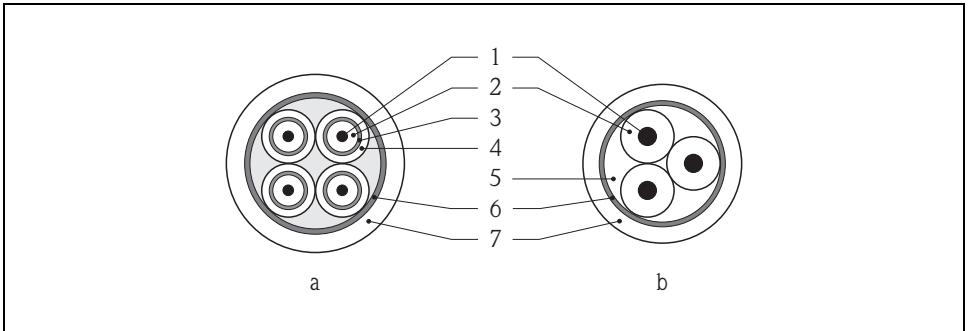

Fig. 17: Cable cross-section

A0003194

- a* Electrode cable
b Coil current cable
- 1 Core
2 Core insulation
3 Core shield
4 Core jacket
5 Core reinforcement
6 Cable shield
7 Outer jacket

7.1.4 Preparing the electrode and coil current cable

Terminate the electrode and coil current cables as shown in the figure below (Detail A).
Fit the fine-wire cores with wire end ferrules (Detail B).

 **Caution!**

Please note the following when terminating the cables:

- For electrode cable:
 - Make sure that the ferrules do not touch the wire shield on the sensor side.
 - Minimum distance = 1 mm (exception “GND” = green cable).
- For coil current cable:
 - Insulate one core of the three-core wire at the level of the core reinforcement. You only require two cores for the connection.

Transmitter

| Electrode cable | Coil current cable |
|---|--|
| <p style="text-align: center;">A</p> <p style="text-align: center;">B</p> <p style="text-align: right;">A0016477</p> | <p style="text-align: center;">A</p> <p style="text-align: center;">B</p> <p style="text-align: right;">A0016479</p> |
| <p style="text-align: center;"><i>Abb. 18: Engineering unit mm (in)</i></p> <p>A = Termination of the cables B = Termination of the fine-wire cores with ferrules 1 = Red ferrules, ϕ 1.0 mm (0.04 in) 2 = White ferrules, ϕ 0.5mm (0.02 in) * = Stripping only for reinforced cables</p> | |

Abb. 19: Engineering unit mm (in)

Sensor

| Electrode cable | Coil current cable |
|---|--|
| <p>A</p> <p>B</p> <p>GND</p> <p>1</p> <p>2</p> <p>2</p> <p>2</p> <p>1</p> <p>$\geq 1 (0.04)$</p> <p>20 (0.79)* 170 (6.69)*</p> <p>80 (3.15)</p> <p>50 (1.97) 18.5 (0.73)</p> <p>6 (0.24)</p> <p>Abb. 20: Engineering unit mm (in)</p> <p>A0016488</p> | <p>A</p> <p>B</p> <p>1</p> <p>1</p> <p>1</p> <p>20 (0.79)* 160 (6.30)*</p> <p>70 (2.76)</p> <p>50 (1.97)</p> <p>10 (0.39)</p> <p>8 (0.31)</p> <p>Abb. 21: Engineering unit mm (in)</p> <p>A0016489</p> |
| <p>A = Termination of the cables B = Termination of the fine-wire cores with ferrules 1 = Red ferrules, ϕ 1.0 mm (0.04 in) 2 = White ferrules, ϕ 0.5mm (0.02 in) * = Stripping only for reinforced cables</p> | |

7.1.5 Preparing the measuring device

- Remove any dummy plugs.

Caution!

Poor sealing in the housing can affect the operational reliability of the measuring device. Use suitable cable glands that correspond to the degree of protection.

If the measuring device is supplied without cable glands, provide appropriate cable glands for the connecting cable that comply with IP protection requirements.

- If the measuring device is supplied with cable glands, observe the cable specifications.

Cable entry

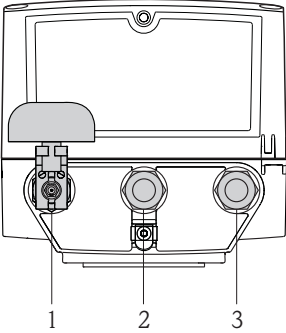
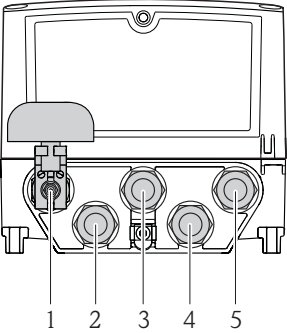
| Compact version | Remote version |
|--|--|
|  |  |
| <p>Fig. 22: Cable entries for the compact version</p> <p>A0016457</p> <ul style="list-style-type: none"> 1 Connection terminal for GSM antenna (optional) 2 External power supply (optional) 3 Inputs/outputs | <p>Fig. 23: Cable entries for the remote version</p> <p>A0016458</p> <ul style="list-style-type: none"> 1 Connection terminal for GSM antenna (optional) 2 External power supply (optional) 3 Inputs/outputs 4 Coil current cable 5 Electrode cable |

7.2 Connecting the measuring device

 Warning!

■ Risk of electric shock!

Switch off the power supply before opening the device. Do not install or wire the device while it is energized. Failure to comply with this precaution can result in irreparable damage to the electronics.

■ Risk of electric shock!

Connect the protective conductor to the ground terminal on the housing before the power supply is applied (not necessary if the power supply is galvanically isolated).

■ Compare the specifications on the nameplate with the local voltage supply and frequency. Also comply with national regulations governing the installation of electrical equipment.

Note! **Incorrect connection work can reduce electrical safety!**

- Connection work must only be performed by properly trained specialists.
- Observe national regulations governing the installation of electrical equipment.
- Comply with local workplace safety regulations.

7.2.1 Connecting and mounting the GSM/GPRS antennae



Detailed information on connecting the GSM/GPRS antennae:
Operating Instructions for the device on the enclosed CD-ROM.

7.2.2 Connecting the inputs and outputs

- Open the housing cover.
 - Release the four screws with a Phillips head screwdriver.
 - Lift the housing cover slightly and tip it to the left.

Two flexible fasteners secure the housing cover to the housing.
- Push the cable through the cable entry →  32.

To ensure tight sealing, do not remove the sealing ring from the cable entry.
- Strip the cable ends over 6 mm (0.24 in).

In the case of stranded cables, also attach wire end ferrules.
- Connect the cables in accordance with the terminal assignment. When connecting the cable shield to the ground terminal, observe the grounding concept of the facility. Rigid conductors or flexible conductors with wire end ferrules can be inserted directly into the terminal without pressing on the wire release.

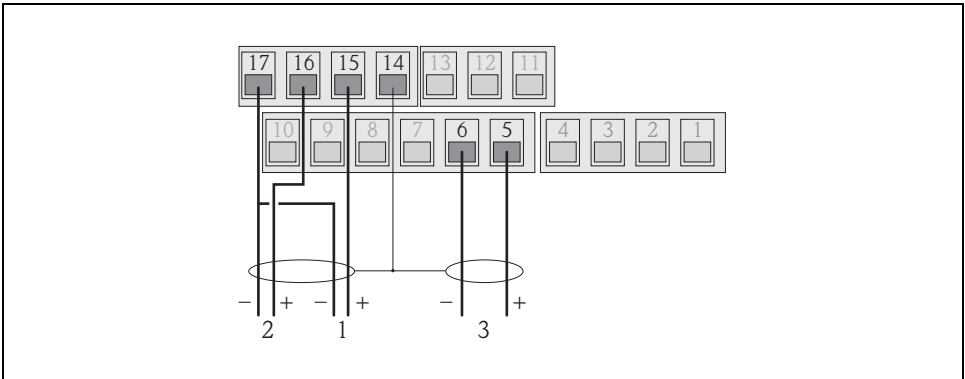

Fig. 24: Connecting the outputs

A0017026

- Output 1
- Output 2
- Input 1



| Inputs | |
|----------|-------------|
| Terminal | Connection |
| 5 | Input 1 (+) |
| 6 | Input 1 (-) |

| Outputs | |
|----------|------------------------|
| Terminal | Connection |
| 14 | Shield, output 1 and 2 |
| 15 | Output 1 (+) |
| 16 | Output 2 (+) |
| 17 | Output 1 and 2 (-) |

- Fit the cable anchorage, firmly tighten the cable glands and secure the housing cover again.

7.2.3 Connecting the connecting cable in the remote version

1. Open the housing cover.
 - Release the four screws with a Phillips head screwdriver.
 - Lift the housing cover slightly and tip it to the left.

Two flexible fasteners secure the housing cover to the housing.
2. Push the cable through the cable entry →  32.
3. Strip the cable ends and fit wire end ferrules →  29.
4. Connect the cables in accordance with the terminal assignment. When connecting the cable shield to the ground terminal, observe the grounding concept of the facility.

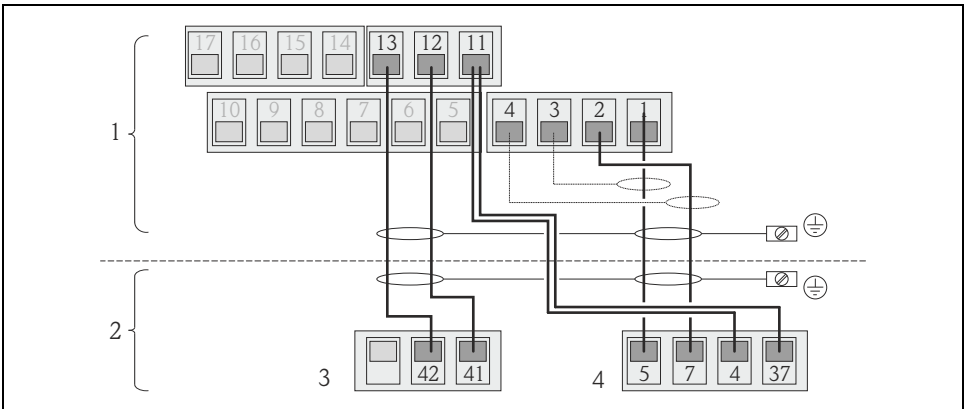

Fig. 25: Connecting the remote version

A0017027

- 1 Transmitter terminals
- 2 Sensor terminals
- 3 Coil current cable
- 4 Electrode cable

| Sensor | |
|----------|--|
| Terminal | Connection |
| 5 | Electrode E1 (brown) |
| 7 | Electrode E2 (white) |
| 4 | Reference electrode, Terminals bridged (green) |
| 37 | |
| 41 | Coil current cable B2 (black) |
| 42 | Coil current cable B1 (black) |

| Transmitter | |
|-------------|-------------------------------|
| Terminal | Connection |
| 1 | Electrode E1 (brown) |
| 2 | Electrode E2 (white) |
| 3 | Shield, electrode E1 (brown) |
| 4 | Shield, electrode E2 (white) |
| 11 | Reference electrode (green) |
| 12 | Coil current cable B2 (black) |
| 13 | Coil current cable B1 (black) |

5. Fit the cable anchorage, firmly tighten the cable glands and secure the housing cover again.

7.3 Connecting the external power supply (optional)

7.3.1 Preparing the connection

It is possible to power the measuring device directly via an external power supply. In addition, batteries are to be used as a backup if the power supply fails and to operate the GSM/GPRS module.

Possible combinations:

| Ordered feature "Power supply" | Power supply | Number of batteries |
|-----------------------------------|----------------------------------|---|
| 5W8B**.*j***** | 100 to 240 V AC 12 to 60 V DC | 1 backup battery |
| 5W8B**.*K***** | 100 to 240 V AC 12 to 60 V DC | 1 backup battery 3 batteries for GSM/GPRS module |

If the measuring device is powered via an external power supply, energy from the batteries is not used. In such instances, the measuring device can work with maximum measured value acquisition cycles (Prof./ MPROF parameter).

To ensure the device continues measuring if the external power supply fails, a battery is used as the backup power supply at the B1 terminal → 38.

The external power supply only supports measuring operation. Additional batteries must be inserted at the B3 terminal for communication via the GSM/GPRS modem → 38.

 The batteries are **not** charged if an external power supply is used. The current state of charge of the batteries can be read on the onsite display or in the BATTs parameter.

7.3.2 Measuring device requirements

- Integrate the measuring system into the potential equalization system → 42.
- The power supply line must be equipped with an external protection for overload current (fuse or automatic circuit breaker).
- The measuring device must have a suitably labeled and easy-to-reach ON/OFF switch.

7.3.3 Power supply and power supply unit requirements

- The power supply must be within the range indicated on the nameplate.
- Take the cable specification of the connecting cable into consideration.
- Take the connecting cable requirements into consideration.

7.3.4 Connecting the external power supply



Different production steps are required to commission the measuring device and must be followed in a set order. Before performing a specific production step, check whether all the previous steps have been completed accordingly → 52.

1. Open the housing cover.
 - Release the four screws with a Phillips head screwdriver.
 - Lift the housing cover slightly and tip it to the left. Two flexible fasteners secure the housing cover to the housing.
2. Fold up the protective cover.
3. Push the cable through the cable entry → 32.
To ensure tight sealing, do not remove the sealing ring from the cable entry.
4. Strip the cable ends over 6 mm (0.24 in).
In the case of stranded cables, also attach wire end ferrules.
5. Connect the cables in accordance with the terminal assignment. When connecting the cable shield to the ground terminal, observe the grounding concept of the facility.

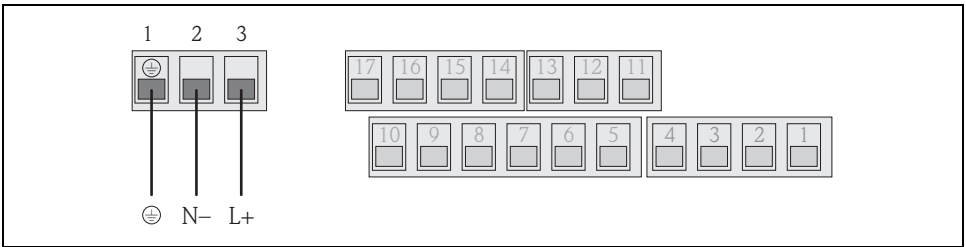

Fig. 26: Connecting the external power supply (optional)

A001702B

| External power supply | |
|-----------------------|-------------------|
| Terminal | Connection |
| 1 | Protective ground |
| 2 | N - |
| 3 | L + |

6. Fold down the protective cover.
7. Fit the cable anchorage and firmly tighten the cable glands.
8. Secure the housing cover.
 - Fix the housing cover on the housing.
 - Tighten the four screws with a Phillips head screwdriver.

7.4 Inserting and connecting the batteries

7.4.1 Overview of battery arrangement options

Three battery terminals are available in the measuring device. These terminals are assigned different uses depending on the number and arrangement of the batteries.

B1 and B2 are the terminals for power supply to the measuring device, B3 is the terminal for the GSM/GPRS modem.

The measuring device is initially powered by the batteries in terminal B2. If the voltage supplied by these batteries becomes too low, the measuring device issues a message and switches automatically to the battery in terminal B1.

If power is supplied to the measuring device externally and the power supply fails, the battery in terminal B1 acts as a backup power supply.

The GSM/GPRS modem is always powered by the battery in terminal B3. This is also the case if the measuring device uses an external power supply.

 The batteries are **not** charged if an external power supply is used. The current state of charge of the batteries can be read on the onsite display or in the BATTs parameter.

Possible configurations

Configuration 1

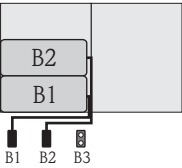
| Configuration of batteries | Connectors | Number of batteries | Battery usage |
|---|---|---------------------|--|
|  <p>A0017127</p> | B 1 | 1 | Backup power supply for the measuring device |
| | B 2 | 1 | Power supply for the measuring device |
| | B 3 | - | Power supply for the GSM/GPRS modem |
| | "Power Supply" order feature: 5W8B**_*** F0 ***** Note! Not permitted in custody transfer! | | |

Configuration 2

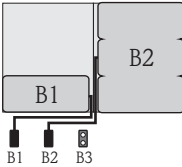
| Configuration of batteries | Connectors | Number of batteries | Battery usage |
|--|--|---------------------|--|
|  <p>A0017128</p> | B 1 | 1 | Backup power supply for the measuring device |
| | B 2 | 3 | Power supply for the measuring device |
| | B 3 | - | Power supply for the GSM/GPRS modem |
| | "Power Supply" order feature: 5W8B**_*** G0 ***** | | |

Configuration 3

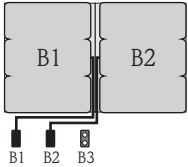
| Configuration of batteries | Connectors | Number of batteries | Battery usage |
|---|--|---------------------|--|
|  <p style="text-align: center;">A0017129</p> | B 1 | 3 | Backup power supply for the measuring device |
| | B 2 | 3 | Power supply for the measuring device |
| | B 3 | - | Power supply for the GSM/GPRS modem |
| | "Power Supply" order feature: 5W8B**_*** HO ***** | | |

Configuration 4

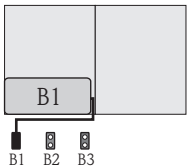
| Configuration of batteries | Connectors | Number of batteries | Battery usage |
|---|-----------------------------------|---------------------|--|
|  <p style="text-align: center;">A0017130</p> | B 1 | 1 | Backup power supply for the measuring device |
| | B 2 | - | Power supply for the measuring device |
| | B 3 | - | Power supply for the GSM/GPRS modem |
| | Powered via external power supply | | Power supply for the measuring device |
| "Power Supply" order feature: 5W8B**_*** JO ***** | | | |

Configuration 5

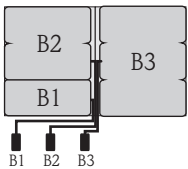
| Configuration of batteries | Connectors | Number of batteries | Battery usage |
|--|--|---------------------|--|
|  <p style="text-align: center;">A0017131</p> | B 1 | 1 | Backup power supply for the measuring device |
| | B 2 | 2 | Power supply for the measuring device |
| | B 3 | 3 | Power supply for the GSM/GPRS modem |
| | "Power Supply" order feature: 5W8B**_*** HP ***** | | |

Configuration 6

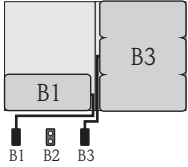
| Configuration of batteries | Connectors | Number of batteries | Battery usage |
|---|-----------------------------------|---------------------|--|
|  <p style="text-align: center;">A0017132</p> | B 1 | 1 | Backup power supply for the measuring device |
| | B 2 | - | Power supply for the measuring device |
| | B 3 | 3 | Power supply for the GSM/GPRS modem |
| | Powered via external power supply | | Power supply for the measuring device |
| "Power Supply" order feature: 5W8B**_*** KP ***** | | | |

7.4.2 Inserting and connecting the batteries

 **Warning!**
Risk of electric shock! Switch off the power supply before opening the device.

 **Caution!**
Can damage the electronic of the device!
Only use batteries provided by Endress+Hauser.

1. Open the housing cover.
 - Release the four screws with a Phillips head screwdriver.
 - Lift the housing cover slightly and tip it to the left.
Two flexible fasteners secure the housing cover to the housing.
2. Remove the battery cover.
 - Release the securing screw with a Phillips head screwdriver.
 - Turn the battery cover in a slightly clockwise direction to remove it (two guides which hold the battery cover in position are located on the right-hand side).
3. Insert the batteries.

Place the batteries into the compartment. In doing so, route the battery cables in the direction of the cable inlet in the battery cover →  28.

 If not all the batteries are inserted, the partition plate can be used to prevent any inserted batteries from becoming dislodged.

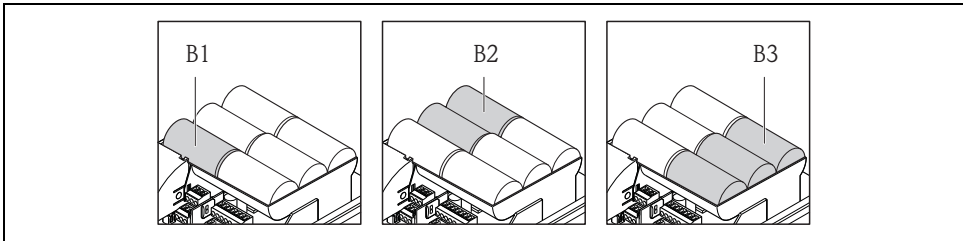





Fig. 27: Example of a battery arrangement (configuration 5)

A0016648

- B1* Battery connection to back up the power supply for the measuring device
B2 Battery connection to power the measuring device
B3 Battery connection to power the GSM/GPRS module

4. Connect the batteries.
 - Insert the battery cables into the appropriate receptacle →  28.
5. Set the DIP switches →  28.
The following options are available:
 - Set the DIP switch to ON to switch on the battery power supply.
If battery power supply is switched on, the red CPU LED flashes →  54 and the startup sequence appears on the onsite display →  53.
 - Set the DIP switch to OFF to switch off the battery power supply.

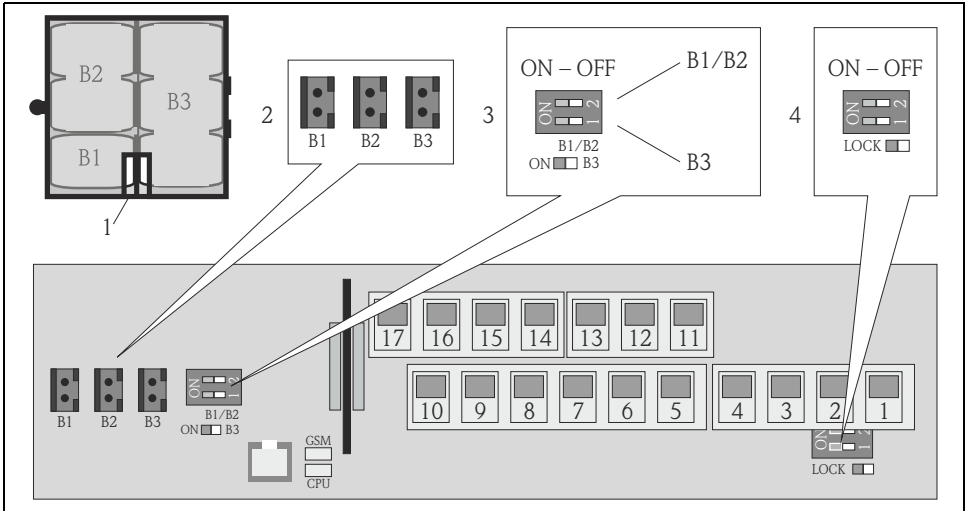



Fig. 28: Connecting the batteries, switching on the battery power supply

A0017025

- 1 Cable inlet in the battery cover
 - 2 Receptacles for terminals B1 and terminals B2 and B3
 - 3 DIP switch (ON/OFF) for switching the batteries on and off:
 - Switch 1: terminals B3
 - Switch 2: terminals B1 and B2
 - 4 DIP switch (ON/OFF) to disable the controls of the local display
6. Secure the battery cover.
 - Route the battery cables in the direction of the cable inlet in the battery cover →  28.
 - Fit the battery cover in place. In doing so, position the guides into the slots in the battery cover.
 - Tighten the securing screw with a Phillips head screwdriver.
 - Fold down the protective cover for the external power supply.
 7. Secure the housing cover.
 - Fix the housing cover on the housing.
 - Tighten the four screws with a Phillips head screwdriver.

7.5 Potential equalization

 Warning!

Integrate the measuring system into the potential equalization system .

7.5.1 Potential equalization requirements

Please consider the following to ensure correct measurement:

- The fluid and sensor have the same electrical potential
- Company-internal grounding concepts
- Material and grounding of the pipes

7.5.2 Connection examples for potential equalization

Connection example in standard situations

Metal, grounded pipe

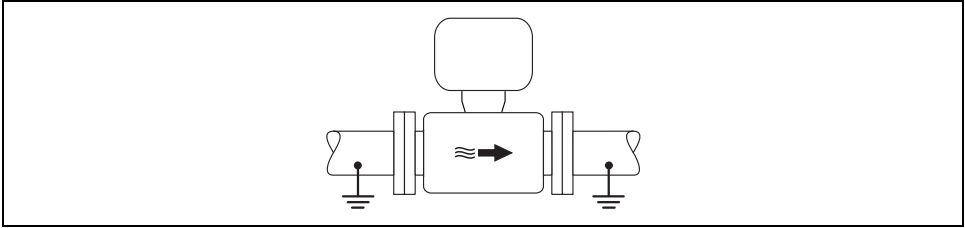

A0016315

Abb. 29: Potential equalization via Measuring tube

Connection example in special situations

Plastic pipe or pipe with insulating lining

This connection method is also to be used when:

- Potential equalization is not customary
- Equalizing currents are present

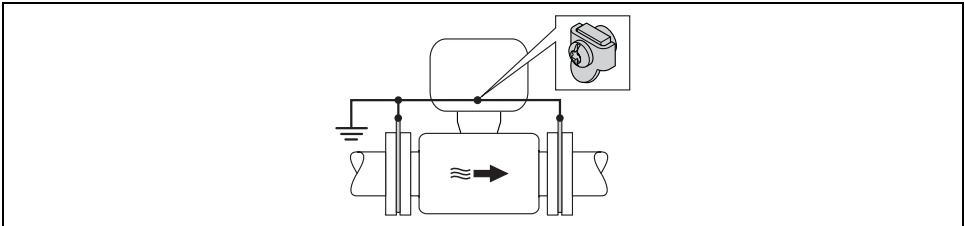

A0016318

Abb. 30: Potential equalization via ground terminal and ground disk

For mounting consider the following:

The ground disks have to be connected to the ground terminal via a ground cable and to the ground potential. Ground cable = copper wire, at least 6 mm^2 (0.0093 in^2).



For remote version: The ground terminal in the example refers to the sensor and **not** to the transmitter.



The required ground cable can be ordered from Endress+Hauser.

Metal, ungrounded pipe without liner

This connection method is also to be used when:

- Potential equalization is not customary
- Equalizing currents are present



Abb. 31: Potential equalization via ground terminal and pipe flanges

A0022704

For mounting consider the following:

- Connect both sensor flanges to the particular pipe flange via a ground cable and ground them. Ground cable = copper wire, at least 6 mm^2 (0.0093 in^2).
- Connect the transmitter or sensor connection housing, as applicable, to ground potential by means of the ground terminal provided for the purpose. For mounting the ground cable: Mount the ground cable directly on the conductive flange coating of the sensor with the flange screws.

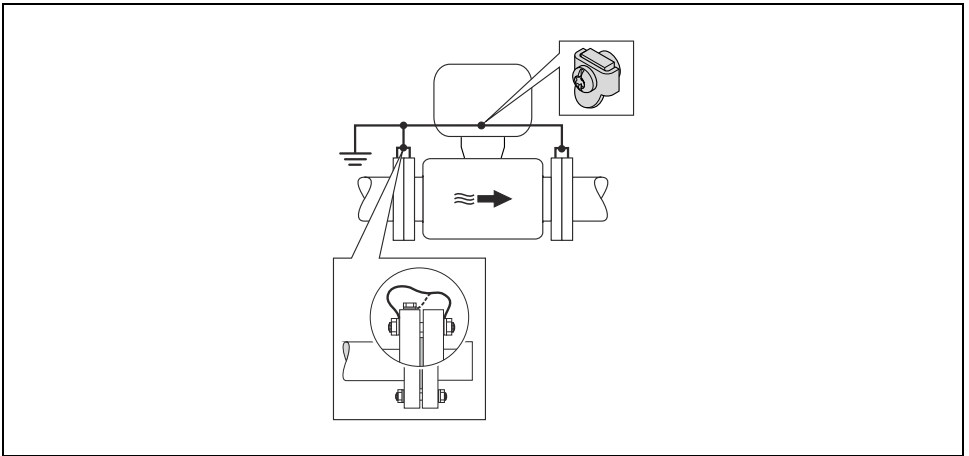

For remote version: The ground terminal in the example refers to the sensor and **not** to the transmitter.



The required ground cable can be ordered from Endress+Hauser.

Pipe with cathodic protection

This connection method only take place, if both of the following requirements are fulfilled:

- Metal pipe without liner or pipe with electrically conductive liner
- Cathodic protection is integrated in the operator protection



Abb. 32: Potential equalization and cathodic protection

A0016319

- 1 Isolating transformer power supply
- 2 Electrically isolated to pipe
- 3 Capacitor

1. Connect the measuring device potential-free compared to protective earth to the power supply.
2. Install the measuring device electrically isolated in the pipe.
3. Connect the two flanges of the pipe with a ground cable.
Ground cable = copper wire, at least 6 mm² (0.0093 in²).
4. By connecting the shielding of the signal cables a capacitor has to be used.

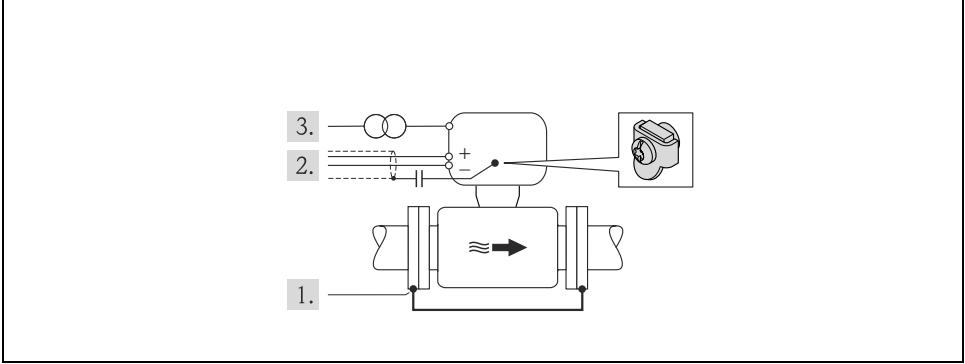
i For remote version: The ground terminal in the example refers to the sensor and **not** to the transmitter.

i The required ground cable can be ordered from Endress+Hauser.



7.6 Guaranteeing the degree of protection of the measuring device

 Caution!

Do not loosen the threaded fasteners of the sensor housing, as otherwise the degree of protection guaranteed by Endress+Hauser no longer applies.

To guarantee the degree of protection of the measuring device.

Perform the following steps after electrical connection:

- Check that the housing seals of the connection and electronics compartment are clean and fitted correctly. Dry, clean or replace the seals if necessary.
- Tighten all housing screws and screw covers.
- Firmly tighten the cable glands.
- To ensure that moisture does not enter the cable entry, route the cable so that it loops down before the cable entry ("water trap") →  33.
- Insert dummy plugs into unused cable entries.
- Notes on measuring devices with IP68 option →  16.

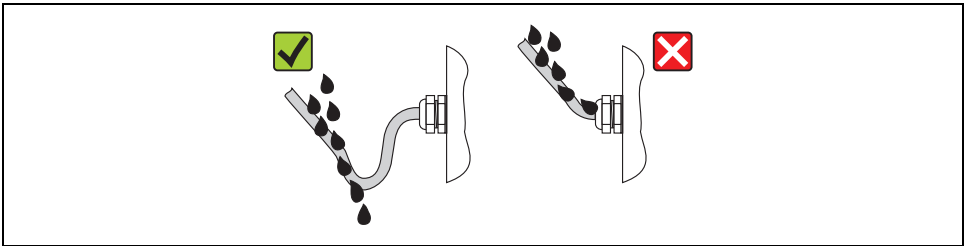

Fig. 33: Cable looped down before the cable entry

A0013960

7.7 Post-connection check

| | |
|--|--------------------------|
| Is the measuring device undamaged (visual inspection)? | <input type="checkbox"/> |
| Do the cables used comply with the requirements? | <input type="checkbox"/> |
| Do the cables have adequate strain relief? | <input type="checkbox"/> |
| Are all cable glands installed, firmly tightened and correctly sealed? Cables looped as "water traps"? | <input type="checkbox"/> |
| Does the supply voltage match the specifications on the transmitter nameplate? | <input type="checkbox"/> |
| Is the ribbon cable for the display and operating module correctly routed in the housing? | <input type="checkbox"/> |
| Is the terminal assignment correct? | <input type="checkbox"/> |
| Have the batteries been inserted and secured correctly? | <input type="checkbox"/> |
| Is the DIP switch set to the correct setting? | <input type="checkbox"/> |
| If power is supplied, is the measuring device ready for operation (the red LED is flashing) and does information appear on the display if an operating key is pressed for >1 second? | <input type="checkbox"/> |
| Are all housing covers installed and tightened with the correct tightening torque? | <input type="checkbox"/> |

8 Operating options

8.1 Overview of operating options

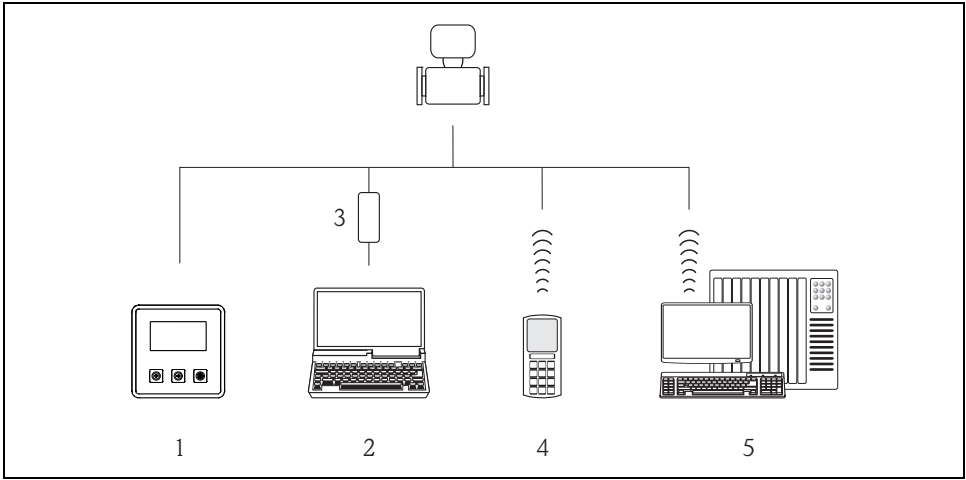

A0016602

Fig. 34: Overview of operating options

- 1 Local operation of the measuring device
- 2 Computer with Config 5800 operating tool
- 3 FXA 291 service interface (connected to computer via USB port and to measuring device via service interface)
- 4 Cell phone (wireless via SMS)
- 5 Computer (wireless via mail)

8.2 Structure and function of the operating menu

8.2.1 Structure of the operating menu

- The measuring device has a main menu with different parameter groups. These parameter groups correspond to different applications or areas of the measuring device.
- The parameter groups contain the various parameters that belong to the individual applications or areas of the measuring device.
- The desired setting or option for the measuring device configuration is made in the individual parameters.
- Some parameters cannot be modified since they are only used to display values or information, or can only be modified by users with a higher access authorization level → 51.

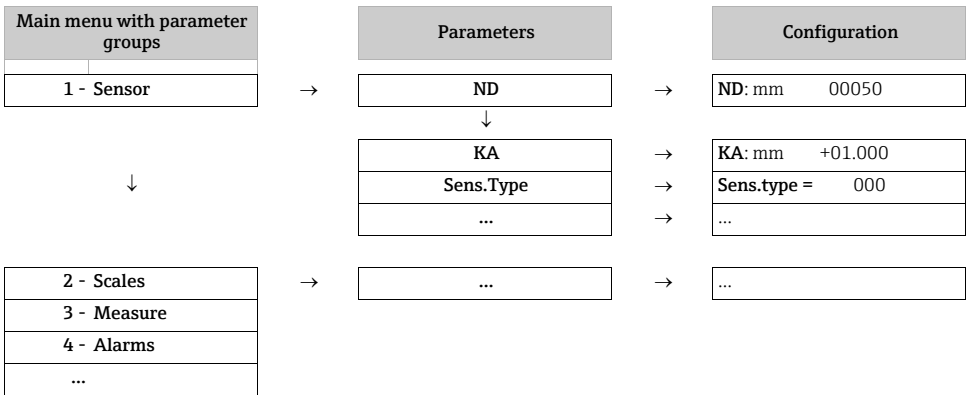

8.2.2 Operating concept

The parameters in the measuring device have different access levels. The parameters can be modified by all users or just by certain user groups depending on the associated access level. Some parameters can only be accessed via the Config 5800 operating tool.

- The parameters can be accessed via:
 - The local operation of the measuring device → 48
 - The Config 5800 operating tool → 51
- The majority of the parameters can be configured without any restrictions (up to Level 2). Special service-specific and device-specific parameters (Level 3 and above) can only be modified by Endress+Hauser Service staff.
- Custody transfer (optional):
 After putting the device into circulation or after sealing the device, operation via the onsite display, via the Config 5800 software operating tool or via GSM/GPRS is only possible to a limited extent.

8.3 Access to the operating menu via the onsite display

8.3.1 Operating elements and display area

The measuring device has three operating elements and one display area.

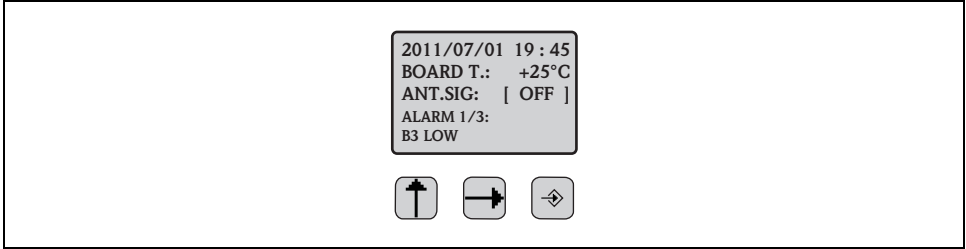





Fig. 35: Operating elements and display area of the measuring device

A0016977



Operating elements

| Key | Operation | Meaning |
|--|----------------------------|--|
|  | Press briefly (<1 second) | <ul style="list-style-type: none"> ▪ Scroll up through the parameters ▪ Scroll up through the options ▪ Increase the numerical values ▪ If several alarms are active: scroll up through the alarm list |
| | Press and hold (>1 second) | <ul style="list-style-type: none"> ▪ Scroll down through the parameters ▪ Scroll down through the options ▪ Decrease the numerical values ▪ If several alarms are active: scroll down through the alarm list |
|  | Press briefly (<1 second) | <ul style="list-style-type: none"> ▪ Change the display area or the display values ▪ Move the cursor to the right ▪ Scroll down through the parameters |
| | Press and hold (>1 second) | <ul style="list-style-type: none"> ▪ Change the display area or the display values ▪ Move the cursor to the left ▪ Scroll up through the parameters |
|  | Press briefly (<1 second) | <ul style="list-style-type: none"> ▪ Select the menu ▪ Select the parameter ▪ Confirm the entry, selection |
| | Press and hold (>1 second) | <ul style="list-style-type: none"> ▪ Exit the current menu ▪ Return to the main menu ▪ Return to the display ▪ Switch display on/off |

Display area

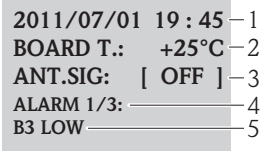
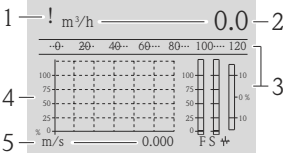
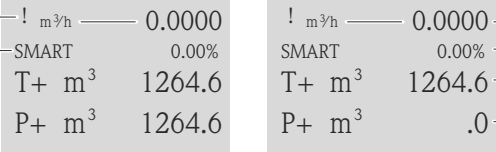
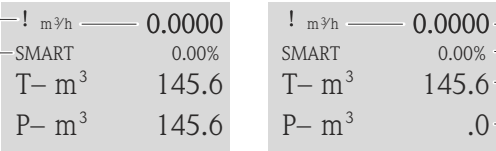
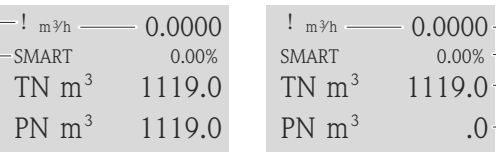

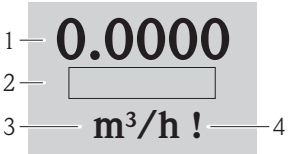
Several measured value and status views are available in the display area. Users can switch between the individual views using the T key →  50.

| Views | Meaning |
|--|---|
|  <p style="text-align: right; margin-right: 10px;">A0016981</p> | <ol style="list-style-type: none"> 1. Date and time 2. Temperature of electronics board 3. Status of antenna signal 4. Number of alarms (scroll through the alarm list via the V operating key) 5. Description of displayed alarm |
|  <p style="text-align: right; margin-right: 10px;">A0016982</p> | <ol style="list-style-type: none"> 1. Alarm status 2. Flow value with numeric representation (incl. unit) 3. Flow value with line and bar graph representation 4. Flow value (0 to 100 %) tracked as chart 5. Flow velocity including unit <p>Note! F (fast) + S (slow) = Filter</p> |
|  <p style="text-align: right; margin-right: 10px;">A0020991</p> | <ol style="list-style-type: none"> 1. Alarm status 2. Flow value with numeric representation (incl. unit) 3. Profile of measured value acquisition 4. Full scale value in % 5. Totalizer, positive (incl. unit)¹⁾ 6. Totalizer, positive (incl. unit)¹⁾ |
|  <p style="text-align: right; margin-right: 10px;">A0020992</p> | <ol style="list-style-type: none"> 1. Alarm status 2. Flow value with numeric representation (incl. unit) 3. Profile of measured value acquisition 4. Full scale value in % 5. Totalizer, negative (incl. unit)¹⁾ 6. Totalizer, negative (incl. unit)¹⁾ |
|  <p style="text-align: right; margin-right: 10px;">A0020993</p> | <ol style="list-style-type: none"> 1. Alarm status 2. Flow value with numeric representation (incl. unit) 3. Profile of measured value acquisition 4. Full scale value in % 5. Totalizer net (balance) (incl. unit)¹⁾ 6. Totalizer net (balance) (incl. unit)¹⁾ |

| Views | Meaning |
|--|--|
|  <p style="text-align: right;">A0016986</p> | <ol style="list-style-type: none"> 1. Flow value with numeric representation (incl. unit) 2. Bar graph full scale value in % 3. Flow value unit 4. Alarm status |
|  <p style="text-align: right;">A0016987</p> | <ol style="list-style-type: none"> 1. State of charge of battery in terminal B1 2. State of charge of battery in terminal B2 3. State of charge of battery in terminal B3 |

- 1) T+ and P+, T- and P- as well as TN and PN have each the same values. It is e.g. possible to reset P+, P- as well as PN periodically to 0, while the values T+, T- as well as TN are preserved.

8.3.2 Changing the views in the display area

Users can switch between the individual views using the  key →  48.

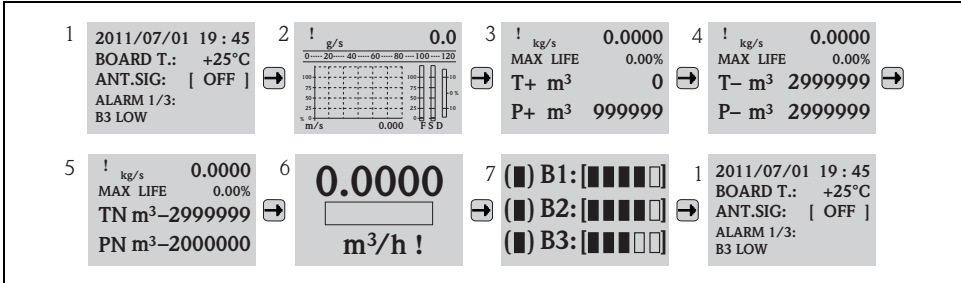







Fig. 36: Changing the views





Locking the view toggle function

1. Select the desired display using the  key.
2. Use the  key to switch to the main menu.
3. Switch to parameter group "8-DISPLAY", go to the "Disp.lock" parameter and select the option "ON".

8.3.3 Changing parameters

1. Press and hold the  key for 2 seconds and then release.
 - ✓ The device leaves the standby mode and the measured value or status display screen appears.
2. Press  once.
 - ✓ The main menu is displayed.

Note! The Quick Start menu is displayed during initial commissioning or if the "Quick start" parameter (QSTME) is set to ON (default value). In such instances, use  to select the "Main menu" option and enter the main menu.

3. Press  to select the desired parameter group.
4. Press  to confirm the selection.
 - ✓ The parameter group is called up.
5. Press  to select the desired parameter.
6. Press  to confirm the selection.
 - ✓ The parameter is displayed.
7. Use  to change the option selected or the value.

Note! In the case of some parameters, it is possible to make several settings within the parameter (example Tot1MU).

8. Press  to confirm the selection.
 - ✓ The option or value selected is accepted.

8.3.4 User roles and related access authorization



Detailed information on user roles and related access authorization
Operating Instructions for the device on the enclosed CD-ROM

8.4 Access to the operating menu via the operating tool

8.4.1 Config 5800 operating tool

Config 5800 is a software operating tool which is used to configure and operate the Promag 800 measuring device. The measuring device does not support any other operating tools.



Detailed information on Config 5800 operating tool:
Operating Instructions for the device on the enclosed CD-ROM

9 Commissioning



9.1 Commissioning with the GSM/GPRS modem





Detailed information on commissioning with the GSM/GPRS modem:
Operating Instructions for the device on the enclosed CD-ROM

9.2 Commissioning without the GSM/GPRS modem

Prerequisites for commissioning the measuring device:

- The measuring device has been installed.
All the criteria of the post-installation check are met →  27.
- Wiring is completed.
Batteries are inserted, external power supply is connected (optional).
All the criteria of the post-connection check are met →  45.

9.2.1 Commissioning the measuring device via local operation

1. Switch on the measuring device:
 - Via the DIP switch if power is supplied by batteries →  41 (→  28).
Then fit the housing cover back on.
 - Via the external power supply switch if power is supplied externally (optional).
2. Configuration of the measuring device via the onsite display →  48.



Detailed information on parameter descriptions:
Operating Instructions for the device on the enclosed CD-ROM

9.2.2 Commissioning the measuring device via the Config 5800 operating tool



Detailed information on commissioning using the Config 5800 operating tool:
Operating Instructions for the device on the enclosed CD-ROM

9.3 Inserting the SIM card

A SIM card must be inserted in the measuring device before it can establish wireless communication.



Detailed information on inserting the SIM card:
Operating Instructions for the device on the enclosed CD-ROM

9.4 Switching on the measuring device

Once the batteries have been inserted, the measuring device is switched on via the DIP switch → 4.1. This applies both to battery-powered operation and for operation with an optional power supply since the device is already powered via the backup battery B1 in this case. Once the device is switched on, press the Enter key for > 1 second, and the measuring device is started.

⚠ Warning!

Only switch on the external power supply (optional) once the post-installation and post-connection checks have been performed successfully for the device.

After a successful startup, the onsite display switches automatically from the startup display screens to the measured value display.

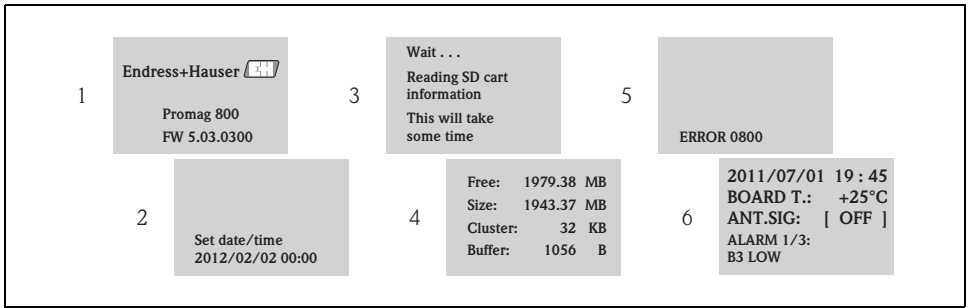

Fig. 37: Example: display screens when the measuring device is started

A0017030

- 1 Name of measuring device, firmware version
- 2 Date and time entered via the operating keys (entry also possible at a later date) → 4.8
- 3 Reads the information from the SD card
- 4 Displays the memory capacity and the current settings of the SD card
- 5 Displays any pending errors (if present)
- 6 Displays general information

9.4.1 Meaning of the LEDs

The measuring device is fitted with two light emitting diodes (LEDs) on the electronics board. Once the measuring device has been switched on the LEDs indicate different states for the measuring device and the GMS module.

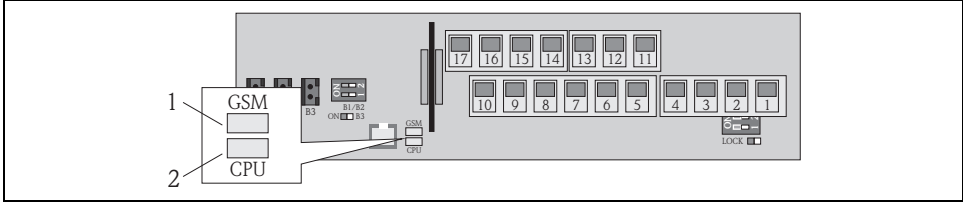

Fig. 38: Light emitting diodes on the electronics board

A0017024

- 1 LED (blue) for GSM module, is lit when communication is active
- 2 LED (red) for CPU

| LED GSM module (blue) | | LED CPU (red) | |
|-----------------------|---|-----------------------|---|
| State | Meaning | State | Meaning |
| Off | The GSM module is not switched on, in the standby mode or is not connected to a network. | Off | Not switched on or no power supply available. |
| Lit | GSM module is trying to log into the network. | | |
| Flashing slowly | GSM module is logged into the network and is waiting for commands. | Flashing | The LED flashes for every measured value acquisition. |
| Flashing quickly | The GSM module is sending or receiving a file (SMS or e-mail), data transmission in progress. | Flashing approx. 1 Hz | One or more alarms are active. |

9.5 Establishing wireless communication



Detailed information on establishing wireless communication:
Operating Instructions for the device on the enclosed CD-ROM

9.6 Troubleshooting



Detailed information on troubleshooting:
Operating Instructions for the device on the enclosed CD-ROM

www.addresses.endress.com
