

Operating Instructions

Proline Promag W 800

Electromagnetic flowmeter

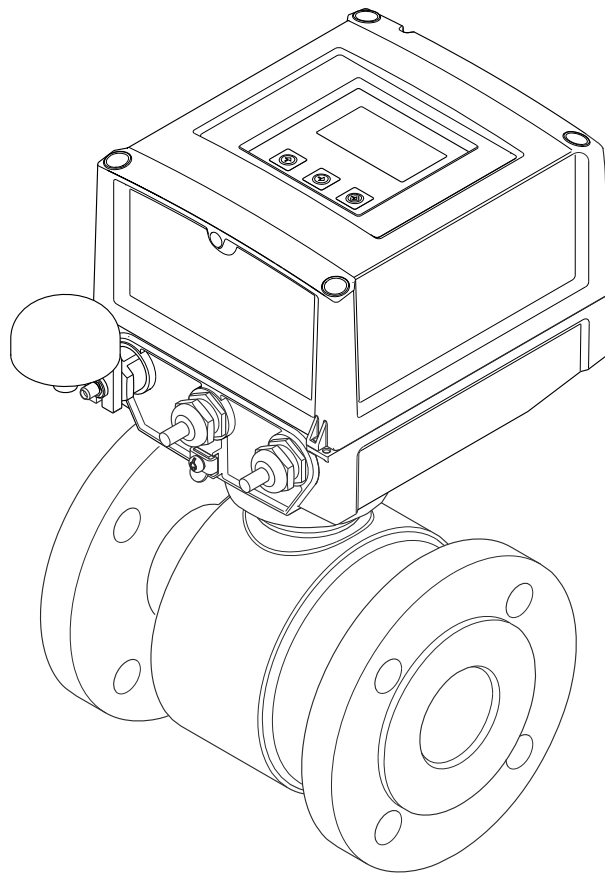

- Make sure the document is stored in a safe place such that it is always available when working on or with the device.
- To avoid danger to individuals or the facility, read the "Basic safety instructions" section carefully, as well as all other safety instructions in the document that are specific to working procedures.
- The manufacturer reserves the right to modify technical data without prior notice. Your Endress+Hauser Sales Center will supply you with current information and updates to these Instructions.

Table of contents

1	Document information	5	9.2	Commissioning without the GSM/GPRS modem	67
1.1	Document function	5	9.3	Inserting the SIM card	68
1.2	Symbols used	5	9.4	Switching on the measuring device	69
1.3	Documentation	7	9.5	Establishing wireless communication	70
2	Basic safety instructions	8	9.6	Data logger file with process data	85
2.1	Personnel requirements	8	9.7	Setting the operating language	87
2.2	Designated use	8	9.8	Managing the configuration	87
2.3	Occupational safety	9	9.9	Simulation	87
2.4	Operational safety	9	9.10	Protecting settings from unauthorized access ..	89
2.5	Product safety	10	10	Operation	90
3	Product description	11	10.1	Changing the operating language	90
3.1	Product structure	11	10.2	Switching the display	90
4	Incoming acceptance and product identification	12	10.3	Reading measured values	90
4.1	Incoming acceptance	12	10.4	Performing a totalizer reset	90
4.2	Product identification	13	10.5	Battery power consumption	91
5	Storage, transport and disposal of packaging	16	11	Custody transfer (optional)	93
5.1	Storage conditions	16	11.1	Terminology	93
5.2	Transporting the product	16	11.2	Permanent flowrate characteristics	94
5.3	Disposing of the packaging	17	11.3	Device as-delivered state	94
6	Installation	18	11.4	Custody transfer measurement (European Measuring Instruments Directive 2004/22/EC, Annex MI-001)	94
6.1	Installation conditions	18	11.5	Custody transfer measurement (national approval, OIML R49)	95
6.2	Installing the measuring device	25	11.6	Reapproval	96
6.3	Post-installation check	30	12	Diagnostics and troubleshooting	97
7	Electrical connection	31	12.1	Diagnostic event on the onsite display	97
7.1	Preparing the measuring device	31	12.2	Diagnostic event in the operating tool	100
7.2	Connecting the measuring device	34	12.3	Communication diagnostic event	101
7.3	Inserting and connecting the batteries	40	12.4	Overview of diagnostic events	101
7.4	Potential equalization	43	13	Repair	103
7.5	Guaranteeing the degree of protection of the measuring device	46	13.1	General notes	103
7.6	Post-connection check	46	13.2	Spare parts	103
8	Operating options	47	13.3	Endress+Hauser services	104
8.1	Overview of operating options	47	14	Maintenance	105
8.2	Structure and function of the operating menu ..	47	14.1	Maintenance work	105
8.3	Access to the operating menu via the onsite display	48	14.2	Measuring and testing equipment	105
8.4	Access to the operating menu via the operating tool	51	14.3	Endress+Hauser services	105
9	Commissioning	67	15	Accessories	106
9.1	Commissioning with the GSM/GPRS modem ..	67	16	Return	107
			17	Disposal	108
			17.1	Disassembling the measuring device	108
			17.2	Disposing of the measuring device	108

17.3	Disposing of the batteries	108
18	Technical data.....	109
18.1	Technical data at a glance	109
19	Appendix.....	124
19.1	Description of device parameters	124
19.2	Access to parameters	128
19.3	Quick Start menu	129
19.4	Parameter descriptions	130
19.5	Information on configuring the measuring device	165
19.6	Operating commands of the Config5800 operating tool	172
19.7	Abbreviations	178
19.8	Factory setting	179
	Index.....	181

1 Document information



1.1 Document function

These Operating Instructions contain all the information that is required in the various phases of the life cycle of the device: from product identification, incoming acceptance and storage, to mounting, connection, operation and commissioning through to troubleshooting, maintenance and disposal.





The document also provides a detailed explanation of each individual parameter. It contains all the parameters required for operation and commissioning. The parameter descriptions are aimed at individuals who bear responsibility for the device during normal measuring operation or who must make settings at the device for maintenance and troubleshooting purposes.

1.2 Symbols used





1.2.1 Safety symbols

Symbol	Device particularities and document content
 Caution!	"Caution" indicates an action or procedure which, if not performed correctly, can result in incorrect operation or destruction of the device. Comply strictly with the instructions.
 Warning!	"Warning" indicates an action or procedure which, if not performed correctly, can result in injury or a safety hazard. Comply strictly with the instructions and proceed with care.
 Note!	"Note" indicates an action or procedure which, if not performed correctly, can have an indirect effect on operation or trigger an unexpected response on the part of the device.







1.2.2 Electrical symbols

Symbol	Meaning
 A0011197	Direct current A terminal at which DC voltage is present or through which direct current flows.
 A0011198	Alternating current A terminal at which alternating voltage (sinusoidal) is present or through which alternating current flows.
 A0011200	Ground connection A grounded terminal which, from the viewpoint of the user, is grounded via a grounding system.
 A0011199	Protective ground connection A terminal which must be connected to ground prior to establishing any other connections.
 A0011201	Equipotential connection A connection that must be connected to the plant grounding system: This may be a potential equalization line or a star grounding system depending on national or company codes of practice.



1.2.3 Tool symbols

Symbol	Meaning
 A0013442	Torx screwdriver
 A0011220	Slotted screwdriver
 A0011219	Phillips head screwdriver
 A0011221	Allen screw
 A0011222	Open-ended wrench

1.2.4 Symbols for types of information

Symbol	Meaning
 A0011182	Permitted Indicates procedures, processes or actions that are permitted.
 A0011183	Preferred Indicates procedures, processes or actions that are preferred.
 A0011200	Forbidden Indicates procedures, processes or actions that are forbidden.
 A0011193	Tip Indicates additional information.
 A0011194	Reference to documentation Refers to the corresponding device documentation.
 A0011195	Reference to page Refers to the corresponding page number.
1., 2., 3. ...	Series of steps
✓	Result of a sequence of actions
 A0013562	Help in the event of a problem

1.2.5 Symbols for graphics

Symbol	Meaning
1, 2, 3 ...	Item numbers
A, B, C etc.	Views
A-A, B-B, C-C etc.	Item numbers
 <small>A0013441</small>	Flow direction
 <small>A0011187</small>	Hazardous area Indicates the hazardous area.
 <small>A0011187</small>	Safe area (non-hazardous area) Indicates the non-hazardous area.

1.3 Documentation

1.3.1 Standard documentation

Document type	Purpose and content of the document
Technical Information	Planning aid for your device The document contains all the technical data on the device and provides an overview of the accessories and other products that can be ordered for the device.
Brief Operating Instructions	Guides you quickly to the 1st measured value The Brief Operating Instructions contain all the essential information from incoming acceptance to initial commissioning.

-  The document types listed are available:
- On the CD supplied with the device
 - In the Download Area of the Endress+Hauser Internet site:
www.endress.com → Download

1.3.2 Supplementary device-dependent documentation

Always comply strictly with the instructions in the supplementary documentation. The supplementary documentation is an integral part of the device documentation.

Document type	Device particularities and document content
Installation Instructions	Ordered accessory The Installation Instructions contain all the information needed to install the ordered accessory or spare part.

-  The document types listed are available:
In the Download Area of the Endress+Hauser Internet site: www.endress.com → Download

2 Basic safety instructions

2.1 Personnel requirements

The personnel for installation, commissioning, diagnostics and maintenance must fulfill the following requirements:

- Trained, qualified specialists must have a relevant qualification for this specific function and task.
- Are authorized by the plant owner/operator.
- Are familiar with federal/national regulations.
- Before beginning work, the specialist staff must have read and understood the instructions in the Operating Instructions and supplementary documentation as well as in the certificates (depending on the application).
- Follow instructions and comply with conditions.

The operating personnel must fulfill the following requirements:

- Be instructed and authorized according to the requirements of the task by the facility's owner-operator.
- Follow the instructions in these Operating Instructions.

2.2 Designated use

Application and fluids

The measuring device described in this manual is to be used only for measuring the flow rate of conductive liquids in closed pipes.

A minimum conductivity of 50 $\mu\text{S}/\text{cm}$ is required for measuring purposes.

The measuring device is designed to measure the following fluids:

- Drinking water
- Rain water
- Spring water

In compliance with the limit values specified in the "Technical data" section and the general conditions indicated in the manual and supplementary documentation, the measuring device may only be used for the following measurements:

- Measured measured variables: volume flow
- Calculated measured variables: mass flow

To ensure that the measuring device remains in proper operating condition for its service life:

- Only use the measuring device for fluids to which the process-wetted materials are adequately resistant.
- Comply with the limit values in the "Technical data" section.



Note!

As an option, Promag W 800 is tested in accordance with OIML R49 and has an EC type-examination certificate as per Measuring Instruments Directive 2004/22/EC (MID) for service subject to legal metrological control ("custody transfer") for cold water (Annex MI-001).

The permitted fluid temperature in these applications is 0 to +50 °C (+32 to +122 °F).

It is used with a legally controlled totalizer on the local display.

Incorrect use

The manufacturer is not liable for damage resulting from improper or non-designated use. An improper or non-designated use can affect the safety.

Clarification of borderline cases:

- With regard to special fluids and media used for cleaning, Endress+Hauser will be happy to assist in clarifying the corrosion-resistant properties of wetted materials but gives no guarantee or warranty as to the suitability of the materials.

**Residual risks**

Warning!

Due to the power throughput in the electronic components, the outer housing surfaces can heat up by a maximum of 20 K. When hot fluid passes through the measuring tube, the surface temperature of the housing increases. In the case of the sensor, in particular, users should expect temperatures that can be close to the fluid temperature.

Hot fluids can present a burn hazard!

- For elevated fluid temperatures, ensure adequate protection against contact to prevent burns.

2.3 Occupational safety

When working on or with the device:

- Always wear the necessary personal protective equipment as defined in national regulations.

When performing welding work on the pipe:

- Do not ground the welding equipment via the measuring device.

When working with batteries:

- The device is powered by lithium-thionyl chloride high-power batteries. This has implications for occupational safety and device storage.



Warning!

Lithium-thionyl chloride high-power batteries are categorized as Class 9: "Miscellaneous Hazardous Materials". Comply strictly with the hazardous material regulations described in the safety data sheet.

You can request the safety data sheet from your Endress+Hauser Sales Center.

2.4 Operational safety

Risk of injury.

- Only operate the device if it is in a perfect technical condition free from errors and faults.
- The operator is responsible for the trouble-free operation of the device.

Conversions to the device

Unauthorized modifications to the device are not permitted and can lead to unforeseeable dangers:

- If, despite this, modifications are required, consult with Endress+Hauser.

Repair

To ensure operational safety:

- Only perform repair work on the device if this is expressly permitted.
- Comply strictly with national regulations concerning the repair of electrical equipment.
- Only use genuine Endress+Hauser spare parts and accessories.

Hazardous area

To exclude any risks to individuals or the facility when operating the device in the hazardous areas:

- Based on the nameplate, check whether the ordered device is permitted for the intended use in the hazardous area.

2.5 Product safety

This measuring device is designed to meet state-of-the-art safety requirements in accordance with sound engineering practice, has been tested and left the factory in a condition in which it is safe to operate.

It meets the general safety requirements and legal requirements. Furthermore, it complies with the EC directives which are listed in the device-specific EC Declaration of Conformity. Endress+Hauser confirms this by affixing the CE mark to the device.

3 Product description

3.1 Product structure

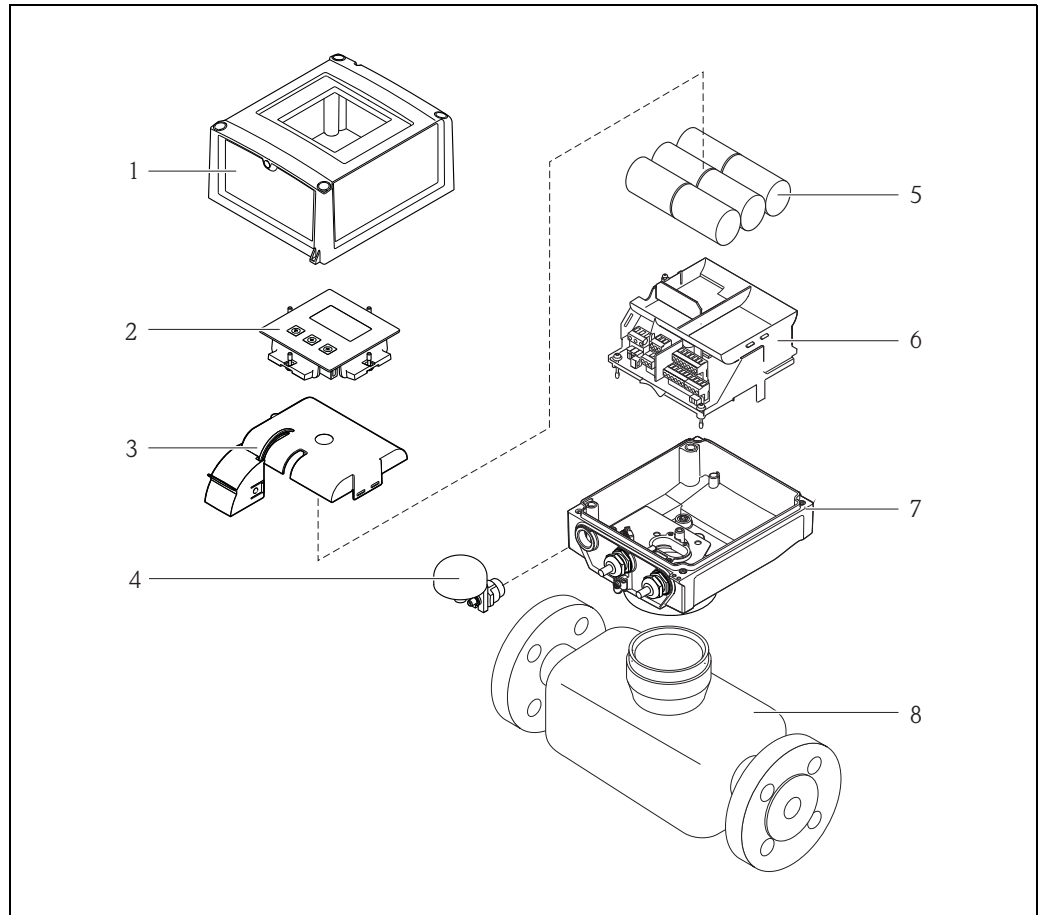

Fig. 1: Primary components of the measuring device

- 1 Transmitter housing cover
- 2 Display and operating module
- 3 Battery cover
- 4 GSM antenna
- 5 Batteries
- 6 Electronics board carrier incl. battery compartment
- 7 Transmitter housing
- 8 Sensor

A0016254

4 Incoming acceptance and product identification

4.1 Incoming acceptance

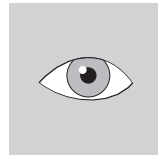

A0013696



1
+
2

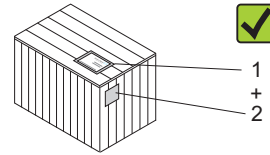

1
+
2

Is the order code in the delivery note (1) identical to the order code on the product sticker (2)?

A0013843

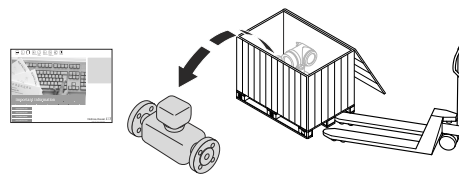

A0013695



Note!

The lithium-thionyl chloride high-power batteries are provided in a separate package. Pay attention to the occupational safety instructions when handling batteries → 9.

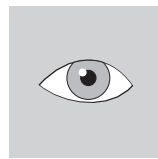

A0013696

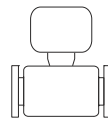

Goods undamaged?

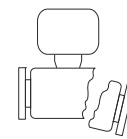

A0013698



Caution!

If batteries are damaged, comply strictly with the hazardous material regulations described in the safety data sheet. You can request the safety data sheet from your Endress+Hauser Sales Center.

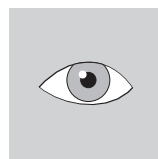

A0013696

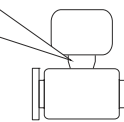
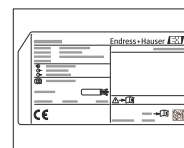

Do the data on the nameplate correspond to the order data on the delivery note?

A0013699

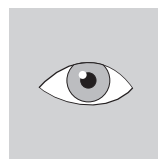

A0013696



CD-ROM available with technical documentation and documents?

A0013697





If you have answered "no" to one of the questions above: Contact your Endress+Hauser Sales Center.

4.2 Product identification

It is possible to identify the measuring device in the following ways:

- Using the nameplate specifications
- Using the order code with a breakdown of the device features on the delivery note
- By entering the serial number on the nameplates into the *W@M Device Viewer* (www.endress.com/deviceviewer): All the information pertaining to the measuring device is displayed.

For an overview of the scope of the Technical Documentation provided, please see:

- The "Additional standard documentation on the device" (→  7) and "Supplementary device-dependent documentation" (→  7) sections.
- The *W@M Device Viewer*: Enter the serial number on the nameplate (www.endress.com/deviceviewer)

4.2.1 Nameplates

Sensor

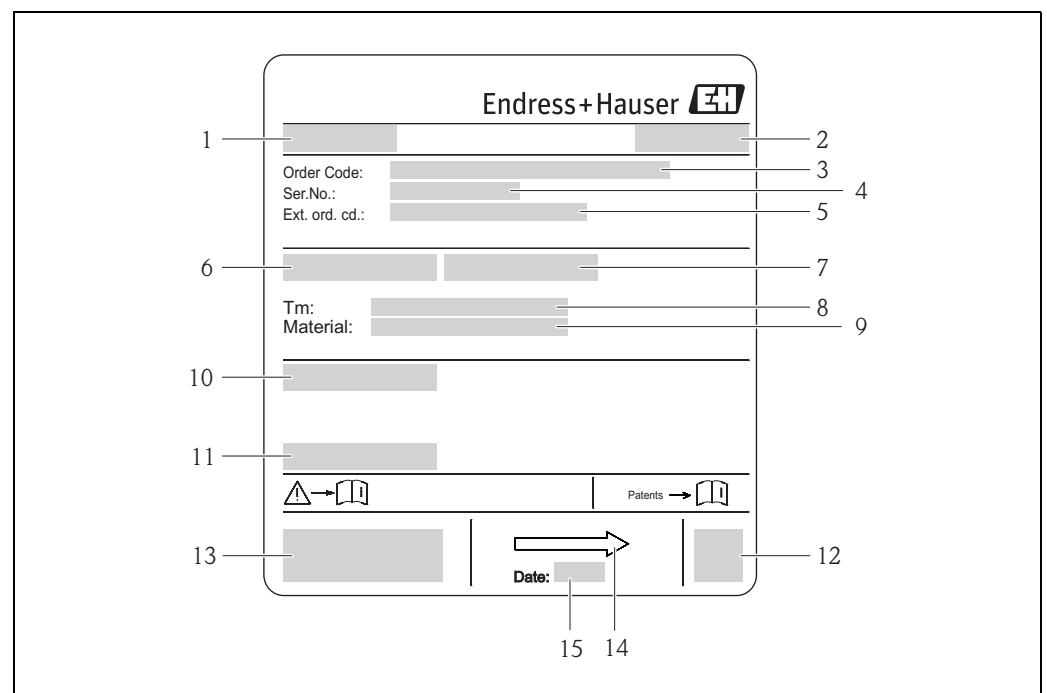

Fig. 2: Example of sensor nameplate

- 1 Name of sensor
- 2 Place of manufacture
- 3 Order code
- 4 Serial number (Ser.No.)
- 5 Extended order code (Ext. ord. co.)
- 6 Nominal diameter of the sensor
- 7 Test pressure of the sensor
- 8 Fluid temperature range
- 9 Measuring tube lining and electrodes material
- 10 Degree of protection: e.g. IP, NEMA
- 11 Permitted ambient temperature (T_a)
- 12 2-D matrix code
- 13 CE mark, C-tick
- 14 Flow direction
- 15 Date of manufacture: year-month

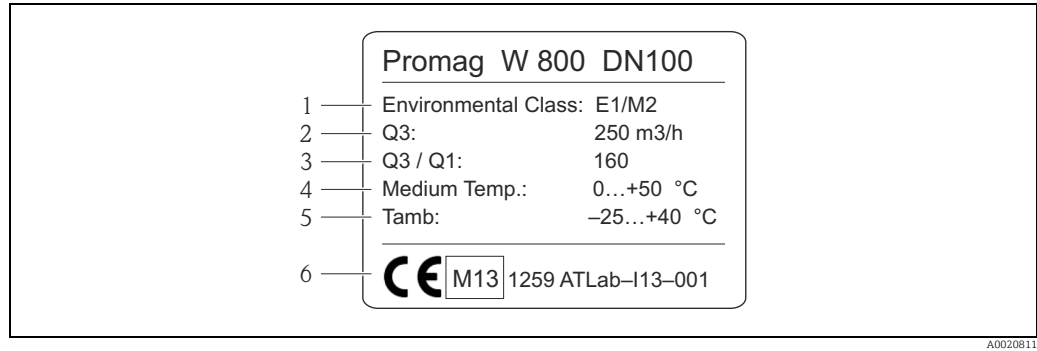

Fig. 3: Additional nameplate for measuring devices subject to legal metrological control (optional) (example)

- 1 Electromagnetic/mechanical environment class
- 2 Permanent flowrate Q3
- 3 Permanent flow ratio Q3/Q1
- 4 Permitted fluid temperature range
- 5 Permitted ambient temperature range
- 6 Conformity marking with CEM mark, year, notified body and number of the EC type-examination certificate

Transmitter

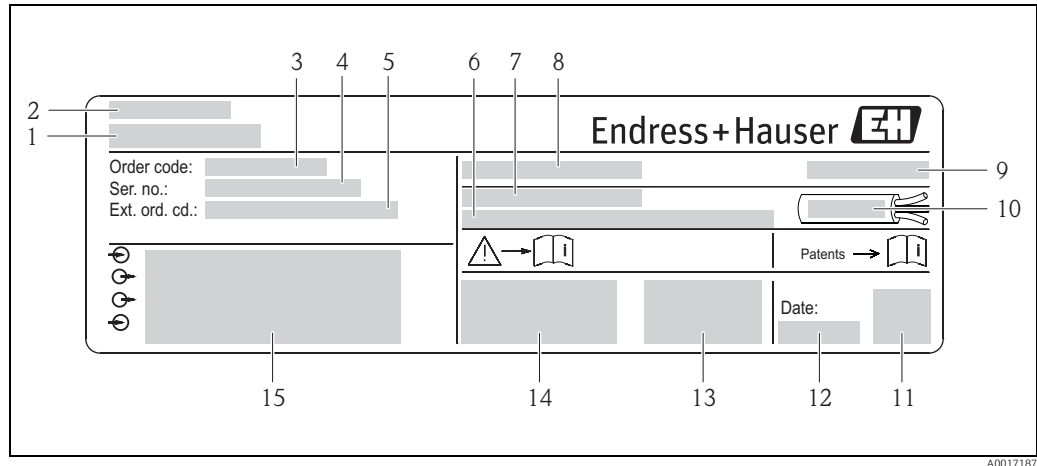

Fig. 4: Example of transmitter nameplate

- 1 Name of transmitter
- 2 Place of manufacture
- 3 Order code
- 4 Serial number (Ser.No.)
- 5 Extended order code (Ext. ord. co.)
- 6 Firmware version (FW) and device revision (Dev.Rev.) from factory
- 7 Permitted ambient temperature range (T_a)
- 8 FCC-ID (Federal Communications Commission)
- 9 Degree of protection: e.g. IP, NEMA
- 10 Permitted temperature range for cables
- 11 2-D matrix code
- 12 Date of manufacture: year-month
- 13 FCC symbol
- 14 CE mark, C-tick
- 15 Electrical connection data: e.g. inputs and outputs available, supply voltage



i Order code
The measuring device is reordered using the order code.

Extended order code

- The device type (product root) and basic specifications (mandatory features) are always listed.
- Of the optional specifications (optional features), only the specifications relating to safety and hazardous areas are listed (e.g. LA). If other optional specifications are also ordered, these are indicated collectively using the placeholder symbol "#" (e.g. #LA#).

- If the ordered optional specifications do not include any safety and approval-related specifications, they are indicated by the placeholder symbol "+" (e.g. 5W8B50-AACCCAAD2S1+).

4.2.2 Symbols on the device

Symbol	Meaning
 Warning!	"Warning" indicates an action or procedure which, if not performed correctly, can result in injury or a safety hazard. Comply strictly with the instructions and proceed with care.
 <small>A0011199</small>	Protective ground connection A terminal which must be connected to ground prior to establishing any other connections.
 <small>A0011194</small>	Reference to documentation Refers to the corresponding device documentation.

5 Storage, transport and disposal of packaging

5.1 Storage conditions

Note the following when storing the device:

- Store in the original packaging to protect against impact.
- Do not remove protective covers or protection caps mounted on process connections. They prevent mechanical damage to the sealing surfaces and fouling in the measuring pipe.
- Protect from sunlight to avoid impermissibly high surface temperatures.
- Choose a storage location where moisture does not collect in the measuring device. This will help prevent fungus and bacteria infestation which can damage the liner.
- Store in a dry, dust-free atmosphere.
- Do not store outdoors.
- Storage temperature → ☰ 114.
- Also be mindful of the following when storing the batteries:
 - Avoid any short-circuiting of the battery poles.
 - The storage temperature should preferably be $\leq 21\text{ °C}$ (70 °F).
 - Store in a dry, dust-free atmosphere that is not subject to large fluctuations in temperature.
 - Protect from sunlight.
 - Do not store near heaters.

5.2 Transporting the product



Warning!

Risk of injury if the measuring device slips.

The center of gravity of the measuring device is higher than the points around which the webbing slings are slung.

- Secure the measuring device so that it does not turn around its axis or slip.

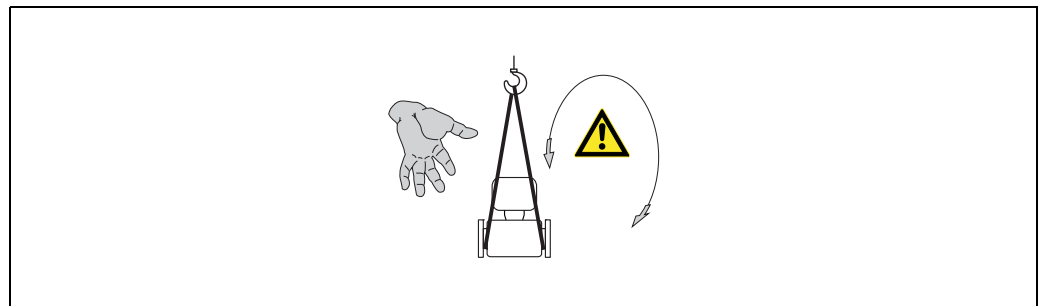

A0015606

Fig. 5: Risk of injury if the measuring device slips when transporting sensors



Caution!

Note the following when transporting the device:

- Transport the measuring device to the measuring point in its original packaging.
- Do not remove protective covers or protection caps mounted on process connections. They prevent mechanical damage to the sealing surfaces and fouling in the measuring pipe.
- Pay attention to the weight information on the packaging (adhesive label).
- Observe the transportation instructions on the adhesive label on the electronics compartment cover.
- Do not lift the measuring device by the transmitter housing or the connection housing of the remote version.
- Lifting tool
 - Use webbing slings (avoid chains as these could damage the housing).

- For wood crates, the floor structure enables these to be loaded lengthwise or broadside using a forklift.
- Using the webbing slings, lift the measuring device by the process connections, not by the transmitter housing.

5.3 Disposing of the packaging

All the packaging material is environmentally friendly and 100 % recyclable:

- Measuring device secondary packaging:
Polymer stretch wrap that meets the requirements of EU Directive 2002/95/EC (RoHS).
- Packaging
 - Wooden crate: treated in accordance with standard ISPM 15, which is confirmed by the IPPC logo affixed to the crate.
or
 - Cardboard: in accordance with European Directive 94/62/EC on packaging and packaging waste;
recyclability is confirmed by the Resy symbol affixed to the packaging.
- Seaworthy packaging (optional):
Wooden crate, treated in accordance with standard ISPM 15, which is confirmed by the IPPC logo affixed to the crate.
- Carrier and fastening material:
 - Plastic disposable pallet
 - Plastic straps
 - Plastic adhesive strips
- Filler material: paper pads

6 Installation

6.1 Installation conditions

No special measures such as supports are necessary. External forces are absorbed by the construction of the device.

6.1.1 Mounting position

Mounting location

Preferably install the sensor in an ascending pipe, and ensure a sufficient distance ($\geq 2 \times \text{DN}$) to the next pipe elbow.

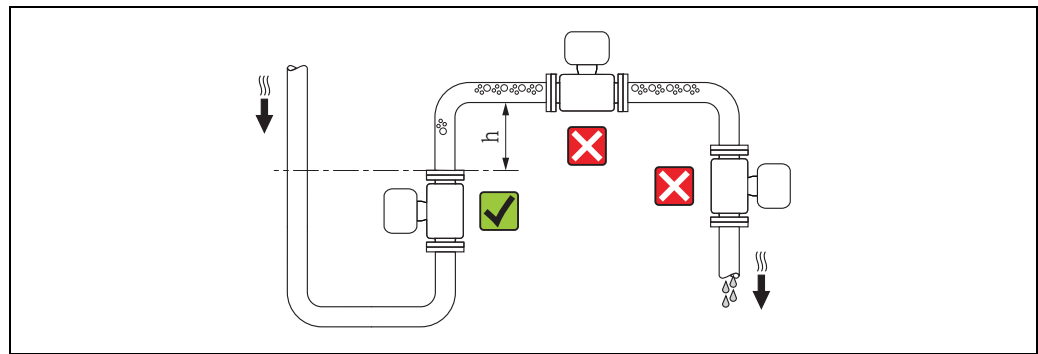

Fig. 6: Selecting the mounting location

To prevent measuring errors from gas bubbles accumulating in the measuring tube, avoid the following mounting locations in the pipe:

- Highest point of a pipeline
- Directly upstream of a free pipe outlet in a down pipe

Installation in down pipes

Install a siphon or a vent valve downstream of the sensor in down pipes whose length $h \geq 5 \text{ m}$ (16.4 ft), (\rightarrow 7). This precaution is to avoid low pressure and the consequent risk of damage to the lining of the measuring tube. This measure also prevents the system losing prime, which could cause air pockets.

Information on the lining's resistance to partial vacuum can be found on \rightarrow 116.

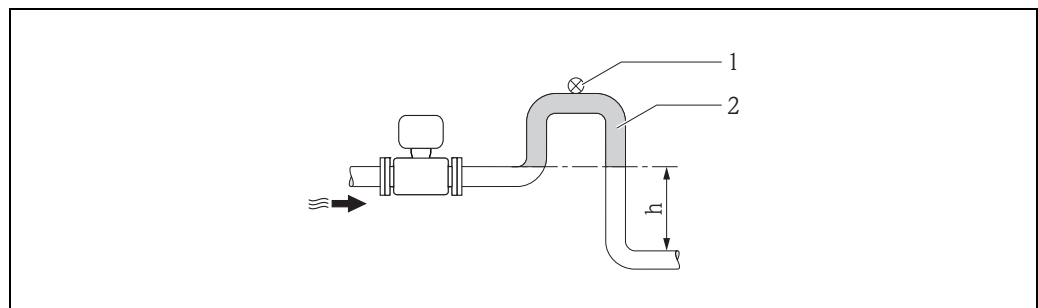

Fig. 7: Measures for installation in a down pipe

- 1 Vent valve
- 2 Pipe siphon
- h Length of down pipe, $h \geq 5 \text{ m}$ (16.4 ft)

Installation in partially filled pipes with a gradient

Partially filled pipes with gradients necessitate a drain-type configuration.

**Caution!**

Risk of solids accumulating.

- Do not install the sensor at the lowest point in the drain.
- It is advisable to install a cleaning valve.

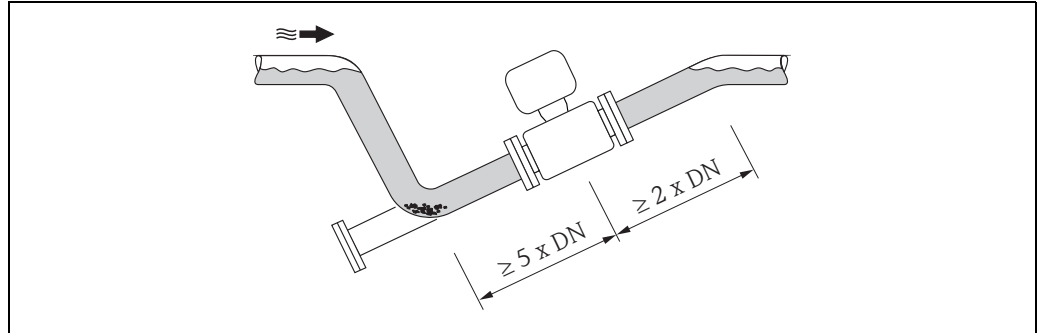

Fig. 8: Installation in a partially filled pipe

If using pumps

- If pumps are used, do not install the sensor on the intake side of a pump. This precaution is to avoid low pressure and the consequent risk of damage to the lining of the measuring tube. Information on the lining's resistance to partial vacuum can be found on → 116.
- If reciprocating, diaphragm or peristaltic pumps are used, it might be necessary to install pulse dampers. For information on the measuring system's resistance to vibration and shock → 115.

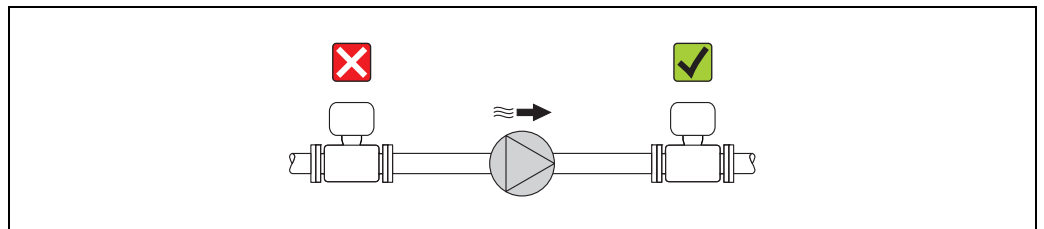

Fig. 9: Installation if using pumps

For permanent immersion in water

The fully welded remote version of the measuring device can be immersed permanently in water to a depth of ≤ 3 m (10 ft) or 48 h at ≤ 10 m (30 ft). The measuring device satisfies diverse corrosion protection categories in accordance with EN ISO 12944. The fully welded design along with the connection compartment sealing system ensure that moisture cannot enter the measuring device.

The connecting cables of the remote version can be ordered:

- With pre-terminated cables that are already connected to the sensor.
- **Optionally:** With pre-terminated cables, where the cables are connected by the customer onsite (incl. tools for sealing the connection compartment).

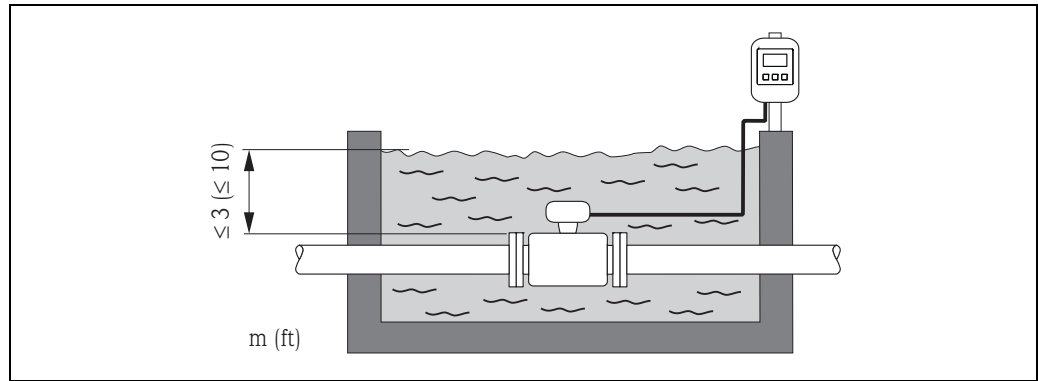

Fig. 10: Installation for permanent immersion in water

For buried applications

The fully welded remote version of the measuring device can be used for buried applications. The measuring device satisfies the certified corrosion protection Im3 in accordance with EN ISO 12944. It can be used directly underground without the need for additional protective measures. The device is installed in accordance with the usual regional installation regulations (e.g. EN DIN 1610).

The connecting cables of the remote version can be ordered:

- With pre-terminated cables that are already connected to the sensor.
- **Optionally:** With pre-terminated cables, where the cables are connected by the customer onsite (incl. tools for sealing the connection compartment).

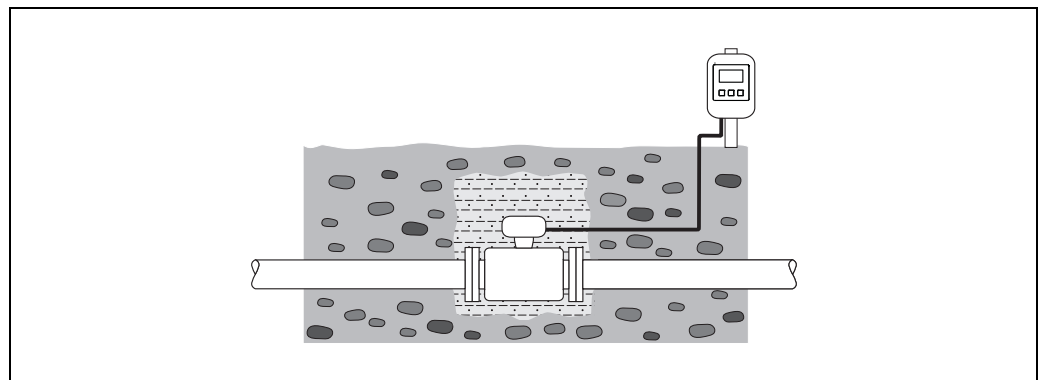

Fig. 11: Installation for buried applications

Orientation

An optimum orientation position helps avoid gas and air accumulations and deposits in the measuring tube.

Vertical orientation

Vertical orientation is optimal in the following scenarios:

- For self-emptying piping systems.
- For sludge containing sand or stones where the solids tend to settle at the bottom.

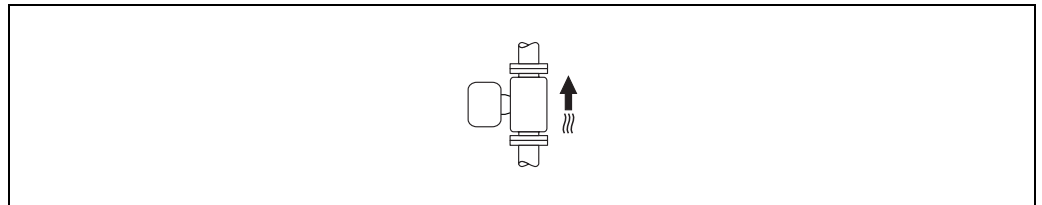

Fig. 12: Vertical orientation

Horizontal orientation

The measuring electrode plane should be horizontal in the case of horizontal orientation. This prevents brief insulation of the two measuring electrodes by entrained air bubbles.

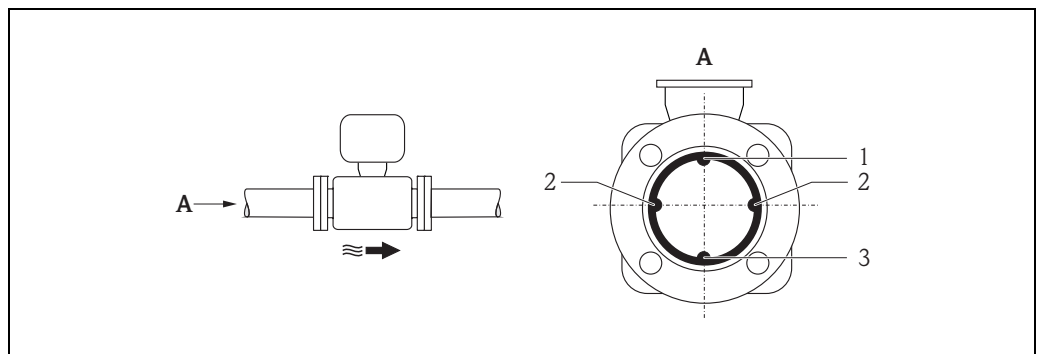

Fig. 13: Horizontal orientation

- 1 EPD electrode for the detection of empty pipes (not supported by the transmitter)
- 2 Measuring electrodes used for measuring signal pick up and empty pipe detection (EPD). An EPD alarm is triggered if there is no fluid between electrodes.
- 3 Reference electrode for potential equalization

Inlet and outlet runs

If possible, install the sensor upstream from fittings such as valves, T-pieces, elbows, etc. Observe the following inlet and outlet runs in order to meet accuracy specifications:

- Inlet run $\geq 5 \times DN$
- Outlet run $\geq 2 \times DN$

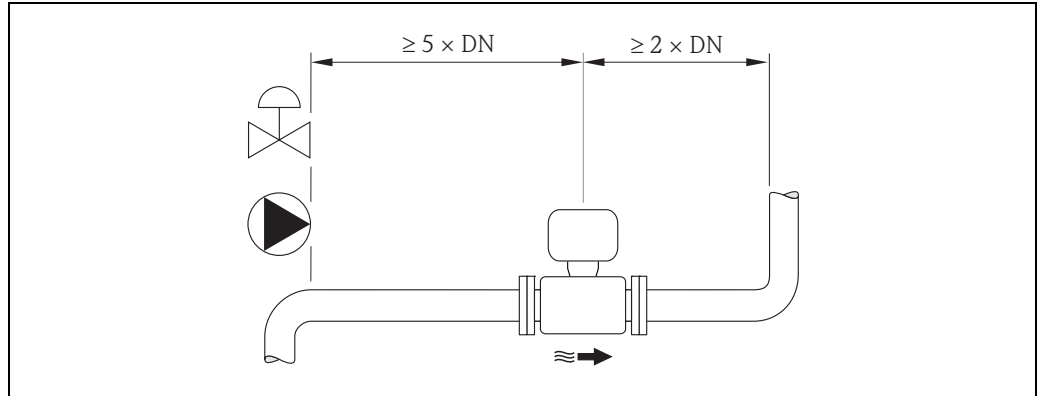

Fig. 14: Inlet and outlet runs

i No special requirements must be observed at the inlet and outlet runs to keep within the in-service maximum permissible errors for custody transfer.

6.1.2 Environmental and process-specific requirements

Ambient temperature range

→ 114

Pressure tightness

→ 116

Vibrations

In the event of strong vibrations: support and fix the pipe and sensor.



Caution!

If vibrations are too severe, we recommend the sensor and transmitter be mounted separately. Information on resistance to vibration and shock can be found on → 115.

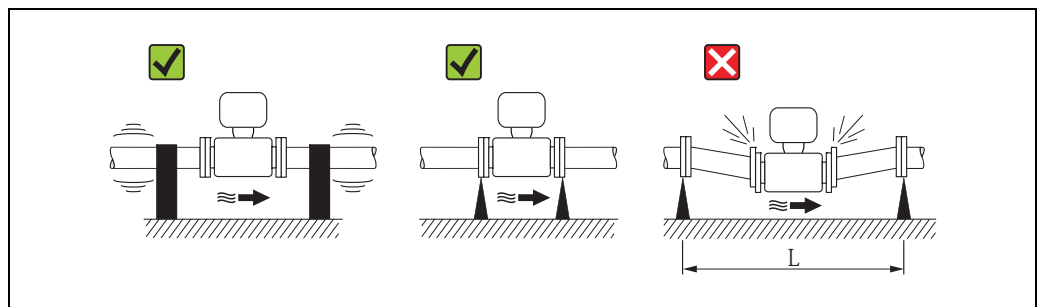

Fig. 15: Measures to prevent vibration of the device ($L > 10\text{ m (33 ft)}$)

Corrosive environment

The fully welded remote version of the measuring device can be immersed permanently in corrosive (saline) environments. The measuring device satisfies the certified corrosion protection in accordance with EN ISO 12944 C5M. The fully welded design along with the varnish finish ensure that the device can be used in saline environments.

6.1.3 Special installation

Adapters

Suitable adapters to DIN EN 545 (double-flange reducers) can be used to install the sensor in larger-diameter pipes.

The resultant increase in the rate of flow improves measuring accuracy with very slow-moving fluids. The nomogram shown here can be used to calculate the pressure loss caused by reducers and expanders.



Note!

The nomogram only applies to liquids of viscosity similar to water.

Determining the pressure loss:

1. Calculate the ratio of the diameters d/D .
2. From the nomogram read off the pressure loss as a function of flow velocity (downstream from the reduction) and the d/D ratio.

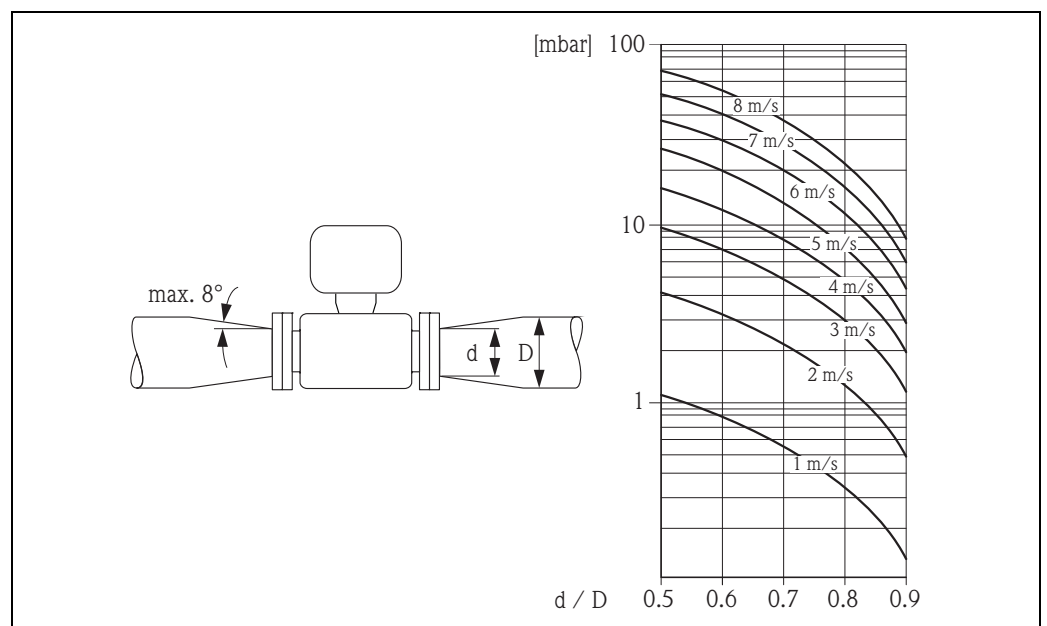

Fig. 16: Pressure loss due to adapters

Nominal diameter and flow rate

The diameter of the pipe and the flow rate determine the nominal diameter of the sensor. Therefore, please note the following:

- The optimum velocity of flow is between 2 and 3 m/s (6.5 to 9.8 ft/s).
- Match the velocity of flow (v) to the physical properties of the fluid:
 - $v < 2$ m/s (6.5 ft/s): for abrasive fluids
 - $v > 2$ m/s (6.5 ft/s): for fluids producing buildup



Note!

If it is necessary to increase the flow velocity:

Use adapters to reduce the nominal diameter of the sensor → 23.

Recommended flow

Nominal diameter		Recommended flow	
[mm]	[in]	Min./max. full scale value ($v \approx 0.5$ or 10 m/s)	
25	1"	15 to 295 dm ³ /min	4 to 80 gal/min
32	–	25 to 485 dm ³ /min	7 to 130 gal/min
40	–	40 to 755 dm ³ /min	10 to 200 gal/min
50	2"	60 to 1180 dm ³ /min	16 to 320 gal/min
65	–	100 to 2000 dm ³ /min	28 to 530 gal/min
80	3"	150 to 3020 dm ³ /min	40 to 800 gal/min
100	4"	240 to 4750 dm ³ /min	65 to 1200 gal/min
125	–	370 to 7400 dm ³ /min	100 to 1900 gal/min
150	6"	32 to 640 m ³ /h	142 to 2800 gal/min
200	8"	58 to 1135 m ³ /h	250 to 4900 gal/min
250	10"	90 to 1800 m ³ /h	390 to 7700 gal/min
300	12"	130 to 2500 m ³ /h	570 to 11000 gal/min

**Note!**

For service subject to legal metrological control the approved flow values apply → 94.

Connecting cable

In order to ensure measuring accuracy, comply with the following instructions when installing a remote version:

- Fix the cable run or route it in an armored conduit. Cable movements can falsify the measuring signal especially in the case of low fluid conductivities.
- Route the cable well clear of electrical machines and switching elements.
- Ensure potential equalization between sensor and transmitter, if necessary.
- The maximum connecting cable length is 20 m (35.6 ft).

GSM/GPRS antenna

Check the signal strength of the mobile communications network before mounting the antenna → 37.

Display protection

To ensure that the optional display protection can be easily opened, maintain the following minimum head clearance: 350 mm (13.8 in)

6.2 Installing the measuring device

6.2.1 Sensor installation

Required mounting tools

For flange and other process connections:

- Bolts, nuts, seals, etc. These items are not included in the scope of supply and must be supplied by the customer.
- Appropriate mounting tools

Installing the sensor

Mount the sensor between the pipe flanges.

In doing so, please note the following:

- Required screw tightening torques →  25.
- If using ground disks:
Comply with the Installation Instructions provided with the ground disks.

Mounting the seals



Caution!

Risk of short circuit!



Do not use electrically conductive sealing compounds such as graphite! An electrically conductive layer could form on the inside of the measuring tube and short-circuit the measuring signal.

Comply with the following instructions when installing seals:

- For hard rubber lining: additional seals are **always** required.
- For polyurethane lining: generally additional seals are **not** required.
- For DIN flanges: only use seals according to EN 1514-1.
- Make sure that the seals do not protrude into the piping cross-section.

Mounting the ground cable

Comply with the following instructions when installing the ground cable:





- Comply with the information on potential equalization and detailed mounting instructions for the use of ground cables on →  43
- If necessary, you can order special ground cables for potential equalization as an accessory (→  106).

Screw tightening torques for mounting the sensor

Please note the following:

- The tightening torques listed below are for lubricated threads only.
- Tighten the screws uniformly and in diagonally opposite sequence.
- Overtightening the screws will deform the sealing faces or damage the seals.
- The tightening torques listed below apply only to pipes not subjected to tensile stress.

Tightening torques for:

- EN (DIN) →  26
- ASME →  26
- AS →  27
- JIS →  27

Promag W tightening torques for EN (DIN)

Nominal diameter [mm]	EN (DIN)		Max. tightening torque [Nm]	
	Pressure rating [bar]	Threaded fasteners	Hard rubber	Polyurethane
25	PN 40	4 × M 12	–	15
32	PN 40	4 × M 16	–	24
40	PN 40	4 × M 16	–	31
50	PN 40	4 × M 16	48	40
65*	PN 16	8 × M 16	32	27
65	PN 40	8 × M 16	32	27
80	PN 16	8 × M 16	40	34
80	PN 40	8 × M 16	40	34
100	PN 16	8 × M 16	43	36
100	PN 40	8 × M 20	59	50
125	PN 16	8 × M 16	56	48
125	PN 40	8 × M 24	83	71
150	PN 16	8 × M 20	74	63
150	PN 40	8 × M 24	104	88
200	PN 10	8 × M 20	106	91
200	PN 16	12 × M 20	70	61
200	PN 25	12 × M 24	104	92
250	PN 10	12 × M 20	82	71
250	PN 16	12 × M 24	98	85
250	PN 25	12 × M 27	150	134
300	PN 10	12 × M 20	94	81
300	PN 16	12 × M 24	134	118
300	PN 25	16 × M 27	153	138

* Designed acc. to EN 1092-1 (not to DIN 2501)

Promag W tightening torques for ASME

Nominal diameter [mm] [in]		ASME Pressure rating [lbs]	Threaded fasteners	Max. tightening torque			
				Hard rubber [Nm] [lbf · ft]		Polyurethane [Nm] [lbf · ft]	
25	1"	Class 150	4 × ½"	–	–	7	5
25	1"	Class 300	4 × 5/8"	–	–	8	6
50	2"	Class 150	4 × 5/8"	35	26	22	16
50	2"	Class 300	8 × 5/8"	18	13	11	8
80	3"	Class 150	4 × 5/8"	60	44	43	32
80	3"	Class 300	8 × ¾"	38	28	26	19
100	4"	Class 150	8 × 5/8"	42	31	31	23
100	4"	Class 300	8 × ¾"	58	43	40	30
150	6"	Class 150	8 × ¾"	79	58	59	44
150	6"	Class 300	12 × ¾"	70	52	51	38
200	8"	Class 150	8 × ¾"	107	79	80	59
250	10"	Class 150	12 × 7/8"	101	74	75	55
300	12"	Class 150	12 × 7/8"	133	98	103	76

Promag W tightening torques for AS

Nominal diameter [mm]	AS		Max. tightening torque [Nm]	
	Pressure rating	Threaded fasteners	Hard rubber	Polyurethane
80	Table E	4 × M 16	49	–
80	PN 16	4 × M 16	49	–
100	Table E	8 × M 16	38	–
100	PN 16	4 × M 16	76	–
150	Table E	8 × M 20	64	–
150	PN 16	8 × M 20	52	–
200	Table E	8 × M 20	96	–
200	PN 16	8 × M 20	77	–
250	Table E	12 × M 20	98	–
250	PN 16	8 × M 20	147	–
300	Table E	12 × M 24	123	–
300	PN 16	12 × M 24	103	–

Promag W tightening torques for JIS

Nominal diameter [mm]	JIS		Max. tightening torque [Nm]	
	Pressure rating	Threaded fasteners	Hard rubber	Polyurethane
25	20K	4 × M 16	–	19
32	20K	4 × M 16	–	22
40	20K	4 × M 16	–	24
50	10K	4 × M 16	40	33
50	20K	8 × M 16	20	17
65	10K	4 × M 16	55	45
65	20K	8 × M 16	28	23
80	10K	8 × M 16	29	23
80	20K	8 × M 20	42	35
100	10K	8 × M 16	35	29
100	20K	8 × M 20	56	48
125	10K	8 × M 20	60	51
125	20K	8 × M 22	91	79
150	10K	8 × M 20	75	63
150	20K	12 × M 22	81	72
200	10K	12 × M 20	61	52
200	20K	12 × M 22	91	80
250	10K	12 × M 22	100	87
250	20K	12 × M 24	159	144
300	10K	16 × M 22	74	63
300	20K	16 × M 24	138	124

6.2.2 Turning the transmitter housing

1. Release the four screws on the housing cover.
2. Lift the housing cover slightly and tip it to the left.
Two flexible fasteners secure the housing cover to the housing.
3. Release the four screws on the electronics board carrier.
(one screw is located under the folding part of the battery cover).
4. Gently lift up the electronics board carrier until it is possible to access the connection between the signal cable and the sensor. Disconnect the signal cable from the sensor and remove the carrier from the transmitter housing.
5. Release the four screws on the transmitter housing.
6. Lift the transmitter housing slightly and turn it to the required position.

Reverse the sequence to install the transmitter housing.

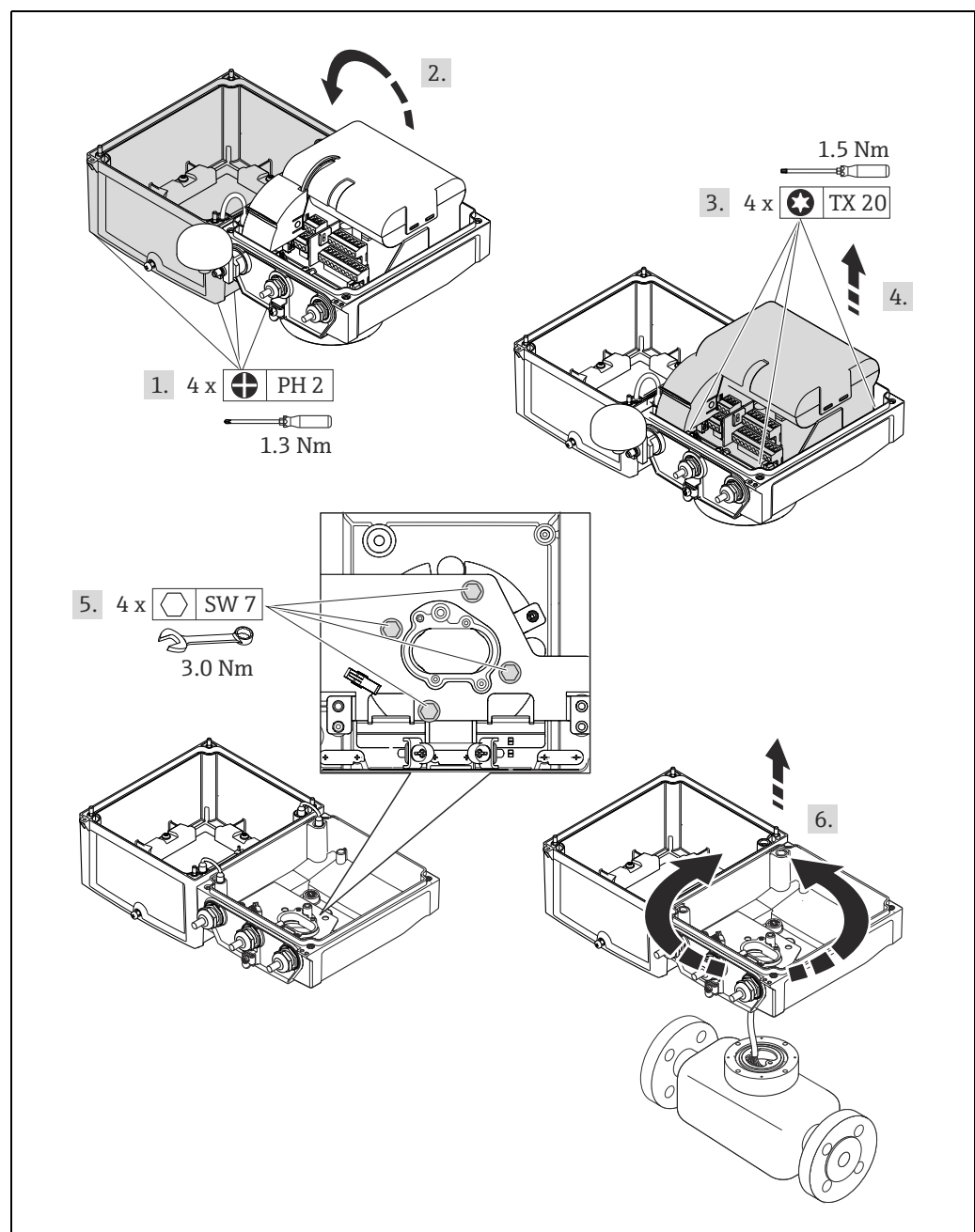

Fig. 17: Turning the transmitter housing

A0017378

6.2.3 Installing the wall-mount housing

There are various ways of installing the wall-mount transmitter housing:

- Direct wall mounting
- Pipe mounting (with separate mounting kit, accessories) → 30



Caution!

The permitted operating temperature range → 114 may not be exceeded or undershot.

Note the following points:

- Install the measuring device in a shady location. Avoid direct sunlight, particularly in warm climatic regions.
- The transmitter must be mounted separate from the sensor if both the ambient and fluid temperatures are high.

Direct wall mounting

1. Drill the holes as illustrated in the graphic.
2. Screw in the securing screws slightly at first.
3. Fit the transmitter housing over the securing screws and mount in place.
4. Tighten the securing screws.

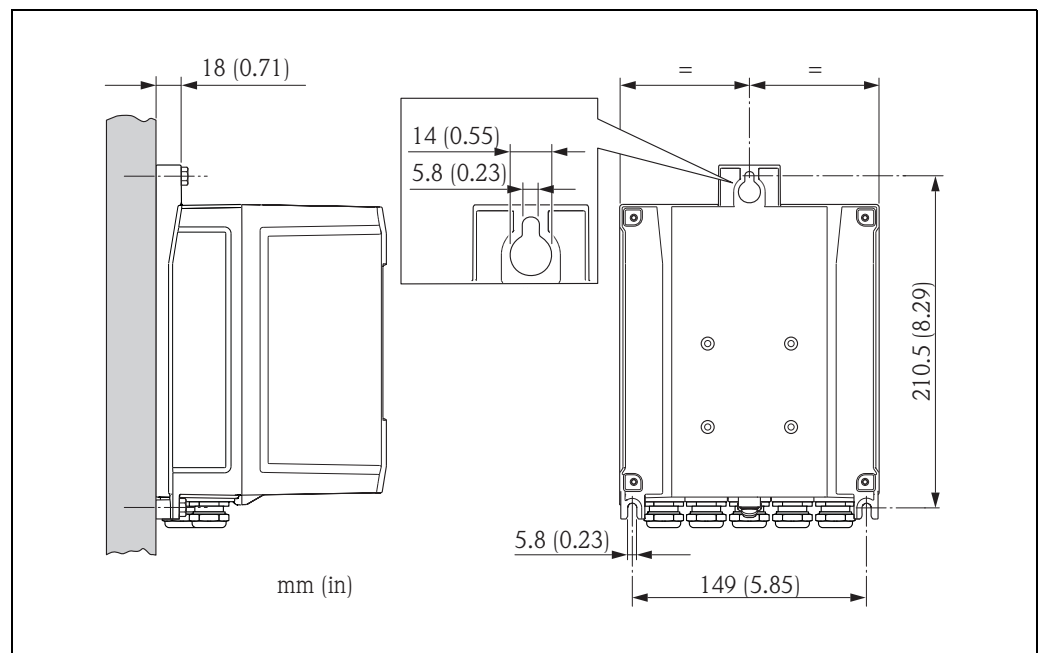

Fig. 18: Direct wall mounting

Pipe mounting

The assembly should be performed by following the instructions in the graphic.



Caution!

If using a warm pipe, make sure that temperatures do not exceed the permitted ambient temperature range → 114.

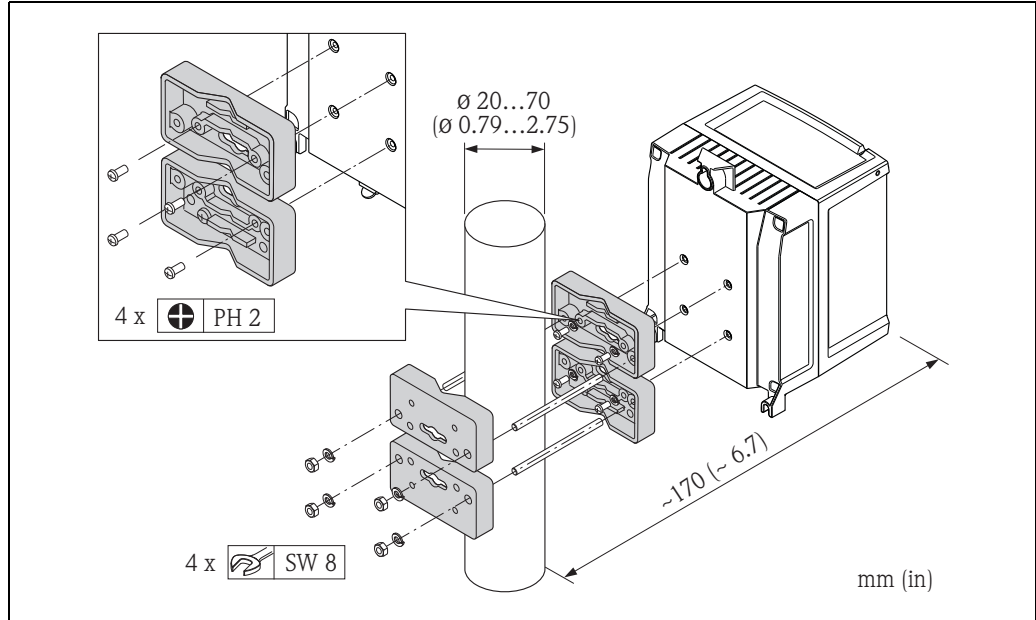

Fig. 19: Pipe mounting (wall-mount housing)

6.3 Post-installation check

Is the measuring device undamaged (visual inspection)?	<input type="checkbox"/>
Does the measuring device meet the specifications of the measuring point? For example: <ul style="list-style-type: none"> ■ Process temperature → 115 ■ Process pressure (see the "Material load diagrams" section in the "Technical Information" document) ■ Ambient temperature range → 114 ■ Measuring range → 110 	<input type="checkbox"/>
Has the correct orientation been selected for the sensor → 18? <ul style="list-style-type: none"> ■ According to sensor type ■ According to fluid temperature ■ According to fluid properties (outgassing, with entrained solids) 	<input type="checkbox"/>
Does the arrow on the sensor nameplate match the actual direction of fluid flow through the pipe?	<input type="checkbox"/>
Are the measuring point identification and labeling correct (visual inspection)?	<input type="checkbox"/>
Is the device adequately protected from precipitation and direct sunlight?	<input type="checkbox"/>
Have the fastening elements been tightened with the correct tightening torque?	<input type="checkbox"/>
Has the signal strength for the GSM/GPRS modem been checked at the mounting location? Is the signal strong enough for operation purposes?	<input type="checkbox"/>

7 Electrical connection

7.1 Preparing the measuring device

7.1.1 Required mounting tools

- For cable entries: use an appropriate tool.
- For the housing cover: use a Phillips head screwdriver.
- Cable stripper.
- For stranded cables: use a crimper for wire end ferrules.
- To remove cables from terminals: use a slotted screwdriver ≤ 3 mm (0.12 in).

7.1.2 Connecting cable requirements

The connecting cables provided by the customer must meet the following criteria:

Electrical safety

According to national regulations.

Cable specification

- Permitted temperature range: -40 to 80 °C (-40 to 176 °F);
Minimum ambient temperature: $+20$ K
- A shielded cable is recommended
- Stripped length: 6 mm
- Strand (flexible): 2.5 mm²
- Cable diameter
 - With cable glands supplied:
M20 \times 1.5 with cable \varnothing 6 to 12 mm (0.24 to 0.47 in)
 - Plug-in screw terminals: core cross-sections 0.5 to 2.5 mm² (20 to 14 AWG)

7.1.3 Connecting cable requirements for the remote version

The connecting cables for the remote version provided by the customer must meet the following criteria:

Cable specifications

Electrode cable

- 3×0.38 mm² PVC cable with common, braided copper shield ($\varnothing \sim 7$ mm) and individually shielded cores
- Conductor resistance: ≤ 50 Ω /km
- Capacitance: core/shield: ≤ 420 pF/m
- Operating temperature: -20 to $+80$ °C (-4 to 176 °F)
- Cable cross-section: max. 2.5 mm²

Coil current cable

- 2×0.75 mm² PVC cable with common, braided copper shield ($\varnothing \sim 7$ mm)
- Conductor resistance: ≤ 37 Ω /km
- Capacitance: core/core, shield grounded: ≤ 120 pF/m
- Operating temperature: -20 to $+80$ °C (-4 to 176 °F)
- Cable cross-section: max. 2.5 mm²
- Test voltage for cable insulation: ≥ 1433 V AC r.m.s 50/60 Hz or ≥ 2026 V DC

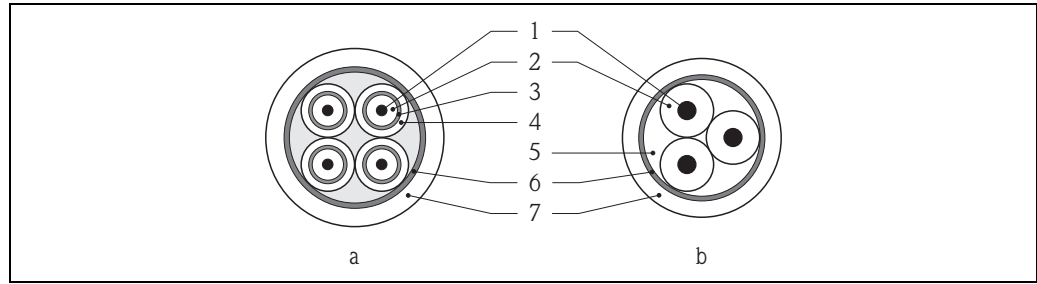

Fig. 20: Cable cross-section

- a* Electrode cable
b Coil current cable
- 1 Core
 2 Core insulation
 3 Core shield
 4 Core jacket
 5 Core reinforcement
 6 Cable shield
 7 Outer jacket

Reinforced connecting cables

As an option, Endress+Hauser can also deliver reinforced connecting cables with an additional, reinforcing metal braid.

Use a reinforced connecting cable in the following situations:

- When laying the cable directly in the ground
- Where there is a risk of damage from rodents
- If using the device below IP68 degree of protection

Operation in zones of severe electrical interference

The measuring device complies with the general safety requirements in accordance with EN 61010-1 and the EMC requirements of IEC/EN 61326.



Caution!

Grounding is by means of the ground terminals provided for the purpose inside the connection housing. Ensure that the stripped and twisted lengths of cable shield to the ground terminal are as short as possible.

7.1.4 Preparing the electrode and coil current cable

Terminate the electrode and coil current cables as shown in the figure below (Detail A). Fit the fine-wire cores with wire end ferrules (Detail B).



Caution!

Please note the following when terminating the cables:

- In the case of electrode cable, make sure that the ferrules do not touch the wire shield on the sensor side. Minimum distance = 1 mm (exception "GND" = green cable).
- In the case of coil current cables, insulate one core of the three-core wire at the level of the core reinforcement. You only require two cores for the connection.

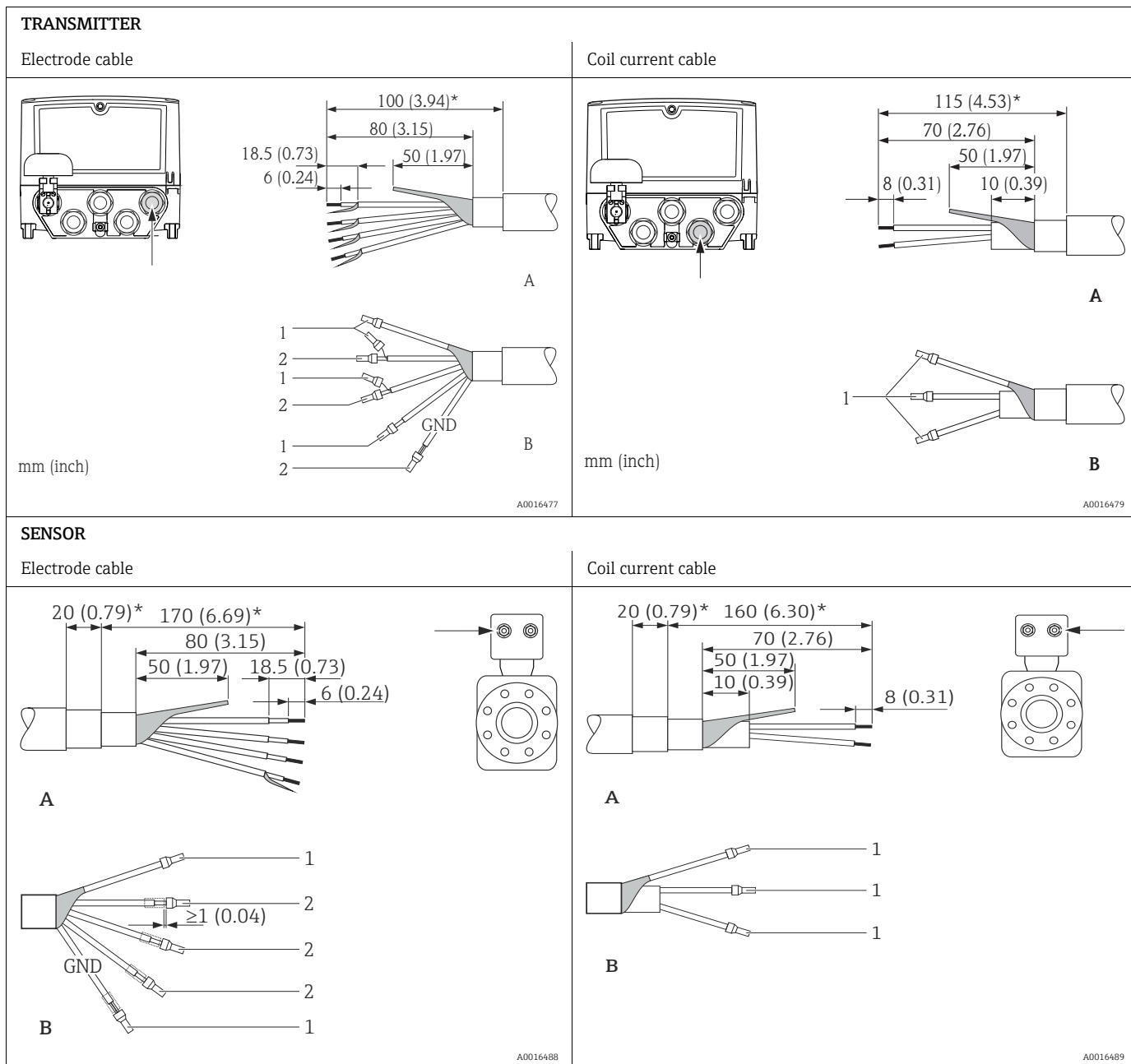

1 = Red ferrules, Ø 1.0 mm

2 = White ferrules, Ø 0.5 mm)

* Stripping only for reinforced cables

7.1.5 Preparing the measuring device

- Remove any dummy plugs.

 **Caution!**

Poor sealing in the housing can affect the operational reliability of the measuring device. Use suitable cable glands that correspond to the degree of protection.

If the measuring device is supplied without cable glands, provide appropriate cable glands for the connecting cable that comply with IP protection requirements.

- If the measuring device is supplied with cable glands, observe the cable specifications.

Cable entry

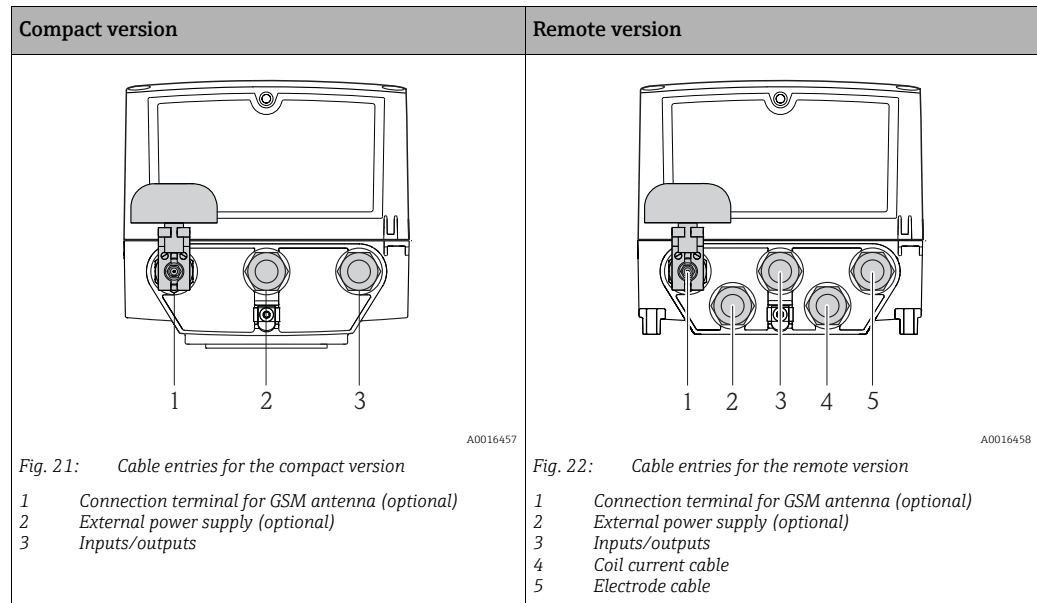

7.2 Connecting the measuring device



Warning!

- Risk of electric shock!**
Switch off the power supply before opening the device. Do not install or wire the device while it is energized. Failure to comply with this precaution can result in irreparable damage to the electronics.
- Risk of electric shock!**
Connect the protective conductor to the ground terminal on the housing before the power supply is applied (not necessary if the power supply is galvanically isolated).
- Compare the specifications on the nameplate with the local voltage supply and frequency. Also comply with national regulations governing the installation of electrical equipment.



Note!

Incorrect connection work can reduce electrical safety!

- Connection work must only be performed by properly trained specialists.
- Observe national regulations governing the installation of electrical equipment.
- Comply with local workplace safety regulations.

7.2.1 Connecting the inputs and outputs

i Different production steps are required to commission the measuring device and must be followed in a set order. Before performing a specific production step, check whether all the previous steps have been completed accordingly → 67.

1. Open the housing cover.
 - Release the four screws with a Phillips head screwdriver.
 - Lift the housing cover slightly and tip it to the left. Two flexible fasteners secure the housing cover to the housing.
2. Push the cable through the cable entry → 34.
To ensure tight sealing, do not remove the sealing ring from the cable entry.
3. Strip the cable ends over 6 mm (0.24 in).
In the case of stranded cables, also attach wire end ferrules.
4. Connect the cables in accordance with the terminal assignment.
When connecting the cable shield to the ground terminal, observe the grounding concept of the facility. Rigid conductors or flexible conductors with wire end ferrules can be inserted directly into the terminal without pressing on the wire release.

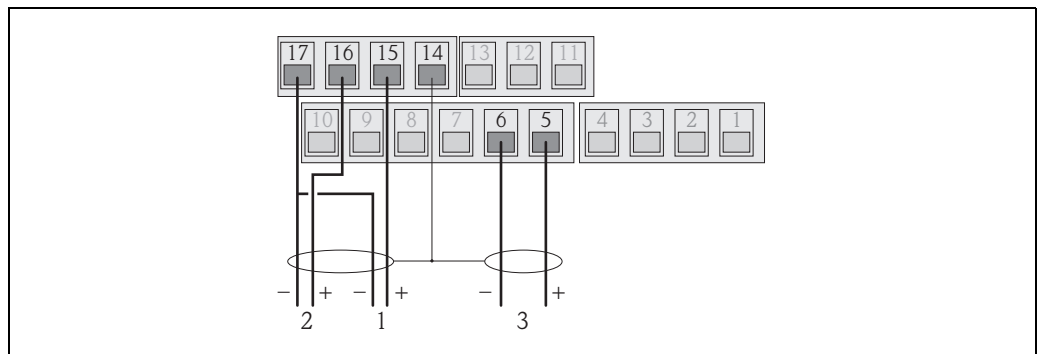

Fig. 23: Connecting the outputs

- 1 Output 1
- 2 Output 2
- 3 Input 1

Terminal assignment

Inputs		Outputs	
Terminal	Connection	Terminal	Connection
5	Input 1 (+)	14	Shield, output 1 and 2
6	Input 1 (-)	15	Output 1 (+)
		16	Output 2 (+)
		17	Output 1 and 2 (-)

5. Fit the cable anchorage and firmly tighten the cable glands.
6. Secure the housing cover.
 - Fix the housing cover on the housing.
 - Tighten the four screws with a Phillips head screwdriver.

7.2.2 Connecting the connecting cable in the remote version

i Different production steps are required to commission the measuring device and must be followed in a set order. Before performing a specific production step, check whether all the previous steps have been completed accordingly → 67.

1. Open the housing cover.
 - Release the four screws with a Phillips head screwdriver.
 - Lift the housing cover slightly and tip it to the left.
 - Two flexible fasteners secure the housing cover to the housing.
2. Push the cable through the cable entry → 34.
 - To ensure tight sealing, do not remove the sealing ring from the cable entry.
3. Strip the cable ends and fit wire end ferrules → 33.
4. Connect the cables in accordance with the terminal assignment.
 - When connecting the cable shield to the ground terminal, observe the grounding concept of the facility.

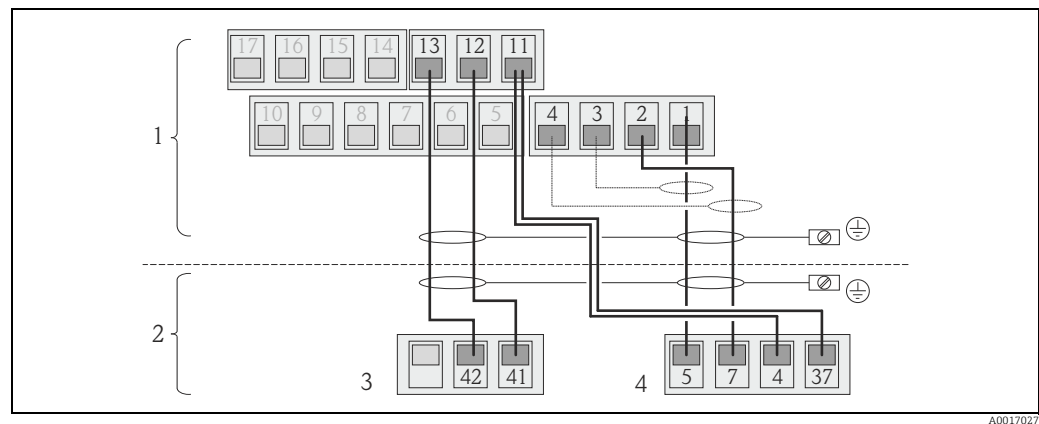

Fig. 24: Connecting the remote version

- 1 Transmitter terminals
- 2 Sensor terminals
- 3 Coil current cable
- 4 Electrode cable

Terminal assignment

Sensor		Transmitter	
Terminal	Connection	Terminal	Connection
5	Electrode E1 (brown)	1	Electrode E1 (brown)
7	Electrode E2 (white)	2	Electrode E2 (white)
4	Reference electrode,	3	Shield, electrode E1 (brown)
37	Terminals bridged (green)	4	Shield, electrode E2 (white)
41	Coil current cable B2 (black)	11	Reference electrode (green)
42	Coil current cable B1 (black)	12	Coil current cable B2 (black)
		13	Coil current cable B1 (black)

5. Fit the cable anchorage and firmly tighten the cable glands.
6. Secure the housing cover.
 - Fix the housing cover on the housing.
 - Tighten the four screws with a Phillips head screwdriver.

7.2.3 Connecting and mounting the GSM/GPRS antennae

i Different production steps are required to commission the measuring device and must be followed in a set order. Before performing a specific production step, check whether all the previous steps have been completed accordingly → 67.

Checking the signal strength to determine the type of mounting

Check whether and where a sufficiently strong signal of the mobile communications network is present. A cell phone or the measuring device can be used for this purpose:

- Hold a cell phone, containing a SIM card from the same provider, at the desired antenna mounting point and read how strong the signal is.
- If the measuring device is already operational (batteries inserted and battery power switched on → 42), the signal strength can be read:
 - On the onsite display by calling up the status of the antenna signal → 49.
 - In the operating tool by using the ANTSS parameter to read the signal strength → 164.

If the signal strength $\leq 30\%$, the antenna must be mounted separately from the measuring device.

Connecting and mounting the antenna

- Mount the antenna:
 - Signal strength $> 30\%$: mount the antenna on the measuring device → 25.
 - Signal strength $\leq 30\%$: mount the antenna separately from the measuring device → 27.
- Connect the antenna to the measuring device → 26.

Mounting the antenna directly on the measuring device

When mounting, make sure the antenna holder is as vertical as possible!

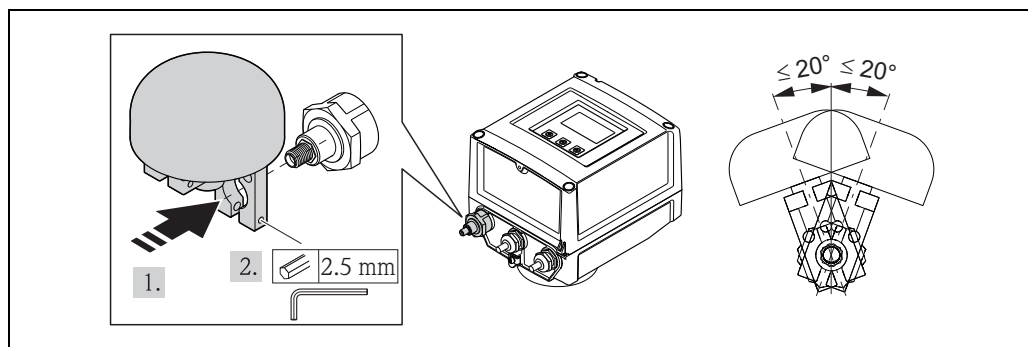

Fig. 25: Mounting the antenna directly on the measuring device

Connecting the antenna to the measuring device

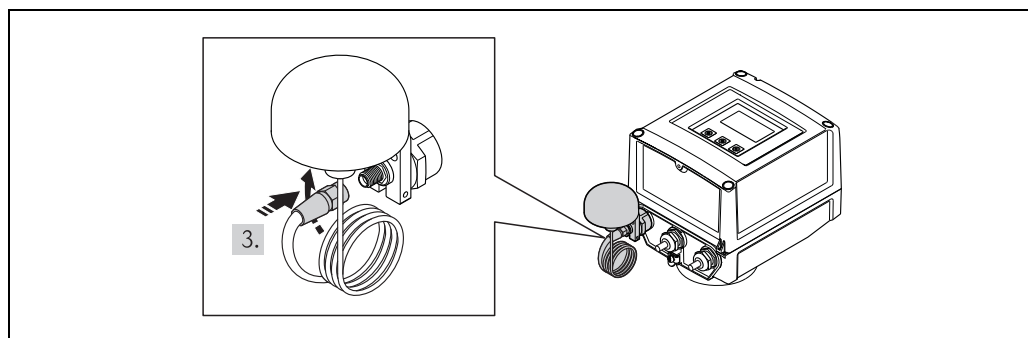



Fig. 26: Connecting the antenna

Mounting the antenna separately from the measuring device

- Mount the antenna as high as possible above the ground.
- Do not mount it beneath metal objects, covers, floors and ceilings.
- Make sure you maintain the minimum distance from walls and ceilings specified in →  27.
- Do not extend the antenna cable.

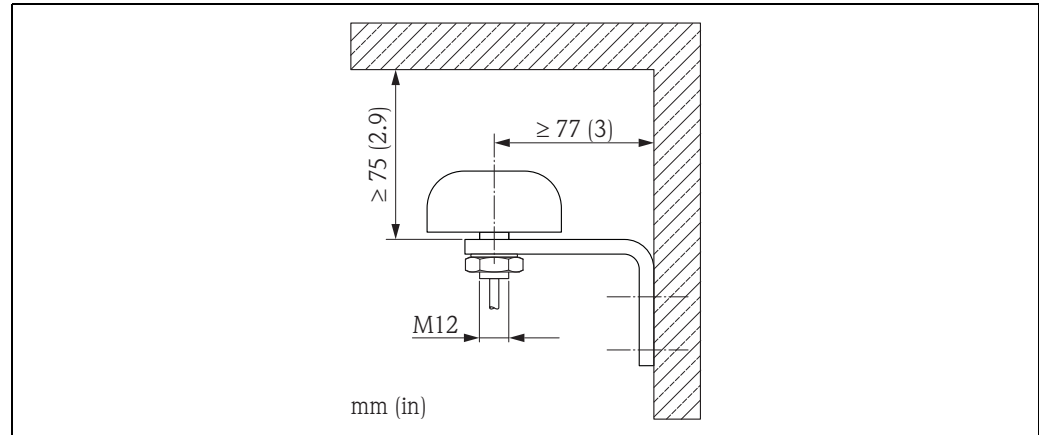

Fig. 27: Mounting the antenna separately from the measuring device

7.2.4 Connecting the external power supply (optional)

Preparing the connection

It is possible to power the measuring device directly via an external power supply. In addition, batteries are to be used as a backup if the power supply fails and to operate the GSM/GPRS module.



Possible combinations:

Ordered feature "Power supply"	Power supply	Number of batteries
5W8B**_***J*****	100 to 240 V AC 12 to 60 V DC	1 back-up battery
5W8B**_***K*****	100 to 240 V AC 12 to 60 V DC	1 back-up battery 3 batteries for GSM/GPRS module

If the measuring device is powered via an external power supply, energy from the batteries is not used. In such instances, the measuring device can work with maximum measured value acquisition cycles (Prof./ MPROF parameter →  135).

To ensure the device continues measuring if the external power supply fails, a battery is used as the backup power supply at the B1 terminal →  40.

The external power supply only supports measuring operation. Additional batteries must be inserted at the B3 terminal for communication via the GSM/GPRS modem →  40.

-  The batteries are **not** charged if an external power supply is used. The current state of charge of the batteries can be read on the onsite display or in the BATTs parameter →  164.

Measuring device requirements

- Integrate the measuring system into the potential equalization system → 43.
- The power supply line must be equipped with an external protection for overload current (fuse or automatic circuit breaker).
- The measuring device must have a suitably labeled and easy-to-reach ON/OFF switch.

Power supply and power supply unit requirements

- The power supply must be within the range indicated on the nameplate (Electrical connection → 112).
- Take the cable specification of the connecting cable into consideration → 112.
- Take the connecting cable requirements into consideration → 112.

Connecting the external power supply

i Different production steps are required to commission the measuring device and must be followed in a set order. Before performing a specific production step, check whether all the previous steps have been completed accordingly → 67.

1. Open the housing cover.
 - Release the four screws with a Phillips head screwdriver.
 - Lift the housing cover slightly and tip it to the left. Two flexible fasteners secure the housing cover to the housing.
2. Fold up the protective cover.
3. Push the cable through the cable entry → 34.
To ensure tight sealing, do not remove the sealing ring from the cable entry.
4. Strip the cable ends over 6 mm (0.24 in).
In the case of stranded cables, also attach wire end ferrules.
5. Connect the cables in accordance with the terminal assignment.
When connecting the cable shield to the ground terminal, observe the grounding concept of the facility.

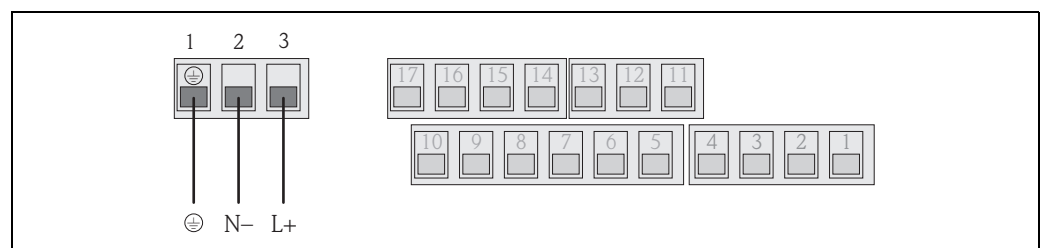

Fig. 28: Connecting the external power supply (optional)

Terminal assignment

External power supply	
Terminal	Connection
1	Protective ground
2	N -
3	L +

6. Fold down the protective cover.
7. Fit the cable anchorage and firmly tighten the cable glands.
8. Secure the housing cover.
 - Fix the housing cover on the housing.
 - Tighten the four screws with a Phillips head screwdriver.

7.3 Inserting and connecting the batteries

7.3.1 Overview of battery arrangement options

Three battery terminals are available in the measuring device. These terminals are assigned different uses depending on the number and arrangement of the batteries. B1 and B2 are the terminals for power supply to the measuring device, B3 is the terminal for the GSM/GPRS modem.

The measuring device is initially powered by the batteries in terminal B2. If the voltage supplied by these batteries becomes too low, the measuring device issues a message and switches automatically to the battery in terminal B1.

If power is supplied to the measuring device externally and the power supply fails, the battery in terminal B1 acts as a backup power supply.

The GSM/GPRS modem is always powered by the battery in terminal B3.



This is also the case if the measuring device uses an external power supply.

 The batteries are **not** charged if an external power supply is used.

The current state of charge of the batteries can be read on the onsite display or in the BATTs parameter →  164.

Possible configurations

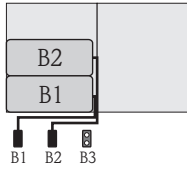
Configuration 1

Configuration of batteries	Connectors	Number of batteries	Battery usage
 A0017127	B 1	1	Backup power supply for the measuring device
	B 2	1	Power supply for the measuring device
	B 3	-	Power supply for the GSM/GPRS modem
"Power supply" order feature for this configuration: 5W8B**_*** FO *****  Note! Not permitted in custody transfer!			

Configuration 2

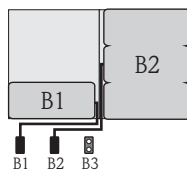
Configuration of batteries	Connectors	Number of batteries	Battery usage
 A0017128	B 1	1	Backup power supply for the measuring device
	B 2	3	Power supply for the measuring device
	B 3	-	Power supply for the GSM/GPRS modem
"Power supply" order feature for this configuration: 5W8B**_*** GO *****			

Configuration 3

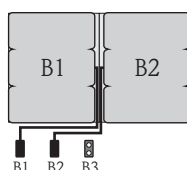
Configuration of batteries	Connectors	Number of batteries	Battery usage
 A0017129	B 1	3	Backup power supply for the measuring device
	B 2	3	Power supply for the measuring device
	B 3	-	Power supply for the GSM/GPRS modem
"Power supply" order feature for this configuration: 5W8B**_*** HO *****			

Configuration 4

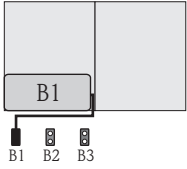
Configuration of batteries	Connectors	Number of batteries	Battery usage	
	B 1	1	Backup power supply for the measuring device	
	B 2	-	Power supply for the measuring device	
	B 3	-	Power supply for the GSM/GPRS modem	
	Powered via external power supply			Power supply for the measuring device
	"Power supply" order feature for this configuration: 5W8B**_*** JO *****			

Configuration 5

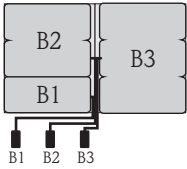
Configuration of batteries	Connectors	Number of batteries	Battery usage
	B 1	1	Backup power supply for the measuring device
	B 2	2	Power supply for the measuring device
	B 3	3	Power supply for the GSM/GPRS modem
	"Power supply" order feature for this configuration: 5W8B**_*** HP *****		

Configuration 6

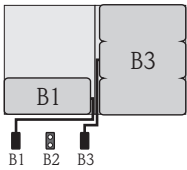
Configuration of batteries	Connectors	Number of batteries	Battery usage	
	B 1	1	Backup power supply for the measuring device	
	B 2	-	Power supply for the measuring device	
	B 3	3	Power supply for the GSM/GPRS modem	
	Powered via external power supply			Power supply for the measuring device
	"Power supply" order feature for this configuration: 5W8B**_*** KP *****			

7.3.2 Inserting and connecting the batteries

i Different production steps are required to commission the measuring device and must be followed in a set order. Before performing a specific production step, check whether all the previous steps have been completed accordingly →  67.



Warning!
Risk of electric shock!
Switch off the power supply before opening the device.



Caution!
Can damage the electronic of the device!
Only use batteries provided by Endress+Hauser.

1. Open the housing cover.
 - Release the four screws with a Phillips head screwdriver.
 - Lift the housing cover slightly and tip it to the left. Two flexible fasteners secure the housing cover to the housing.
2. Remove the battery cover.
 - Release the securing screw with a Phillips head screwdriver.
 - Turn the battery cover in a slightly clockwise direction to remove it (two guides which hold the battery cover in position are located on the right-hand side).
3. Insert the batteries.

Place the batteries into the compartment. In doing so, route the battery cables in the direction of the cable inlet in the battery cover →  30.

i If not all the batteries are inserted, the partition plate can be used to prevent any inserted batteries from becoming dislodged.

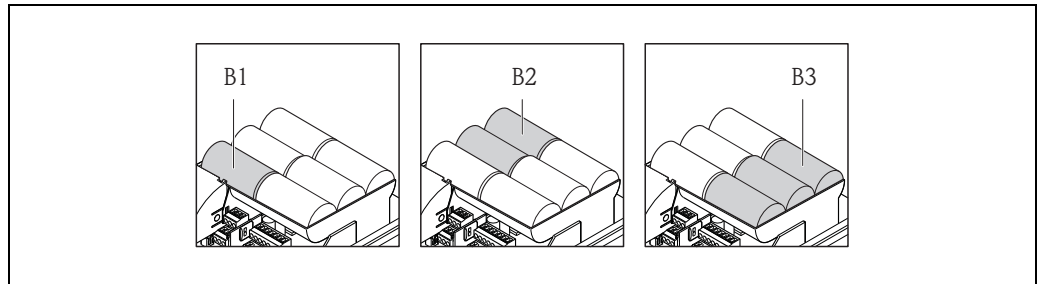



Fig. 29: Example of a battery arrangement (configuration 5)



B1 Battery connection to back up the power supply for the measuring device

B2 Battery connection to power the measuring device

B3 Battery connection to power the GSM/GPRS module

4. Connect the batteries.
 - Insert the battery cables into the appropriate receptacle →  30.
5. Set the DIP switches →  30.

The following options are available:

 - Set the DIP switch to ON to switch on the battery power supply.
If battery power supply is switched on, the red CPU LED flashes →  69 and the startup sequence appears on the onsite display →  69.
 - Set the DIP switch to OFF to switch off the battery power supply.

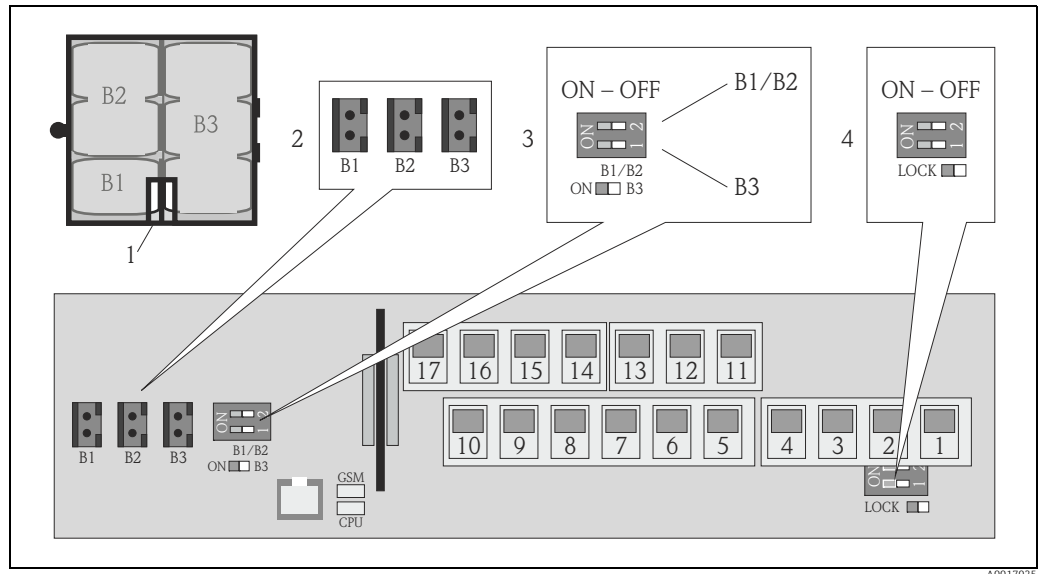



Fig. 30: Connecting the batteries, switching on the battery power supply

- 1 Cable inlet in the battery cover
- 2 Receptacles for terminals B1 and terminals B2 and B3
- 3 DIP switch (ON/OFF) for switching the batteries on and off:
 - Switch 1: terminals B3
 - Switch 2: terminals B1 and B2
- 4 DIP switch (ON/OFF) to disable the controls of the local display

6. Secure the battery cover.
 - Route the battery cables in the direction of the cable inlet in the battery cover → 30.
 - Fit the battery cover in place. In doing so, position the guides into the slots in the battery cover.
 - Tighten the securing screw with a Phillips head screwdriver.
 - Fold down the protective cover for the external power supply.
7. Secure the housing cover.
 - Fix the housing cover on the housing.
 - Tighten the four screws with a Phillips head screwdriver.

 Comply with instructions for battery disposal → 108.

7.4 Potential equalization



Warning!

Integrate the measuring system into the potential equalization system.

7.4.1 Potential equalization requirements

Please consider the following to ensure correct measurement:

- The fluid and sensor have the same electrical potential
- Company-internal grounding concepts
- Material and grounding of the pipes

7.4.2 Connection examples for potential equalization

Connection example in standard situations

Metal, grounded pipe

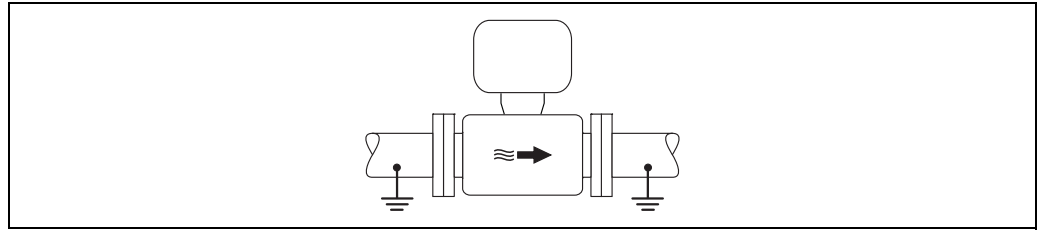

Fig. 31: Potential equalization via Measuring tube

A0016315

Connection example in special situations

Metal, ungrounded pipe without liner

This connection method is also to be used when:

- Potential equalization is not customary
- Equalizing currents are present

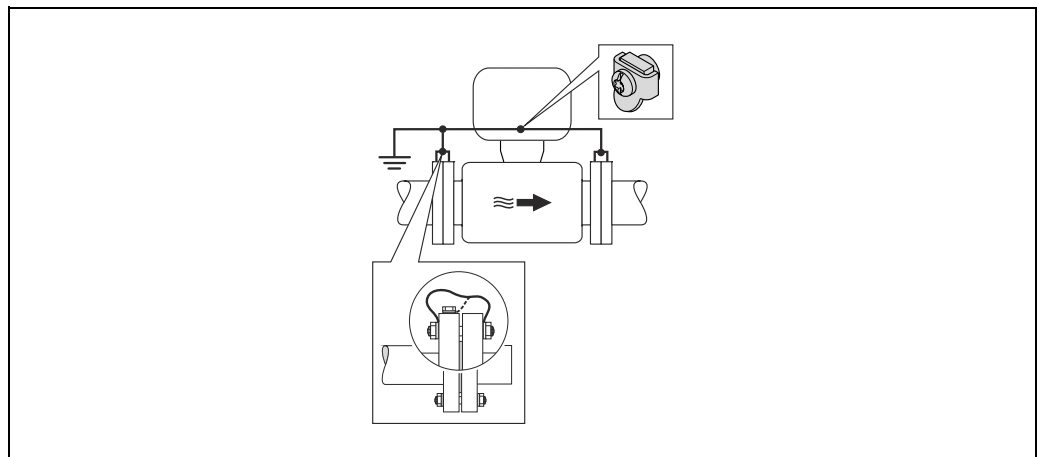

Fig. 32: Potential equalization via ground terminal and pipe flanges

A0022704

For mounting consider the following:

- Connect both sensor flanges to the particular pipe flange via a ground cable and ground them.
Ground cable = copper wire, at least 6 mm² (0.0093 in²).
- Connect the transmitter or sensor connection housing, as applicable, to ground potential by means of the ground terminal provided for the purpose. For mounting the ground cable:
 - Mount the ground cable directly on the conductive flange coating of the sensor with the flange screws.



For remote version: The ground terminal in the example refers to the sensor and **not** to the transmitter.



The required ground cable can be ordered from Endress+Hauser.

Plastic pipe or pipe with insulating lining

This connection method is also to be used when:

- Potential equalization is not customary
- Equalizing currents are present

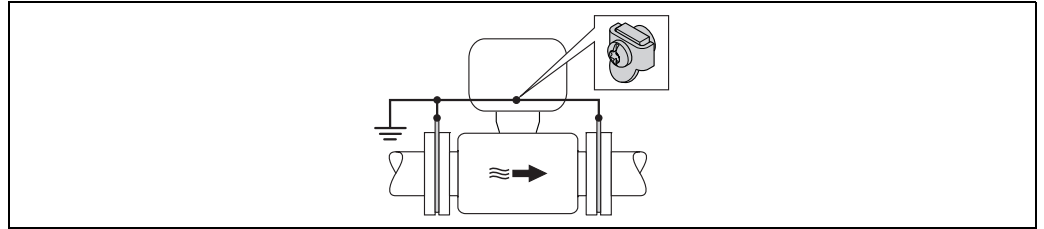

Fig. 33: Potential equalization via ground terminal and ground disk

For mounting consider the following:

The ground disks have to be connected to the ground terminal via a ground cable and to the ground potential. Ground cable = copper wire, at least 6 mm² (0.0093 in²).



For remote version: The ground terminal in the example refers to the sensor and **not** to the transmitter.



The required ground cable can be ordered from Endress+Hauser.

Pipe with cathodic protection

This connection method only take place, if both of the following requirements are fulfilled:

- Metal pipe without liner or pipe with electrically conductive liner
- Cathodic protection is integrated in the operator protection

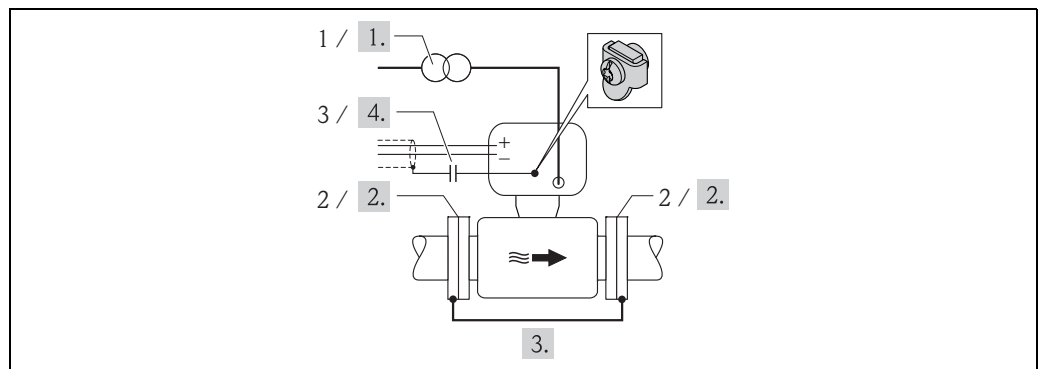

Fig. 34: Potential equalization and cathodic protection

- 1 Isolating transformer power supply
- 2 Electrically isolated to pipe
- 3 Capacitor

1. Connect the measuring device potential-free compared to protective earth to the power supply.
2. Install the measuring device electrically isolated in the pipe.
3. Connect the two flanges of the pipe with a ground cable. Ground cable = copper wire, at least 6 mm² (0.0093 in²).
4. By connecting the shielding of the signal cables a capacitor has to be used.



For remote version: The ground terminal in the example refers to the sensor and **not** to the transmitter.



The required ground cable can be ordered from Endress+Hauser.

7.5 Guaranteeing the degree of protection of the measuring device



Caution!

Do not loosen the threaded fasteners of the sensor housing, as otherwise the degree of protection guaranteed by Endress+Hauser no longer applies.

To guarantee the degree of protection of the measuring device → 115.

Perform the following steps after electrical connection:

- Check that the housing seals of the connection and electronics compartment are clean and fitted correctly. Dry, clean or replace the seals if necessary.
- Tighten all housing screws and screw covers.
- Firmly tighten the cable glands.
- To ensure that moisture does not enter the cable entry, route the cable so that it loops down before the cable entry ("water trap").

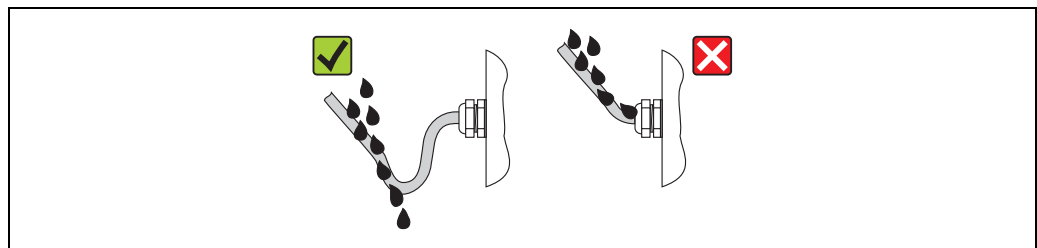

A0013960

Fig. 35: Cable looped down before the cable entry

- Insert dummy plugs into unused cable entries.
- Notes on measuring devices with IP68 option → 20.

7.6 Post-connection check

Is the measuring device undamaged (visual inspection)?	<input type="checkbox"/>
Do the cables used comply with the requirements?	<input type="checkbox"/>
Do the cables have adequate strain relief?	<input type="checkbox"/>
Are all cable glands installed, firmly tightened and correctly sealed? Cables looped as "water traps"?	<input type="checkbox"/>
Does the supply voltage match the specifications on the transmitter nameplate?	<input type="checkbox"/>
Is the ribbon cable for the display and operating module correctly routed in the housing?	<input type="checkbox"/>
Is the terminal assignment correct?	<input type="checkbox"/>
Is the GSM/GPRS antenna connected correctly?	<input type="checkbox"/>
Is the signal strong enough to establish a connection to a GSM/GPRS network?	<input type="checkbox"/>
Have the batteries been inserted and secured correctly?	<input type="checkbox"/>
Is the DIP switch set to the correct setting?	<input type="checkbox"/>
If power is supplied, is the measuring device ready for operation (the red LED is flashing) and does information appear on the display if an operating key is pressed for >1 second?	<input type="checkbox"/>
Are all housing covers installed and tightened with the correct tightening torque?	<input type="checkbox"/>

8 Operating options

8.1 Overview of operating options

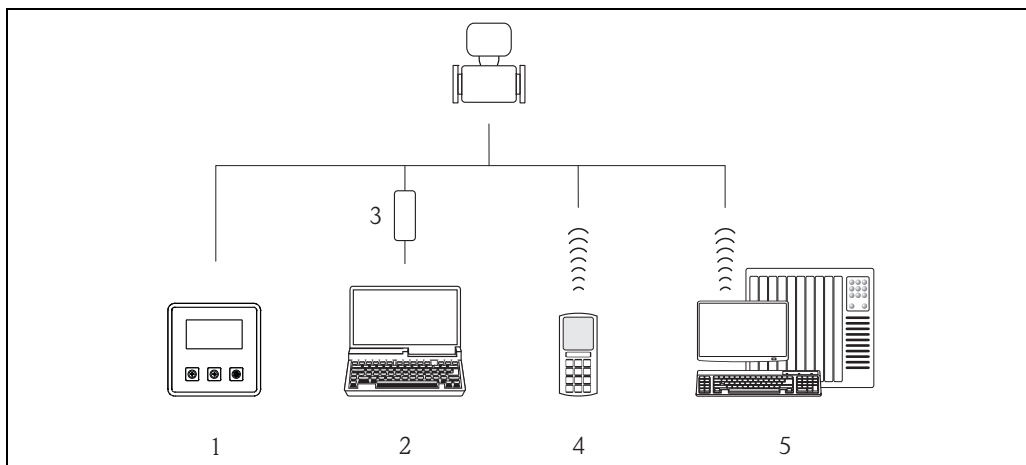

Fig. 36: Overview of operating options

- 1 Local operation of the measuring device
- 2 Computer with Config 5800 operating tool
- 3 FXA 291 service interface (connected to computer via USB port and to measuring device via service interface)
- 4 Cell phone (wireless via SMS)
- 5 Computer (wireless via mail)

8.2 Structure and function of the operating menu

8.2.1 Structure of the operating menu

- The measuring device has a main menu with different parameter groups. These parameter groups correspond to different applications or areas of the measuring device.
- The parameter groups contain the various parameters that belong to the individual applications or areas of the measuring device.
- The desired setting or option for the measuring device configuration is made in the individual parameters.
- Some parameters cannot be modified since they are only used to display values or information, or can only be modified by users with a higher access authorization level → 51.

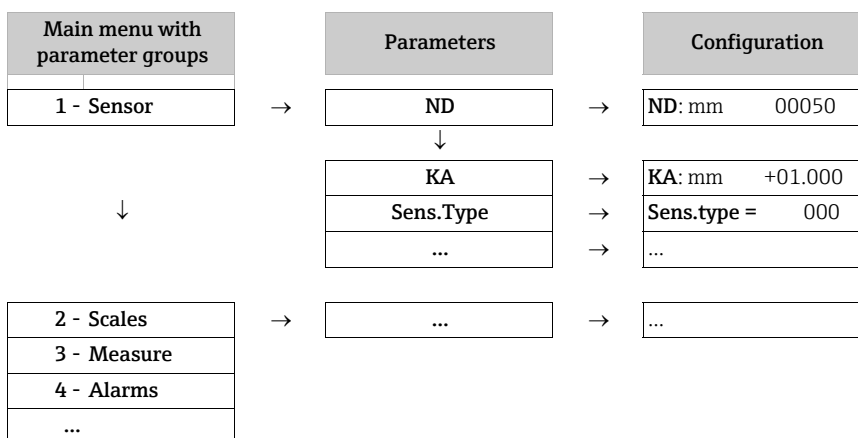

Note!
For an overview of the main menu and all the parameters available, see → 124 ff.

8.2.2 Operating concept

The parameters in the measuring device have different access levels. The parameters can be modified by all users or just by certain user groups depending on the associated access level. Some parameters can only be accessed via the Config 5800 operating tool.

- The parameters can be accessed via:
 - The local operation of the measuring device → 48
 - The Config 5800 operating tool → 51
- The majority of the parameters can be configured without any restrictions (up to Level 2). Special service-specific and device-specific parameters (Level 3 and above) can only be modified by Endress+Hauser Service staff.

 For further information on access authorization, see → 51.

8.3 Access to the operating menu via the onsite display

8.3.1 Operating elements and display area

The measuring device has three operating elements and one display area.

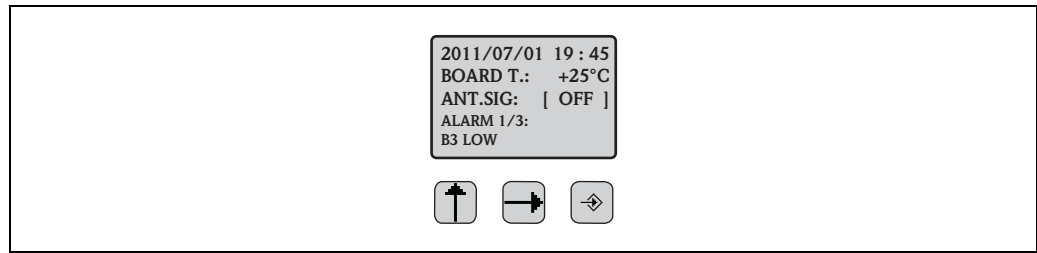





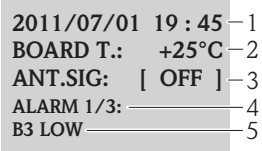
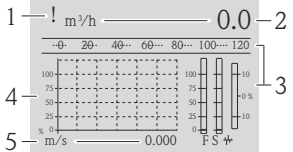
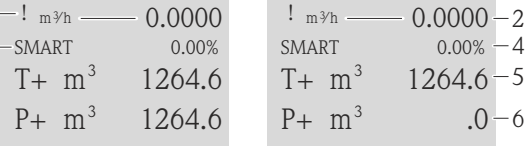
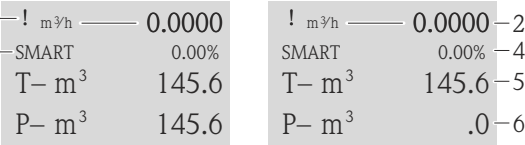
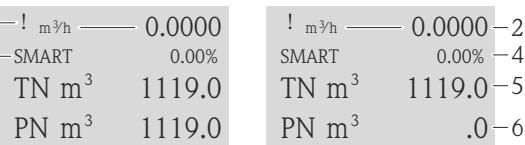
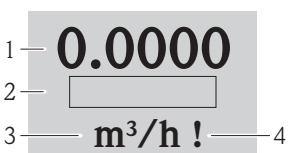

Fig. 37: Operating elements and display area of the measuring device

Operating elements

Key	Operation	Meaning
	Press briefly (<1 second)	<ul style="list-style-type: none"> ■ Scroll up through the parameters ■ Scroll up through the options ■ Increase the numerical values ■ If several alarms are active: scroll up through the alarm list
	Press and hold (>1 second)	<ul style="list-style-type: none"> ■ Scroll down through the parameters ■ Scroll down through the options ■ Decrease the numerical values ■ If several alarms are active: scroll down through the alarm list
	Press briefly (<1 second)	<ul style="list-style-type: none"> ■ Change the display area or the display values ■ Move the cursor to the right ■ Scroll down through the parameters
	Press and hold (>1 second)	<ul style="list-style-type: none"> ■ Change the display area or the display values ■ Move the cursor to the left ■ Scroll up through the parameters
	Press briefly (<1 second)	<ul style="list-style-type: none"> ■ Select the menu ■ Select the parameter ■ Confirm the entry, selection
	Press and hold (>1 second)	<ul style="list-style-type: none"> ■ Exit the current menu ■ Return to the main menu ■ Return to the display ■ Switch display on/off

Display area

Several measured value and status views are available in the display area. Users can switch between the individual views using the key → 50.

Views	Meaning
 <p style="text-align: right;">A0016981</p>	<ol style="list-style-type: none"> 1. Date and time 2. Temperature of electronics board 3. Status of antenna signal 4. Number of alarms (scroll through the alarm list via the V operating key → 48) 5. Description of displayed alarm
 <p style="text-align: right;">A0016982</p>	<ol style="list-style-type: none"> 1. Alarm status 2. Flow value with numeric representation (incl. unit) 3. Flow value with line and bar graph representation 4. Flow value (0 to 100 %) tracked as chart 5. Flow velocity including unit <p> Note! F (fast) + S (slow) = Filter</p>
 <p style="text-align: right;">A0020991</p>	<ol style="list-style-type: none"> 1. Alarm status 2. Flow value with numeric representation (incl. unit) 3. Profile of measured value acquisition → 135 4. Full scale value in % 5. Totalizer, positive (incl. unit)¹⁾ 6. Totalizer, positive (incl. unit)¹⁾
 <p style="text-align: right;">A0020992</p>	<ol style="list-style-type: none"> 1. Alarm status 2. Flow value with numeric representation (incl. unit) 3. Profile of measured value acquisition → 135 4. Full scale value in % 5. Totalizer, negative (incl. unit)¹⁾ 6. Totalizer, negative (incl. unit)¹⁾
 <p style="text-align: right;">A0020993</p>	<ol style="list-style-type: none"> 1. Alarm status 2. Flow value with numeric representation (incl. unit) 3. Profile of measured value acquisition → 135 4. Full scale value in % 5. Totalizer net (balance) (incl. unit)¹⁾ 6. Totalizer net (balance) (incl. unit)¹⁾
 <p style="text-align: right;">A0016986</p>	<ol style="list-style-type: none"> 1. Flow value with numeric representation (incl. unit) 2. Bar graph full scale value in % 3. Flow value unit 4. Alarm status
 <p style="text-align: right;">A0016987</p>	<ol style="list-style-type: none"> 1. State of charge of battery in terminal B1 2. State of charge of battery in terminal B2 3. State of charge of battery in terminal B3

1) T+ and P+, T- and P- as well as TN and PN have each the same values. It is e.g. possible to reset P+, P- as well as PN periodically to 0, while the values T+, T- as well as TN are preserved.

8.3.2 Changing the views in the display area

Users can switch between the individual views using the  key →  48.

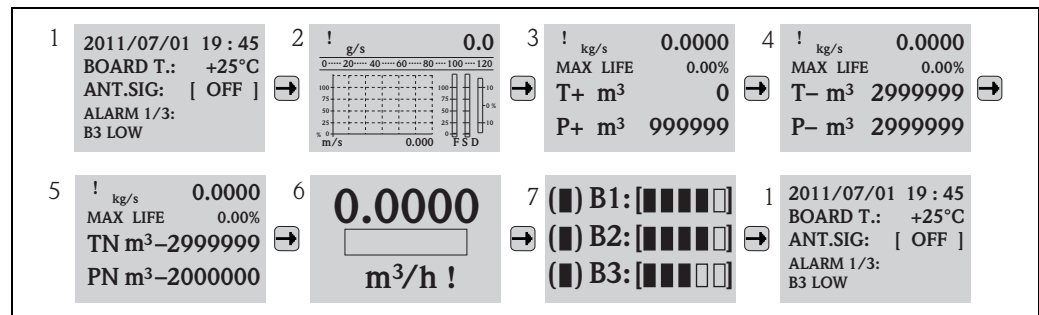

















Fig. 38: Changing the views

Locking the view toggle function

1. Select the desired display using the  key.
2. Use the  key to switch to the main menu.
3. Switch to parameter group "8-DISPLAY", go to the "Disp.lock" parameter and select the option "ON" →  150.

8.3.3 Changing parameters

1. Press and hold the  key for 2 seconds and then release.
 - ✓ The device leaves the standby mode and the measured value or status display screen appears.
2. Press  once.
 - ✓ The main menu is displayed.

 **Note!**
The Quick Start menu is displayed during initial commissioning or if the "Quick start" parameter (QSTME →  150) is set to ON (default value). In such instances, use  to select the "Main menu" option and enter the main menu.
3. Press  to select the desired parameter group.
4. Press  to confirm the selection.
 - ✓ The parameter group is called up.
5. Press  to select the desired parameter.
6. Press  to confirm the selection.
 - ✓ The parameter is displayed.
7. Use  to change the option selected or the value.
 -  **Note!**
In the case of some parameters, it is possible to make several settings within the parameter (example Tot1MU →  133).
8. Press  to confirm the selection.
 - ✓ The option or value selected is accepted.

 For information on access authorization to parameters, see →  51.

8.3.4 User roles and related access authorization

Access to parameters

The parameters in the measuring device have different access levels. The majority of the parameters can be configured without any restrictions (up to Level 2).

 Level 2 parameters can be protected by an individual password →  62.

Special service-specific and device-specific parameters (Level 3 and above) can only be modified by Endress+Hauser Service staff. These parameters can be read by every user, however. The parameters have a **gray** background in the description of the device parameters (see Appendix).

 If a user attempts to change a service-specific or device-specific parameter, the prompt "L3 Code =0..." appears on the onsite display. If using the Config 5800 operating tool, the error message "5:Access error" appears on the display.

Access to parameters that are only available via the Config 5800 operating tool

The parameters in parameter groups 0 "Quick-Start" to 11 "Internal Data" can be configured both via local operation and via the parameter menu of the operating tool. The parameters in the parameter groups "GRPS data", "Auxiliary cmds" and "Process data" can **only be configured via the parameter menu** of the operating tool →  58.

 Parameter groups that are used to configure or establish communication via the GSM/GPRS modem are only available via the Config 5800 operating tool.

Custody transfer (optional):

After putting the device into circulation or after sealing the device, operation via the onsite display, via the Config 5800 software operating tool or via GSM/GPRS is only possible to a limited extent.

8.3.5 Enabling and disabling the keypad lock

The keypad lock allows you to disable access to the entire operating menu via local operation. This makes it no longer possible to navigate through the operating menu or modify the values of individual parameters. Only the measured values on the measured value display can be read off. The keypad is locked using the DIP switches on the electronics board →  89.

8.4 Access to the operating menu via the operating tool

8.4.1 Config 5800 operating tool

Config 5800 is a software operating tool which is used to configure and operate the Promag 800 measuring device. The measuring device does not support any other operating tools.

Function scope

- Access to all the measuring device parameters:
 - Via the user interface integrated in the operating tool
 - Via the parameter menu
- Configuring/establishing measuring device communication via GSM, mail etc. These parameters are only available via the parameter menu of the operating tool.
- Operation of the measuring device.
- Saving or exporting data records (parameters, events etc.).

- Saving or loading the configuration of the measuring device.

How to acquire the Config 5800 operating tool

- CD-ROM (in the scope of delivery)
- www.endress.com → Download

8.4.2 Installing the Config 5800 operating tool

PC oder laptop requirements

- Intel® i486® or Pentium→ processor
- Microsoft Windows 2000®, Windows XP®, Windows Vista® or Windows 7→
- 32 MB RAM
- 10 MB free space on the hard drive
- CD-ROM drive
- USB port

Installing the Config 5800 operating tool



Note!

- If an earlier version of the software is already installed:
Uninstall the earlier version before installing the latest version of the software.
 - Install all the software components.
1. Close all the applications.
 2. Insert the CD-ROM into the drive.
 3. Follow the instructions in the dialog boxes.

8.4.3 Connecting the laptop to the measuring device

Hardware and software required

- Commubox FXA291 service interface (USB version)
- Laptop with Config 5800 operating tool installed → 51

Connecting the laptop

1. Open the housing cover of the measuring device.
 - Release the four screws with a Phillips head screwdriver.
 - Lift the housing cover slightly and tip it to the left.
Two flexible fasteners secure the housing cover to the housing.
2. Switch on the measuring device → 69.



The measuring device must be switched on and successfully started (the CPU LED is flashing (red)) before you connect the Commubox FXA291 → 69).

3. Connect the Commubox FXA291.
 - Via the USB port on the laptop
 - Via the service interface on the measuring device.

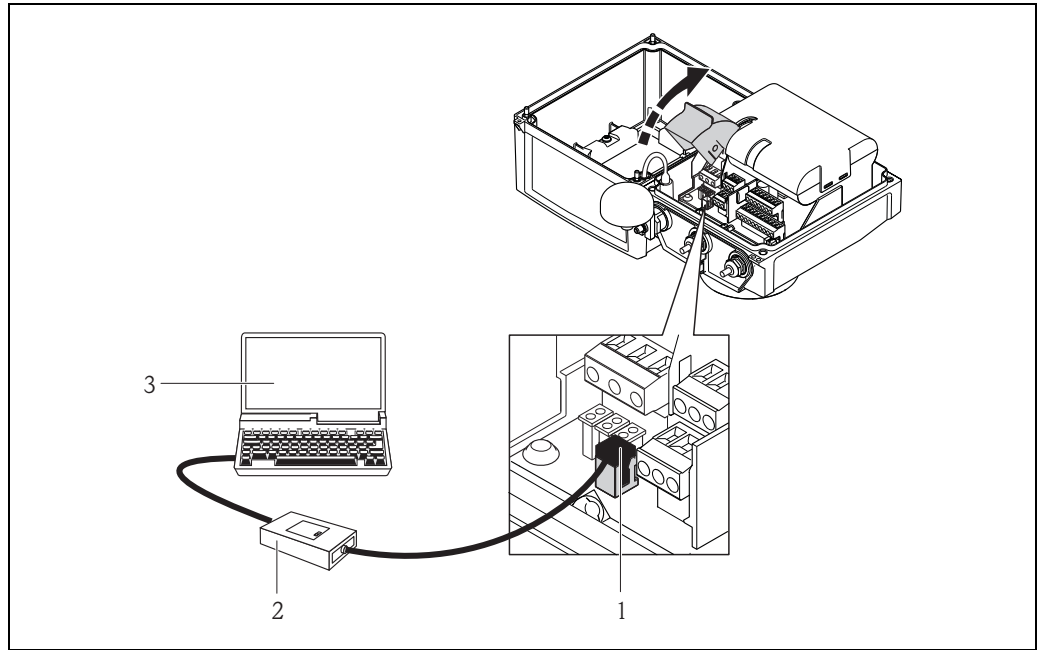

Fig. 39: Connecting a laptop to the service interface via Commubox FXA291

- 1 CDI interface of the measuring device
- 2 Commubox FXA291 (USB version)
- 3 Laptop with Config 5800 operating tool installed

4. Start the Config 5800 operating tool and establish communication with the measuring device → 53.

8.4.4 Starting the Config 5800 operating tool

Start the operating tool by clicking on the Config 5800 icon on the desktop.

8.4.5 Establishing communication between Config 5800 and the measuring device



Fig. 40: Config 5800 user interface

- 1 Fading in/out the information/settings for the interface

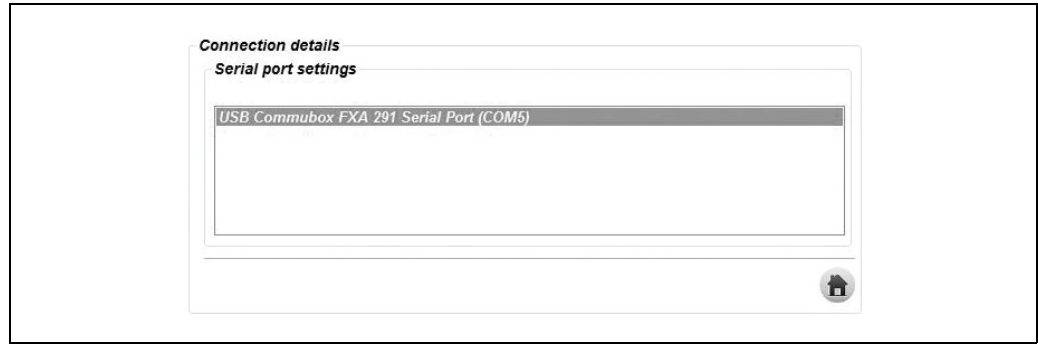

Fig. 41: Information/settings for the interface



Note!

If communication is not established successfully, the COM port must be determined via the Device Manager of the connected laptop and then assigned manually:

1. Via the Device Manager, determine the COM port used for the connected "USB Commubox FXA291 Serial Port".

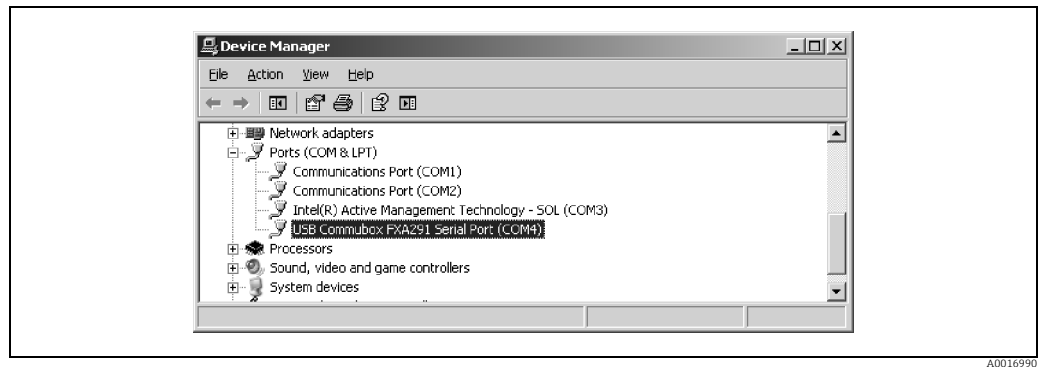

Fig. 42: Example of the Device Manager

2. From the picklist, select the COM port found.

8.4.6 Config 5800 user interface

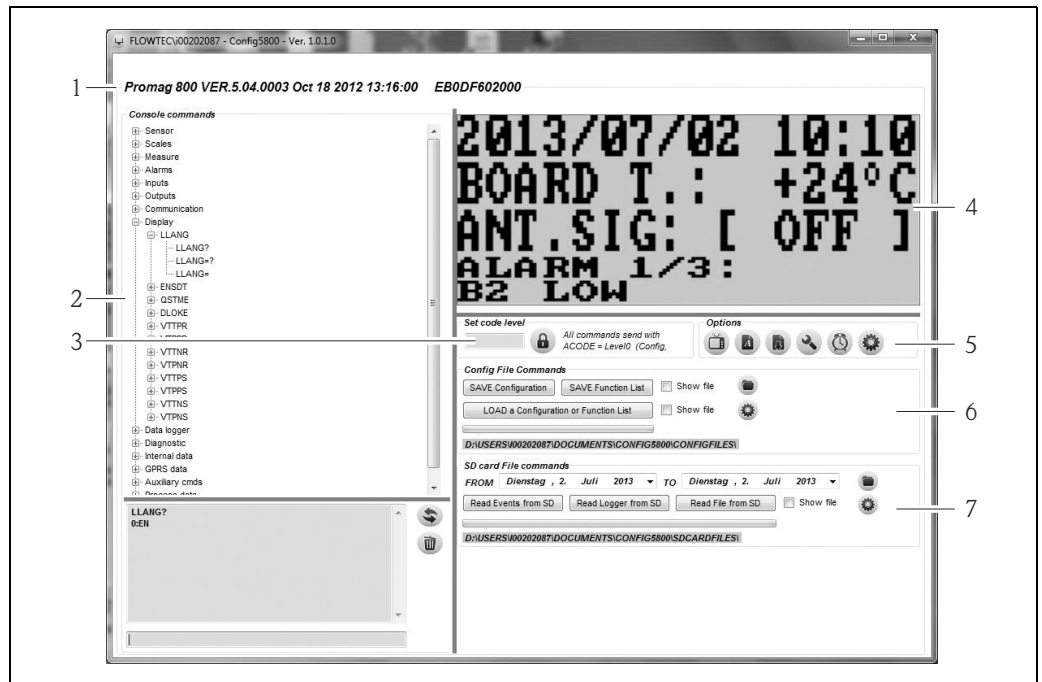

Fig. 43: Config 5800 user interface

Sections of the user interface:

- 1 Device information display (name of the measuring device, firmware version, E+H serial number)
- 2 Parameter menu, display field and input box
- 3 Password entry box
- 4 Integrated user interface (corresponds to the onsite display)
- 5 Function menu
- 6 Save or load configuration and parameters (laptop ↔ measuring device)
- 7 Load event or process data from the data logger (SD card) (measuring device → laptop)

Function menu

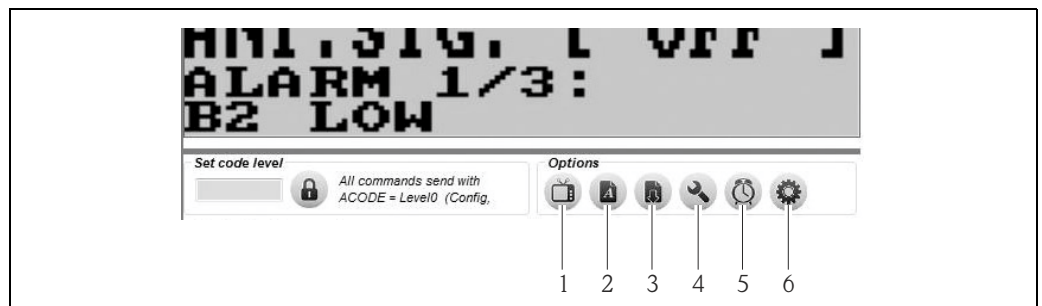

Fig. 44: Config 5800 user interface: function menu

- 1 Function to display and hide the integrated user interface
- 2 Function to display and hide the parameter menu
- 3 Function to update the parameter menu
- 4 Function to display and hide the information and settings relating to the interface
- 5 Function to synchronize the measuring device with the system time of the laptop
- 6 Function to adjust the size of the individual windows

Adjusting the user interface

The user interface can be adjusted individually using the mouse. However, please note that areas can be covered over and might not be available directly in the adjusted view. The changes are retained when the operating tool is restarted.

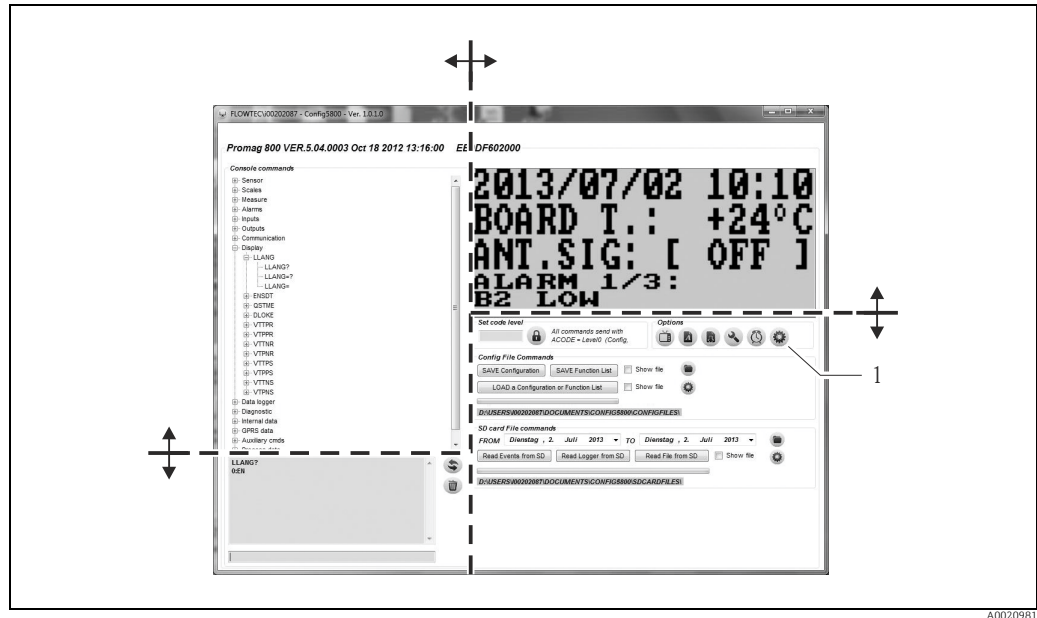

Fig. 45: Adjusting the user interface
 1 Function to adjust the size of the individual windows

8.4.7 Selecting parameters

The following options for selecting device parameters are available in the operating tool:

- Parameter selection via the integrated user interface (corresponds to the onsite display)
- Parameter selection via the tree structure view

Selecting parameters via the integrated user interface

The operating tool has an integrated user interface. All the functions, views and parameters of this user interface correspond to the onsite display.

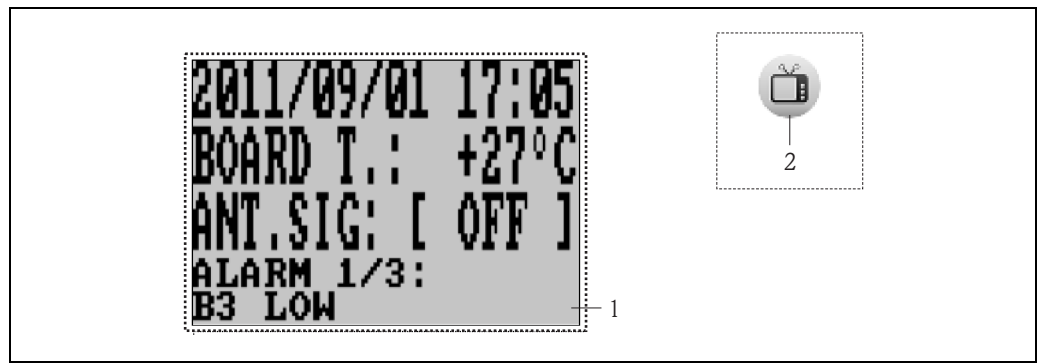







Fig. 46: Config 5800 user interface: integrated user interface
 1 Integrated user interface (corresponds to the onsite display)
 2 Button: display and hide the integrated user interface
 (the button is located around the function menu on the user interface → 55)

Selecting parameters

Parameters are selected and the device parameters configured in the integrated user interface via the following keys on the computer keyboard:

Key		Meaning
	Arrow up	<ul style="list-style-type: none"> ▪ Scroll up through the parameters ▪ Scroll up through the options ▪ Increase numerical values ▪ If several alarms are active: scroll up through the alarm list
	Arrow down	<ul style="list-style-type: none"> ▪ Scroll down through the parameters ▪ Scroll down through the options ▪ Decrease numerical values ▪ If several alarms are active: scroll down through the alarm list
	Arrow right	<ul style="list-style-type: none"> ▪ Change the display format or the display values ▪ Move the cursor to the right ▪ Scroll down through the parameters
	Arrow left	<ul style="list-style-type: none"> ▪ Change the display format or the display values ▪ Move the cursor to the left ▪ Scroll up through the parameters
	Enter	<ul style="list-style-type: none"> ▪ Select the menu ▪ Select the parameter ▪ Confirm the entry, selection
	Escape or Delete	<ul style="list-style-type: none"> ▪ Exit the current menu ▪ Return to the main menu ▪ Return to the display

Selecting parameters in the tree structure view

The tree structure displays all the parameter groups currently available and the associated parameters.

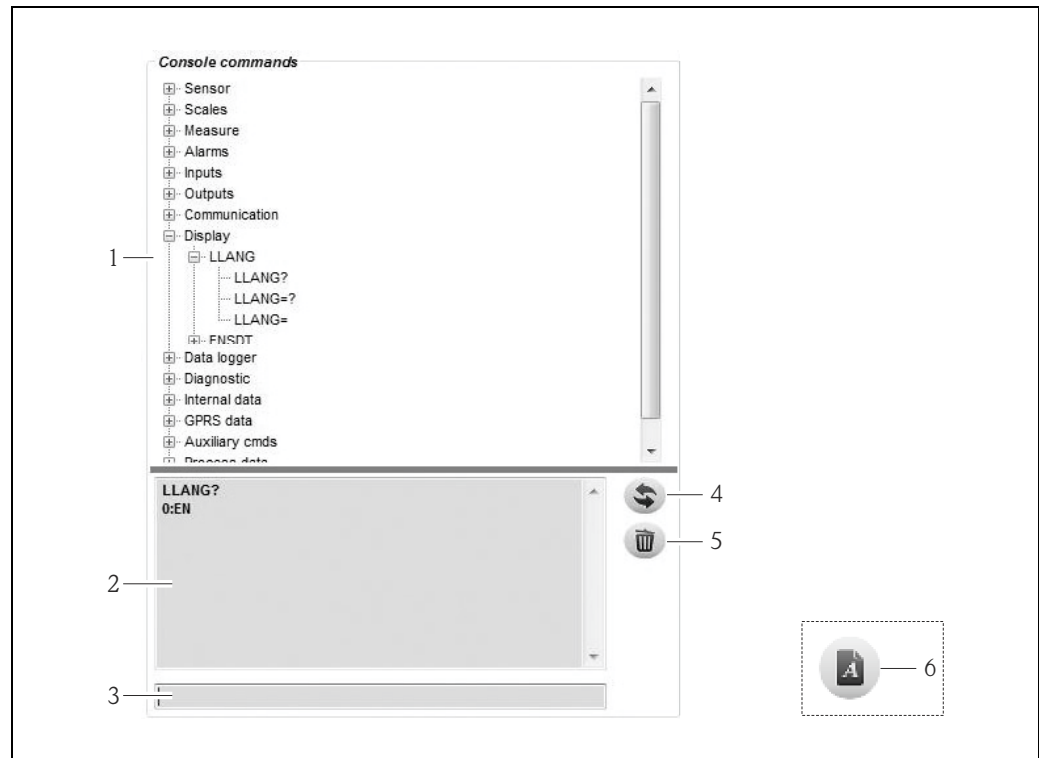

Fig. 47: Config 5800 user interface: parameter menu as tree structure

- 1 Parameter menu
- 2 View box
- 3 Input box
- 4 Function to list the parameters/main menu alphabetically
- 5 Key to clear view box
- 6 Button: display and hide parameter menu
(the button is located around the function menu on the user interface → 55)

Selecting parameters

- The parameters in the parameter group are displayed by double-clicking a parameter group or by clicking [+].
- The substructure of the parameter is displayed by double-clicking a parameter or by clicking [+].
- The set value or the configuration options of the parameter are displayed in the left display area by double-clicking a parameter. The following options are available:
 - Parameter with "?": the parameter value currently set is displayed.
 - Parameter with "=?": the possible configuration options of the parameter are displayed.
 - Parameter "=": the parameter settings can be edited.

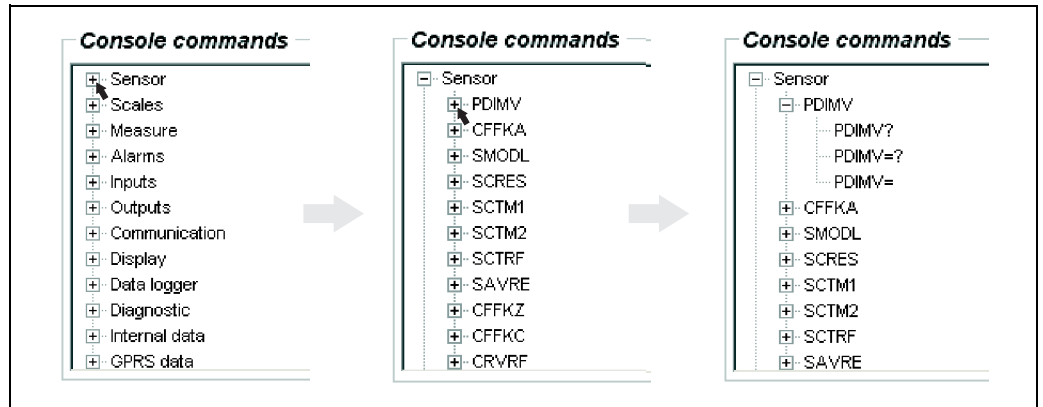

Fig. 48: Example: parameter signs for the PDIMV parameter

Clearing entries in the view box

All the queries and entries made are displayed in the view box. These entries can be deleted via the "Clear text results" button.

8.4.8 Changing parameters

Changing parameters via the integrated user interface

Example: changing the pulse value from 1000 g to 0.8 kg

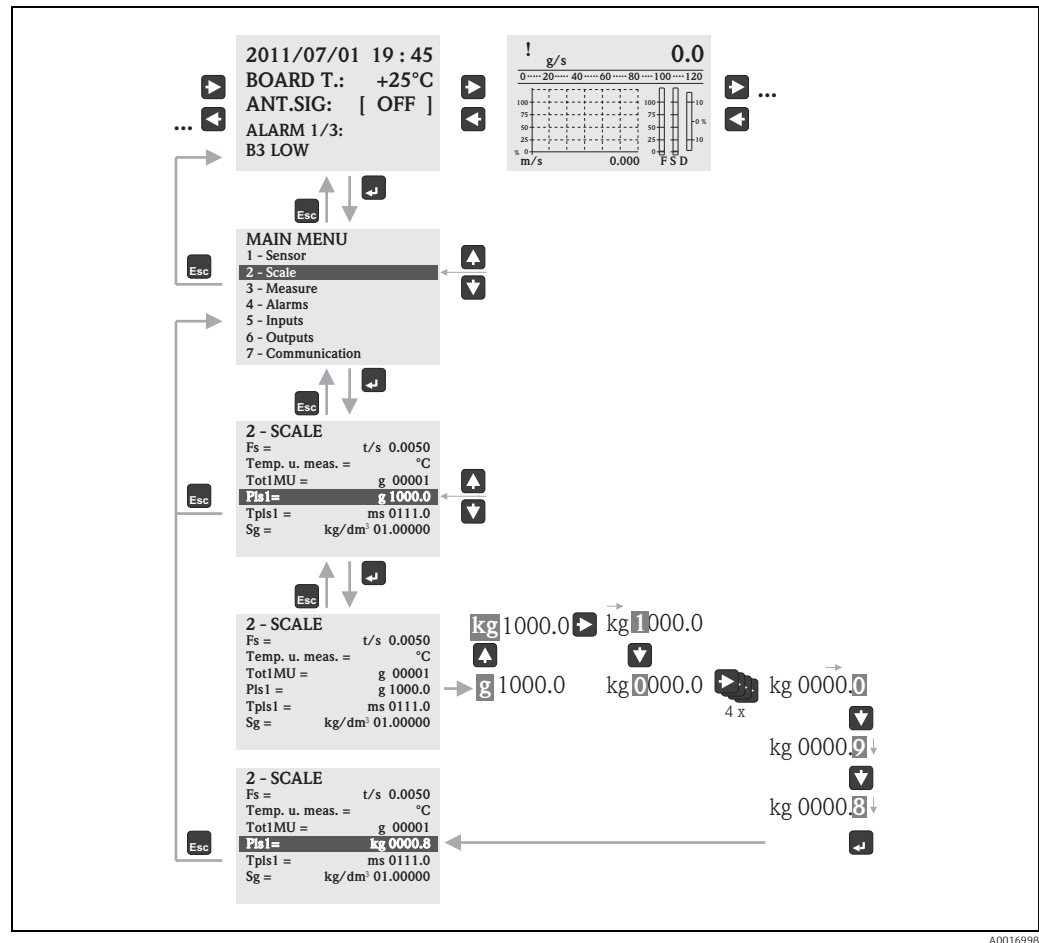

A0016998



Note!

The Quick Start menu is displayed during initial commissioning or if the "Quick start" parameter (QSTME → 150) is set to ON (default value). In such instances, select the "Main menu" option to enter the main menu.

Changing parameters via the parameter menu

Changing a numerical value in a parameter

Example: changing the nominal diameter from DN 25 to DN 125

1. Double-click the "Sensor" parameter group.
 - ✓ The parameters in the "Sensor" parameter group are displayed.
2. Double-click the "PDIMV" parameter (nominal diameter).
 - ✓ The substructure of the parameter opens.
3. Double-click "PDIMV?".
 - ✓ The current value for the nominal diameter is displayed in the view box: 25 (mm)
4. Double-click "PDIMV=?".
 - ✓ The possible input range is displayed in the view box: 0 <>10000 (mm)

5. – Double-click "PDIMV=".
 - ✓ The input box shows the prompt: PDIMV=
 - In the input box, enter the value 125 after "PDIMV=" (PDIMV=125).
6. Press **E** to confirm the value entered.
 - ✓ The correct entry PDIMV=125 is confirmed in the view box: 0:OK.

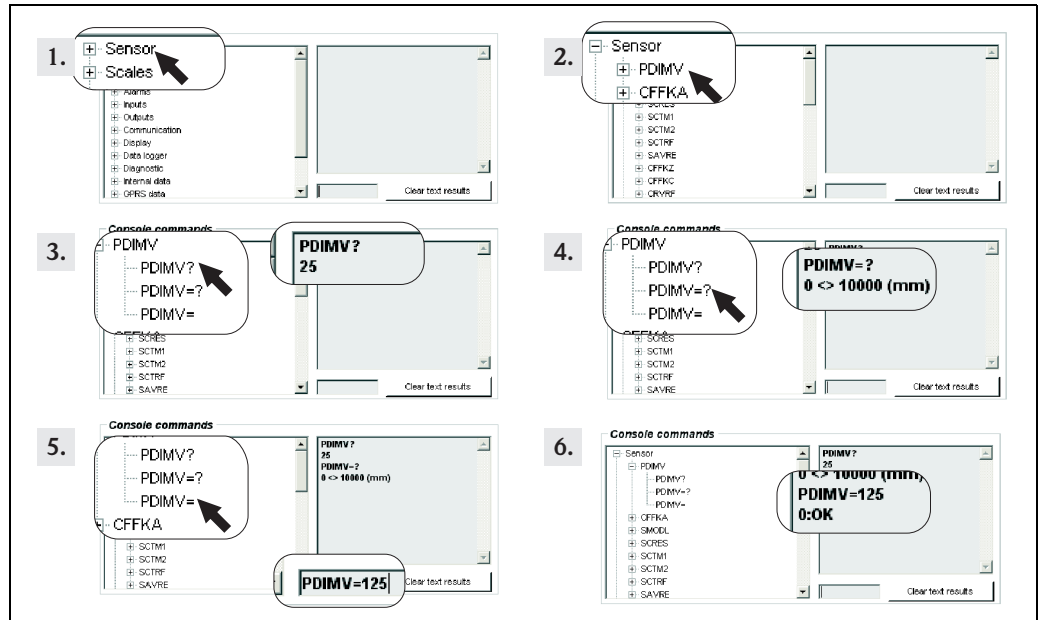

Fig. 49: Example for PDIMV parameter: changing the nominal diameter from DN 25 to DN 125



Note!

If no value is entered in the input box and **E** is pressed, the value "0" is accepted.

Changing an option selected in a parameter

In the case of picklists, the value corresponding to the option must be entered.

Example: changing the language

1. Double-click the "Display" parameter group.
 - ✓ The parameters in the "Display" parameter group are displayed.
2. Double-click the "LLANG" parameter (language).
 - ✓ The substructure of the parameter opens.
3. Double-click "LLANG?".
 - ✓ The current language is displayed in the view box "2:FR" (French)
4. Double-click LLANG=?
 - ✓ The picklist appears in the view box "0:EN, 1:IT, 2:FR, 3:SP"
5. – Double-click "LLANG="
 - ✓ "LLANG=" appears in the input box.
 - In the input box, enter the value 0 after "LLANG=" (LLANG=0).
6. Press **E** to confirm the value entered.
 - ✓ The correct entry is confirmed in the view box: 0:OK.
7. Double-click "LLANG?".
 - ✓ The new language is displayed in the view box "0:EN" (English)



Note!

If the value entered is invalid, the error message "2:PARAM ERR" appears on the display.

8.4.9 Access authorization

All the parameters in the operating tool are assigned a certain level. Level 2 parameters can be protected by a password in order to prevent unauthorized persons from modifying the device configuration.

Parameter levels

- Level 1 parameters:
Read and write access without entering a password
- Level 2 parameters:
Write access can be protected by defining a password; read access without password entry.
- Level 3 parameters and higher (special service-specific and device-specific parameters):
Write access only for Endress+Hauser Service staff; read access without password entry. These parameters have a gray background in the parameter description → 130. The message "L3 Code =0..." or "5:ACCESS ERR." appears on the display if a user attempts to change these parameters.

Assigning a password for Level 2 parameters

Assigning a password via local operation

Enter a numerical password, with a maximum of six digits, in the "L2 code" parameter → 158.

The following options are available:

- Password = numeric six-digit password: write access only by entering a password
- Password = 000000 (factory setting): write access without entering a password

Assigning a password via the Config 5800 operating tool

Enter a numerical password, with a maximum of six digits, in the "L2ACD" parameter → 158.

The following options are available:

- Password = numeric six-digit password: write access only by entering a password
- Password = 000000 (factory setting): write access without entering a password



Note!

If you forget the password, it is **not** possible to simply reset the password! Contact your Endress+Hauser Sales Center if you lose or forget the password.

Access to parameters with password assigned

Access to parameters via the onsite display and integrated user interface of the operating tool

When a Level 2 parameter is accessed, the user is prompted to enter the password. The parameter can be changed as soon as the password is entered.

Access to parameters via the parameter menu of the operating tool

When a Level 2 parameter is accessed via the parameter menu of the operating tool → 58, an error message appears in the view box. The password must first be entered in the "Set code level" input box before you can change Level 2 parameters. The password is displayed in the ACODE parameter → 163 and saved until the next time it is changed via "Set code level".

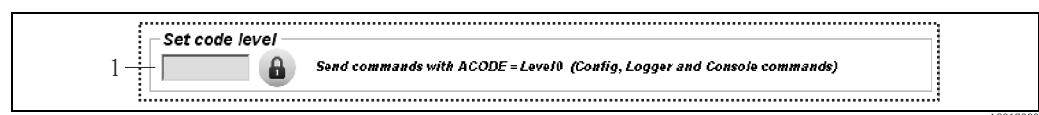

Fig. 50: Config 5800 user interface: entering a password to access Level 2 parameters via the parameter menu



1 Input box

Enter the value 000000 in the "Set code level" input box to reset access.

8.4.10 Saving and loading the configuration and parameters

The configuration and the parameters of the measuring device can be saved as a file on a laptop via the operating tool. Conversely, a file containing a configuration and the parameters can be uploaded from a laptop to the measuring device via the operating tool.

The file is saved as a text file and can be opened in a text editor.

 This function is only available once the system times have been synchronized. Synchronization via the button in the function menu (No. 5 →  55).

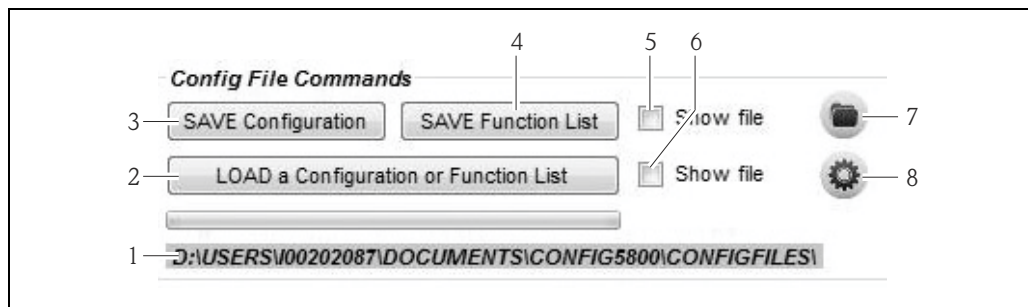

Fig. 51: Config 5800 user interface: saving or loading the configuration and parameters

- 1 Displays the directory path of the saved files
- 2 Load the configuration or parameters
- 3 Save the configuration (measuring device → laptop); the file name can be changed if necessary
- 4 Save the parameters (measuring device → laptop); the file name can be changed if necessary
- 5 Option for opening a file after saving it
- 6 Opens the directory with the saved files
- 7 Option for opening a file after loading it
- 8 Change the file directory for saving and loading

Configuration file

Possible applications

- Save the configuration of the measuring device to restore the settings to a known configuration (e.g. after replacing the electronics or changing the configuration).
- Transfer the configuration to other measuring devices in order to use the same configuration.
- Offline configuration of the measuring device in order to make changes directly in the .txt file and then upload the new configuration to the measuring device.



Caution!

When uploading the configuration file to a measuring device, make sure that the data in the parameters are suitable for the measuring device. Values such as the nominal diameter, calibration factor, zero point etc. must be appropriate for the measuring device. If a configuration file with incorrect values is uploaded to a measuring device, this can result in incorrect measurements and damage the measuring device!

Using a configuration file

1. Save the configuration of a measuring device to a file via "Save Configuration". Change the file name where necessary.

Recommended file naming convention: xx_DNyy.txt

(xx = serial number of the measuring device, yy = nominal diameter of the measuring device)

2. Change the configuration file where necessary, e.g. if uploading to other measuring devices:
 - Leave parameters that are to be used for other measuring devices in the file and change them where necessary
 - Delete parameters that are not used for other measuring devices
 - Adapt or delete parameters with device-specific values (e.g. nominal diameter, calibration factor etc.)

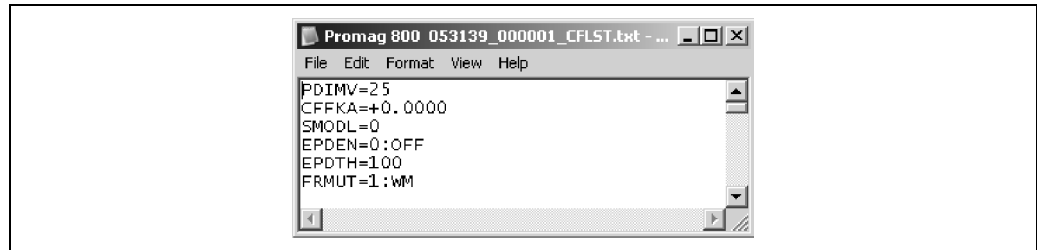

Fig. 52: Configuration file

3. Save the changes made in the configuration file.
4. Upload the configuration file to a measuring device via "Load a Configuration or Function List".



Caution!

Before loading the configuration file make sure that the serial number and the nominal diameter information in the configuration file matches the information in the measuring device.

- Serial number: parameter SRNUM (Config 5800) → ⓘ 159
- Nominal diameter: parameter ND (onsite display)/PDVIM (Config 5800) → ⓘ 130

- ✓ The values of the parameters in the file are transferred to the measuring device.
- ✓ All other measuring device parameters remain unchanged.

Parameters as list

Possible applications

For displaying a list of the parameters of the measuring device to get an overview of all the parameters available in the measuring device. The list displays the parameter names of the onsite display and the Config 5800 operating tool.

8.4.11 Loading event and process data from the data logger (SD card)

Event data (access to the measuring device, alarms etc.) and process data (measured values, status of the measuring device etc.) can be saved on a data logger in the measuring device (2 GB SD card).

If data logging is enabled (Acquisition parameter, DLOGE → ⓘ 152), the process data are recorded and written to a file every day. It is possible to specify the time and the recording interval for saving the process data → ⓘ 171.

Parameter group "9 Data logger" is used to specify which process data (parameters) are saved → ⓘ 151.

The event and process data can be uploaded from the data logger (SD card) to a laptop.

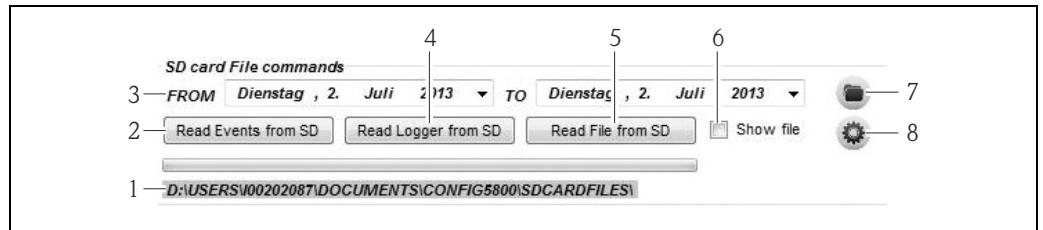

Fig. 53: Config 5800 user interface: reading data from data logger (SD card)

- 1 Displays the directory path of the saved files
- 2 Load file with event data (measuring device → laptop)
- 3 Selection of the time frame
- 4 Load file with process data (measuring device → laptop)
- 5 Read file
- 6 Option for opening the file immediately after saving
- 7 Opens the directory with the saved files
- 8 Respecify the folder in which the files are saved/loaded

Loading event data from the data logger (SD card)

1. Click the "Read Events from SD" button.
✓ An input window opens.
2. Via the date in the file name, specify the day for which the event data should be loaded → 54. Then press "OK" to confirm.
✓ The file with the event data is loaded in .TXT format.



An error message is displayed if no event data are available for the selected date.

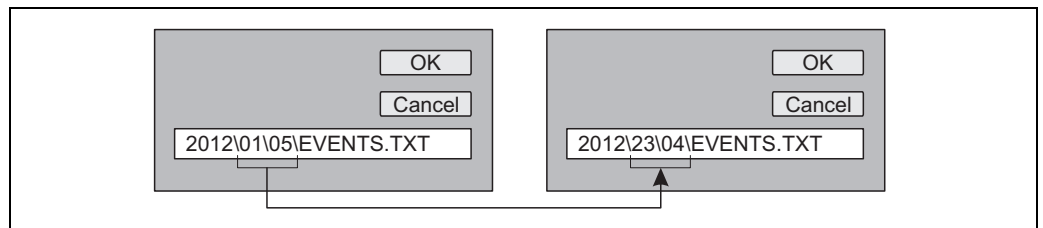

Fig. 54: Via the file name, specify the day for which the event data should be loaded.
Example: if the file name is changed from 01\05 to 23\04, the event data from April 23, 2012 are loaded

3. Click the "View PC file folder" button.
✓ The directory in which the file was saved opens.
4. Select and open the event data file.
✓ The file is opened in .TXT format.



If the "Show File" option is enabled (→ 53, No. 4), the file with the event data is automatically opened once it is loaded.

5. Evaluate the event data.

Loading process data from the data logger (SD card)

1. Click the "Read Logger from SD" button.
✓ An input window opens.
2. Via the date in the file name, specify the day for which the process data should be loaded. Then press "OK" to confirm.
✓ The file with the process data is loaded in .CSV format.



An error message is displayed if no process data are available for the selected date.

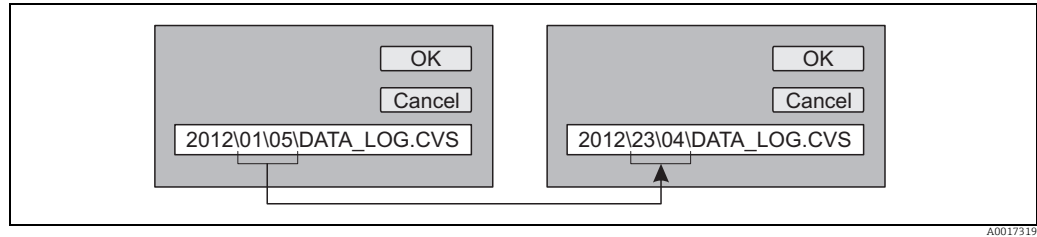





Fig. 55: Via the file name, specify the day for which the process data should be loaded.
 Example: if the file name is changed from 01\05 to 23\04, the process data from April 23, 2012 are loaded

3. Click the "View PC file folder" button.
 - ✓ The directory in which the file was saved opens.
4. Select and open the process data file.
 - ✓ The file is opened in .CSV format.
 - i** If the "Show File" option is enabled (→  53, No. 4), the file with the process data is automatically opened once it is loaded.
5. Import the .CSV file into a spreadsheet program, such as MS Excel. When importing the file, pay attention to the delimiter used (comma or semicolon).
 - i** The delimiter used in the .CSV can be configured in the Separator parameter, DLFSC →  155.
6. Evaluate the process data. For the file structure, see →  85.
 - i** The imported file with the process data does not have any headers. If the process data are loaded and evaluated more frequently, it can be helpful to add headers manually to the file. In this way, this file can always be used as an import template since the structure (columns used →  85) is always identical.

9 Commissioning

9.1 Commissioning with the GSM/GPRS modem

Prerequisites for commissioning the measuring device:

- The measuring device has been installed and the GSM/GPRS antenna connected. All the criteria of the post-installation check are met → [☰ 30](#).
- Wiring is completed. Batteries are inserted, external power supply is connected (optional). All the criteria of the post-connection check are met → [☰ 46](#).

9.1.1 Commissioning the measuring device



It is only possible to commission the measuring device with the GSM/GPRS modem using the Config 5800 operating tool. Not all the parameters required are accessible via local operation.

1. Insert the SIM card → [☰ 68](#).
2. Connect the laptop via FXA291 to the service interface of the measuring device → [☰ 52](#).
3. Start the Config5800 operating tool → [☰ 53](#).
4. Synchronize the system time between the measuring device and the laptop → [☰ 55](#), → [☒ 44 \(No. 5\)](#)
5. Configure GPRS communication → [☰ 72](#).
6. Configure SMS communication → [☰ 70](#).
7. Configure e-mail communication (sending) → [☰ 74](#).
8. Configure e-mail communication (receiving) → [☰ 80](#).
9. Configure the synchronization time with the server → [☰ 80](#).
10. Make other device-specific settings.
Parameter descriptions → [☰ 124 ff.](#)
11. After configuring, disconnect the laptop and FXA291 from the measuring device.
12. Fit the housing cover back on.

9.2 Commissioning without the GSM/GPRS modem

Prerequisites for commissioning the measuring device:

- The measuring device has been installed. All the criteria of the post-installation check are met → [☰ 30](#).
- Wiring is completed. Batteries are inserted, external power supply is connected (optional). All the criteria of the post-connection check are met → [☰ 46](#).

9.2.1 Commissioning the measuring device via local operation

1. Switch on the measuring device:
 - Via the DIP switch if power is supplied by batteries → [☰ 43](#) (→ [☒ 30](#)).
 - Then fit the housing cover back on.
 - Via the external power supply switch if power is supplied externally (optional).
2. Configuration of the measuring device via the onsite display → [☰ 51](#).
Parameter descriptions → [☰ 124 ff.](#)

9.2.2 Commissioning the measuring device via the Config 5800 operating tool

1. Connect the laptop via FXA291 to the service interface of the measuring device → 52.
2. Start the Config5800 operating tool → 53.
3. Synchronize the system time between the measuring device and the laptop → 55, → 44 (No. 5)
4. Configuration of the measuring device via the Config5800 operating tool → 51. Parameter descriptions → 124 ff.
5. After configuring, disconnect the laptop and FXA291 from the measuring device.
6. Fit the housing cover back on.

9.3 Inserting the SIM card

A SIM card must be inserted in the measuring device before it can establish wireless communication.



The SIM card must **not** be protected by a PIN number. Insert the SIM card into a cellular phone to check whether it is possible to access the card without entering a PIN number. If necessary, disable PIN entry for the SIM card via the cellular phone.

1. Open the housing cover.
 - Release the four screws with a Phillips head screwdriver.
 - Lift the housing cover slightly and tip it to the left. Two flexible fasteners secure the housing cover to the housing.
2. Insert the SIM card into the slot, aligning the notch on the card so that it is at the bottom at the front.

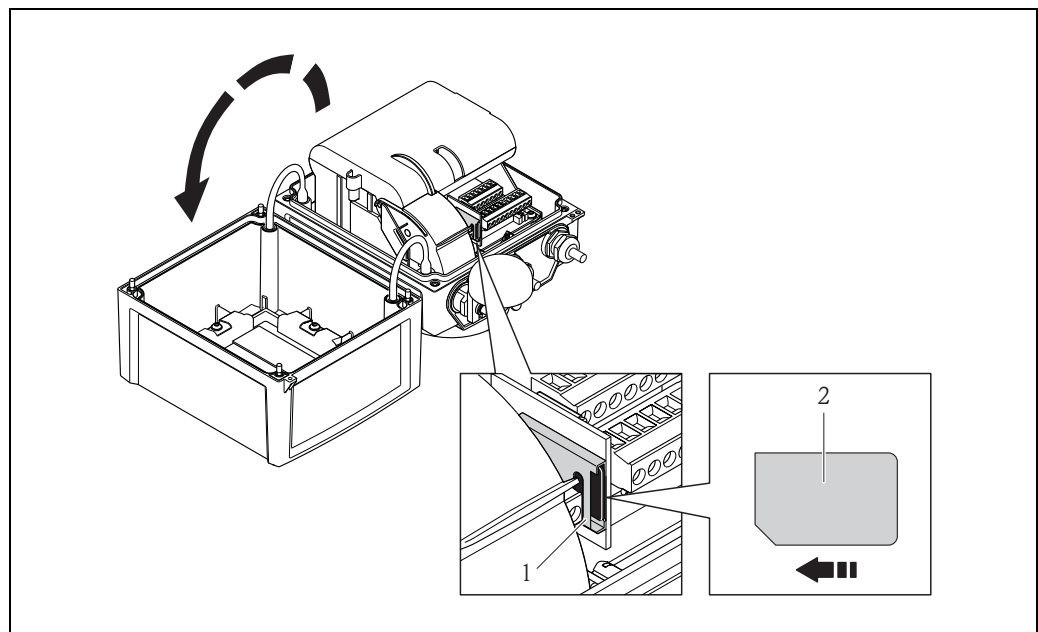

A0016594

Fig. 56: SIM card slot on the electronics board

- 1 Slot on the electronics board
- 2 SIM card

9.4 Switching on the measuring device

Once the batteries have been inserted, the measuring device is switched on via the DIP switch → 43. This applies both to battery-powered operation and for operation with an optional power supply since the device is already powered via the backup battery B1 in this case.



Warning!

Only switch on the external power supply (optional) once the post-installation and post-connection checks have been performed successfully for the device.

After a successful startup, the onsite display switches automatically from the startup display screens to the measured value display.

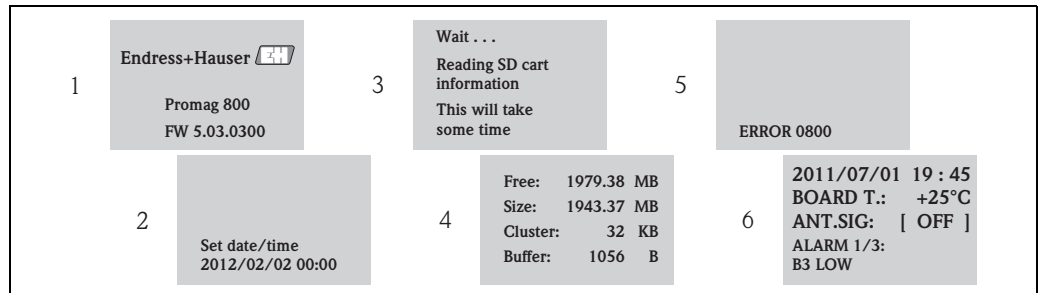

Fig. 57: Example: display screens when the measuring device is started

- 1 Name of measuring device, firmware version
- 2 Date and time entered via the operating keys (entry also possible at a later date) → 48
- 3 Reads the information from the SD card
- 4 Displays the memory capacity and the current settings of the SD card
- 5 Displays any pending errors → 99 ff.
- 6 Displays general information

9.4.1 Meaning of the LEDs

The measuring device is fitted with two light emitting diodes (LEDs) on the electronics board. Once the measuring device has been switched on the LEDs indicate different states for the measuring device and the GMS module.

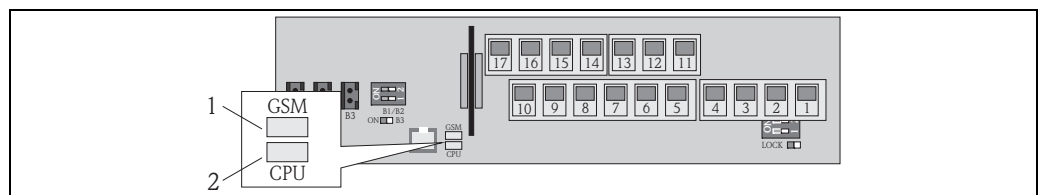

Fig. 58: Light emitting diodes on the electronics board

- 1 LED (blue) for GSM module, is lit when communication is active
- 2 LED (red) for CPU

LED GSM module (blue)		LED CPU (red)	
State	Meaning	State	Meaning
Off	The GSM module is not switched on, in the standby mode or is not connected to a network.	Off	Not switched on or no power supply available.
Lit	GSM module is trying to log into the network.		
Flashing slowly	GSM module is logged into the network and is waiting for commands.	Flashing	The LED flashes for every measured value acquisition. Frequency of measured value acquisition → 135.
Flashing quickly	The GSM module is sending or receiving a file (SMS or e-mail), data transmission in progress.	Flashing approx. 1 Hz	One or more alarms are active.





9.5 Establishing wireless communication

9.5.1 General notes

It is only possible to configure the parameters that are relevant for wireless communication via the "Config 5800" operating tool. The parameters required to establish communication are not available in the onsite display.

9.5.2 Configuring SMS communication

1. In the Config 5800 operating tool, call up the "GPRS data" parameter group and configure the parameters as described in the following table:





Parameters	Description	Options and information on setting the parameter	Example	Source of information
GPASN (→  162)	Telephone number of the sender (sends SMS to measuring device)	<ul style="list-style-type: none"> ▪ Text entry, max. 19 characters ▪ No number: The measuring device can receive every text message (SMS) from every number. ▪ Partial number: The measuring device can receive all the text messages (SMS) that start with the number entered. ▪ Complete number: The measuring device can only receive text messages (SMS) from the number entered. 	<ul style="list-style-type: none"> ▪ +41123456789: receives SMS from this number only ▪ +41123456: receives SMS from phone numbers +411234560000 to +411234569999 	Customer
GPSSN (→  162)	Telephone number of the first receiver (receives SMS from measuring device).	<ul style="list-style-type: none"> ▪ Text entry, max. 19 characters ▪ A text message (SMS) is sent to this telephone number if errors or alarms occur. 	+41123456789	Customer
GPSS2 (→  162)	Telephone number of the second receiver (receives SMS from measuring device).	<ul style="list-style-type: none"> ▪ Text entry, max. 19 characters ▪ A text message (SMS) is sent to this telephone number if errors or alarms occur. 	+41123456790	Customer
GPSS3 (→  162)	Telephone number of the third receiver (receives SMS from measuring device).	<ul style="list-style-type: none"> ▪ Text entry, max. 19 characters ▪ A text message (SMS) is sent to this telephone number if errors or alarms occur. 	+41123456791	Customer

2. Send a text message (SMS) to the measuring device with the cellular phone.
The parameters of the measuring device can be queried or modified by text message.

Example: Send the command VTPV? in an SMS to the measuring device (→  71).



Make sure that you, as the sender (cellular phone number), are also authorized to send a text message to the measuring device (GPASN parameter).

3. Check the message inbox of the measuring device.
 - Via the integrated user interface →  56:
 - a. Select parameter group "7 - Communication"
 - b. Select the "Chk SMS" parameter →  149
 - c. Use the **ESC key** to confirm the "EXECUTE?" prompt
 - Via the tree structure →  58:
 - a. Select parameter group "Communication"
 - b. Select the "SMSCI" parameter →  149
 - c. Select "SMSCI="
 - ✓ "SMSCI=" appears in the input box

- d. Enter the value "1" after "SMSCI=" in the input box (**SMSCI=1**)
 - e. Press  to confirm the value entered.
 - ✓ The correct entry is confirmed in the view box: 0:OK.
4. Check whether SMS communication has been established successfully.
 SMS communication has been established successfully if:
- the measuring device has sent a reply message (SMS) to the cellular phone.
 - the receipt of the query message (SMS) and the transmission of the reply message (SMS) have both been logged in the event list.

Example

- The parameters are protected by the password "100000".
- The unit for the temperature is to be changed from °C to °F.
- The totalizer positive total is to be displayed.

User entry: ACODE=100000,TMMUV=1,VTPPV?

 In the case of protected parameters with Level 2 status or higher, the ACODE parameter and the password must be the first element specified.

 The individual commands, queries etc. must **always** be separated by a comma **without** a space.

Structure of the query message (SMS)

Query message for the example		
Category	SMS content	Description
Sender (from:)	+41 123456789	Cellular phone number of the sender. Check the GPASN parameter to ensure that the measuring device is authorized to receive a text message from this cellular phone number →  70.
Receiver (to:)	+41 987654321	Cellular phone number of the measuring device.
Text/content	ACODE=100000,TMMUV=1,VTPPV ?	<ul style="list-style-type: none"> ▪ Password for access (if password-protected) ▪ Change the unit for temperature to °F ▪ Query the totalizer value (positive total)

Structure of the reply message (SMS)

Possible reply message for the example above		
Category	SMS content	Description
Sender (from:)	+41 987654321	Cellular phone number of the measuring device.
Receiver (to:)	+41 123456789	Cellular phone number of the cellular phone from which the query message was sent.
Text/content	°F,dm3,548.989	Temperature unit, unit and current value of the totalizer (positive total)

9.5.3 Configuring general GPRS communication

GPRS communication supported by the mobile communications network provider

The parameters listed below must be configured correctly to ensure that the device can execute the following functions:

- Send e-mails
- Read e-mails
- Synchronize the system time with a time server (NTP server)

The parameter settings must be requested from the cell phone network provider (GPRS provider) (e.g. home page or customer service).

Communication cannot be established if the settings are incorrect or incomplete. The measuring device does not have any default settings.

Communication can only be established via the Config 5800 operating tool

It is only possible to configure the parameters that are relevant for wireless communication via the "Config 5800" operating tool. The parameters required to establish communication are not available in the onsite display.

The mobile communications network provider must support GPRS communication (GPRS data traffic) for communication via e-mail to take place. This must be taken into consideration when selecting the mobile communications network provider and entering a mobile communications contract.

Verifying parameter settings with the mobile telecommunications provider

Where necessary check the following GPRS data with your mobile communications network provider:

Information required to configure GPRS communication		
Parameters (GPRS configuration → 72)	Settings in the measuring device (GPRS data → 164)	Information from your mobile communications network provider
GPAPN Name of the access point to the mobile communications network (APN: access point name)		
GPUSR User name for authentication purposes		
GPPSW Password for authentication purposes		
GPAUT Authentication type, access authentic value required for the network provider		

1. In the Config 5800 operating tool, call up the "GPRS data" parameter group and configure the parameters as described in the following table:

Parameters	Description	Options and information on setting the parameter	Example	Source of information
GPAPN (→ 160)	Name of the access point to the mobile communications network (APN: access point name)	Text entry, max. 31 characters.	gprs.provider.com	Mobile communications network provider

Parameters	Description	Options and information on setting the parameter	Example	Source of information
GPUSR (→ 161)	User name for authentication purposes	<ul style="list-style-type: none"> ▪ Text entry, max. 18 characters. ▪ Only optional for some mobile communications network providers. 	"" (empty)	Mobile communications network provider
GPPSW (→ 161)	Password for authentication purposes	<ul style="list-style-type: none"> ▪ Text entry, max. 18 characters. ▪ Only optional for some mobile communications network providers. 	"" (empty)	Mobile communications network provider
GPAUT (→ 161)	Authentication type, access authentic value required for the network provider	<ul style="list-style-type: none"> ▪ 0 = Normal (PAP) ▪ 1 = Secure (CHAP) ▪ 2 = No one Select "0" if this information is not required by the provider.	0	Mobile communications network provider

2. Test whether communication can be established.
 - Via the integrated user interface → 56:
 - a. Select parameter group "10 - Diagnostic"
 - b. Select the "Gprs test" parameter → 157
 - c. Use the **ESC key** to confirm the "EXECUTE?" prompt
 - ✓ The "Definition Setup:OK" message appears on the display
 - Via the tree structure → 58:
 - a. Select the "Diagnostic" parameter group
 - b. Select the "GTEST" parameter → 157
 - c. Select "GTEST="
 - ✓ "GTEST=" appears in the input box.
 - d. Enter the value "1" after "GTEST=" in the input box (GTEST=1)
 - e. Press **Enter** to confirm the value entered.
 - ✓ The correct entry is confirmed in the view box: 0:OK.
 - ✓ The "Definition Setup:OK" message appears on the display
3. Check the test result in the event list → 64. If the communication has been established correctly, the message "Modem registrate to network [name of the provider]" appears on the display.

Possible errors if communication fails

- Incorrect entries in the parameters for GPRS configuration.
Action: verify parameter settings with the provider of the mobile communications network.
- The option to enter a PIN number is not disabled for the SIM card.
- The SIM card is not configured correctly. The SIM card must be configured for a GPRS network. This differs from the standard configuration for a GSM network.
- The antenna signal is too weak.
- The antenna is not connected or is damaged.

9.5.4 Configuring e-mail communication (sending)

General notes

The Promag 800 can send and receive e-mails, i.e. it acts as a mail client. To send e-mails, the measuring device must be able to access an SMTP server. The measuring device does not support encrypted login (e.g. SSL/TSL using TCP Port 465), as the processing power and, consequently, power consumption would be too high.

For sending e-mails, one of the following IT solutions is required:

■ SMTP server

Use of an SMTP server from a GPRS provider (e.g. Vodafone, Orange etc.). Here, the SMTP server must treat the IP address of the SIM card as a "secure IP" and allow e-mails to be sent via Port 25. No username or password is required for the SMTP server. The SMTP server must be configured accordingly. Solutions such as these are possible within the context of M2M (mobile to mobile) contracts with GPRS providers and must be clarified upfront.

Description of configuration:

– Example A:

Communication via domain name without username/password →  76

– Example B:

Communication via static IP address without username/password →  77

■ E-mail account

Setting up an e-mail account (username and password) for the measuring device with an internet provider. Using the assigned username (max. 24 characters) and password (max. 12 characters), the measuring device can log on without encryption to the internet provider's SMTP server via Port 25. No specific username or password for the SMTP server is provided in the measuring device memory. The username and password for the POP3 server are used. It is necessary to check with the internet provider if an unencrypted login is possible using Port 25.

Description of configuration:

– Example C:

Communication via domain name with username/password →  78

– Example D:





Communication via static IP address with username/password →  79

■ Additional solutions may be possible.

For more information on this, please contact Endress+Hauser customer service.

Parameters for establishing e-mail communication via SMTP server of the GPRS provider (sending)

The parameters are used differently depending on how the communication link is configured.

Parameter (description) Short description	Notes	Format, Example	Source of information
GPSMA (→  161) Static IP address of the SMTP server (e-mail receiver).	<ul style="list-style-type: none"> ■ Is only required if a static IP address is used →  77. ■ If "0.0.0.0" is entered: The system searches for the IP address via the fully qualified domain name of the SMTP server (GPDNS). 	xxx.xxx.xxx.xxx 154.25.132.47	Internet provider
GPDNS (→  161) Fully qualified domain name (plain text name) of the SMTP server (e-mail receiver).	<ul style="list-style-type: none"> ■ Is only required if the system searches via the fully qualified domain name of the SMTP server →  76. ■ Text entry, max. 31 characters ■ Complete computer name of the SMTP server. ■ Given the combination: <ul style="list-style-type: none"> – GPSMA parameter: 0.0.0.0 is entered – No entry "" in this parameter The system searches for the IP address via the DNS server 	smtp.gprsprovider.com	Internet provider







Parameter (description) Short description	Notes	Format, Example	Source of information
GPNS (→ 161) IP address of the DNS server (domain name system)	<ul style="list-style-type: none"> ■ Is only required if the system searches via the e-mail address of the receiver → 78, otherwise "0.0.0.0" is always entered. ■ Given the combination: <ul style="list-style-type: none"> – GPSMA parameter: "0.0.0.0" is entered – GPDNS parameter: "" no entry – 0.0.0.0 entered in this parameter: The IP address of the DNS server is assigned automatically by the network. A fixed IP address can also be entered, however. 	xxx.xxx.xxx.xxx 0.0.0.0	If 0.0.0.0: automatically via the network
GPSMP (→ 161) IP port of the SMTP server (e-mail receiver).	<ul style="list-style-type: none"> ■ IP port 25 is used in most cases. ■ Input range: 0 to 65535. ■ The measuring device is not able to interpret TLS- or SSL-encrypted data. For this reason, you cannot use a port that uses a TSL or SSL protocol (e.g. 465). 	25	– If IP port 25 is not supported: Admin, IT department
GPEMT (→ 161) E-mail address of receiver	<ul style="list-style-type: none"> ■ Text entry, max. 39 characters ■ The customer must set up the e-mail account. Customers can use their own e-mail address (company address) or an address of an e-mail provider. 	client@-provider.com john.public@company.com	Customer
GPEMF (→ 161) Existing transmission e-mail address of the measuring device. In the event of an error, the receiver (SMTP server) sends a mail error, along with the cause of the error, to this address (e.g. error sending mail to receiver (SMTP server))	<ul style="list-style-type: none"> ■ Max. 39 characters. ■ The customer must set up the e-mail account. Customers can use their own e-mail address (company address) or an address of an e-mail provider. ■ If an error occurs when establishing the connection, this e-mail account can be used to check whether a mail error has been received. 	client@-provider.com john.public@provider.com	Customer
GPSAE (→ 163)	This value must be set to = 1 to ensure that the measuring device logs on to the SMTP server using the POP3 server's access data.	1	
GP3US (→ 162)	User name for authentication on POP3 server	Text entry, max. 24 characters	Internet provider, customer
GP3PS (→ 162)	Password for authentication on POP3 server	Text entry, max.12 characters	Internet provider, customer
GPHES (→ 163) Name (HELO string) so the SMTP server of the receiver can identify the measuring device.	<ul style="list-style-type: none"> ■ This must always be entered. ■ Max. 31 characters, no spaces. ■ The SMTP server of the receiver must know the name (HELO string). If this is not the case, the e-mail might be treated as spam. 	Promag800	Customer, possibly admin, IT department

**Example A:
Establishing e-mail communication (sending) via the domain name of the SMTP server of the GPRS provider without user name and password**

1. In the Config 5800 operating tool, call up the "GPRS data" parameter group and configure the parameters as described in the following table:

Parameters	Input, format	Remarks
GPSMA	0.0.0.0	"0.0.0.0" is always entered. The system searches for the IP address via the fully qualified domain name of the SMTP server (GPDNS parameter).
GPDNS	smtp.emailprovider.com	Fully qualified domain name (plain text name) of the SMTP server (e-mail receiver).
GPNRS	0.0.0.0	"0.0.0.0" is always entered.
GPSMP	25	IP port 25 is used in most cases. If this is not supported, contact your administrator, IT department.
GPEMT	e.g. john.public@company.com	E-mail address of receiver.
GPEMF	e.g. client@provider.com	E-mail address of the field device and receiver of mail errors.
GPHESES	e.g. Promag800	How the measuring device is identified at the SMTP server of the receiver. The SMTP server must know this name (otherwise the e-mail might be treated as spam).

Exact description of the parameters →  74.

2. Test whether communication can be established:
 - Via the integrated user interface →  56:
 - a. Select parameter group "7 - Communication".
 - b. Select the "Send events" parameter →  149.
 - c. Use the **ESC key** to confirm the "EXECUTE?" prompt.
 - Via the tree structure →  58:
 - a. Select the parameter group "Communication".
 - b. Select the "EVTSI" parameter →  149.
 - c. Select "EVTSI=".
 - ✓ "EVTSI=" appears in the input box.
 - d. Enter the value "1" after "EVTSI=" in the input box (EVTSI=1).
 - e. Press  to confirm the value entered.
 - ✓ The correct entry is confirmed in the view box: 0:OK.
3. Check the test result in the event list →  64.
An e-mail will have been sent if the communication was established successfully.









For an overview of other configuration options for establishing e-mail communication (sending), and the related advantages and disadvantages, see →  74.

Example B:**Establishing e-mail communication (sending) via the static IP address of the SMTP server of the GPRS provider without user name and password**

1. In the Config 5800 operating tool, call up the "GPRS data" parameter group and configure the parameters as described in the following table:

Parameters	Input, format	Remarks
GPSMA	e.g. 154.25.132.047	Static IP address of the SMTP server (e-mail receiver), information supplied by administrator, IT department.
GPSMA	" "	No entry " ". Is not required if a static IP address (GPSMA parameter) is used.
GPNRS	0.0.0.0	"0.0.0.0" is always entered.
GPSMP	25	IP port 25 is used in most cases. If this is not supported, contact your administrator, IT department.
GPEMT	e.g. john.public@company.com	E-mail address of receiver.
GPEMF	e.g. client@provider.com	E-mail address of the field device and receiver of mail errors.
GPHEM	e.g. Promag800	How the measuring device is identified at the SMTP server of the receiver. The SMTP server must know this name (otherwise the e-mail might be treated as spam).

Exact description of the parameters →  74.

2. Test whether communication can be established:
 - Via the integrated user interface →  56:
 - a. Select parameter group "7 - Communication".
 - b. Select the "Send events" parameter →  149.
 - c. Use the **ESC key** to confirm the "EXECUTE?" prompt.
 - Via the tree structure →  58:
 - a. Select the parameter group "Communication".
 - b. Select the "EVTSI" parameter →  149.
 - c. Select "EVTSI=".
 - ✓ "EVTSI=" appears in the input box.
 - d. Enter the value "1" after "EVTSI=" in the input box (EVTSI=1).
 - e. Press  to confirm the value entered.
 - ✓ The correct entry is confirmed in the view box: 0:OK.
3. Check the test result in the event list →  64.
An e-mail will have been sent if the communication was established successfully.









For an overview of other configuration options for establishing e-mail communication (sending), and the related advantages and disadvantages, see →  74.

Example C:**Establishing e-mail communication (sending) via the domain name of the SMTP server of the internet provider with user name and password**

1. In the Config 5800 operating tool, call up the "GPRS data" parameter group and configure the parameters as described in the following table:

Parameters	Input, format	Remarks
GPSMA	0.0.0.0	"0.0.0.0" is always entered. The system searches for the IP address via the fully qualified domain name of the SMTP server (GPDNS parameter).
GPDNS	smtp.emailprovider.com	Fully qualified domain name (plain text name) of the SMTP server (e-mail receiver).
GPNRS	0.0.0.0	"0.0.0.0" is always entered.
GPSMP	25	IP port 25 is used in most cases. If this is not supported, contact your administrator, IT department.
GPSAE	1	Switch-on the authentication.
GP3US	Max. 24 characters	User name for the authentication.
GP3PS	Max. 12 characters	Password for the authentication.
GPENT	e.g. john.public@company.com	E-mail address of receiver.
GPENF	e.g. client@provider.com	E-mail address of the field device and receiver of mail errors.
GPHEP	e.g. Promag800	How the measuring device is identified at the SMTP server of the receiver. The SMTP server must know this name (otherwise the e-mail might be treated as spam).

Exact description of the parameters →  74.

2. Test whether communication can be established:
 - Via the integrated user interface →  56:
 - a. Select parameter group "7 - Communication".
 - b. Select the "Send events" parameter →  149.
 - c. Use the **ESC key** to confirm the "EXECUTE?" prompt.
 - Via the tree structure →  58:
 - a. Select the parameter group "Communication".
 - b. Select the "EVTSI" parameter →  149.
 - c. Select "EVTSI=".
 - ✓ "EVTSI=" appears in the input box.
 - d. Enter the value "1" after "EVTSI=" in the input box (EVTSI=1).
 - e. Press  to confirm the value entered.
 - ✓ The correct entry is confirmed in the view box: 0:OK.
3. Check the test result in the event list →  64.
An e-mail will have been sent if the communication was established successfully.









For an overview of other configuration options for establishing e-mail communication (sending), and the related advantages and disadvantages, see →  74.

Example D:**Establishing e-mail communication (sending) via the static IP address of the SMTP server of the GPRS provider with user name and password**

1. In the Config 5800 operating tool, call up the "GPRS data" parameter group and configure the parameters as described in the following table:

Parameters	Input, format	Remarks
GPSMA	e.g. 154.25.132.047	Static IP address of the SMTP server (e-mail receiver), information supplied by administrator, IT department.
GPSMA	""	No entry "". Is not required if a static IP address (GPSMA parameter) is used.
GPNRS	0.0.0.0	"0.0.0.0" is always entered.
GPSMP	25	IP port 25 is used in most cases. If this is not supported, contact your administrator, IT department.
GPSAE	1	Switch-on the authentication.
GP3US	Max. 24 characters	User name for the authentication.
GP3PS	Max. 12 characters	Password for the authentication.
GPEMT	e.g. john.public@company.com	E-mail address of receiver.
GPEMF	e.g. client@provider.com	E-mail address of the field device and receiver of mail errors.
GPHEM	e.g. Promag800	How the measuring device is identified at the SMTP server of the receiver. The SMTP server must know this name (otherwise the e-mail might be treated as spam).

Exact description of the parameters →  74.

2. Test whether communication can be established:
 - Via the integrated user interface →  56:
 - a. Select parameter group "7 - Communication".
 - b. Select the "Send events" parameter →  149.
 - c. Use the **ESC key** to confirm the "EXECUTE?" prompt.
 - Via the tree structure →  58:
 - a. Select the parameter group "Communication".
 - b. Select the "EVTSI" parameter →  149.
 - c. Select "EVTSI=".
 - ✓ "EVTSI=" appears in the input box.
 - d. Enter the value "1" after "EVTSI=" in the input box (EVTSI=1).
 - e. Press  to confirm the value entered.
 - ✓ The correct entry is confirmed in the view box: 0:OK.
3. Check the test result in the event list →  64.
An e-mail will have been sent if the communication was established successfully.



For an overview of other configuration options for establishing e-mail communication (sending), and the related advantages and disadvantages, see →  74.

9.5.5 Configuring e-mail communication (receiving)

The system can be configured in different ways to receive e-mails:

- Communication established via the static IP address of the POP3 server
- Communication established via a dynamic IP address of the POP3 server

Communication established via the static IP address of the POP3 server

Communication with the server is established quickly and directly by specifying the static IP address of the POP3 server.

1. In the Config 5800 operating tool, call up the "GPRS data" parameter group and configure the parameters as described in the following table:

Parameter s	Description	Options and information on setting the parameter	Example	Source of information
GPP3A (→ ☰ 162)	Static IP address of the POP3 server. The measuring device searches for e-mails on the POP3 server.	xxx.xxx.xxx.xxx	152.22.102.57	Customer, possibly administrator, IT department or e-mail provider
GPDNP (→ ☰ 162)	Fully qualified domain name of the POP3 server.	Is not required if a static IP address is used.	"" (empty)	–
GPP3P (→ ☰ 162)	TCP PORT of the POP3 server.	<ul style="list-style-type: none"> ■ User entry between 0 and 65535 ■ The measuring device cannot read or send TLS- or SSL-encrypted data. For this reason, please ensure you do not use a connection that uses a TSL or SSL protocol. 	110	Customer, possibly administrator, IT department or e-mail provider
GP3US (→ ☰ 162)	User name for authentication purposes.	Text entry, max. 24 characters	User name	Customer
GP3PS (→ ☰ 162)	Password for authentication purposes.	Text entry, max. 12 characters	Password	Customer

2. Send an e-mail to the measuring device → ☰ 82.
3. Check the mail inbox of the measuring device.
 - Via the integrated user interface → ☰ 56:
 - a. Select parameter group "7 - Communication"
 - b. Select the "Ck mail" parameter → ☰ 149
 - c. Use the **ESC key** to confirm the "EXECUTE?" prompt
 - Via the tree structure → ☰ 58:
 - a. Select parameter group "Communication"
 - b. Select the "**EMLRI**" parameter → ☰ 149
 - c. Select "**EMLRI**="
 - ✓ "**EMLRI**=" appears in the input box
 - d. Enter the value "1" after "**EMLRI**=" in the input box (**EMLRI**=1)
 - e. Press **☰** to confirm the value entered.
 - ✓ The correct entry is confirmed in the view box: 0:OK.
4. Check whether e-mail communication has been established successfully.

E-mail communication has been established successfully if:





 - the receipt of the query mail and the transmission of the reply mail have both been logged in the event list.
 - communication is indicated on the onsite display.
 - the measuring device has sent a reply mail to the server.







Communication established via a dynamic IP address of the POP3 server

The measuring device automatically searches for the dynamic IP address of the POP3 server described in the fully qualified domain name.

The communication is only established once the dynamic IP address has been determined. Compared to when a static IP address is used, the measuring device requires a longer time to establish the communication when using a dynamic IP address. This uses more battery power.

1. In the Config 5800 operating tool, call up the "GPRS data" parameter group and configure the parameters as described in the following table:

Parameter s	Description	Options and information on setting the parameter	Example	Source of information
GPP3A (→  162)	Static IP address of the POP3 server. The measuring device searches for e-mails on the POP3 server.	xxx.xxx.xxx.xxx Is not required if a dynamic IP address is used. Entry 0.0.0.0 = activation of fully qualified domain name	0.0.0.0	–
GPDPN (→  162)	Fully qualified domain name of the POP3 server	<ul style="list-style-type: none"> ▪ Text entry, max. 31 characters ▪ Complete computer name of the POP3 server 	pop3.-provider.com	Customer, possibly administrator, IT department or e-mail provider
GPP3P (→  162)	TCP-PORT of POP3 server	<ul style="list-style-type: none"> ▪ User entry between 0 and 65535 ▪ The measuring device cannot read or send TLS- or SSL-encrypted data. For this reason, please ensure you do not use a connection that uses a TSL or SSL protocol. 	110	Customer, possibly administrator, IT department or e-mail provider
GP3US (→  162)	User name for authentication purposes	Text entry, max. 24 characters	User name	Customer
GP3PS (→  162)	Password for authentication purposes	Text entry, max. 12 characters	Password	Customer

2. Send an e-mail to the measuring device →  82.
3. Check the mail inbox of the measuring device.
 - Via the integrated user interface →  56:
 - a. Select parameter group "7 - Communication"
 - b. Select the "Ck mail" parameter →  149
 - c. Use the **ESC key** to confirm the "EXECUTE?" prompt
 - Via the tree structure →  58:
 - a. Select parameter group "Communication"
 - b. Select the "**EMLRI**" parameter →  149
 - c. Select "**EMLRI**="
 - ✓ "**EMLRI**=" appears in the input box
 - d. Enter the value "1" after "**EMLRI**=" in the input box (**EMLRI**=1)
 - e. Press  to confirm the value entered.
 - ✓ The correct entry is confirmed in the view box: 0:OK.
4. Check whether e-mail communication has been established successfully. E-mail communication has been established successfully if:
 - the receipt of the query mail and the transmission of the reply mail have both been logged in the event list.
 - communication is indicated on the onsite display.
 - the measuring device has sent a reply mail to the server.

Structure of a query e-mail to the measuring device

The parameters of the measuring device can be queried or modified by an e-mail. In the case of protected parameters with Level 2 status or higher, the ACODE parameter and the password must be the first element specified.

E-mail with queries entered directly

Example of a query e-mail sent to the measuring device		
Category	E-mail content	Description
Sender (from:)	client@provider.com	E-mail address of sender.
Receiver (to:)	Promag800@provider.com	E-mail address of measuring device.
Subject (Subject:)	Promag800	Name of measuring device.
Text/content	acode=123456, frmu=0	Enable Level 2 parameters: Change the unit

E-mail with the queries in an attached file

Example of a query e-mail sent to the measuring device		
Category	E-mail content	Description
Sender (from:)	client@provider.com	E-mail address of sender.
Receiver (to:)	Promag800@provider.com	E-mail address of measuring device.
Subject (Subject:)	Promag800	Name of measuring device.
Text/content	fname=config_02.txt  config_02.txt	File name specified Attached file

9.5.6 Configuring system time synchronization

The measuring device sends all the files with a date and time stamp. The measuring device supports synchronization of the date and time via an NTP server. It is advisable to synchronize the date and time to ensure that all the files have a unique stamp, regardless of how energy management is configured for the measuring device.

Synchronization can be configured in different ways:

- Synchronization established via the static IP address of the NTP server
- Synchronization established via the domain name (DNS) of the NTP server

Synchronization established via the static IP address of the NTP server

1. In the Config 5800 operating tool, call up the "GPRS data" parameter group and configure the parameters as described in the following table:

Parameter s	Description	Options and information on setting the parameter	Example	Source of information
GPTSA (→ ☰ 161)	IP address of the NTP server, for establishing the connection to the server and for synchronizing the system time of the measuring device.	Address is entered in the format: xxx.xxx.xxx.xxx	212.25.132.47	NTP server
GPDNT (→ ☰ 161)	Fully qualified domain name of the NTP server.	<ul style="list-style-type: none"> ▪ Text entry, max. 31 characters ▪ Complete computer name of the SMTP server 	"" (empty)	NTP server
GPTSP (→ ☰ 162)	TCP port of the NTP server.	<ul style="list-style-type: none"> ▪ User entry between 0 and 65535 ▪ The measuring device cannot read or send TLS- or SSL-encrypted data. For this reason, please ensure you do not use a connection that uses a TSL or SSL protocol. 	123	NTP server

2. Test whether communication can be established.
 - Via the integrated user interface → ☰ 56:
 - a. Select parameter group "7 - Communication"
 - b. Select the "Clock s" parameter → ☰ 149
 - c. Use the **ESC** key to confirm the "EXECUTE?" prompt
 - ✓ The system time is displayed correctly in the Config 5800 operating tool.
 - Via the tree structure → ☰ 58:
 - a. Select parameter group "Communication"
 - b. Select the "**CSYNI**" parameter → ☰ 149
 - c. Select "**CSYNI**="
 - ✓ "**CSYNI**=" appears in the input box
 - d. Enter the value "1" after "**CSYNI**=" in the input box (**CSYNI**=1)
 - e. Press **↵** to confirm the value entered.
 - ✓ The correct entry is confirmed in the view box: 0:OK.
 - ✓ The system time is displayed correctly in the Config 5800 operating tool.

Synchronization established via the domain name of the NTP server

1. In the Config 5800 operating tool, call up the "GPRS data" parameter group and configure the parameters as described in the following table:

Parameters	Description	Options and information on setting the parameter	Example	Source of information
GPTSA (→ ☰ 161)	IP address of the NTP server, for establishing the connection to the server and for synchronizing the system time of the measuring device.	Address is entered in the format: xxx.xxx.xxx.xxx	0.0.0.0	NTP server
GPDNT (→ ☰ 161)	Fully qualified domain name of the NTP server	<ul style="list-style-type: none"> ▪ Text entry, max. 31 characters ▪ Complete computer name of the SMTP server 	ntp.metas.ch	NTP server
GPTSP (→ ☰ 162)	TCP port of the NTP server	<ul style="list-style-type: none"> ▪ User entry between 0 and 65535 ▪ The measuring device cannot read or send TLS- or SSL-encrypted data. For this reason, please ensure you do not use a connection that uses a TSL or SSL protocol. 	123	NTP server

2. Test whether communication can be established.
 - Via the integrated user interface → ☰ 56:
 - a. Select parameter group "7 - Communication"
 - b. Select the "Clock s" parameter → ☰ 149
 - c. Use the **ESC key** to confirm the "EXECUTE?" prompt
 - ✓ The system time is displayed correctly in the Config 5800 operating tool.
 - Via the tree structure → ☰ 58:
 - a. Select parameter group "Communication"
 - b. Select the "**CSYNI**" parameter → ☰ 149
 - c. Select "**CSYNI**="
 - ✓ "**CSYNI**=" appears in the input box
 - d. Enter the value "1" after "**CSYNI**=" in the input box (**CSYNI**=1)
 - e. Press **↵** to confirm the value entered.
 - ✓ The correct entry is confirmed in the view box: 0:OK.
 - ✓ The system time is displayed correctly in the Config 5800 operating tool.

9.6 Data logger file with process data

The file with the process data contains process and status values of the measuring device. It is saved on the data logger (SD card) and can be called up:

- Via the user interface of the Config 5800 operating tool → 64.
- Via an e-mail query → 82.

i If data logging is enabled (Acquisition parameter, DLOGE → 152), the process data are recorded and written to a file every day. It is possible to specify the time and the recording interval for saving the process data → 171.

Parameter group "9 Data logger" is used to specify which process data (parameters) are saved → 151.

The file is made available in CSV format and can be imported into MS Excel, for example.

The data logger file does **not** contain any headers. Only the actual values are transmitted in order to reduce the data volume during GSM/GPRS communication.

However, the values transmitted are always located in the same position in the table. The following table extracts (rows 1 and 2, columns A to AS), in which the individual values are described, can be used to evaluate the file.

i If the process data are loaded and evaluated more frequently, it can be helpful to add headers manually to the file. In this way, this file can always be used as an import template since the structure (columns used) is always identical.

9.6.1 Structure of the sent data logger file

The structure of the data logger file is illustrated in the following table extracts.

The data logger file does **not** contain the headers (rows 1 and 2). They are only used here to assign the individual values. Examples of process and status values of the measuring device are listed from row 3 onwards. Additional explanations and cross-references to the related parameters are provided below the values.

Data logger file in MS Excel format, column A-G

	A	B	C	D	E	F	G
1	Reference data			Total Positive tot.		Total Negative tot.	
2	N.record	Date	Time	M.Unit	Value	M.Unit	Value
3	1	30.01.2012	15:05:10	dm3	1808.799	dm3	1808.799
4	2	30.01.2012	15:15:10	dm3	1808.799	dm3	1808.799
5	3	30.01.2012	15:25:10	dm3	1808.799	dm3	1808.799
...		
	Reference data (No. of measurement, date, time)			Positive totalizer total Log T+ (DTTPE) → 154		Negative totalizer total Log T- (DTTNE) → 154	

Data logger file in MS Excel format, column H-Q

	H	I	J	K	L	M	N	O	P	Q
	Flow rate		Flow rate %						Partial Positive tot.	
	M.Unit	Value	Symbol	Value					M.Unit	Value
	dm3/min	7.68	%	15					dm3	59936
	dm3/min	7.68	%	15					dm3	59936
	dm3/min	7.68	%	15					dm3	59936

	Flow value Log Q (DFLWE) → 155		Flow value in % % values (DLPVE) → 155		-				Positive totalizer total Log P+ (DTPPE) → 154	

Data logger file in MS Excel format, column R-AA

R	S	T	U	V	W	X	Y	Z	AA	AB
Partial Negative tot.		Total Net Value tot.		Partial Net Value tot.						
M.Unit	Value	M.Unit	Value	M.Unit	Value					
dm3	59936	dm3	59936	dm3	59936					
dm3	59936	dm3	59936	dm3	59936					
dm3	59936	dm3	59936	dm3	59936					
...
Negative totalizer total Log P- (DTPNE) → 154		Totalizer Net (balance) Log NT (DLTNE) → 154		Totalizer Net (balance) Log NP (DLPNE) → 154		-				



Data logger file in MS Excel format, column AC-AM

AC	AD	AE	AF	AG	AH	AI	AJ	AK	AL	AM
					Meas. cycles/hour		Battery Status1		Battery Status2	
					Symbol	Value	Symbol	Value	Symbol	Value
					c/h	6966	%	99	%	80
					c/h	6966	%	99	%	80
					c/h	6966	%	99	%	80
...
-					Measured value acquisition per hourLog STAT (DLMSE) → 155		State of charge of battery 1 Log STAT (DLMSE) → 155		State of charge of battery 2 Log STAT (DLMSE) → 155	

Data logger file in MS Excel format, column AN-AS

AN	AO	AP	AQ	AR	AS	AT	AE
Battery Status3		Antenna Signal		Board Temperature			
Symbol	Value	Symbol	Value	M.Unit	Value		
%	90	%	75	°C	19		
%	90	%	75	°C	19		
%	90	%	75	°C	19		
...		
State of charge of battery 3 Log STAT (DLMSE) → 155		Strength of antenna signal Log STAT (DLMSE) → 155		Temperature of electronics board Log STAT (DLMSE) → 155			

9.7 Setting the operating language

1. Press and hold the **[E]** key on the local operation panel for 2 seconds and release.
 - ✓ The device leaves the standby mode and the measured value or status display screen appears.
 2. Press **[E]** once.
 - ✓ The main menu is called up.
-  **Note!**
 During initial commissioning or if the **Quick Start** parameter (→  150) is set to **ON** (default value), the Quick Start menu is displayed when the **[E]** key is pressed. Once in the Quick Start menu (→  129), the user can access the main menu by pressing **[↑]** to select **Main menu** and pressing **[E]** to confirm.
3. Press **[↑]** to select parameter group **8 - DISPLAY**.
 4. Press **[E]** to confirm the selection.
 - ✓ Parameter group **8 - DISPLAY** is called up.
 5. Press **[↑]** to select the **Language** parameter.
 6. Press **[E]** to confirm the selection.
 - ✓ The parameter is displayed.
 7. Press **[↑]** to select the desired language.
 8. Press **[E]** to confirm the selection.
 - ✓ The language changes to the language selected.



Note!

Setting the operating language with the Config 5800 operating tool:

- **Integrated user interface:**
 The process is identical to the procedure via local operation from Step 2 onwards.
 The option selected is confirmed by pressing the Enter key.
- **Parameter menu:**
 The operating language is configured via the **LLANG** parameter →  150.

9.8 Managing the configuration



The configuration of the measuring device is saved on the SD card.
 For information on saving or loading the configuration, see →  63.

9.9 Simulation





9.9.1 Flow simulation

The simulation function is used to generate an internal flow signal which can be used to test the behavior of the outputs, limit values etc. of the measuring device. If simulation is enabled, an "S" appears on the onsite display.





Starting the simulation

- **Local operation:** "10 - Diagnostic", "Simulation" parameter set to ON →  157
- **Config 5800 operating tool:**
 - **Integrated user interface:** "10 - Diagnostic", "Simulation" parameter set to ON →  157
 - **Parameter menu:** "Diagnostic", "MSIEN" parameter set to 1 →  157

Specifying the value for simulation

- Local operation:
 1. Switch to the display area →  49.
 2. Press the Enter key →  48.
 - ✓ The prompt "Fl.rate = % +000.00" appears on the display.
 3. Specify the value for the simulation and press the Enter key to confirm →  48.
- Config 5800 operating tool, integrated user interface:
 1. Switch to the display area →  49.
 2. Press the Enter key.
 - ✓ The prompt "Fl.rate = % +000.00" appears on the display.
 3. Specify the value for the simulation and press the Enter key to confirm.

Ending the simulation

- Local operation:
 1. Switch to the display area →  49.
 2. Press the Enter key →  48.
 - ✓ The prompt "Fl.rate = % +000.00" appears on the display.
 3. Press the Enter key > 3 seconds →  48.
- Config 5800 operating tool, integrated user interface:
 1. Switch to the display area →  49.
 2. Press the Enter key.
 - ✓ The prompt "Fl.rate = % +000.00" appears on the display.
 3. Press the ESC key.
- Config 5800 operating tool, parameter menu:
 1. In "Diagnostic", "MSIEN" parameter set to 0 →  157

9.10 Protecting settings from unauthorized access

9.10.1 Write protection via lock switch

The local operation of the measuring device can be locked via DIP switches on the electronics board. Access to individual parameters is no longer supported. It is still possible to change the views in the display area and to read the measured values.

1. Open the housing cover.
 - Release the four screws with a Phillips head screwdriver.
 - Lift the housing cover slightly and tip it to the left. Two flexible fasteners secure the housing cover to the housing.
2. **Switch both** DIP switches to the ON position →  59.

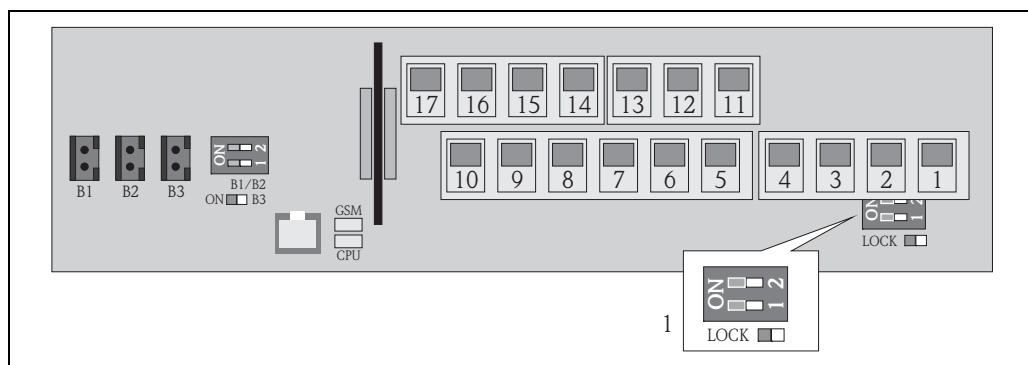

Fig. 59: DIP switches on the electronics board

1 DIP switches for locking the operating elements for local operation

3. Secure the housing cover.
 - Fix the housing cover on the housing.
 - Tighten the four screws with a Phillips head screwdriver.



Note!

The housing cover can be lead-sealed to the housing as an additional mechanical precaution to prevent unauthorized access to the electronics board. A borehole is provided on both the housing and housing cover for this purpose.



In custody transfer:















More information on locking the measuring device and the as-delivered state is provided in the "Custody transfer (optional)" section →  93.

9.10.2 Protection by user roles and access authorization

The parameters in the measuring device have different access levels →  51.

10 Operation

10.1 Changing the operating language

1. Press and hold the  key on the local operation panel for 2 seconds and release.
 - ✓ The device leaves the standby mode and the measured value or status display screen appears.
 2. Press  once.
 - ✓ The main menu is called up.
-  **Note!**
 During initial commissioning or if the **Quick Start** parameter (→  150) is set to **ON** (default value), the Quick Start menu is displayed when the  key is pressed. Once in the Quick Start menu (→  129), the user can access the main menu by pressing  to select **Main menu** and pressing  to confirm.
3. Press  to select parameter group **8 - DISPLAY**.
 4. Press  to confirm the selection.
 - ✓ Parameter group **8 - DISPLAY** is called up.
 5. Press  to select the **Language** parameter.
 6. Press  to confirm the selection.
 - ✓ The parameter is displayed.
 7. Press  to select the desired language.
 8. Press  to confirm the selection.
 - ✓ The language changes to the language selected.





Note!

To change the operating language via the operating tool, the procedure is identical from Step 2 onwards. The option selected is confirmed by pressing the Enter key.

10.2 Switching the display

The measuring device has seven different measured value and status display screens (→  48). The user can toggle between these screens.

1. Press and hold the  key on the local operation panel for 2 seconds and release.
 - ✓ The device leaves the standby mode and the measured value or status display screen appears.
2. Press  to switch to the desired measured value or status display screen.
 -  The measured value or status display screen appears.



Note!

To change the display via the operating tool, the procedure is identical from Step 2 onwards.

10.3 Reading measured values

1. Press and hold the  key on the local operation panel for 2 seconds and release.
 - ✓ The device leaves the standby mode and the measured value or status display screen appears.

10.4 Performing a totalizer reset

The individual totalizer totals can be reset via local operation or via the measuring device input:







- Via local operation, parameter →  150.



- Via the measuring device input, configuration via parameter →  137.

10.5 Battery power consumption

The power consumption level depends on how the measuring device is used and configured. The table lists typical applications and indicates how they affect the battery life of the individual batteries.

The power consumption level is indicated in the form of a bar graph: 1 (low) to 4 (high).

Operating conditions	Batteries on main board B1/B2
Use of location operation	
Use of service interface and data storage	
Measured value acquisition: Continuous	
Measured value acquisition: Smart	
Measured value acquisition: Average	
Measured value acquisition: Max. battery life	

Operating conditions	Batteries for GSM/GPRS modem B3
Low signal from mobile telecommunications network	
High rate of data exchange	
Transmission of max. number of parameters and units	



Contact your Endress+Hauser Sales Center to calculate the battery life for your specific operating conditions.

10.5.1 Battery life

The battery has a maximum battery life of 15 years.

The battery life, and thereby the availability of the measuring device if powered by batteries, depends on a number of factors, including:

- The number of batteries
- The ambient conditions
- The frequency of data transmission via the GSM/GPRS modem
- The size of the files transmitted
- The interface activities (use of local operation, GSM/GPRS modem etc.)
- The selected measured value acquisition method (parameter → 135):
 - "MAX. LIVE" (max. battery life): measured value acquired every 15 seconds.
 - "SMART" (dynamic control of measurement data acquisition): measured value acquisition depends on the flow profile. The measuring device records the measured value every 5 seconds. The frequency of the measured value acquisition cycle is increased if the measuring device detects a change in the flow profile. The measuring device is supplied with the "SMART" measuring mode as standard.
 - "AVERAGE": measured value acquisition every 3 seconds.
 - "CONTINUOUS": continuous measured value acquisition.

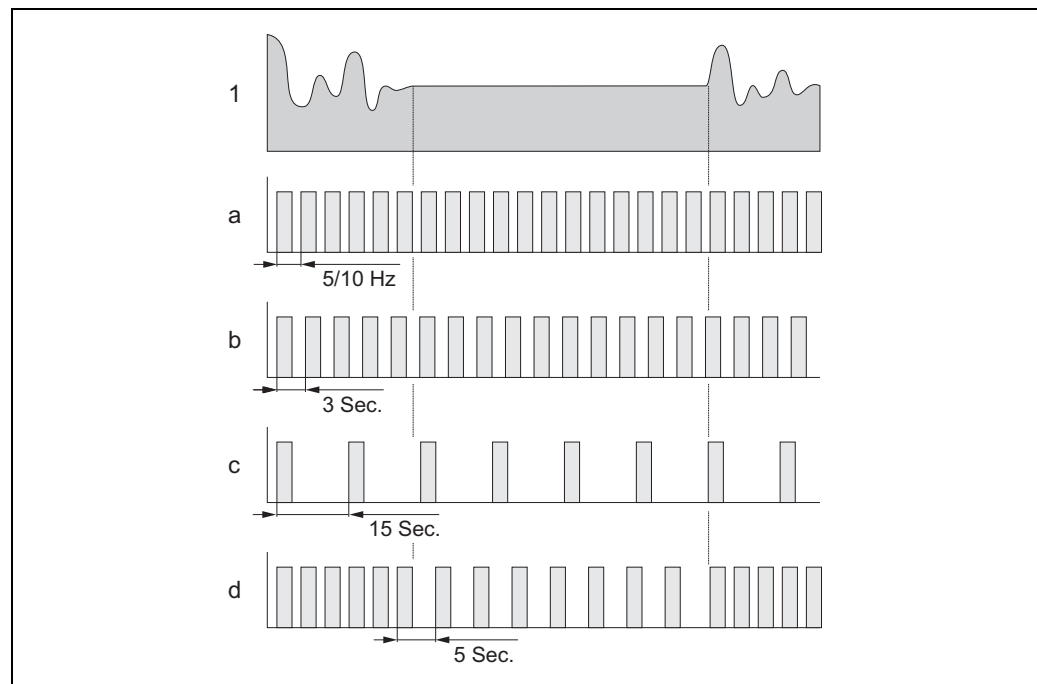

Fig. 60: Operating principle of the different measured value acquisition methods

- | | |
|---|--------------|
| 1 | Flow profile |
| a | CONT.PWR |
| b | AVERAGE |
| c | MAX. LIFE |
| d | SMART |



Contact your Endress+Hauser Sales Center to calculate the battery life for your specific operating conditions.

11 Custody transfer (optional)

As an option, Promag W 800 is tested in accordance with OIML R49 and has an EC type-examination certificate as per Measuring Instruments Directive 2004/22/EC (MID) for service subject to legal metrological control ("custody transfer") for cold water (Annex MI-001).

It is used with a legally controlled totalizer on the local display.

Measuring devices subject to legal metrological control totalize in both directions, i.e. all the outputs consider flow components in the positive (forward) and negative (reverse) flow direction.

Generally a measuring device subject to legal metrological control is secured against tampering by lead seals on the transmitter or sensor. These lead seals may normally only be opened by a representative of the competent authority for legal metrology controls.

After putting the device into circulation or after sealing the device, operation via the onsite display, via the Config 5800 software operating tool or via GSM/GPRS is only possible to a limited extent.

 Detailed ordering information is available from your local Endress+Hauser sales center for national approvals as cold water meters based on OIML R49.

11.1 Terminology

Cold water

Fluid temperature between +0.1 to +50 °C (+32.2 to +122 °F)

Flow ranges

Overload flowrate Q4:

Highest flowrate at which the meter is required to operate, for a short period of time, within its maximum permissible error, whilst maintaining its metrological performance.

Permanent flowrate Q3:

Highest flowrate of the meter within the rated operating conditions while remaining within the error limits.

Transitional flowrate Q2:

Flow between the permanent flowrate Q3 and the minimum flowrate Q1, which divides the flowrate range into two zones (the upper flowrate zone and the lower flowrate zone), each characterized by its own maximum permissible error.

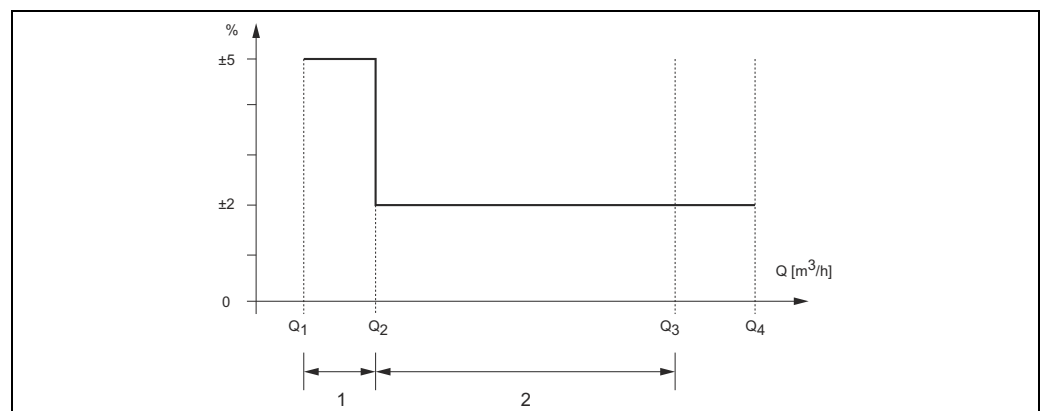

Fig. 61: Flow ranges and maximum permissible errors for cold water

- 1 Lower flowrate zone (error limit: $\pm 5\%$)
 2 Upper flowrate zone (error limit: $\pm 2\%$)

Minimum flowrate Q1:

Lowest flowrate at which the water meter is required to operate within the maximum permissible errors.

11.2 Permanent flowrate characteristics

DN		Q1	Q2	Q3	Q4	Q3/Q1
[mm]	[in]	[m ³ /h]	[m ³ /h]	[m ³ /h]	[m ³ /h]	[m ³ /h]
25	1	0.10	0.16	16	20	160
32	1 ¼	0.16	0.25	25	31	160
40	1 ½	0.25	0.40	40	50	160
50	2	0.39	0.63	63	79	160
65	2 ½	0.63	1.0	100	125	160
80	3	1.0	1.6	160	200	160
100	4	1.6	2.5	250	313	160
125	5	2.5	4.0	400	500	160
150	6	3.9	6.3	630	788	160
200	8	6.3	10	1000	1250	160
250	10	10	16	1600	2000	160
300	12	16	25	2500	3125	160

11.3 Device as-delivered state

Measuring devices for service according to the EC type-examination certificate as per the Measuring Instruments Directive 2004/22/EC (MID), Annex MI-001 are locked when delivered.

For the remote device version, the connection between the transmitter and sensor may need to be subsequently sealed on site by an authorized Endress+Hauser service technician or by the measuring equipment owner/operator.

Following installation, the electronics compartment cover of the transmitter must be sealed by the owner/operator.

Measuring devices according to national approvals, based on OIML R49, are not locked and sealed when delivered.

When putting the device into circulation, the owner/operator must comply with national regulations and standards that apply.

11.4 Custody transfer measurement (European Measuring Instruments Directive 2004/22/EC, Annex MI-001)

11.4.1 Disabling custody transfer mode

Prerequisite: The device is operational and is already set to custody transfer mode.



Note!

The special service and device-specific parameters (Level 4) can only be modified by Endress+Hauser Service staff. Contact your local Endress+Hauser sales center!

For this purpose, please note down the serial number of the measuring device. This information can be found on the nameplate →  13.

1. Remove the operation seal on the transmitter housing
2. Open the electronics compartment cover of the transmitter.
3. Have a qualified Endress+Hauser Service technician unlock the measuring device.
4. Screw down the electronics compartment cover.

11.4.2 Setting up custody transfer mode

Prerequisite: The device is operational and is not already set to custody transfer mode.



Note!

The special service and device-specific parameters (Level 4) can only be modified by Endress+Hauser Service staff. Contact your local Endress+Hauser sales center!

For this purpose, please note down the serial number of the measuring device. This information can be found on the nameplate →  13.

1. Open the electronics compartment cover of the transmitter.
2. Have a qualified Endress+Hauser Service technician configure the functions that are relevant for custody transfer measurement.



Note!

Strict compliance with the restrictions defined in the type-examination certificate ATLab-I13-001 is mandatory!

3. Have a qualified Endress+Hauser Service technician lock the measuring device.



Note!

Once the device is locked, operation via the onsite display, via the Config 5800 software operating tool or via GSM/GPRS is only possible to a limited extent.

4. Screw down the electronics compartment cover.
5. Seal the transmitter housing with an operation seal.

11.5 Custody transfer measurement (national approval, OIML R49)

11.5.1 Setting up custody transfer mode

Prerequisite: The device is operational and is not already set to custody transfer mode.



Note!

- When putting the device into circulation, the owner/operator must comply with national regulations and standards that apply for configuring and sealing the measuring device.
- Generally speaking, to protect the DIP switch against tampering it suffices to use a tape seal that leaves a residue if removed (see step 4).

1. Open the electronics compartment cover of the transmitter.
2. Configure the functions that are relevant for custody transfer measurement.
3. Lock the operating elements of the local display with the DIP switch provided for this purpose (→  30).



Note!

Once the device is locked, operation via the onsite display, via the Config 5800 software operating tool or via GSM/GPRS is only possible to a limited extent.

4. Have the DIP switch sealed by an authorized person (optional).
5. Screw down the electronics compartment cover.
6. Seal the transmitter housing with an operation seal.

11.5.2 Disabling custody transfer mode

Prerequisite: The device is operational and is already set to custody transfer mode.

1. Remove the operation seal on the transmitter housing
2. Open the electronics compartment cover of the transmitter.
3. Have the seal of the DIP switch removed by an authorized person (optional).

4. Unlock the operating elements of the local operation with the DIP switch provided for this purpose (→  30).
5. Screw down the electronics compartment cover.





11.6 Reapproval

The owner/operator is required to apply for reapproval in accordance with national regulations. The date for reapproval (year) can be indicated on a special seal on the measuring device.

In the case of measuring devices that are put into circulation according to the EC type-examination certificate as per the Measuring Instruments Directive 2004/22/EC(MID), Annex MI-001, the first reapproval date is the year indicated on the additional nameplate →  13.

12 Diagnostics and troubleshooting

12.1 Diagnostic event on the onsite display

All the active errors are shown on the onsite display. To view the errors, the user must switch to the specific display screen →  62 (for information on switching between the onsite display screens with ,   48).

The "ALARM" row shows the number of the current error and the total number of active alarms (the error message of the current error is displayed under this line).

If more than one error is active, the user can toggle between the individual errors and the related error messages with the  key.

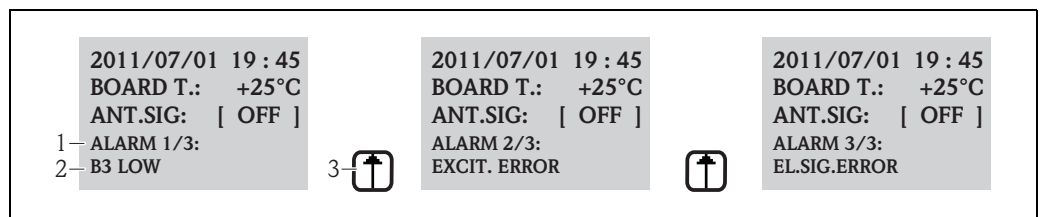



Fig. 62: Active errors shown on the onsite display



- 1 Active errors: No. of current error displayed / total number of active errors
- 2 Error message of the error currently displayed
- 3 Toggle between the errors using the V key

12.1.1 Error messages

 If the appropriate option is selected in the Send AL (ALRSM) parameter, errors messages can be output via SMS and/or e-mail →  144.

No.	Message	Cause	Measures
000	No error	-	-
212	CLOCK NOT SET	Date and time NOT valid	Set the clock manually or via GPS
214	V.MODEM LOW	The power supply for the GSM/GPRS modem is too low to guarantee reliable modem operation.	Check: <ul style="list-style-type: none"> ▪ B3 batteries ▪ B3 battery connection ▪ The batteries or electronics board for visible damage
215	SD MEMORY ERROR	The SD card is not: <ul style="list-style-type: none"> ▪ Available ▪ Valid ▪ Formated ▪ Compatible 	The SD card must be: <ul style="list-style-type: none"> ▪ Inserted correctly ▪ Replaced ▪ Formated
216	POWER SUPPLY OFF	The external power supply has failed.	Check: <ul style="list-style-type: none"> ▪ Power supply source ▪ Connections
217	SD MEMORY FULL	The memory of the SD card is full. No more data can be saved.	Replace the SD card or delete unwanted data from the SD card.
218	S.OUT OVERLOAD	Electrical overloading of the external sensors and inputs.	Check: <ul style="list-style-type: none"> ▪ Connections ▪ External sensors
219	ERR.SENS.TEMP	There is a problem with the external temperature sensor (functionality is not supported).	-
220	F.SENSOR ERROR	Flow sensor error.	Check the error message in the event file. Take additional steps depending on the results of the check.

No.	Message	Cause	Measures
221	EXCITE.ERROR	Magnetic coil excitation current error.	Check: <ul style="list-style-type: none"> ▪ Connection of coil current cable ▪ Magnetic coil insulation ▪ Resistance of magnetic coil
222	EL.SIG.ERROR	Error at the measuring electrode.	Check: <ul style="list-style-type: none"> ▪ Sensor cable connection ▪ Electrode surface ▪ Grounding ▪ Operating conditions
223	P. EMPTY	An empty pipe has been detected.	Check: <ul style="list-style-type: none"> ▪ Check the threshold value, "EPDTH" parameter → 131 ▪ Operating conditions
224	MAX Q-	The negative flow value is higher than the set alarm limit value.	Check: <ul style="list-style-type: none"> ▪ "Al max-" alarm limit value → 136 ▪ Operating conditions
225	MIN Q-	The negative flow value is lower than the set alarm limit value.	Check: <ul style="list-style-type: none"> ▪ "Al min-" alarm limit value → 136 ▪ Operating conditions
226	MAX Q+	The positive flow value is higher than the set alarm limit value.	Check: <ul style="list-style-type: none"> ▪ "Al max+" alarm limit value → 136 ▪ Operating conditions
227	MIN Q+	The positive flow value is lower than the set alarm limit value.	Check: <ul style="list-style-type: none"> ▪ "Al min+" alarm limit value → 136 ▪ Operating conditions
236	FLOW>FS	The current flow is higher than the set full scale value.	Check: <ul style="list-style-type: none"> ▪ Full scale value setting → 132 ▪ Operating conditions
239	PULS.1>F.MAX	The pulse frequency of output 1 is too high.	Reduce the pulse frequency if the connected totalizer allows this value to be reduced. Or reduce the value for the pulse unit.
240	PULS.2>F.MAX	The pulse frequency of output 2 is too high.	Reduce the pulse frequency if the connected totalizer allows this value to be reduced. Or reduce the value for the pulse unit.
242	B1 LOW	The B1 battery for the electronics board is low.	Replace the B1 battery/batteries.
243	B2 LOW	The B2 batteries for the electronics board are low.	Replace the B2 battery/batteries.
244	B3 LOW	The B3 batteries for the GSM/GPRS modem are low.	Replace the B3 batteries.
245	MAIL S.FAILED	The last mail transmission failed.	Check: <ul style="list-style-type: none"> ▪ Antenna signal ▪ GPRS parameter ▪ Server status and configuration
246	SMS NOT AUTH	System has received SMS from an unauthorized number.	Check the data logger file to find out the number of the sender. Then take additional steps (e.g. authorize the number).
247	B.TEMP.OUT R.	The temperature of the electronics board is outside the permitted temperature range.	Change the operating conditions to guarantee operation in the permitted temperature range.
248	CLOCK S.FAIL	System time synchronization between the measuring device and server has failed.	Check: <ul style="list-style-type: none"> ▪ Server configuration ▪ GPRS network conditions ▪ Antenna signal

No.	Message	Cause	Measures
249	POWER FAILURE	The power supply has failed.	Check: <ul style="list-style-type: none"> ▪ Battery state of charge ▪ Connections  Note! The message can also appear if the measuring device was switched off directly and not from the standby mode.
250	NO CMD RECEIVED	The list of parameters sent to the measuring device does not contain executable commands.	Check, modify and resend the list.
251	FIRMW.FILE ERR	Firmware file error	Request a new firmware file.
252	ALARM INPUT ACT.	An alarm has been detected via the digital input.	Check the operating conditions.
253	CONFIG. ENTERED	The configuration parameters of the measuring device have been accessed.	Check the access in the event file. Take further action depending on the desired access authorization.
254	SYSTEM RESTART	The measuring device is restarted following a reset command.	Check: <ul style="list-style-type: none"> ▪ Connections ▪ Batteries ▪ Grounding of measuring device  Note! This message is not an error if it appears after an AUTO-TEST command.
255	SYSTEM STARTUP	The measuring device is booted.	–

12.1.2 System error codes



Multiple system error codes can be added together (hexadecimal) and displayed. To determine the individual system errors the highest possible system error code is subtracted from the aggregated system error code.

Example

Aggregated system error code = 0215

- 0215 – 0200 = 0015 (system error with error code 0200)
- 0015 – 0008 = 0007 (system error with error code 0008)
- 0007 – 0004 = 0003 (system error with error code 0004)
- 0003 – 0002 = 0001 (system error with error code 0002)
- 0001 – 0001 = 0000 (system error with error code 0001)

No.	Cause	Measures
0001	Operating key error (operating key is jammed)	Contact your Endress+Hauser Sales Center.
0002	The hardware parameters saved in the F-RAM are not valid.	
0004	The software parameters saved in the F-RAM are not valid.	
0008	The transducer parameters saved in the F-RAM are not valid.	
0200	Excitation current error for magnetic coil.	
0400	Measured value input error.	
1000	Internal reference time error.	
0010	Resistance of magnetic coil outside tolerance.	Check: <ul style="list-style-type: none"> ▪ Sensor status ▪ Sensor wiring ▪ Operating conditions ▪ Transmitter connections ▪ Grounding
0020	TC2 time outside tolerance.	
0040	TC1 time outside tolerance.	
0080	Insulation of magnetic coil outside tolerance.	
0100	Error in excitation current phase shift.	
0800	Excitation current interrupted for magnetic coil.	

No.	Cause	Measures
2000	Reference temperature error.	Check: <ul style="list-style-type: none"> ▪ Operating conditions
4000	External power supply overload.	–
8000	SD card error.	Check: <ul style="list-style-type: none"> ▪ Card slot ▪ SD card compatibility

12.2 Diagnostic event in the operating tool

12.2.1 Operating tool error messages

Error message	Meaning	Measures
0:OK	The command was executed correctly.	–
1:CMD ERR	The command could not be executed: <ul style="list-style-type: none"> ▪ Command not permitted or unknown ▪ Command outside input range 	<ul style="list-style-type: none"> ▪ Enter correct or available value. ▪ Check spelling.
2:PARAM ERR	Parameter error. The value entered: <ul style="list-style-type: none"> ▪ Is outside the parameter input range. ▪ Is not among the options available for the parameter. 	<ul style="list-style-type: none"> ▪ Enter correct or available value. ▪ Check spelling.
3:EXEC ERR	Execution error: incorrect hardware or configuration.	Check whether hardware is present (e.g. GSM/GPRS modem).
4:RANGE ADJ	Automatic reset: an internal parameter reset is performed	Switch on the hardware (e.g. GSM/GPRS modem).
5:ACCESS ERR	Access denied: A higher access level is required to execute the command.	Change access level →  128.
6:BUFFER FULL	The input or output memory for communication is full	Use shorter commands.
7:FILE NOTFND	The file sought is not on the SD card.	<ul style="list-style-type: none"> ▪ Check the filter name. ▪ Copy the file.
8:SDC ERR	<ul style="list-style-type: none"> ▪ Cannot read the SD card. ▪ Cannot write to the SD card. ▪ Cannot access the SD card memory. 	<ul style="list-style-type: none"> ▪ Check the SD card. ▪ Replace the SD card.
9:BUSY	The ETP interpreter is busy (working) (still processing command)	Wait until the ETP interpreter has processed the command.

12.3 Communication diagnostic event

12.3.1 GSM/GPRS error messages

No.	Meaning	No.	Meaning
25 (19)	LLC or SNDCP error	39 (27)	Reactivation request
26 (1a)	Insufficient resources	40 (28)	Functionality is not supported
27 (1b)	APN unknown or missing	103	Invalid MS
28 (1c)	Unknown PDP address or PDP type	106	Invalid ME
29 (1d)	User identification failed	107	GPRS service not permitted
30 (1e)	Activation denied (GGSN)	111	PLMN not permitted
31 (1f)	Activation denied	112	Application not permitted
32 (20)	Service option is not supported	113	Roaming not permitted in application
33 (21)	Requested service option not described	132	Service option is not supported
34 (22)	Service option temporarily out of service	133	Requested service option not described
35 (23)	NSAPI already in use	134	Service option temporarily out of service
36 (24)	Deactivation of the normal PDP context	148	Unspecified GPRS error
37 (25)	QoS is not accepted	149	PDP detection error
38 (26)	Network error	150	Defective modem

12.4 Overview of diagnostic events

12.4.1 Calibration



Note!

This function is only available with the Level 3 access code → 128.

Calibration and verification of the input circuits (Calibration/CALIC parameter → 156).

The result can be viewed via the event file → 64.

12.4.2 Sensor test

Verification of the sensor (Sensor test/STSTC parameter → 156).

The result can be viewed via the event file → 64.

12.4.3 Self-test

Verification of the measuring device (Self test/ATSIC parameter → 156).

The result can be viewed via the event file → 64.

12.4.4 Display data



Note!

This function is only available with the Level 3 access code → 128.

Advanced display of measuring device data (Display data parameter → 157).



The result can be viewed via the event file → 64.

12.4.5 Standby

Switch the display to the standby mode (Standby/STBYC parameter → 157).

The result can be viewed via the event file → 64.

12.4.6 GPRS test

To perform the GPRS test with the server (Gprs test/GTEST parameter →  157).
The result can be viewed via the event file →  64.

12.4.7 Read SD card information

Display the information on the SD card (Read SDC info/SDSTA parameter →  157).
Display total/free disk space, cluster, buffer on onsite display.

13 Repair

13.1 General notes

Repair and conversion concept

The Endress+Hauser repair and conversion concept defines the following:

- The measuring devices have a modular design.
- Spare parts are grouped logically into kits along with the respective installation instructions.
- Repairs are performed by Endress+Hauser Service or by appropriately trained clients.
- Certified devices can only be converted to other certified devices by Endress+Hauser Service or in the factory.

Information on repair and conversion work

Please note the following if repairing or converting a measuring device:

- Only use genuine Endress+Hauser parts.
- Carry out the repairs as specified in the installation instructions.
- Observe the applicable standards, national regulations and certificates.
- Document all repairs and modifications and enter them in the W@M Life Cycle Management database.

13.2 Spare parts

- Some replaceable measuring device components are identified by a spare parts nameplate, which contains information about the spare part.
- A spare parts nameplate is located in the connection compartment cover of the measuring device and contains the following information:
 - A list of the most important spare parts for the measuring device, including the associated ordering information.
 - The URL for the W@M Device Viewer (www.endress.com/deviceviewer): This contains a list of all the spare parts that are available for the measuring device, including the order code. These parts can be ordered. If available, the corresponding installation instructions can also be downloaded here.

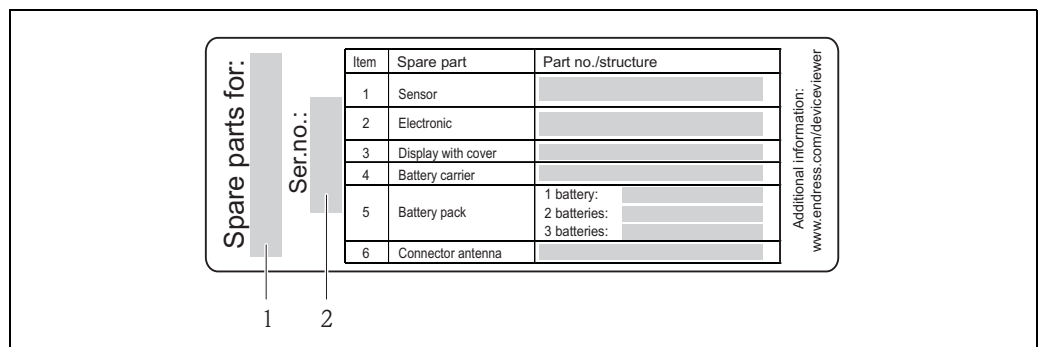

Fig. 63: Example of "Spare parts overview nameplate" in the connection compartment cover

- 1 Measuring device serial number
- 2 Measuring device name



Measuring device serial number:

- Is located on the device and the spare parts nameplate.
- Can be read out via the "Serial number" parameter in the "Device information" submenu.

13.3 Endress+Hauser services



Contact your Endress+Hauser Sales Center for information on services and spare parts.

14 Maintenance

14.1 Maintenance work

14.1.1 Exterior cleaning

When cleaning the exterior of measuring devices, always use cleaning agents that do not attack the surface of the housing and the seals.



Caution!

Cleaning agents can damage the plastic transmitter housing!

- Do not use high-pressure steam.
- Only use the permitted cleaning agents specified.

Permitted cleaning agents for the plastic housing

- Mild soap solutions
- Commercially available household cleaners
- Methyl alcohol or isopropyl alcohol

14.1.2 Interior cleaning

No interior cleaning is planned for the device.

14.1.3 Replacing the batteries



Caution!

Can damage the electronic of the device!

Only use batteries provided by Endress+Hauser.

Battery replacement → 40.

After replacing the batteries, comply with instructions for battery disposal → 108.

14.2 Measuring and testing equipment

Endress+Hauser offers a wide range of measuring and testing equipment, such as W@M or device tests.



Your Endress+Hauser sales center can provide detailed information on the specific services.



List of some of the measuring and testing equipment:

"Accessories" chapter in the "Technical Information" document for the device.

14.3 Endress+Hauser services

Endress+Hauser offers a wide range of maintenance services, such as recalibration, servicing or device tests.



Your Endress+Hauser sales center can provide detailed information on the specific services.

15 Accessories

Various accessories, which can be ordered with the device or subsequently from Endress+Hauser, are available for the device.

Detailed information on the order code in question is available from your local Endress+Hauser Sales Center or on the product page of the Endress+Hauser website: www.endress.com.



For an overview of the accessories that can be ordered, see the "Technical Information" document.

16 Return

The measuring device must be returned if it is in need of repair or a factory calibration, or if the wrong measuring device was ordered or delivered. Legal specifications require Endress+Hauser, as an ISO-certified company, to follow certain procedures when handling products that are in contact with the medium.

To ensure your device is returned in a safe, professional and swift manner, please refer to the procedure and conditions for returning devices provided on the Endress+Hauser website at www.services.endress.com/return-material.



Note!

Remove the batteries before returning the device →  42.

17 Disposal

17.1 Disassembling the measuring device

1. Switch off the device.
2.  Warning!
Process conditions can present a risk to humans! Pay particular attention to dangerous process conditions such as pressure in the measuring device, high temperatures or aggressive fluids. Carry out the mounting and connection procedure described in the "Mounting the measuring device" and "Connecting the measuring device" sections in the reverse order. Observe safety instructions.

17.2 Disposing of the measuring device



Warning!

Hazardous fluids present a risk to humans and the environment!

Make sure that the measuring device and all cavities are free from all traces of hazardous fluids, e.g. substances which have penetrated crevices or diffused through plastic.

Note the following when disposing of the device:

- Observe applicable national regulations.
- Separate and recycle the device components based on the materials.

17.3 Disposing of the batteries

Observe the regulations applicable in your country! Dispose of the batteries in accordance with local regulations. Recycle used batteries if possible.

18 Technical data

18.1 Technical data at a glance

18.1.1 Application

The measuring device described in this manual is to be used only for measuring the flow rate of conductive liquids in closed pipes.

A minimum conductivity of 50 $\mu\text{S}/\text{cm}$ is required for measuring purposes.

To ensure that the device remains in proper operating condition for its service life, use the measuring device only for media to which the process-wetted materials are adequately resistant.

18.1.2 Function and system design

Measuring principle

Flow velocity (proportional to induced voltage)

Measuring system

The measuring system consists of a transmitter and a sensor.

Two versions are available:

- Compact version: the transmitter and sensor form a mechanical unit.
- Remote version: transmitter and sensor are mounted separately from one another

Transmitter

Promag 800 (key operation, eight lines)

Sensor

Promag W (DN 25 to 300 / 1 to 12")

18.1.3 Input

Measured variable

Direct measured variables

Volume flow (proportional to induced voltage)

Calculated measured variables

Mass flow



Note!

In custody transfer: only volume flow.

Measuring range

Typically $v = 0.01$ to 10 m/s (0.03 to 33 ft/s) with the specified accuracy



To calculate the measuring range, use the *Applicator sizing tool*.

Recommended measuring range

"Limiting flow" section → 23

Operable flow range

Over 1000 : 1

In custody transfer:

160 : 1

Further details are laid down by the applicable approval.

Input signal

Status input (auxiliary input)

- $U = 3$ to 40 V DC
- $R = 5$ k Ω
- Galvanically isolated
- Can be configured for:
 - totalizer reset, positive zero return, error message reset.

18.1.4 Output**Output signal**

Status/pulse output

- Passive
- Opto-MOS (opto-isolated output)
- Max. switching voltage: 40 V DC / 28 V AC
- Max. switching current: 100 mA
- Max. R_{on} : 70 Ω
- Max. switching frequency ($R_L = 240$ Ω , $V_{OUT} = 24$ V DC): 50 Hz
- Isolated from other secondary circuits: 500 V DC

GSM/GPRS

GSM/GPRS modem

- For data transmission via a GSM network (TDMA/FMDA)
- Integrated on the electronics board
- Quad-band: 850, 900, 1800, 1900 MHz
- Mail and messaging (SMS) functions
 - Measuring device configuration
 - Measuring device diagnostics
 - Flow protocol data (automatic transmission)
 - Totalizer: positive/negative/net values (balance) (automatic transmission)
 - Alarms (at the time of the event)

Signal on alarm*Status/pulse output*

“Not conductive” in the event of a fault or power supply failure

Low flow cutoff

Switch points can be selected for low flow cutoff between 0 and 25 % of the full scale value.

Galvanic isolation

All circuits for inputs, outputs and power supply are galvanically isolated from each other.

Data logger (SD card)

- The integrated data logger can log the following data:
 - Reference data: time, date, consecutive numbers in list etc.
 - Totalizer counter readings: positive, negative, net (balance)
 - Flow: in volume unit (e.g. m³/h) or in %
 - Measuring cycles per hour, state of charge of the individual battery packs (B1, B2, B3), temperature of the electronics board
- Configurable save cycle: 15 seconds to 24 hours.
- The data of the data logger are not lost if the battery is replaced.

The data logger gives users the option of second, parallel data recording in a higher resolution within a specific period of time.

The data are saved daily in a new file on the micro SD card (storage capacity 2 GB). Via the FXA291 service interface, the files can be saved for evaluation on a PC or laptop with the Config5800 operating software. It is also possible to transmit the files by e-mail via the GSM/GPRS modem, which is available as an option.



18.1.5 Power supply**Battery concept**

→  40



Battery life

→  92

Battery specifications

- Lithium-thionyl chloride high-power batteries (size D)
- 3.6 V DC
- Not rechargeable
- 19 Ah nominal capacity at 20 °C (per battery)
- Battery lasts for up to 15 years
 - The battery life depends on the ambient conditions, the configuration of GSM communication, the received signal strength, the measuring interval etc. →  91.
- Required battery quantity and possible battery arrangement →  40

Terminal assignment

- Inputs/outputs →  35
- Connecting cable of the remote version →  36
- External power supply (optional) →  38

Power supply

Power from batteries

- 3.6 V DC
- 19 Ah nominal capacity at 20 °C (per battery)
- Max. power: 200 mW



The battery life depends on the ambient conditions, the configuration of GSM communication, the received signal strength, the measuring interval etc. → 91.

Supply voltage via external power supply (optional)

- 100 to 240 V AC / 12 to 60 V DC
- 44 to 66 Hz
- Max. power: 3 W
- A battery to act as a backup if the power supply fails



Caution!

The values specified for the supply voltage may not be exceeded.

Power consumption

Switch-on current:

- Max. 30 A at 240 V AC
- Max. 6 A at 24 V DC

Power supply failure

Lasting min. ½ cycle frequency:



The battery in terminal B1 acts as a power backup if power is supplied to the measuring device externally and the power supply fails → 40.

Electrical connection

→ 31 ff.

Potential equalization

→ 43 ff.

Terminals

Plug-in terminals for core cross-sections 0.5 to 2.5 mm² (20 to 14 AWG)

Cable entry

Connecting cable for power supply, signal cable (inputs/outputs) and connecting cable for remote version → 34

- Cable entry
 - Standard: M20 × 1.5 (8 to 12 mm / 0.31 to 0.47 in)
 - For reinforced cables: M20 × 1.5 (9.5 to 16 mm / 0.37 to 0.63 in)
- Thread: ½" NPT, G ½"



If using metal cable entries, the optional ground plate for cable entries must be used.

Cable specification

- Connecting cable → 31
- Connecting cable of the remote version → 31

18.1.6 Performance characteristics

Reference operating conditions

To DIN EN 29104

- Fluid temperature: $(+28 \pm 2) ^\circ\text{C}$ / $(+82 \pm 4) ^\circ\text{F}$
- Ambient temperature range: $(+22 \pm 2) ^\circ\text{C}$ / $(+72 \pm 4) ^\circ\text{F}$
- Warm-up period: 30 minutes

Installation conditions

- Inlet run $> 10 \times \text{DN}$
- Outlet run $> 5 \times \text{DN}$
- Sensor and transmitter grounded.
- The sensor is centered in the pipe.

i The minimum conductivity information refers to measured value acquisition with the "CONT.PWR" profile (continuous operation, the device records the maximum number of measured values, parameter Prof., MPROF). Values can deviate if another profile is selected for measured value acquisition.

i No special requirements must be observed at the inlet and outlet runs to keep within the in-service maximum permissible errors for custody transfer.

Maximum measured error

Pulse output

$\pm 0.5\%$ o.r. $\pm 2\text{ mm/s}$ ($\pm 0.5\%$ o.r. $\pm 0.08\text{ in/s}$)

o.r. = of reading

Fluctuations in the supply voltage do not have any effect within the specified range.

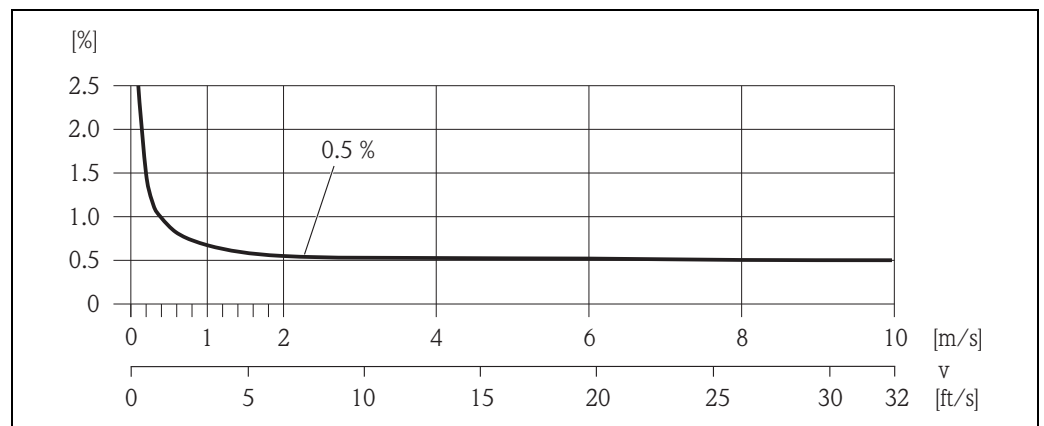

Fig. 64: Max. measured error in % of reading

Repeatability

Max. $\pm 0.2\%$ o.r. $\pm 2.0\text{ mm/s}$ ($\pm 0.2\%$ o.r. $\pm 0.08\text{ in/s}$)

o.r. = of reading

18.1.7 Installation

→ 22

18.1.8 Environment

Ambient temperature range

Transmitter

-20 to +60 °C (-4 to +140 °F)

Sensor

- Flange material carbon steel: -10 to +60 °C (14 to +140 °F)



Caution!

The permitted temperature range of the measuring tube lining may not be undershot or overshoot, "Fluid temperature range" section → 115.

Note the following points:

- Install the measuring device in a shady location.
 - Avoid direct sunlight, particularly in warm climatic regions.
 - Avoid direct exposure to weather conditions.If necessary use a protective cover or weather protector.
- The transmitter must be mounted separate from the sensor if both the ambient and fluid temperatures are high.
- If the measuring device is to be operated with the AVERAGE, SMART or MAX.LIFE profile (→ 135) at low ambient temperatures, regular housing heating should be provided if necessary.

Storage temperature

The storage temperature corresponds to the operating temperature range of the measuring transmitter and the appropriate measuring sensors.

Note the following points:

- The measuring device must be protected against direct sunlight during storage in order to avoid unacceptably high surface temperatures.
- A storage location must be selected where moisture does not collect in the measuring device. This will help prevent fungus and bacteria infestation which can damage the liner.
- Never remove any protection caps or protective covers mounted before installing the measuring device.
- Also be mindful of the following when storing the batteries:
 - Avoid any short-circuiting of the battery poles.
 - The storage temperature should preferably be $\leq 21^{\circ}\text{C}$ ($\leq 70^{\circ}\text{F}$).
 - Store in a dry, dust-free atmosphere that is not subject to large fluctuations in temperature.
 - Protect from sunlight.
 - Do not store near heaters.

Altitude

-200 to +4000 m (-656 to +13124 ft)

Atmosphere

If a plastic transmitter housing is permanently exposed to certain steam and air mixtures, this can damage the housing.



If you are unsure, please contact your Endress+Hauser Sales Center for clarification.

Degree of protection

Transmitter

- Standard: IP66/67, Type 4X enclosure
- When housing is open: IP20, Type 1 enclosure

Sensor

- IP66/67, Type 4X enclosure; fully welded, with protective varnish EN ISO 12944 C5-M. Suitable for use in corrosive atmospheres.
- IP68, Type 6P enclosure; fully welded, with protective varnish EN ISO 12944 C5-M. Suitable for permanent immersion in water ≤ 3 m (10 ft). ≤ 10 m (30 ft) for 48 hours.
- IP68, Type 6P enclosure; fully welded, with protective varnish EN ISO 12944 Im2/Im3. Suitable for permanent immersion in saline water ≤ 3 m (10 ft) or underground. ≤ 10 m (30 ft) for 48 hours.

Shock and vibration resistance

- Vibration sinusoidal, 1 g peak, following IEC 60068-2-6
- Vibration broadband random, 1.54 g rms, following IEC 60068-2-64

Mechanical load

Transmitter housing



Caution!

- The transmitter housing must be protected against mechanical effects, such as shock, impact etc. It is sometimes preferable to use the remote device version.
- The transmitter housing must never be used as a ladder or climbing aid!

Electromagnetic compatibility (EMC)

In accordance with IEC/EN 61326

GSM/GPRS signal strength

It is important to ensure that the signal of the mobile communications network is strong enough to enable the system to dial into the GPRS/GSM network.

18.1.9 Process

Medium temperature range

Sensor

The permissible temperature depends on the lining of the measuring tube.

- 0 to +80 °C (+32 to +176 °F) for hard rubber, DN 50 to 300 (2 to 12")
- -20 to +50 °C (-4 to +122 °F) for polyurethane, DN 25 to 300 (1 to 12")

Seals

No internal seals

Medium pressure range (nominal pressure)

- EN 1092-1 (DIN 2501):
 - PN 10 (DN 200 to 300 / 8 to 12")
 - PN 16 (DN 65 to 300 / 3 to 12")
 - PN 25 (DN 200 to 300 / 8 to 12")
 - PN 40 (DN 25 to 150 / 1 to 6")
- ASME
 - Class 150 (DN 25 to 300 / 1 to 12")
 - Class 300 (DN 25 to 150 / 1 to 6")
- AS
 - AS 2129: Table E (DN 80 to 300 / 3 to 12")
 - AS 4087: PN 16 (DN 80 to 300 / 3 to 12")
- JIS
 - 10K (DN 50 to 300 / 2 to 12")
 - 20K (DN 25 to 300 / 1 to 12")

Conductivity

The minimum conductivity is 50 µS/cm.

Pressure tightness

Liner: polyurethane, hard rubber

Promag W Nominal diameter		Measuring tube liner	Liner pressure tightness: limit values for absolute pressure at different fluid temperatures		
[mm]	[in]		25 °C (77 °F) [mbar]/[psi]	50 °C (122 °F) [mbar]/[psi]	80 °C (176 °F) [mbar]/[psi]
25 to 300	1 to 12"	Polyurethane	0	0	-
50 to 300	2 to 12"	Hard rubber	0	0	0

Limiting flow

→  23

Pressure loss

- No pressure loss if the sensor is installed in a pipe of the same nominal diameter.
- Pressure losses for configurations incorporating adapters according to DIN EN 545 (see "Adapters" →  23)

18.1.10 Mechanical construction

Design, dimensions

For information on the dimensions and lengths of the device, see the "Mechanical construction" section of the "Technical information" document.

Weight

Weight in SI units

Weight data in kg (for standard pressure ratings and excluding packaging material)										
Nominal diameter		Compact version (sensor and transmitter) excluding batteries				Remote version (sensor and connection housing) excluding connecting cable, transmitter and batteries				
		EN (DIN) / AS*		ASME	JIS	EN (DIN) / AS*		ASME	JIS	
[mm]	[in]									
25	1"	PN 40	5	5	5	PN 40	6.5	6	6.5	
32	-		6	-	5		8	-	7.5	
40	1 1/2"		8	8	6		8.5	7	7.5	
50	2"		9	9	7		10	9	9	
65	-	PN 16	10	-	9	PN 16	11	-	10	
80	3"		12	12	11		13	13	11	
100	4"		14	14	13		15	17	13	
125	-		20	-	19		20	-	18	
150	6"	PN 10	24	24	23	PN 10	25	26	23	
200	8"		43	43	40		36	42	32	
250	10"		63	73	68		49	59	48	
300	12"		68	108	70		58	84	55	

Transmitter remote version = 1.5 kg

*Flanges according to AS are only available for DN 80, 100, 150 to 300.
Weight of battery block: 100 g (1 battery), 190 g (2 batteries), 290 g (3 batteries)

Weight in US units

Weight data in lbs (excluding packaging material)										
Nominal diameter		Compact version (sensor and transmitter) excluding batteries				Remote version (sensor and connection housing) excluding connecting cable, transmitter and batteries				
		ASME		ASME		ASME		ASME		
[mm]	[in]									
25	1"	Class 150	11		13					
32	-		-		-					
40	-		-		-					
50	2"		20		20					
65	-		-		-					
80	3"		27		29					
100	4"		31		38					
125	-		-		-					
150	6"		53		58					
200	8"		95		93					
250	10"		161		130					
300	12"		238		185					

Transmitter remote version = 3.3 lbs

Weight of battery block: 3.53 oz (1 battery), 6.70 oz (2 batteries), 10.2 oz (3 batteries)

Material*Transmitter housing*

- Compact version: polycarbonate plastic
- Remote version (wall-mount housing): polycarbonate plastic

Sensor

Fully welded with protective varnish

Sensor connection housing (remote version)

Polycarbonate plastic

Measuring tubes

Stainless steel 1.4301 or 1.4306/304L

Measuring tube lining

- DN 25 to 300 (1 to 12"): polyurethane
- DN 50 to 300 (2 to 12"): hard rubber

Electrodes

1.4435/304L, Alloy C-22

Process connections with protective varnish

- EN 1092-1 (DIN 2501): C22, FE 410 WB, S235JRG2
- ASME B16.5: A105
- AS 2129: A105, S235JRG2, S275JR
- AS 4087: A105, S275JR
- JIS: 1.0425, HII, S235JRG2

Seals

In accordance with DIN EN 1514-1

Accessories

- Display protection
Stainless steel 1.4301
- Ground disks
1.4435/316L, Alloy C-22

Material load diagram

For an overview of the material load diagrams (pressure-temperature graphs) for the process connections, see the "Technical Information" document.

Tightening torques

Observe the following maximum tightening torques:

Component	Max. tightening torque [Nm]
Threaded joint of housing cover	1.3
Cable entry	4.5 to 5.0
Strain relief	1.0
Grounding	2.5
Pipe mounting	2.0
Threaded joint of connection housing, IP68 version, plastic	25
Screw tightening torques	→  25 ff.

Fitted electrodes

- 2 measuring electrodes for signal detection
- 1 reference electrode for potential equalization
- 1 EPD electrode for the detection of empty pipes (not supported by the measuring device)

Process connections

- EN 1092-1 (DIN 2501):
 - PN 10 (DN 200 to 300 / 8 to 12")
 - PN 16 (DN 65 to 300 / 3 to 12")
 - PN 25 (DN 200 to 300 / 8 to 12")
 - PN 40 (DN 25 to 150 / 1 to 6")
- ASME
 - Class 150 (DN 25 to 300 / 1 to 12")
 - Class 300 (DN 25 to 150 / 1 to 6")
- AS
 - AS 2129: Table E (DN 80 to 300 / 3 to 12")
 - AS 4087: PN 16 (DN 80 to 300 / 3 to 12")
- JIS
 - 10K (DN 50 to 300 / 2 to 12")
 - 20K (DN 25 to 300 / 1 to 12")

Surface roughness

Electrodes: 0.3 to 0.5 μm (12 to 20 μin)
 All data relate to parts in contact with fluid.

GSM/GPRS antenna

- Omnidirectional dipole antenna with 3 m (9.84 ft) connecting cable.
- Connection socket for GSM antenna: SMA socket (female)
- For mounting and connecting the GSM antenna, see →  24.

18.1.11 Human interface

Operating concept

→  47

Local display

Display elements

- Liquid crystal display: unlit, 8-line, 16 characters per line

- Custom configurations for presenting different measured-value and status variables
- Totalizer

Operating elements

- Local operation via plastic-coated keypad
- Quick Start menu for quick commissioning

Config 5800 operating tool

→  51

Remote operation

- via Config 5800 operating tool
- via GSM (Global System for Mobile Communication)/GPRS (General Packet Radio Service)

Languages

- English
- Deutsch
- Italian
- Spanish
- French

18.1.12 Certificates and approvals

CE mark

The measuring system is in conformity with the statutory requirements of the applicable EC Directives.

These are listed in the corresponding EC Declaration of Conformity along with the standards applied. Endress+Hauser confirms successful testing of the device by affixing to it the CE mark.

Drinking water approval

- WRAS BS 6920
- ACS
- NSF 61
- KTW/W270

Other standards and guidelines

- EN 60529: Degrees of protection provided by enclosures (IP code)
- EN 61010-1: Safety requirements for electrical equipment for measurement, control and laboratory use
- IEC/EN 61326: Emission in accordance with Class A requirements

GSM approvals

- EN 301 511 V9.0.2
Global System for Mobile communications (GSM); Harmonized EN for mobile stations in the GSM 900 and GSM 1800 bands covering essential requirements under article 3.2 of the R&TTE directive (1999/5/EC)
- EN 301 489-7 V1.3.1
Electromagnetic compatibility and Radio spectrum Matters (ERM);
ElectroMagnetic Compatibility (EMC) standard for radio equipment and services;
Part 7: Specific conditions for mobile and portable radio and ancillary equipment of digital cellular radio telecommunications systems (GMS and DCS)

- EN 61326
Electrical equipment for measurement, control and laboratory use
EMC requirements - Part 1: General requirements
- EN 60950-1:2006 + A11: 2009 + A1:2010 + A12: 2011
Information technology equipment - Safety - Part 1: General requirements
- 47CFR15 (12/2010) Part 15
RADIO FREQUENCY DEVICES, Subpart B - Unintentional Radiators

Declaration of Conformity

CE mark

The measuring system meets the requirements of EC Directive "Electromagnetic compatibility" (EMC Directive).

- Interference emission: EN 61326: Class A, Industry
- Interference immunity: EN 61326: Industry

A Declaration of Conformity in line with the standards cited above has been submitted and can be viewed at Endress+Hauser.

FCC notice (Federal Communications Commission)

This device generates, uses and can radiate radio frequency energy, and, if not installed and used in accordance with the instruction manual, may cause harmful interference to radio communications. However, there is no guarantee that interference will not occur in a particular installation. If this device does cause harmful interference to radio or television reception, which can be determined by turning the device off and on, the user is encouraged to try to correct the interference by one or more of the following measures:

- Reorient or relocate the receiving antenna
- Increase the separation between the device and receiver
- Connect the device to an outlet on a circuit different from that to which the receiver is connected

To ensure that the device meets current FCC requirements and safety conditions, which restrict both the maximum radio frequency output rating and human exposure to radio frequency radiation, use an antenna with a maximum antenna gain of 2 dBi. Furthermore, a distance of at least 20 cm must be observed between the device antenna and the user's body and everyone in the vicinity of the antenna. This distance must be observed for all applications and uses.

Modifications

The FCC requires the manufacturer to inform users that all modifications made to this device, which are not expressly approved by Endress+Hauser, can void the authority of the user to operate the device.

FCC statement (Federal Communications Commission)

This device complies with Part 15 of the FCC regulations.

Operation is subject to the following two conditions:

- This device cannot cause harmful interference.
- This device must accept any interference received, including interference that may cause undesired operation.

Remarks regarding wireless equipment

The use of wireless devices can be restricted in certain situations or environments. Such restrictions can apply in airplanes, vehicles, hospitals, in the vicinity of explosives, in hazardous areas etc. If you are unsure which directive applies for the use of this device, request usage approval prior to switching on the device.

GSM/GPRS communication

Wireless GSM/GPRS transmission of information

Data can be transmitted to and from the measuring device via wireless communication. Ideal for applications in which the measuring point is installed in a remote location, making tasks like reading counters very time-consuming activities.

As it is possible to configure limit value monitoring with alarms signaled by e-mail or SMS, operators can respond specifically to local changes:

- SMS: receive alarms, query totalizer counter readings, change the device configuration etc.
- E-mail: The data saved by the data logger are sent by e-mail in a defined period of time (e.g. once a day). A CSV-file is attached to the e-mail.

i E-mails can only be sent to an SMTP server that does not require a password and user name. Port 25 normally fulfills these criteria. This must be verified by your e-mail provider.

i It is important to ensure that the signal of the mobile communications network is strong enough to enable the system to dial into the GPRS/GSM network.

Mobile communications network (GSM: Global System for Mobile Communications)

Data can be transmitted via a mobile communications network with the GSM/GPRS modem. The modem can be configured as a point-to-point connection or as a modem that can be openly accessed via the Internet/intranet.

A SIM card from a mobile communications provider is required for the GSM/GPRS mode. The communication is established via the data channel of the SIM card.

Additional activation might be required for this card depending on the GSM/GPRS provider.

i The SIM card must be activated for GPRS operation.

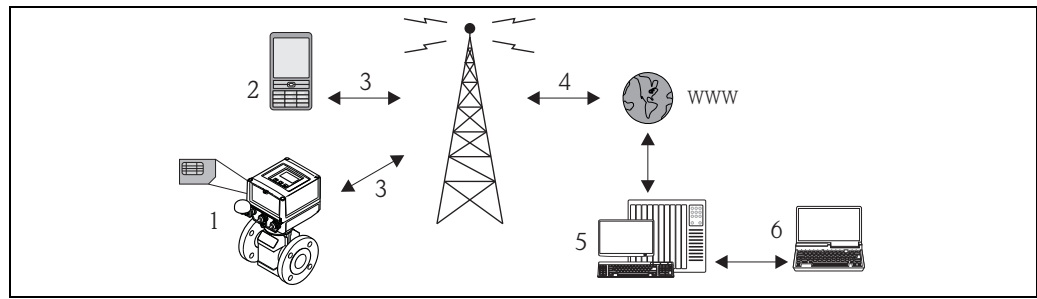

Fig. 65: Operation of the measuring device in the mobile communications network

- 1 Measuring device with SIM card
- 2 Cellular phone
- 3 GSM network
- 4 GPRS network
- 5 Web server (provider)
- 6 Laptop (customer)

GPRS support

GPRS (General Packet Radio Services) is a mobile communications technology that takes advantage of the benefits afforded by package-oriented data transmission and channel bundling.

In contrast to normal connections, an entire channel is not reserved for the duration of the connection between the mobile device and the base station when transmitting data via GPRS. Instead, the data are grouped into data packets which can be transmitted depending on the requirements and capacity.

Higher transmission rates are possible with packet-based data transmission. This allows the measuring system to connect periodically to the Internet, an intranet or a mailbox. Data are then only transmitted if required, such as if a new e-mail is sent or received.

Therefore communication via GPRS-based operation of the measuring system provides the simplest and most cost-effective way of connecting a measuring point periodically to the Internet or an intranet.

Measuring device approval

The measuring device is (optionally) approved as a cold water meter (MI-001) for volume measurement in service subject to legal metrological control in accordance with the European Measuring Instruments Directive 2004/22/EC (MID), type-examination certificate ATLab-I13-001. The device is qualified to OIML R49 and has an OIML Certificate of Conformity (optional).

18.1.13 Accessories

→  106

19 Appendix

19.1 Description of device parameters

19.1.1 Main menu

0 - Quick Start	→ ⓘ 129	For configuring the most important parameters for quick commissioning. To enable and disable the Quick Start function, see the QSTME parameter → ⓘ 150
↓		
1 - Sensor	→ ⓘ 130	For specifying sensor data and setting the sensor: Nominal diameter, calibration factor, zero point, empty pipe detection etc.
↓		
2 - Scales	→ ⓘ 132	For configuring the measuring signal: Full scale values, unit, pulse value/width etc.
↓		
3 - Measure	→ ⓘ 135	For configuring the measurement: Low flow cutoff, measuring mode etc.
↓		
4 - Alarms	→ ⓘ 136	For configuring the alarms: Limit values for total/partial, hysteresis
↓		
5 - Inputs	→ ⓘ 137	For configuring the inputs: Resetting the total/partial, stop counters
↓		
6 - Outputs	→ ⓘ 138	For configuring the outputs: Configuration of the functionality of the outputs
↓		
7 - Communication	→ ⓘ 141	For configuring the communication: Protocols, transmission rates, activation of messaging/mail etc.
↓		
8 - Display	→ ⓘ 150	For configuring the display and controls via the display: Language, resetting the total/partial, totalizers, Quick Setup etc.
↓		
9 - Data logger	→ ⓘ 151	For configuring the data logger: Switch-on, settings, reset etc.
↓		
10 - Diagnostic	→ ⓘ 156	For configuring the diagnostics: Self-test, simulation etc.
↓		
11 - Internal data	→ ⓘ 158	For displaying and setting the internal data: Access code, battery configuration, operating hours etc.

Only available via the operating tool:

GPRS data	→ ⓘ 160	For making connection settings to establish the communication: IP addresses, mail addresses, user information etc.
Auxiliary cmds	→ ⓘ 163	For performing data exchange: Access code, read information on SD card, list of parameters etc.
Process data	→ ⓘ 164	For displaying the process data: Totalizer values, battery state of charge, antenna signal etc.



Note!

For additional information on the individual parameters, see:

- The overview of the parameters in the main menu → 125 ff.
- The description of the individual parameters → 130 ff.

19.1.2 Parameters in the main menu

 Special service-specific and device-specific parameters (Level 3 and above) can only be modified by Endress+Hauser Service staff. These parameters can be read by every user, however. The parameters have a **gray** background in the following description.

Main menu	Parameter name		Parameter description		
	Local display	Operating tool			
1 - Sensor ↓	→ 130	ND	PDIMV	Nominal diameter of the sensor	→ 130
		KA	CFFKA	Calibration factor	→ 130
		Sens.type	SMODL	Sensor type	→ 130
		KZ	CFFKZ	Coefficient KZ	→ 130
		KC	CFFKC	Coefficient KC	→ 130
		TC1	CRCT1	Control constant 1 (coil control)	→ 130
		TC2	CRCT2	Control constant 2 (coil control)	→ 131
		E.p. detect	EPDEN	Enable/disable empty pipe detection (OED)	→ 131
		E.p. thr.	EPDTH	Empty pipe detection threshold	→ 131
		Sensor test	SAVRE	Start sensor test	→ 131
		Zero cal.	-	Start zero point adjustment	→ 131
		Zero res.	-	Reset zero point value	→ 132
	2 - Scales ↓	→ 132	Fs	FRMUT, FRMUV, FRFS1	Flow value, 100 % full scale value
		Temp. u. meas.	TMMUV	Temperature unit	→ 132
		Tot1MU	VTMUT, VTMUV, VTDPP	Display totalizer value	→ 133
		PLS1	VTMUT, VTMUV, OP1PV	Pulse value 1 (incl. unit type and unit)	→ 133
		PLS2	VTMUT, VTMUV, OP2PV	Pulse value 2 (incl. unit type and unit)	→ 134
		TPLS1	OP1PT	Pulse width 1	→ 134
		TPLS2	OP2PT	Pulse width 2	→ 134
		Sg	VMSGC	Density coefficient	→ 134
3 - Measure ↓	→ 135	Cut-off	MFCUT	Value for low flow cutoff	→ 135
		Prof.	MPROF	Frequency of measured value acquisition	→ 135
4 - Alarms ↓	→ 136	Al. max.+	FRAXP	Max. alarm limit value for positive flow	→ 136
		Al. min.+	FRANP	Min. alarm limit value for positive flow	→ 136
		Al. max.-	FRAXN	Max. alarm limit value for negative flow	→ 136
		Al. min.-	FRANN	Min. alarm limit value for negative flow	→ 136
		Hyst.	ATHYS	Hysteresis for alarm limit values	→ 136
5 - Inputs ↓	→ 137	T + reset	VTTPE	Reset totalizer, positive total	→ 137
		P + reset	VTPPE	Reset totalizer, positive total	→ 137
		T - reset	VTTNE	Reset totalizer, negative total	→ 137
		P - reset	VTPNE	Reset totalizer, negative total	→ 137
		Count lock	TCLIE	Enable/disable totalization	→ 137

Main menu	Parameter name		Parameter description
	Local display	Operating tool	
	Calibration	CALIE	Enable/disable calibration → 137
	Alarm	ALFIE	Enable/disable alarm suppression → 137
	Wake-up	WKUIE	Enable/disable automatic switch-on signal → 138
6 - Outputs → 138 ↓	OUT 1	OUT1F	Selection of the output variable → 138
	OUT 1	OU1PT	Regular transmission period → 138
	T. ON	ON1TV	Start regular transmission → 139
	T. OFF	OF1TV	End regular transmission → 139
	OUT 2	OUT2F	Selection of the output variable → 140
	OUT 2	OU2PT	Regular transmission period → 140
	T. ON	ON2TV	Start regular transmission → 140
	T. OFF	OF2TV	End regular transmission → 141
	Pwr scr	PWSRC	Enable supply voltage via output → 141
7 - Communication → 141 ↓	Min. ant.s.	MINAS	Minimum strength of antenna signal → 141
	Send DL	DLGSM	Transmission of data logger data → 142
		DLGTM	Transmission mode → 142
		DLGPT	Interval for regular transmission → 142
	Interv	DLGIV	Period between transmissions → 142
	Time	DLGTV	Time of regular transmission → 142
	Send PD	PRDSM	Transmission of process data → 143
		PRDTM	Transmission mode → 143
		PRDPT	Interval for regular transmission → 143
	Interv	PRDIV	Period between transmissions → 143
	Time	PRDTV	Time of regular transmission → 144
	Send AL	ALRSM	Alarm transmission mode → 144
	T. min AL	ALMNT	Alarm transmission delay time → 144
	Chk SMS	SMSRE	Check SMS → 144
		SMSTM	Check mode → 144
		SMSPT	Interval for regular checking routine → 144
	Interv	SMSIV	Period between checks → 145
	Time	SMSTV	Time of regular checking routine → 145
	SMS wait t	SMSWT	Check duration → 146
	Ck mail	EMLRE	Mail check → 146
		EMLTM	Check mode → 146
		EMLPT	Interval for regular checking routine → 146
	Interv	EMLIV	Period between checks → 146
	Time	EMLTV	Time of regular checking routine → 147
	Clock s	CSYNE	System time check → 147
		CSYTM	Check mode → 147
		CSYPT	Interval for regular checking routine → 147
	Interv	CSYIV	Period between checks → 148
	Time	CSYTV	Time of regular checking routine → 148
	Send events	EVTSE	Transmission of event data → 148
	Roaming	ROAME	Enable/disable roaming → 148

Main menu	Parameter name		Parameter description
	Local display	Operating tool	
Main menu	Send DL	DLSNI	Immediate transmission of data logger data → 148
	Send PD	PRDSI	Immediate transmission of process data → 149
	Send events	EVTSI	Immediate transmission of events → 149
	Send config.	CFGSI	Immediate transmission of configuration → 149
	Clock s	CSYNI	Immediate system time check → 149
	Ck mail	EMLRI	Immediate mail check → 149
	Chk SMS	SMSCI	Immediate SMS check → 149
8 - Display → 150 ↓	Language	LLANG	Select display language → 150
	D.time	ENSDT	Specify time for automatic display switchoff → 150
	Quick start	QSTME	Enable/disable Quick Setup function → 150
	Disp. lock	DLOKE	Enable/disable display lock → 150
	T + reset	VTTPR	Reset totalizer, positive total → 150
	P + reset	VTPPR	Reset totalizer, positive total → 150
	T - reset	VTNTR	Reset totalizer, negative total → 151
	P - reset	VTPNR	Reset totalizer, negative total → 151
9 - Data logger → 151 ↓	SET DATE/TIME	DTIME	Date/time setting → 151
	T.zone	TZONE	Time zone setting → 151
	Acquisition	DLOGE	Enable/disable data logger function → 152
	Double int.	DLI2E	Enable/disable data logger interval mode → 152
	int. 1	DLGSI	Recording interval 1 → 152
	int. 2	DLGS2	Recording interval 2 → 153
		DI2PT	Recording repeat rate → 153
	T. ON	I2ONT	Start recording interval 2 → 153
	T. OFF	I2OFT	End recording interval 2 → 153
	Log T+	DTTPE	Totalizer recording (pos. total) → 154
	Log P+	DTPPE	Totalizer recording (pos. total) → 154
	Log T-	DTTNE	Totalizer recording (neg. total) → 154
	Log P-	DTPNE	Totalizer recording (neg. total) → 154
	Log NT	DLTNE	Totalizer recording (net total (balance)) → 154
	Log NP	DLPNE	Totalizer recording (net total (balance)) → 154
	Log Q	DFLWE	Flow recording → 155
	Log STAT	DTMSE	Measuring statistics recording → 155
	M. units	DLUSE	Unit recording → 155
	% values	DLPVE	Percentages recording → 155
Separator	DLFSC	Character separator → 155	
10 - Diagnostic → 156 ↓	Calibration	CALIC	Start calibration → 156
	Sensor test	STSTC	Start sensor test → 156
	Self test	ATSIC	Start self-test → 156
	Simulation	MSIEN	Enable/disable simulation → 157
	Display data	-	Display measured values and settings → 157
	Standby	STBYC	Standby function → 157
	Gprs test	GTEST	Start GPRS test → 157

Main menu	Parameter name		Parameter description
	Local display	Operating tool	
	Read SDC info	SDSTA	Display free SD card space → 157
	Format SDC	-	Start formatting SD card → 157
11 - Internal data → 158	L2 code	L2ACD	Enter Level 2 access codes → 158
	Load fact. data	LFDIC	Load parameter factory setting → 159
	Save fact. data	SFDIC	Save parameter setting → 159
	Memory reset	CMRIC	Reset parameter to factory setting → 159
	B2	BT2HE	Activation of battery connected in terminal B2 → 160
	KF	CFFKF	Coefficient KF → 159
	KT	CFFKT	Coefficient KT → 159
	KR	CFFKR	Coefficient KR → 159
	KS	CFFKS	Coefficient KS → 159

19.2 Access to parameters

19.2.1 Operation via the onsite display or Config 5800 operating tool

The measuring device can be operated via:

- Local display → 47
- Config 5800 operating tool → 51

There are two ways of operating the device if using the Config 5800 operating tool:

- Via the integrated user interface (corresponds to local operation) → 56
- Via the parameter menu as a tree structure → 58

19.2.2 User roles and related access authorization

Access to parameters

The parameters in the measuring device have different access levels.

The majority of the parameters can be configured without any restrictions (up to Level 2).

 Level 2 parameters can be protected by an individual password → 62.

Special service-specific and device-specific parameters (Level 3 and above) can only be modified by Endress+Hauser Service staff. These parameters can be read by every user, however. The parameters have a **gray** background in the description of the device parameters.

 If a user attempts to change a service-specific or device-specific parameter, the prompt "L3 Code =0..." appears on the onsite display. If using the Config 5800 operating tool, the error message "5:Access error" appears on the display.

Access to parameters that are only available via the Config 5800 operating tool

The parameters in parameter groups 0 "Quick-Start" to 11 "Internal Data" can be configured both via local operation and via the parameter menu of the operating tool.

The parameters in the parameter groups "GRPS data", "Auxiliary cmds" and "Process data" can **only be configured via the parameter menu** of the operating tool → 58.

 Parameter groups that are used to configure or establish communication via the GSM/GPRS modem are only available via the Config 5800 operating tool.

Custody transfer (optional):

After putting the device into circulation or after sealing the device, operation via the onsite display, via the Config 5800 software operating tool or via GSM/GPRS is only possible to a limited extent.

19.2.3 Interdependent parameters

There is a dependency between some parameters. If settings are made in these parameters, this can mean that other associated parameters are available which only then appear on the onsite display.

Example

If the OUT1 parameter under 6 - OUTPUTS is switched from OFF to PLS, the PLS1 parameter is available in parameter group 2 - SCALES.

In the following parameter descriptions, a "Note" symbol indicates the parameters that depend on other parameters, such as PLS1 for example.

19.3 Quick Start menu

The Quick Start menu is used to commission the measuring device quickly. Parameters that are required for initial commissioning are called up from different menus.

The Quick Start menu is launched automatically during initial commissioning. Via the Quick Start parameter (QSTME → 150) it is possible to enable or disable the automatic launch of Quick Start parameters when the user switches from the display mode to the parameter entry mode.

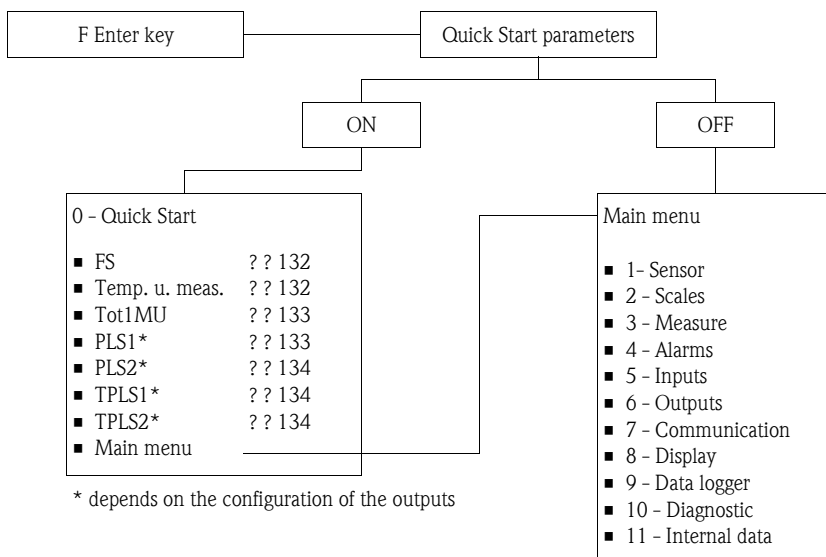



Note!
This function is locked in custody transfer!

19.4 Parameter descriptions

















Note!

Used Symbols

 A0011200	This function is locked in custody transfer!
	Only volume units are permitted in custody transfer!





19.4.1 Parameter group 1 - Sensor











Parameter group 1 - Sensor			
	Local display	Operating tool	Parameter description
 A0011200	ND	PDIMV	Enter the nominal diameter. Onsite display (example): ND = mm 00025 User entry 0 to 10000 [mm]
 A0011200	KA	CFFKA	Enter the calibration factor KA. Onsite display (example): KA = +03.000 User entry ±0.00000...±99.9999  Note! The calibration factor is indicated on the sensor nameplate.
 A0011200	Sens.type	SMODL	Enter the sensor type. Onsite display (example): KA = 200 User entry 0...255 Enter the sensor type. <ul style="list-style-type: none"> ■ 200: for sensor types <ul style="list-style-type: none"> - Promag L ≤ DN300 - Promag W, without optional IP68 version ■ 201: for sensor types <ul style="list-style-type: none"> - Promag L > DN 300 - Promag W ≤ DN300, with optional IP68 version
 A0011200	KZ	CFFKZ	Enter the coefficient KZ. Onsite display (example): KZ = +000000 User entry ±0...±999999
 A0011200	KC	CFFKC	Enter the calibration factor KC. Onsite display (example): Ki = 1.0000 User entry 0.0100...6.5000
 A0011200	TC1	CRCT1	Enter control constant 1 for coil current control. Onsite display (example): TC1 = ms 008 User entry 0 to 99 ms













Parameter group 1 - Sensor			
	Local display	Operating tool	Parameter description
 A0011200	TC2	CRCT2	Enter control constant 2 for coil current control. Onsite display (example): TC2 = ms 002 User entry 0 to 99 ms
	E.p. detect	EPDEN	Enable/disable empty pipe detection (OED). Open electrode method is used. Onsite display (example): E. P. detect = OFF Options OFF - ON
	E.p. thr.	EPDTH	Enter the limit for empty pipe detection(OED). Low value = OED response very sensitive. Default 100 to 150 Onsite display (example): E. p. thr. = 100 User entry 20...250
 A0011200	Sensor test	SAVRE	Enable or disable automatic sensor verification every hour. Onsite display (example): Sensor test = OFF Options OFF - ON
	-	SCRES	Resistance value of coil system.
	-	SCTM1	Reference value 1 for sensor electronics.
	-	SCTM2	Reference value 2 for sensor electronics.
	-	SCTRF	Reference temperature for sensor electronics.
 A0011200	-	CRVRF	Enter the default value for the coil current. User entry 0 to 255 (188 $\hat{=}$ 20 mA)
 A0011200	-	CRRMA	Enter the default value for the coil current control.  Note! This parameter should not be modified.
 A0011200	Zero cal.	-	Start a zero point calibration. During zero point calibration, the zero point is recalculated and set.  Note! Even a very low flow during the calibration routine can cause incorrect zero point calibration, resulting in inaccurate measurement results. For this reason, ensure the following when performing the calibration routine: <ul style="list-style-type: none"> ▪ The measuring tube is completely filled with fluid ▪ There is no flow To start the zero point calibration. Select EXECUTE → press and hold  key > 1 second. During the calibration routine a counter that counts from 0 to 600 appears on the display. When the calibration routine is finished, the message "DONE" briefly appears on the display. Onsite display (example): Zero cal. Options EXECUTE

Parameter group 1 - Sensor			
	Local display	Operating tool	Parameter description
 A0011200	Zero res.	–	Reset the zero point to the order configuration. Onsite display (example): Zero res. Options EXECUTE



19.4.2 Parameter group 2 - Scales

Parameter group 2 - Scales			
	Local display	Operating tool	Parameter description
 A0011200	Fs	<ul style="list-style-type: none"> ▪ FRMUT ▪ FRMUV ▪ FRFS1 	Enter a flow value that acts as the 100 % full scale value and select the unit for the 100 % full scale value. Onsite display (example): Fs = dm ³ /s X.XXXX To select/enter a value, position the cursor on: – dm ³ = select unit – " " (space) = select unit type – X.XXX = select number of decimal places
 A0011200		FRMUT	Options (unit type) <ul style="list-style-type: none"> ▪ SI unit, volume ▪ SI unit, weight ▪ Imperial or US unit, volume ▪ Imperial or US unit, weight
 A0011200		FRMUV	Options (unit type, time unit) <ul style="list-style-type: none"> ▪ SI unit ml/d, ml/h, ml/m, ml/s, cm³/d, cm³/h, cm³/m, cm³/s, l/d, l/h, l/m, l/s, dm³/d, dm³/h, dm³/m, dm³/s, dal/d, dal/h, dal/m, dal/s, hl/d, hl/h, hl/m, hl/s, m³/d, m³/h, m³/m, m³/s, Ml/d, Ml/h, Ml/m, Ml/s ▪ Imperial or US unit in³/d, in³/h, in³/m, in³/s, Gal/d, Gal/h, Gal/m, Gal/s, IGL/d, IGL/h, IGL/m, IGL/s, ft³/d, ft³/h, ft³/m, ft³/s, bbl/d, bbl/h, bbl/m, bbl/s, BBL/d, BBL/h, BBL/m, BBL/s, hf³/d, hf³/h, hf³/m, hf³/s, KGL/d, KGL/h, KGL/m, KGL/s, IKG/d, IKG/h, IKG/m, IKG/s, kf³/d, kf³/h, kf³/m, kf³/s, ttG/d, ttG/h, ttG/m, ttG/s, Aft/d, Aft/h, Aft/m, Aft/s, MGL/d, MGL/h, MGL/m, MGL/s, IMG/d, IMG/h, IMG/m, IMG/s
 A0011200		FRFS1	User entry (full scale value) 0.2000 to 5.0000 [dm ³ /s]  Note! For additional information on the 100 % full scale value and the related parameters, see → 169.
	Temp. u. meas.	TMMUV	Select the unit for the temperature. Onsite display (example): Temp. u. meas. = °C Options <ul style="list-style-type: none"> ▪ °C ▪ °F

Parameter group 2 - Scales			
	Local display	Operating tool	Parameter description
	Tot1MU	<ul style="list-style-type: none"> ■ VTMUT ■ VTMUV ■ VTDPP 	<p>Select the unit and the display mode for the totalizer value.</p> <p> Note! The option selected here for the unit type (VTMUT) and the unit (VTMUV) also defines the units for the PLS1 (→  133) and PLS2 (→  134) parameters. -</p> <p>Onsite display (example): Tot1Mu = dm³ X.XXXX</p> <p>To select/enter a value, position the cursor on:</p> <ul style="list-style-type: none"> - dm³ = select unit - "" (space) = select unit type - X.XXX = select number of decimal places
		VTMUT	<p>Options (unit type)</p> <ul style="list-style-type: none"> ■ SI unit, volume ■ SI unit, weight ■ Imperial or US unit, volume ■ Imperial or US unit, weight
		VTMUV	<p>Options (unit)</p> <p>Depends on the option selected for "Unit type"</p> <ul style="list-style-type: none"> ■ ml, cm³, l, dm³, dal, hl, m³ ■ in³, Gal, IGL, ft³, bbl, BBL, KGL, IKG, Aft, MGL, IMG ■ oz, lb, ton ■ g, kg, t
		VTDPP	<p>Options (number of decimal places)</p> <ul style="list-style-type: none"> ■ 999999999 ■ 99999999.9 ■ 9999999.99 ■ 999999.999
	PLS1	<ul style="list-style-type: none"> ■ VTMUT ■ VTMUV ■ OP1PV 	<p> Note! This parameter is only available if the PLS, PLS+ or PLS- option is selected in the OUT 1 parameter →  138.</p> <p>Select the unit and enter the pulse value for output 1.</p> <p> Note! The option selected here for the unit type (VTMUT) and the unit (VTMUV) also defines the units for the Tot1MU (→  133) and PLS2 (→  134) parameters. -</p> <p>Onsite display (example): PLS1 = ml X.XXX</p> <p>To select/enter a value, position the cursor on:</p> <ul style="list-style-type: none"> - ml = select unit - "" (space) = select unit type - X.XXX = enter pulse value
		VTMUT	<p>Options (unit type)</p> <ul style="list-style-type: none"> ■ SI unit, volume ■ SI unit, weight ■ Imperial or US unit, volume ■ Imperial or US unit, weight
		VTMUV	<p>Options (unit)</p> <p>Depends on the option selected for "Unit type"</p> <ul style="list-style-type: none"> ■ ml, cm³, l, dm³, dal, hl, m³ ■ in³, Gal, IGL, ft³, bbl, BBL, KGL, IKG, Aft, MGL, IMG ■ oz, lb, ton ■ g, kg, t
		OP1PV	<p>User entry (pulse value)</p> <p>0.00001...99999.9</p>

Parameter group 2 - Scales			
	Local display	Operating tool	Parameter description
	PLS2	<ul style="list-style-type: none"> ▪ VTMUT ▪ VTMUV ▪ OP2PV 	<p> Note! This parameter is only available if the PLS, PLS+ or PLS- option is selected in the OUT 2 parameter →  140.</p> <p>Select the unit and enter the pulse value for output 2.</p> <p> Note! The option selected here for the unit type (VTMUT) and the unit (VTMUV) also defines the units for the Tot1MU (→  133) and PLS1 (→  133) parameters. -</p> <p>Onsite display (example): PLS2 = ml X.XXX</p> <p>To select/enter a value, position the cursor on:</p> <ul style="list-style-type: none"> - ml = select unit - " " (space) = select unit type - X.XXX = enter pulse value
		VTMUT	<p>Options (unit type)</p> <ul style="list-style-type: none"> ▪ SI unit, volume ▪ SI unit, weight ▪ Imperial or US unit, volume ▪ Imperial or US unit, weight
		VTMUV	<p>Options (unit)</p> <p>Depends on the option selected for "Unit type"</p> <ul style="list-style-type: none"> ▪ ml, cm³, l, dm³, dal, hl, m³ ▪ in³, Gal, IGL, ft³, bbl, BBL, KGL, IKG, Aft, MGL, IMG ▪ oz, lb, ton ▪ g, kg, t
		OP2PV	<p>User entry (pulse value)</p> <p>0.00001 to 99999.9 [dm³]</p>
	TPLS1	OP1PT	<p> Note! This parameter is only available if the PLS, PLS+ or PLS- option is selected in the OUT 1 parameter →  138.</p> <p>Enter the pulse width for the pulse value at output 1.</p> <p>Onsite display (example): TPLS1 = ms 0010.0</p> <p>User entry</p> <p>8.0 to 7999.9 (PULS.2>F.MAX) [ms]</p>
	TPLS2	OP2PT	<p> Note! This parameter is only available if the PLS, PLS+ or PLS- option is selected in the OUT 2 parameter →  140.</p> <p>Enter the pulse width for the pulse value at output 2.</p> <p>Onsite display (example): TPLS2 = ms 0010.0</p> <p>User entry</p> <p>8.0 to 7999.9 (PULS.2>F.MAX) [ms]</p>
 A0011200	Sg	VMSGC	<p> Note! This parameter is only available if a mass unit is selected in the Tot1MU parameter →  133.</p> <p>Enter the density coefficient for converting volume to mass.</p> <p>Onsite display (example): Sg = kg/dm³ 01.0000</p> <p>User entry</p> <p>0.1000 to 10.0000 (kg/dm³)</p>

19.4.3 Parameter group 3 - Measure

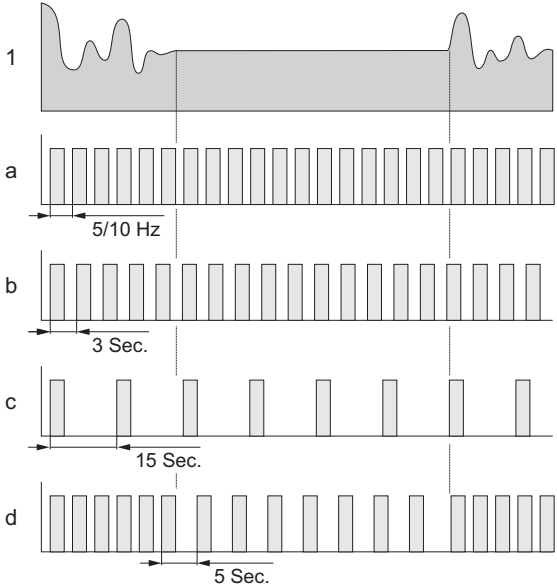





Parameter group 3 - Measure			
	Local display	Operating tool	Parameter description
 A0011200	Cut-off	MFCUT	Select the value for low flow cutoff in % in relation to the full scale value. If the flow value drops below the value for low flow cutoff, the measuring device indicates there is zero flow. Onsite display (example): Cut-off = % 00.0 Options 0.0...25.0 [%]
	Prof.	MPROF	Select the profile for measured value acquisition. Onsite display (example): Prof. = SMART Options <ul style="list-style-type: none"> ■ CONT.PWR The device records the maximum number of measured values (depending on the DN of the sensor, 5 or 10 Hz).  Note! The CONT.PWR option is only available if the energy saving mode is disabled in the ENSVE parameter → 174. ■ AVERAGE The device records the measured value every 3 seconds. ■ MAX. LIVE The device records the measured value every 15 seconds. ■ SMART The device automatically adapts the measured value acquisition cycle to the current flow profile. In doing so, the device records the measured value every 5 seconds. The device increases the frequency of the measured value acquisition cycle if it detects a change in the flow profile.  <p style="text-align: right; font-size: small;">A0017032</p> <p><i>Fig. 66: Operating principle of the different measured value acquisition methods</i></p> <p> 1 Flow profile a CONT.PWR b AVERAGE c MAX. LIVE d SMART </p>

Parameter group 3 - Measure			
	Local display	Operating tool	Parameter description
 A0011200	–	MFCT2	Select the internal value for low flow cutoff in % in relation to the full scale value. If the flow value drops below the value for low flow cutoff, the device indicates there is zero flow. Options 0.0...25.0 %
	–	ENSVE	Enable/disable the energy-saving mode. The energy-saving mode should be enabled (ON) if the unit is powered by batteries. Options OFF - ON

19.4.4 Parameter group 4 - Alarms



Parameter group 4 - Alarms		
Local display	Operating tool	Parameter description
Al. max.+	FRAXP	Enter a maximum alarm limit value for positive flow. The alarm limit value is indicated in % in relation to the full scale value. Onsite display (example): Al. max+ = % 000 User entry 0...125 %
Al. min.+	FRANP	Enter a minimum alarm limit value for positive flow. The alarm limit value is indicated in % in relation to the full scale value. Onsite display (example): Al. min+ = % 000 User entry 0...125 %
Al. max.-	FRAFN	Enter a maximum alarm limit value for negative flow. The alarm limit value is indicated in % in relation to the full scale value. Onsite display (example): Al. max- = % 000 User entry 0...125 %
Al. min.-	FRANN	Enter a minimum alarm limit value for negative flow. The alarm limit value is in % in relation to the full scale value. Onsite display (example): Al. min- = % 000 User entry 0...125 %
Hyst.	ATHYS	Enter the hysteresis for all the alarm limit values. Onsite display (example): Hyst. = % 00 User entry 0...25 %







19.4.5 Parameter group 5 - Inputs





Parameter group 5 - Inputs			
	Local display	Operating tool	Parameter description
 A0011200	T + reset	VTPE	Enable a possible reset of the totalizer positive total via the digital input. If enabled (= ON) and if the signal at the digital input drops (1 → 0), the device performs a reset. Onsite display (example): T+ reset = OFF Options OFF - ON
 A0011200	P + reset	VTPE	Enable a possible reset of the totalizer positive total via the digital input. If enabled (= ON) and if the signal at the digital input drops (1 → 0), the device performs a reset. Onsite display (example): P+ reset = OFF Options OFF - ON
 A0011200	T - reset	VTNE	Enable a possible reset of the totalizer negative total via the digital input. If enabled (= ON) and if the signal at the digital input drops (1 → 0), the device performs a reset. Onsite display (example): T- reset = OFF Options OFF - ON
 A0011200	P - reset	VTPE	Enable a possible reset of the totalizer negative total via the digital input. If enabled (= ON) and if the signal at the digital input drops (1 → 0), the device performs a reset. Onsite display (example): P- reset = OFF Options OFF - ON
 A0011200	Count lock	TCLIE	Enable the device to stop the totalizer from totalizing via the digital input. If enabled (= ON) is selected in this parameter and if there is an active signal (0 → 1) at the digital input, the device stops totalizing. Onsite display (example): Count lock = OFF Options OFF - ON
 A0011200	Calibration	CALIE	Enable the device to start calibration via the digital input. If enabled (= ON) is selected in this parameter and if there is an active signal (0 → 1) at the digital input, the device performs a calibration. Onsite display (example): Calibration = OFF Options OFF - ON
	Alarm	ALFIE	Enable the alarm to be suppressed for the status input. Onsite display (example): Alarm = OFF Options OFF - ON





Parameter group 5 - Inputs			
	Local display	Operating tool	Parameter description
 A0011200	Wake-up	WKUIE	Enable the wake-up function via the status input. Onsite display (example): Wake-Up = OFF Options OFF – ON

19.4.6 Parameter group 6 - Outputs



Parameter group 6 - Outputs		
Local display	Operating tool	Parameter description
OUT 1	OUT1F	Select the output variable for output 1. Onsite display (example): OUT1 = DIRECT. DR. Options <ul style="list-style-type: none"> ▪ OFF ▪ MAX. Q+; MIN. Q+; MX+MN Q+ ▪ MAX. Q-; MIN. Q-; MX+MN Q- ▪ MX+MN Q ▪ MX+MN ALL ▪ P. EMPTY ▪ HARDW.AL. ▪ OVR.RANGE ▪ ALL ALARMS ▪ DIRECT. DR. (direct control of the output signal) ▪ F. SIGN (specified flow direction, negative flow = ON) ▪ PLS+ ▪ PLS- ▪ PLS
-	OUT1C	 Note! This parameter is only available if the DIRECT DR. option is selected in the OUT 1 (OUT1F) parameter and the time information 00:00:00 is set in the T. ON and T. OFF parameters. Direct control/change of status of the output signal at output 1. Options OFF – ON
OUT 1	OU1PT	 Note! This parameter is only available if the DIRECT DR. option is selected in the OUT 1 (OUT1F) parameter. Select the time frame in which the output signal should be transmitted via output 1. Specify the associated times via the T. ON and T. OFF parameters. Onsite display (example): OUT1 = HOURLY Options <ul style="list-style-type: none"> ▪ HOURLY ▪ DAILY ▪ WEEKLY ▪ MONTHLY







Parameter group 6 - Outputs		
Local display	Operating tool	Parameter description
T. ON	ON1TV	<p> Note! This parameter is only available if the DIRECT DR. option is selected in the OUT 1 (OUT1F) parameter.</p> <p>Enter the time to activate the output signal via output 1.</p> <p>Onsite display (example): T. ON = 10d12h30m (d = day/h = hour/m = minute)</p> <p>User entry 00d00h00m</p> <p> Note! The entry options depend on the time frame set in the OUT 1 (OU1PT) parameter. If the HOURLY option is selected, for example, the value for the day (d) can be changed in this parameter but it is reset when the setting is saved.</p> <p>Example:</p> <ul style="list-style-type: none"> ▪ Time frame selected in the OUT 1 (OU1PT) parameter: MONTHLY ▪ Time for the start of transmission (T. ON): 10d 12h 30m <p>✓ Transmission starts: at 12:30 on the 10th of each month</p> <p> Note! After parameterization of T.ON (00d00h00m), the output can be activated (OUT1C=1) or deactivated (OUT1C=0) by SMS; e.g. to switch on or off an external device.</p>
T. OFF	OF1TV	<p> Note! This parameter is only available if the DIRECT DR. option is selected in the OUT 1 (OUT1F) parameter.</p> <p>Enter the time to deactivate the output signal via output 1.</p> <p>Onsite display (example): T. OFF = 10d13h00m (d = day/h = hour/m = minute)</p> <p>User entry 00d00h00m</p> <p> Note! The entry options depend on the time frame set in the OUT 1 (OU1PT) parameter. If the HOURLY option is selected, for example, the value for the day (d) can be changed in this parameter but it is reset when the setting is saved.</p> <p>Example:</p> <ul style="list-style-type: none"> ▪ Time frame selected in the OUT 1 (OU1PT) parameter: MONTHLY ▪ Time when transmission ends (T. OFF): 10d 13h 00m <p>✓ Transmission ends: at 13:00 on the 10th of each month</p> <p> Note! After parameterization of T.OFF (00d00h00m), the output can be activated (OUT1C=1) or deactivated (OUT1C=0) by SMS; e.g. to switch on or off an external device.</p>

Parameter group 6 - Outputs		
Local display	Operating tool	Parameter description
OUT 2	OUT2F	<p>Select the output variable for output 2.</p> <p>Onsite display (example): OUT2 = DIRECT. DR.</p> <p>Options</p> <ul style="list-style-type: none"> ▪ OFF ▪ MAX. Q+; MIN. Q+; MX+MN Q+ ▪ MAX. Q-; MIN. Q-; MX+MN Q- ▪ MX+MN ALL ▪ EMPTY ▪ HARDW.AL. ▪ OVR.RANGE ▪ ALL.ALARMS ▪ DIRECT. DR. (direct control of the output signal) ▪ F. SIGN (specified flow direction, negative flow = ON) ▪ PLS+ ▪ PLS- ▪ PLS
-	OUT2C	<p> Note!</p> <p>This parameter is only available if the DIRECT DR. option is selected in the OUT 2 (OUT2F) parameter and the time information 00:00:00 is set in the T. ON and T. OFF parameters.</p> <p>Direct control/change of status of the output signal at output 2.</p> <p>Options</p> <p>OFF – ON</p>
OUT 2	OU2PT	<p> Note!</p> <p>This parameter is only available if the DIRECT DR. option is selected in the OUT 2 (OUT2F) parameter.</p> <p>Select the time frame in which the output signal should be transmitted via output 2. Specify the associated times via the T. ON and T. OFF parameters.</p> <p>Onsite display (example): OUT2 = HOURLY</p> <p>Options</p> <ul style="list-style-type: none"> ▪ HOURLY ▪ DAILY ▪ WEEKLY ▪ MONTHLY
T. ON	ON2TV	<p> Note!</p> <p>This parameter is only available if the DIRECT DR. option is selected in the OUT 2 (OUT2F) parameter.</p> <p>Enter the time to activate the output signal via output 2.</p> <p>Onsite display (example): T. ON = 10d12h30m (d = day/h = hour/m = minute)</p> <p>User entry 00d00h00m</p> <p> Note!</p> <p>The entry options depend on the time frame set in the OUT 2 (OU2PT) parameter. If the HOURLY option is selected, for example, the value for the day (d) can be changed in this parameter but it is reset when the setting is saved.</p> <p>Example:</p> <ul style="list-style-type: none"> ▪ Time frame selected in the OUT 2 (OU2PT) parameter: MONTHLY ▪ Time for the start of transmission (T. ON): 10d 12h 30m <p>✓ Transmission starts: at 12:30 on the 10th of each month</p> <p> Note!</p> <p>After parameterization of T.ON (00d00h00m), the output can be activated (OUT2C=1) or deactivated (OUT2C=0) by SMS; e.g. to switch on or off an external device.</p>





Parameter group 6 - Outputs		
Local display	Operating tool	Parameter description
T. OFF	OF2TV	<p> Note! This parameter is only available if the DIRECT DR. option is selected in the OUT 2 (OUT2F) parameter.</p> <p>Enter the time to deactivate the output signal via output 2.</p> <p>Onsite display (example): T. OFF = 10d13h00m (d = day/h = hour/m = minute)</p> <p>User entry 00d00h00m</p> <p> Note! The entry options depend on the time frame set in the OUT 2 (OU2PT) parameter. If the HOURLY option is selected, for example, the value for the day (d) can be changed in this parameter but it is reset when the setting is saved.</p> <p>Example:</p> <ul style="list-style-type: none"> ■ Time frame selected in the OUT 2 (OU2PT) parameter: MONTHLY ■ Time when transmission ends (T. OFF): 10d 13h 00m <p>✓ Transmission ends: at 13:00 on the 10th of each month</p> <p> Note! After parameterization of T.OFF (00d00h00m), the output can be activated (OUT2C=1) or deactivated (OUT2C=0) by SMS; e.g. to switch on or off an external device.</p>
Pwr scr	PWSRC	<p>Switch the power supply from the output on and off, e.g. from a passive to an active pulse.</p> <p>Onsite display (example): T. OFF = ON</p> <p>Options OFF – ON</p> <p>Example: ON = active pulse output</p> <p> Note! Activating this option drains the battery faster.</p>







19.4.7 Parameter group 7 - Communication







Parameter group 7 - Communication		
Local display	Operating tool	Parameter description
Min. ant.s.	MINAS	<p>Enter the minimum antenna receiver signal strength that is needed. If this value is not reached, communication with the GSM/GPRS network is not established.</p> <p>Onsite display (example): Min. ant. s. = 30 %</p> <p>User entry 0...99 %</p>
<p> For information on sending the data of the data logger and interdependencies between the associated parameters, →  165.</p>		







Parameter group 7 - Communication		
Local display	Operating tool	Parameter description
Send DL	DLGSM	Select the format for transmitting the data from the data logger. Onsite display (example): Send DL = mail Options <ul style="list-style-type: none"> ▪ OFF (no check is performed) ▪ mail
	DLGTM	 Note! This parameter is only available if the Send DL (DLGSM) parameter is selected. Select whether the data are always transmitted after a set interval or regularly at a set time (periodically). Onsite display (example): Send DL = PERIODIC Options <ul style="list-style-type: none"> ▪ PERIODIC ▪ INTERVAL
	DLGPT	 Note! This parameter is only available if the PERIODIC option is selected in the Send DL (DLGTM) parameter. Select the time frame in which transmission should regularly take place. Specify the associated time via the Time parameter (→  142). Onsite display (example): Send DL = HOURLY Options <ul style="list-style-type: none"> ▪ HOURLY ▪ DAILY ▪ WEEKLY ▪ MONTHLY
Interv	DLGIV	 Note! This parameter is only available if the INTERVAL option is selected in the Send DL (DLGTM) parameter. Enter the interval after which transmission takes place. Onsite display (example): Interv = 00d12h30m User entry 00d00h00m (d = days, h = hours, m = minutes) Example: If 00d 12h 30m is entered as the interval, the device transmits the data from the data logger every 12 hours and 30 minutes (from the moment the entry is saved).
Time	DLGTV	 Note! This parameter is only available if the PERIODIC option is selected in the Send DL (DLGTM) parameter. Enter the time for regular transmission. Onsite display (example): Time = 00d12h30m User entry 00d00h00m (d = days, h = hours, m = minutes)  Note! The entry options depend on the time frame set in the Send DL (DLGPT) parameter. If the HOURLY option is selected, for example, the value for the day (d) can be changed in this parameter but it is reset when the setting is saved. Example: <ul style="list-style-type: none"> ▪ Time frame selected in the SendDL (DLGPT) parameter: MONTHLY ▪ Time for transmission: 10d 12h 30m  The system checks for e-mails at 12:30 on the 10th of each month.







Parameter group 7 - Communication		
Local display	Operating tool	Parameter description
 For information on sending the process data and interdependencies between the associated parameters, →  166.		
Send PD	PRDSM	Select the format for transmitting the process data. Onsite display (example): Send PD = mail Options <ul style="list-style-type: none"> ▪ OFF (no check is performed) ▪ mail ▪ SMS ▪ m+SMS (mail and messaging)
	PRDTM	 Note! This parameter is only available if the OFF option is not selected in the Send PD (PRDSM) parameter. Select whether the data are always transmitted after a set interval or regularly at a set time (periodically). Onsite display (example): Send PD = PERIODIC Options <ul style="list-style-type: none"> ▪ PERIODIC ▪ INTERVAL
	PRDPT	 Note! This parameter is only available if the PERIODIC option is selected in the Send PD (PRDTM) parameter. Select the time frame in which transmission should regularly take place. Specify the associated time via the Time parameter (→  144). Onsite display (example): Send PD = HOURLY Options <ul style="list-style-type: none"> ▪ HOURLY ▪ DAILY ▪ WEEKLY ▪ MONTHLY
Interv	PRDIV	 Note! This parameter is only available if the INTERVAL option is selected in the Send PD (PRDTM) parameter. Enter the interval after which transmission takes place. Onsite display (example): Interv = 00d12h30m User entry 00d00h00m (d = days, h = hours, m = minutes) Example: If 00d 12h 30m is entered as the interval, the device transmits the process data every 12 hours and 30 minutes (from the moment the entry is saved).









Parameter group 7 - Communication		
Local display	Operating tool	Parameter description
Time	PRDTV	<p> Note! This parameter is only available if the PERIODIC option is selected in the Send PD (PRDTM) parameter.</p> <p>Enter the time for regular transmission.</p> <p>Onsite display (example): Time = 00d12h30m</p> <p>User entry 00d00h00m (d = days, h = hours, m = minutes)</p> <p> Note! The entry options depend on the time frame set in the Send PD (PRDPT) parameter. If the HOURLY option is selected, for example, the value for the day (d) can be changed in this parameter but it is reset when the setting is saved.</p> <p>Example:</p> <ul style="list-style-type: none"> ▪ Time frame selected in the Send PD (PRDPT) parameter: MONTHLY ▪ Time for transmission: 10d 12h 30m <p>✓ The system checks for e-mails at 12:30 on the 10th of each month.</p>
Send AL	ALRSM	<p>Select the format for transmitting the alarms. Once an alarm is present, it will be transmitted immediately.</p> <p>Onsite display (example): Send AL = mail</p> <p>Options</p> <ul style="list-style-type: none"> ▪ 0 OFF (no transmission takes place) ▪ 1 mail ▪ 2 SMS ▪ 3 m+SMS (mail and messaging)
T. min AL	ALMNT	<p>Enter a delay time between the individual alarm transmission times. The delay time prevents a high transmission frequency since the device only transmits the next active alarm when the time entered has elapsed.</p> <p>Onsite display (example): T. min AL = 30m00s</p> <p>User entry 00m 00s (m = minutes, s = seconds)</p>
<p> For information on checking the SMS inbox and interdependencies between the associated parameters, →  167.</p>		

Parameter group 7 - Communication		
Local display	Operating tool	Parameter description
Chk SMS	SMSRE	<p>Enable/disable the system to check for new text messages (SMS). Onsite display (example): Chk SMS = ON</p> <p>Options OFF – ON</p>
	SMSTM	<p> Note! This parameter is only available if the ON option is selected in the Chk SMS (SMSRE) parameter.</p> <p>Select whether the system should always run a check after a set interval or regularly at a set time (periodically).</p> <p>Onsite display (example): Chk SMS = PERIODIC</p> <p>Options</p> <ul style="list-style-type: none"> ▪ PERIODIC ▪ INTERVAL
	SMSPT	<p> Note! This parameter is only available if the PERIODIC option is selected in the Chk SMS (SMSTM) parameter.</p> <p>Select the time frame in which the inbox should be checked regularly. Specify the associated time via the Time parameter (→  145).</p> <p>Onsite display (example): Chk SMS = HOURLY</p> <p>Options</p> <ul style="list-style-type: none"> ▪ HOURLY ▪ DAILY ▪ WEEKLY ▪ MONTHLY
Interv	SMSIV	<p> Note! This parameter is only available if the INTERVAL option is selected in the Chk SMS (PRDTM) parameter.</p> <p>Enter the interval after which the check takes place.</p> <p>Onsite display (example): Interv = 00d12h30m</p> <p>User entry 00d00h00m (d = days, h = hours, m = minutes)</p> <p>Example: If 00d 12h 30m is entered as the interval, the device checks the SMS inbox every 12 hours and 30 minutes (from the moment the entry is saved).</p>
Time	SMSTV	<p> Note! This parameter is only available if the PERIODIC option is selected in the Chk SMS (PRDTM) parameter.</p> <p>Enter the time for the regular check.</p> <p>Onsite display (example): Time = 00d12h30m</p> <p>User entry 00d00h00m (d = days, h = hours, m = minutes)</p> <p> Note! The entry options depend on the time frame set in the Chk SMS (SMSPT) parameter. If the HOURLY option is selected, for example, the value for the day (d) can be changed in this parameter but it is reset when the setting is saved.</p> <p>Example:</p> <ul style="list-style-type: none"> ▪ Time frame selected in the Chk SMS (SMSPT) parameter: MONTHLY ▪ Time when check is performed: 10d 12h 30m <p>✓ The system checks for e-mails at 12:30 on the 10th of each month.</p>







Parameter group 7 - Communication		
Local display	Operating tool	Parameter description
SMS wait t	SMSWT	Enter how long the system checks the SMS inbox for new messages. Onsite display (example): SMS wait t = s 060 User entry 20 to 250 [s]
	For information on checking the mail inbox and interdependencies between the associated parameters, →  168.	
Ck mail	EMLRE	Enable/disable the system to check for new mail. Onsite display (example): Ck mail = ON Options OFF - ON
	EMLTM	 Note! This parameter is only available if the ON option is selected in the Ck mail (EMLRE) parameter. Select whether the system should always run a check after a set interval or regularly at a set time (periodically). Onsite display (example): Ck mail = PERIODIC Options ▪ PERIODIC ▪ INTERVAL
	EMLPT	 Note! This parameter is only available if the PERIODIC option is selected in the Ck mail (EMLTM) parameter. Select the time frame in which the inbox should be checked regularly. Specify the associated time via the Time parameter (→  147). Onsite display (example): Ck mail = HOURLY Options ▪ HOURLY ▪ DAILY ▪ WEEKLY ▪ MONTHLY
Interv	EMLIV	 Note! This parameter is only available if the INTERVAL option is selected in the Ck mail (EMLTM) parameter. Enter the interval after which the check takes place. Onsite display (example): Interv = 00d12h30m User entry 00d00h00m (d = days, h = hours, m = minutes) Example: If 00d 12h 30m is entered as the interval, the device checks the mail inbox every 12 hours and 30 minutes (from the moment the entry is saved).









Parameter group 7 - Communication		
Local display	Operating tool	Parameter description
Time	EMLTV	<p> Note! This parameter is only available if the PERIODIC option is selected in the Ck mail (EMLTM) parameter.</p> <p>Enter the time for the regular check.</p> <p>Onsite display (example): Time = 00d12h30m</p> <p>User entry 00d00h00m (d = days, h = hours, m = minutes)</p> <p> Note! The entry options depend on the time frame set in the Ck mail (EMLPT) parameter. If the HOURLY option is selected, for example, the value for the day (d) can be changed in this parameter but it is reset when the setting is saved.</p> <p>Example:</p> <ul style="list-style-type: none"> ▪ Time frame selected in the Ck mail (EMLPT) parameter: MONTHLY ▪ Time check is performed: 10d 12h 30m <p>✓ The system checks for e-mails at 12:30 on the 10th of each month.</p>
<p> For information on synchronizing the system time and interdependencies between the associated parameters, →  170.</p>		
Clock s	CSYNE	<p>For enabling/disabling system time synchronization.</p> <p>Onsite display (example): Clock s = ON</p> <p>Options OFF – ON</p>
	CSYTM	<p> Note! This parameter is only available if the ON option is selected in the Clock s (CSYNE) parameter.</p> <p>Select whether the time should always be synchronized after a set interval or regularly at a set time (periodically).</p> <p>Onsite display (example): Clock s = PERIODIC</p> <p>Options</p> <ul style="list-style-type: none"> ▪ PERIODIC ▪ INTERVAL
	CSYPT	<p> Note! This parameter is only available if the PERIODIC option is selected in the Clock s (CSYTM) parameter.</p> <p>Select the time frame in which the synchronization should regularly take place. Specify the associated time via the Time parameter (→  148).</p> <p>Onsite display (example): Clock s = HOURLY</p> <p>Options</p> <ul style="list-style-type: none"> ▪ HOURLY ▪ DAILY ▪ WEEKLY ▪ MONTHLY

Parameter group 7 - Communication		
Local display	Operating tool	Parameter description
Interv	CSYIV	<p> Note! This parameter is only available if the INTERVAL option is selected in the Clock s (CSYTM) parameter.</p> <p>Enter the interval after which synchronization takes place.</p> <p>Onsite display (example): Interv = 00d12h30m</p> <p>User entry 00d00h00m (d = days, h = hours, m = minutes)</p> <p>Example: If 00d12h30m is entered as the interval, the device synchronizes the system time every 12 hours and 30 minutes (from the moment the entry is saved).</p>
Time	CSYTV	<p> Note! This parameter is only available if the PERIODIC option is selected in the Clock s (CSYTM) parameter.</p> <p>Enter the time for regular synchronization.</p> <p>Onsite display (example): Time = 00d12h30m</p> <p>User entry 00d00h00m (d = days, h = hours, m = minutes)</p> <p> Note! The entry options depend on the time frame set in the Clock s (CSYPT) parameter. If the HOURLY option is selected, for example, the value for the day (d) can be changed in this parameter but it is reset when the setting is saved.</p> <p>Example:</p> <ul style="list-style-type: none"> ▪ Time frame selected in the Clock s (CSYPT) parameter: MONTHLY ▪ Time check is performed: 10d 12h 30m <p>✓ The system checks for e-mails at 12:30 on the 10th of each month.</p>
Send events	EVTSE	<p>Enable/disable the transmission of events via e-mail.</p> <p>Onsite display (example): Send events = ON</p> <p>Options OFF – ON</p>
Roaming	ROAME	<p>Enable/disable roaming. If roaming is enabled, the GSM/GPRS modem can start connecting to another network.</p> <p>Onsite display (example): Roaming = ON</p> <p>Options OFF – ON</p>
Send DL	DLSNI	<p> Note! This parameter is only available if an option is selected in the Send DL (→  142) parameter.</p> <p>Use this function to start immediate transmission of all the data which have not yet been sent from the data logger.</p> <p>Onsite display (example): Send DL = ON</p> <p>Options EXECUTE?</p> <p> Note! If you are using the Config 5800 operating tool, you must confirm the "EXECUTE?" option by pressing the ESC key.</p>



Parameter group 7 - Communication		
Local display	Operating tool	Parameter description
Send PD	PRDSI	<p> Note! This parameter is only available if an option is selected in the Send PD (→  143) parameter.</p> <p>Use this function to start the immediate transmission of current process data.</p> <p>Onsite display (example): Send PD = ON</p> <p>Options EXECUTE?</p> <p> Note! If you are using the Config 5800 operating tool, you must confirm the "EXECUTE?" option by pressing the ESC key.</p>
Send events	EVTSI	<p>Use this function to start the immediate transmission of all the events.</p> <p>Onsite display (example): Send events</p> <p>Options EXECUTE?</p> <p> Note! <ul style="list-style-type: none"> ■ Use this parameter to test sending e-mails. ■ If you are using the Config 5800 operating tool, you must confirm the "EXECUTE?" option by pressing the ESC key. </p>
Send config.	CFGSI	<p>Use this function to start the immediate transmission of the configuration of all the parameters.</p> <p>Onsite display (example): Send config.</p> <p>Options EXECUTE?</p> <p> Note! <ul style="list-style-type: none"> ■ Use this parameter to test sending e-mails. ■ If you are using the Config 5800 operating tool, you must confirm the "EXECUTE?" option by pressing the ESC key. </p>
Clock s	CSYNI	<p>Use this function to start immediate system time synchronization.</p> <p>Onsite display (example): Clock s</p> <p>Options EXECUTE?</p> <p> Note! If you are using the Config 5800 operating tool, you must confirm the "EXECUTE?" option by pressing the ESC key.</p>
Ck mail	EMLRI	<p>Use this function to immediately start checking for new mail.</p> <p>Onsite display (example): Ck mail</p> <p>Options EXECUTE?</p> <p> Note! If you are using the Config 5800 operating tool, you must confirm the "EXECUTE?" option by pressing the ESC key.</p>
Chk SMS	SMSCI	<p>Use this function to immediately start checking for a new message (SMS).</p> <p>Onsite display (example): Chk SMS</p> <p>Options EXECUTE?</p> <p> Note! If you are using the Config 5800 operating tool, you must confirm the "EXECUTE?" option by pressing the ESC key.</p>





19.4.8 Parameter group 8 - Display

Parameter group 8 - Display			
	Local display	Operating tool	Parameter description
	Language	LLANG	Select the language for the display or for messages, for example. Onsite display (example): Language = EN Options <ul style="list-style-type: none"> ▪ EN ▪ IT ▪ FR ▪ SP ▪ DE
	D.time	ENSDT	Specify the time for enabling the standby mode. If the measuring device is not operated, the display switches off automatically once the time specified has elapsed. Onsite display (example): D. time = s 060 User entry 20 to 250 s
 A0011200	Quick start	QSTME	Enable and disable the Quick Start function. Onsite display (example): Quick Start = ON Options OFF – ON <ul style="list-style-type: none"> ▪ If OFF is selected the display switches to the main menu ▪ If ON is selected the Quick Start parameters are called up →  129
	Disp. lock	DLOKE	Lock the display area on the onsite display (= ON) →  50. Onsite display (example): Disp. lock = OFF Options OFF – ON
 A0011200	T + reset	VTPR	Reset the totalizer positive total. Onsite display (example): T + reset Options EXECUTE?  Note! If you are using the Config 5800 operating tool, you must confirm the "EXECUTE?" option by pressing the ESC key.
 A0011200	P + reset	VTPPR	Reset the totalizer positive total. Onsite display (example): P + reset Options EXECUTE?  Note! If you are using the Config 5800 operating tool, you must confirm the "EXECUTE?" option by pressing the ESC key.







Parameter group 8 - Display			
	Local display	Operating tool	Parameter description
 A0011200	T - reset	VTNR	Reset the totalizer negative total. Onsite display (example): T - reset Options EXECUTE?  Note! If you are using the Config 5800 operating tool, you must confirm the "EXECUTE?" option by pressing the ESC key.
 A0011200	P - reset	VTPNR	Reset the totalizer negative total. Onsite display (example): P - reset Options EXECUTE?  Note! If you are using the Config 5800 operating tool, you must confirm the "EXECUTE?" option by pressing the ESC key.
 A0011200	-	VTTPS	Specify a default value for the totalizer positive total. User entry 0...999999999
 A0011200	-	VTPPS	Specify a default value for the totalizer positive partial. User entry 0...999999999
 A0011200	-	VTINS	Specify a default value for the totalizer negative total. User entry 0...999999999
 A0011200	-	VTPNS	Specify a default value for the totalizer negative partial. User entry 0...999999999





19.4.9 Parameter group 9 - Data logger

Parameter group 9 - Data logger		
Local display	Operating tool	Parameter description
SET DATE/TIME	DTIME	Set the date and the time. Onsite display (example): 01.03.2012 08:30 User entry DD/MM/YYYY HH:MM
T.zone	TZONE	Enter the time difference to GMT to adjust the time to a certain time zone. Onsite display (example): T.zone = h +01.0 User entry ±0.00...12.0
	For information on writing data from the data logger and interdependencies between the associated parameters, →  171.	

Parameter group 9 - Data logger		
Local display	Operating tool	Parameter description
Acquisition	DLOGE	<p>Enables the following parameters in the "9 - Data logger" parameter group.</p> <ul style="list-style-type: none"> ■ Parameters for configuring the chronological sequence for recording the process data on the data logger (SD card): <ul style="list-style-type: none"> - Double int. (DLI2E) - int. 1 (DLGSI) - int. 2 (DLGS2) - int. 2 (DI2PT) - T. ON (I2ONT) - T. OFF (I2OFT) ■ Parameters with process data and units that can be recorded. The data are recorded including the record number, date and time. For the data logger file structure, see →  85. <ul style="list-style-type: none"> - Log T+ (DTTPE) - Log T- (DTTNE) - Log Q (DFLWE) - % values (DLPVE) - Log P+ (DTPPE) - Log P- (DTPNE) - Log NT (DLTNE) - Log NP (DLPNE) - Log STAT (DLMSE) - M.units (DLUSE) ■ Parameter that specifies how values are separated within the data logger file: <ul style="list-style-type: none"> - Separator (DLFSC) <p>Onsite display (example): Acquisition = ON</p> <p>Options OFF - ON</p>
Double int.	DLI2E	<p> Note! This parameter is only available if the ON option is selected in the Acquisition (DLOGE) parameter.</p> <p>Enable/disable recording interval 2 for the data logger. The interval is entered in the int. 2 (DLGS2) parameter.</p> <p>Onsite display (example): Double int. = ON</p> <p>Options OFF - ON</p>
int. 1	DLGSI	<p> Note! This parameter is only available if the ON option is selected in the Acquisition (DLOGE) parameter.</p> <p>Recording interval 1 for the data logger. Enter the interval after which the process data are saved to the data logger (SD card) →  171.</p> <p>Onsite display (example): int. 1 = 00h01m00s (h = hours, m = minutes, s = seconds)</p> <p>Recording interval min. 15 s If you switch off the power saving mode (ENSVE), a min. value of 1 s will be possible.</p> <p>User entry 00h 00m 00s</p>



Parameter group 9 - Data logger		
Local display	Operating tool	Parameter description
int. 2	DLGS2	<p> Note! This parameter is only available if the ON option is selected in both the Acquisition (DLOGE) and Double int. (DLI2E) parameters.</p> <p>Recording interval 2 for the data logger. Enter the interval after which the process data are saved to the data logger (SD card) → 171.</p> <p>Onsite display (example): int. 2 = 00h01m00s (h = hours, m = minutes, s = seconds)</p> <p>Recording interval min. 15 s If you switch off the power saving mode (ENSVE), a min. value of 1 s will be possible.</p> <p>User entry 00h 00m 00s</p>
	DI2PT	<p> Note! This parameter is only available if the ON option is selected in both the Acquisition (DLOGE) and Double int. (DLI2E) parameters.</p> <p>Select the time frame in which the data should be recorded. Specify the associated times via the T. ON (I2ONT) and T. OFF (I2OFT) parameters.</p> <p>Onsite display (example): int. 2 = WEEKLY</p> <p>Options</p> <ul style="list-style-type: none"> ▪ HOURLY ▪ DAILY ▪ WEEKLY ▪ MONTHLY
T. ON	I2ONT	<p> Note! This parameter is only available if the ON option is selected in both the Acquisition (DLOGE) and Double int. (DLI2E) parameters.</p> <p>Enter a starting time for recording interval 2.</p> <p>Onsite display (example): T. on = 10d12h30m (d = day, h = hours, m = minutes)</p> <p>User entry 00d00h00m</p>
T. OFF	I2OFT	<p> Note! This parameter is only available if the ON option is selected in both the Acquisition (DLOGE) and Double int. (DLI2E) parameters.</p> <p>Enter a finishing time for recording interval 2.</p> <p>Onsite display (example): T. on = 10d12h30m (d = day, h = hours, m = minutes)</p> <p>User entry 00d00h00m</p>
-	DLMRD	<p>Read the minimum and maximum measured variable values out of the data logger.</p> <p>Display l/s,0.0050,6.5000</p>
-	DLMRE	<p>Reset the minimum and maximum measured variable values in the data logger.</p> <p>Options EXECUTE</p>
<p> The following parameters specify which process data and values are recorded in the data logger in order to be sent as a CSV file (structure of CSV files → 85).</p>		





Parameter group 9 - Data logger		
Local display	Operating tool	Parameter description
Log T+	DTTPE	<p> Note! This parameter is only available if the ON option is selected in the Acquisition (DLOGE) parameter.</p> <p>Enable/disable recording of the totalizer positive total in the data logger.</p> <p>Onsite display (example): Log T+ = OFF</p> <p>Options OFF - ON</p>
Log P+	DTPPE	<p> Note! This parameter is only available if the ON option is selected in the Acquisition (DLOGE) parameter.</p> <p>Enable/disable recording of the totalizer positive total.</p> <p>Onsite display (example): Log P+ = OFF</p> <p>Options OFF - ON</p>
Log T-	DTTNE	<p> Note! This parameter is only available if the ON option is selected in the Acquisition (DLOGE) parameter.</p> <p>Enable/disable recording of the totalizer negative total.</p> <p>Onsite display (example): Log T- = OFF</p> <p>Options OFF - ON</p>
Log P-	DTPNE	<p> Note! This parameter is only available if the ON option is selected in the Acquisition (DLOGE) parameter.</p> <p>Enable/disable recording of the totalizer negative total.</p> <p>Onsite display (example): Log P- = OFF</p> <p>Options OFF - ON</p>
Log NT	DLTNE	<p> Note! This parameter is only available if the ON option is selected in the Acquisition (DLOGE) parameter.</p> <p>Enable/disable recording of the totalizer net (balance).</p> <p>Onsite display (example): Log NT = OFF</p> <p>Options OFF - ON</p>
Log NP	DLPNE	<p> Note! This parameter is only available if the ON option is selected in the Acquisition (DLOGE) parameter.</p> <p>Enable/disable recording of the totalizer net (balance).</p> <p>Onsite display (example): Log NP = OFF</p> <p>Options OFF - ON</p>

Parameter group 9 - Data logger		
Local display	Operating tool	Parameter description
Log Q	DFLWE	<p> Note! This parameter is only available if the ON option is selected in the Acquisition (DLOGE) parameter.</p> <p>Enable/disable recording of the flow value.</p> <p>Onsite display (example): Log Q = OFF</p> <p>Options OFF – ON</p>
Log STAT	DLMSE	<p> Note! This parameter is only available if the ON option is selected in the Acquisition (DLOGE) parameter.</p> <p>Enable/disable recording of the measurement statistics (e.g. measuring cycle, status, battery, antenna signal etc.)</p> <p>Onsite display (example): Log STAT = OFF</p> <p>Options OFF – ON</p>
M. units	DLUSE	<p> Note! This parameter is only available if the ON option is selected in the Acquisition (DLOGE) parameter.</p> <p>Enable/disable recording of the units.</p> <p>Onsite display (example): M.units = OFF</p> <p>Options OFF – ON</p>
% values	DLPVE	<p> Note! This parameter is only available if the ON option is selected in the Acquisition (DLOGE) parameter.</p> <p>Enable/disable recording of the percentage values for all the measured values.</p> <p>Onsite display (example): % values= OFF</p> <p>Options OFF – ON</p>
Separator	DLFSC	<p> Note! This parameter is only available if the ON option is selected in the Acquisition (DLOGE) parameter.</p> <p>Select the character separator for the CSV file, for example.</p> <p>Onsite display (example): Separator = ;</p> <p>Options ▪ , ▪ ;</p>
-	DLRST	<p>Start resetting the data not yet sent in the data logger. The reset removes the data from the queue but does not delete them.</p> <p>Options EXECUTE</p>
-	EVRST	<p>Start resetting the events not yet sent. The reset removes the events from the queue but does not delete them.</p> <p>Options EXECUTE</p>

Parameter group 9 - Data logger		
Local display	Operating tool	Parameter description
-	DLSTA	<p>Display the status of the data of the data logger and the events in the following order:</p> <ul style="list-style-type: none"> ▪ RECNUM Number of records sent ▪ SMSNUM Number of text messages (SMS) sent ▪ LOGGERBYTES Number of bytes sent for data of the data logger ▪ EVENTBYTES Number of bytes sent for events <p>Display (example) 8,11,8538581,1050487</p> <p> Note! If the SMS function is not enabled for sending events and data of the data logger, the first two digits are always "0".</p>
-	DLSIZ	<p>Display the following values:</p> <ul style="list-style-type: none"> ▪ RECNUM Number of records in the period selected ▪ SMSNUM Number of text messages required to send the records ▪ MAX_DATA_LOGGER_RECORD Max. size (bytes) of the records ▪ MAX_BYTE Number of bytes of the records in the period selected <p>Display (example) 8,11,8538581,1050487</p>

19.4.10 Parameter group 10 - Diagnostic







Parameter group 10 - Diagnostic			
	Local display	Operating tool	Parameter description
 A0011200	Calibration	CALIC	<p>Start a calibration and verify the input circuits.</p> <p>Onsite display (example): Calibration</p> <p>Options EXECUTE</p>
 A0011200	Sensor test	STSTC	<p>Start a sensor test. The sensor is verified and reset when the sensor test is performed. The system is then restarted.</p> <p>Onsite display (example): Sensor test</p> <p>Options EXECUTE</p>
 A0011200	Self test	ATSIC	<p>Start a sensor test. The sensor is verified and reset when the sensor test is performed. The system is then restarted.</p> <p>Onsite display (example): Self test</p> <p>Options EXECUTE</p>





Parameter group 10 - Diagnostic			
	Local display	Operating tool	Parameter description
 A0011200	Simulation	MSIEN	<p>Enable/disable simulation. If simulation is active, a flow value can be specified via the FRVPC parameter → 164.</p> <p>Onsite display (example): Simulation = OFF</p> <p>Options OFF – ON</p> <p> Note! If simulation is enabled, an "S" appears on the onsite display.</p>
	Display data	–	<p>Display the measured values and settings.</p> <p>Onsite display (example): Display data</p> <p>Options EXECUTE</p>
 A0011200	Standby	STBYC	<p>Switch the measuring device to the standby mode. To reactivate the measuring device: Press the ENTER key on the onsite display for longer than 5 seconds.</p> <p>Onsite display (example): Standby</p> <p>Options EXECUTE</p> <p> Note! If you are using the Config 5800 operating tool, you must confirm the "EXECUTE?" option by pressing the ESC key.</p>
	Gprs test	GTEST	<p>Start the GPRS test.</p> <p> Note! The following parameters must be configured to perform a GPRS test:</p> <ul style="list-style-type: none"> ■ GPAPN ■ GPUSR ■ GPPSW ■ GPAUT <p>Onsite display (example): Simulation = Gprs test</p> <p>Options EXECUTE</p>
	Read SDC info	SDSTA	<p>View the status of the SD card (total and free storage space in MB).</p> <p>Onsite display (example): Read SDC info</p> <p>Options EXECUTE</p>
	Format SDC	–	<p>SD card formatting.</p> <p>Onsite display (example): Format SDC</p> <p>Options EXECUTE</p>
	–	SDRSY	<p>Synchronizing the capacity of the SD card between calculated and effective capacity.</p> <p>Options EXECUTE</p>
	–	MDDPI	<p>Reinitialization of the GSM/GPRS modem following a firmware upgrade.</p> <p>Options OFF – ON</p>

Parameter group 10 - Diagnostic			
	Local display	Operating tool	Parameter description
	–	OUT1D	Parameter for internal use only! Diagnostics for output 1. User entry 0...3
	–	OUT2D	Parameter for internal use only! Diagnostics for output 2. User entry 0...3
	–	HWCFG	Parameter for internal use only! Hardware configuration. Display 220013,1,1,0,1,2
	–	MDIAG	Parameter for internal use only! Advanced diagnostics of the GSM/GPRS modem. Options OFF – ON
	–	MDCMD	Parameter for internal use only! Send a command [CMD STRING] directly to the modem. User entry [CMD STRING], TIMEOUT
	–	TMPLR	Display the temperature of the electronics board. Display °C,0,32
	–	TMPRE	Reset the max. temperature value of the electronics board. Options EXECUTE
	–	MEMDP	Parameter for internal use only! Read the entire memory for diagnostics purposes. Options EXECUTE
	–	RSTDF	Reset the diagnostics flags. Options EXECUTE
	–	ALECL	Parameter for internal use only! Record the ETP commands. Options OFF – ON



19.4.11 Parameter group 11 - Internal data

Parameter group 11 - Internal data			
	Local display	Operating tool	Parameter description
	L2 code	L2ACD	Enter the access code for Level 2 to be able to call up the main menu. Onsite display (example): L2 code = ***** User entry 0...999999

Parameter group 11 - Internal data			
	Local display	Operating tool	Parameter description
 A0011200	Load fact. data	LFDIC	Reset the parameter setting to the delivery settings. Onsite display (example): Load fact. data Options EXECUTE
 A0011200	Save fact. data	SFDIC	Save the current parameter setting. Onsite display (example): Save fact. data Options EXECUTE
 A0011200	Memory reset	CMRIC	Reset the parameters to the factory setting (only Level 4). Onsite display (example): Memory reset Options EXECUTE
	–	SRNUM	Display the serial number of the electronics board. Onsite display (example): S/n = 053139 Display 0...999999
 A0011200	KF	CFFKF	For internal use only! The parameter may not be modified. Display the coefficient KF for the calibration factor (system-frequency time base). Onsite display (example): KF = 1.00000 User entry 0.10000...9.99999
 A0011200	KT	CFFKT	For internal use only! The parameter may not be modified. Display/enter the coefficient KT for the calibration factor (measure analog signal chain). Onsite display (example): KF = +1.0031 User entry ±0.5000...±9.9999
 A0011200	KR	CFFKR	For internal use only! The parameter may not be modified. Display/enter the optional coefficient KT for the reference factor between this measuring device and an ideal measuring device with an identical sensor. Onsite display (example): KR = +1.0000 User entry ±0.5000...±9.9999
 A0011200	KS	CFFKS	For internal use only! The parameter may not be modified. Display/enter the coefficient KS for the optional calibration factor. Onsite display (example): KS = +1.0000 User entry ±0.5000...±9.9999
	–	TONTM	Display the operating hours. Display h, 160:17:19

Parameter group 11 - Internal data			
	Local display	Operating tool	Parameter description
	–	INTAG	Enter the device ID for mails (Tag No.). User entry Max. 31 characters
 A0011200	–	SPSIC	Save the reference values of the sensor. Options EXECUTE
	–	SRCOD	Display the serial number. Display Max. 31 CHR String
	–	TOMCY	Number of measuring cycles throughout the lifetime of the measuring device. User entry 0...-1
	–	GPRHE	Enable/disable GPRS. User entry 0...1  Note! The parameter may not be modified if the measuring device does not have a GSM/GPRS modem.
	–	DLGHE	Enable/disable the data and event logger. User entry 0...1
	–	OUTHE	Enable/disable the outputs. User entry 0...1
	–	BT1HE	Enter the number of batteries connected in terminal B1 →  40. User entry 1...3  Note! The parameter may not be set to 0.
	B2	BT2HE	Enter the number of batteries connected in terminal B2 →  40. User entry 0...3

19.4.12 Parameter group GPRS data



Parameter group GPRS data (only available via the operating tool)		
Local display	Operating tool	Parameter description
		The parameters in this menu are only available via the operating tool. The parameters are not shown on the onsite display (or on the integrated user interface of the operating tool) and can only be called up and changed manually via the parameter menu.
–	GPAPN	APN: Name of the access point of the mobile communications network (access point name). Configuration of GPRS communication →  72. User entry Max. 31 characters, e.g. "gprs.provider.com"

Parameter group GPRS data (only available via the operating tool)		
Local display	Operating tool	Parameter description
-	GPEMF	Existing transmission e-mail address of the measuring device. In the event of an error, the receiver (SMTP server) sends a mail error, along with the cause of the error, to this address (e.g. error sending mail to receiver (SMTP server)) Configuration of e-mail communication (sending) → 74. User entry Max. 31 characters, e.g. "client@provider.com"
-	GPEMT	E-mail address of receiver. Configuration of e-mail communication (sending) → 74. User entry Max. 31 characters, e.g. "client@provider.com"
-	GPUSR	User name for authentication purposes. Configuration of GPRS communication → 72. User entry Max. 18 characters
-	GPPSW	Password for authentication purposes. Configuration of GPRS communication → 72. User entry Max. 18 characters
-	GPAUT	Authentication type, access authentic value required for the network provider. Configuration of GPRS communication → 72. User entry 0...2 <ul style="list-style-type: none"> ■ 0 = Normal (PAP) ■ 1 = Secure (CHAP) ■ 2 = No one Select "0" if this information is not required by the provider.
-	GPSMA	Static IP address of the SMTP server (e-mail receiver). Configuration of e-mail communication (sending) → 74. User entry xxx.xxx.xxx.xxx (e.g. "142.25.132.47")
-	GPDNS	Fully qualified domain name (plain text name) of the SMTP server (e-mail receiver). Configuration of e-mail communication (sending) → 74. User entry Max. 31 characters (e.g. "smtp.emailprovider.com")
-	GPNRS	IP address of the DNS server (domain name system). Configuration of e-mail communication (sending) → 74. User entry xxx.xxx.xxx.xxx (e.g. "83.214.64.20")
-	GPSMP	IP port of the SMTP server (e-mail receiver). Configuration of e-mail communication (sending) → 74. User entry 0 to 65535 (e.g. "25") IP port 25 is used in most cases.
-	GPTSA	IP address of the NTP server, for establishing the connection to the server and for synchronizing the system time of the measuring device. Configuration of system time synchronization → 83. User entry xxx.xxx.xxx.xxx (e.g. "122.23.56.201")
-	GDNT	Fully qualified domain name of the NTP server. Configuration of system time synchronization → 83. User entry Max. 31 characters (e.g. "ntp.metas.ch")

Parameter group GPRS data (only available via the operating tool)		
Local display	Operating tool	Parameter description
-	GPTSP	TCP port of the NTP server. Configuration of system time synchronization → 83. User entry 0 to 65535 (e.g. "123") IP port 123 is used in most cases.
-	GPP3A	Static IP address of the POP3 server. The measuring device searches for e-mails on the POP3 server. Configuration of e-mail communication (receiving) → 80. User entry xxx.xxx.xxx.xxx (e.g. "122.27.56.201")
-	GPDNP	Fully qualified domain name of the POP3 server. Configuration of e-mail communication (receiving) → 80. User entry Max. 31 characters (e.g. "pop3.provider.com")
-	GPP3P	TCP PORT of the POP3 server. Configuration of e-mail communication (receiving) → 80. User entry 0 to 65535 (e.g. "110") IP port 110 is used in most cases.
-	GP3US	User name for authentication purposes. Configuration of e-mail communication (receiving) → 80. User entry Max. 24 characters (e.g. "Promag800")
-	GP3PS	Password for authentication purposes. Configuration of e-mail communication (receiving) → 80. User entry Max. 12 characters (e.g. "P800IN")
-	GPASN	Telephone number of the sender (sends text message (SMS) to measuring device). Configuration of SMS communication → 70. User entry Max. 19 characters
-	GPSSN	Telephone number of the first receiver (receives SMS from measuring device). A text message (SMS) is sent to this telephone number if errors or alarms occur. Configuration of SMS communication → 70. User entry Max. 19 characters
-	GPSS2	Telephone number of the second receiver (receives SMS from measuring device). A text message (SMS) is sent to this telephone number if errors or alarms occur. Configuration of SMS communication → 70. User entry Max. 19 characters
-	GPSS3	Telephone number of the third receiver (receives SMS from measuring device). A text message (SMS) is sent to this telephone number if errors or alarms occur. Configuration of SMS communication → 70. User entry Max. 19 characters

Parameter group GPRS data (only available via the operating tool)		
Local display	Operating tool	Parameter description
-	GPHESES	Name (HELO string) so the SMTP server of the receiver can identify the measuring device. Description of the configuration of e-mail communication (sending) →  74. User entry Max. 31 characters, e.g. "Promag800"
-	GPRES	Start resetting all the GPRS parameters to the factory setting or to the value "zero". Options EXECUTE
-	GPSAE	This value must be set to = 1 to ensure that the measuring device logs on to the SMTP server using the POP3 server's access data.

19.4.13 Parameter group Auxiliary cmds

Parameter group "Auxiliary cmds" (only available via the operating tool)		
Local display	Operating tool	Parameter description
		The parameters in this menu are only available via the operating tool. The parameters are not shown on the onsite display (or on the integrated user interface of the operating tool) and can only be called up and changed manually via the parameter menu.
-	ACODE	Displays the value entered in the "Set code level" field →  62. Display 0...999999
-	MODSV	Display the measuring device version and the firmware version. Display (example) Promag 800 VER.5.01.06 Jul 20 2011 17:56:33
-	CLIST	Display all the parameters currently available. Display (example) PDIMV, CFFKA, SMODL, SCRES...
-	MLIST	Displays a list of all the supported commands. Display (example) PDIMV,243,1,0,0,[Pipe DiaMeter Value][Sensor] CFFKA,241,1,0,0,[CoeFFicient KA][Sensor] SMODL,241,1,0,0,[Sensor MODEL][Sensor] SCRES,241,1,0,0,[Sensor Coils RESistance][Sensor]...
-	CFLST	Display the current configuration. Display (example) PDIMV=25 CFFKA=+0.0000 SMODL=0 SCRES=0...
 A0011200	SWUPD	Start a firmware update. Options EXECUTE

19.4.14 Parameter group Process data

Parameter group Process data (only available via the operating tool)		
Local display	Operating tool	Parameter description
		The parameters in this menu are only available via the operating tool. The parameters are not shown on the onsite display (or on the integrated user interface of the operating tool) and can only be called up and changed manually via the parameter menu.
-	VTPV	Display the totalizer positive total. Display (example) m ³ , 0
-	VTPV	Display the totalizer positive total. Display (example) m ³ , 999999
-	VTTNV	Display the totalizer negative total. Display (example) m ³ , 2999999
-	VTPNV	Display the totalizer negative total. Display (example) m ³ , 2999999
-	VTTNT	Display the totalizer net total. Display (example) m ³ , -2999999
-	VTPNT	Display the totalizer negative net total. Display (example) m ³ , -2000000
-	FRVPC	Display the flow value in %. Display (example) %, 0.000000
-	FRVTU	Display the flow value in the unit selected. Display (example) m ³ /s, 0.000000
-	FRVPX	Display the flow value (without low flow cutoff) in %. Display (example) %, 0.000000
-	FRVTX	Display the flow value (without low flow cutoff) in the unit selected. Display (example) m ³ /s, 0.000000
-	BATTS	Display the battery state of charge in %. Display (example) %, 99,0,0,1 ¹⁾
-	ALARM	Display the alarm status. Display 3;244;B3 LOW;221;EXCIT.ERROR;222;EL.SIG.ERROR
-	ANTSS	Displays the strength of the antenna signal the last time communication was established with the GSM/GPRS network. Display (example) %, 57
-	BTMPV	Display the temperature of the electronics board in the unit selected. Display (example) °C, +26

- 1) 1 = gets energy from B1
2 = gets energy from B2

19.5 Information on configuring the measuring device

19.5.1 Regular data transmission from the data logger

It is possible to configure the regular transmission of data from the data logger using the parameters in parameter group 7 - Communication → 142. The transmission mode (e.g. transmission by mail) and the transmission time can be set here.



Note!

The data are sent immediately via the DLSNI (Send DL) parameter → 148.

Sending the data logger data at intervals → 67

In the parameter:

- DLGSM (Send DL) → 142: select the desired transmission mode, e.g. mail.
 - DLGTM (Send DL) → 142: select the INTERVAL option.
 - DLGIV (Interv) → 142: specify the time interval for the transmission, e.g. every 10 hours.
- ✓ The data are always transmitted after the time interval has elapsed.

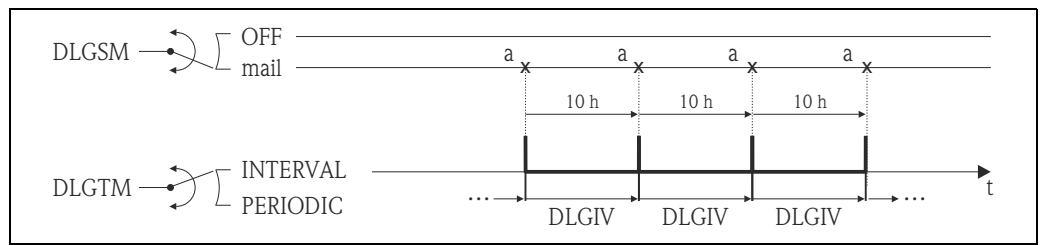

Fig. 67: Transmission of the data in the data logger with the INTERVAL option selected in the DLGTM parameter

a The data of the data logger are sent

Sending the data logger data periodically → 68

In the parameter:

- DLGSM (Send DL) → 142: select the desired transmission mode, e.g. mail.
 - DLGTM (Send DL) → 142: select the PERIODIC option.
 - DLGPT (Send DL) → 142: select the period in which transmission should take place, e.g. daily (MON, TUES etc.).
 - DLGTV (Time) → 142: specify the transmission time, e.g. 8:00 a.m.
- ✓ The data are always transmitted at the specified time within the selected time frame.

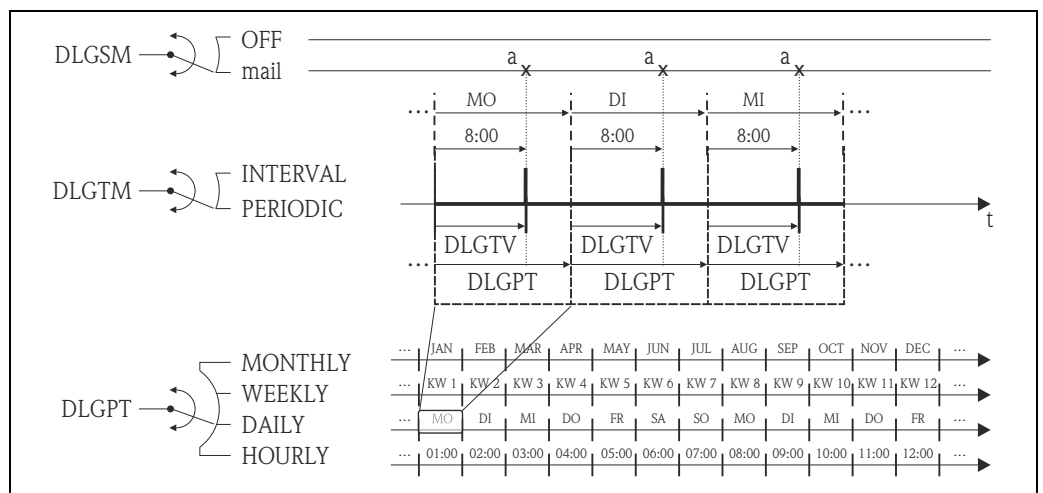

Fig. 68: Transmission of the data in the data logger with the PERIODIC option selected in the DLGTM parameter

a The data of the data logger are sent

19.5.2 Regular transmission of the process data

It is possible to configure the regular transmission of the process data using the parameters in parameter group 7 - Communication → 143. The transmission mode (e.g. transmission by mail or SMS) and the transmission time can be set here.



Note!

The process data are sent immediately via the PRDSI (Send PD) parameter → 149.

Sending process data at intervals → 69

In the parameter:

- PRDSM (Send PD) → 143: select the desired transmission mode, e.g. mail.
 - PRDTM (Send PD) → 143: select the INTERVAL option.
 - PRDIV (Interv) → 143: specify the time interval for the transmission, e.g. every 10 hours.
- ✓ The data are always transmitted after the time interval has elapsed.

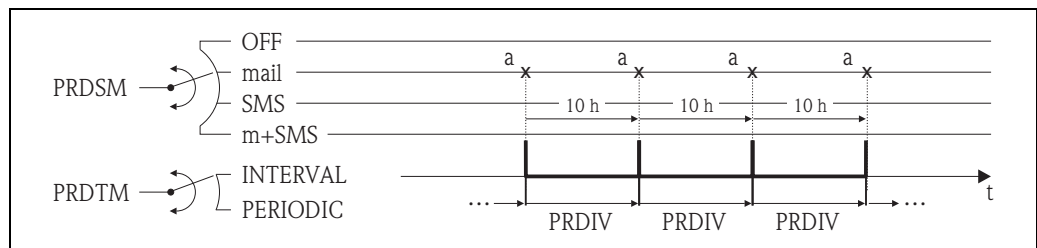

Fig. 69: Transmission of the process data with the INTERVAL option selected in the PRDTM parameter

a The process data are sent

Sending process data periodically → 70

In the parameter:

- PRDSM (Send PD) → 143: select the desired transmission mode, e.g. mail.
 - PRDTM (Send PD) → 143: select the PERIODIC option.
 - PRDPT (Send PD) → 143: select the period in which transmission should take place, e.g. daily (MON, TUES etc.).
 - PRDTV (Time) → 144: specify the transmission time, e.g. 8:00 a.m.
- ✓ The data are always transmitted at the specified time within the selected time frame.

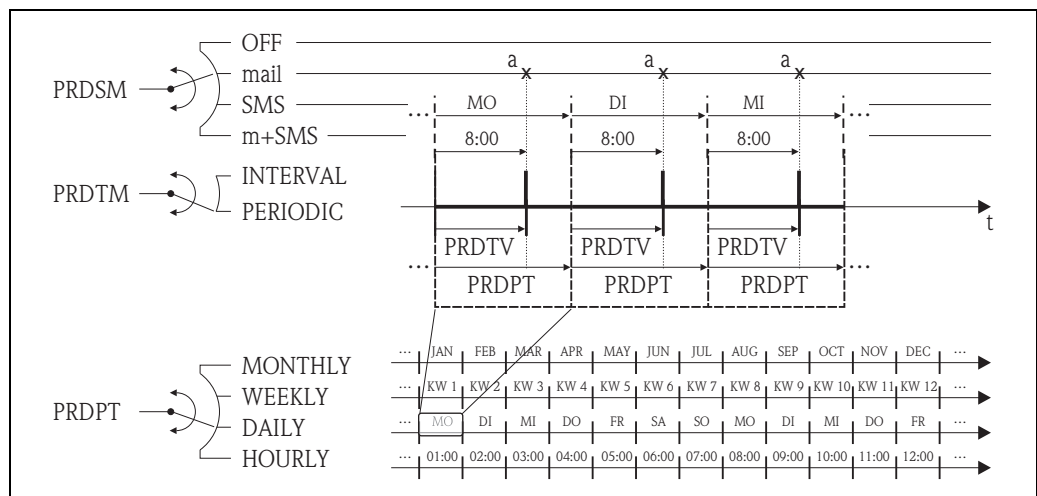

Fig. 70: Transmission of the process data with the PERIODIC option selected in the PRDTM parameter

a The process data are sent

19.5.3 Checking the inbox regularly for new messages

It is possible to configure the system to regularly check for new messages (SMS) using the parameters in parameter group 7 - Communication → 145.



Note!

The inbox is checked immediately via the SMSCI (Chk SMS) parameter → 149.

Check for new messages at intervals → 71

In the parameter:

- SMSRE (Chk SMS) → 145: select ON to enable checking.
- SMSTM (Chk SMS) → 145: select the INTERVAL option.
- SMSIV (Interv) → 145: specify the time interval for the transmission, e.g. 1 hour.
 - ✓ The inbox is always checked after the time interval has elapsed.
- SMSWT (SMS wait t) → 146: specify how long the system check for messages, e.g. 60 sec.
 - Å The check lasts as long as specified in this parameter.

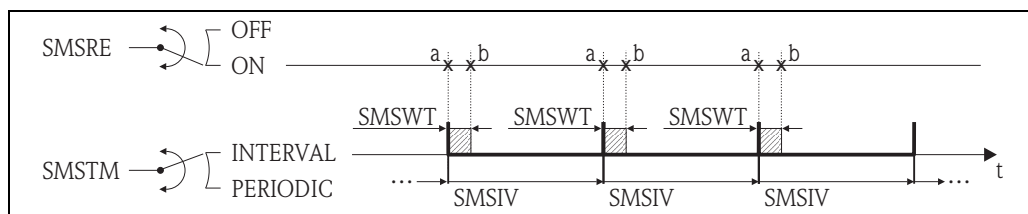

Fig. 71: Check for new messages with the INTERVAL option selected in the SMSTM parameter

- a Start checking
- b Stop checking

Check for new messages periodically → 72

In the parameter:

- SMSRE (Chk SMS) → 145: select ON to enable checking.
- SMSTM (Chk SMS) → 145: select the PERIODIC option.
- SMSPT (Chk SMS) → 145: select the period in which the inbox should be checked, e.g. daily (MON, TUES etc.).
- SMSTV (Time) → 145: specify the time for checking the inbox, e.g. 8:00 a.m.
 - Å The inbox is always checked at the specified time within the selected time frame.
- SMSWT (SMS wait t) → 146: specify how long the system check for messages, e.g. 60 sec.
 - ✓ The check lasts as long as specified in this parameter.

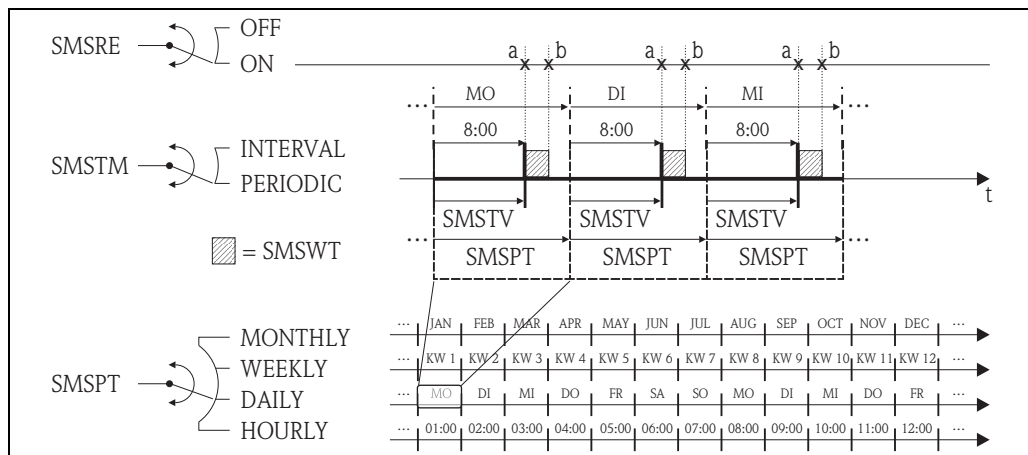

Fig. 72: Check for new messages with the PERIODIC option selected in the SMSTM parameter

- a Start checking
- a Stop checking

19.5.4 Checking the inbox regularly for new mail

It is possible to configure the system to regularly check for new e-mail using the parameters in parameter group 7 - Communication → 146.



Note!

The inbox is checked immediately via the EMLRI (Ck mail) parameter → 149.

Check for new mail at intervals → 73

In the parameter:

- EMLRE (Ck mail) → 146: select ON to enable checking.
- EMLTM (Ck mail) → 146: select the INTERVAL option.
- EMLIV (Interv) → 146: specify the time interval for the transmission, e.g. 10 hours.
- ✓ The inbox is always checked after the time interval has elapsed.

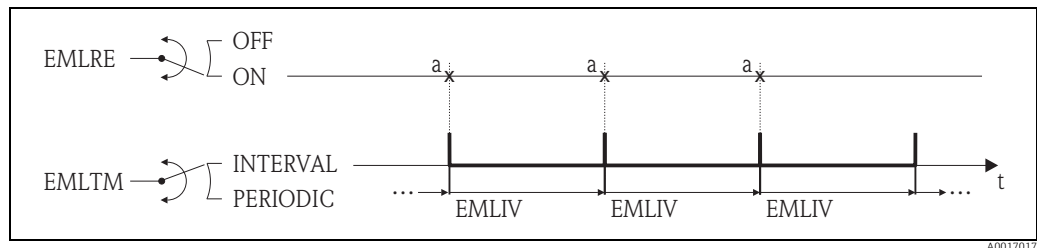

Fig. 73: Check for new mails with the INTERVAL option selected in the EMLTM parameter

a Check for new mails

Check for new mails periodically → 74

In the parameter:

- EMLRE (Ck mail) → 146: select ON to enable checking.
- EMLTM (Ck mail) → 146: select the PERIODIC option.
- EMLPT (Ck mail) → 146: select the period in which the inbox should be checked, e.g. daily (MON, TUES etc.).
- EMLTV (Time) → 147: specify the time for checking the inbox, e.g. 8:00 a.m.
- ✓ The inbox is always checked at the specified time within the selected time frame.

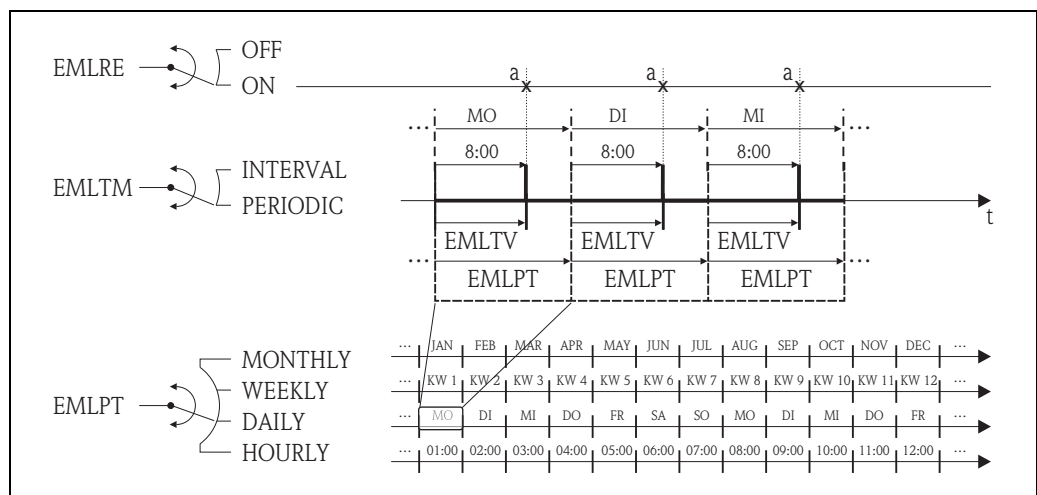



Fig. 74: Check for new mails with the PERIODIC option selected in the EMLTM parameter

a Check for new mails

19.5.5 Explanation of the 100 % full scale value





The flow value to be used as the 100 % full scale value is specified in the Fs parameter (FRMUT, FRMUV, FRFS1) →  132. Many other parameters refer to this 100 % full scale value as they are specified as a percentage in relation to the 100 % full scale value.

Configuration example:

The following section explains a configuration example with a measuring device with nominal diameter DN 80 and a recommended flow (→  23) of 90 to 3000 dm³/min.

- Parameter Fs (100 % full scale value →  132),
is used for positive and negative flow
User entry: **3000 dm³** (max. recommended flow) = 100 % full scale value

All other data are specified in % (in relation to the 100 % full scale value):

- Parameter cut-off (low flow cutoff →  135)
is used for positive and negative flow
User entry: **3 %** = 90 dm³/min (min. recommended flow)
- Al. max.+ and Al. min.+ parameters (alarms for positive flow limit values →  136)
 - User entry: **90 %** = 2700 dm³/min
 - User entry: **10 %** = 300 dm³/min
- Al. max.- and Al. min.- parameters (alarms for negative flow limit values →  136)
 - User entry: **80 %** = 2400 dm³/min
 - User entry: **20 %** = 600 dm³/min
- Hyst. parameter (hysteresis for **all** the alarms and low flow cut off →  136)
User entry: **2 %** = 60 dm³/min

Switching behavior taking the example of Al. max+ and Al. min+:

- Al. max.+
 - is triggered at 90 % of the 100 % full scale value = 2700 dm³/min
 - is no longer active at 90 % – 2 % (hysteresis) of the 100 % full scale value = 88 % = 2640 dm³/min
- Al. min.+
 - is triggered at 10 % of the 100 % full scale value = 300 dm³/min
 - is no longer active at 10 % + 2 % (hysteresis) of the 100 % full scale value = 12 % = 360 dm³/min

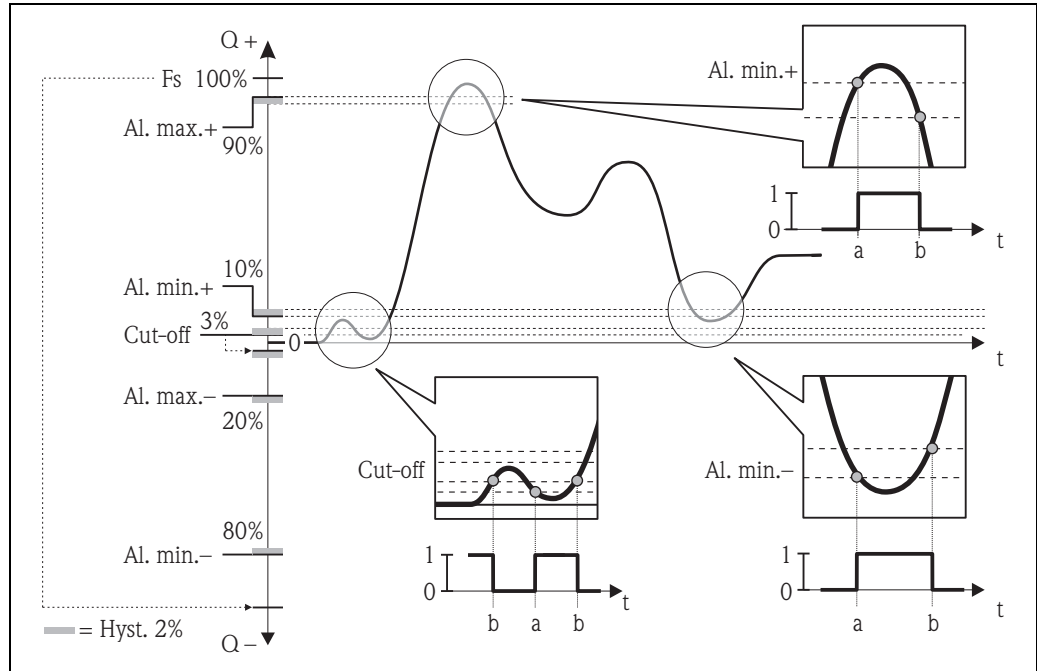

Fig. 75: Examples for switching behavior

- a On-value, alarm or low flow cut off active
- b Off-value (with hysteresis) of the alarm or low flow cut off

19.5.6 Regular synchronization of the system time

It is possible to configure the regular synchronization of the system time using the parameters in parameter group 7 - Communication → 147.



Note!

Synchronization takes place immediately via the CSYNI (Clock s) parameter → 149.

Synchronizing the system time at intervals → 76

In the parameter:

- CSYNE (Clock s) → 147: select ON to enable synchronization.
- CSYTM (Clock s) → 147: select the INTERVAL option.
- CSYIV (Interv) → 148: specify the time interval for synchronization, e.g. 10 hours.
- ✓ Synchronization always takes place after the time interval has elapsed.

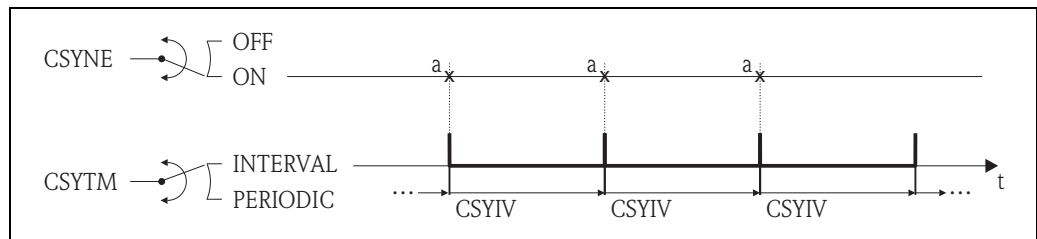

Fig. 76: Synchronizing the system time with the INTERVAL option selected in the CSYTM parameter

- a Synchronization of the system time

Synchronizing the system time periodically → 77

In the parameter:

- CSYNE (Clock s) → 147: select ON to enable synchronization.
- CSYTM (Clock s) → 147: select the PERIODIC option.
- CSYPT (Clock s) → 147: select the period in which synchronization should take place, e.g. daily (MON, TUES etc.).

- CSYTV (Time) → 148: specify the time for synchronization, e.g. 8:00 a.m.
 - ✓ Synchronization is always performed at the specified time within the selected time frame.

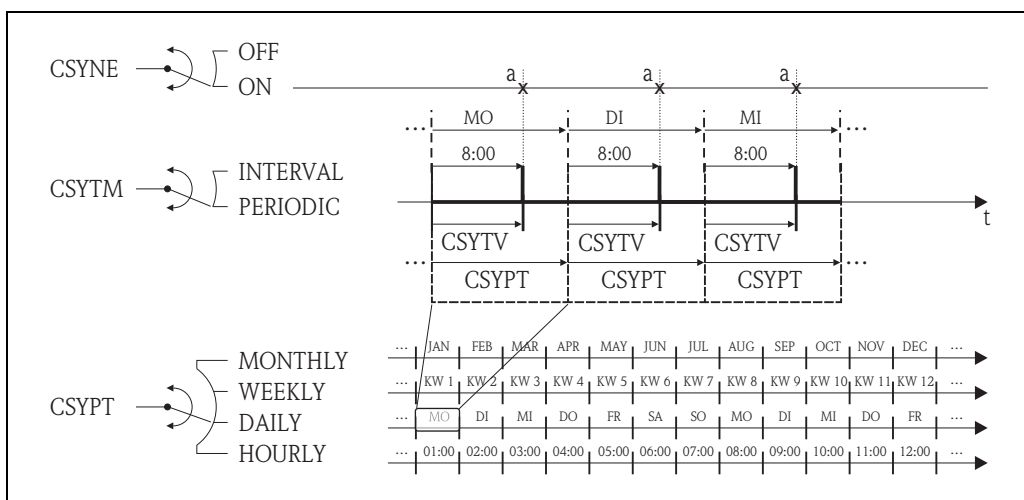

Fig. 77: Synchronizing the system time with the PERIODIC option selected in the CSYTM parameter

a Synchronization of the system time

19.5.7 Regular writing of process data to the data logger

It is possible to configure the regular writing of process values to the data logger using the parameters in parameter group 09 - Data logger → 152.

1. At a specific interval (interval 1)

The process values are written to the data logger after a specified time interval.

In the parameter:

- DLOGE (Acquisition) → 152: ON, enables writing with time interval 1.
- DLGSI (int. 1) → 152: time interval between transmissions, e.g. 10 hours.
 - ✓ The data are always transmitted after the time interval has elapsed.

Example: It is possible to specify that process values should be written to the data logger every 30 minutes (time interval 1; DLGSI).

2. Within a set time frame, at a specific interval (interval 2)

In addition, the process values are written to the data logger within a set time frame after a specific time interval.

In the parameter:

- DLOGE (Acquisition) → 152: ON, enables writing with time interval 1.
- DLI2E (Double int.) → 152: ON, enables writing with the additional time interval 2.
- DI2PT (int. 2) → 152: select the period in which the system should write data with the additional time interval 2, e.g. daily (MON, TUES etc.).
- I2ONT (T.ON) → 153: starting time within the time frame, for writing data with time interval 2
- I2OFT (T.ON) → 153: finishing time within the time frame, for writing data with time interval 2
- DLGS2 (int. 2) → 153: time interval between the transmissions, time interval 2.
 - ✓ The data are always transmitted after the time interval has elapsed.

Example: It is possible to specify that process values should be written to the data logger on a particular day (time frame, DI2PT) every 30 minutes (time interval 2; DLGS2) between 8:00 a.m. (starting time; I2ONT) and 12:00 midday (finishing time; I2OFT).

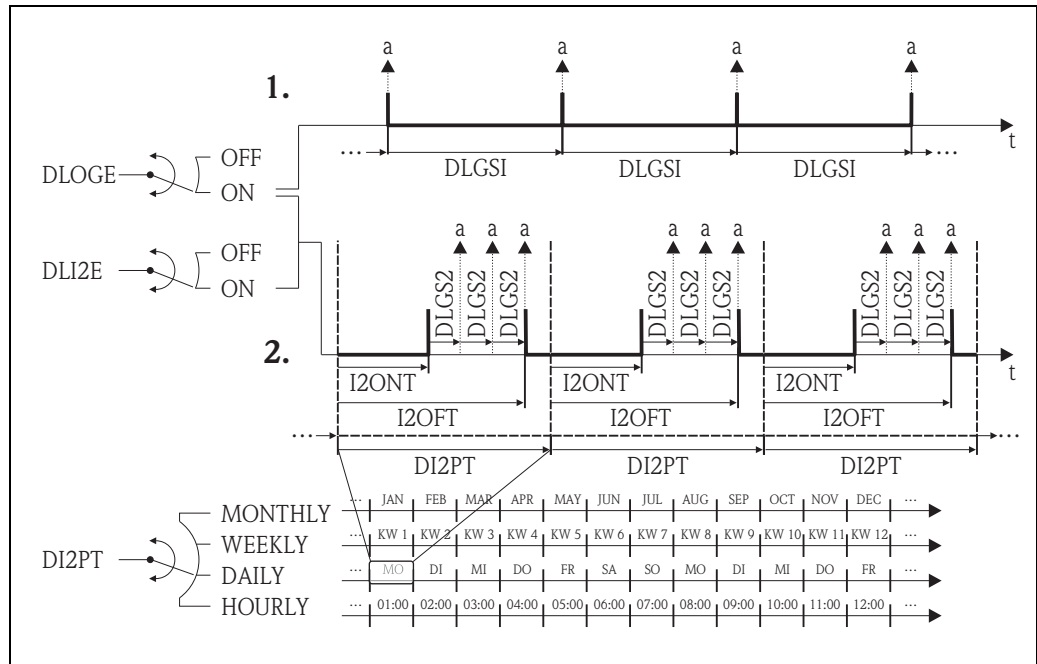

Fig. 78: Writing process values to the data logger

a Process values are written to the data logger

19.6 Operating commands of the Config5800 operating tool

Config 5800	Local display	Description	
ACODE	-	Access code	→ 163
ALARM	-	Status of alarms	→ 164
ALECL	-	Record the ETP commands.	→ 158
ALFIE	Alarm	Enable alarm suppression via input signal	→ 137
ALMNT	T. min AL	Alarm transmission delay time	→ 144
ALRSM	Send AL	Alarm transmission mode	→ 144
ANTSS	-	Antenna signal in %	→ 164
ATHYS	Hyst.	Hysteresis for all alarm limit values	→ 136
ATSIC	Self test	Start self-test	→ 156
BATTS	-	State of charge of battery in %	→ 164
BTMPV	-	Temp. of electronics board in selected unit	→ 164
BT1HE	-	Enter number of batteries at terminal B1	→ 160
BT2HE	B2	Enter number of batteries at terminal B2	→ 160
CALIC	Calibration	Start calibration	→ 156
CALIE	Calibration	Start enabling calibration via input signal	→ 137
CFFKA	KA	Calibration factor	→ 130
CFFKC	KC	Coefficient KC	→ 130
CFFKF	KF	Coefficient KF	→ 159
CFFKR	KR	Coefficient KF	→ 159
CFFKS	KS	Coefficient KS	→ 159
CFFKT	KT	Coefficient KT	→ 159

Config 5800	Local display	Description	
CFFKZ	KZ	Coefficient KZ	→ 130
CFGSI	Send config.	Immediate transmission of configuration	→ 149
CFLST	-	Configuration list	→ 163
CLIST	-	Command list	→ 163
CMRIC	Memory reset	Reset parameters to factory setting	→ 159
CRCT1	TC1	Control constant 1 for coil current control	→ 130
CRCT2	TC2	Control constant 2 for coil current control	→ 131
CRRMA	-	Parameters for coil current control	→ 131
CRVRF	-	Default value for coil current	→ 131
CSYIV	Interv	Period between checks	→ 148
CSYNE	Clock s	System time check	→ 147
CSYNI	Clock s	Immediate system time check	→ 149
CSYPT	Clock s	Interval for regular checks	→ 147
CSYTM	Clock s	Check mode	→ 147
CSYTV	Time	Time of regular checks	→ 148
DFLWE	Log Q	Flow recording	→ 155
DI2PT		Repeat rate for records	→ 153
DLFSC	Separator	Character separator for the CSV file, e.g. ("," or ";").	→ 155
DLGHE	-	Enable data logger and event logger	→ 160
DLGIV	Interv	Period between transmissions	→ 142
DLGPT	Send DL	Interval for regular transmission	→ 142
DLGS2	int. 2	Recording interval 2 of data logger	→ 153
DLGSI	int. 1	Recording interval 1 of data logger	→ 152
DLGSM	Send DL	Transmission of data from the data logger	→ 142
DLGTM	Send DL	Transmission mode	→ 142
DLGTV	Time	Time of regular transmissions	→ 142
DLIZE	Double int.	Enable data logger interval mode	→ 152
DLMRE	-	Min. and max. value from data logger	→ 153
DLMRD	-	Reset min. and max. value from data logger	→ 153
DLMSE	Log STAT	Record measurement statistics	→ 155
DLOGE	Acquisition	Enable data logger function	→ 152
DLOKE	Disp. lock	Enable display lock	→ 150
DLPNE	Log NP	Record the totalizer net partial	→ 154
DLPVE	% values	Record percentages	→ 155
DLRST	-	Reset data logger data not yet sent	→ 155
DLSIZ	-	Info on the size, No. of data records of the data logger	→ 156
DLSNI	Send DL	Immediate transmission of data logger data	→ 148
DLSTA	-	Information on status of the data logger data	→ 156
DLTNE	Log NT	Record totalizer net total	→ 154
DLUSE	M. units	Unit recording	→ 155
DTIME	SET DATE/TIME	Setting for the date and time	→ 151
DTPNE	Log P-	Record totalizer neg. partial	→ 154
DTPPE	Log P+	Record totalizer pos. partial	→ 154
DTTNE	Log T-	Record totalizer neg. total	→ 154

Config 5800	Local display	Description	
DTTPE	Log T+	Record totalizer pos. total	→ 154
EMLIV	Interv	Period between checks	→ 146
EMLPT	Ck mail	Interval for regular checks	→ 146
EMLRE	Ck mail	Immediate check for new mail	→ 146
EMLRI	Ck mail	Immediate system time check	→ 149
EMLTM	Ck mail	Check mode	→ 146
EMLTV	Time	Time of regular checks	→ 147
ENSDT	D.time	Time specified for automatic display switchoff	→ 150
ENSVE	-	Energy saving mode	→ 136
EPDEN	E.p. detect	Empty pipe detection on/off (OED)	→ 131
EPDTH	E.p. thr.	Value for empty pipe detection	→ 131
EVRST	-	Reset the events not yet sent	→ 155
EVTSE	Send events	Transmission of event data	→ 148
EVTSI	Send events	Immediate transmission of events	→ 149
FRANN	Al. min.-	Min. alarm limit value for negative flow	→ 136
FRANP	Al. min.+	Min. alarm limit value for positive flow	→ 136
FRAXN	Al. max.-	Max. alarm limit value for negative flow	→ 136
FRAXP	Al. max.+	Max. alarm limit value for positive flow	→ 136
FRFS1	Fs	Flow value that consider the 100 % full scale value	→ 132
FRMUT	Fs	Unit type for the 100 % full scale value	→ 132
FRMUV	Fs	Unit incl. time unit for the 100 % full scale value	→ 132
FRVPC	-	Flow value in %	→ 164
FRVPX	-	Flow value (w/o low flow cutoff) in %	→ 164
FRVTU	-	Flow value in the selected unit	→ 164
FRVTX	-	Flow value (w/o low flow cutoff) in the unit)	→ 164
GPAPN	-	Access point name (APN)	→ 160
GPASN	-	Telephone number of sender	→ 162
GPAUT	-	Network provider access authentic value	→ 161
GPDNP	-	Use FQDN of POP3 server	→ 162
GPDNS	-	Use FQDN of SMTP server	→ 161
GPDNT	-	Use FQDN of NTP server	→ 161
GPEMF	-	Mail address for server or network errors	→ 161
GPEMT	-	Mail address of receiver	→ 161
GPHEs	-	Identification of measuring device at SMTP server	→ 163
GPNRS	-	IP address of the DNS server	→ 161
GPPSW	-	Password for the user account	→ 161
GPP3A	-	IP address of the POP3 server	→ 162
GPP3P	-	TCP port for connecting to the POP3 server	→ 162
GPRES	-	Reset all the GPRS parameters	→ 163
GPRHE	-	Switch GPRS on/off	→ 160
GPSAE	-	Login of the measuring device to the SMTP server	→ 163
GPSMA	-	IP address of the SMTP server	→ 161
GPSMP	-	TCP port for connecting to the SMTP server	→ 161
GPSSN	-	Telephone number 1 of receiver	→ 162
GPSS2	-	Telephone number 2 of receiver	→ 162

Config 5800	Local display	Description	
GPSS3	-	Telephone number 3 of receiver	→ ⓘ 162
GPTSA	-	IP address of the NTP server	→ ⓘ 161
GPTSP	-	TCP port for connecting to the NTP server	→ ⓘ 162
GPUSR	-	User name for the user account	→ ⓘ 161
GP3PS	-	User password for receiving mails, POP3 server	→ ⓘ 162
GP3US	-	User name for receiving mails, POP3 server	→ ⓘ 162
GTEST	Gprs test	Start GPRS test	→ ⓘ 157
HWCFG	-	Check compatibility of laptop and measuring device	→ ⓘ 158
I2ONT	T. ON	Start recording interval 2	→ ⓘ 153
I2OFT	T. OFF	End recording interval 2	→ ⓘ 153
INTAG	-	Device name for mails	→ ⓘ 160
L2ACD	L2 code	Enter the access code for Level 2.	→ ⓘ 158
LFDIC	Load fact. data	Load parameter factory setting	→ ⓘ 159
LLANG	Language	Select the display language	→ ⓘ 150
MDCMD	-	Send a command directly to the modem	→ ⓘ 158
MDIAG	-	Diagnostics of the modem	→ ⓘ 158
MDDPI	-	Reinitialize modem after firmware upgrade	→ ⓘ 157
MEMDP	-	Read the entire memory for diagnostics purposes	→ ⓘ 158
MFCUT	Cut-off	Value for low flow cutoff	→ ⓘ 135
MFCT2	-	Internal value for low flow cutoff in %	→ ⓘ 136
MINAS	Min. ant.s.	Minimum strength of antenna signal	→ ⓘ 141
MLIST	-	Display all the supported commands	→ ⓘ 163
MODSV	-	Device model and software version	→ ⓘ 163
MPROF	Prof.	Frequency of measured value acquisition	→ ⓘ 135
MSIEN	Simulation	Enable/disable simulation	→ ⓘ 157
OF1TV	T. OFF	End regular transmission	→ ⓘ 139
ON1TV	T. ON	Start regular transmission	→ ⓘ 139
OF2TV	T. OFF	End regular transmission	→ ⓘ 141
ON2TV	T. ON	Start regular transmission	→ ⓘ 140
OP1PT	TPLS1	Pulse width 1	→ ⓘ 134
OP1PV	PLS1	Pulse value 1	→ ⓘ 133
OP2PT	TPLS2	Pulse width 2	→ ⓘ 134
OP2PV	PLS2	Pulse value 2	→ ⓘ 134
OUTHE	-	Enable/disable outputs	→ ⓘ 160
OUT1C	-	Direct control/status change of output 1	→ ⓘ 138
OUT1D	-	Diagnostics for output 1	→ ⓘ 158
OUT1F	OUT 1	Selection of the output variable	→ ⓘ 138
OU1PT	OUT 1	Regular transmission period	→ ⓘ 138
OUT2C	-	Direct control/status change of output 2	→ ⓘ 140
OUT2D	-	Diagnostics for output 2	→ ⓘ 158
OUT2F	OUT 2	Selection of the output variable	→ ⓘ 140
OU2PT	OUT 2	Regular transmission period	→ ⓘ 140
PDIMV	ND	Nominal diameter of the sensor	→ ⓘ 130
PRDIV	Interv	Period between transmissions	→ ⓘ 142
PRDPT	Send PD	Interval for regular transmission	→ ⓘ 143

Config 5800	Local display	Description	
PRDSI	Send PD	Immediate transmission of process data	→ 149
PRDSM	Send PD	Transmission of process data	→ 143
PRDTM	Send PD	Transmission mode	→ 143
PRDTV	Time	Time of regular transmissions	→ 142
PWSRC	Pwr scr	Enable supply voltage via output	→ 141
QSTME	Quick start	Switch on Quick Start function	→ 150
ROAME	Roaming	Enable roaming	→ 148
RSTDF	-	Reset the diagnostics flags	→ 158
SAVRE	Sensor test	Start sensor test	→ 131
SCRES	-	Resistance value of coil system	→ 131
SCTM1	-	Reference value 1 for sensor electronics	→ 131
SCTM2	-	Reference value 2 for sensor electronics	→ 131
SCTRF	-	Reference temperature for sensor electronics	→ 131
SDSTA	Read SDC info	Free space on SD card	→ 157
SFDIC	Save fact. data	Save parameter settings	→ 159
SPSIC	-	Save the reference values of the sensor	→ 160
SMODL	Sens.type	Sensor type	→ 130
SMSCI	Chk SMS	Immediate check for new messages	→ 149
SMSIV	Interv	Period between checks	→ 145
SMSPT	Chk SMS	Interval for regular checks	→ 145
SMSRE	Chk SMS	Check for new message	→ 145
SMSTM	Chk SMS	Check mode	→ 145
SMSTV	Time	Time for regular checks	→ 145
SMSWT	SMS wait t	Duration of check for new message	→ 146
SRCOD	-	Serial number	→ 160
SRNUM	-	Serial number of electronics board	→ 159
STBYC	Standby	Standby function	→ 157
STSTC	Sensor test	Start sensor test	→ 156
SWUPD	-	Update software	→ 163
TCLIE	Count lock	Disable totalization via input signal	→ 137
TMMUV	Temp. u. meas.	Unit for the temperature	→ 132
TMPLR	-	Temperature of electronics board	→ 158
TMPRE	-	Reset max. temperature value of electronics board	→ 158
TOMCY	-	Number of measuring cycles	→ 160
TONTM	-	Display the operating hours	→ 159
TZONE	T.zone	Change time to suit time zone	→ 151
VMSGC	Sg	Density coefficient for volume to mass	→ 134
VTDPP	Tot1MU	Display totalizer value	→ 133
VTMUT	Tot1MU	Display totalizer value (unit type)	→ 133
	PLS1	Display pulse value 1 (unit type)	→ 133
	PLS2	Display pulse value 2 (unit type)	→ 134
VTMUV	Tot1MU	Display totalizer value (unit)	→ 133
	PLS1	Display pulse value 1 (unit)	→ 133
	PLS2	Display pulse value 2 (unit)	→ 134
VTPNE	P - reset	Reset totalizer, negative total	→ 137

Config 5800	Local display	Description	
VTPNR	P – reset	Reset negative total	→ 151
VTPNS	–	Specify totalizer negative partial	→ 151
VTPNT	–	Totalizer negative net partial	→ 164
VTPNV	–	Totalizer negative partial	→ 164
VTPPE	P + reset	Reset totalizer, positive total	→ 137
VTPPR	P + reset	Reset totalizer, positive total	→ 150
VTPPS	–	Specify totalizer positive partial	→ 151
VTPPV	–	Totalizer positive partial	→ 164
VTTNE	T – reset	Reset totalizer, negative total	→ 137
VTTNR	T – reset	Reset totalizer, negative total	→ 151
VTTNS	–	Specify the neg. total of the totalizer	→ 151
VTTNT	–	Totalizer positive net total	→ 164
VTTNV	–	Totalizer negative total	→ 164
VTTPE	T + reset	Reset totalizer, positive total	→ 137
VTTPS	–	Specify the positive total of the totalizer	→ 151
VTTPR	T + reset	Reset positive total	→ 150
VTTPV	–	Totalizer positive total	→ 164
WKUIE	Wake-up	Enable the automatic wake-up signal	→ 138

19.7 Abbreviations

19.7.1 Units

Unit	Meaning	
cm ³	Cubic centimeter	SI unit
ml	Milliliter	SI unit
l	Liter	SI unit
dm ³	Cubic decimeter	SI unit
dal	Decaliter	SI unit
hl	Hectoliter	SI unit
m ³	Cubic meter	SI unit
in ³	Cubic inch	US unit
Gal	Gallon (US)	US unit
IGL	Imperial gallon	Imperial (British)
ft ³	Cubic feet	US unit
bbbl	Standard barrel	US unit
BBL	Oil barrel	US unit
IKG	Imperial kilogallon	Imperial (British)
KGL	US kilogallon	US unit
Aft	Acre feet	US unit
MGL	US megagallon	US unit
IMG	Imperial megagallon	Imperial (British)
oz	Ounce	US unit
lbs	Pound	US unit
ton	US ton	US unit
g	Gram	SI unit
kg	Kilogram	SI unit
t	Metric ton	SI unit
/s	Per second	Time unit
/min	Per minute	Time unit
/h	Per hour	Time unit
/d	Per day	Time unit

19.8 Factory setting

19.8.1 SI units (not for USA and Canada)

Low flow cutoff, full scale value, pulse value, totalizer

Nominal diameter		Low flow cut off		Full scale value		Pulse value		Totalizer
[mm]	[in]	(approx. v = 0.04 m/s)		(approx. v = 2.5 m/s)		(approx. 2 pulse/s at v = 2.5 m/s)		
25	1"	2	dm ³ /min	75	dm ³ /min	0,03	dm ³	dm ³
32	1 ¼"	4	dm ³ /min	125	dm ³ /min	0,05	dm ³	dm ³
40	1 ½"	6	dm ³ /min	200	dm ³ /min	0,08	dm ³	dm ³
50	2"	10	dm ³ /min	300	dm ³ /min	0,10	dm ³	dm ³
65	2 ½"	15	dm ³ /min	500	dm ³ /min	0,20	dm ³	dm ³
80	3"	20	dm ³ /min	750	dm ³ /min	0,30	dm ³	dm ³
100	4"	40	dm ³ /min	1200	dm ³ /min	0,50	dm ³	dm ³
125	5"	60	dm ³ /min	1850	dm ³ /min	0,75	dm ³	dm ³
150	6"	5	m ³ /h	150	m ³ /h	0,001	m ³	m ³
200	8"	10	m ³ /h	300	m ³ /h	0,002	m ³	m ³
250	10"	15	m ³ /h	500	m ³ /h	0,003	m ³	m ³
300	12"	20	m ³ /h	750	m ³ /h	0,004	m ³	m ³

Language

Country	Language	Country	Language
Belgium	English	Japan	English
Denmark	English	Malaysia	English
Germany	Deutsch	Norway	English
England	English	Austria	Deutsch
Finland	English	Sweden	English
France	Francais	Switzerland	Deutsch
Netherlands	English	Singapore	English
Hong Kong	English	Spain	Espanol
International Instruments	English	South Africa	English
Italy	Italiano	Thailand	English

19.8.2 US units (only for USA and Canada)

Low flow cutoff, full scale value, pulse value, totalizer

Nominal diameter		Low flow cut off		Full scale value		Pulse value		Totalizer
[in]	[mm]	(approx. v = 0.04 m/s)		(approx. v = 2.5 m/s)		(approx. 2 pulse/s at v = 2.5 m/s)		
1"	25	0,60	gal/min	20	gal/min	0,008	gal	gal
1 ¼"	32	1,00	gal/min	30	gal/min	0,015	gal	gal
1 ½"	40	1,50	gal/min	50	gal/min	0,02	gal	gal
2"	50	2,50	gal/min	80	gal/min	0,03	gal	gal
2 ½"	65	4,00	gal/min	150	gal/min	0,05	gal	gal
3"	80	6,00	gal/min	200	gal/min	0,08	gal	gal
4"	100	10,0	gal/min	300	gal/min	0,15	gal	gal
5"	125	15,0	gal/min	500	gal/min	0,20	gal	gal
6"	150	20,0	gal/min	700	gal/min	0,30	gal	gal
8"	200	40,0	gal/min	1200	gal/min	0,50	gal	gal
10"	250	60,0	gal/min	2000	gal/min	0,80	gal	gal
12"	300	80,0	gal/min	3000	gal/min	1,15	gal	gal

Language

Country	Language
USA	English
Canada	English

Index

Numerics

100% full scale value. 169

A

Abbreviations 178
 Access to parameters 128
 Accessories 106
 Adapters 23
 Adapters (sensor installation) 23
 Altitude 114
 Ambient temperature range 114

B

Batteries
 Arrangement 40
 Disposal 108
 Inserting and connecting 42
 Power consumption 91
 Replacing 105
 Specification 92, 111
 Battery power consumption 91
 Battery specifications 92, 111

C

Cable entry 34, 112
 CE mark 120
 Certificates and approvals 120
 Changing the operating language 90
 Commissioning
 Establishing wireless communication 70
 Inserting the SIM card 68
 Recommended sequence 67
 Conductivity 116
 Conductivity of fluid 116
 Config 5800 operating tool
 Access authorization 62
 Adjusting the user interface 56
 Changing parameters 60
 Connecting the laptop to the measuring device. 52
 Establishing the communication 53
 Function menu 55
 Function scope 51
 How to acquire 52
 Installing 52
 Integrated user interface 56
 Saving and loading parameters 63
 Saving and loading SD card data 64
 Saving and loading the configuration 63
 Selecting parameters 56
 Tree structure view 58
 User interface 55

Configuration

E-mail communication (receiving) 80
 E-mail communication (sending) 74
 GPRS communication 72
 SMS communication 70
 System time synchronization 83

Configuring e-mail communication (receiving) 80
 Configuring e-mail communication (sending) 74
 Configuring GPRS communication 72
 Configuring SMS communication 70
 Configuring system time synchronization 83
 Connecting cable 24, 31
 Connecting the measuring device
 Batteries 40
 Connecting cable 36
 External supply voltage 38
 GSM/GPRS antenna 37
 Inputs and outputs 35
 Potential equalization 44
 Conversion 103

D

Data logger 111
 Declaration of Conformity 121
 Degree of protection 115
 Design 116
 Design, dimensions 116
 Designated use 8
 Device parameters 124
 Diagnostic events
 Calibration 101
 Display data 101
 GPRS test 102
 SD card information 102
 Self-test 101
 Sensor test 101
 Standby 101
 Diagnostics 97
 Disposal 108
 Disposing of the packaging 17
 Document conventions 5
 Documentation 7
 Drinking water approval 120

E

Electrical connection 31
 Electrodes
 Measuring electrode plane 21
 Reference electrode (potential equalization) 21
 Electromagnetic compatibility (EMC) 115
 EMC (electromagnetic compatibility) 32
 Error messages 97
 Exterior cleaning 105

F

Factory setting 179
 SI units 179
 US units 180
 Fitted electrodes 119
 Flow 23

G

Galvanic isolation 111

GPRS support	122
Ground cable	25
GSM approvals	120
GSM/GPRS antenna	119
GSM/GPRS error messages	101
GSM/GPRS modem	110
Guaranteeing the degree of protection	46
Guidelines	120
I	
Incoming acceptance	12
Inlet and outlet runs	22
Inlet runs	22
Input	109
Input signal	110
Installation conditions	
Inlet and outlet runs	22
Vibrations	22
Installing the measuring device	18
Installing the wall-mount housing	29
Interior cleaning	105
L	
Languages	120
LED	69
Local display	
Access authorization	51
Changing parameters	50
Changing the display area	50
Display area	48
Keypad lock	51
Operating elements	48
Lock switch	89
Low flow cut off	111
M	
Main menu	124
Maintenance work	105
Managing the configuration	87
Material	118
Material load diagram	115, 118–119
Maximum measured error	113
Measured variables	109
Measuring and testing equipment	105
Measuring principle	109
Measuring range	110
Measuring system	109
Mechanical construction	116
Medium pressure range (nominal pressure)	116
Medium temperature range	115
Mobile communications network (GSM)	122
N	
Nameplates	13
O	
Occupational safety	9
Operable flow range	110
Operating commands of the Config5800 operating tool	172

Operating concept	48
Operating menus	47
Operating options	47
Operating tool error messages	100
Operational safety	9
Order code	14
Orientation	21
Other standards	120
Outlet runs	22
Output	110
Output signal	110
P	
Parameter descriptions	130
Parameter group	
1 - Sensor	130
10 - Diagnostic	156
11 - Internal data	158
2 - Scales	132
3 - Measure	135
4 - Alarms	136
5 - Inputs	137
6 - Outputs	138
7 - Communication	141
8 - Display	150
9 - Data logger	151
Auxiliary cmds	163
GPRS data	160
Process data	164
Parameters	125
Performance characteristics	113
Post-connection check	46
Post-installation check	30
Potential equalization	43
Power consumption	112
Power supply	111–112
Power supply failure	112
Pressure loss	116
Adapters (reducers, expanders)	23
Pressure tightness	116
Process connections	119
Product description	11
Product identification	13
Product safety	10
Promag W	
Ground cable	25
Installation	25
Seals	25
Tightening torques	25
Q	
Quick Start menu	129
R	
Reading measured values	90
Reference operating conditions	113
Regular check	
For new e-mail	168
New text messages	167
Regular synchronization of the system time	170

Regular transmission	
Data from the data logger.....	165
Process data.....	166
Regular writing of data to the data logger.....	171
Reinforced connecting cables.....	32
Remote operation.....	120
Remote version cable specification	
Cable length, conductivity.....	24
Repair.....	103
Repeatability.....	113
Replacing the batteries.....	105
Return.....	107
S	
Safety instructions.....	5
Seals.....	25
Sensor installation	
Adapters.....	23
Installation.....	25
Services.....	104–105
Setting the operating language.....	87
Shock and vibration resistance.....	115
Signal on alarm.....	111
Simulation.....	87
Spare parts.....	103
Status input (auxiliary input).....	110
Status/pulse output.....	110
Storage.....	16
Storage temperature.....	114
Surface roughness.....	119
Switching on the measuring device.....	69
Switching the display.....	90
System error codes.....	99
T	
Technical data.....	109
Terminal assignment.....	111
Terminals.....	112
Tightening torques	
Sensor.....	25
Transmitter.....	119
Totalizer reset.....	90
Transport.....	16
Troubleshooting.....	97
Turning the transmitter housing.....	28
V	
Vibrations.....	22
W	
Wall-mount housing, installing.....	29
Weight.....	117
Wire end ferrules.....	33
Write protection.....	89

www.addresses.endress.com
