

# Operating Instructions **Gammapilot M FMG60** **HART**

Radiometric measurement

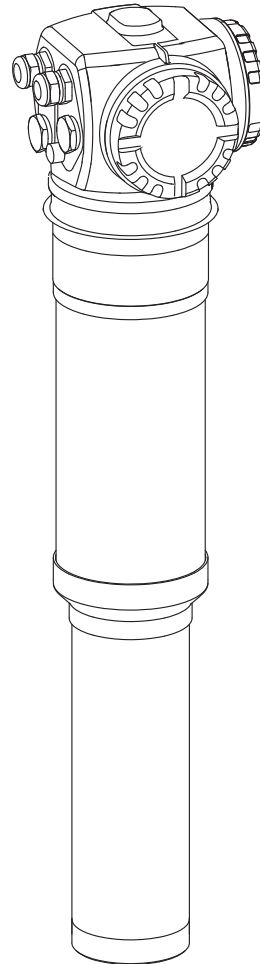

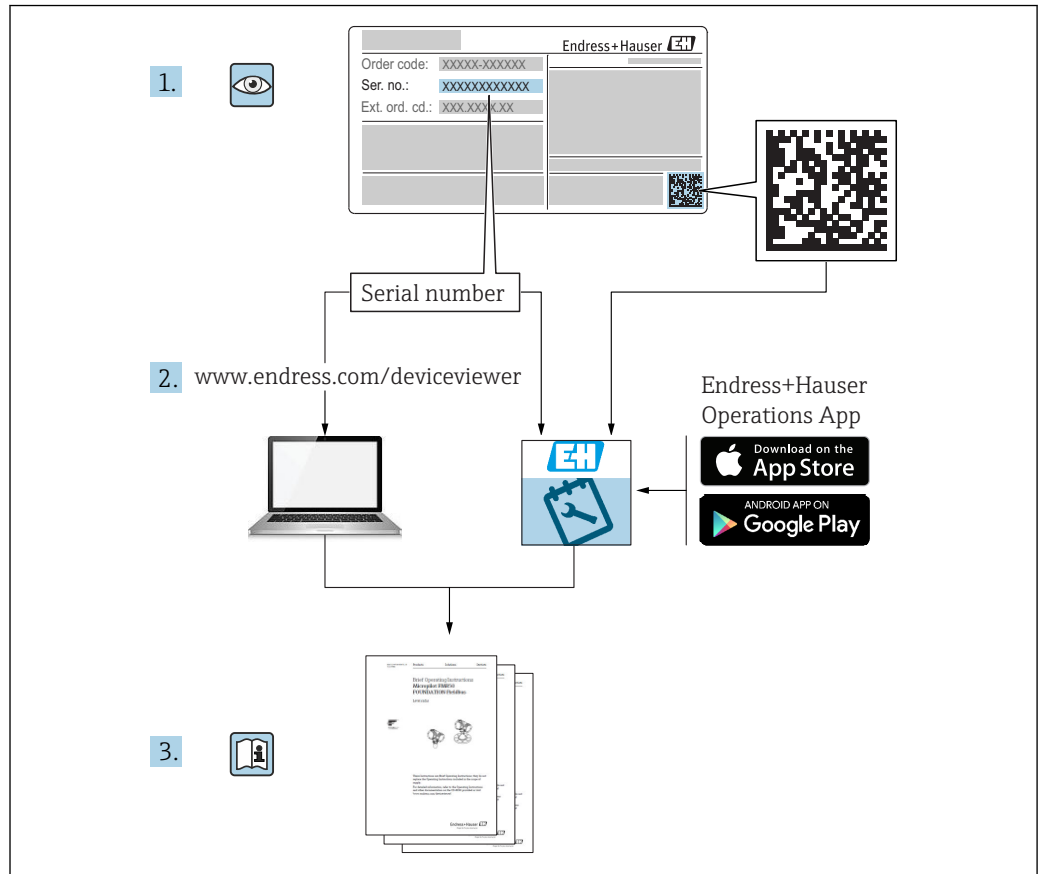

A0023555

# Gammapiilot M - Quick guide

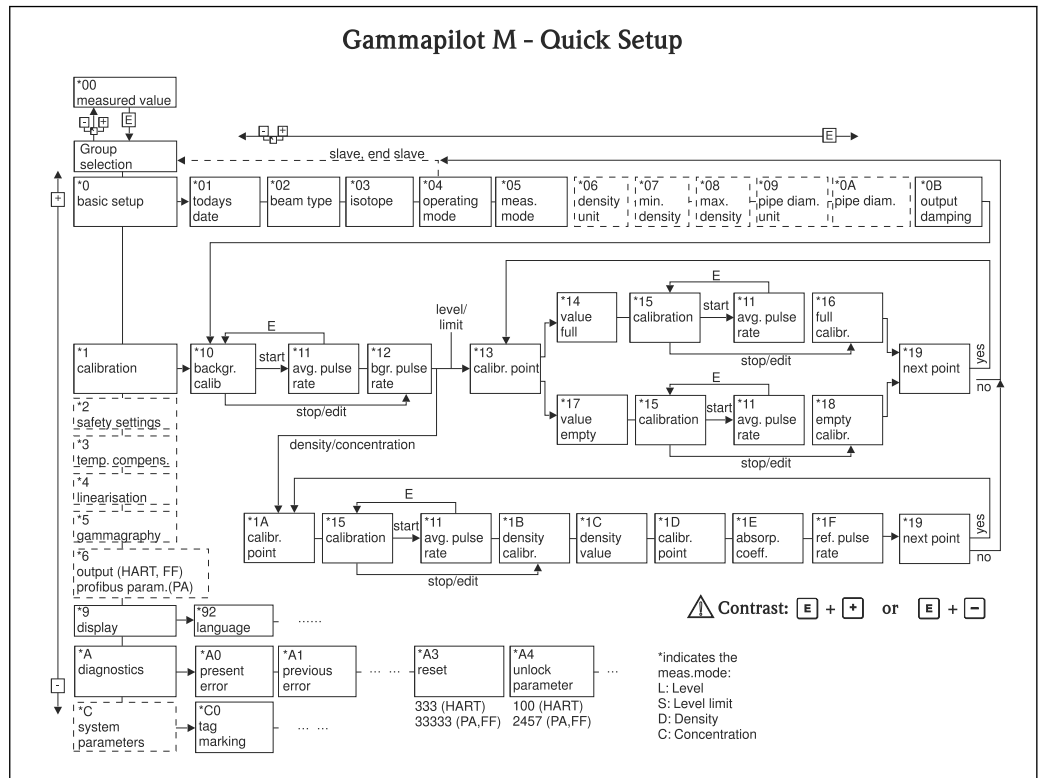

A0036818-EN

## Contents of these Operating Instructions

These Operating Instructions describe how to install and commission the radiometric compact transmitter Gammapilot M. All of the functions that are necessary for standard measuring tasks are included. In addition, the Gammapilot M provides many additional functions for optimizing the measuring point and for converting the measured value. These functions are not described in these Operating Instructions.

An overview of the operating menu is provided in the Appendix →  90

A detailed description of all the device functions is provided in the "Gammapilot M - Description of Device Functions" document, which can be found on the CD-ROM supplied.



BA00287F/00/EN

## Table of contents

<b>1</b>	<b>About this document</b> . . . . .	<b>8</b>		
1.1	Document function . . . . .	8		
1.2	Symbols used . . . . .	8		
1.2.1	Safety symbols . . . . .	8		
1.2.2	Electrical symbols . . . . .	8		
1.2.3	Tool symbols . . . . .	8		
1.2.4	Symbols for certain types of information . . . . .	9		
1.2.5	Symbols in graphics . . . . .	9		
<b>2</b>	<b>Basic safety instructions</b> . . . . .	<b>10</b>		
2.1	Requirements for the personnel . . . . .	10		
2.2	Designated use . . . . .	10		
2.3	Installation, commissioning and operation . . . . .	10		
2.4	Hazardous area . . . . .	10		
2.5	Radiation protection . . . . .	11		
2.5.1	Basic radiation protection guidelines . . . . .	11		
2.6	Workplace safety . . . . .	12		
2.7	Operational safety . . . . .	12		
2.8	Product safety . . . . .	12		
<b>3</b>	<b>Product description</b> . . . . .	<b>14</b>		
3.1	Product design . . . . .	14		
3.1.1	Components of the FMG60 . . . . .	14		
3.2	Nameplates . . . . .	15		
3.2.1	Device nameplate . . . . .	15		
3.2.2	Supplementary nameplate (examples) . . . . .	15		
3.3	Scope of delivery . . . . .	15		
3.4	Accompanying documentation . . . . .	16		
3.4.1	Operating Instructions (BA00236F/00/EN) . . . . .	16		
3.4.2	Description of Device Functions (BA00287F/00/EN) . . . . .	16		
3.4.3	Safety instructions . . . . .	16		
3.5	Certificates and approvals . . . . .	16		
3.6	Registered trademarks . . . . .	16		
<b>4</b>	<b>Mounting</b> . . . . .	<b>17</b>		
4.1	Incoming acceptance, product identification, transport, storage . . . . .	17		
4.1.1	Incoming acceptance . . . . .	17		
4.1.2	Product identification . . . . .	17		
4.1.3	Transport . . . . .	17		
4.1.4	Storage . . . . .	17		
4.2	Installation conditions . . . . .	17		
4.2.1	Dimensions, weight . . . . .	17		
4.2.2	Installation conditions for level measurement . . . . .	18		
4.2.3	Installation conditions for point level detection . . . . .	19		
4.2.4	Installation conditions for density and concentration measurements . . . . .	20		
4.2.5	Empty pipe detection . . . . .	22		
4.2.6	Installation conditions for flow measurement . . . . .	22		
4.3	Water cooling . . . . .	23		
4.3.1	Mounting position and position of the cooling water nozzles . . . . .	24		
4.3.2	Required flow . . . . .	25		
4.4	Post-installation check . . . . .	25		
<b>5</b>	<b>Wiring</b> . . . . .	<b>27</b>		
5.1	Connection compartments . . . . .	27		
5.2	Cable entries . . . . .	27		
5.3	Terminal assignment . . . . .	28		
5.4	Fieldbus connectors . . . . .	30		
5.4.1	Pin assignment for connector M12 . . . . .	30		
5.4.2	Pin assignment for connector 7/8" . . . . .	30		
5.5	Potential equalization . . . . .	30		
5.6	Wiring in connection compartment 1 . . . . .	31		
5.7	Wiring in connection compartment 2 . . . . .	32		
5.8	Connecting the remote display and operating unit FHX40 . . . . .	33		
5.9	Wiring for cascade mode . . . . .	35		
5.10	Wiring example for point level detection 200/400 mm . . . . .	35		
5.10.1	Ex applications in conjunction with RMA42 . . . . .	36		
5.10.2	SIL applications for Gammapilot M FMG60 in conjunction with RMA42 (for point level detection 200/400 mm PVT scintillator) . . . . .	37		
5.11	Post-connection check . . . . .	37		
<b>6</b>	<b>Operation</b> . . . . .	<b>38</b>		
6.1	Overview of the operating options . . . . .	38		
6.1.1	4 to 20 mA with HART protocol . . . . .	38		
6.2	Display operation . . . . .	38		
6.2.1	Display and operating elements . . . . .	38		
6.2.2	The operating menu . . . . .	40		
6.3	Alternative operation options . . . . .	42		
6.3.1	Operation via Field Xpert SFX100 . . . . .	42		
6.3.2	Operation with FieldCare . . . . .	42		
6.4	Locking/unlocking configuration . . . . .	43		
6.4.1	Software locking . . . . .	43		
6.4.2	Hardware locking . . . . .	43		
6.5	Resetting to the default configuration . . . . .	43		
<b>7</b>	<b>Commissioning</b> . . . . .	<b>44</b>		
7.1	Calibration: overview . . . . .	44		
7.2	Switching on the device . . . . .	45		
7.3	Basic setup . . . . .	46		
7.3.1	"Present date" (*01) . . . . .	46		
7.3.2	"Beam type" (*02) . . . . .	46		

7.3.3	"Isotope" (*03) . . . . .	46	8.2	Repairs . . . . .	73
7.3.4	"Operating mode" (*04) . . . . .	46	8.3	Repairs to Ex- or SIL-certified devices . . . . .	73
7.3.5	"Measuring mode" (*05) . . . . .	47	8.4	Replacement . . . . .	73
7.3.6	"Density unit" (*06) . . . . .	48	8.5	Return . . . . .	73
7.3.7	"Min. density" (*07) . . . . .	49	8.5.1	Return . . . . .	73
7.3.8	"Max. density" (*08) . . . . .	49	8.6	Disposal . . . . .	74
7.3.9	"Pipe diameter unit" (*09) . . . . .	49	8.7	Contact addresses at Endress+Hauser . . . . .	74
7.3.10	"Pipe diameter" (*0A) . . . . .	49	<b>9</b>	<b>Accessories . . . . .</b>	<b>75</b>
7.3.11	"Output damping" (*0B) . . . . .	50	9.1	Commubox FXA195 HART . . . . .	75
7.4	Calibration for level measurement and point level detection . . . . .	51	9.2	Commubox FXA291 . . . . .	75
7.4.1	General principles . . . . .	51	9.3	ToF Adapter FXA291 . . . . .	75
7.4.2	Background calibration . . . . .	53	9.4	Field Xpert SFX100 . . . . .	75
7.4.3	Full and empty calibration or covered and free calibration . . . . .	55	9.5	Remote display and operating unit FHX40 . . . . .	76
7.4.4	Additional settings . . . . .	58	9.5.1	Dimensions . . . . .	76
7.4.5	Configuration of the connected limit switch (for point level detection) . . . . .	59	9.5.2	Ordering information . . . . .	76
7.5	Function group "Safety settings" (*2) . . . . .	59	9.5.3	Technical data (cable and housing) . . . . .	77
7.5.1	"Output on alarm" (*20) . . . . .	59	9.5.4	Materials . . . . .	77
7.5.2	"Output on alarm" (*21) . . . . .	59	9.6	Mounting device FHG60 (for level and point level measurement) . . . . .	78
7.6	SIL locking (for point level detection 200/400 mm PVT scintillator) (HART only) . . . . .	60	9.6.1	Dimensions . . . . .	78
7.6.1	List of the parameters to be confirmed . . . . .	60	9.6.2	Use . . . . .	79
7.6.2	Function "Security locking" (*22) (SIL unlocking) . . . . .	61	9.6.3	Ordering information . . . . .	79
7.6.3	Forgotten your password? . . . . .	61	9.7	Clamping device for density measurement FHG61 . . . . .	80
7.6.4	Function "Password" (*23) (security password) . . . . .	61	9.8	Measurement section for density measurement FHG62 . . . . .	80
7.6.5	Function "Confirm Iout" (*24) (output current during locking) . . . . .	61	9.9	Memograph M, RSG45 . . . . .	80
7.6.6	Function "Confirm sequence" (*25) (display check) . . . . .	62	9.9.1	Measuring principle . . . . .	80
7.6.7	Function "Confirm backgr." (*26) . . . . .	62	9.9.2	Measuring system . . . . .	80
7.6.8	Function "Confirm cal." (*27) . . . . .	62	9.10	RMA42, process transmitter with control unit . . . . .	81
7.6.9	Function "Confirm source" (*28) . . . . .	62	9.10.1	Measuring principle . . . . .	81
7.6.10	Function "Confirm time" (*29) (output damping) . . . . .	63	9.10.2	Measuring system . . . . .	81
7.6.11	Function "Confirm date" (*2A) . . . . .	63	<b>10</b>	<b>Troubleshooting . . . . .</b>	<b>82</b>
7.6.12	Function "Confirm length" (*2B) . . . . .	63	10.1	System error messages . . . . .	82
7.6.13	Function "Confirm password" (*2C) . . . . .	63	10.1.1	Error signal . . . . .	82
7.6.14	Function "Password" (*2D) (unlock password) . . . . .	64	10.1.2	Last error . . . . .	82
7.7	Calibration for density and concentration measurements . . . . .	64	10.1.3	Types of error . . . . .	82
7.7.1	General principles . . . . .	64	10.1.4	Error codes . . . . .	82
7.7.2	Background calibration . . . . .	66	10.2	Possible calibration errors . . . . .	84
7.7.3	Calibration points . . . . .	67	10.3	Software history . . . . .	85
7.7.4	Linearization (for concentration measurements) . . . . .	71	<b>11</b>	<b>Technical data . . . . .</b>	<b>86</b>
7.7.5	Additional settings . . . . .	71	11.1	Additional technical data . . . . .	86
7.8	Density measurement/temperature-compensated . . . . .	71	11.2	Supplementary documentation . . . . .	86
7.9	Gammagraphy detection . . . . .	72	11.2.1	Clamping device for level and point level detection FHG60 . . . . .	86
<b>8</b>	<b>Maintenance and repair . . . . .</b>	<b>73</b>	11.2.2	Clamping device for density measurement FHG61 . . . . .	86
8.1	Cleaning . . . . .	73	11.2.3	Measurement section for density measurement FHG62 . . . . .	86
			11.2.4	Certificates and approvals . . . . .	86

<b>12</b>	<b>Appendix</b> .....	<b>90</b>
12.1	Operating menu for level measurements .....	90
12.2	Operating menu for level limit (point level) detection .....	92
12.3	Operating menu for density and concentration measurements .....	94





# 1 About this document

## 1.1 Document function





These Operating Instructions contain all the information that is required in the various phases of the life cycle of the device: from product identification, incoming acceptance and storage, to mounting, connection, operation and commissioning through to troubleshooting, maintenance and disposal.

## 1.2 Symbols used



### 1.2.1 Safety symbols

Symbol	Meaning
	<b>DANGER!</b> This symbol alerts you to a dangerous situation. Failure to avoid this situation will result in serious or fatal injury.
	<b>WARNING!</b> This symbol alerts you to a dangerous situation. Failure to avoid this situation can result in serious or fatal injury.
	<b>CAUTION!</b> This symbol alerts you to a dangerous situation. Failure to avoid this situation can result in minor or medium injury.
	<b>NOTE!</b> This symbol contains information on procedures and other circumstances which do not result in personal injury.

### 1.2.2 Electrical symbols













Symbol	Meaning
	<b>Direct current</b> A terminal at which DC is present or through which DC flows.
	<b>Alternating current</b> A terminal to which alternating voltage (sine-wave) is applied or through which alternating current flows.
	<b>Ground connection</b> A grounded terminal which, as far as the operator is concerned, is grounded via a grounding system.
	<b>Protective ground connection</b> A terminal which must be connected to ground prior to establishing any other connections.

### 1.2.3 Tool symbols

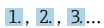

Symbol	Meaning
	Flat blade screwdriver
	Allen key



### 1.2.4 Symbols for certain types of information

Symbol	Meaning
	<b>Permitted</b> Procedures, processes or actions that are permitted.
	<b>Preferred</b> Procedures, processes or actions that are preferred.
	<b>Forbidden</b> Procedures, processes or actions that are forbidden.
	<b>Tip</b> Indicates additional information.
	Reference to documentation
	Reference to page
	Reference to graphic
	Notice or individual step to be observed
	Series of steps
	Result of a step
	Help in the event of a problem
	Visual inspection
	Operation via local display
	Operation via operating tool
	Write-protected parameter

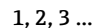
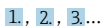
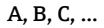
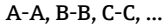
### 1.2.5 Symbols in graphics

Symbol	Meaning
	Item numbers
	Series of steps
	Views
	Sections
	<b>Hazardous area</b> Indicates the hazardous area.
	<b>Safe area (non-hazardous area)</b> Indicates the non-hazardous area.

## 2 Basic safety instructions

### 2.1 Requirements for the personnel

The personnel for installation, commissioning, diagnostics and maintenance must fulfill the following requirements:

- ▶ Trained, qualified specialists must have a relevant qualification for this specific function and task.
- ▶ Are authorized by the plant owner/operator.
- ▶ Are familiar with federal/national regulations.
- ▶ Before starting work, read and understand the instructions in the manual and supplementary documentation as well as the certificates (depending on the application).
- ▶ Follow instructions and comply with basic conditions.

The operating personnel must fulfill the following requirements:

- ▶ Are instructed and authorized according to the requirements of the task by the facility's owner-operator.
- ▶ Follow the instructions in this manual.

### 2.2 Designated use

The Gammapilot M is a compact transmitter for non-contact level, point level, density and concentration measurement. The measuring range of a single Gammapilot M is up to 2 m (6.6 ft). Large measuring ranges of any size can be implemented, however, by cascading several Gammapilot M devices. When used for point level detection, the Gammapilot is certified according to IEC 61508 for safety-related operation up to SIL 2/3.

### 2.3 Installation, commissioning and operation

The Gammapilot M is designed to meet state-of-the-art safety requirements and complies with applicable standards and EC regulations. However, if it is used improperly or for applications for which it is not intended, application-related hazards may arise, e.g. product overflow due to incorrect installation or configuration. Installation, electrical connection, commissioning, operation and maintenance of the measuring system must therefore be carried out exclusively by trained specialists authorized to perform such work by the system operator. Technical personnel must have read and understood these Operating Instructions and must adhere to them. Modifications and repairs to the device may only be carried out if they are expressly permitted in the Operating Instructions.

### 2.4 Hazardous area

If the measuring system is used in hazardous areas, the corresponding national standards and regulations must be observed. The device is accompanied by separate "Ex documentation", which is an integral part of these Operating Instructions. The installation specifications, connection values and safety instructions listed in this supplementary documentation must be observed.

- Ensure that all technical personnel are suitably qualified and trained.
- Comply with the metrological and safety-related requirements for the measuring point.

#### CAUTION

**The detector or cooling jacket can become damaged if the cooling water freezes.**

- ▶ Empty sensor with cooling jacket or protect against freezing.

**⚠ WARNING**

- ▶ The three screws connecting the detector pipe to the terminal housing may not be opened.

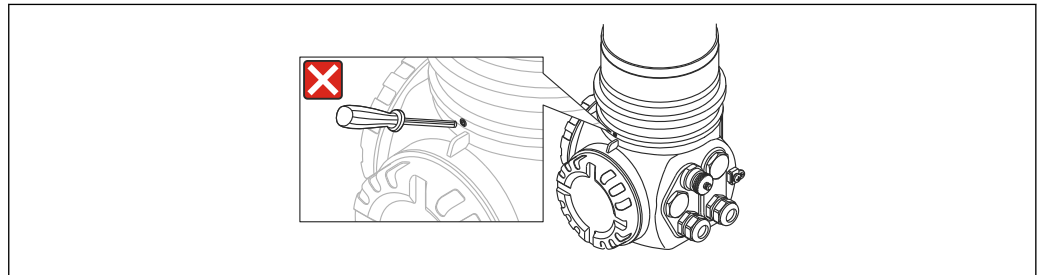

A0018068

**⚠ WARNING**

- ▶ Depending on the certificate ordered, observe the associated safety instructions → 86

## 2.5 Radiation protection

The Gammapilot M is used in conjunction with a radioactive source, contained in a source container. When handling radioactive sources, the following instructions must be observed:

### 2.5.1 Basic radiation protection guidelines

**⚠ WARNING**

- ▶ When working with radioactive sources, avoid any unnecessary exposure to radiation. All unavoidable radiation exposure must be kept to a minimum. Three basic concepts apply to achieve this:

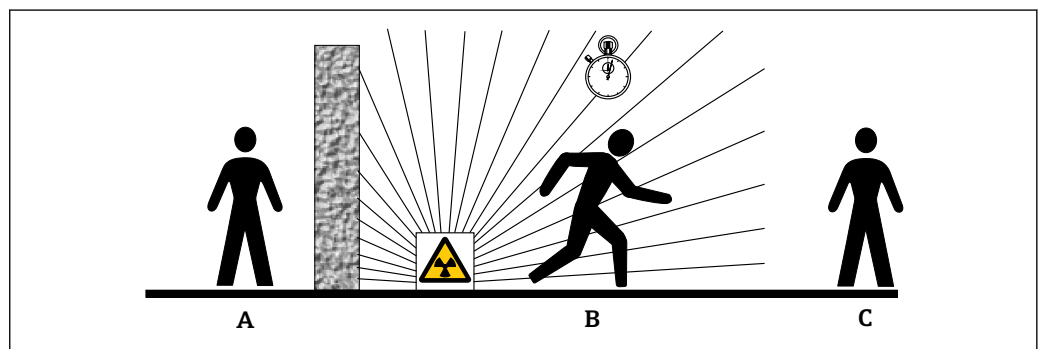

A0016373

A *Shielding*B *Time*C *Distance*

### Shielding

Ensure the best possible shielding between the radiation source and yourself and all other persons. Effective shielding is provided by source containers (FQG60, FQG61/FQG62, FQG63, QG2000) and all high-density materials (lead, iron, concrete etc.).

**⚠ CAUTION**

- ▶ When working with source containers, all the instructions for mounting and usage outlined in the following documents must be observed:

Source container	Document
FQG60	TI00445F/00/EN
FQG61, FQG62	TI00435F/00/EN
FQG63	TI00446F/00/EN
QG2000	TI00346F/00/EN BA00223F/00/EN

### Time

The time spent in the exposed area should be kept to a minimum.

### Distance

Keep as far away from the radiation source as possible. The radiation intensity decreases in proportion to the square of the distance from the radiation source.

## 2.6 Workplace safety

For work on and with the device:

- ▶ Wear the required personal protective equipment according to federal/national regulations.

## 2.7 Operational safety

Risk of injury.

- ▶ Operate the device in proper technical condition and fail-safe condition only.
- ▶ The operator is responsible for interference-free operation of the device.

### Conversions to the device

Unauthorized modifications to the device are not permitted and can lead to unforeseeable dangers.

- ▶ If, despite this, modifications are required, consult with the manufacturer.

### Repair

To ensure continued operational safety and reliability,

- ▶ Carry out repairs on the device only if they are expressly permitted.
- ▶ Observe federal/national regulations pertaining to repair of an electrical device.
- ▶ Use original spare parts and accessories from the manufacturer only.

### Hazardous area

To eliminate a danger for persons or for the facility when the device is used in the hazardous area (e.g. explosion protection, pressure vessel safety):

- ▶ Based on the nameplate, check whether the ordered device is permitted for the intended use in the hazardous area.
- ▶ Observe the specifications in the separate supplementary documentation that is an integral part of these Instructions.

## 2.8 Product safety

This measuring device is designed in accordance with good engineering practice to meet state-of-the-art safety requirements, has been tested, and left the factory in a condition in which it is safe to operate.

It meets general safety standards and legal requirements. It also complies with the EC directives listed in the device-specific EC Declaration of Conformity. Endress+Hauser confirms this by affixing the CE mark to the device.

## 3 Product description

### 3.1 Product design

#### 3.1.1 Components of the FMG60

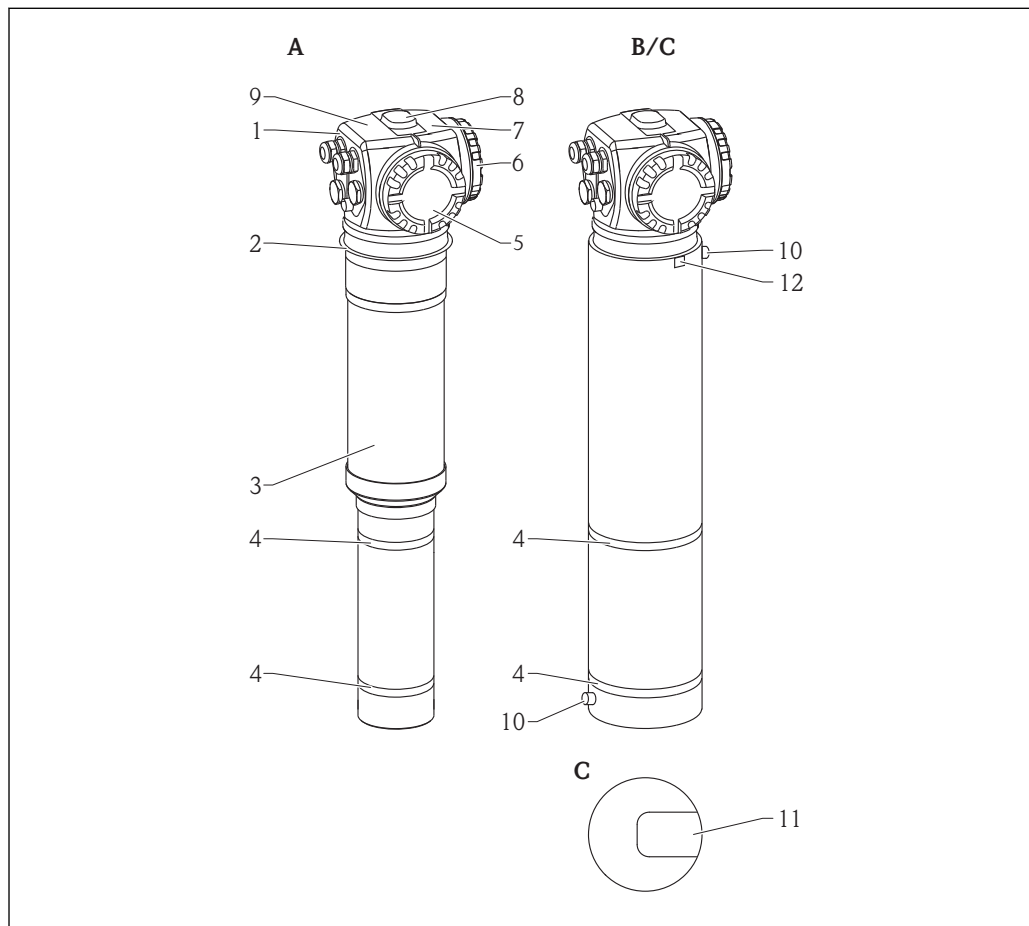

A0018069

1 A: Gammapiilot M without water cooling jacket; B: Gammapiilot M with water cooling jacket; C: Gammapiilot M with collimator

- 1 Terminal housing
- 2 Mounting collar
- 3 Detector pipe
- 4 Measuring range marks
- 5 Connection compartment 2
- 6 Connection compartment 1
- 7 Supplementary nameplate
- 8 Centering knob
- 9 Device nameplate
- 10 Cooling water connections
- 11 Marking of the radiation window (for versions with collimator)
- 12 Potential equalization terminal of the cooling jacket

### 3.2 Nameplates

#### 3.2.1 Device nameplate

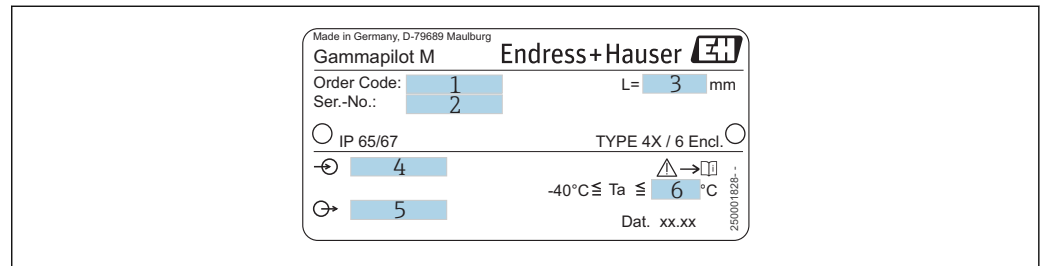

A0018070

- 1 Order code (see the product structure for the meaning of the code)
- 2 Serial number
- 3 Measuring range
- 4 Power supply
- 5 Output signal
- 6 Max. ambient temperature

#### 3.2.2 Supplementary nameplate (examples)

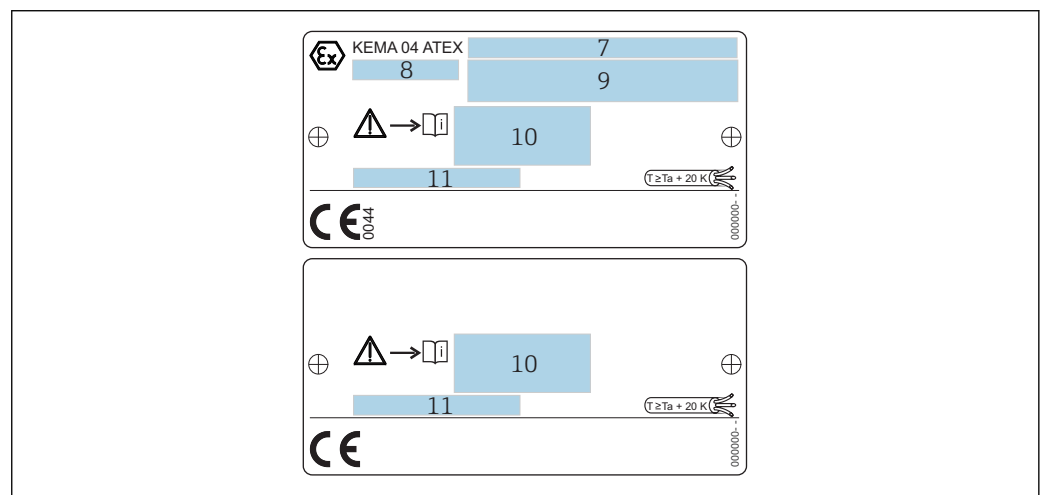

A0018071

- 7 Number of certificate
- 8 Equipment group and category
- 9 Type of protection
- 10 Reference to additional safety-related documentation
- 11 Reference to additional certificates (e.g. WHG, SIL)
- 12 Information on the required temperature resistance of the connecting cables (only for device versions with a water cooling jacket)

### 3.3 Scope of delivery

- Ordered version of the device (including Operating Instructions)
- Endress+Hauser operating program (on the CD-ROM supplied)
- Accessories as ordered

## 3.4 Accompanying documentation

### 3.4.1 Operating Instructions (BA00236F/00/EN)

The Operating Instructions describe how to install and commission the Gammapilot M (communication version 4-20 mA HART). All the functions of the operating menu that are necessary for standard measuring tasks are described here.

Any additional functions are contained in the "Description of Device Functions"



BA00287F/00/EN

### 3.4.2 Description of Device Functions (BA00287F/00/EN)

The Description of Device Functions document contains a detailed description of all the functions of the Gammapilot M and applies for all communication versions. This document is available as a PDF file on the CD-ROM supplied and can be downloaded from the Internet at "www.de.endress.com" (Download).

### 3.4.3 Safety instructions

Additional safety instructions (XA, ZE, ZD) are supplied with certified device versions. Please refer to the nameplate for the safety instructions that apply to your device version.

An overview of the certificates and approvals can be found in the "Certificates and approvals" section of



TI00363F/00/EN

## 3.5 Certificates and approvals

### CE mark, Declaration of Conformity

The device is designed to meet state-of-the-art safety requirements, has been tested, and left the factory in a condition in which it is safe to operate. The device takes into account the applicable standards and regulations which are listed in the EC Declaration of Conformity and thus meets the legal requirements of the EC directives. Endress+Hauser confirms the successful testing of the device by affixing to it the CE mark.

## 3.6 Registered trademarks

HART®

Registered trademark of the HART Communication Foundation, Austin, USA

ToF®

Registered trademark of Endress+Hauser SE+Co. KG, Maulburg, Germany



## 4 Mounting

### 4.1 Incoming acceptance, product identification, transport, storage

#### 4.1.1 Incoming acceptance

Check the packaging and contents for any signs of damage. Check the shipment, make sure nothing is missing and that the scope of supply matches your order.

#### 4.1.2 Product identification

The measuring device can be identified in the following ways:

- Using the nameplate specifications.
- Using the order code with a breakdown of the device features on the delivery note.
- By entering the serial number of the nameplates into *W@M Device Viewer*. ([www.endress.com/deviceviewer](http://www.endress.com/deviceviewer)): all the information about the measuring device is displayed.

For an overview of the scope of the Technical Documentation provided: Enter the serial number of the nameplates into *W@M Device Viewer*. ([www.endress.com/deviceviewer](http://www.endress.com/deviceviewer))

#### 4.1.3 Transport

##### **CAUTION**

##### Risk of injury

- ▶ Follow the safety instructions and transport conditions for devices weighing more than 18 kg (39.69 lb).

#### 4.1.4 Storage

Pack the device so that is protected against impact for storage and transport. The original packaging provides optimum protection. The permissible storage temperature is:

- -40 to +50 °C (-40 to +122 °F) for devices with PVT scintillator
- -40 to +60 °C (-40 to +140 °F) for devices with NaI crystal

## 4.2 Installation conditions

### 4.2.1 Dimensions, weight

Gammapilot M (without water cooling jacket)

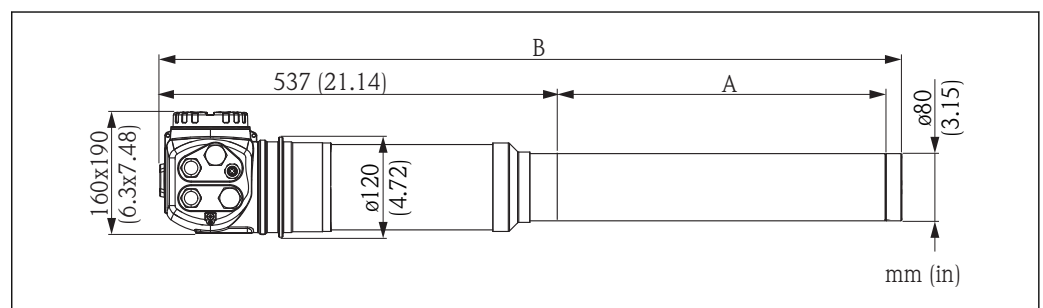

A0018072

### Gammapiilot M with water cooling jacket or collimator

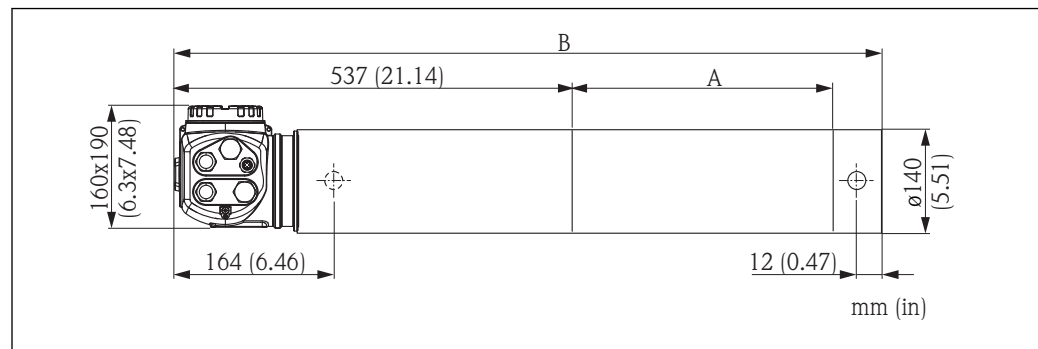

A0018073

Type	Measuring length A [mm (in)]	Without water cooling jacket		With water cooling jacket		
		Total length B [mm (in)]	Weight [kg (lbs)] <sup>1)</sup>	Total length B [mm (in)]	Weight without water [kg (lbs)] <sup>1)</sup>	Weight with water [kg (lbs)] <sup>1)</sup>
NaI	50 (1.97)	621 (24.4)	14 (30.87)	631 (24.8)	18 (39.69)	20 (44.10)
NaI with collimator	50 (1.97)	663 (26.1)	35 (77.18)	-	-	-
PVT	200 (7.87)	780 (30.7)	15 (33.08)	790 (31.1)	20 (44.10)	24 (52.92)
PVT	400 (15.7)	980 (38.6)	16 (35.28)	990 (39)	23 (50.72)	29 (63.95)
PVT	800 (31.5)	1380 (54.3)	20 (44.10)	1390 (54.7)	31 (68.36)	40 (88.20)
PVT	1200 (47.5)	1780 (70.1)	24 (52.92)	1790 (70.5)	37 (81.59)	50 (110.25)
PVT	1600 (63)	2180 (85.8)	28 (61.74)	2190 (86.2)	45 (99.23)	61 (134.51)
PVT	2000 (78.7)	2580 (102)	31 (68.36)	2590 (102)	51 (112.46)	72 (158.76)

1) The weight data indicated are for the 316L version. The weight of the aluminum version is reduced by 5.3 kg (11.69 lb)

## 4.2.2 Installation conditions for level measurement

### Conditions

- For level measurements the Gammapiilot M is mounted vertically; if possible the detector head should point downwards
- The angle of emission of the source container must be exactly aligned to the measuring range of the Gammapiilot M. Observe the measuring range marks of the Gammapiilot M.
- If several Gammapiilot M devices are connected in cascade mode, there should not be any gap between the individual measuring ranges.
- The source container and the Gammapiilot M should be mounted as close to the vessel as possible. Any access to the beam must be blocked to ensure that it is not possible to reach into this area.
- The Gammapiilot M should be protected against direct sunlight in order to increase its service life. Use a protective cover if necessary.
- The mounting device FHG60 or an equivalent mounting device should be used to secure the Gammapiilot M → 78  
The mounting device must be installed in such a way as to withstand the weight of the Gammapiilot M under all anticipated operating conditions (e.g. vibrations). → 18

The Gammapiilot M should be given additional support to prevent damage to the connecting cable or to the unit if it falls.

## Examples

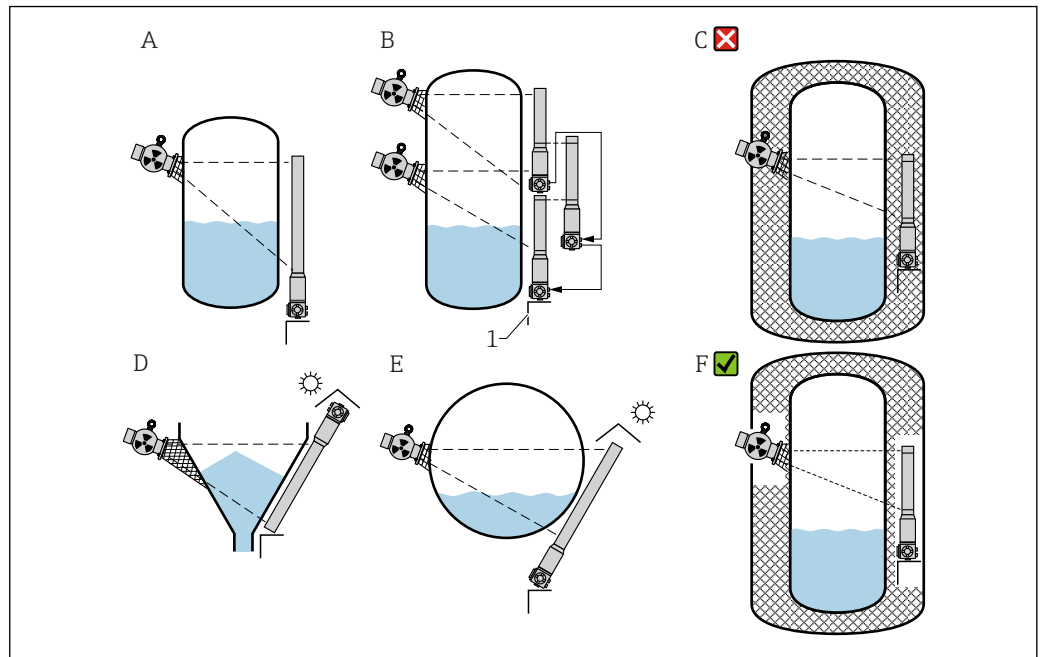

A0018074

- A Vertical cylinder; the Gammapilot M is mounted vertically with the detector head pointing downwards, the gamma ray is aligned to the measuring range.
- B Cascading of multiple Gammapilot M devices; there is no gap between the measuring ranges
- C Incorrect: Gammapilot M mounted inside the tank insulation
- D Conical vessel outlet (here with sun protection cover)
- E Horizontal cylinder (here with sun protection cover)
- F Correct: tank insulation removed for Gammapilot M
- 1 Support

### 4.2.3 Installation conditions for point level detection

#### Conditions

- For point level detection, the Gammapilot M is generally mounted horizontally at the height of the desired level limit.
- The angle of emission of the source container must be exactly aligned to the measuring range of the Gammapilot M. Observe the measuring range marks of the Gammapilot M.
- The source container and the Gammapilot M should be mounted as close to the vessel as possible. Any access to the beam must be blocked to ensure that it is not possible to reach into this area.
- The Gammapilot M should be protected against direct sunlight in order to increase its service life. Use a protective cover if necessary.
- The mounting device FHG60 or an equivalent mounting device should be used to secure the Gammapilot M → 78  
The mounting device must be installed in such a way as to withstand the weight of the Gammapilot M under all anticipated operating conditions (e.g. vibrations). → 18

**i** More information with regard to the safety-related use of the Gammapilot M can be found in the Functional Safety Manual SD00230F/00/EN and SD00324F/00/EN.

## Examples

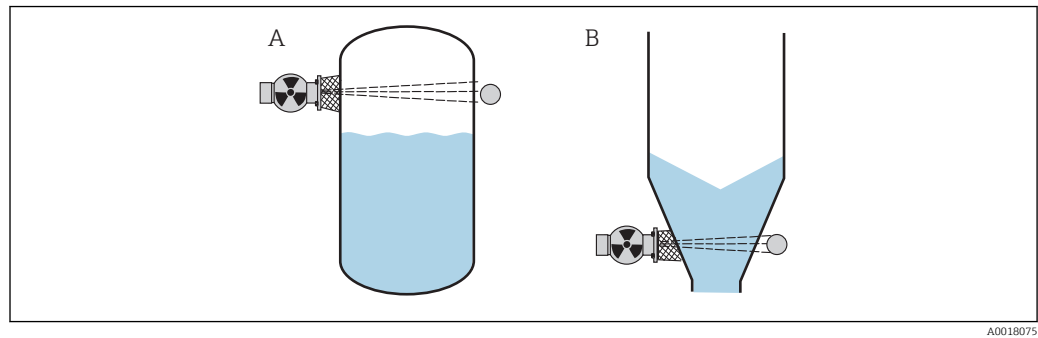

A Maximum fail-safe mode  
B Minimum point level detection

A0018075

### 4.2.4 Installation conditions for density and concentration measurements

#### Density and concentration measurement

##### Conditions

- If possible, density and concentration should be measured on vertical pipes with forward flow from bottom to top.
- If only horizontal pipes are accessible, the path of the beam should also be arranged horizontally to minimize the influence of air bubbles and deposits.
- The Endress+Hauser clamping device FHG61 or an equivalent clamping device should be used to fasten the radiation source container and the Gammapilot M to the measuring tube. → 80  
The clamping device itself must be installed in such a way as to withstand the weight of the source container and the Gammapilot M under all anticipated operating conditions. → 18
- The sample point may not be further than 20 m (66 ft) from the measuring point.
- The distance of the density measurement to pipe bends is  $\geq 3 \times$  pipe diameter, and  $\geq 10 \times$  pipe diameter in the case of pumps.

##### Measuring system arrangement

The arrangement of the source container and the Gammapilot M depends on the pipe diameter (or the length of the irradiated measuring path) and the density measuring range. These two parameters determine the measuring effect (relative change in the pulse rate). The measuring effect increases with the length of the radiation path through the medium. Therefore, it is advisable to use diagonal irradiation or a measurement section for small pipe diameters.

To select the measuring system arrangement please contact your Endress+Hauser sales organization or use the Applicator™ configuration software <sup>1)</sup>

1) The Applicator™ is available from your Endress+Hauser sales organization.

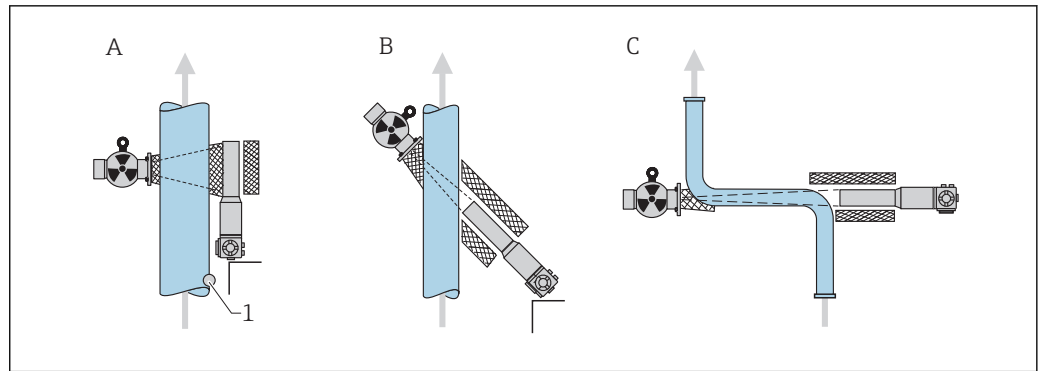

A Vertical beam (90°)  
 B Diagonal beam (30°)  
 C Measurement section  
 1 Sample point

- i
 To increase the accuracy of density measurements, the use of a collimator is recommended. The collimator screens the detector against environmental radiation.
- When planning, the total weight of the measuring system must be taken into consideration.
- The Gammapilot M should be given additional support to secure it against falling or to prevent damage to the connecting cable.
- A clamping device (FHG61) and a measurement section (FHG62) are available as accessories → 80

### Interface measurement

The measuring principle is based on the fact that the radioactive isotope (emitter) emits radiation which is attenuated when it penetrates a material and the medium to be measured. In radiometric interface measurement, the source is inserted into a closed immersion pipe via a rope extension, thus preventing any contact between the source and the medium.

Depending on the measuring range and the application, one or several detectors are mounted on the outside of the vessel. The average density of the medium between the radiation source and the detector is calculated from the radiation received. A direct correlation to the interface can then be derived from this density value.

### For more information, see:

CP01205F/00/EN

### Density profile measurement (DPS)

To obtain detailed information on the distribution of layers of different densities in a vessel, a density profile is measured using a multi-detector solution. Several compact transmitters are installed next to one another on the outside of the vessel wall for this purpose. The measuring range is divided into zones and each compact transmitter measures the density value in its respective zone. A density profile is derived from these values.

This results in a high-resolution measurement of the distribution of medium layers (e.g. in separators)

### For more information, see:

CP01205F/00/EN

### 4.2.5 Empty pipe detection

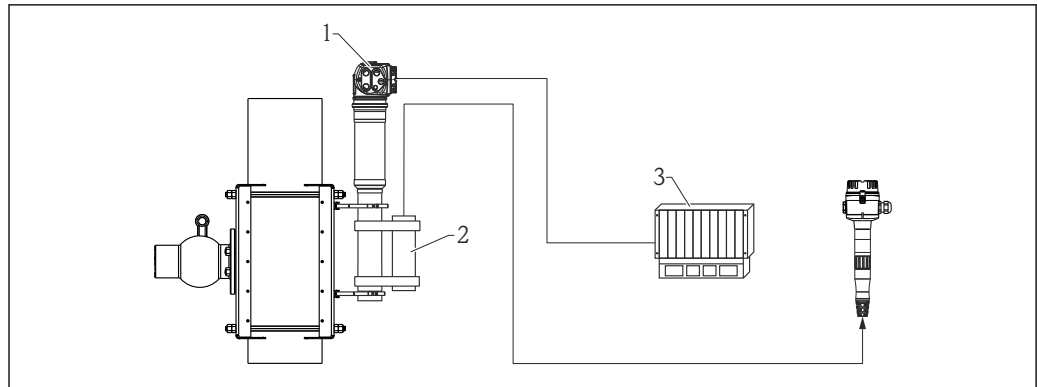

- 1 Gammapilot M
- 2 Monitoring detector FTG20 or FMG60
- 3 PLC

#### Mounting the FTG20 or FMG60 on the FMG60 for empty pipe detection

If the pipe becomes empty as a result of operational processes, the level of radiation on the detector side can reach dangerous levels.

- In such cases, the radiation emission channel must be closed immediately for reasons of radiation protection.
- A high local dose rate also causes the detector unit (scintillator and photomultiplier) to age quickly.

The best way to avoid such a situation is to mount a second radiometric measuring system that monitors the radiation intensity. If high radiation levels occur, an alarm is output and/or the source container is automatically switched off through pneumatic action for example.

### 4.2.6 Installation conditions for flow measurement

#### Measurement of solids flow

In conjunction with a density measuring device, such as Endress+Hauser's Gammapilot M, Promag 55S also determines the rate of solids in terms of mass, volume or percentage. The following order information is required for this purpose for Promag 55S: Order option for the "Solids flow" software option (F-CHIP) and order option for a current input.

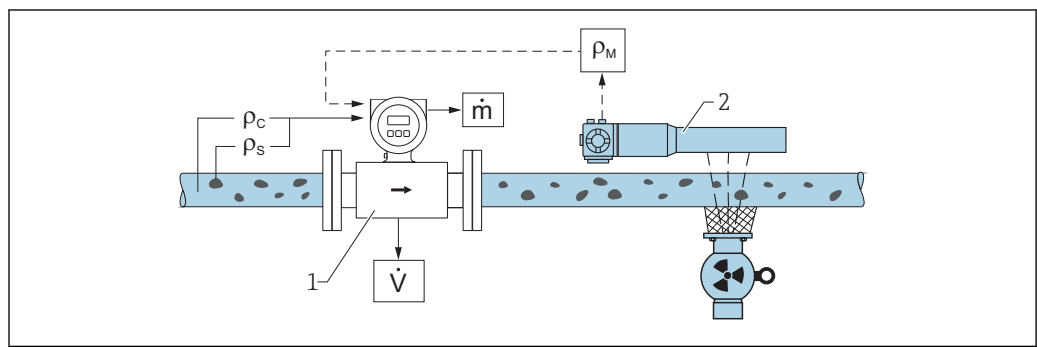

- 2 Solids flow measurement (m) using a density meter and flowmeter. If the density of the solids ( $\rho_s$ ) and the density of the carrier liquid ( $\rho_c$ ) are also known, the solids flow rate can be calculated.

- 1 Flowmeter (Promag 55S) -> volume flow (V). The solids density ( $\rho_s$ ) and the density of the carrier liquid ( $\rho_c$ ) also have to be entered in the transmitter
- 2 Density meter (e.g. "Gammapilot M") -> total density ( $\rho_m$ ) consisting of the carrier liquid and solids

### Measurement of mass flow

Bulk solids applications on conveyor belts and conveyor screws.

The source container is positioned above the conveyor belt and the Gammapilot M FMG60 below the conveyor belt. The radiation is attenuated by the medium on the conveyor belt. The intensity of the radiation received is proportional to the density of the medium. The mass flow is calculated from the belt speed and the radiation intensity.

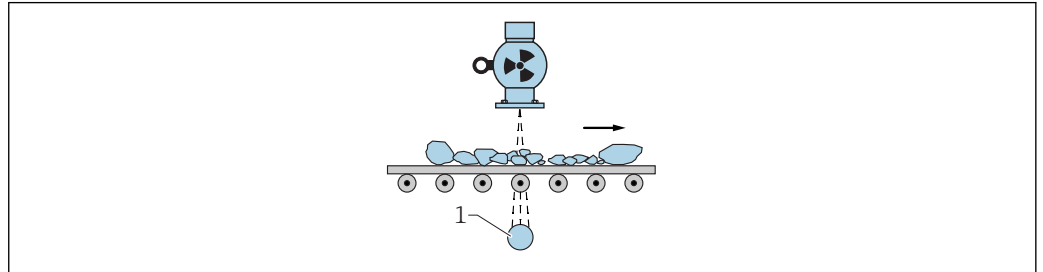

1 Gammapilot M

## 4.3 Water cooling

The following applies for the versions of the Gammapilot M with a water cooling jacket:

- Material: 316L
- Water connection: 2 x G 1/4", DIN ISO 228
- Inlet temperature: max. 40 °C (104 °F)
- Outlet temperature: max. 50 °C (122 °F) (temperature monitoring recommended)
- Water pressure: 4 to 6 bar (60 to 90 psi)

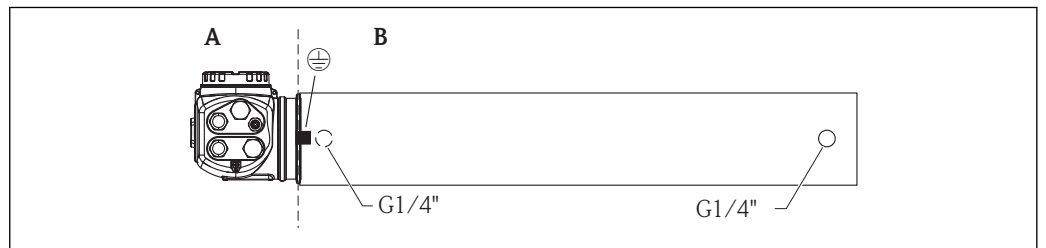

- A  $T < 75\text{ °C}$  (167 °F)  
 B  $T < 120\text{ °C}$  (248 °F)

#### ⚠ CAUTION

The detector or cooling jacket can become damaged if the cooling water freezes.

- ▶ Empty the cooling jacket or protect against freezing.

#### ⚠ WARNING

**Pressurized water cooling system!**

- ▶ Do not open the cylinder screws (see diagram below) when pressurized.

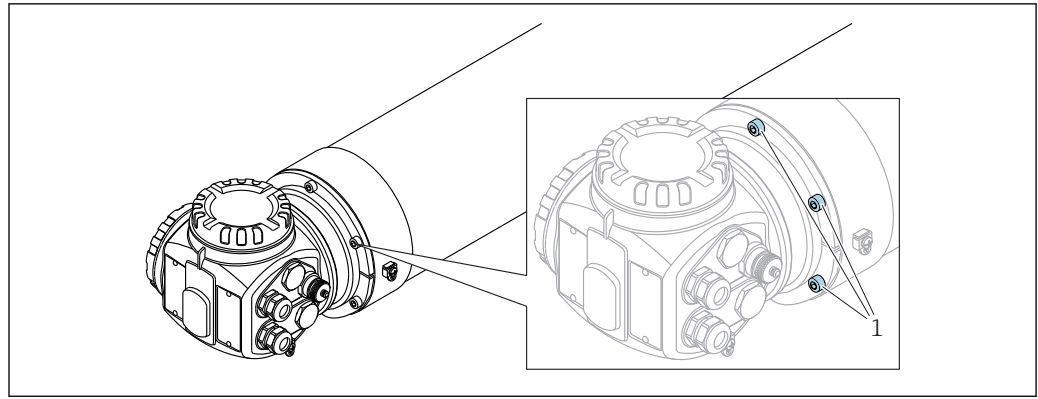

A0023205

1 Cylinder screws

**CAUTION**

**Consider the following when using the water cooling jacket**

- ▶ It is recommended to ground the water cooling jacket separately at the protective ground connection provided for this purpose.
- ▶ The ambient temperature of the terminal housing may not exceed 75 °C (167 °F). This also applies if water cooling is used.
- ▶ The three screws (see graphic below) connecting the detector pipe to the terminal housing may **not** be opened.

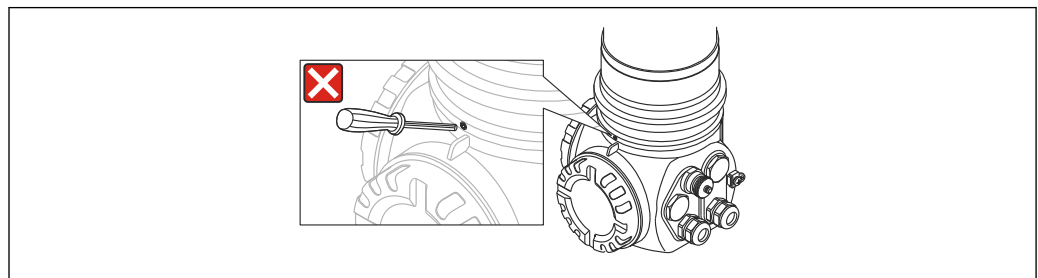

A0018068

3 The three screws connecting the detector pipe to the terminal housing may not be opened.

**4.3.1 Mounting position and position of the cooling water nozzles**

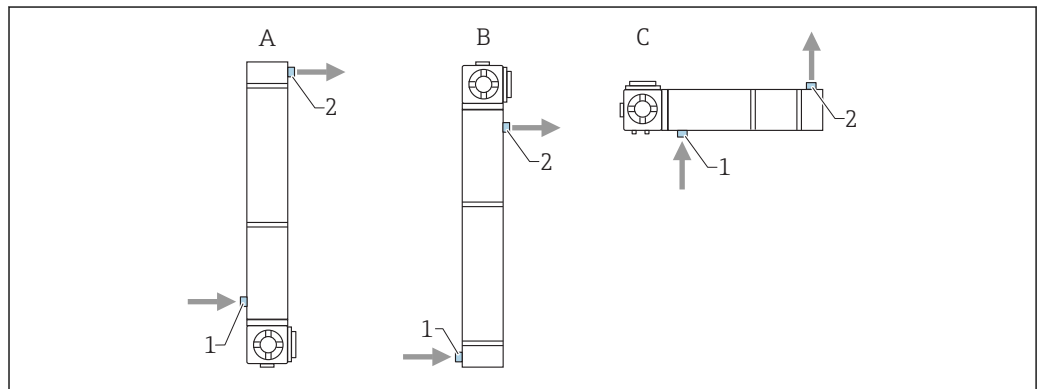

A0018079

- A Recommended mounting position for level measurement: the terminal housing is at the bottom
- B In exceptional cases (e.g. shortage of space) the terminal housing may be located at the top
- C Mounting position for point level detection and density measurement
- 1 Cooling water inlet (always at bottom)
- 2 Cooling water outlet (always at top)



**⚠ CAUTION**

- ▶ The water must always be introduced from the bottom to ensure that the water cooling jacket is completely filled.

**4.3.2 Required flow**

The required flow rate depends on:

- The ambient temperature at the water cooling jacket
- The inlet temperature
- The measuring length of the Gammapilot M

Typical values are given in the following tables:

**Ambient temperature  $T_A = 75\text{ °C}$  (167 °F)**

Inlet temperature °C (°F)	Measuring length in mm (in)						
	50 (1.97)	200 (7.87)	400 (15.7)	800 (31.5)	1200 (47.2)	1600 (63)	2000 (78.7)
20 (68)	30 l/h	30 l/h	30 l/h	41 l/h	55 l/h	70 l/h	84 l/h
25 (77)	30 l/h	30 l/h	30 l/h	45 l/h	61 l/h	77 l/h	93 l/h
30 (86)	30 l/h	30 l/h	33 l/h	50 l/h	68 l/h	86 l/h	104 l/h
35 (95)	30 l/h	30 l/h	38 l/h	59 l/h	80 l/h	101 l/h	122 l/h
40 (104)	30 l/h	30 l/h	47 l/h	72 l/h	98 l/h	124 l/h	149 l/h

**Ambient temperature  $T_A = 100\text{ °C}$  (212 °F)**

Inlet temperature °C (°F)	Measuring length in mm (in)						
	50 (1.97)	200 (7.87)	400 (15.7)	800 (31.5)	1200 (47.2)	1600 (63)	2000 (78.7)
20 (68)	30 l/h	30 l/h	38 l/h	59 l/h	80 l/h	101 l/h	122 l/h
25 (77)	30 l/h	30 l/h	42 l/h	64 l/h	87 l/h	110 l/h	133 l/h
30 (86)	30 l/h	30 l/h	47 l/h	73 l/h	98 l/h	124 l/h	150 l/h
35 (95)	30 l/h	30 l/h	54 l/h	84 l/h	113 l/h	143 l/h	173 l/h
40 (104)	33 l/h	33 l/h	66 l/h	101 l/h	137 l/h	173 l/h	210 l/h

**Ambient temperature  $T_A = 120\text{ °C}$  (248 °F)**

Inlet temperature °C (°F)	Measuring length in mm (in)						
	50 (1.97)	200 (7.87)	400 (15.7)	800 (31.5)	1200 (47.2)	1600 (63)	2000 (78.7)
20 (68)	30 l/h	30 l/h	45 l/h	70 l/h	94 l/h	119 l/h	144 l/h
25 (77)	30 l/h	30 l/h	50 l/h	77 l/h	104 l/h	131 l/h	158 l/h
30 (86)	30 l/h	30 l/h	55 l/h	85 l/h	115 l/h	146 l/h	176 l/h
35 (95)	32 l/h	32 l/h	64 l/h	98 l/h	133 l/h	168 l/h	203 l/h
40 (104)	38 l/h	38 l/h	75 l/h	116 l/h	157 l/h	199 l/h	240 l/h

**4.4 Post-installation check**

After installing the measuring device, carry out the following checks:

- Is the device damaged (visual inspection)?
- Does the device match the measuring point specifications (ambient temperature, measuring range etc.)?
- If available: are the measuring point number and labeling correct (visual inspection)?
- Is the measuring device sufficiently protected against sunlight?
- Are the cable glands tightened correctly?

## 5 Wiring

### 5.1 Connection compartments

The Gammapilot M has two connection compartments

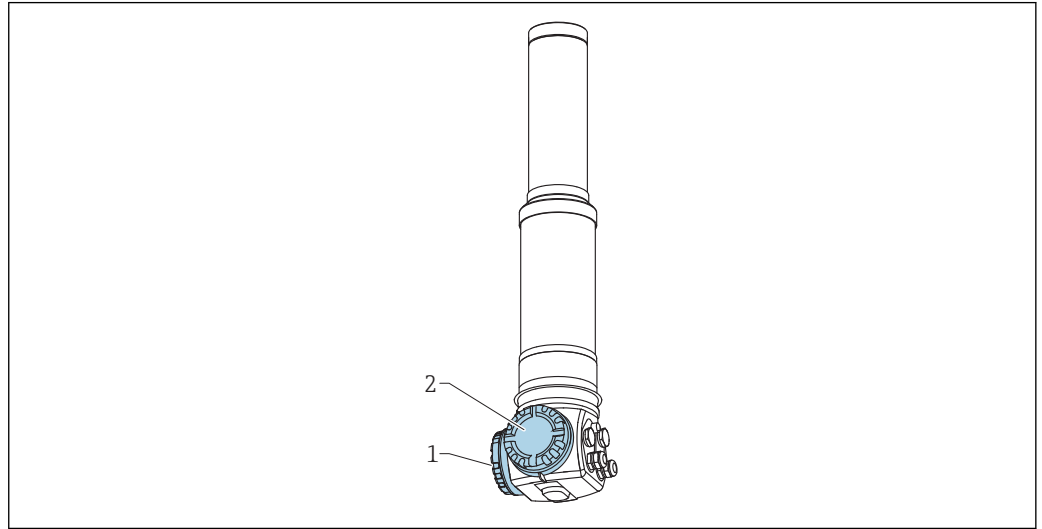

A0018082

- 1 Connection compartment 1  
2 Connection compartment 2

#### Connection compartment 1

Connection compartment for:

- Power supply
- Signal output (depending on the device version)

#### Connection compartment 2

Connection compartment for:

- Signal output (depending on the device version)
- Pt-100 input (4-wire)
- Pulse input for cascade mode
- Pulse output for cascade mode
- Display and operating module FHX40 (or VU331)

 Depending on the device version, the signal output is located in connection compartment 1 or 2.

Maximum cable length:

- For cascade, 20 m (66 ft) per device
- For Pt-100 2 m (6.6 ft). Temperature measurement should be performed as close as possible to density measurement.

### 5.2 Cable entries

The number and type of cable entries depend on the device version ordered. The following are possible:

- Coupling M20x1.5, sealing range 7 to 10.5 mm (0.28 to 0.41 in)
- Cable entry M20x1.5
- Cable entry G1/2

- Cable entry NPT1/2
- M12 connector (see "Fieldbus connectors")
- 7/8" connector (see "Fieldbus connectors")

In addition, the Gammapilot M also has a socket to connect the separate display and operating unit FHX40. The housing of the Gammapilot M does not have to be opened to connect the FHX40.

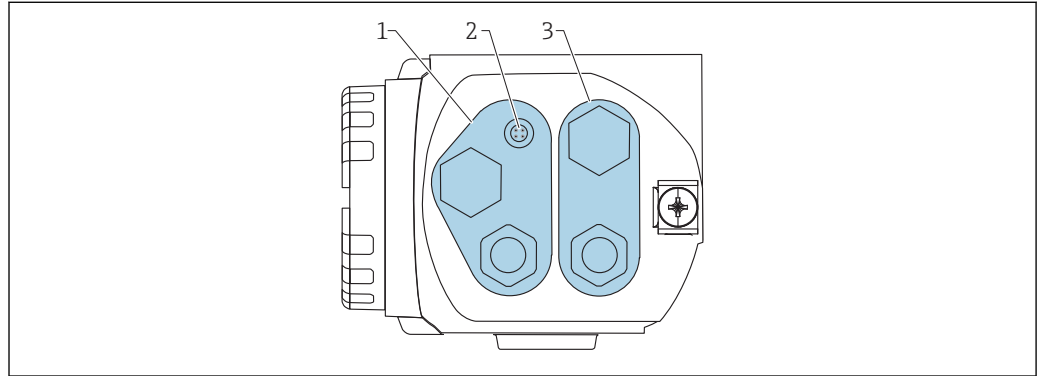

A0018083

- 1 Cable entry for connection compartment 2
- 2 Socket for FHX40
- 3 Cable entry for connection compartment 1

**i** Cable entries

- A maximum of one cable gland is provided for each of the connection compartments upon delivery. If additional cable glands are required (e.g. for cascade mode), they must be supplied by the user.
- Connecting cables should be routed away from the housing from below to prevent moisture from penetrating the connection compartment. Otherwise, a drip loop should be provided or the Gammapilot M should be fitted with a weather protection cover.

### 5.3 Terminal assignment

#### Connection compartment 1

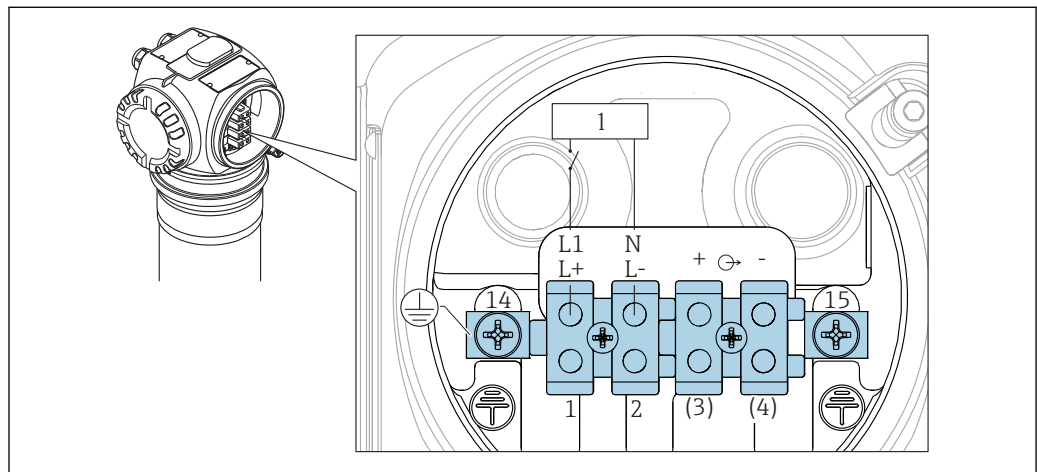

A0018084

**4** For the terminal assignment, see the table below

1 Power supply: 90 to 253VAC, 18 to 35 VDC

#### Connection compartment 2

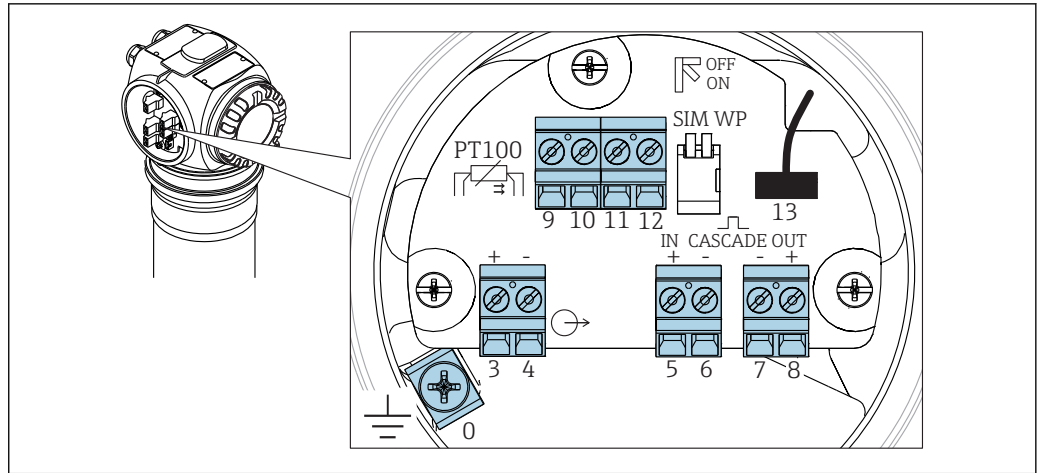

5 For the terminal assignment, see the table below

Terminal	Meaning
0	Grounding of the cable shield <sup>1)</sup>
1, 2	Power supply <sup>2)</sup>
<b>Connection compartment 2:</b> 3, 4 <b>Connection compartment 1:</b> 3 <sup>1)</sup> , 4 <sup>1)</sup>	Signal output, depending on communication version: <ul style="list-style-type: none"> <li>■ 4-20mA with HART</li> <li>■ PROFIBUS PA</li> <li>■ FOUNDATION Fieldbus</li> </ul> Depending on the device version ordered, the signal output is located in connection compartment 1 or 2 (see below). ⓘ For the versions of the Gammapilot M with a fieldbus connector (M12 or 7/8"), the signal output is wired in connection compartment 2 on delivery and connected to the fieldbus connector (see the "Fieldbus connectors" section). In this case, the housing does not need to be opened to connect the signal cable.
5, 6	Pulse input (for cascade mode; is used for master and slave)
7, 8	Pulse output (for cascade mode; is used for slave and end slave)
9, 10, 11, 12	Pt-100 input (4-wire)
13	Connection for display and operating module VU331 (from FHX40); is wired on delivery and connected to the FHX40 plug.
14	Protective ground <sup>1)</sup>
15	Protective ground or grounding of the cable shield <sup>1)</sup>

1) Rated cross-section > 1 mm<sup>2</sup> (17 AWG)

2) Rated cross-section max. 2.5 mm<sup>2</sup> (14 AWG)

ⓘ The cables used at terminals 14 and 15 must at least have the same cross-section as the cables at terminals 1 and 2.

Feature 30 of the ordering information: power supply wiring/output wiring		Connection compartment with terminals for	
		Supply voltage	Signal output
A	Non-Ex; non-Ex	1	2
B	Ex e; Ex ia	1	2
C	Ex e; Ex e	1	1
D	Ex d (XP); Ex d (XP)	1	1
E	Ex d (XP); Ex ia (IS)	1	2
F	Dust-Ex; Dust-Ex	1	1
G	Ex e, Dust-Ex; Ex e, Dust-Ex	1	1
H	Ex d, Dust-Ex; Ex d, Dust-Ex	1	1
J	Ex e, Dust-Ex; Ex ia, Dust-Ex	1	2
K	Ex d, Dust-Ex; Ex ia, Dust-Ex	1	2
L	Dust-Ex; Ex ia	1	2

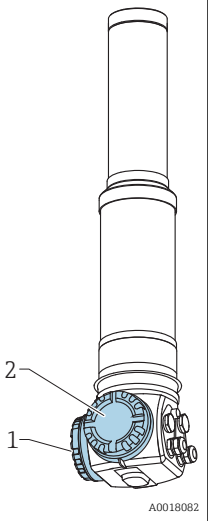

A0018082

## 5.4 Fieldbus connectors

For the versions with a fieldbus connector M12 or 7/8", the housing does not need to be opened to connect the signal cable.

### 5.4.1 Pin assignment for connector M12

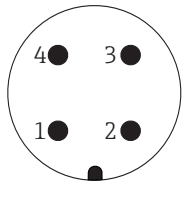
	PIN	Meaning
	1	Signal +
	2	Not assigned
	3	Signal -
	4	Ground

A0011175

### 5.4.2 Pin assignment for connector 7/8"

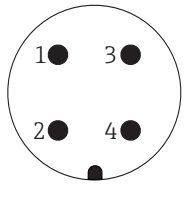
	PIN	Meaning
	1	Signal -
	2	Signal +
	3	Shielding
	4	Not assigned

A0011176

## 5.5 Potential equalization

**Before wiring**, connect the potential matching line to the external ground terminal of the transmitter. If a water cooling jacket is provided, it must be connected separately to the potential matching line.

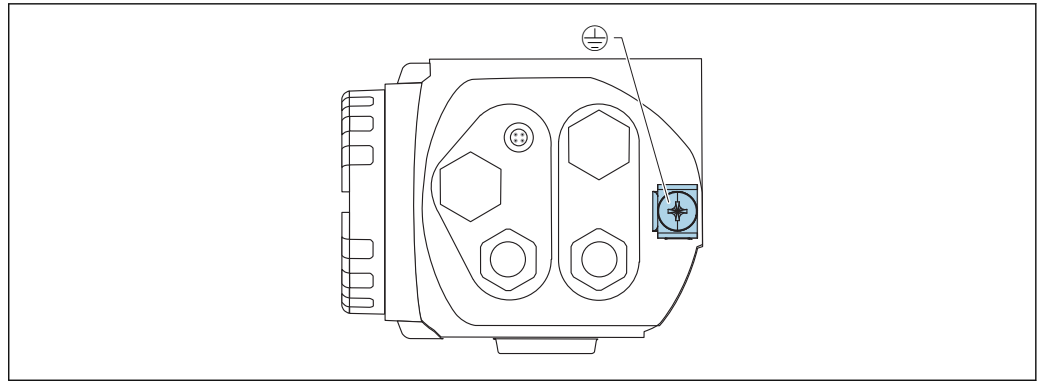

A0018086

6 Ground terminal for connecting the potential matching line

### ⚠ CAUTION

**In Ex applications, the device may only be grounded on the sensor side**

- ▶ Please refer to the separate documentation on applications in hazardous areas for further safety instructions.

- i** For optimum electromagnetic compatibility, the potential matching line should be as short as possible and at least 2.5 mm<sup>2</sup> (14 AWG) in cross-section.

## 5.6 Wiring in connection compartment 1

### ⚠ CAUTION

**Note the following before connecting:**

- ▶ If the device is used in hazardous areas, make sure to comply with national standards and the specifications in the Safety Instructions (XAs). The specified cable gland must be used.
- ▶ The supply voltage must match the specifications on the nameplate
- ▶ Switch off the supply voltage before connecting the device.
- ▶ Connect the potential matching line to the external ground terminal of the transmitter and to the ground terminal of the water cooling jacket (if present) before connecting the device. → 30
- ▶ Connect the protective ground to the protective ground terminal → 28
- ▶ According to IEC/EN 61010 a suitable circuit breaker must be provided for the device
- ▶ The cables must be adequately insulated, with due consideration given to the supply voltage and the overvoltage category.
- ▶ The connecting cables must offer adequate temperature stability, with due consideration given to the ambient temperature.

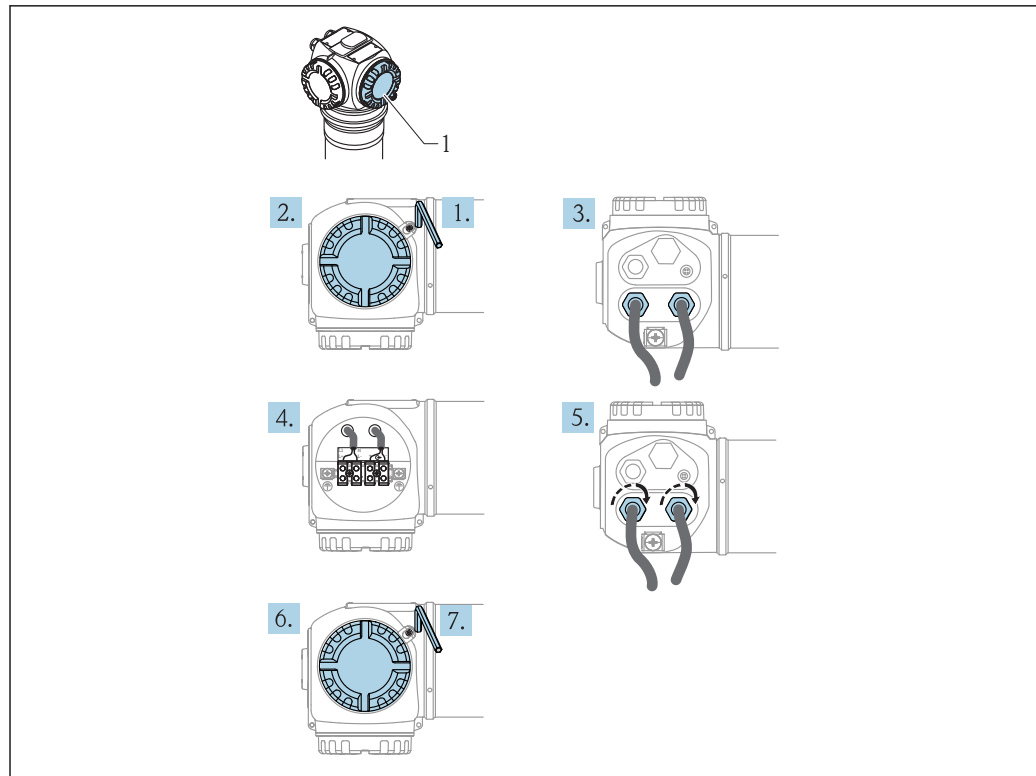

A0019826

1. Using a 3 mm Allen key, loosen the cover clamp for the connection compartment cover
2. Unscrew the cover
3. Push the power cable and (if required) the signal cable through the appropriate cable glands or cable entries
4. Wire up according to the terminal assignment diagram
5. Tighten the cable glands or cable entries so that they are leak-tight
6. Screw the cover securely back onto the connection compartment
7. Turn the cover clamp so that it is set over the cover and then tighten.

## 5.7 Wiring in connection compartment 2

### **⚠ CAUTION**

**Note the following before connecting:**

- ▶ Connect the potential matching line to the external ground terminal of the transmitter and to the ground terminal of the water cooling jacket (if present) before connecting the device. → 30
- ▶ The cables must be adequately insulated, with due consideration given to the supply voltage and the overvoltage category.
- ▶ The connecting cables must offer adequate temperature stability, with due consideration given to the ambient temperature.



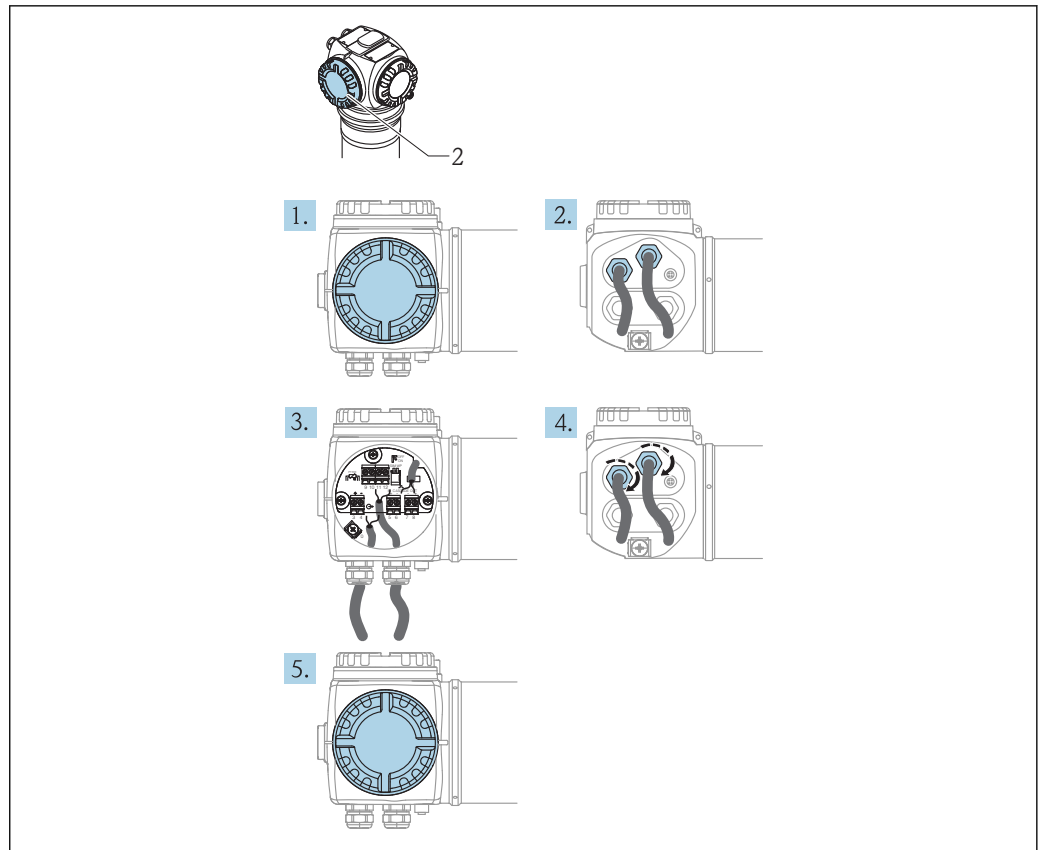

A0019827

1. Unscrew the cover
2. Push the following cables through the corresponding cable glands or cable entries: signal cable (if the signal output is located in connection compartment 2), Pt100 cable (if present), cascading cable (input and/or output, if required)
3. Wire up according to the terminal assignment diagram
4. Tighten the cable glands or cable entries so that they are leak-tight
5. Screw the cover securely back onto the connection compartment

## 5.8 Connecting the remote display and operating unit FHX40

The remote display and operating unit FHX40 is available as an accessory. It is connected to the FHX40 connector of the Gammapilot M via the cable supplied. The housing of the Gammapilot M does not have to be opened for this.

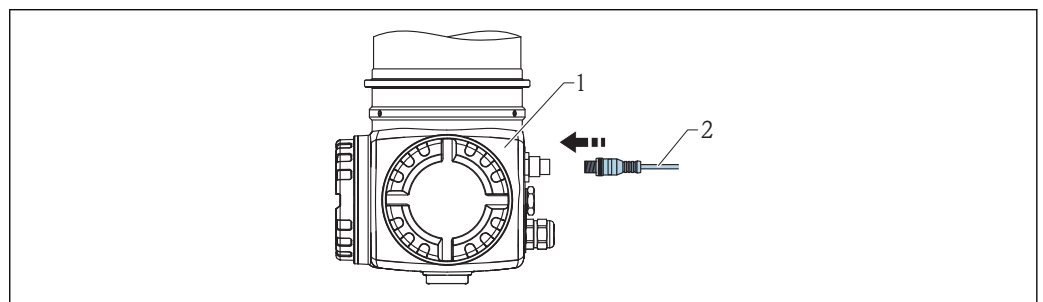

A0018089

- 1 Gammapilot M FMG60
- 2 Cable of the display and operating unit FHX40

For some Dust-Ex versions of the Gammapilot M, the FHX40 connector is protected by a metal sleeve:

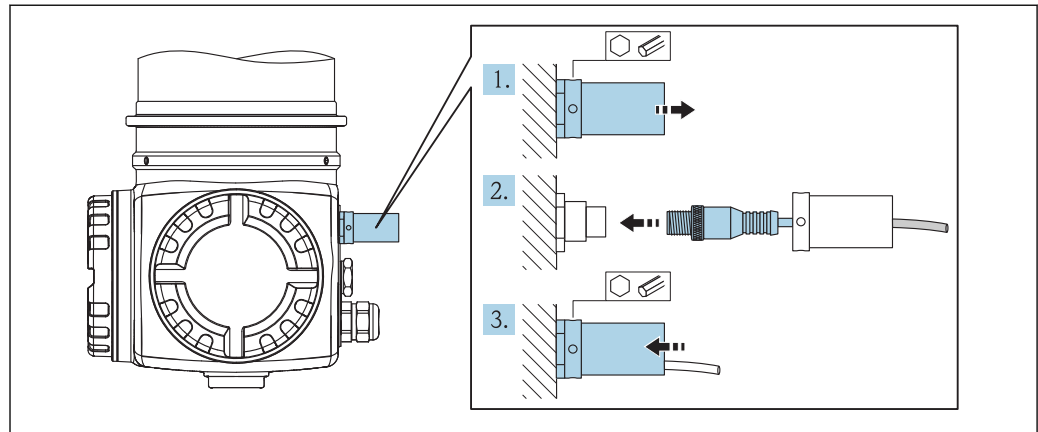

A0018090

1. Loosen the sleeve with an Allen key and remove it
2. Connect the display and operating unit FHX40
3. Attach the sleeve and fasten the Allen screw

### 5.9 Wiring for cascade mode

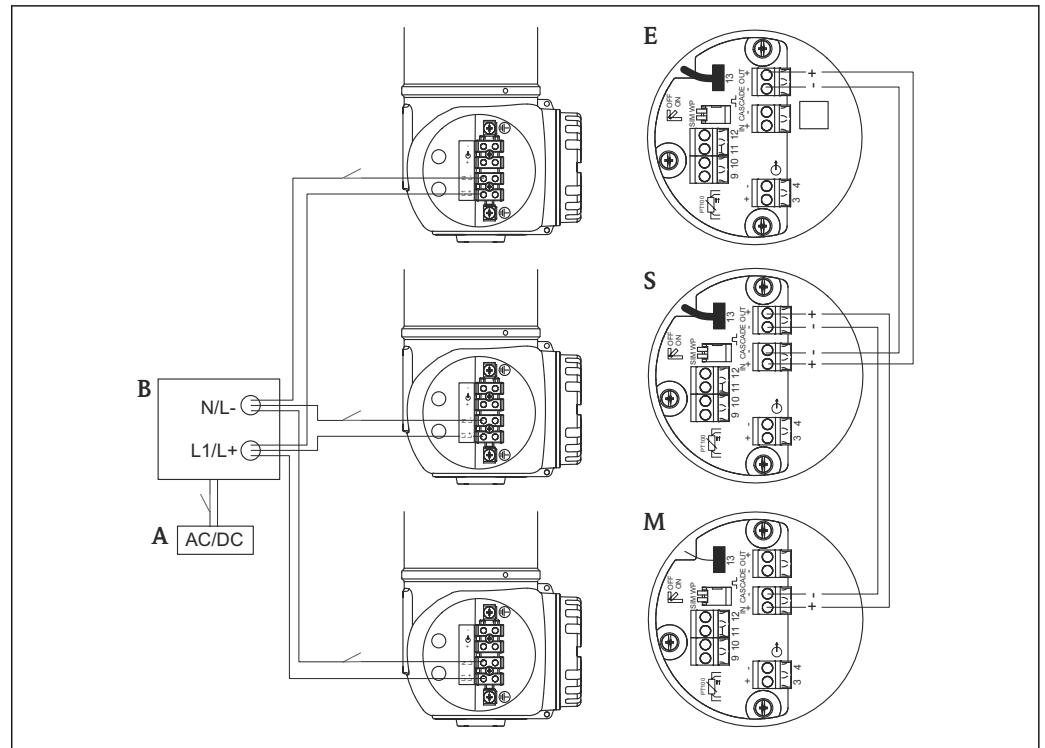

A0018091

- A Power supply (90 to 253VAC or 18 to 35VDC)
- B Junction box
- M Master
- S Slave
- E End slave

- i** There are two options for attaching the circuit breaker as per IEC/EN 61010:
  - **Upstream** of the junction box i.e. on the power supply side (one switch for all transmitters)
  - **Downstream** of the junction box i.e. on the transmitter side (an individual switch for every transmitter)

**⚠ WARNING**

- ▶ For applications in hazardous areas it is not permitted to interconnect the HART signal circuits for Multidrop operation.

### 5.10 Wiring example for point level detection 200/400 mm

The output signal is linear between the free and covered calibration (e.g. 4 to 20 mA) and can be evaluated in the control system. If a relay output is needed, the following Endress +Hauser process transmitters can be used:

- RTA421: for non-Ex applications, without WHG (German Water Resources Act), without SIL
- RMA42: for Ex-applications; with SIL certificates

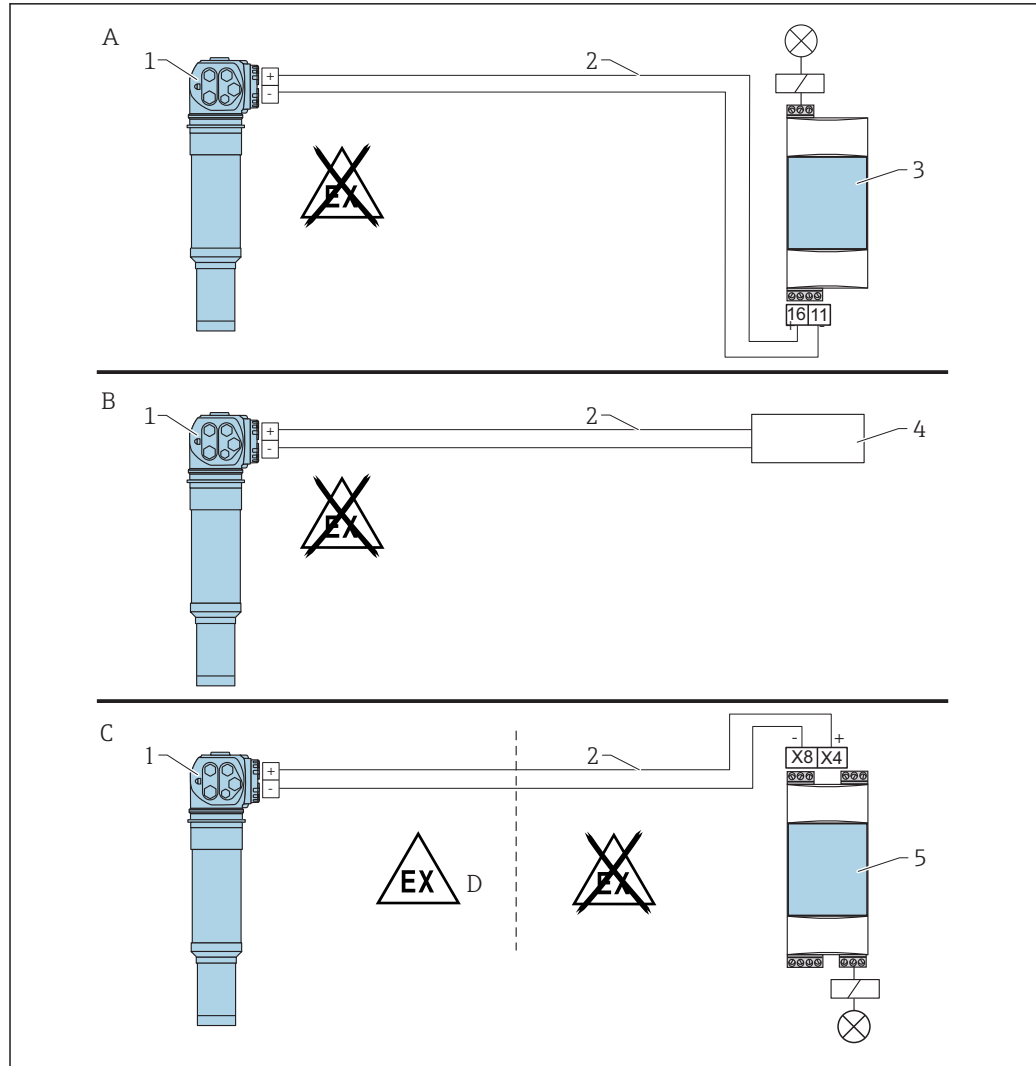

A0018092

- A Wiring with RTA421 switching unit  
 B Wiring with process control system  
 C Wiring with RMA42 switching unit  
 D When installing in hazardous areas, please observe the corresponding Safety Instructions  
 1 Gammapilot M  
 2 4 to 20 mA  
 3 RTA421  
 4 PLC  
 5 RMA42

### 5.10.1 Ex applications in conjunction with RMA42

Observe the following Safety Instructions:

- XA00303F/00/A3: ATEX II 2 (1) G for Gammapilot M
- XA00304F/00/A3: ATEX II 2 (1) D for Gammapilot M
- XA00095R/09/A3: ATEX II (1) G [Ex ia] IIC, ATEX II (1) D [Ex ia] IIIC for RMA42

### 5.10.2 SIL applications for Gammapilot M FMG60 in conjunction with RMA42 (for point level detection 200/400 mm PVT scintillator)

- The Gammapilot M meets SIL2/3 as per IEC 61508, see:
  - Functional Safety Manual SD00230F/00/EN (maximum point level detection)
  - Functional Safety Manual SD00324F/00/EN (minimum point level detection)
- The RMA42 meets SIL2 as per IEC 61508:2010 (Edition 2.0), see the Functional Safety Manual SD00025R/09/EN

## 5.11 Post-connection check

After wiring the device, carry out the following checks:

- Is the protective ground connected?
- Is the potential matching line connected?
- Is the terminal assignment correct?
- Are the cable glands and dummy plugs tight?
- Are the fieldbus connectors and the FHX40 connector fixed securely?
- Are the covers screwed tightly onto the connection compartments?
- For Dust-Ex devices: is the protective sleeve for the FHX40 socket mounted correctly?
- Is the cover of connection compartment 1 secured by the cover clamp?

#### **WARNING**

- ▶ The Gammapilot M may only be operated if the cover of connection compartment 1 is closed.

## 6 Operation

### 6.1 Overview of the operating options

#### 6.1.1 4 to 20 mA with HART protocol

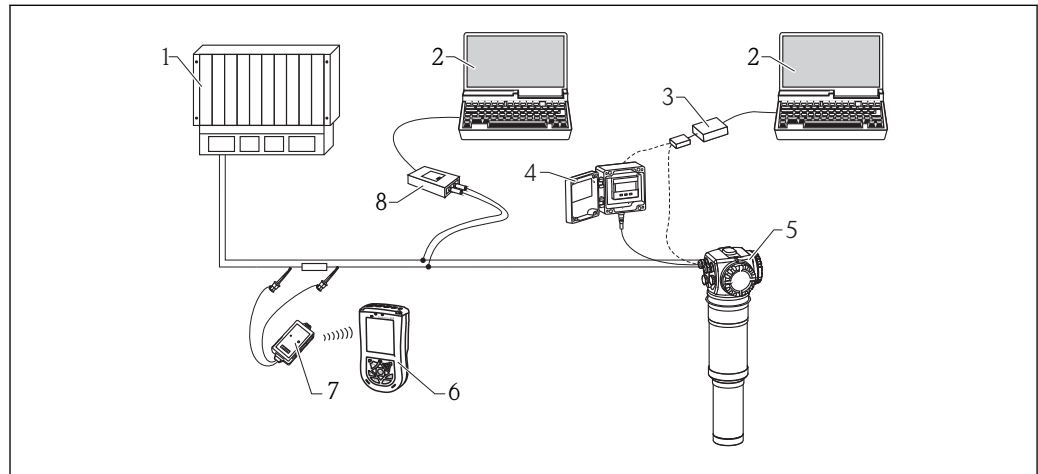

A0018095

- 1 PLC (programmable logic controller)
- 2 Computer with operating tool (e.g. FieldCare)
- 3 Commubox FXA291 with ToF Adapter FXA291
- 4 FHX40 with display VU331
- 5 Gammapilot M
- 6 Field Xpert SFX100
- 7 VIATOR Bluetooth modem with connecting cable
- 8 Commubox FXA195 (USB)

If the HART communication resistor is not built into the supply unit, a 250  $\Omega$  communication resistor must be incorporated into the 2-wire line.

#### Operation via the service interface

- With the display and operating unit FHX40
- With a personal computer, Commubox FXA291 with ToF Adapter FXA291 (USB) and the "FieldCare" operating program. FieldCare is a graphical operating software for measuring devices from Endress+Hauser. It assists with commissioning, data backup, signal analysis and documentation of the measuring point.

#### Operation via HART

- With Field Xpert SFX100
- With the Commubox FXA195 and the "FieldCare" operating program

## 6.2 Display operation

### 6.2.1 Display and operating elements

The LCD module VU331 for displaying and operating is located inside the remote display and operating unit FHX40. The measured value can be read through the FHX40 window. The FHX40 must be opened in order to operate the device. Remove the four screws on the cover to do so.

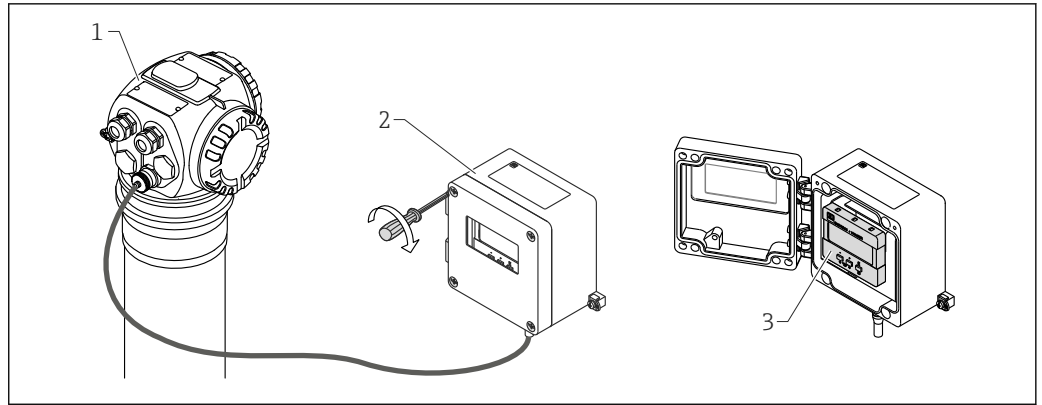

A0018096

- 1 Gammapiilot M
- 2 FHX40
- 3 Operating module VU331

### LCD module VU331

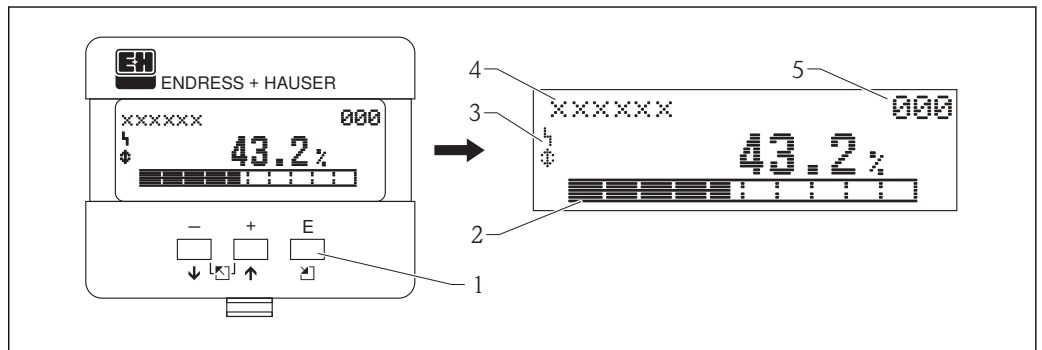

A0018097

- 1 Operating keys
- 2 Bargraph
- 3 Symbols
- 4 Function name
- 5 Parameter ID number

### Display symbols

The following table describes the symbols that appear on the liquid crystal display:

Symbol	Meaning
⚡	<b>ALARM_SYMBOL</b> This alarm symbol is displayed when the device is in an alarm condition. If the symbol flashes, this indicates a warning.
🔒	<b>LOCK_SYMBOL</b> This lock symbol is displayed when the device is locked, i.e. if no entries are possible.
⚡	<b>COM_SYMBOL</b> This communication symbol is displayed when data transmission via HART, PROFIBUS PA or FOUNDATION Fieldbus, for example, is in progress.
⚡	<b>SIMULATION_SWITCH_ENABLE</b> This communication symbol is displayed when simulation in FOUNDATION Fieldbus is enabled via the DIP switch.

**Function of the keys**

Key(s)	Meaning
⏴ or ⏵	Navigate upwards in the selection list Edit the numeric values within a function
⏶ or ⏷	Navigate downwards in the selection list Edit the numeric values within a function
⏪ and ⏩ or ↔	Navigate to the left within a function group
⏴	Navigate to the right within a function group, confirmation
⏴ and ⏴ or ⏶ and ⏴	Contrast settings of the LCD
⏴ and ⏶ and ⏴	Hardware locking/unlocking After locking the hardware, operation via the display and communication is not possible! The hardware can only be unlocked via the display. An access code must be entered to do so.

**6.2.2 The operating menu**

**Function codes**

The functions of the Gammapilot M are arranged in an operating menu. To ensure easy orientation within this menu, a unique position code is indicated on the display for each function. This code consists of one alphabetic and two numeric characters.

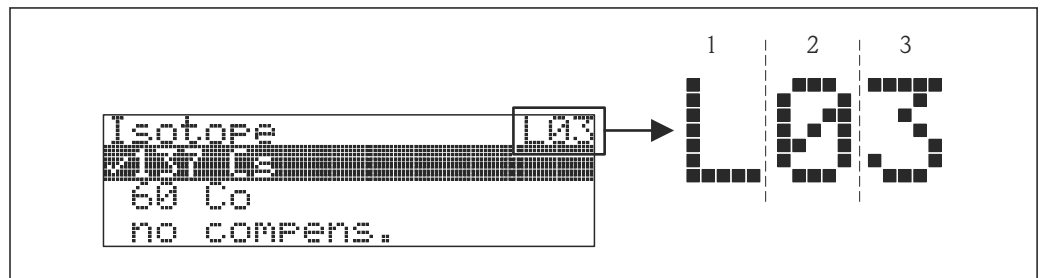

A0019876-EN

- 1 Measuring mode
- 2 Function group
- 3 Function



- The alphabetic character indicates the current measuring mode of the Gammapilot M:
  - L: Level
  - S: Switch
  - D: Density
  - C: Concentration
  - \*: no measuring mode selected yet
- The first numeric character identifies the function group:
  - **Basic setup \*0**
  - **Calibration \*1**
  - **Safety settings \*2**
  - ...
- The second numeric character identifies the individual functions within the function group:
  - **Basic setup \*0**
  - **Today's date \*01**
  - **Beam type \*02**
  - **Isotope \*03**
  - **Operating mode \*04**
  - ...

Hereinafter, the position is always indicated in brackets after the function name. "\*" (not yet selected) is always indicated as the measuring mode, e.g. "Present date" (\*01)



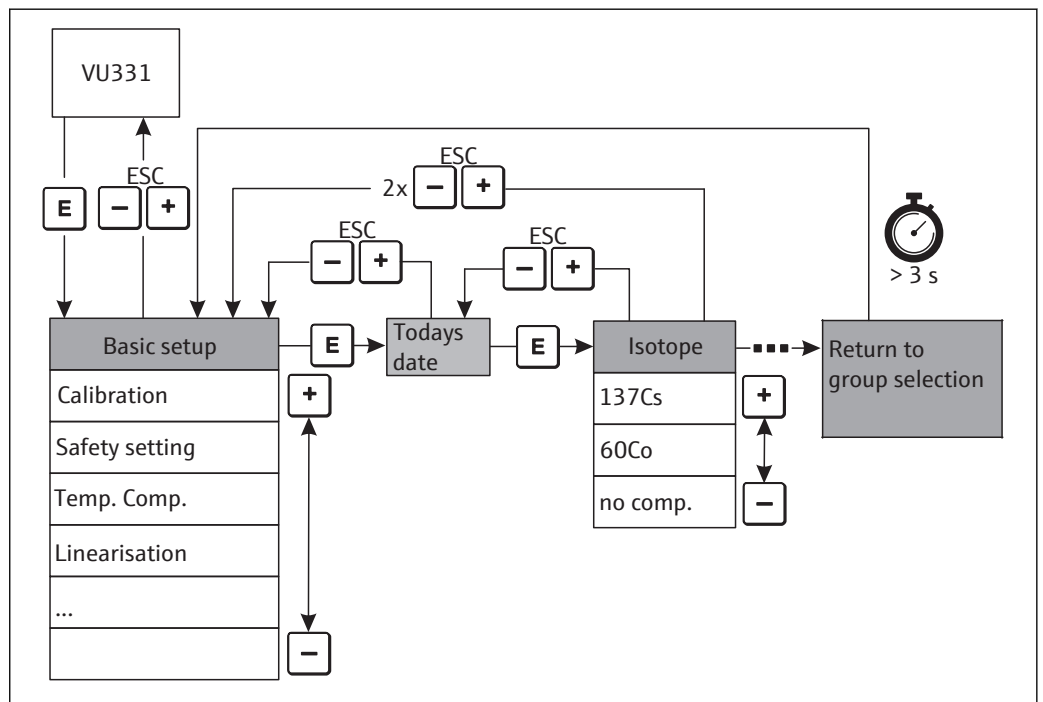



**Operation using the local display VU331**









7 Operation using the local display VU331

A0037159-EN



















### Selection and configuration in the operating menu:

- Switch from the measured value display to the **Group selection** by pressing 
- Press  or  to select the desired **Function group** and press  to confirm. The  mark in front of the menu text indicates the active option.
- Press  or  to activate the Edit mode

#### Selection menus

- Select the required parameter in the **function** selected with  or 
-  confirms the selection; the  mark appears in front of the selected parameter
-  confirms the edited value; the system quits the Edit mode
- Pressing  and  simultaneously will cancel the selection; the system quits the Edit mode

#### Entering numerals and text

- Press  or  to edit the first character of the numeral/text
  -  positions the cursor at the next character; continue with  and  until the entire value has been entered
  - If the  appears at the cursor, press  to accept the value entered; the system quits the Edit mode
  - If the  appears at the cursor, press  to return to the previous character
  - Pressing  and  simultaneously will cancel the selection; the system quits the Edit mode
- Press  to select the next function
  - Press  and  simultaneously once to return to the last **function**  
Press  and  simultaneously twice to return to the **group selection**
  - Press  and  simultaneously to return to the **measured value display**

## 6.3 Alternative operation options

As an alternative to local operation, the measuring device can also be configured and measured values obtained via the HART protocol. Two options are available for operation:

- Operation via the FieldXpert SFX100 handheld terminal
- Operation via a personal computer (PC) using the FieldCare operating program

 The device can also be operated locally using the keys. If operation is locked by locking the keys locally, parameter entry via communication is not possible either.

### 6.3.1 Operation via Field Xpert SFX100

Compact, flexible and robust industrial handheld terminal for remote configuration and measured value interrogation via the HART current output or FOUNDATION Fieldbus. For details refer to

 BA00060S/04/EN

### 6.3.2 Operation with FieldCare

FieldCare is an Endress+Hauser asset management tool based on FDT technology. With FieldCare, you can configure all Endress+Hauser devices as well as devices from other manufacturers that support the FDT standard. Hardware and software requirements can be found on the Internet:

[www.de.endress.com](http://www.de.endress.com) -> Search: FieldCare -> FieldCare -> Technical data

FieldCare supports the following functions:

- Configuration of transmitters in online mode
- Loading and saving device data (upload/download)
- Documentation of the measuring point

Connection options:

- HART via Commubox FXA195 and USB interface of a computer
- Commubox FXA291 with ToF Adapter FXA291 via service interface

## 6.4 Locking/unlocking configuration

### 6.4.1 Software locking



Enter a number unequal to 100 in the "**Unlock parameter**" (\*A4) function in the "**Diagnostics**" (\*A) function group. The  symbol appears on the display. No more entries can be made.





If you try to change a parameter, the device goes to the "**Unlock parameter**" (\*A4) function. Enter "100". Parameters can now be modified again.

### 6.4.2 Hardware locking

Press ,  and  simultaneously. No more entries can be made. If you try to change a parameter, the following appears:

Local display
Unlock parameter 0A4  Hardware locked

Press ,  and  simultaneously. The "**Unlock parameter**" (\*A4) function appears. Enter "100". Parameters can now be modified again.

 Hardware locking can only be unlocked again via the display by pressing the ,  and  keys simultaneously once again. It is not possible to unlock the hardware by communication.

## 6.5 Resetting to the default configuration

It is always advisable to reset the customer parameters if you want to use a device with an unknown history. Effects of resetting:

- All customer parameters are reset to their default values.
- Linearization is switched to "**Linear**" but the table values are kept. The table can be switched back on in the "**Linearization**" (\*40/\*46) function in the "**Linearization**" (\*4) function group.

To perform a reset, enter "333" in the "**Reset**" (\*A3) function in the "**Diagnostics**" (\*A) function group.

### CAUTION

- ▶ A reset may negatively impact the measurement. As a rule, a basic setup must be performed again after a reset. All the calibration data are deleted after a reset. A complete calibration is needed to put the measurement back into operation.

 The default values of each parameter are shown in bold in the menu overview in the appendix.

## 7 Commissioning

**i** This chapter describes how to commission the Gammapiilot M using the display and operating module VU331 (which is located in the remote display and operating unit FHX40). Commissioning via "FieldCare" or "Field Xpert SFX100" is performed in a similar manner. More information on the "FieldCare" operating program and on Field Xpert SFX100 is provided in BA00027S/04/EN and BA00060S/04/EN respectively.

### 7.1 Calibration: overview

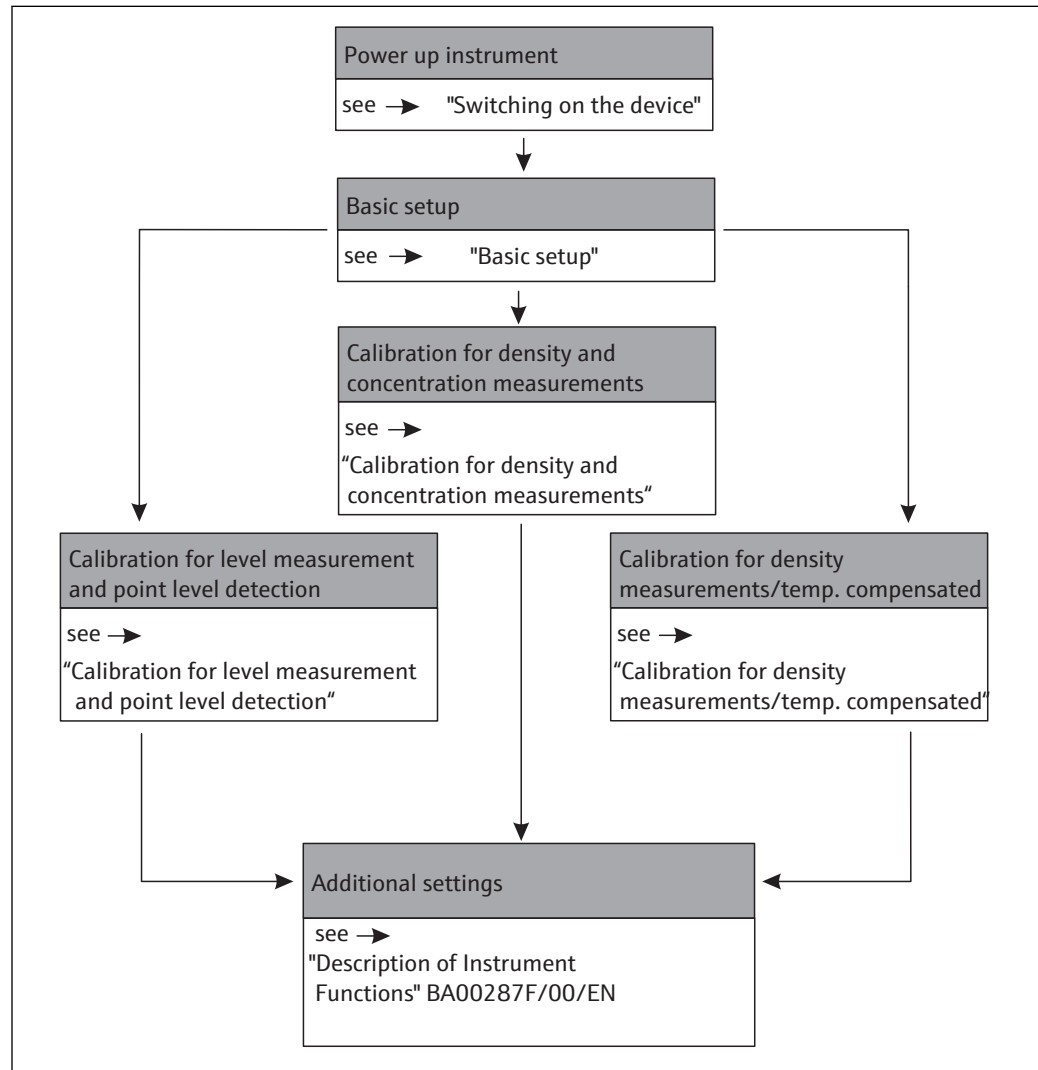

A0037160-EN

**i** A detailed description of the functions used can be found in the following sections:

- Basic setup → 46
- Calibration for level measurement and point level detection → 51
- Calibration for density and concentration measurements → 64
- Density measurement/temperature-compensated → 71

## 7.2 Switching on the device

### Error messages A165 "Electronics defect" and A635 "Present date not defined"

The Gammapilot M contains 2 real-time clocks for decay compensation, which are permanently compared with one another for safety reasons. In order to bridge voltage interruptions, the clocks are buffered with a capacitor. To ensure that the clocks work correctly and retain the date in the event of a voltage interruption, this capacitor must have a minimum charge. If the A165 "Electronics defect" or A635 "Present date not defined" error message appears **after switching on** the Gammapilot M, this may indicate that the capacitor is not yet sufficiently charged. In this case, the Gammapilot M must be operated at the operating voltage for at least 20 to 30 minutes in order to charge the capacitor. After this, the correct date must be entered. If the error message persists after this, it can be deleted by switching the Gammapilot M off and then on again.

After the supply voltage has been switched on, the device is first initialized. Due to internal memory tests, this takes approx. 2 minutes.

Local display
FMG60 V01.03.06

The following information appears for approximately 5 seconds:

- Device type
- Software version
- Type of communication signal

Language 092
<input checked="" type="checkbox"/> English
<input type="checkbox"/> Français
<input type="checkbox"/> Español

On the first power-up, select the language for the text on the display.

Select the language with the  and  keys. Press  twice to confirm your selection.

Group selection
<input checked="" type="checkbox"/> Basic setup
<input type="checkbox"/> Calibration
<input type="checkbox"/> Safety settings

The measured value screen then appears.

The basic setup can now be performed. Press  to switch to the group selection:

Press  again to enter the first function of the "Basic setup" function group

## 7.3 Basic setup

### 7.3.1 "Present date" (\*01)

Local display
Present date *01 17.11.04 ____ 10:30 DD.MM.YY ____ HH:MM

This function is used to enter the date and time of the basic setup. Each of these values must be confirmed by pressing  after entering the value.

### 7.3.2 "Beam type" (\*02)

Local display
Beam type *02 <input checked="" type="checkbox"/> Standard/cont. Modulated

This function is used to specify whether the radiation source used emits radiation continuously or whether it is modulated (for gamma radiography suppression).

- Standard/continuous (permanent, continuous radiation)
- Modulated (modulated radiation source)

### 7.3.3 "Isotope" (\*03)

Local display
Isotope *03 <input checked="" type="checkbox"/> 137 Cs 60 Co No compens.

This function is used to specify which isotope is used for the measurement. The Gammapilot M needs this information for decay compensation.

### 7.3.4 "Operating mode" (\*04)

Local display
Operating mode *04 <input checked="" type="checkbox"/> Stand alone Master Slave

This function is used to specify in which operating mode the Gammapilot M will be used.

-  The operating mode can only be selected once. After this, the function is automatically locked and can only be unlocked by resetting the Gammapilot M ("Reset" (\*A3) function).

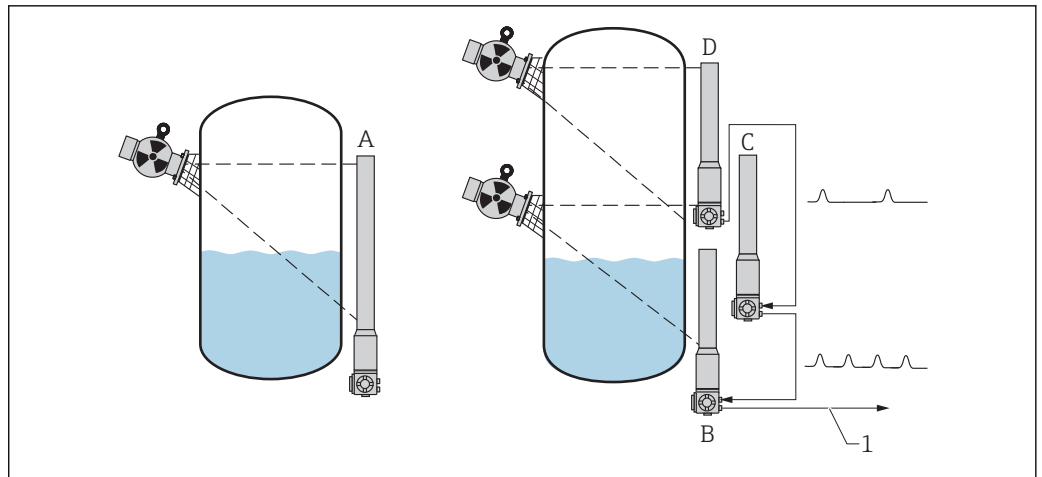

A0018107

- A Stand alone.  
Only one Gammapilot M is required for measuring ranges up to 2 m (6.6 ft)  
For larger measuring ranges, any number of Gammapilot M devices can be interconnected (cascade mode).  
The devices are defined by software settings as:
- B Master
- C Slave(s) or
- D End slave
- 1 4 to 20 mA HART; PROFIBUS PA; FOUNDATION Fieldbus

**Options/display:**

- **Stand alone:** This option is selected if the Gammapilot M is used as a single, standalone device.
- **Master:** This option is selected if the Gammapilot M is located at the beginning of a cascade chain. It then receives the pulses from a connected slave, adds its own pulses and calculates the measured value from this total.
- **Slave:** This option is selected if the Gammapilot M is located in the middle of a cascade chain. It then receives the pulses from another connected slave or end slave, adds its own pulses and transmits this total to the next device (master or slave). The calibration is finished if this option is selected. If several transmitters are cascaded, the rest of the calibration procedure is performed on the master only.
- **End slave:** This option is selected if the Gammapilot M is located at the end of a cascade chain. It does not receive pulses from another device but transmits its own pulses to the next device (master or slave). The calibration is finished if this option is selected. If several transmitters are cascaded, the rest of the calibration procedure is performed on the master only.
- **Not defined:** Is displayed if the operating mode has not yet been selected. An option must be selected in order to continue with the basic setup.



If a "slave" or an "end slave" is connected to "FieldCare", the pulse rate of this device is displayed in the header instead of the measured value.

**7.3.5 "Measuring mode" (\*05)**

Local display
Measuring mode *05
✓ Level
Switch
Density

This function is used to select the desired measuring mode.

**Further options:**

- Level measurement (continuous)
- Level limit detection
- Density measurement (with temperature compensation if required)
- Concentration measurement (density measurement followed by linearization)

**i** The operating mode can only be selected once. After this, the function is automatically locked and can only be unlocked by resetting the Gammapiot M ("Reset" (\*A3) function).

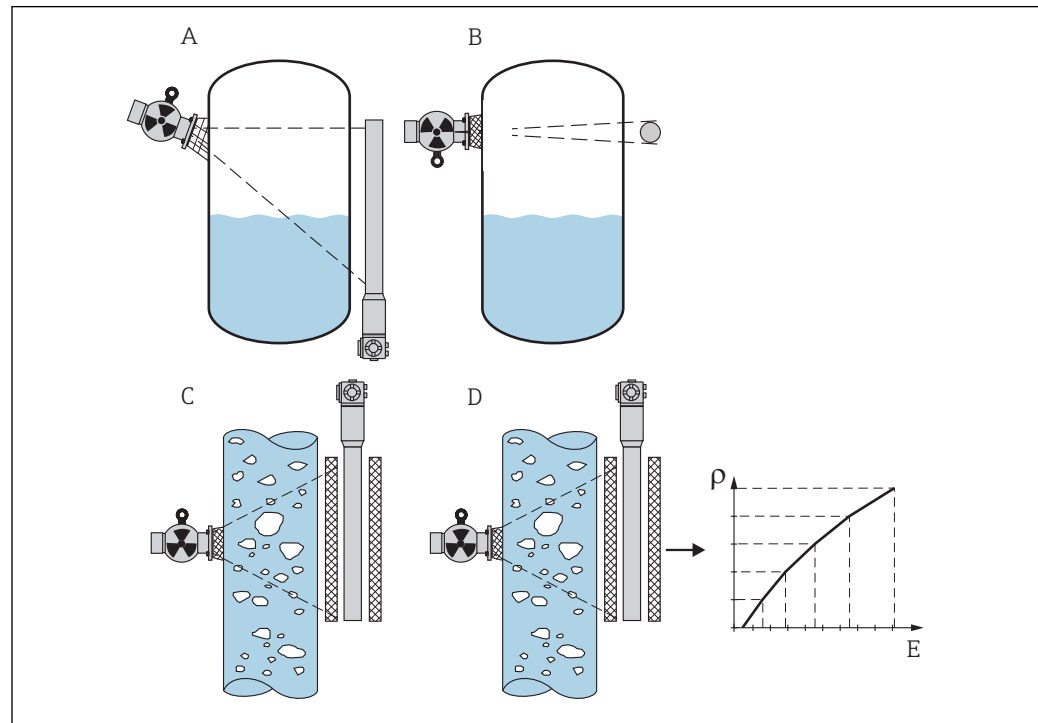

A0018108

- A Level measurement (continuous)  
 B Level limit detection  
 C Density measurement (with temperature compensation if required)  
 D Concentration measurement (density measurement followed by linearization)  
 $\rho$  Density  
 E Concentration

**7.3.6 "Density unit" (\*06)**

Local display
Density unit *06
✓ g/cm <sup>3</sup>
g/l
lb/gal

This function is needed for density and concentration measurements only. It is used to select the density unit.

**Further options:**

- g/cm<sup>3</sup>
- g/l
- lb/gal; [1g/cm<sup>3</sup> = 8,345 lb/gal]
- lb/ft<sup>3</sup>; [1g/cm<sup>3</sup> = 62,428 lb/ft<sup>3</sup>]
- °Brix; [1°Brix = 270 (1 - 1/x)]



- °Baumé; [ $1^{\circ}\text{Baumé} = 144.3 (1 - 1/x)$ ]
- °API; [ $1^{\circ}\text{API} = 131.5 (1,076/x - 1)$ ]
- °Twaddell; [ $1^{\circ}\text{Twaddell} = 200 (x-1)$ ]

"x" refers to the density in  $\text{g}/\text{cm}^3$ . The formula indicates how many degrees this density corresponds to.

### 7.3.7 "Min. density" (\*07)

Local display
Min. density *07 0.9500 $\text{g}/\text{cm}^3$

This function is needed for density and concentration measurements only. It is used to specify the lower limit of the density measuring range. The output current for this density is 4 mA.

### 7.3.8 "Max. density" (\*08)

Local display
Max. density *08 1.2500 $\text{g}/\text{cm}^3$

This function is needed for density and concentration measurements only. It is used to specify the upper limit of the density measuring range. The output current for this density is 20 mA.

### 7.3.9 "Pipe diameter unit" (\*09)

Local display
Pipe diam. unit *09 ✓ mm inch

This function is needed for density and concentration measurements only. It is used to select the unit for the pipe diameter.

1 in = 25.4 mm

### 7.3.10 "Pipe diameter" (\*0A)

Local display
Pipe diam. *0A 200 mm

This function is needed for density and concentration measurements only. It is used to specify the irradiated measuring path L. With standard installation, this value is identical to the pipe inner diameter  $D_I$ . For other installations (to enlarge the irradiated measuring path), it may be larger however (see figure). The pipe walls are not to be considered a part of the measuring path.

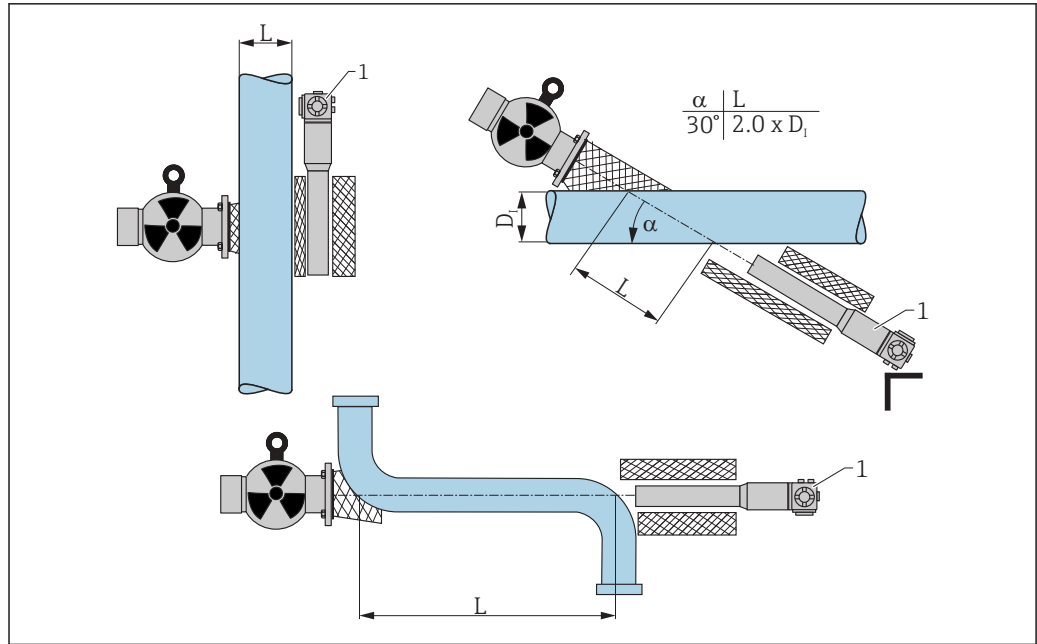

A0018109

8 Always specify the complete irradiated measuring path L in the "Pipe diameter" (\*0A) function. Depending on the installation, this value may be larger than the actual pipe diameter.

1 Gammapilot M

### 7.3.11 "Output damping" (\*0B)

Local display
Output damping *0B 60 s

This function is used to specify the output damping time  $\tau$  (in seconds). A change in the measured value is attenuated by this time. After a change in the level or density it takes  $5 \times \tau$  until the new measured value is reached.

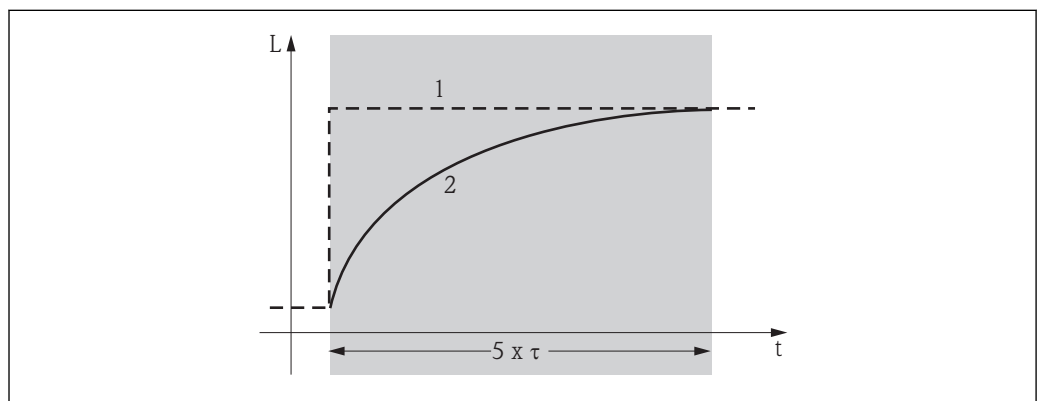

A0018110

- 1 Level change (or density change)
- 2 Measured value

#### Value range

1 to 999 s

### Default value

The default value depends on the selected **"Measuring mode" (\*05)**:

- Level: 6 s
- Switch: 6 s
- Density: 60 s
- Concentration: 60 s

### Selecting the output damping value

The output damping value depends on the process conditions. Increasing the output damping value makes the measured value considerably steadier but also slower. In order to reduce the influence of stirrers or turbulent surfaces, it is advisable to increase the output damping value. However, the value selected for output damping should not be too large so that rapid changes in the measured value can also be detected quickly.

## 7.4 Calibration for level measurement and point level detection

### 7.4.1 General principles

The calibration points for the measurement are entered in the **"Calibration" (\*1)** function group. Each calibration point consists of a level and the associated pulse rate.

#### Calibration points for level measurement

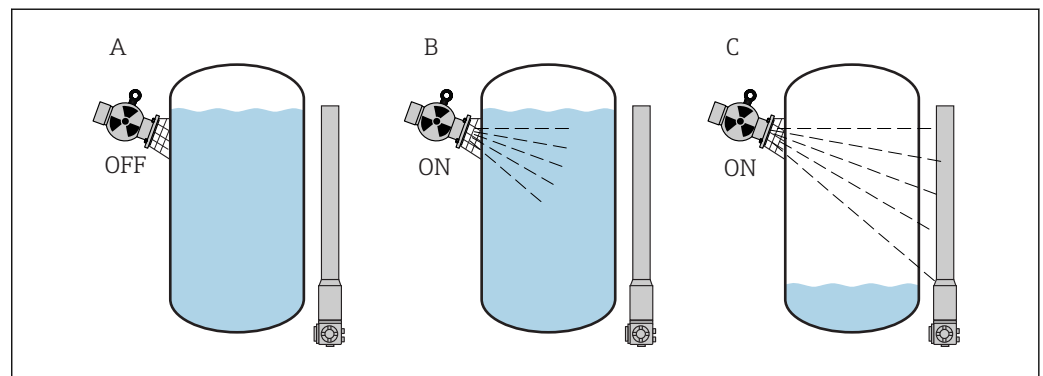

- A Background calibration  
 B Full calibration  
 C Empty calibration

#### Background calibration

Background calibration refers to the following situation:

- The radiation is switched off
- The vessel is filled as much as possible (ideally 100%) within the measuring range.

The background calibration is necessary in order to register the natural background radiation at the mounting position of the Gammapilot M. The pulse rate of this background radiation is automatically subtracted from all other measured pulse rates. This means that only the part of the pulse rate which originates from the applied radiation source is displayed and taken into account during signal analysis. As the background radiation remains virtually constant for the entire measurement duration (as opposed to the radiation of the source used), background calibration is not included in automatic decay compensation of the Gammapilot M.

### Full calibration

Full calibration refers to the following situation:

- The radiation is switched on
- The vessel is filled as much as possible (ideally 100%, at least 60%) within the measuring range.

If the vessel cannot be filled to at least 60% during the calibration, the full calibration can alternatively be performed with the radiation switched off. This is a way of simulating a vessel that is 100% full. In this case, full calibration is identical to background calibration. As the pulse rate of the background calibration is automatically subtracted, the pulse rate displayed is around 0 cps.

 This type of simulated calibration is not possible with self-radiating media. In this case, the vessel must be filled to 100% to perform the background and full calibration.

### Empty calibration

Empty calibration refers to the following situation:

- The radiation is switched on
- The vessel is emptied as much as possible (ideally 0%, at least 40%) within the measuring range.

### Calibration points for point level detection

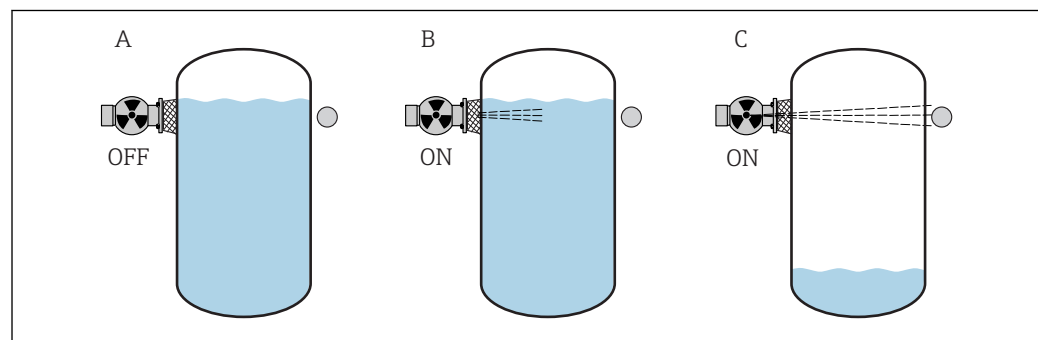

- A Background calibration  
 B Covered calibration  
 C Free calibration

### Background calibration

Background calibration refers to the following situation:

- The radiation is switched off.
- The radiation path is completely covered

The background calibration is necessary in order to register the natural background radiation at the mounting position of the Gammapilot M. The pulse rate of this background radiation is automatically subtracted from all other measured pulse rates. This means that only the part of the pulse rate which originates from the applied radiation source is displayed. As the background radiation remains virtually constant for the entire measurement duration (as opposed to the radiation of the source used), background calibration is not included in automatic decay compensation of the Gammapilot M.

### Covered calibration

Covered calibration refers to the following situation:

- The radiation is switched on
- The radiation path is completely covered, where possible

If the radiation path cannot be completely covered during the calibration, the covered calibration can alternatively be performed with the radiation switched off. This is a way of simulating a completely covered radiation path. In this case, covered calibration is identical

to background calibration. As the pulse rate of the background calibration is automatically subtracted, the pulse rate displayed is around 0 c/s.

**i** This type of simulated calibration is not possible with self-radiating media. In this case, the radiation path must be completely covered to perform the background calibration and the covered calibration.

*Free calibration*

Free calibration refers to the following situation:

- The radiation is switched on
- The radiation path is completely free

**Methods for entering the calibration points**

*Automatic calibration*

For an automatic calibration, the vessel is filled to the required value. The radiation remains switched off for background calibration, while radiation is switched on for all other calibration points. The Gammapilot M records the pulse rate automatically. The associated level is entered by the user.

*Manual calibration*

If one or more calibration points cannot be implemented during the commissioning of the Gammapilot M (e.g. because the vessel cannot be sufficiently filled or emptied), this calibration point must be entered manually. This means that both the level and the associated pulse rate must be entered directly. Please contact Endress+Hauser Service for any questions regarding the calculation of the pulse rate.

**i** Calibration date and calibration

- The calibration date is not set automatically during manual calibration. It must be entered by the user in the "Calibration date" (\*C7) function.
- A calibration point entered manually should be replaced by an automatic calibration as soon as the associated level occurs during the operation of the plant. This recalibration is advisable because calibration points entered automatically result in more precise measurement results than calculated ones.

**7.4.2 Background calibration**

**Excerpt from the operating menu**

The following excerpt from the operating menu illustrates the entries to be made for background calibration. The individual functions are explained in detail in the sections that follow.

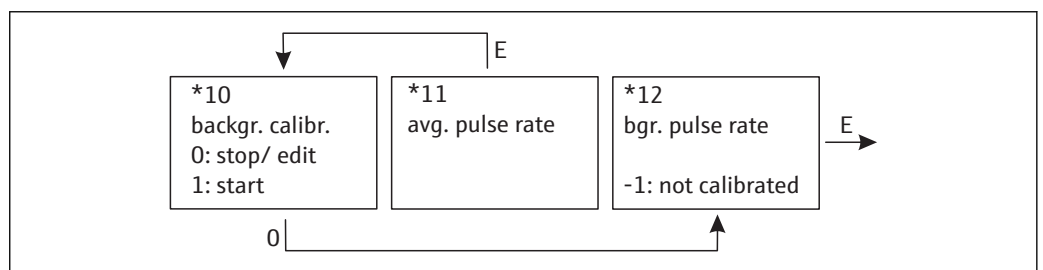

A0037161-EN

**"Background calibration" (\*10)**

Local display
Backgr. cal. *10 Stop/edit Start

This function is used to start the background calibration

*Options:*

▪ **Stop/edit**

This option must be selected if:

- No background calibration is to be performed but the pulse rate of an existing background calibration is to be displayed instead.
- The background calibration is to be performed manually.

Once this option has been selected, the Gammapilot M goes to the **"Bgr. pulse rate" (\*12)** function where the existing pulse rate is displayed and can be changed if required.

▪ **Start**

This option is used to start automatic background calibration. The Gammapilot M changes to the **"Avg. pulse rate" (\*11)** function.

**"Avg. pulse rate" (\*11)**

Local display
Avg. pulse rate *11 186 cps

The average (integrated) pulse rate is displayed in this function (after the selection of "Start" in the previous function). Initially, this value fluctuates (because of the decay statistics), but reaches an average value over time due to integration. The longer the averaging is performed, the lower the fluctuations.

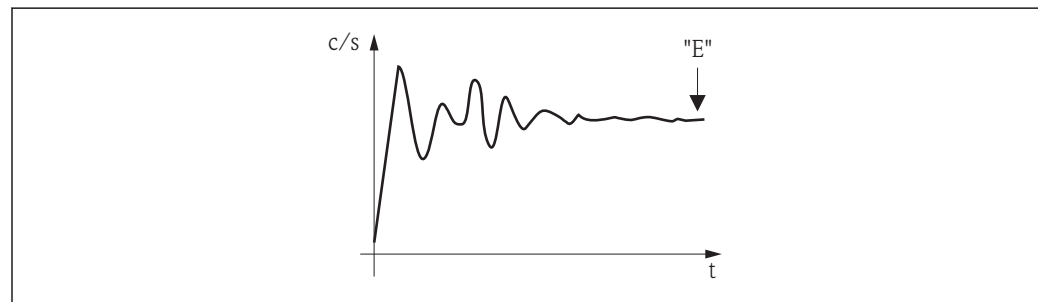

A0018118

When the value is sufficiently stable users can quit the function by pressing **[E]**. After this, the Gammapilot M changes to the **"Background calibration" (\*10)** function. Here the

"**Stop/edit**" option must be selected to stop the integration. The value is then automatically transmitted to the "**Background pulse rate**" (\*12) function.



#### **Background pulse rate**

- The maximum integration time (= averaging time) is 1000 s. After this time, the value is automatically transmitted to the "**Background pulse rate**" (\*1B) function.
- Integration is **not** terminated by pressing  $\square$  in the "**Avg. pulse rate**" (\*11) function. Integration continues until "**Stop/edit**" is selected in the "**Background calibration**" (\*10) function. For this reason, there may be a slight deviation between the last average (integrated) pulse rate displayed and the final "**Background pulse rate**" (\*12).

#### "Background pulse rate" (\*12)

Local display
Avg. pulse rate *12 186 cps

The pulse rate of the background calibration is displayed in this function. Press  $\square$  to confirm the value and complete the background calibration. If a background calibration has not yet been performed, "-1" is displayed. There are two options if this occurs:

- Return to the "Background calibration" (\*10) function and restart the background calibration
- Enter a known or calculated pulse rate (manual calibration). The Gammapilot M then changes to the "Calibration point" (\*13) or (\*1A) function.

### 7.4.3 Full and empty calibration or covered and free calibration

#### Excerpt from the operating menu

The following excerpt from the operating menu illustrates the procedure for empty and full calibration (for level measurements) or for free and covered calibration (for point level detection). The individual functions are explained in detail in the sections that follow. The functions are only accessible once the background calibration has been performed.

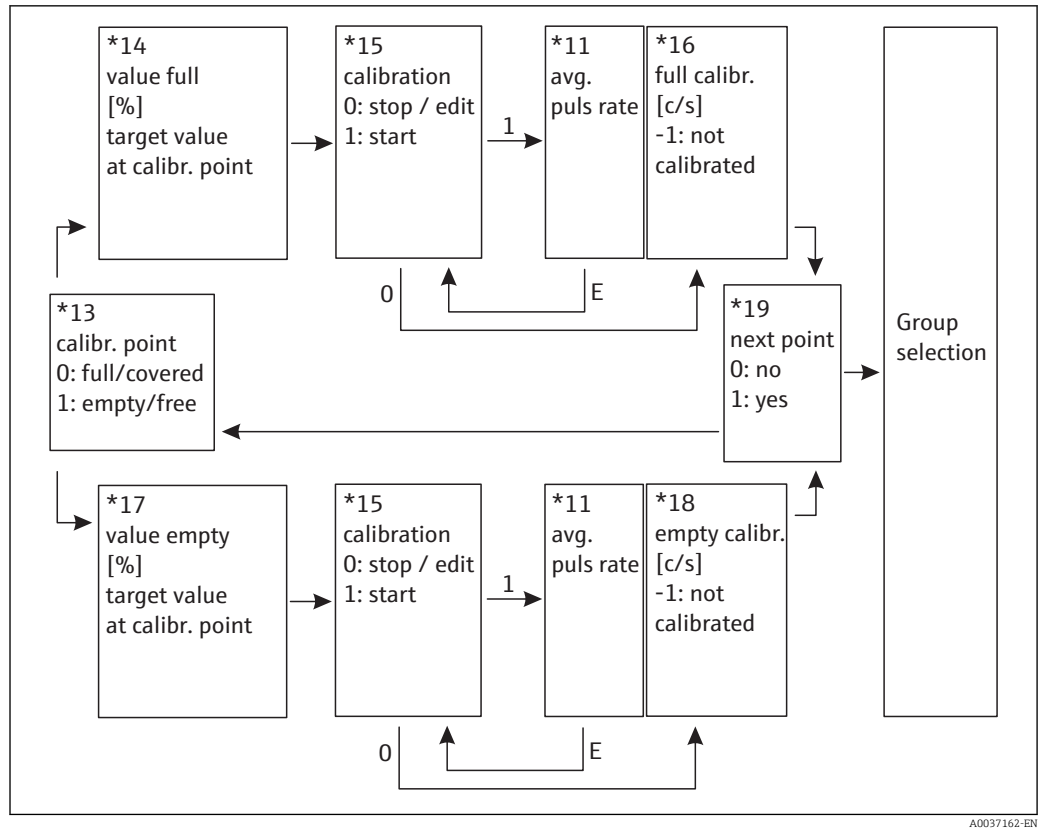

A0037162-EN

**i** The "Value full" (\*14) and "Value empty" (\*17) functions only appear if the "Level" option was selected in the "Measuring mode" (\*05) function.

**"Calibration point" (\*13)**

Local display
Calibr. point *13
✓ Full/covered
Empty/free

This function is used to select which calibration point ("full/covered" or "empty/free") will be entered.

**"Value full" (\*14) / "Value empty" (\*17)**

Local display
Value full *14
100%

Local display
Value empty *17
0%

These functions are needed for level measurements only. They are used to specify the level at which the full or empty calibration is performed.



Range of values

	optimum value	minimum value	maximum value
Value full (*14)	100%	60%	100%
Value empty (*17)	0%	0%	40%

"Calibration" (\*15)

Local display
Calibration *15 Stop/edit Start

This function is used to start automatic entry of the selected calibration point

Options:

■ Stop/edit

This option must be selected if:

- The calibration point is not to be entered (e.g. because it has already been entered). The pulse rate of the calibration point is then displayed in the following function "Full calibration" (\*16) or "Empty calibration" (\*18). This value can be changed if required.
- The calibration point is to be entered manually. The Gammapilot M changes to the "Full calibration" (\*16) or "Calibration empty" (\*18) function.

■ Start

This option is used to start automatic entry of the calibration point. The Gammapilot M then changes to the "Avg. pulse rate" (\*11) function.

"Avg. pulse rate" (\*11)

Local display
Avg. pulse rate *11 2548 cps

The average (integrated) pulse rate is displayed in this function (after the selection of "Start" in the previous function). Initially, this value fluctuates (because of the decay statistics), but reaches an average value over time due to integration. The longer the averaging is performed, the lower the fluctuations.

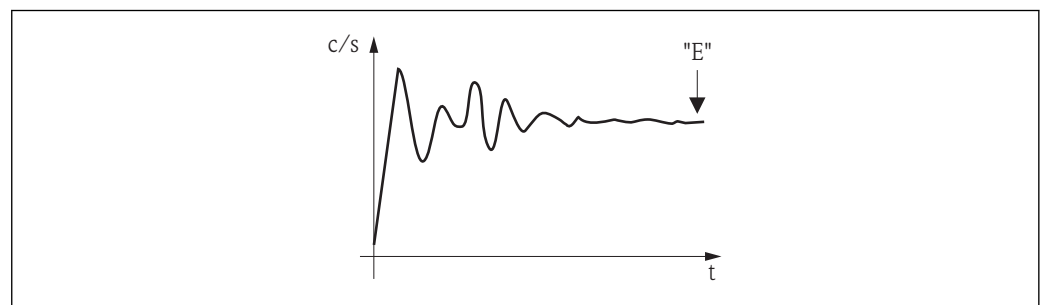

9 The integrated (average) pulse rate fluctuates greatly at the start. An average value is reached over time.

When the value is sufficiently stable users can quit the function by pressing [E]. After this, the Gammapilot M changes to the "Calibration" (\*15) function. Here the "Stop/edit"

option must be selected to stop the integration. The value is then automatically transmitted to the **"Full calibration" (\*16)** or **"Empty calibration" (\*18)** function.

#### **Avg. pulse rate**

- The maximum integration time (= averaging time) is 1000 s. After this time, the value is automatically transmitted to the **"Full calibration" (\*16)** or **"Empty calibration" (\*18)** function.
- Integration is **not** terminated by pressing  in the **"Avg. pulse rate" (\*11)** function. Integration continues until **"Stop/edit"** is selected in the **"Calibration" (\*15)** function. For this reason, there may be a slight deviation between the last average (integrated) pulse rate displayed and the final **"Full calibration" (\*16)** or **"Empty calibration" (\*18)**.

#### **"Full calibration" (\*16) / "Empty calibration" (\*18)**

Local display
Full calibration *16 33 cps

Local display
Empty calibration *18 2548 cps

The pulse rate of the full or empty calibration is displayed in this function. Press  to confirm the value. If a full or empty calibration has not yet been performed, "-1" is displayed. There are two options if this occurs:

- Either return to the **"Calibration" (\*15)** function and restart the calibration
- Or enter a known or calculated pulse rate (manual calibration)

#### **"Next point" (\*19)**

Local display
Next point *19 ✓ No Yes

This function is used to specify whether an additional calibration point is to be entered or not.

*Options:*

- **No**  
Select this option once both calibration points have been entered. The Gammapilot M then returns to the group selection and the calibration is completed.
- **Yes**  
Select this option if only one calibration point has yet been entered. The Gammapilot M then returns to the **"Calibration point" (\*13)** function and the next point can be entered.

### 7.4.4 Additional settings

After the basic setup, the Gammapilot M outputs the measured value via the current output and the HART signal. The entire measuring range (0 to 100%) is mapped to the range (4 to 20 mA) of the current output. Many additional functions are available for optimizing the measuring point and can be configured as required. For a detailed

description of all the device functions, see BA00287F/00/EN, "Gammapilot M - Description of Device Functions" or the CD-ROM supplied.

### 7.4.5 Configuration of the connected limit switch (for point level detection)

 For safety-related applications, the threshold values in the Safety Manual SD00230F/00/EN and SD00324F/00/EN must be observed.

The switching signal is calculated from the continuous signal in a connected evaluation unit or in a process transmitter and not in the Gammapilot M itself. For information on the configuration, please refer to the Operating Instructions of the specific device. The following settings are recommended if using the Endress+Hauser process transmitter RTA421 or RMA42:

#### For maximum fail-safe mode

- Switch threshold (SETPT) = 75%
- Hysteresis (HYST) = 50%

## 7.5 Function group "Safety settings" (\*2)

Local display
Group selection *2 ✓ Safety settings Temp. compensation Linearization

### 7.5.1 "Output on alarm" (\*20)

Local display
Outp. on alarm *20 MIN -10% 3.6 mA MAX 110% 22 mA Hold

This function determines what value the output of the Gammapilot M adopts in an alarm condition.

(*20)	Output on alarm	
	4 to 20 mA with HART	PROFIBUS PA FOUNDATION Fieldbus
MIN	3.6 mA	-99999
MAX	22 mA	+99999
Hold	The last measured value is held	
User-specific (can only be selected for HART devices)	As defined in "Output on alarm" (*21)	Not possible

### 7.5.2 "Output on alarm" (\*21)

Local display
Outp. on alarm *21 22.00 mA

This function is used to specify what user-specific value the current output should adopt in an alarm condition. The value is entered in mA. This function is only available for HART devices. It is only active if the "User-specific" option has been selected in the "Output on alarm" (\*20) function. Value range: 3.6 to 22 mA

## 7.6 SIL locking (for point level detection 200/400 mm PVT scintillator) (HART only)

SIL locking ("Security locking" (022) function) is in the **"Safety settings" (S2)** function group. It can only be accessed in the **"Stand alone"** operating mode in conjunction with the **"Switch"** measuring mode (see also "Prerequisites for locking"). As soon as SIL locking or unlocking is started, communication via the display or via FieldCare is significantly slower. This is due to internal readback and parameter validation. However, this only applies during the locking or unlocking phase and does not affect the measurement itself. In the event of locking, all the parameters are locked apart from the manufacturer reset code. The parameters can only be viewed. Only the manufacturer reset code can be modified. Locking starts by entering a four-digit password (1000 to 9999). Then there follows a sequence of prompts for the most important parameters which all have to be confirmed. The locking is concluded by confirming the password. The device is locked as soon as the password is confirmed. The password is no longer visible. If a parameter or the password is displayed incorrectly and thus the password or a parameter is not confirmed, the locking procedure is canceled. The FMG60 is then in an unlocked state, as it was before the locking procedure began.

### Prerequisites for locking

The following parameters must be configured for locking to be possible:

- Operating mode = Stand alone
- Measuring mode = Switch
- Communication = HART Ex i or HART Ex e/d
- Type of scintillator = PVT
- Detector length = 200 or 400
- SW version = 01.02.00 or 01.02.02
- Radiation source = Cs or Co

Check whether the calibration values of the readback path are in the valid range.

### 7.6.1 List of the parameters to be confirmed

The following parameters can be modified by the user and must therefore be confirmed. The detector length must be confirmed since it cannot be defined with regard to the safety function in the final check and is only in the service segment following repair work.

The following parameters can be modified by the user and must therefore be confirmed. The detector length must be confirmed since it cannot be defined with regard to the safety function in the final check and is only in the service segment following repair work.

- Date
- Beam type (standard or modulated <sup>2)</sup>)
- Isotope (Cs or Co)
- Output damping
- Calibration date
- Background pulse rate cps
- Free calibration cps
- Covered calibration cps

2) Modulated only for max. point level detection

- Gammagraphy hold time (can only be configured for "Standard" beam type) or 10 for modulated source
- Output current  $\leq 3.0$  mA
- Detector length

### 7.6.2 Function "Security locking" (\*22) (SIL unlocking)

The FMG60 can be unlocked in SIL2/3 mode by entering the password. If the password is entered correctly, the FMG60 is unlocked. If an incorrect password is entered, the FMG60 goes back to the group selection. The device cannot be unlocked by switching the power ON and then OFF.

Local display
Security locking *22 ✓ Unlocked Locked Device locked

#### Further options:

- Unlocked
- Locked
- Device locked
- Device unlocked

### 7.6.3 Forgotten your password?

The password cannot be viewed when the device is locked. For this reason, the password can only be deleted by a manufacturer reset. At the same time, all the parameters are set to default values and the calibration data are deleted. The device then has a failure current.

### 7.6.4 Function "Password" (\*23) (security password)

The password is always a four-digit number in the range from 1000 to 9999. Other values are not valid. After locking, 0000 is displayed. The password itself is not.

Local display
Password *23 -----

### 7.6.5 Function "Confirm Iout" (\*24) (output current during locking)

To ensure that the user can clearly recognize whether the FMG60 is locked, the output current is changed to  $<3.6$  mA, typically 2.4 mA, via the 2nd switch-off path when "Device locked" is selected. The user must explicitly confirm this current value. The system must go through the entire locking sequence before the FMG60 is set to the "Device locked" state and the output current is released again. If the FMG60 is switched off and then on again during the locking process, the FMG60 resumes normal, unlocked operation. If a parameter is not confirmed, the FMG60 remains in the "Device locked" state. The device can also be switched to "Unlocked" during the locking process; it then operates in the normal operating mode. The "Device locked" state can also be disabled by performing a

total reset (7864). This also deletes all the calibration parameters, however. The correct locking state can be determined using the "partial stroke test".

Local display
Confirm lout *24 <input checked="" type="checkbox"/> Not valid <input type="checkbox"/> Valid

### 7.6.6 Function "Confirm sequence" (\*25) (display check)

To verify that numbers are shown properly on the display, the sequence of numbers > 0123456789 .- < is the first element to be confirmed on the display. The user must confirm the numbers are displayed correctly. If an error occurs in how the numbers are displayed, the user must cancel the locking action.

Local display
Confirm sequence *25 >0123456789 .-< <input checked="" type="checkbox"/> Not valid <input type="checkbox"/> Valid

### 7.6.7 Function "Confirm backgr." (\*26)

Local display
Confirm backgr. *26 ----- <input checked="" type="checkbox"/> Not valid <input type="checkbox"/> Valid

Select "Valid" if the data displayed (see \_ \_ \_ \_ \_ ) match the data you entered. Select "Not valid" if you want to cancel SIL locking.

### 7.6.8 Function "Confirm cal." (\*27)

Local display
Confirm cal. *27 ----- ----- <input checked="" type="checkbox"/> Not valid

Select "Valid" if the data displayed (see \_ \_ \_ \_ \_ ) match the data you entered. Select "Not valid" if you want to cancel SIL locking.

#### Further options:

- Not valid
- Valid

### 7.6.9 Function "Confirm source" (\*28)

Local display
Confirm source *28 ----- ----- <input checked="" type="checkbox"/> Not valid

Select "Valid" if the data displayed (see \_\_\_\_\_) match the data you entered. Select "Not valid" if you want to cancel SIL locking.

**Further options:**

- Not valid
- Valid

**7.6.10 Function "Confirm time" (\*29) (output damping)**

Local display
Confirm time *29 ----- -----
<input checked="" type="checkbox"/> Not valid

Select "Valid" if the data displayed (see \_\_\_\_\_) match the data you entered. Select "Not valid" if you want to cancel SIL locking.

**Further options:**

- Not valid
- Valid

**7.6.11 Function "Confirm date" (\*2A)**

Local display
Confirm date *2A ----- -----
<input checked="" type="checkbox"/> Not valid

Select "Valid" if the data displayed (see \_\_\_\_\_) match the data you entered. Select "Not valid" if you want to cancel SIL locking.

**Further options:**

- Not valid
- Valid

**7.6.12 Function "Confirm length" (\*2B)**

Local display
Confirm length *2B -----
<input checked="" type="checkbox"/> Not valid
Valid

Select "Valid" if the data displayed (see \_\_\_\_\_) match the data you entered. Select "Not valid" if you want to cancel SIL locking.

**7.6.13 Function "Confirm password" (\*2C)**

Local display
Confirm password *2C -----
<input checked="" type="checkbox"/> Not valid
Valid

Select "Valid" if the data displayed (see \_\_\_\_\_) match the data you entered. Select "Not valid" if you want to cancel SIL locking.

### 7.6.14 Function "Password" (\*2D) (unlock password)

The password is always a four-digit number in the range from 1000 to 9999. Other values are not valid. Enter the four-digit password to unlock the device.

Local display
Password *2D -----

## 7.7 Calibration for density and concentration measurements

### 7.7.1 General principles

The calibration points for the measurement are entered in the "Calibration" (\*1) function group. Each calibration point consists of a density value and the associated pulse rate.

#### Calibration points for density and concentration measurements

##### Function of the calibration points

In addition to the length of the irradiated measuring path, the Gammapilot M also needs the following two parameters for density and concentration measurements:

- The absorption coefficient  $\mu$  of the material measured
- The reference pulse rate  $I_0$ <sup>3)</sup>

It calculates these parameters automatically from the pulse rates of the following calibration points:

- Background calibration (calibration with radiation switched off)
- Up to nine calibration points for samples of various known densities

**i** In the case of self-radiating media, the background calibration must always be performed when the pipe is filled. A simulated calibration with an empty pipe is not possible in this case.

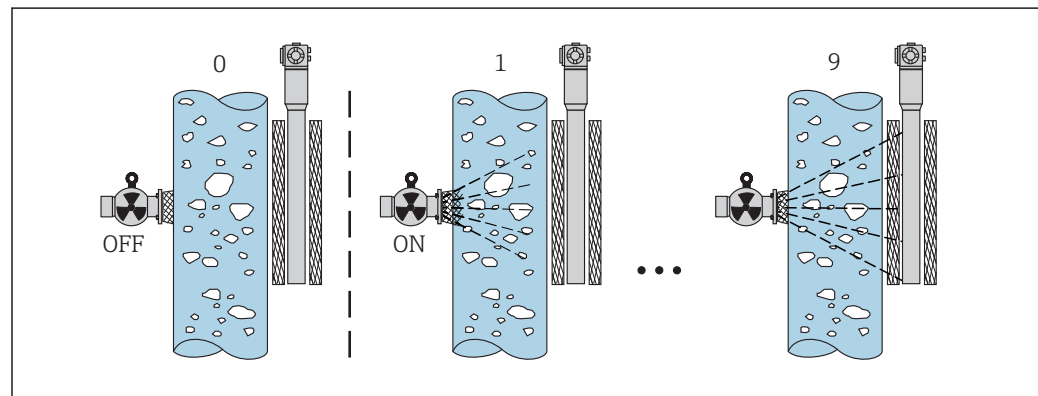

A0018128

0 Background calibration

1-9 Calibration points for various densities

3)  $I_0$  is the pulse rate when the tube is empty. The value is significantly higher than any real pulse rates occurring during the measurement.



### *Two-point calibration*

Two-point calibration is the recommended calibration procedure to meet strict accuracy requirements over the entire measuring range. Background calibration is performed first of all. Afterwards, the two calibration points are entered. These points should be as far apart as possible. Once the two calibration points have been entered, the Gammapilot M calculates the  $I_0$  and  $\mu$  parameters on its own.

### *One-point calibration*

A one-point calibration can be performed if a two-point calibration is not possible. This means that apart from the background calibration only one additional calibration point is used. This calibration point should be as close as possible to the operating point. Densities in the proximity of this operating point are measured quite accurately, but the accuracy can decrease as the distance from the calibration point increases. In one-point calibration, the Gammapilot M only calculates the reference pulse rate  $I_0$ . In this case, it uses the default value  $\mu = 7.7 \text{ mm}^2/\text{g}$  for the absorption coefficient.

### *Multiple-point calibration*

Multiple-point calibration is recommended particularly for measurements in a large density range or for particularly accurate measurements. Up to 9 calibration points can be used over the entire measuring range. The calibration points should be as far apart as possible and should be evenly distributed over the entire measuring range. Once the calibration points have been entered, the Gammapilot M calculates the  $I_0$  and  $\mu$  parameters on its own. Multiple-point calibration is recommended particularly for measurements in a large density range or for particularly accurate measurements.

### *Recalibration*

The Gammapilot M provides an additional calibration point (calibration point "10") for recalibration. This point can be entered if the measuring conditions have changed, e.g. as a result of deposit buildup in the measuring tube. Once the calibration point has been entered,  $I_0$  is recalculated according to the current measuring conditions. The absorption coefficient  $\mu$  from the original calibration remains unchanged.

## **Methods for entering the calibration points**

### *Automatic calibration*

In the case of automatic calibration, the calibration point in question is implemented on the vessel or the measuring tube, i.e. the measuring tube is filled with a medium of the desired density. The radiation remains switched off for background calibration, while radiation is switched on for all other calibration points. The Gammapilot M records the pulse rate automatically. The associated density is determined in the laboratory and entered by the user.

### *Manual calibration*

In order to achieve a high level of measuring accuracy, it is advisable to determine the pulse rates for several samples at a constant density and to calculate the average density and average pulse rate for these samples. These values can then be entered manually in the Gammapilot M. If possible, this procedure should be repeated at another density. The two density values should be as far apart as possible.



The calibration date is not set automatically during manual calibration. It must be entered by the user in the "Calibration date" (\*C7) function.

## 7.7.2 Background calibration

### Excerpt from the operating menu

The following excerpt from the operating menu illustrates the entries to be made for background calibration. The individual functions are explained in detail in the sections that follow.

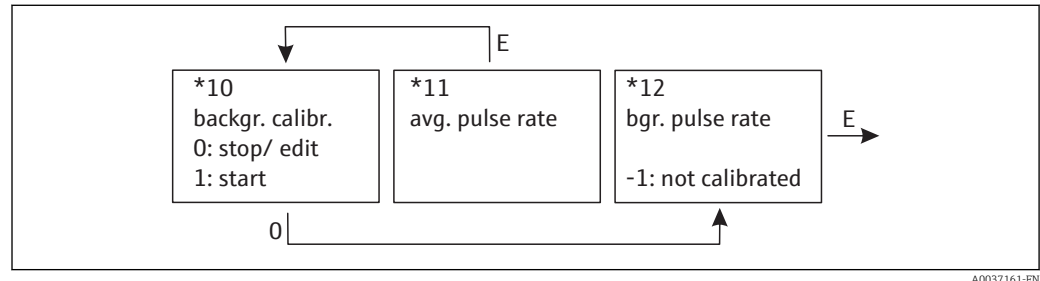

A0037161-EN

### "Background calibration" (\*10)

Local display
Backgr. cal. *10 Stop/edit Start

This function is used to start the background calibration

Options:

#### ■ Stop/edit

This option must be selected if:

- No background calibration is to be performed but the pulse rate of an existing background calibration is to be displayed instead.
- The background calibration is to be performed manually.

Once this option has been selected, the Gammapiilot M goes to the "**Bgr. pulse rate" (\*12)** function where the existing pulse rate is displayed and can be changed if required.

#### ■ Start

This option is used to start automatic background calibration. The Gammapiilot M changes to the "**Avg. pulse rate" (\*11)** function.

### "Avg. pulse rate" (\*11)

Local display
Avg. pulse rate *11 186 cps

The average pulse rate is displayed in this function. Initially, this value fluctuates (because of the decay statistics), but reaches an average value over time due to integration. The longer the averaging is performed, the lower the fluctuations.

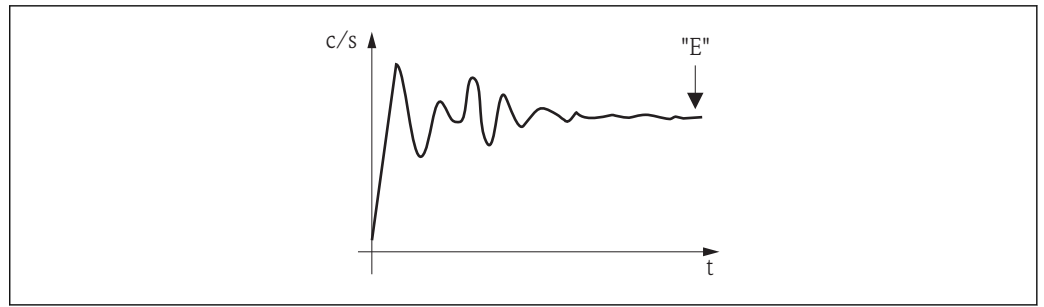

A0018118

When the value is sufficiently stable users can quit the function by pressing  $\boxed{E}$ . After this, the Gammapilot M changes to the **"Background calibration" (\*10)** function. Here the **"Stop/edit"** option must be selected to stop the integration. The value is then automatically transmitted to the **"Background pulse rate" (\*12)** function.

### Background pulse rate

- The maximum integration time (= averaging time) is 1000 s. After this time, the value is automatically transmitted to the **"Background pulse rate" (\*1B)** function.
- Integration is **not** terminated by pressing  $\boxed{E}$  in the **"Avg. pulse rate" (\*11)** function. Integration continues until **"Stop/edit"** is selected in the **"Background calibration" (\*10)** function. For this reason, there may be a slight deviation between the last average (integrated) pulse rate displayed and the final **"Background pulse rate" (\*12)**.

### **"Background pulse rate" (\*12)**

Local display
Avg. pulse rate *12 186 cps

The pulse rate of the background calibration is displayed in this function. Press  $\boxed{E}$  to confirm the value and complete the background calibration. If a background calibration has not yet been performed, "-1" is displayed. There are two options if this occurs:

- Return to the "Background calibration" (\*10) function and restart the background calibration
- Enter a known or calculated pulse rate (manual calibration). The Gammapilot M then changes to the "Calibration point" (\*13) or (\*1A) function.

## 7.7.3 Calibration points

The following excerpt from the operating menu illustrates the procedure for entering the density calibration points. The individual functions are explained in detail in the sections that follow. The functions are only accessible once the background calibration has been performed.

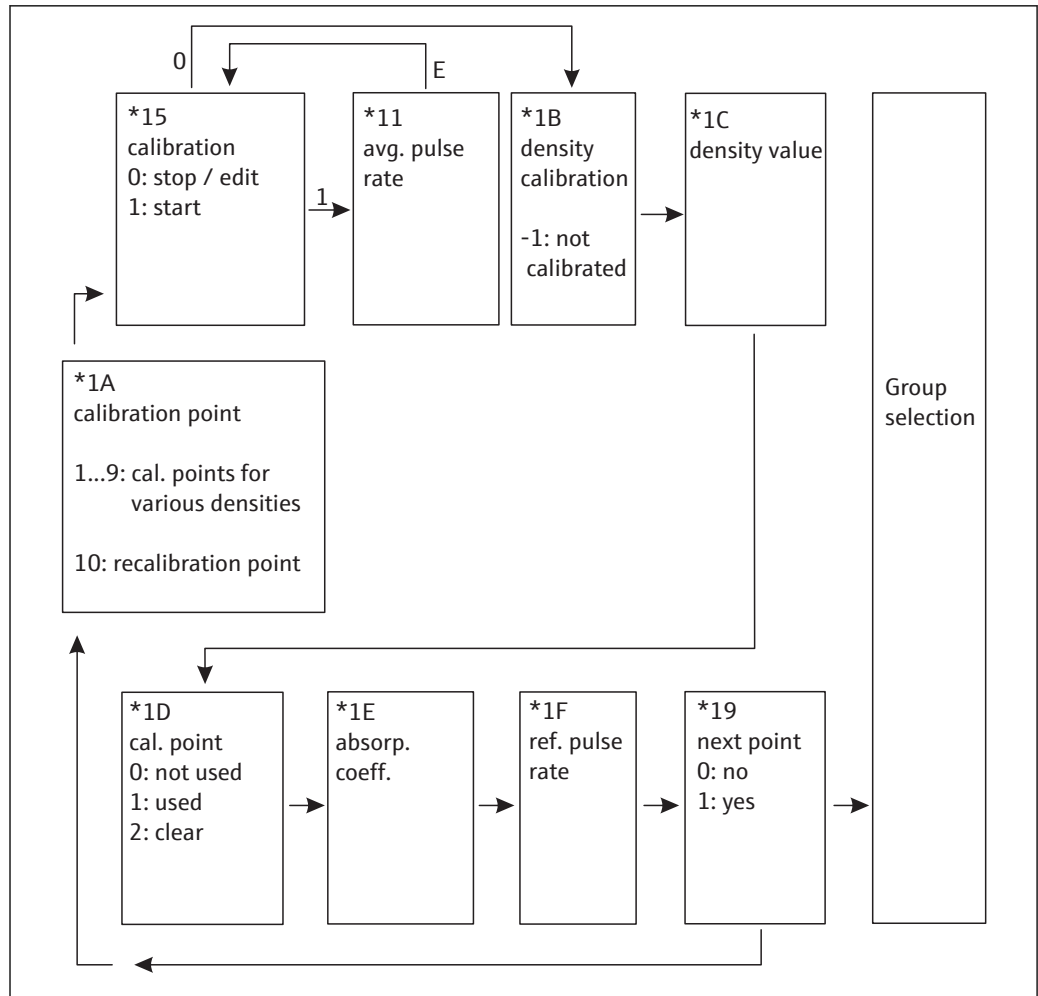

A0037163-EN

**"Calibration point" (\*1A)**

Local display
Calibration point *1A
✓ 1
2
3

This function is used to select the calibration point which will be entered.

Further options:

- "1" to "9": calibration points for various densities
- "10": recalibration point. Once the calibration point has been entered,  $I_0$  is recalculated according to the current measuring conditions. The absorption coefficient  $\mu$  from the original calibration remains unchanged. Calibration point "10" can be entered if the measuring conditions have changed, e.g. as a result of deposit buildup in the measuring tube.

**"Calibration" (\*15)**

Local display
Calibration *15
Stop/edit
Start

This function is used to start automatic entry of the selected calibration point.

Options:

■ **Stop/edit**

This option must be selected if:

- The calibration point is not to be entered (e.g. because it has already been entered). The pulse rate of the calibration point is then displayed in the following function **"Density calib." (\*1B)**. This value can be changed if required.
- The calibration point is to be entered manually. The Gammapilot M changes to the **"Density calib." (\*1B)** function.

■ **Start**

This option is used to start automatic entry of the calibration point. The Gammapilot M then changes to the **"Avg. pulse rate" (\*11)** function.

**"Avg. pulse rate" (\*11)**

Local display
Avg. pulse rate *11 1983 cps

The average pulse rate is displayed with this function (after the selection of "Start" in the previous function). Initially, this value fluctuates (because of the decay statistics), but reaches an average value over time due to integration. The longer the averaging is performed, the lower the fluctuations.

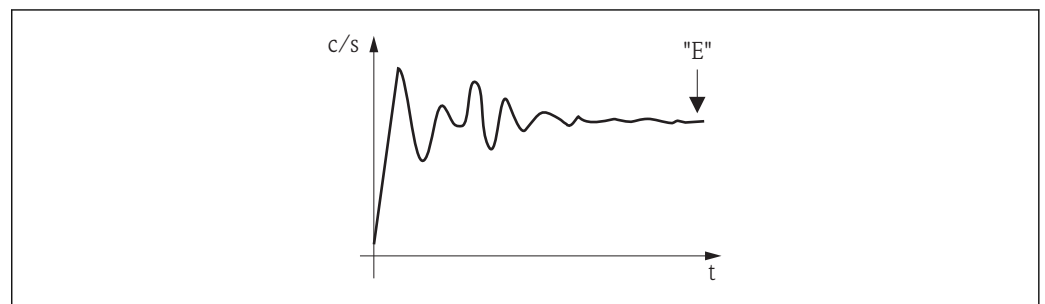

A0018118

When the value is sufficiently stable users can quit the function by pressing  $\boxed{E}$ . After this, the Gammapilot M changes to the **"Calibration" (\*15)** function. Here the **"Stop/edit"** option must be selected to stop the integration. The value is then automatically transmitted to the **"Density calibration" (\*1B)** function.

**i** **Density calibration**

- The maximum integration time (= averaging time) is 1000 s. After this time, the value is automatically transmitted to the **"Density calibration (\*1B)** function.
- During the integration, a sample of the measured material must be taken. Its density must then be determined (e.g. in the laboratory).
- Integration is not terminated by pressing  $\boxed{E}$  in the **"Avg. pulse rate" (\*11)** function. Integration continues until **"Stop/edit"** is selected in the **"Calibration" (\*15)** function. For this reason, there may be a slight deviation between the last average (integrated) pulse rate displayed and the final **"Density calibration (\*1B)**.

**"Density calibration" (\*1B)**

Local display
Density calibration *1B 1983 cps

The pulse rate of the calibration point is displayed in this function. Press  $\boxed{E}$  to confirm the value and complete the entry of the calibration point. If a calibration has not yet been performed for the current point, "-1" is displayed. There are two options if this occurs:

- Either return to the "Calibration" (\*15) function and restart the calibration
- Or enter a known or calculated pulse rate (manual calibration)

#### "Density value" (\*1C)

Local display
Density value *1C 0.9963 g/cm <sup>3</sup>

This function is used to specify the density of the calibration point. The value must be determined from a sample in the laboratory.

-  The temperature effect must be taken into account when entering the density value. The density entered must refer to the temperature at which the pulse rate has been determined. If the density and the pulse rate have been determined at different temperatures, the density value must be corrected accordingly before it is entered.

#### "Calibration point" (\*1D)

Local display
Calibration point *1D Not used ✓ Used Clear

This function is used to specify whether the current calibration point is to be used or not.

##### Options:

- **Not used**  
The calibration point is **not** used. It can be reactivated subsequently, however.
- **Used**  
The calibration point is used.
- **Clear**  
The calibration point is deleted. It cannot be reactivated subsequently.

#### "Absorption coefficient" (\*1E)

Local display
Absorp. coeff. *1E 7.70 mm <sup>2</sup> /g

This function is used to display the absorption coefficient  $\mu$  which results from the calibration points that are currently active. The displayed value is used to check plausibility.

-  If only one calibration point is active, the absorption coefficient is not calculated and the last valid value is used instead. The default value  $\mu = 7.70 \text{ mm}^2/\text{g}$  is used during initial commissioning and following a reset. This value can be changed by the user, however.

**"Reference pulse rate" (\*1F)**

Local display
Ref. pulse rate *1F 31687 cps

This function is used to display the reference pulse rate  $I_0$  which has been calculated from the calibration points currently active. The value cannot be edited.

  $I_0$  is the pulse rate when the tube is empty (theoretical reference value). Generally, the value is significantly higher than any real pulse rates occurring during the measurement.

**"Next point" (\*19)**

Local display
Next point *19 <input checked="" type="checkbox"/> No Yes

This function is used to specify whether the current calibration point is to be used or not.

**Options:****■ No**

Select this option if no more calibration points are to be entered or changed. The Gammapilot M then returns to the group selection and the calibration is completed.

**■ Yes**

Select this option if another calibration point is to be entered or changed. The Gammapilot M then returns to the **"Calibration point" (\*1A)** function and the next point can be entered or changed.

**7.7.4 Linearization (for concentration measurements)**

If the concentration is to be measured in a unit other than the **"Density unit" (\*06)**, a linearization must be performed after the basic setup. This is done in the **"Linearization" (\*4)** function group. The individual functions of this group and the linearization procedure are described in Operating Instructions BA00287F/00/EN, "Gammapilot M - Description of Device Functions", which can be found on the CD-ROM supplied.

**7.7.5 Additional settings**

After the basic setup and following the configuration of the current output, the Gammapilot M outputs the measured value via the current output and the HART signal. The entire measuring range ["Min. density" (\*07) to "Max. density" (\*08)] is mapped to the 4 to 20 mA range. Many additional functions are available for optimizing the measuring point and can be configured as required. For a detailed description of all the device functions, see BA00287F/00/EN, "Gammapilot M - Description of Device Functions" or the CD-ROM supplied.

**7.8 Density measurement/temperature-compensated**

Perform density measurement as described in the "Calibration for density and concentration measurements" section and then perform temperature calibration (see the "Temperature compensation" section in BA00287F/00/EN "Gammapilot M - Description of Device Functions").

## 7.9 Gammagraphy detection

See the "Gammagraphy" section of BA00287F/00/EN "Gammapilot M - Description of Device Functions".



## 8 Maintenance and repair

### 8.1 Cleaning

When cleaning the exterior, always use cleaning agents that do not corrode the surface of the housing and the seals.

### 8.2 Repairs

Under the Endress+Hauser repair concept, repairs to the Gammapilot M are performed by Endress+Hauser Service in Endress+Hauser repair workshops. For more information contact the Service Department at Endress+Hauser.

### 8.3 Repairs to Ex- or SIL-certified devices

**The following information must also be taken into account when repairing devices with an Ex or SIL certificate:**

- Repairs to Ex- or SIL-certified devices may only be carried out by Endress+Hauser Service in Endress+Hauser workshops.
- Comply with the prevailing standards, national Ex-area regulations, Safety Instructions (XA) and certificates.
- Only use original spare parts from Endress+Hauser.
- A certified device may only be converted into a different certified device version by Endress +Hauser Service in Endress+Hauser workshops.
- All repairs and modifications must be documented.

### 8.4 Replacement

#### CAUTION

**Data upload/download is not permitted if the device is used for safety-related applications.**

- ▶ After an entire device or an electronics module has been replaced, the parameters can be downloaded to the device again via the communication interface. For this, the data must have been uploaded to the PC beforehand using the "FieldCare" software.

#### **Level measurement and point level detection**

You can continue measuring without performing a new calibration. However, the calibration values should be checked as soon as possible since the mounting position may have changed slightly.

#### **Density and concentration measurement**

A new calibration must be performed after the replacement.

### 8.5 Return

#### 8.5.1 Return

The measuring device must be returned if it is in need of repair or a factory calibration, or if the wrong measuring device has been delivered or ordered. Legal specifications require Endress+Hauser, as an ISO-certified company, to follow certain procedures when handling products that are in contact with the medium.

To ensure swift, safe and professional device returns, please refer to the return procedures and conditions on the Endress+Hauser website at "[www.services.endress.com/return-material](http://www.services.endress.com/return-material)".

## **8.6 Disposal**

When disposing, separate and recycle the device components based on the materials.

## **8.7 Contact addresses at Endress+Hauser**

Contact addresses are available at [www.endress.com/worldwide](http://www.endress.com/worldwide) or from your local Endress+Hauser branch office.

## 9 Accessories

### 9.1 Commubox FXA195 HART

For intrinsically safe HART communication with FieldCare via the USB interface. For details refer to

 TI00404F/00/EN

### 9.2 Commubox FXA291

The Commubox FXA291 connects Endress+Hauser field devices with a CDI interface (Endress+Hauser Common Data Interface) and the USB port of a personal computer or laptop. For details, see

 TI00405C/07/EN

 For Gammapilot M, you also need the "ToF Adapter FXA291" accessory

### 9.3 ToF Adapter FXA291

The ToF Adapter FXA291 connects the Commubox FXA291 with the Gammapilot M via the USB port of a computer or laptop. For details, see

 KA00271F/00/A2

### 9.4 Field Xpert SFX100

Compact, flexible and robust industrial handheld terminal for remote operation and measured value interrogation via the HART current output or FOUNDATION Fieldbus. For details, see

 BA00060S/04/EN

## 9.5 Remote display and operating unit FHX40

### 9.5.1 Dimensions

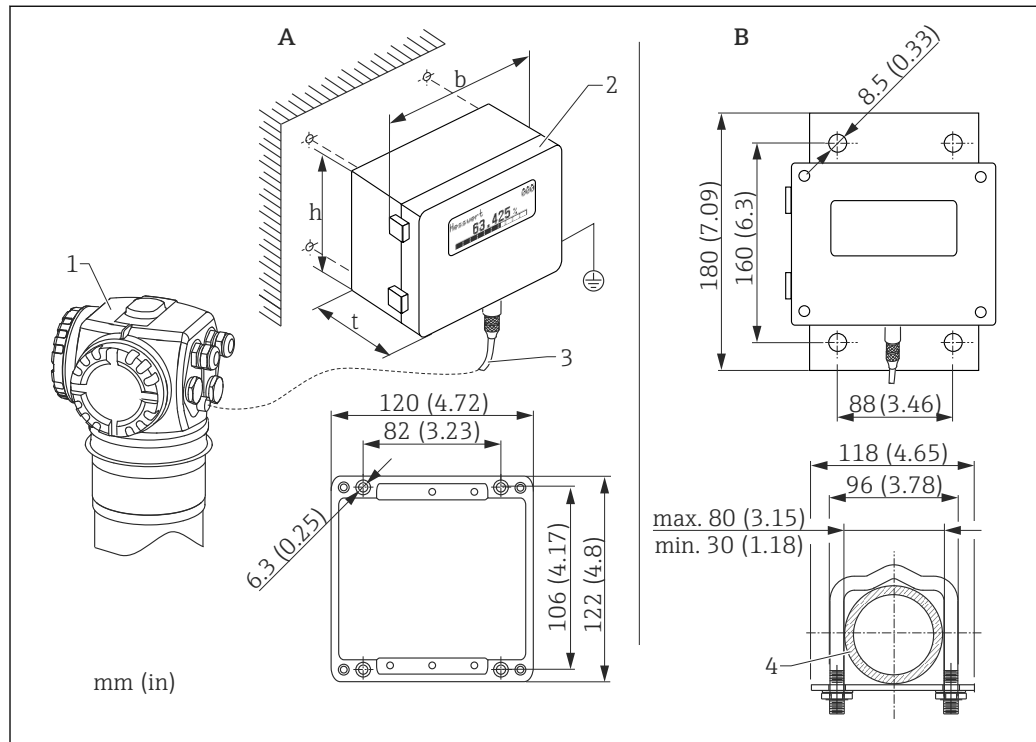

A0018138

- A Wall mounting (without mounting bracket)
- B Pipe mounting (mounting bracket/plate supplied optionally)
- 1 Gammapilot M
- 2 Separate housing FHX40
- 3 Cable
- 4 Pipe

### 9.5.2 Ordering information

010	Approval
A	Non-hazardous area
2	ATEX II 2G Ex ia IIC T6
3	ATEX II 2D Ex ia IIIC T80°C
H	ATEX II 3G Ex ic IIC T6, T5 Gc (in preparation)
G	IECEX Zone1 Ex ia IIC T6/T5
S	FM IS Cl.I Div.1 Gr.A-D, Zone0
U	CSA IS Cl.I Div.1 Gr.A-D, Zone0
N	CSA General Purpose
K	TIIS Ex ia IIC T6
C	NEPSI Ex ia IIC T6/T5 Gb
Y	Special version, TSP-no. to be spec.
020	Cable
1	20m (> HART)
5	20m (> PROFIBUS PA/FOUNDATION Fieldbus)
9	Special version, TSP-no. to be spec.
030	Additional options
A	Basic version
B	Mounting bracket, pipe 1"/2"
Y	Special version, TSP-no. to be spec.

995	Marking
1	Tagging (TAG), see additional spec.

Use the cables provided for the corresponding communication version of the device to connect the remote display FHX40.

### 9.5.3 Technical data (cable and housing)

Cable length	20 m (66 ft) (fixed length including attached plugs)
Temperature range	Temperature class T5: -40 to +75 °C (-40 to +167 °F) Temperature class T6: -40 to +60 °C (-40 to +140 °F)
Degree of protection	IP65/66/67 (housing); IP68 (cable) according to IEC 60529
Materials	Housing: AlSi12; cable gland: nickel-plated brass
Dimensions [mm (in)]	122x150x80 (4.72x5.91x3.15) / HxWxD

### 9.5.4 Materials

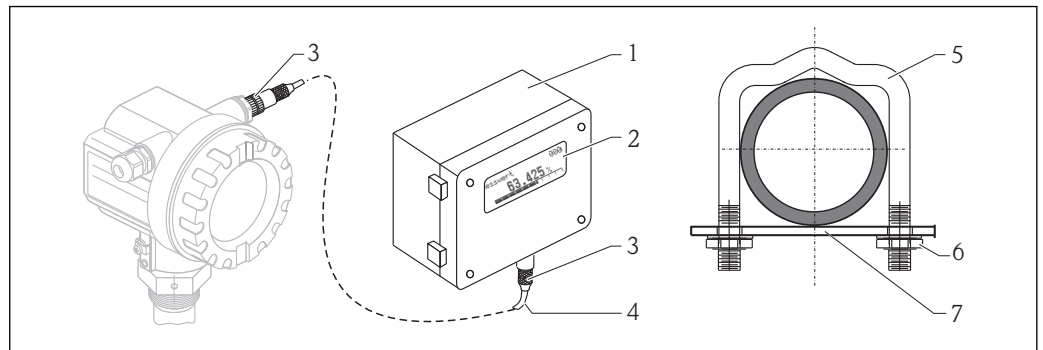

A0019282

10 Materials (see table below)

Position	Part	Material
1	Housing/cover	AlSi12, screw: V2A
	Ground terminal	CuZn nickel-plated, screw: V2A
2	Display	Glass
3	Cable gland	CuZn nickel-plated
4	Cable	PVC
5	Mounting bracket	316 Ti (1.4571) or 316 L (1.4435) or 316 (1.4401)
6	Nut	V4A
7	Plate screw set (M5)	316 Ti (1.4571) spring washer: 301 (1.431) or V2A, screw: V4A, nut: V4A

## 9.6 Mounting device FHG60 (for level and point level measurement)

### 9.6.1 Dimensions

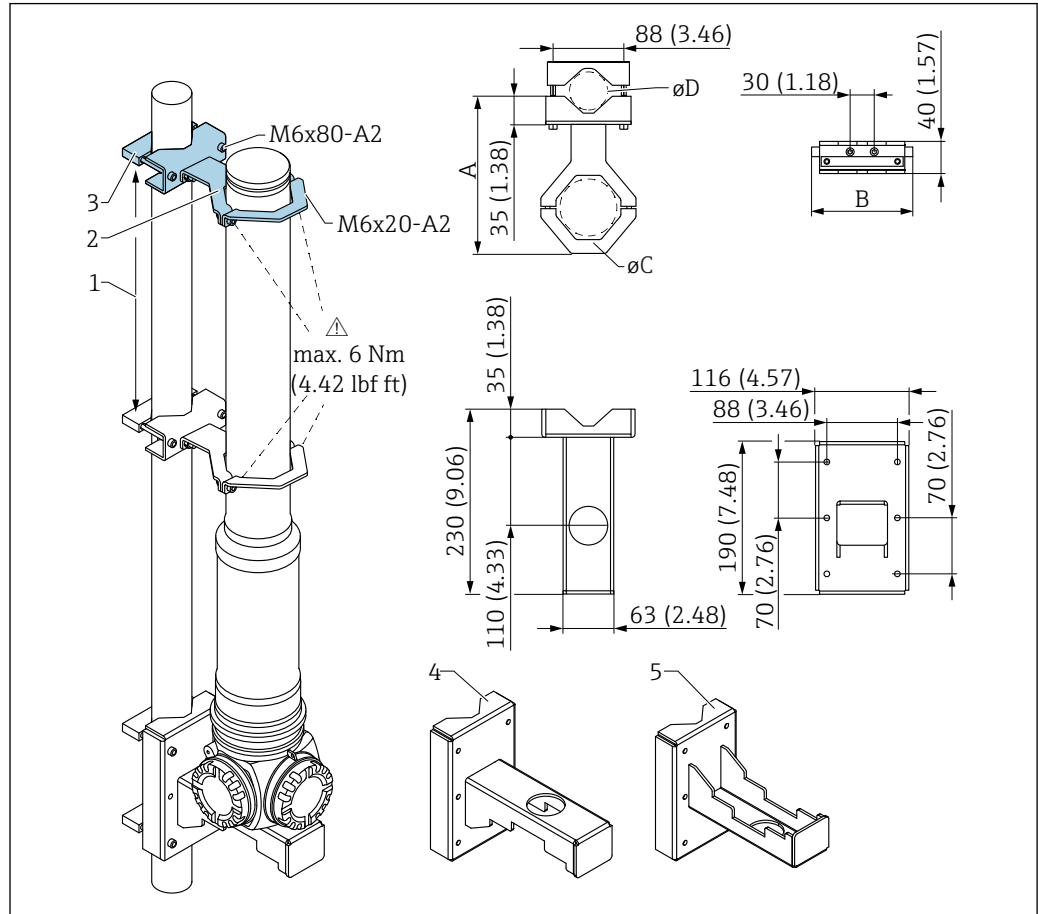

A0018139

- 1 Distance as large as possible
- 2 Retainers (number and size depending on selected application); Allen screws to ISO 4762 are supplied
- 3 Mounting clamps (number depending on selected application)
- 4 With preferred mounting method "housing head down" - bracket (for "level" application only)
- 5 With alternative mounting method "housing head up" - bracket (for "level" application only)

Size of the retainers (depending on selected application):

Mounting position on FMG60	A [mm (in)]	B [mm (in)]	øC [mm (in)]	øD [mm (in)]	Mounting
Scintillator pipe dimensions	198 (7.8)	126 (4.96)	80 (3.15)	40 to 65 (1.57 to 2.56)	(a)
Electronic pipe dimensions	210 (8.27)	150 (5.91)	102 (4.02)		(b)
Water cooling jacket dimensions	230 (9.06)	200 (7.87)	140 (5.51)		(c)

**CAUTION**

**Max. torque for the screws of the retainers:**

- ▶ 6 Nm (4.42 lbf ft)

## 9.6.2 Use

- ✓ Permitted
- ✓ ✓ Preferred

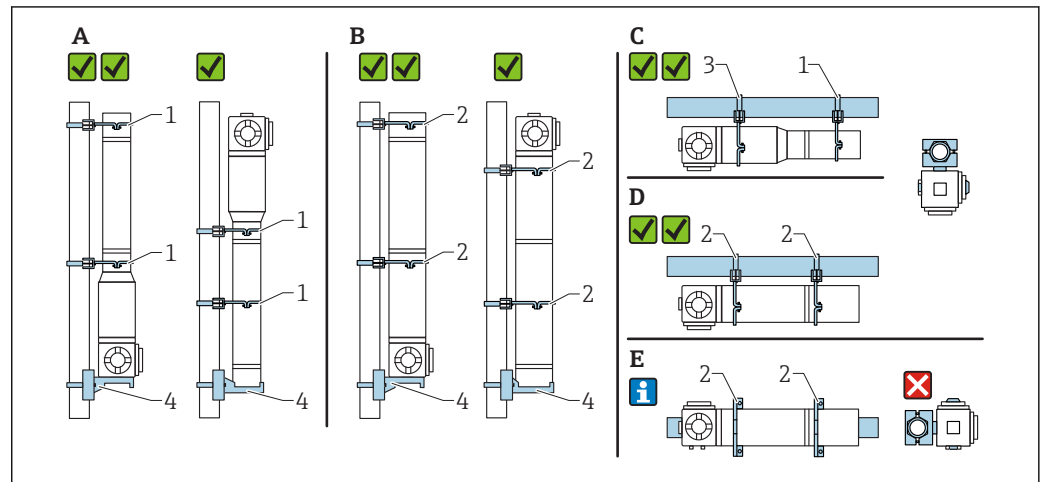

A0018141

- A Level measurement, FMG60 without cooling jacket  
 B Level measurement, FMG60 with cooling jacket  
 C Point level measurement, FMG60 without cooling jacket  
 D Point level measurement, FMG60 with cooling jacket  
 E Such horizontal mounting not permitted  
 1 Retainer for pipe diameter 80 mm (3.15 in)  
 2 Retainer for water cooling jacket diameter 140 mm (5.51 in)  
 3 Retainer for pipe diameter 102 mm (4.72 in)  
 4 Bracket

**i** For horizontal mounting with cooling jacket or collimator (**see picture E**), the pipe mounting must be carried out by the customer. Make sure that the clamping forces of the mounting clamps are sufficient to prevent the FMG60 from slipping off. The dimensions are described in the chapter "FHG60 mounting device". → 78

### ⚠ CAUTION

#### Note the following when mounting the device

- ▶ The mounting device must be installed in such a way as to withstand the weight of the Gammapiilot M under all anticipated operating conditions.
- ▶ For measuring lengths of 1 600 mm (63 in) or more, two retainers (vertical) or three retainers (horizontal) must be used.
- ▶ The use of the bracket or a support unit fitted by the customer is mandatory if the device is mounted in a vertical position. Otherwise sufficient stability and support for the Gammapiilot M is not ensured.
- ▶ For stability reasons the mounting version with the terminal housing positioned at the top should only be used in exceptional cases.
- ▶ Clamping solution for pipe mounting required by the customer. Do not use supplied mounting clamps for pipe. Supplied retainers can be used for FMG60 (**see picture E**).
- ▶ To prevent damage to the tube of the Gammapiilot M, the maximum torque that can be applied to tighten the retainer screws is 6 Nm (4.42 lbf ft).

## 9.6.3 Ordering information

Detailed ordering information is available from the following sources:

- In the Product Configurator on the Endress+Hauser website: [www.endress.com](http://www.endress.com) -> Select country -> Instruments -> Select device -> Accessories for FMG60
- From an Endress+Hauser Sales Center: [www.endress.com/worldwide](http://www.endress.com/worldwide)

#### **Product Configurator - the tool for individual product configuration**

- Up-to-the-minute configuration data
- Depending on the device: Direct input of measuring point-specific information such as measuring range or operating language
- Automatic verification of exclusion criteria
- Automatic creation of the order code and its breakdown in PDF or Excel output format
- Ability to order directly in the Endress+Hauser Online Shop

## 9.7 Clamping device for density measurement FHG61

For details, see:

 [SD01221F/00/EN](#)

## 9.8 Measurement section for density measurement FHG62

For drawings and description, see:

 [SD00540F/00/EN](#)

## 9.9 Memograph M, RSG45

### 9.9.1 Measuring principle

Electronic acquisition, display, recording, analysis, remote transmission and archiving of analog and digital input signals as well as calculated values.

The device is intended for installation in a panel or cabinet door. There is also the option of operating it in a desktop housing or field housing.

### 9.9.2 Measuring system

Multichannel data recording system with multicolor TFT display (178 mm / 7" screen size), internal memory, external memory (SD card and USB stick), galvanically isolated universal inputs (U, I, TC, RTD, pulse, frequency), HART® inputs, digital inputs, transmitter power supply, limit relays, digital and analog outputs, communication interfaces (USB, Ethernet, RS232/485), optionally available with Modbus, Profibus DP or PROFINET I/O or EtherNet/IP.



An Essential Version of the Field Data Manager (FDM) software is included for SQL-supported data analysis on the PC.

 The number of inputs available in the basic device can be individually increased using a maximum of 5 plug-in cards. The device supplies power directly to connected two-wire transmitters. The device is configured and operated via the navigator (jog/shuttle dial) or by touchscreen (optional) using the integrated web server and a PC, an external USB keyboard or mouse or with the FieldCare/Device Care configuration software. Online help supports the user during local operation.

 **Ex version:**

- The hazardous area version (Ex version) is only available in conjunction with the stainless steel front and touch control.
- In this version, the SD card is integrated in the device and cannot be removed. The card can be read out using the Field Data Manager (FDM) software supplied via USB or Ethernet or via WebDAV.

**For more information, see:**

 TI01180R

 BA01338R

## 9.10 RMA42, process transmitter with control unit

### 9.10.1 Measuring principle

The RMA42 process transmitter powers the transmitter and processes analog signals from transmitters, particularly from the area of process instrumentation. These signals are monitored, evaluated, calculated, saved, separated, linked, converted and displayed. The signals, intermediate values and the results of calculations and analysis are transmitted by digital or analog means.

### 9.10.2 Measuring system

The RMA42 is a process transmitter that is controlled by a microcontroller and features a display, analog inputs for process and status signals, analog and digital outputs, as well as a configuration interface.

Connected sensors can be powered by the integrated transmitter power supply system. The signals to be measured are converted from analog to digital signals, processed digitally in the device, and then converted from digital to analog signals and made available at the various outputs. All measured values, and values calculated in any way, are available as a signal source for the display, all outputs, relays and the interface. It is possible to make multiple use of the signals and results (e.g. a signal source is used as an analog output signal and as a limit value for a relay).

**For more information, see:**

 TI00150R

 BA00287R

# 10 Troubleshooting

## 10.1 System error messages

### 10.1.1 Error signal



Errors occurring during commissioning or operation are signaled in the following way:

- Error symbol, error code and error description on the display and operating module.
- Current output, configurable ("**Output on alarm (\*20)**" function):
  - MAX, 110%, 22 mA
  - MIN, -10%, 3.6 mA
  - Hold (the last value is held)
  - User-specific value

### 10.1.2 Last error

The last error is displayed in the "**Previous error**" (\*A1) function in the "**Diagnostics**" (\*A) function group. This can be deleted in the "**Delete last error**" (\*A2) function.

### 10.1.3 Types of error

Type of error	Symbol	Symbol
Alarm (A)	 Continuous	The output signal adopts a value that can be set using the "Output on alarm" (*10) function: <ul style="list-style-type: none"> <li>▪ MAX, 110%, 22 mA</li> <li>▪ MIN, -10%, 3.8 mA</li> <li>▪ Hold (the last value is held)</li> <li>▪ User-specific value</li> </ul> An error message is displayed
Warning (W)	 Flashing	The device continues to measure. An error message is displayed (alternating with the measured value)

### 10.1.4 Error codes

Code	Error description	Remedial action
A102	Checksum error	Contact Endress+Hauser Service
W103	Initializing	Wait for the initialization procedure to finish
A106	Downloading	Wait for the download to finish
A110	Checksum error	Contact Endress+Hauser Service
A111	Electronics defect	Switch device off/on; If the error persists: contact Endress+Hauser Service or replace the transmitter
A113	Electronics defect	Switch device off/on; If the error persists: contact Endress+Hauser Service or replace the transmitter
A114	Electronics defect	Switch device off/on; If the error persists: contact Endress+Hauser Service or replace the transmitter
A116	Download error	Repeat download

Code	Error description	Remedial action
A121	Electronics defect	Switch device off/on; If the error persists: contact Endress+Hauser Service or replace the transmitter
W153	Initializing	Wait for the initialization procedure to finish
A160	Checksum error	Contact Endress+Hauser Service
A165	Electronics defect	<ul style="list-style-type: none"> <li>▪ Switch device off/on; If the error persists: contact Endress+Hauser Service or replace the transmitter</li> <li>▪ See note regarding "Error messages A165 "Electronics defect" and A635 "Present date not defined"</li> </ul>
A291	Slave error	Check that the basic setup is correct and that the slave transmitter has been connected correctly
A503	Wrong sensor type	Contact Endress+Hauser Service
W513	Calibration integration running	Wait until the pulse rate has stabilized; then terminate the integration (by pressing  in the "Average pulse rate (*11) function)
W514	Pt100 calibration	Wait for the calibration to finish. If the error persists: contact Endress+Hauser Service
A531	Sensor electronics defect	Switch device off/on; If the error persists: contact Endress+Hauser Service or replace the transmitter
A532	Sensor voltage error	Contact Endress+Hauser Service
A533	Wrong sensor software version	Contact Endress+Hauser Service
A535	Sensor regulation error	Contact Endress+Hauser Service
W536	High voltage near limit	Contact Endress+Hauser Service
A538	Sensor communication error	Contact Endress+Hauser Service
A602	Linearization table not plausible	Check monotony of the linearization table; if necessary, correct the table (" <b>Linearization</b> " (*4) function group)
A612	Linearization table not defined	Enter or complete the linearization table (" <b>Linearization</b> " (*4) function group). The linearization table must contain the end points 0% = 1000 cps (standardized) and 100% = 0 cps (standardized). When entering the table via FieldCare, select the right type of table (lin tab. "Level" or "Concentration")
W621	Simulation on	Switch off simulation (" <b>Output</b> " (*6) function group, " <b>Simulation</b> " (*65) function)
W640	SIL lock device	SIL_locking not completed
W642	I_back calibration running	Calibration of the current readback path active
A631	Background not calibrated	Perform background calibration (" <b>Calibration</b> " (*1) function group)
A632	Full/covered not calibrated	Perform full/covered calibration (" <b>Calibration</b> " (*1) function group)
A633	Empty/free not calibrated	Perform empty/free calibration (" <b>Calibration</b> " (*1) function group)
A634	Density not calibrated	<ul style="list-style-type: none"> <li>▪ Check: has at least one calibration point been entered and activated? If not: enter and activate calibration point(s). ("<b>Calibration</b>" (*1) function group)</li> <li>▪ Check: is the "reference pulse rate" (*1F) greater than 2<sup>32</sup>? If so: perform density calibration again ("<b>Calibration</b>" (*1) function group)</li> </ul>
A635	Present date not defined	<ul style="list-style-type: none"> <li>▪ Enter present date ("<b>Basic setup</b>" (*0) function group, "<b>Today's date</b>" (*01) function)</li> <li>▪ See note regarding "Error messages A165 "Electronics defect" and A635 "Present date not defined"</li> </ul>

Code	Error description	Remedial action
A636	Calibration date not plausible	Check calibration date and enter it again ("System parameters" (*C) function group, "Calibration date" (*C7) function)
A637	Operating mode not defined	Enter operating mode ("Basic setup" (*0) function group, "Operating mode" (*04) function)
A638	Measuring mode not defined	Enter measuring mode ("Basic setup" (*0) function group, "Measuring mode" (*05) function)
A639	Temperature compensation not complete	Enter at least two "temperature - density" value pairs ("Temperature compensation" (*3) function group)
W662	High sensor temperature (warning)	Install water cooling jacket or thermal shielding
A663	Sensor temperature too high (alarm)	Install water cooling jacket or thermal shielding
A664	Temperature measurement error	Check the correct functioning and connection of the Pt100 sensor
W681	Current out of range (3.8 to 20.5 mA)	Check calibration and linearization
A692	Gammagraphy detected (alarm)	<ul style="list-style-type: none"> <li>▪ Check whether interference radiation is present or the "Hold time" (*54) is too short.</li> <li>▪ If no interference radiation is present: decrease gammagraphy sensitivity ("Gammagraphy" (*5) function group, "Sensitivity" (*52) function)</li> </ul>
W693	Gammagraphy detected (warning)	Wait for the end of the gammagraphy measurement
W695	Measurement counter overflow	The local dose rate is too high (where applicable, reduce with blind flange)

## 10.2 Possible calibration errors

Error	Possible reasons	Solution
Pulse rate too low at empty vessel	Radiation source switched off	Switch on source at the source container
	Incorrect alignment of radiation beam	Realign beam
	Buildup in the vessel	Clean vessel or Recalibrate (if buildup is stable)
	Fittings in the vessel have not been considered in the activity calculation	Recalculate activity and change source if required
	Pressure in the vessel has not been considered in the activity calculation	Recalculate activity and change source if required
	No radiation source in the source container	Load source capsule in the container
	Source too weak	Use source with higher activity
Pulse rate too high at empty vessel	Activity too high	Attenuate radiation, e.g. by mounting a steel plate in front of the source container; or exchange source
	External radiation sources present (e.g. from gammagraphy)	Shield off if possible; repeat calibration without external radiation source
Pulse rate too high at full vessel	External radiation sources present (e.g. from gammagraphy)	Shield off if possible; repeat calibration without external radiation source

### 10.3 Software history

Date	Software version	Software modification	Documentation
Since 09.2004	01.01.02	Original software	<ul style="list-style-type: none"> <li>■ BA00236F/00/en/08.04, 52023878</li> <li>■ BA00287F/00/en/08.04, 52023818</li> </ul>
Since 11.2005	01.01.04	Bug fix. Concentration mode corrected. Density measurement recalibration corrected.	
Since 08.2006	01.01.06	Bug fix. Corrections for high and low pulse rate.	
Since 04.2007	01.02.00	Software extended to include "SIL locking" function	<ul style="list-style-type: none"> <li>■ BA00236F/00/en/03.07, 71041166</li> <li>■ BA00287F/00/en/04.07, 71041169</li> </ul>
	01.02.02		<ul style="list-style-type: none"> <li>■ BA00236F/00/en/06.07, 71041166</li> <li>■ BA00287F/00/en/06.07, 71041169</li> </ul>
Since 08.2008	01.03.00	Automatic restart after error A165 caused by empty pipe during density measurement (pulse rate > 160000 c/s)   Software version 01.02.02 is the valid software version for devices with a SIL or WHG certificate.	<ul style="list-style-type: none"> <li>■ BA00236F/00/en/09.08, 71082935</li> <li>■ BA00287F/00/en/06.07, 71041169</li> </ul>
Since 02.2009	01.03.02	New filtering function implemented for Gamma Modulator FHG65	<ul style="list-style-type: none"> <li>■ BA00236F/00/en/03.09, 71091964</li> <li>■ BA00287F/00/en/06.07, 71041169</li> </ul>
Since 10.2010	01.03.06	Improved EMC stability for extreme interferences far beyond the norm	<ul style="list-style-type: none"> <li>■ BA00236F/00/en/10.09, 71104590</li> <li>■ BA00287F/00/en/06.07, 71041169</li> </ul>

## 11 Technical data

### 11.1 Additional technical data

For additional technical data, please see

 TI00363F/00/EN

### 11.2 Supplementary documentation

The supplementary documentation is available on our product pages at "[www.endress.com](http://www.endress.com)"

- Technical Information (TI00363F/00/EN)
- Operating Instructions "Description of Device Functions" (BA00287F/00/EN)
- Functional Safety Manual:
  - For max. point level detection (SD00230F/00/EN)
  - For min. point level detection (SD00324F/00/EN)

#### 11.2.1 Clamping device for level and point level detection FHG60

For details, see

 SD01202F/00/EN

#### 11.2.2 Clamping device for density measurement FHG61

For details, see

 SD01221F/00/EN

#### 11.2.3 Measurement section for density measurement FHG62

For drawings and description, see

 SD00540F/00/EN

#### 11.2.4 Certificates and approvals

##### Safety Manual (SIL 2/3)

SIL 2/3 according to IEC 61508, see:

- SD00230F/00/EN "Functional Safety Manual" (for maximum point level detection)
- SD00324F/00/EN "Functional Safety Manual" (for min. point level detection)

##### Ex approval

The Ex certificates available are listed in the ordering information. Observe the related Safety Instructions (XA) and Control Drawings (ZD).

##### Certificates

 For the allocation of the approval to the device version, see the Product Configurator on the Endress+Hauser website: [www.endress.com](http://www.endress.com) -> Select country -> Instruments -> Select device -> Product page function: Configure this product

*General*

Approval feature 010	Type of protection	Power supply wiring/output wiring, option 030	Output (communication), option 040	Safety instructions
A	Non-hazardous area	A	1,2,3	-
F	Non-hazardous area, WHG	A	1	-
N	CSA General Purpose	A	1,2,3	-

Approval number: NEPSI GYJ15.1144

Approval feature 010	Type of protection	Power supply wiring/output wiring, option 030	Output (communication), option 040	Safety instructions
C	Ex de [ia] IIC T6	C	1	XA00536F
		C	2,3	XA01706F
		B	1	XA00536F
		B	2,3	XA00537F
D	Ex d [ia] IIC T6	D	1	XA00536F
		D	2,3	XA01706F
		E	1	XA00536F
		E	2,3	XA00537F

Approval number: IECEx DEK 13.0071X

Approval feature 010	Type of protection	Power supply wiring/output wiring, option 030	Output (communication), option 040	Safety instructions
G	Ex de [ia Ga] IIC T6 Gb	B	1	XA00449F
		B	2,3	XA00450F
		C	1	XA00449F
		C	2,3	XA00451F
H	Ex d [ia Ga] IIC T6 Gb	E	1	XA00449F
		E	2,3	XA00450F
		D	1	XA00449F
		D	2,3	XA00451F

Approval number: KEMA 04 ATEX 1153

Approval feature 010	Type of protection	Power supply wiring/ output wiring, option 030	Output (communication), option 040	Safety instructions
1	II 2(1) G Ex de [ia Ga] IIC T6 Gb	B	1	XA00303F
		B	2,3	XA00332F
		C	1	XA00303F
		C	2,3	XA00334F
2	II 2(1) G Ex de [ia Ga] IIC T6 Gb, WHG	B	1	XA00303F
		C	1	XA00303F
3	II 2(1) G Ex d [ia Ga] IIC T6 Gb	E	1	XA00303F
		E	2,3	XA00332F
		D	1	XA00303F
		D	2,3	XA00334F
4	II 2(1) G Ex d [ia Ga] IIC T6 Gb, WHG	E	1	XA00303F
		D	1	XA00303F
5	II 2(1) D Ex tb [ia Da] IIIC T80°C Db	F	1	XA00304F
		F	2,3	XA00335F
		L	1	XA00304F
		L	2,3	XA00333F
6	II 2(1) G Ex de [ia Ga] IIC T6 Gb II 2(1) D Ex tb [ia Da] IIIC T80°C Db	J	1	XA00303F XA00304F
		J	2,3	XA00332F XA00333F
		G	1	XA00303F XA00304F
		G	2,3	XA00334F XA00335F
7	II 2(1) Ex de [ia Ga] IIC T6 Gb, WHG II 2(1) D Ex tb [ia Da] IIIC T80°C Db, WHG	J	1	XA00303F XA00304F
		G	1	XA00303F XA00304F
8	II 2(1) G Ex d [ia Ga] IIC T6 Gb II 2(1) D Ex tb [ia Da] IIIC T80°C Db	K	1	XA00303F XA00304F
		K	2,3	XA00332F XA00304F
		H	1	XA00303F XA00304F
		H	2,3	XA00334F XA00335F
M	II 2(1) G Ex d [ia Ga] IIC T6 Gb, WHG II 2(1) D Ex tb [ia Da] IIIC T80°C Db, WHG	K	1	XA00303F XA00304F
		H	1	XA00303F XA00304F



Approval number: ID 3022785

Approval feature 010	Type of protection	Power supply wiring/output wiring, option 030	Output (communication), option 040	Safety instructions
S	FM Cl. I Gp. A-D, Cl. II Gp. E-G, Cl. III, Cl. I Zone 1 Ex d [ia] IIC t6	D	1	XA01100F
		D	2,3	XA01108F
		E	1	XA01102F
		E	2,3	XA01109F

Approval number: CSA 1653884

Approval feature 010	Type of protection	Power supply wiring/output wiring, option 030	Output (communication), option 040	Safety instructions
P	CSA Cl. I Gp. A-D, Cl. II Gp. E-G, Cl. III, Cl. I Zone 1 Ex d [ia] IIC T6	D	1	XA01099F
		D	2,3	XA01110F
		E	1	XA01101F
		E	2,3	XA01111F

Approval number: TC17525, TC19557 (NaI scintillator)

Approval feature 010	Type of protection	Power supply wiring/output wiring, option 030	Output (communication), option 040	Safety instructions
K	TIIS Ex d [ia] IIC T6	D	1	BA00236F

Approval number: TC17524, TC19556 (PVT scintillator)

Approval feature 010	Type of protection	Power supply wiring/output wiring, option 030	Output (communication), option 040	Safety instructions
K	TIIS Ex d [ia] IIC T6	D	1	BA00236F

### CE mark

The measuring system meets the legal requirements of the EC Directives. Endress+Hauser confirms that the device has been successfully tested by applying the CE mark.

### GOST

Approval for GOST available

### Overfill prevention

WHG (German Water Resources Act) for point level detection

## 12 Appendix

### 12.1 Operating menu for level measurements

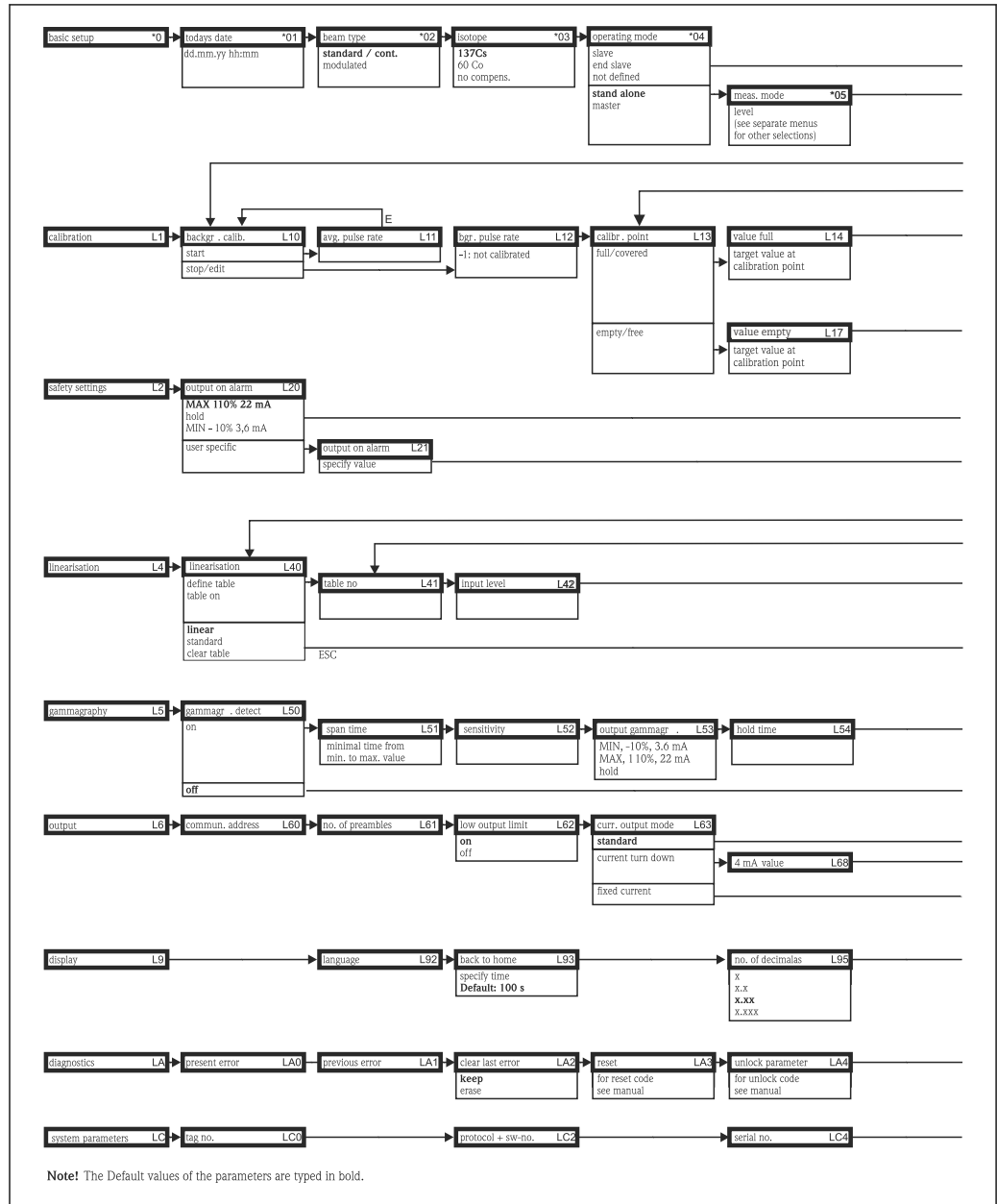

A0036819-EN

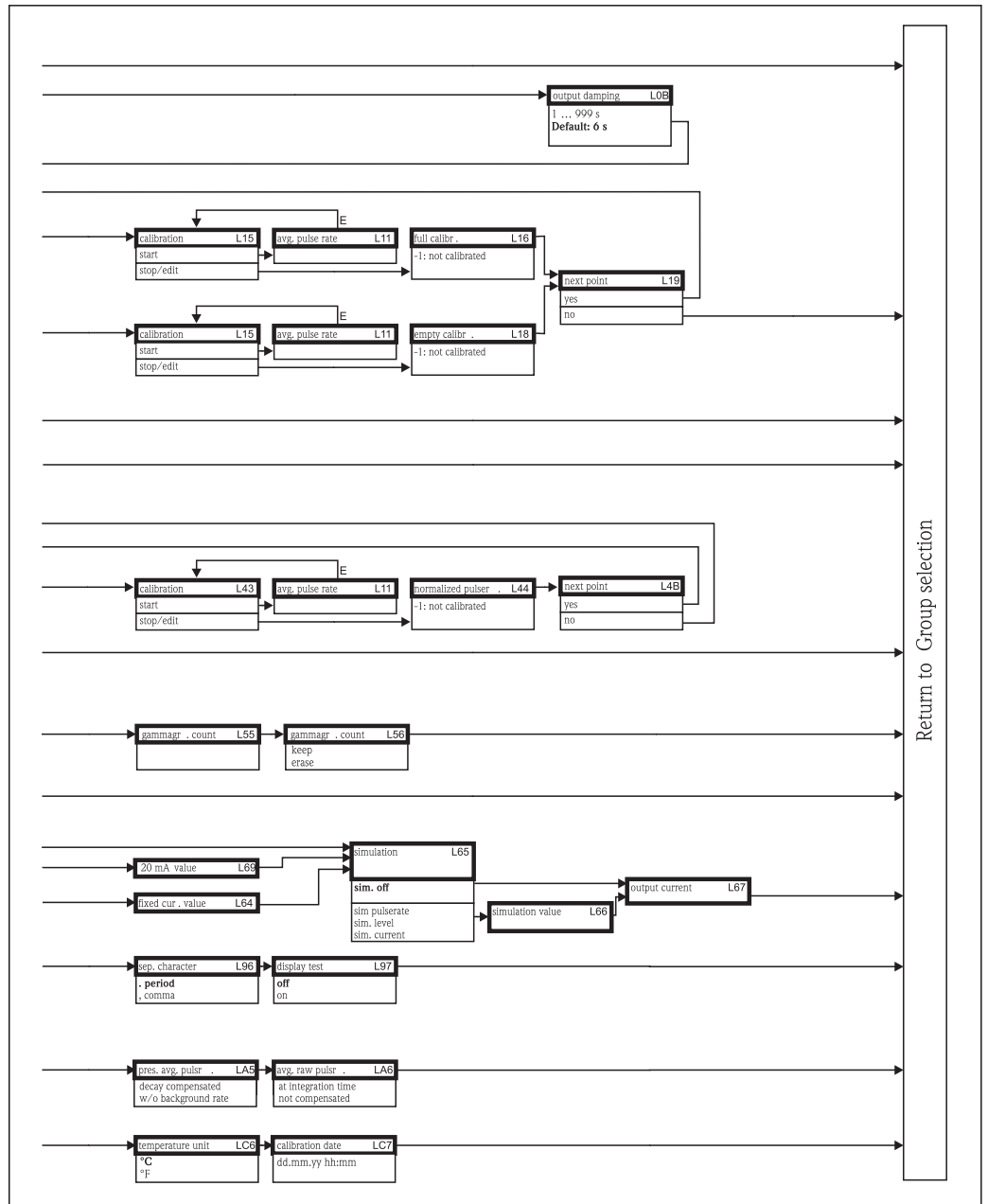

A0036820-EN

All the device functions are described in detail in the following Operating Instructions:

 BA00287F/00/EN

## 12.2 Operating menu for level limit (point level) detection

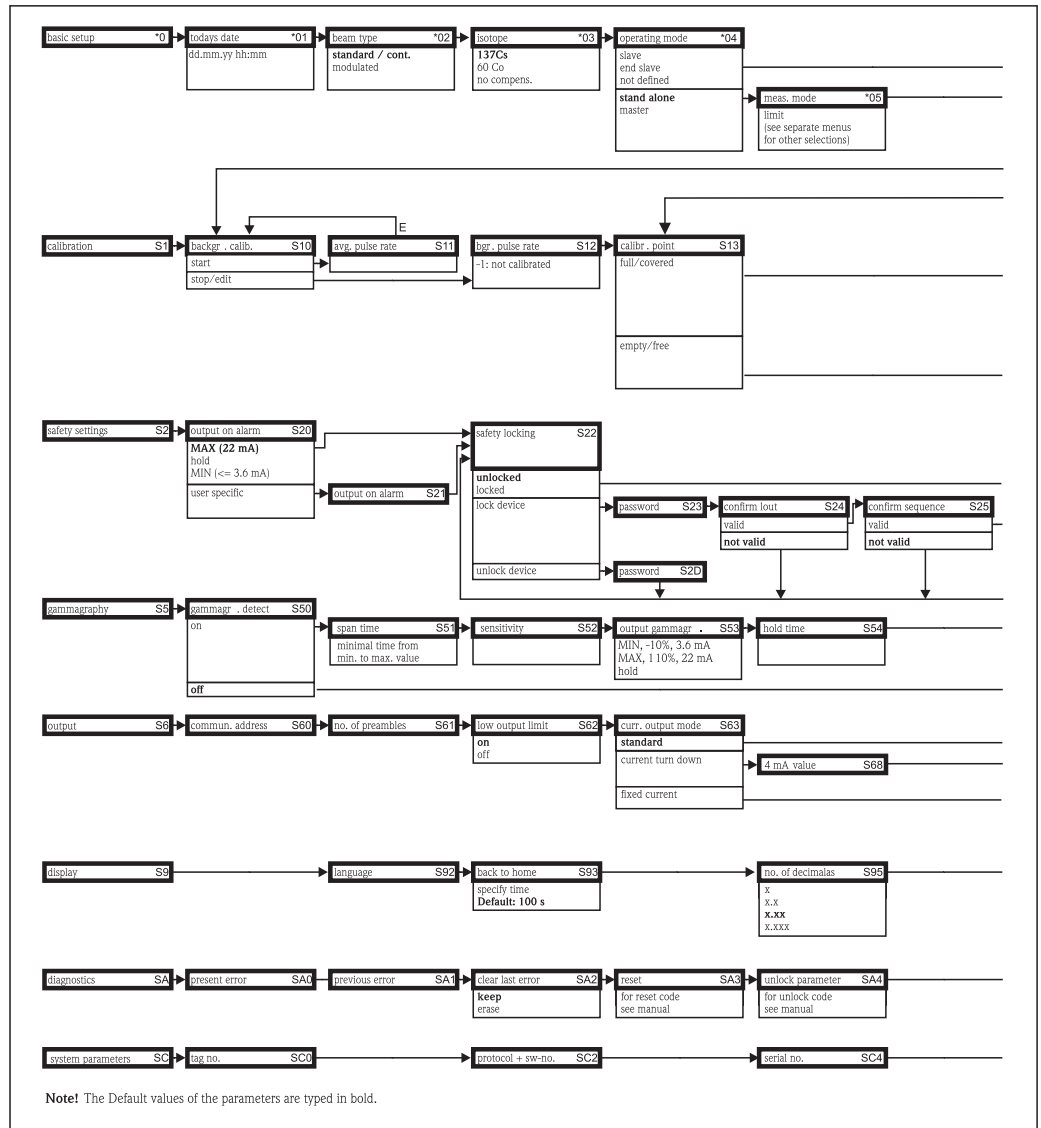

A0036821-EN

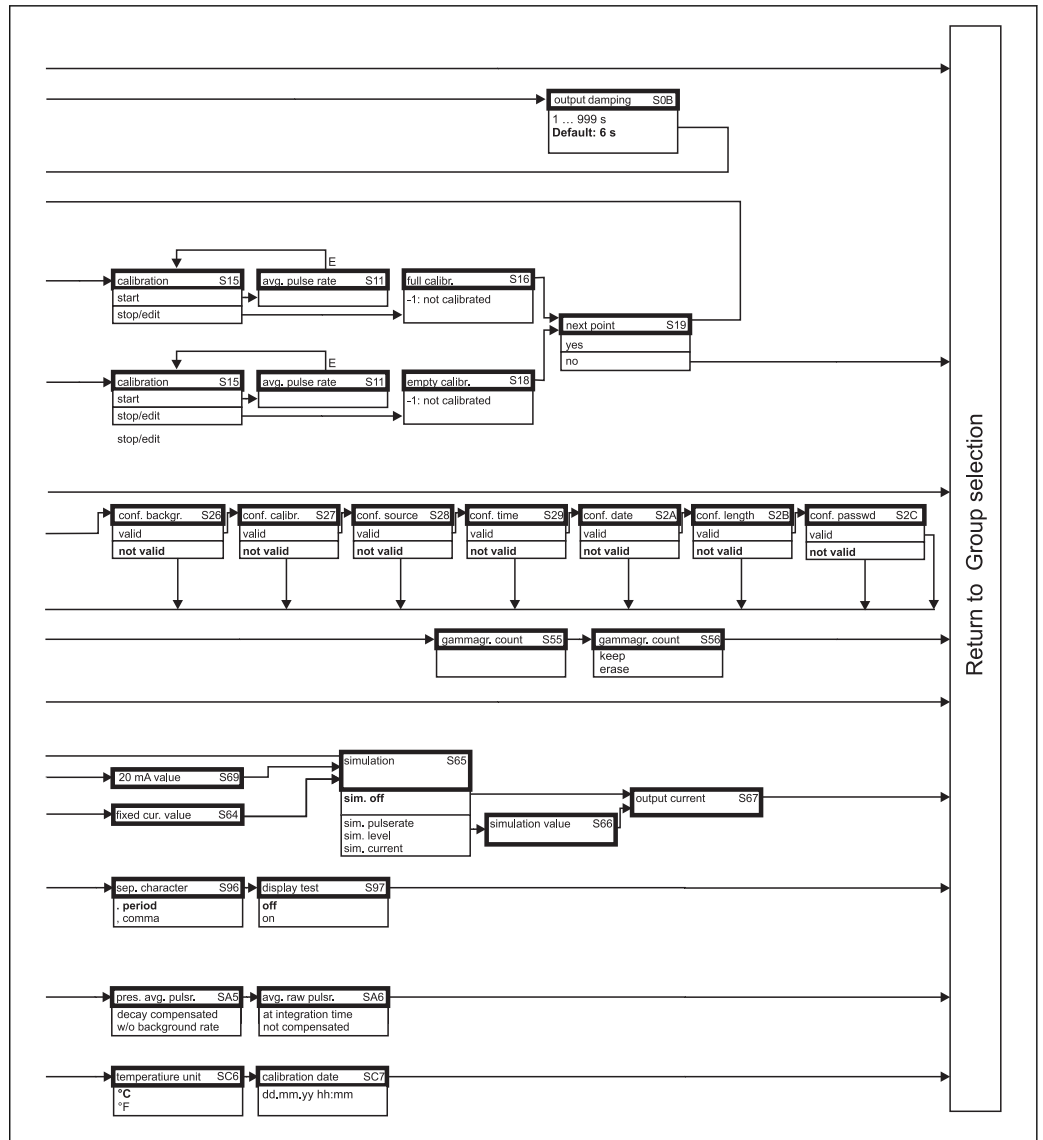

A0036822-EN

All the device functions are described in detail in the following Operating Instructions:

 BA00287F/00/EN

## 12.3 Operating menu for density and concentration measurements

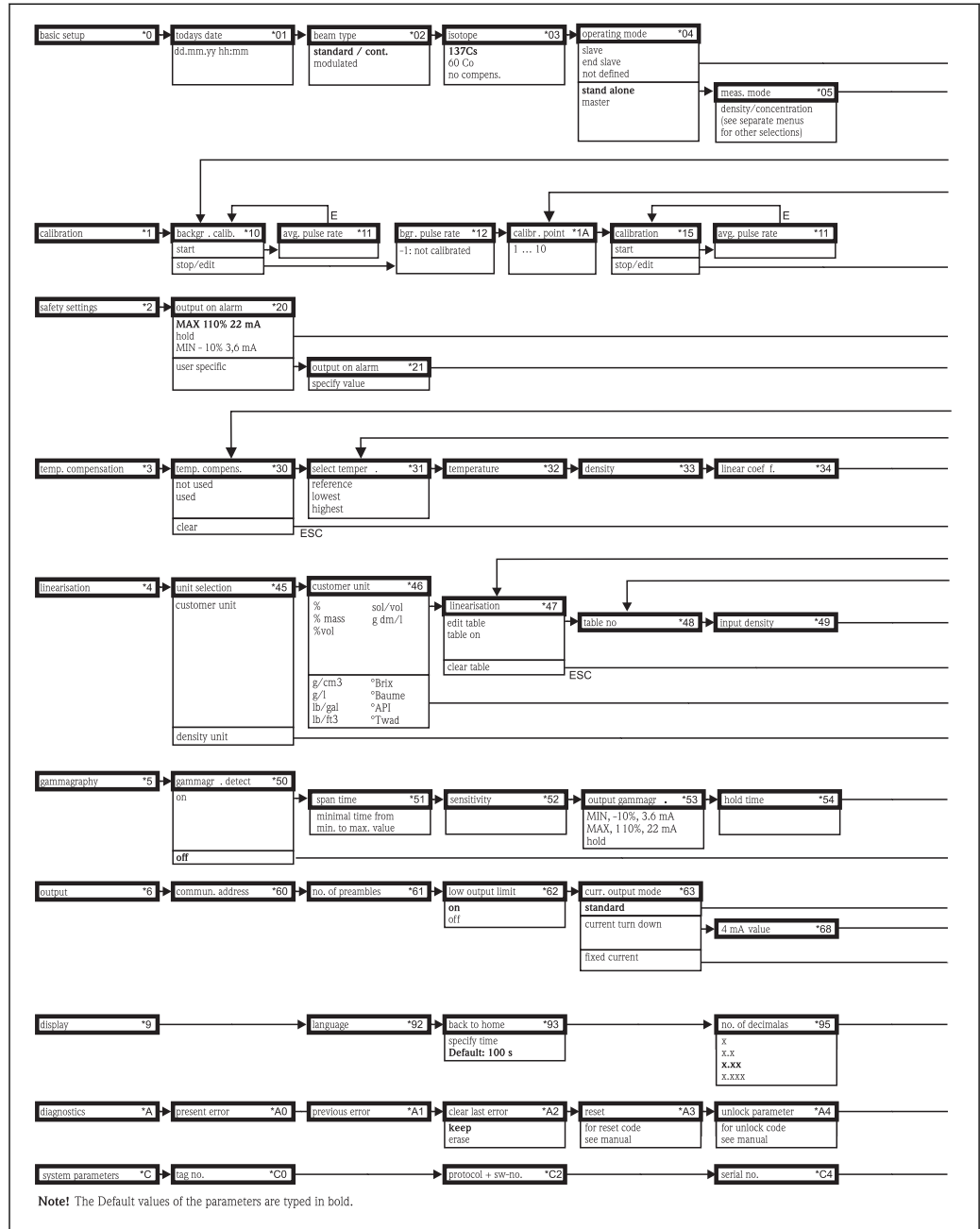

A0036823-EN

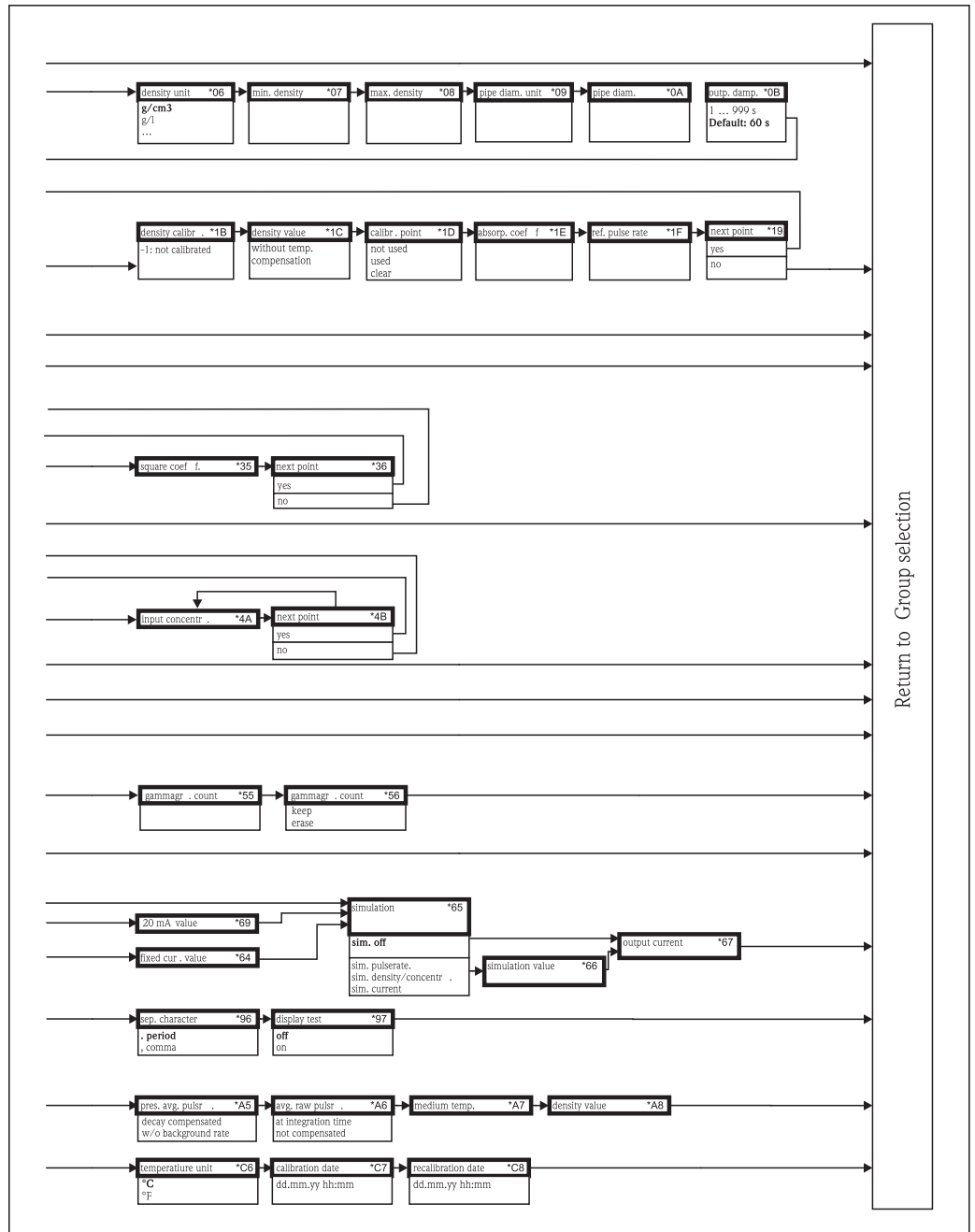

A0036824-EN

All the device functions are described in detail in the following Operating Instructions:

 BA00287F/00/EN



71401068

[www.addresses.endress.com](http://www.addresses.endress.com)

---