



Level



Pressure



Flow



Temperature

Liquid
Analysis

Registration

Systems
Components

Services



Solutions

Technical Information

Proline Prosonic Flow B 200

Ultrasonic flow measuring system

The device for accurate, reliable biogas measurement under variable process conditions



Application

- Reliable measurement of wet biogas, digester gas and landfill gas under low process pressure, low flow rates and varying gas compositions.
- The Ultrasonic measuring principle is unaffected by the gas composition.

Device properties:

- Medium temperature: 0 to 80 °C (32 to 176 °F)
- Process pressure: max. 10 bar (145 psi)
- Nominal diameter: DN 50 to 200 (2 to 8")
- Accuracy:
 - Volume flow: $\pm 1.5\%$ o.r.
 - Methane: $\pm 2\%$ abs. (optional)
- Loop powered transmitter made of aluminum or stainless steel
- Graphical local display with operation from the outside (Touch Control)
- Communication via 4-20 mA HART
- Ex approvals accepted worldwide: ATEX, IECEx, cCSA_{US}, NEPSI (intrinsically safe or explosion proof design)

Your benefits

Biogas measurement for a wide range of applications with optional real-time measurement of the biogas methane fraction combined with genuine loop-powered technology.

Sizing – correct product selection

Applicator - the reliable, easy-to-use tool for selecting and sizing measuring devices for every application

Installation – simple and efficient

- Short inlet and outlet runs
- Reduced wiring thanks to loop-powered technology

Commissioning – reliable and intuitive

Guided parameterization ("Make-it-run" Wizards)

Operation – increased measurement availability

- Multivariable measurement: volume flow and, optionally, methane fraction and temperature
- No pressure loss
- Diagnostic capability
- Automatic data restore by HistoROM

Cost-effective Life Cycle Management by W@M







Table of contents

Document information	3	Process	24
Symbols used	3	Medium temperature range	24
Function and system design	4	Pressure-temperature ratings	24
Measuring principle	4	Flow limit	25
Measuring system	5	Pressure loss	25
Input	6	System pressure	25
Measured variable	6	Thermal insulation	25
Measuring range	6	Mechanical construction	25
Operable flow range	6	Design, dimensions	25
Input signal	7	Weight	31
Output	7	Materials	33
Output signal	7	Process connections	35
Signal on alarm	8	Operability	35
Load	9	Operating concept	35
Ex connection data	10	Local operation	35
Low flow cut off	12	Remote operation	36
Galvanic isolation	12	Certificates and approvals	37
Protocol-specific data	12	CE mark	37
Power supply	13	C-Tick symbol	37
Terminal assignment	13	Ex approval	37
Supply voltage	14	Pressure Equipment Directive	38
Power consumption	14	Other standards and guidelines	38
Current consumption	14	Ordering information	39
Power supply failure	14	Application packages	39
Electrical connection	15	Diagnostics functions	39
Potential equalization	17	Accessories	39
Terminals	17	Device-specific accessories	39
Cable entries	17	Communication-specific accessories	40
Cable specification	17	Service-specific accessories	41
Overvoltage protection	17	System components	41
Performance characteristics	17	Documentation	42
Reference conditions	17	Standard documentation	42
Maximum measured error	18	Supplementary device-dependent documentation	42
Repeatability	18	Registered trademarks	42
Response time	18		
Influence of ambient temperature	18		
Installation	19		
Mounting location	19		
Orientation	19		
Inlet and outlet runs	20		
Special mounting instructions	21		
Environment	22		
Ambient temperature range	22		
Storage temperature	23		
Degree of protection	23		
Shock resistance	23		
Vibration resistance	24		
Electromagnetic compatibility (EMC)	24		







Document information

Symbols used

Electrical symbols



Symbol	Meaning
 A0011197	Direct current A terminal to which DC voltage is applied or through which direct current flows.
 A0011198	Alternating current A terminal to which alternating voltage is applied or through which alternating current flows.
 A0017381	Direct current and alternating current <ul style="list-style-type: none"> ■ A terminal to which alternating voltage or DC voltage is applied. ■ A terminal through which alternating current or direct current flows.
 A0011200	Ground connection A grounded terminal which, as far as the operator is concerned, is grounded via a grounding system.
 A0011199	Protective ground connection A terminal which must be connected to ground prior to establishing any other connections.
 A0011201	Equipotential connection A connection that has to be connected to the plant grounding system: This may be a potential equalization line or a star grounding system depending on national or company codes of practice.

Symbols for certain types of information

Symbol	Meaning
 A0011182	Allowed Indicates procedures, processes or actions that are allowed.
 A0011183	Preferred Indicates procedures, processes or actions that are preferred.
 A0011184	Forbidden Indicates procedures, processes or actions that are forbidden.
 A0011193	Tip Indicates additional information.
 A0011194	Reference to documentation Refers to the corresponding device documentation.
 A0011195	Reference to page Refers to the corresponding page number.
 A0011196	Reference to graphic Refers to the corresponding graphic number and page number.

Symbols in graphics

Symbol	Meaning
1, 2, 3, ...	Item numbers
1., 2., 3., ...	Series of steps
A, B, C, ...	Views
A-A, B-B, C-C, ...	Sections
 A0013441	Flow direction

Symbol	Meaning
 A0011187	Hazardous area Indicates a hazardous area.
 A0011188	Safe area (non-hazardous area) Indicates a non-hazardous area.

Function and system design

Measuring principle

A Prosonic Flow inline flowmeter measures the flow rate of the passing fluid by using sensor pairs located on opposite sides of the meter body and at an angle so that one of the sensors in the pair is slightly downstream. The design is non-invasive and does not have any moving parts.

The flow signal is established by alternating an acoustic signal between the sensor pairs and measuring the time of flight of each transmission. Then utilizing the fact that sound travels faster with the flow versus against the flow, this differential time (ΔT) can be used to determine the fluids velocity between the sensors.

The volume flow rate is established by combining all the flow velocities determined by the sensor pairs with the cross sectional area of the meter body and extensive knowledge about fluid flow dynamics. The design of the sensors and their position ensures that only a short straight run of pipe upstream of the meter is required after typical flow obstructions such as bends in one or two planes.

Advance digital signal processing facilitates constant validation of the flow measurement reducing susceptibility to multiphase flow conditions and increases the reliability of the measurement.

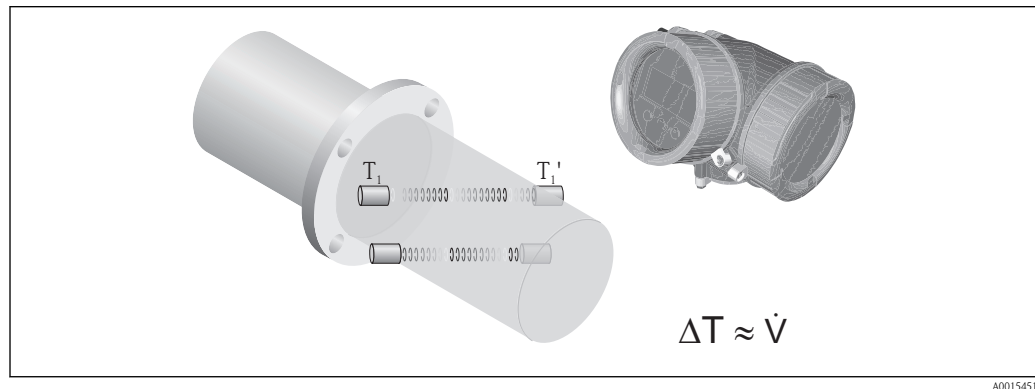

A0015451

Direct measurement of the methane fraction (CH₄)

The sound velocity, temperature and chemical composition of a gas are directly related to one another. If two of these characteristic quantities are known, the third can be calculated. The higher the gas temperature or the methane fraction, the higher the sound velocity in biogas, for example.

Since the measuring device accurately measures both the sound velocity and the current gas temperature, the methane fraction can be calculated directly and displayed on site without the need for an additional measuring instrument.

The relative humidity of biogas is usually 100 %. Thus, the water content can be determined by the temperature measurement and can be compensated for.

The measuring device is unique in its ability to measure the methane fraction directly, making it possible to monitor the gas flow and gas quality 24/7. In this way, operators of a biogas plant, for example, can react swiftly and specifically to problems in the digestion process.

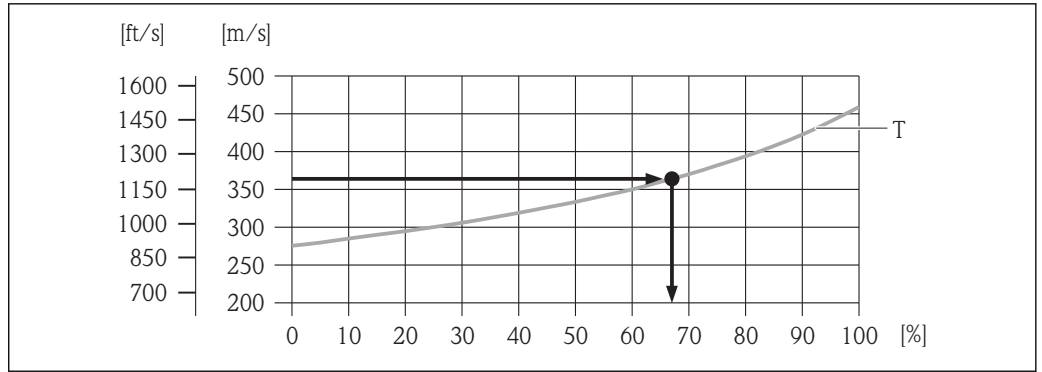

1 Calculation of the methane fraction [%] based on the sound velocity [m/s (ft/s)] and a temperature T of 40 °C (104 °F), for example

Measuring system

The device consists of a transmitter and a sensor.

One device version is available: compact version, transmitter and sensor form a mechanical unit.

Transmitter

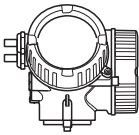
<p>Prosonic Flow 200</p>  <p style="text-align: right; font-size: small;">A0013471</p>	<p>Materials:</p> <ul style="list-style-type: none"> ■ Stainless steel 1.4404/316L ■ Aluminum coated AlSi10Mg <p>Configuration:</p> <ul style="list-style-type: none"> ■ External operation via four-line, illuminated local display with touch control and guided menus ("Make-it-run" wizards) for applications ■ Via operating tools (e.g. FieldCare)
---	--

Sensor

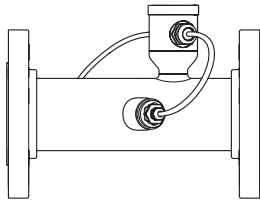
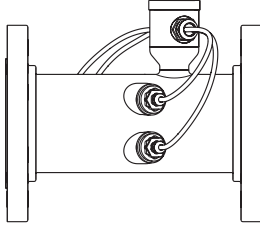
<p>Prosonic Flow B</p> <p><i>Single-path version: DN 50 (2"), DN 80 (3")</i></p>  <p style="text-align: right; font-size: small;">A0015826</p>	<ul style="list-style-type: none"> ■ Designed exclusively to measure: <ul style="list-style-type: none"> - Biogas - Coal seam gas - Air - Methane - Nitrogen - Gas with a very high methane fraction ■ Range of nominal diameter: DN 50 to 200 (2 to 8") ■ Materials: <ul style="list-style-type: none"> - Sensor: <ul style="list-style-type: none"> Stainless steel 1.4404/316L, cold worked Stainless steel 1.4435/316L, cold worked - Process connections: <ul style="list-style-type: none"> Stainless steel 1.4301/304, Stainless steel 1.4306/304L, Stainless steel 1.4404/316L, Steel S235JR, Carbon steel A105
<p><i>Two-path version: DN 100 to 200 (4 to 8")</i></p>  <p style="text-align: right; font-size: small;">A0015452</p>	

Input

Measured variable

Direct measured variables

Volume flow

Calculated measured variables

- Corrected volume flow
- Mass flow

Optional measured variables (can be ordered)

Order code for "Sensor version", option 2 "Volume flow + Biogas analysis"

- Corrected methane volume flow
- Energy flow
- Methane fraction
- Gross calorific value
- Wobbe index
- Temperature

Measuring range



Standard (Order code for "Calibration Flow", option 1 "Operable flow range 30 : 1")

Nominal diameter		Velocity		Effective volume flow	
[mm]	[in]	[m/s]	[ft/s]	[m ³ /h]	[ft ³ /h]
50	2	1 to 30	3.28 to 98.4	9 to 269	316 to 9 495
80	3	1 to 30	3.28 to 98.4	20 to 611	720 to 21 592
100	4	1 to 30	3.28 to 98.4	34 to 1 032	1 215 to 36 443
150	6	1 to 30	3.28 to 98.4	76 to 2 290	2 695 to 80 862
200	8	1 to 30	3.28 to 98.4	131 to 3 925	4 620 to 138 596

Optional (Order code for "Calibration Flow", option 2 "Operable flow range 100 : 1")

Nominal diameter		Velocity		Effective volume flow	
[mm]	[in]	[m/s]	[ft/s]	[m ³ /h]	[ft ³ /h]
50	2	0.3 to 30	0.98 to 98.4	3 to 269	95 to 9 495
80	3	0.3 to 30	0.98 to 98.4	6 to 611	215 to 21 592
100	4	0.3 to 30	0.98 to 98.4	11 to 1 032	363 to 36 443
150	6	0.3 to 30	0.98 to 98.4	25 to 2 290	805 to 80 862
200	8	0.3 to 30	0.98 to 98.4	43 to 3 925	1 365 to 138 596

The values in the table should only be regarded as reference values.

 To calculate the measuring range, use the *Applicator* sizing tool (→  41)

Recommended measuring range

"Flow limit" section (→  25)

Operable flow range

- 30 : 1 (standard; order code for "Calibration Flow", option 1 "Operable flow range 30 : 1")
- 100 : 1 (optional; order code for "Calibration Flow", option 2 "Operable flow range 100 : 1")



Flow rates above the preset full scale value do not overload the amplifier so the totalized values are registered correctly.

Input signal

HART protocol

To increase the accuracy of certain measured variables, a measured pressure value can be used instead of a fixed process pressure. For this purpose, the measuring device continuously reads in the process pressure from a pressure transmitter (e.g. Cerabar M or Cerabar S) via the HART protocol.

The pressure transmitter must support the following protocol-specific functions:

- HART protocol
- Burst mode
- Endress+Hauser recommends the use of an absolute pressure transmitter
-  ■ Various pressure transmitters can be ordered from Endress+Hauser: see "Accessories" section (→  41)
 - Please comply with the special mounting instructions when using pressure transmitters (→  21)

External pressure compensation is recommended to calculate the following measured variables:

- Corrected volume flow
- Corrected methane volume flow
- Mass flow
- Energy flow



Output

Output signal

Current output

Current output 1	4-20 mA HART (passive)
Current output 2	4-20 mA (passive)
Resolution	< 1 µA
Damping	Adjustable: 0.07 to 999 s
Assignable measured variables	<ul style="list-style-type: none"> ■ Volume flow ■ Corrected volume flow ■ Corrected methane volume flow ■ Mass flow ■ Energy flow ■ Methane fraction ■ Gross calorific value ■ Wobbe index ■ Temperature

Pulse/frequency/switch output

Function	Can be set to pulse, frequency or switch output
Version	Passive, open collector
Maximum input values	<ul style="list-style-type: none"> ■ DC 35 V ■ 50 mA  For information on the Ex connection values (→  10)
Voltage drop	<ul style="list-style-type: none"> ■ For ≤ 2 mA: 2 V ■ For 10 mA: 8 V
Residual current	≤ 0.05 mA
Pulse output	
Pulse width	Adjustable: 5 to 2000 ms
Maximum pulse rate	100 Impulse/s
Pulse value	Adjustable

Assignable measured variables	<ul style="list-style-type: none"> ■ Volume flow ■ Corrected volume flow ■ Corrected methane volume flow ■ Mass flow ■ Energy flow
Frequency output	
Output frequency	Adjustable: 0 to 1 000 Hz
Damping	Adjustable: 0 to 999 s
Pulse/pause ratio	1:1
Assignable measured variables	<ul style="list-style-type: none"> ■ Volume flow ■ Corrected volume flow ■ Corrected methane volume flow ■ Mass flow ■ Energy flow ■ Methane fraction ■ Gross calorific value ■ Wobbe index ■ Temperature
Switch output	
Switching behavior	Binary, conductive or non-conductive
Switching delay	Adjustable: 0 to 100 s
Number of switching cycles	Unlimited
Assignable functions	<ul style="list-style-type: none"> ■ Off ■ On ■ Diagnostic behavior ■ Limit value <ul style="list-style-type: none"> – Volume flow – Corrected volume flow – Corrected methane volume flow – Mass flow – Energy flow – Methane fraction – Gross calorific value – Wobbe index – Temperature – Totalizer 1 to 3 ■ Flow direction monitoring ■ Status <ul style="list-style-type: none"> Low flow cut off

Signal on alarm

Depending on the interface, failure information is displayed as follows:

Current output

4-20 mA

Failure mode	Selectable (as per NAMUR recommendation NE 43): <ul style="list-style-type: none"> ■ Minimum value: 3.6 mA ■ Maximum value: 22 mA ■ Defined value: 3.59 to 22.5 mA ■ Actual value ■ Last valid value
---------------------	---

HART

Device diagnostics	Device condition can be read out via HART Command 48
---------------------------	--

Pulse/frequency/switch output

Pulse output	
Failure mode	Choose from: <ul style="list-style-type: none"> ■ Actual value ■ No pulses
Frequency output	
Failure mode	Choose from: <ul style="list-style-type: none"> ■ Actual value ■ Defined value: 0 to 1250 Hz ■ 0 Hz
Switch output	
Failure mode	Choose from: <ul style="list-style-type: none"> ■ Current status ■ Open ■ Closed

Local display



Plain text display	With information on cause and remedial measures
Backlight	Additionally for device version with SD03 local display: red lighting indicates a device error.

 Status signal as per NAMUR recommendation NE 107

Operating tool

- Via digital communication:
 - HART protocol
- Via service interface

Plain text display	With information on cause and remedial measures
--------------------	---

 Additional information on remote operation (→  36)

Load

Load for current output: 0 to 500 Ω, depending on the external supply voltage of the power supply unit

Calculation of the maximum load

Depending on the supply voltage of the power supply unit (U_S), the maximum load (R_B) including line resistance must be observed to ensure adequate terminal voltage at the device. In doing so, observe the minimum terminal voltage (→  14)

- For $U_S = 16.0$ to 16.8 V: $R_B \leq (U_S - 16.0 \text{ V}) : 0.0036 \text{ A}$
- For $U_S = 16.8$ to 23.0 V: $R_B \leq (U_S - 12.0 \text{ V}) : 0.022 \text{ A}$
- For $U_S = 23.0$ to 30.0 V: $R_B \leq 500 \text{ } \Omega$

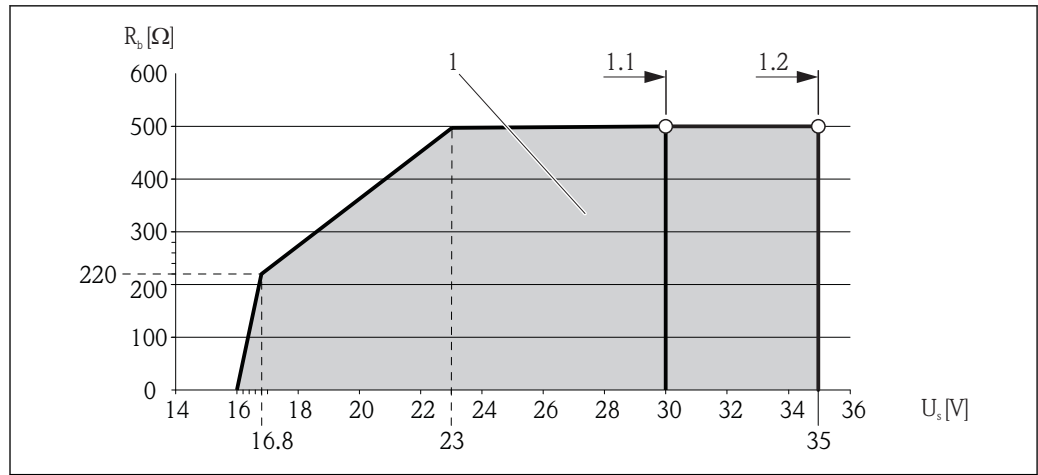

A0018972

1 Operating range

1.1 For order code for "Output", option A "4-20 mA HART"/option B "4-20 mA HART, pulse/frequency/switch output" with Ex i and option C "4-20 mA HART, 4-20 mA"

1.2 For order code for "Output", option A "4-20 mA HART"/option B "4-20 mA HART, pulse/frequency/switch output" with non-Ex and Ex d

Sample calculation

Supply voltage of the power supply unit: $U_s = 17.5 \text{ V}$

Maximum load: $R_B \leq (17.5 \text{ V} - 12.0 \text{ V}) : 0.022 \text{ A} = 250 \text{ } \Omega$

Ex connection data

Safety-related values

Ex d type of protection

Order code for "Output"	Output type	Safety-related values
Option A	4-20mA HART	$U_{nom} = \text{DC } 35 \text{ V}$ $U_{max} = 250 \text{ V}$
Option B	4-20mA HART	$U_{nom} = \text{DC } 35 \text{ V}$ $U_{max} = 250 \text{ V}$
	Pulse/frequency/switch output	$U_{nom} = \text{DC } 35 \text{ V}$ $U_{max} = 250 \text{ V}$ $P_{max} = 1 \text{ W}^{1)}$

1) Internal circuit limited by $R_i = 760.5 \text{ } \Omega$

Option C	<ul style="list-style-type: none"> ■ 4-20mA HART ■ 4-20mA 	$U_{nom} = \text{DC } 30 \text{ V}$ $U_{max} = 250 \text{ V}$
----------	---	--

Type of protection XP

Order code for "Output"	Output type	Safety-related values
Option A	4-20mA HART	$U_{nom} = \text{DC } 35 \text{ V}$ $U_{max} = 250 \text{ V}$
Option B	4-20mA HART	$U_{nom} = \text{DC } 35 \text{ V}$ $U_{max} = 250 \text{ V}$
	Pulse/frequency/switch output	$U_{nom} = \text{DC } 35 \text{ V}$ $U_{max} = 250 \text{ V}$ $P_{max} = 1 \text{ W}^{1)}$

1) Internal circuit limited by $R_i = 760.5 \text{ } \Omega$

Option C	<ul style="list-style-type: none"> ■ 4-20mA HART ■ 4-20mA 	$U_{nom} = DC\ 30\ V$ $U_{max} = 250\ V$
----------	---	---

Type of protection NI

Order code for "Output"	Output type	Safety-related values
Option A	4-20mA HART	$U_{nom} = DC\ 35\ V$
Option B	4-20mA HART	$U_{nom} = DC\ 35\ V$
	Pulse/frequency/switch output	$U_{nom} = DC\ 35\ V$
Option C	<ul style="list-style-type: none"> ■ 4-20mA HART ■ 4-20mA 	$U_{nom} = DC\ 30\ V$

Type of protection NIFW

Order code for "Output"	Output type	Intrinsically safe values
Option A	4-20mA HART	$U_i = DC\ 35\ V$ $I_i = n.a.$ $P_i = 1\ W$ $L_i = 0\ \mu H$ $C_i = 5\ nF$
Option B	4-20mA HART	$U_i = DC\ 35\ V$ $I_i = n.a.$ $P_i = 1\ W$ $L_i = 0\ \mu H$ $C_i = 5\ nF$
	Pulse/frequency/switch output	$U_i = DC\ 35\ V$ $I_i = n.a.$ $P_i = 1\ W$ $L_i = 0\ \mu H$ $C_i = 6\ nF$
Option C	<ul style="list-style-type: none"> ■ 4-20mA HART ■ 4-20mA 	$U_i = DC\ 30\ V$ $I_i = n.a.$ $P_i = 1\ W$ $L_i = 0\ \mu H$ $C_i = 30\ nF$

Intrinsically safe values

type of protection Ex ia

Order code for "Output"	Output type	Intrinsically safe values
Option A	4-20mA HART	$U_i = DC\ 30\ V$ $I_i = 300\ mA$ $P_i = 1\ W$ $L_i = 0\ \mu H$ $C_i = 5\ nF$

Option B	4-20mA HART	$U_i = DC\ 30\ V$ $I_i = 300\ mA$ $P_i = 1\ W$ $L_i = 0\ \mu H$ $C_i = 5\ nF$
	Pulse/frequency/switch output	$U_i = DC\ 30\ V$ $I_i = 300\ mA$ $P_i = 1\ W$ $L_i = 0\ \mu H$ $C_i = 6\ nF$
Option C	<ul style="list-style-type: none"> ■ 4-20mA HART ■ 4-20mA 	$U_i = DC\ 30\ V$ $I_i = 300\ mA$ $P_i = 1\ W$ $L_i = 0\ \mu H$ $C_i = 30\ nF$

IS type of protection

Order code for "Output"	Output type	Intrinsically safe values
Option A	4-20mA HART	$U_i = DC\ 30\ V$ $I_i = 300\ mA$ $P_i = 1\ W$ $L_i = 0\ \mu H$ $C_i = 5\ nF$
Option B	4-20mA HART	$U_i = DC\ 30\ V$ $I_i = 300\ mA$ $P_i = 1\ W$ $L_i = 0\ \mu H$ $C_i = 5\ nF$
	Pulse/frequency/switch output	$U_i = DC\ 30\ V$ $I_i = 300\ mA$ $P_i = 1\ W$ $L_i = 0\ \mu H$ $C_i = 6\ nF$
Option C	<ul style="list-style-type: none"> ■ 4-20mA HART ■ 4-20mA 	$U_i = DC\ 30\ V$ $I_i = 300\ mA$ $P_i = 1\ W$ $L_i = 0\ \mu H$ $C_i = 30\ nF$

Low flow cut off

The switch points for low flow cut off are user-selectable.

Galvanic isolation

All outputs are galvanically isolated from one another.

Protocol-specific data

HART

Manufacturer ID	0x11
Device type ID	0x5A
HART protocol revision	6.0
Device description files (DTM, DD)	Information and files under: www.endress.com

HART load	<ul style="list-style-type: none"> ■ Min. 250 Ω ■ Max. 500 Ω
Dynamic variables	<p>The measured variables can be freely assigned to the dynamic variables.</p> <p>Measured variables for PV (primary dynamic variable)</p> <ul style="list-style-type: none"> ■ Volume flow ■ Corrected volume flow ■ Corrected methane volume flow ■ Mass flow ■ Energy flow ■ Methane fraction ■ Gross calorific value ■ Wobbe index ■ Temperature <p>Measured variables for SV, TV, QV (secondary, tertiary and quaternary dynamic variable)</p> <ul style="list-style-type: none"> ■ Volume flow ■ Corrected volume flow ■ Corrected methane volume flow ■ Mass flow ■ Energy flow ■ Methane fraction ■ Gross calorific value ■ Wobbe index ■ Temperature ■ Totalizer 1 ■ Totalizer 2 ■ Totalizer 3

Power supply

Terminal assignment

Transmitter

Connection versions

<p style="text-align: right; font-size: small;">A0013570</p>	<p style="text-align: right; font-size: small;">A0018161</p>
<i>Maximum number of terminals, without integrated overvoltage protection</i>	<i>Maximum number of terminals, with integrated overvoltage protection</i>
<p>1 Output 1 (passive): supply voltage and signal transmission</p> <p>2 Output 2 (passive): supply voltage and signal transmission</p> <p>3 Ground terminal for cable shield</p>	

Order code for "Output"	Terminal numbers			
	Output 1		Output 2	
	1 (+)	2 (-)	3 (+)	4 (-)
Option A	4-20 mA HART (passive)		-	
Option B ¹⁾	4-20 mA HART (passive)		Pulse/frequency/switch output (passive)	

Option C ¹⁾	4-20 mA HART (passive)	4-20 mA (passive)
------------------------	------------------------	-------------------

1) Output 1 must always be used; output 2 is optional.

Supply voltage

An external power supply is required for each output. The following supply voltage values apply for the 4-20 mA and 4-20 mA HART current output:

Order code for "Output"	Minimum terminal voltage	Maximum terminal voltage
<ul style="list-style-type: none"> ■ Option A ^{1), 2)}: 4-20 mA HART ■ Option B ^{1), 2)}: 4-20 mA HART, Pulse/frequency/switch output 	For 4 mA: ≥ DC 16 V For 20 mA: ≥ DC 12 V	DC 35 V
Option C ^{1), 2)} : 4-20 mA HART, 4-20 mA	For 4 mA: ≥ DC 16 V For 20 mA: ≥ DC 12 V	DC 30 V

- 1) External supply voltage of the power supply unit with load (→ 9)
- 2) For device versions with local display SD03: The terminal voltage must be increased by DC 2 V if backlighting is used.

 For information on the Ex connection values (→ 10)

 Various power supply units can be ordered from Endress+Hauser: see "Accessories" section (→ 41)

Power consumption

Transmitter

Order code for "Output"	Maximum power consumption
Option A: 4-20 mA HART	770 mW
Option B: 4-20 mA HART, Pulse/frequency/switch output	<ul style="list-style-type: none"> ■ Operation with output 1: 770 mW ■ Operation with output 1 and 2: 2 770 mW
Option C: 4-20 mA HART, 4-20 mA	<ul style="list-style-type: none"> ■ Operation with output 1: 660 mW ■ Operation with output 1 and 2: 1 320 mW

 For information on the Ex connection values (→ 10)

Current consumption

Current output

For every 4-20 mA or 4-20 mA HART current output: 3.6 to 22.5 mA

 If the option **Defined value** is selected in the **Failure mode** parameter (→ 8): 3.59 to 22.5 mA

Power supply failure

- Totalizers stop at the last value measured.
- Configuration is retained in the device memory (HistoROM).
- Error messages (incl. total operated hours) are stored.

Electrical connection

Connecting the transmitter

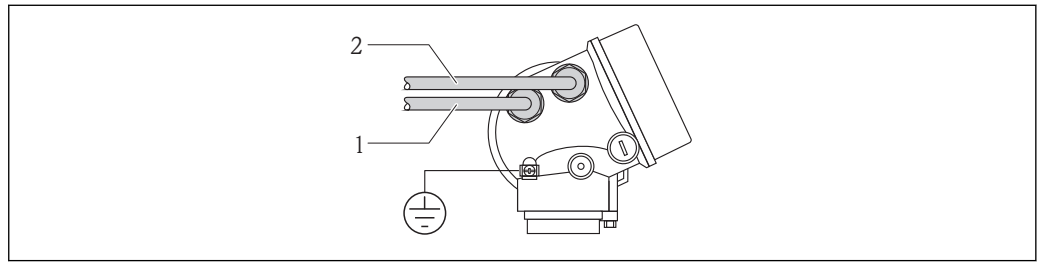

A0015510

- 1 Cable entry for output 1
- 2 Cable entry for output 2

Connection examples

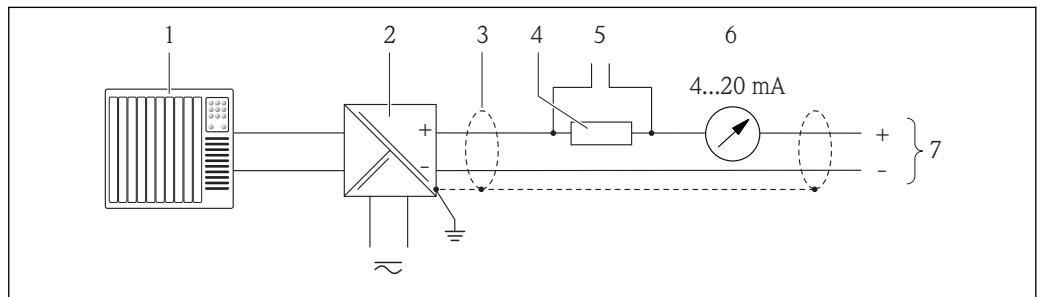

A0015511

2 Connection example for 4-20 mA HART current output (passive)

- 1 Automation system with current input (e.g. PLC)
- 2 Active barrier for power supply (e.g. RN221N) (→ 17)
- 3 Observe cable specification (→ 17)
- 4 Resistor for HART communication ($\geq 250 \Omega$): observe maximum load (→ 9)
- 5 Connection for HART operating devices (→ 36)
- 6 Analog display unit: observe maximum load (→ 9)
- 7 Transmitter

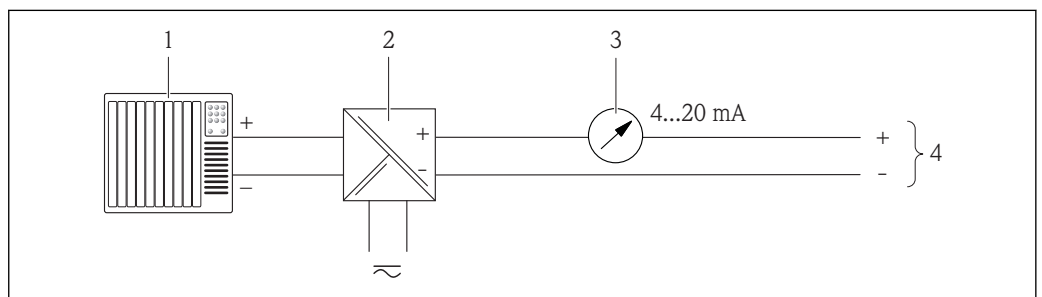

A0015512

3 Connection example for 4-20 mA current output (passive)

- 1 Automation system with current input (e.g. PLC)
- 2 Active barrier for power supply (e.g. RN221N) (→ 14)
- 3 Analog display unit: observe maximum load (→ 9)
- 4 Transmitter

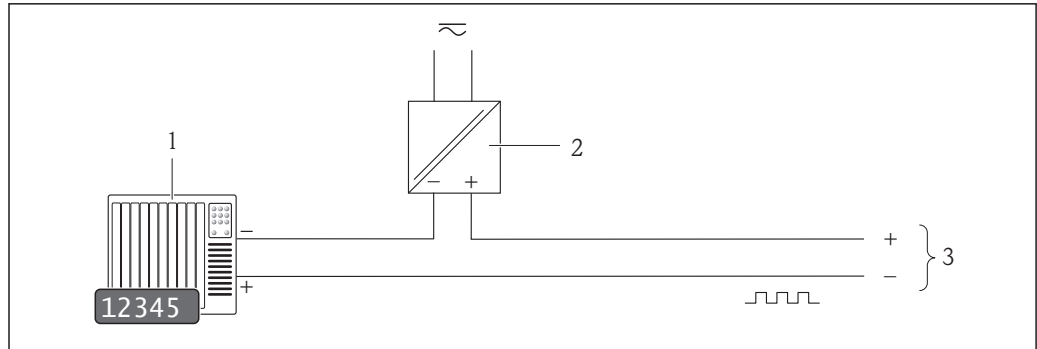

A0016801

4 Connection example for pulse/frequency output (passive)

- 1 Automation system with pulse/frequency input (e.g. PLC)
- 2 Power supply
- 3 Transmitter: Observe input values (→ 7)

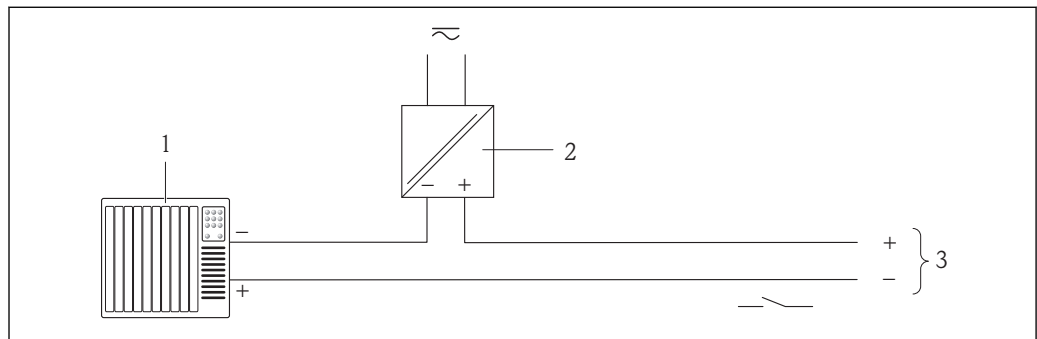

A0016802

5 Connection example for switch output (passive)

- 1 Control system with switch input (e.g. PLC)
- 2 Power supply
- 3 Transmitter: Observe input values (→ 7)

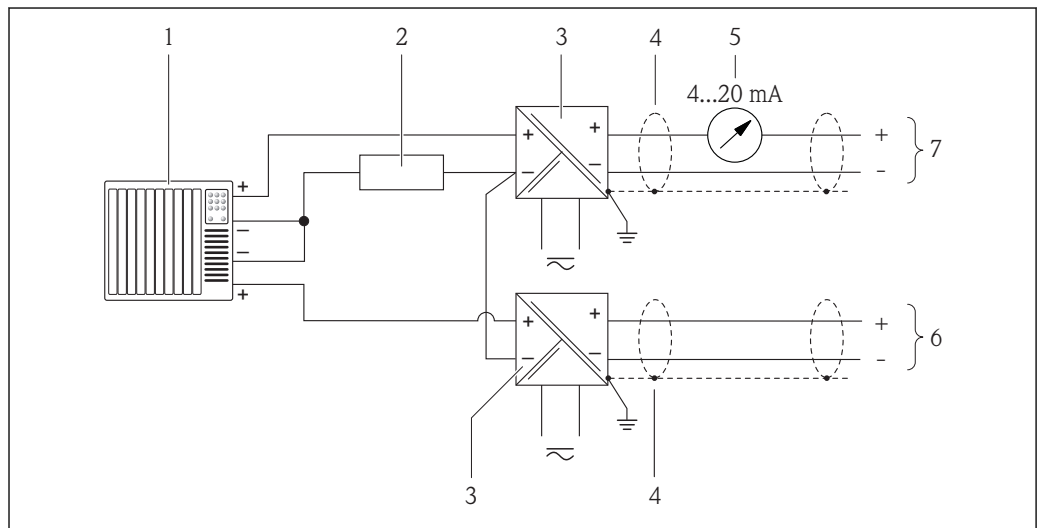

A0016029

6 Connection example for HART input with a common negative

- 1 Automation system with HART output (e.g. PLC)
- 2 Resistor for HART communication ($\geq 250 \Omega$): observe maximum load (→ 9)
- 3 Active barrier for power supply (e.g. RN221N) (→ 14)
- 4 Observe cable specification (→ 17)
- 5 Analog display unit: observe maximum load (→ 9)
- 6 Pressure transmitter (e.g. Cerabar M, Cerabar S): see requirements (→ 7)
- 7 Transmitter

Potential equalization

No special measures for potential equalization are required.



For devices in hazardous locations, please observe the guidelines in the Ex documentation (XA).

Terminals

- For device version without integrated overvoltage protection: plug-in spring terminals for wire cross-sections 0.5 to 2.5 mm² (20 to 14 AWG)
- For device version with integrated overvoltage protection: screw terminals for wire cross-sections 0.2 to 2.5 mm² (24 to 14 AWG)

Cable entries

- Cable gland (not for Ex d): M20 × 1.5 with cable Ø 6 to 12 mm (0.24 to 0.47 in)
- Thread for cable entry:
 - For non-Ex and Ex: NPT ½"
 - For non-Ex and Ex (not for CSA Ex d/XP): G ½"
 - For Ex d: M20 × 1.5

Cable specification

Permitted temperature range

- -40 °C (-40 °F)...≥ 80 °C (176 °F)
- Minimum requirement: cable temperature range ≥ ambient temperature + 20 K

Signal cable

Current output

- For 4-20 mA: standard installation cable is sufficient.
- For 4-20 mA HART: Shielded cable recommended. Observe grounding concept of the plant.

Pulse/frequency/switch output

Standard installation cable is sufficient.

Overvoltage protection

The device can be ordered with integrated overvoltage protection for diverse approvals: Order code for "Accessory mounted", option **NA** "overvoltage protection"

Input voltage range	Values correspond to supply voltage specifications (→ 14) ¹⁾
Resistance per channel	2 · 0.5 Ω max
DC sparkover voltage	400 to 700 V
Trip surge voltage	< 800 V
Capacitance at 1 MHz	< 1.5 pF
Nominal discharge current (8/20 µs)	10 kA
Temperature range	-40 to +85 °C (-40 to +185 °F)

1) The voltage is reduced by the amount of the internal resistance $I_{min} \cdot R_i$



Depending on the temperature class, restrictions apply to the ambient temperature for device versions with overvoltage protection .

Performance characteristics

Reference conditions

- Error limits following ISO/DIS 11631
- Calibration gas: air
- Temperature regulated to 24 ± 0.5 °C (75.2 ± 0.9 °F) under atmospheric pressure
- Humidity regulated to < 40 % RH
- Accuracy based on accredited calibration rigs that are traced to ISO 17025.



To calculate the measuring range, use the *Applicator* sizing tool (→ 41)

Maximum measured error

In addition to the values indicated, the measured error at the current output is typically $\pm 4 \mu\text{A}$.
 o.r. = of reading; o.f.s. = of full scale value; abs. = absolute; $1 \text{ g/cm}^3 = 1 \text{ kg/l}$; T = medium temperature

Volume flow

Standard Order code for "Calibration", option 1	<ul style="list-style-type: none"> ■ $\pm 1.5 \%$ o.r. for 3 to 30 m/s (9.84 to 98.4 ft/s) ■ $\pm 3 \%$ o.r. for 1 to 3 m/s (3.28 to 9.84 ft/s)
Optional Order code for "Calibration", option 2	<ul style="list-style-type: none"> ■ $\pm 0.1 \%$ o.f.s. for 0.3 to 1 m/s (0.98 to 3.28 ft/s) ■ $\pm 1.5 \%$ o.r. for 1 to 30 m/s (3.28 to 98.4 ft/s)

Methane

$\pm 2 \%$ o.f.s. = $\pm 2 \%$ abs.

Temperature

$\pm 0.6 \text{ }^\circ\text{C} \pm 0.005 \cdot T \text{ }^\circ\text{C}$ ($\pm 0.9 \text{ }^\circ\text{F} \pm 0.005 \cdot (T - 32) \text{ }^\circ\text{F}$)

Example for max. measured error (volume flow)

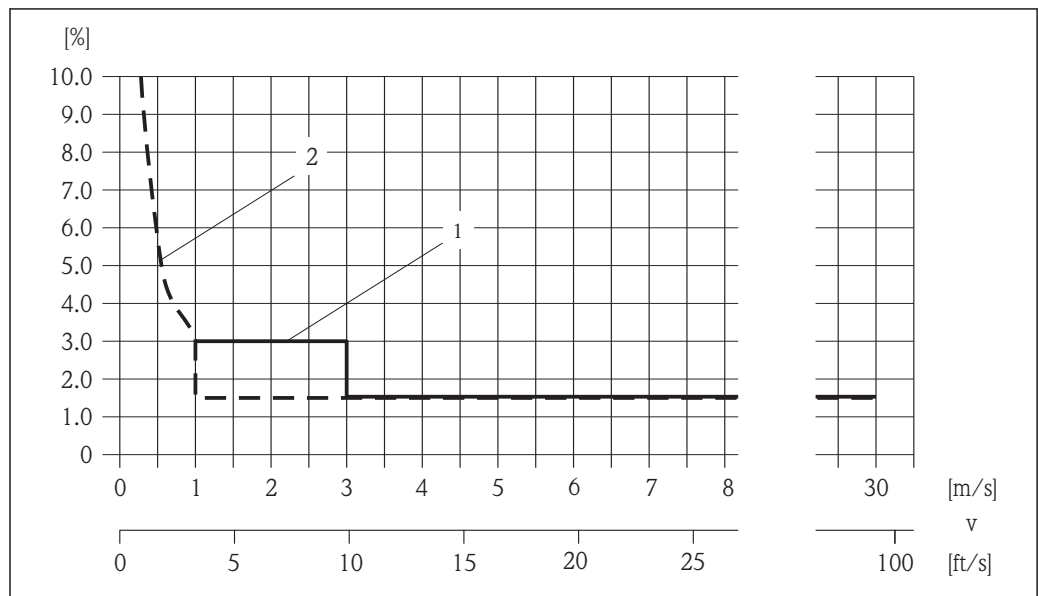

7 Example for max. measured error (volume flow) in % o.r.

- 1 Standard (order code for "Calibration", option 1)
- 2 Optional (order code for "Calibration", option 2)

Repeatability

o.r. = of reading; o.f.s. = of full scale value; abs. = absolute; $1 \text{ g/cm}^3 = 1 \text{ kg/l}$; T = medium temperature

Volume flow

$\pm 0.5 \%$ o.r.

Methane

$\pm 0.5 \%$ o.f.s. = $\pm 0.5 \%$ abs.

Temperature

$\pm 0.3 \text{ }^\circ\text{C} \pm 0.0025 \cdot T \text{ }^\circ\text{C}$ ($\pm 0.45 \text{ }^\circ\text{F} \pm 0.0025 \cdot (T - 32) \text{ }^\circ\text{F}$)

Response time

- The response time depends on the configuration (damping).
- Response time in the event of erratic changes in the flow: after 1 000 ms 95 % of the full scale value.

Influence of ambient temperature

o.r. = of reading; o.f.s. = of full scale value

Current output

Additional error, in relation to the span of 16 mA:

Temperature coefficient at zero point (4 mA)	0.02 %/10 K, max. 0.35 % over the entire temperature range -40 to +60 °C (-40 to +140 °F)
Temperature coefficient with span (20 mA)	0.05 %/10 K, max. 0.5 % over the entire temperature range -40 to +60 °C (-40 to +140 °F)

Pulse/frequency output

Temperature coefficient	Max. ±100 ppm o.r.
--------------------------------	--------------------

Installation

No special measures such as supports are necessary. External forces are absorbed by the construction of the device.

Mounting location

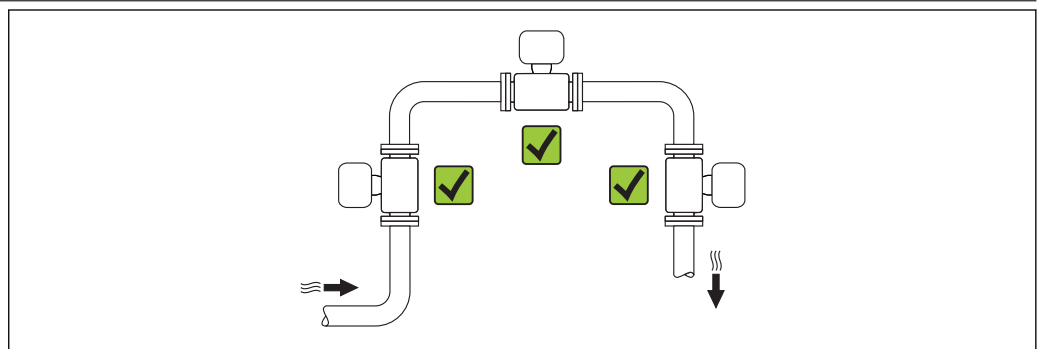

A0015543

Orientation



The direction of the arrow on the sensor helps you to install the sensor according to the flow direction (direction of medium flow through the piping).

-  ■ Install the measuring device in a parallel plane free of external mechanical stress.
- The internal diameter of the pipe must match the internal diameter of the sensor (→ 26).

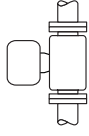
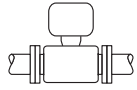

A0015895

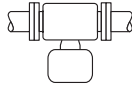
Orientation		Compact version
A	Vertical orientation	 A0015545 ✓✓
B	Horizontal orientation, transmitter head up *	 A0015589 ✓✓

Orientation		Compact version	
C	Horizontal orientation, transmitter head down *	 A0015590	✓
D	Horizontal orientation, transmitter head at side	 A0015592	✗

i * A maximum deviation of only $\pm 3^\circ$ is permitted for the horizontal alignment of the transducers.

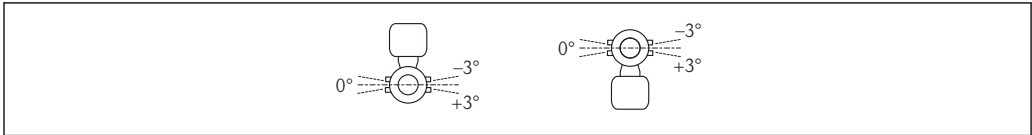

A0016534

Inlet and outlet runs

The sensor should be mounted upstream of assemblies such as valves, T-sections, elbows etc. where possible. As a minimum, the inlet and outlet runs shown below must be observed to achieve the specific accuracy of the device. The longest inlet run shown must be observed if two or more flow disturbances are present.

Single-path version: DN 50 (2"), DN 80 (3")

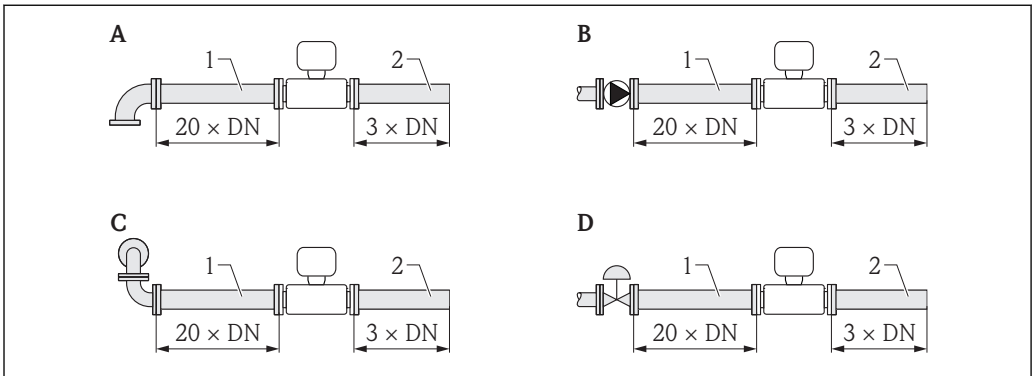

A0015453

8 Single-path version: minimum inlet and outlet runs with various flow obstructions

- A 90° elbow or T-section
- B Pump
- C 2x 90° elbow 3-dimensional
- D Control valve
- 1 Inlet run
- 2 Outlet run

Two-path version: DN 100 to 200 (4 to 8")

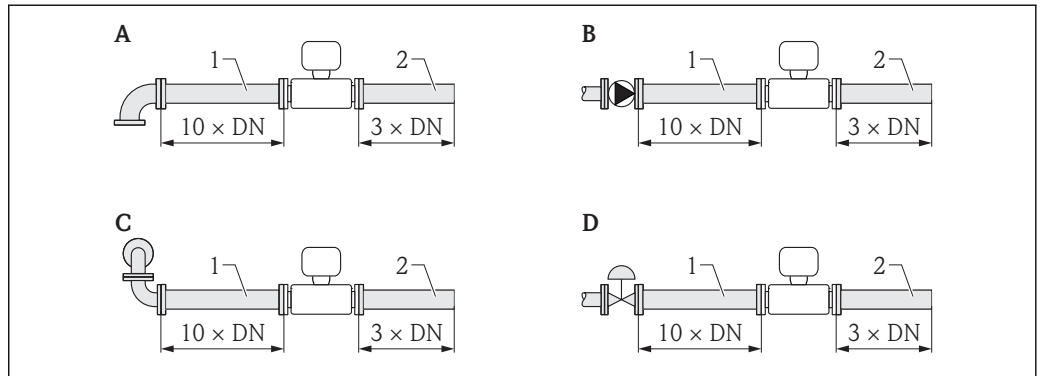

A0015553

9 Two-path version: minimum inlet and outlet runs with various flow obstructions

- A 90 ° elbow or T-section
- B Pump
- C 2x 90 ° elbow 3-dimensional
- D Control valve
- 1 Inlet run
- 2 Outlet run

Special mounting instructions **Outlet run for pressure transmitter**

If a pressure transmitter is installed downstream of the measuring device, make sure there is sufficient distance between the two devices.

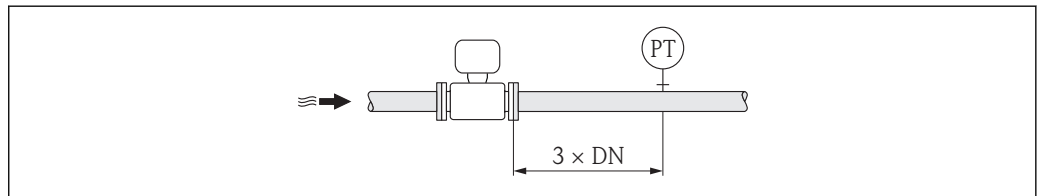

A0015901

PT Pressure transmitter

Flow conditioner

It is advisable to use a flow conditioner if the inlet runs cannot be observed. Using a flow conditioner reduces the inlet required as follows:

Single-path version	Two-path version
10 x DN	5 x DN

The flow conditioner should be installed so that it divides the available inlet run by a ratio of roughly 20 : 80. Example for an inlet run of 10 x DN:

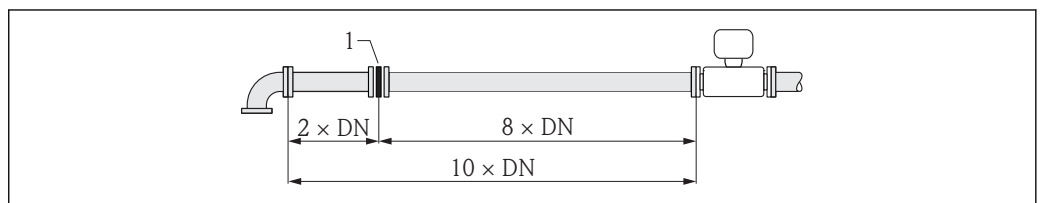

A0015562

1 Flow conditioner

Pressure loss

The pressure loss for flow conditioners is calculated as follows:

$$\Delta p [\text{mbar}] = 0.0085 \cdot \rho [\text{kg/m}^3] \cdot v^2 [\text{m/s}]$$

Example for biogas

$p = 1\,040$ mbar abs.

$\rho = 1.0432$ kg/m³ at $t = 54$ °C (129 °F)

$v = 7$ m/s

$$\Delta p = 0.0085 \cdot 1.0432 \text{ kg/m}^3 \cdot 49 \text{ m/s} = 0.434 \text{ mbar}$$

abs.: absolute

ρ : density of the process medium

v : average flow velocity

Environment

Ambient temperature range

Transmitter	-40 to +60 °C (-40 to +140 °F)
Local display	-20 to +60 °C (-4 to +140 °F), the readability of the display may be impaired at temperatures outside the temperature range.
Sensor	<ul style="list-style-type: none"> ■ Flange material carbon steel: -10 to +60 °C (+14 to +140 °F) ■ Flange material stainless steel: -40 to +60 °C (-40 to +140 °F) ■ Version without flange: -40 to +60 °C (-40 to +140 °F)

- If operating outdoors:
Avoid direct sunlight, particularly in warm climatic regions.

 Weather protection covers can be ordered from Endress+Hauser: see "Accessories" section (→  39)

Temperature tables

The following interdependencies between the permitted ambient and fluid temperatures apply when operating the device in hazardous areas:

The following applies for installations with overvoltage protection in conjunction with approval code BJ or IJ:
 $T_a = T_a - 2$ °C ($T_a = T_a - 3.6$ °F)

Order code for "Output", option A "4-20mA HART"

Ex ia, Ex d, cCSA_{US} IS, cCSA_{US} XP, cCSA_{US} NI

SI units

Nominal diameter [mm]	T_a [°C]	T6 [85 °C]	T5 [100 °C]	T4 [135 °C]	T3 [200 °C]	T2 [300 °C]	T1 [450 °C]
50 to 200	40	60	80	80	80	80	80
50 to 200	50	–	80	80	80	80	80
50 to 200	60	–	80	80	80	80	80

US units

Nominal diameter [in]	T_a [°F]	T6 [185 °F]	T5 [212 °F]	T4 [275 °F]	T3 [392 °F]	T2 [572 °F]	T1 [842 °F]
2 to 8	104	140	176	176	176	176	176
2 to 8	122	–	176	176	176	176	176
2 to 8	140	–	176	176	176	176	176

Order code for "Output", option B "4-20mA HART, pulse/frequency/switch output"

Ex ia, Ex d, cCSA_{US} IS, cCSA_{US} XP, cCSA_{US} NI

SI units

Nominal diameter [mm]	T _a [°C]	T6 [85 °C]	T5 [100 °C]	T4 [135 °C]	T3 [200 °C]	T2 [300 °C]	T1 [450 °C]
50 to 200	40	– ¹⁾	80	80	80	80	80
50 to 200	50	–	60 ²⁾	80	80	80	80
50 to 200	60	–	–	80	80	80	80

- 1) T_a = 60 °C for pulse/frequency/switch output P_i ≤ 0.85 W
 2) T_a = 80 °C for pulse/frequency/switch output P_i ≤ 0.85 W

US units

Nominal diameter [in]	T _a [°F]	T6 [185 °F]	T5 [212 °F]	T4 [275 °F]	T3 [392 °F]	T2 [572 °F]	T1 [842 °F]
2 to 8	104	– ¹⁾	176	176	176	176	176
2 to 8	122	–	140 ²⁾	176	176	176	176
2 to 8	140	–	–	176	176	176	176

- 1) T_a = 140 °F for pulse/frequency/switch output P_i ≤ 0.85 W
 2) T_a = 176 °F for pulse/frequency/switch output P_i ≤ 0.85 W

Order code for "Output", option C "4-20mA HART, 4-20mA"

Ex ia, Ex d, cCSA_{US} IS, cCSA_{US} XP, cCSA_{US} NI

SI units

Nominal diameter [mm]	T _a [°C]	T6 [85 °C]	T5 [100 °C]	T4 [135 °C]	T3 [200 °C]	T2 [300 °C]	T1 [450 °C]
50 to 200	40	60	80	80	80	80	80
50 to 200	50	–	80	80	80	80	80
50 to 200	60	–	55	80	80	80	80

US units

Nominal diameter [in]	T _a [°F]	T6 [185 °F]	T5 [212 °F]	T4 [275 °F]	T3 [392 °F]	T2 [572 °F]	T1 [842 °F]
2 to 8	104	140	176	176	176	176	176
2 to 8	122	–	176	176	176	176	176
2 to 8	140	–	131	176	176	176	176

Storage temperature –40 to +80 °C (–40 to +176 °F), preferably at +20 °C (+68 °F)

Degree of protection

Transmitter

- As standard: IP66/67, type 4X enclosure
- When housing is open: IP20, type 1 enclosure
- Display module: IP22, type 1 enclosure

Sensor
 IP66/67, type 4X enclosure

Shock resistance In accordance with EN 60721-3-4

Vibration resistance Class 4M4, in accordance with EN 60721-3-4

Electromagnetic compatibility (EMC)

- As per IEC/EN 61326 and NAMUR Recommendation 21 (NE 21)
- Complies with emission limits for industry as per EN 55011



Details are provided in the Declaration of Conformity.

Process

Medium temperature range **Sensor**
0 to +80 °C (+32 to +176 °F)

Pressure-temperature ratings The following material load diagrams refer to the entire device and not just the process connection.

Flange connection according to EN 1092-1 (DIN 2501)

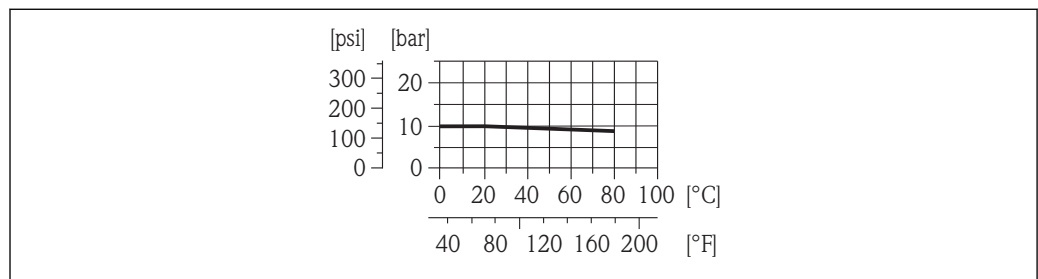

A0015905

10 With lap joint flange, stamped plate PN 10, material 1.4301/304 (DN 50 to 200 / 2 to 8")

Flange connection according to EN 1092-1 (DIN 2501)

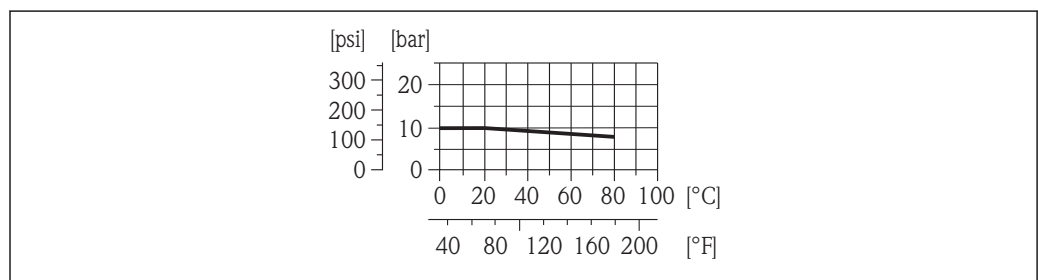

A0015906

11 With lap joint flange PN 10, material 1.4306/304L (DN 200 / 8")

Flange connection according to EN 1092-1 (DIN 2501)

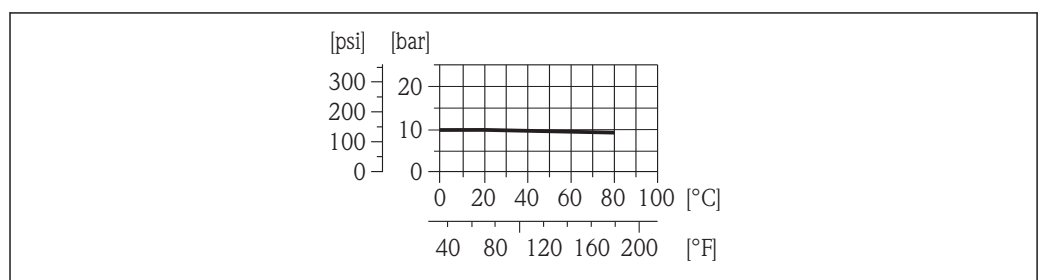

A0015932

12 With lap joint flange PN 10/16, materials S235JR (DN 50 to 200 / 2 to 8") and 1.4306/304L (DN 50 to 150 / 2 to 6"); With lap joint flange, stamped plate PN 10, material S235JR (DN 50 to 200 / 2 to 8")

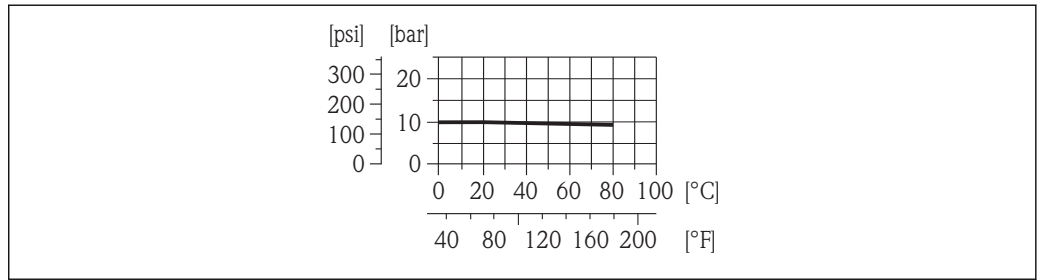

Flange connection according to ASME B16.5



A0015568

13 With lap joint flange Class 150, materials 1.4404/316L and A105 (DN 50 to 200 / 2 to 8")

Flow limit Select the nominal diameter by optimizing between the required flow range and permissible pressure loss.

 For an overview of the measuring range full scale values, see the "Measuring range" section (→  6)

- The minimum recommended full scale value is approx. 1/20 of the maximum full scale value.
- In most applications, 10 to 50 % of the maximum full scale value can be considered ideal.

Pressure loss There is no pressure loss.

System pressure **Sensor**
Max. 10 bar (145 psi)

Thermal insulation For optimum temperature and methane fraction measurement (order characteristic for "Sensor version", option 2 "Volume flow + Biogas analysis"), make sure that heat is neither lost nor applied to the sensor. Thermal insulation can ensure that such heat transfer does not take place.

Thermal insulation is particularly recommended in situations where there is a large difference between the process temperature and the ambient temperature. This can result in heat convection errors during temperature measurement. A further factor which can lead to measurement errors due to heat convection is a low flow velocity.

Mechanical construction

Design, dimensions **Compact version**

Order code for "Housing", options C "GT20 two-chamber, aluminum coated", S "GT18 two-chamber, stainless steel"

Lap joint flange; lap joint flange, stamped plate

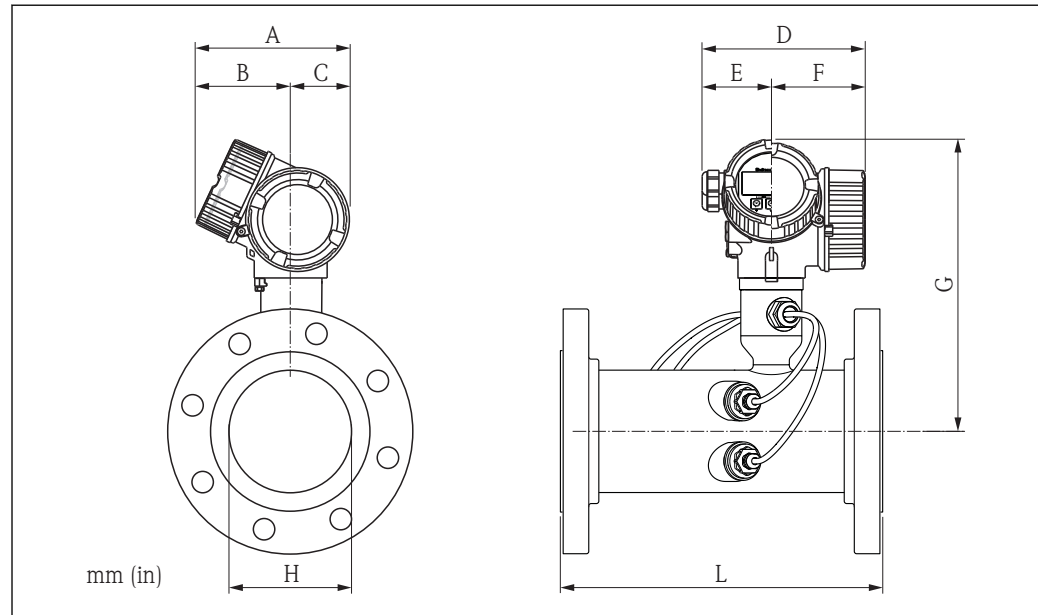

Dimensions in SI units for version without overvoltage protection

DN [mm]	A [mm]	B ¹⁾ [mm]	C [mm]	D ²⁾ [mm]	E [mm]	F ²⁾ [mm]	G ³⁾ [mm]	Ø H [mm]	L [mm]
50	162	102	60	165	75	90	254	56.3	250
80	162	102	60	165	75	90	268	84.9	300
100	162	102	60	165	75	90	281	110.3	300
150	162	102	60	165	75	90	308	164.3	350
200	162	102	60	165	75	90	334	213.9	400

- 1) for version without local display: values - 7 mm
- 2) For version with overvoltage protection (OVP): values + 8 mm
- 3) for version without local display: values - 10 mm

Dimensions in US units for version without overvoltage protection

DN [in]	A [in]	B ¹⁾ [in]	C [in]	D ²⁾ [in]	E [in]	F ²⁾ [in]	G ³⁾ [in]	Ø H [in]	L [in]
2	6.38	4.02	2.36	6.50	2.95	3.54	10.0	2.22	9.84
3	6.38	4.02	2.36	6.50	2.95	3.54	10.6	3.34	11.81
4	6.38	4.02	2.36	6.50	2.95	3.54	11.1	4.34	11.81
6	6.38	4.02	2.36	6.50	2.95	3.54	12.1	6.47	13.78
8	6.38	4.02	2.36	6.50	2.95	3.54	13.2	8.42	15.75

- 1) for version without local display: values - 0.28 in
- 2) For version with overvoltage protection (OVP): values + 0.31 in
- 3) for version without local display: values - 0.39 in

Without flange

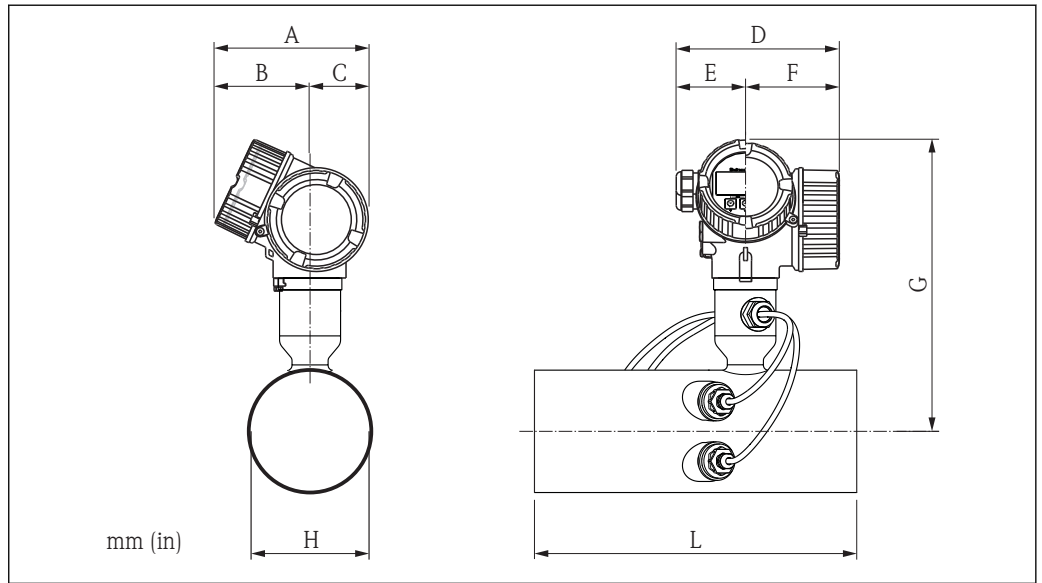

A0016233

Dimensions in SI units for version without overvoltage protection

DN [mm]	A [mm]	B ¹⁾ [mm]	C [mm]	D ²⁾ [mm]	E [mm]	F ²⁾ [mm]	G ³⁾ [mm]	Ø H [mm]	L [mm]
50	162	102	60	165	75	90	254	56.3	282.5
80	162	102	60	165	75	90	268	84.9	336.5
100	162	102	60	165	75	90	281	110.3	338.0
150	162	102	60	165	75	90	308	164.3	394.0
200	162	102	60	165	75	90	334	213.9	447.0

- 1) For version without local display: values - 7 mm
- 2) For version with overvoltage protection (OVP): values + 8 mm
- 3) Version without local display: values - 10 mm

Dimensions in US units for version without overvoltage protection

DN [mm]	A [mm]	B ¹⁾ [mm]	C [mm]	D ²⁾ [mm]	E [mm]	F ²⁾ [mm]	G ³⁾ [mm]	Ø H [mm]	L [mm]
2	6.38	4.02	2.36	6.5	2.95	3.54	10.0	2.22	11.1
3	6.38	4.02	2.36	6.5	2.95	3.54	10.6	3.34	13.2
4	6.38	4.02	2.36	6.5	2.95	3.54	11.1	4.34	13.3
6	6.38	4.02	2.36	6.5	2.95	3.54	12.1	6.47	15.5
8	6.38	4.02	2.36	6.5	2.95	3.54	13.1	8.42	17.6

- 1) For version without local display: values - 0.28 in
- 2) For version with overvoltage protection (OVP): values + 0.31 in
- 3) Version without local display: values - 0.39 in

Process connections in SI units

Flange connections EN (DIN), ASME B16.5

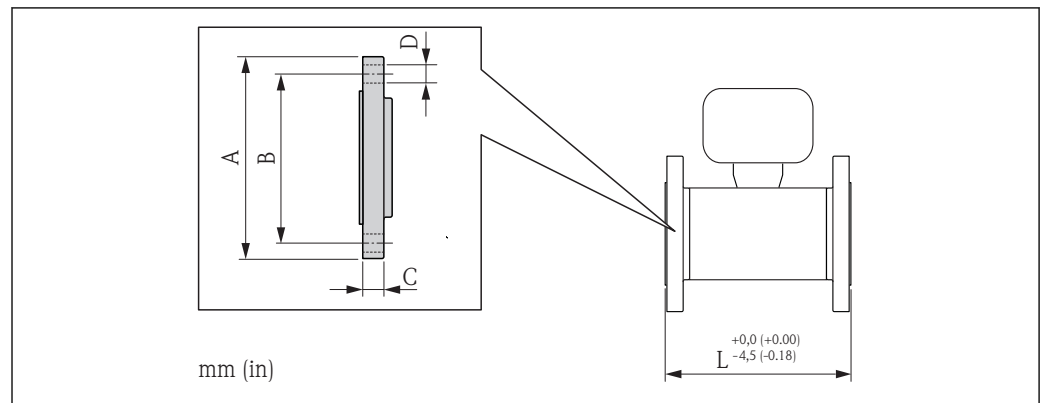

A0015457

Flange connections EN (DIN)

Flange according to EN 1092-1 (DIN 2501); PN 10/16: 1.4306/304L, S235JR (lap joint flange)					
DN [mm]	A [mm]	B [mm]	C [mm]	Ø D [mm]	L [mm]
50	165	125	22	4 × 18	250
80	200	160	22	8 × 18	300
100	220	180	24	8 × 18	300
150	285	240	26	8 × 22	350

Flange according to EN 1092-1 (DIN 2501); PN 10: 1.4306/304L, S235JR (lap joint flange)					
DN [mm]	A [mm]	B [mm]	C [mm]	Ø D [mm]	L [mm]
200	340	295	27	8 × 22	400

Flange according to EN 1092-1 (DIN 2501); PN 10: 1.4301/304, S235JR (lap joint flange, stamped plate)					
DN [mm]	A [mm]	B [mm]	C [mm]	Ø D [mm]	L [mm]
50	165	125	22	4 × 17.5	250
80	200	160	25	8 × 17.5	300
100	220	180	26	8 × 17.5	300
150	285	240	29	8 × 21.5	350
200	340	295	34	8 × 21.5	400

Flange connections ASME B16.5

Flange according to ASME B16.5; Class 150: 1.4404/316L, A105 (lap joint flange)					
DN [mm]	A [mm]	B [mm]	C [mm]	Ø D [mm]	L [mm]
50	152.4	120.7	21.1	4 × 19.1	250
80	190.5	152.4	25.9	4 × 19.1	300

Flange according to ASME B16.5; Class 150: 1.4404/316L, A105 (lap joint flange)					
DN [mm]	A [mm]	B [mm]	C [mm]	Ø D [mm]	L [mm]
100	228.6	190.5	25.9	8 × 19.1	300
150	279.4	241.3	27.4	8 × 22.4	350
200	342.9	298.5	31.0	8 × 22.4	400

Process connections in US units

Flange connections ASME B16.5

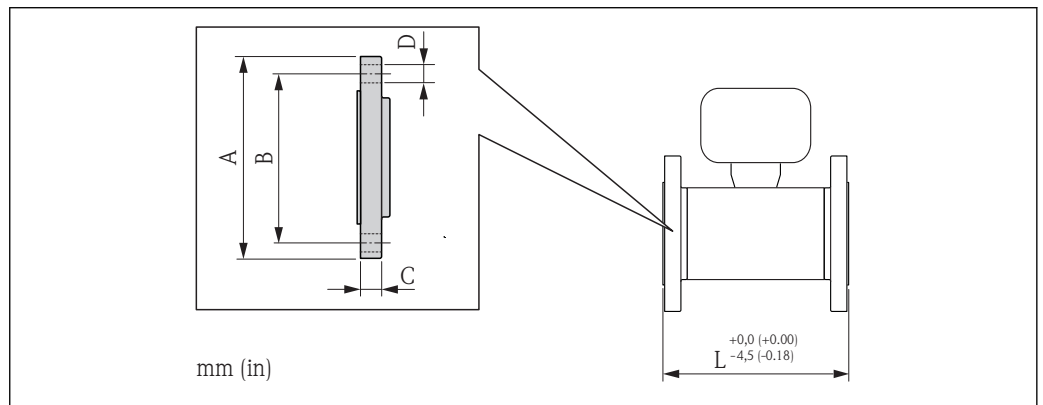

A0015457

Flange according to ASME B16.5; Class 150: 1.4404/316L, A105 (lap joint flange)					
DN [in]	A [in]	B [in]	C [in]	Ø D [in]	L [in]
2	6.00	4.75	0.83	4 × 0.75	9.84
3	7.50	6.00	1.02	4 × 0.75	11.81
4	9.00	7.50	1.02	8 × 0.75	11.81
6	11.00	9.50	1.08	8 × 0.88	13.78
8	13.50	11.75	1.22	8 × 0.88	15.75

Accessories

Replacement tool

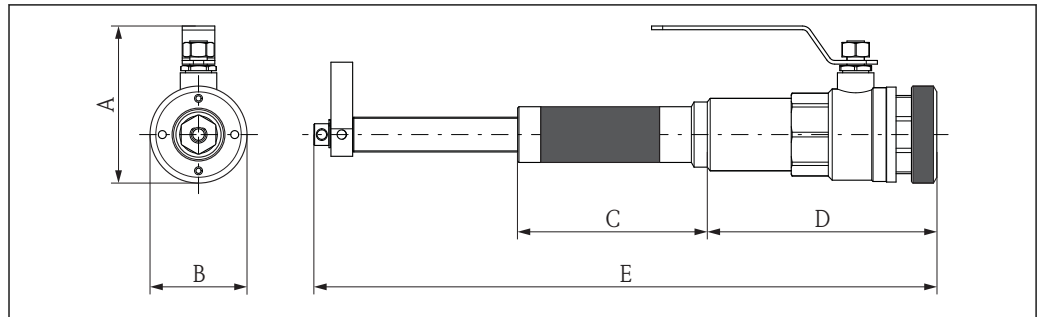

A0016020

Dimensions in SI units

A [mm]	Ø B [mm]	C [mm]	D [mm]	E [mm]
108	67	131	159	330 to 430

Dimensions in US units

A [in]	Ø B [in]	C [in]	D [in]	E [in]
4.25	2.64	5.16	6.26	13 to 17

Flow conditioner

(according to EN 1092-1 (DIN 2501))

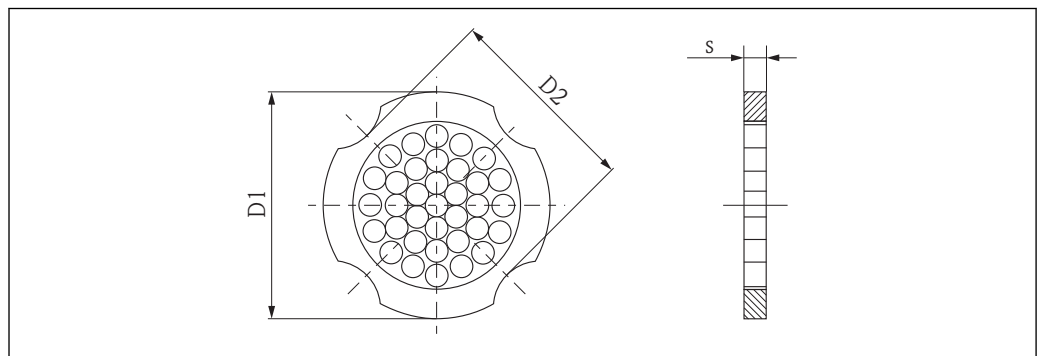

A0001941

Dimensions in SI units

DN [mm]	Pressure rating	Centering diameter [mm]	D1 ¹⁾ / D2 ²⁾	s [mm]
50	PN 10/16	110.0	D2	6.80
80	PN 10/16	145.3	D2	10.1
100	PN 10/16	165.3	D2	13.3

DN [mm]	Pressure rating	Centering diameter [mm]	D1 ¹⁾ / D2 ²⁾	s [mm]
150	PN 10/16	221.0	D2	20.0
200	PN 10	274.0	D1	26.3

- 1) The flow conditioner is fitted at the outer diameter between the bolts.
 2) The flow conditioner is fitted at the indentations between the bolts.

DN [mm]	Pressure rating	Centering diameter [mm]	D1 ¹⁾ / D2 ²⁾	s [mm]
50	Class 150	104.0	D2	6.80
80	Class 150	138.4	D1	10.1
100	Class 150	176.5	D2	13.3
150	Class 150	223.5	D1	20.0
200	Class 150	274.0	D2	26.3

- 1) The flow conditioner is fitted at the outer diameter between the bolts.
 2) The flow conditioner is fitted at the indentations between the bolts.

Dimensions in US units

DN [in]	Pressure rating	Centering diameter [in]	D1 ¹⁾ / D2 ²⁾	s [in]
2	Class 150	4.09	D2	0.27
3	Class 150	5.45	D1	0.40
4	Class 150	6.95	D2	0.52
6	Class 150	8.81	D1	0.79
8	Class 150	10.8	D2	1.04

- 1) The flow conditioner is fitted at the outer diameter between the bolts.
 2) The flow conditioner is fitted at the indentations between the bolts.

Weight

Weight in SI units

Compact version

All values (weight) refer to devices with EN (DIN) PN 10/16 flanges. Weight information in [kg].

Order code for "Housing", option C "GT20 two-chamber, aluminum coated"

Nominal diameter [mm]	Lap joint flange		Lap joint flange, stamped plate	
	1.4306	S235JR	1.4301	S235JR
50	9.5		5.9	
80	11.8		7.5	
100	14.0		9.1	
150	20.9		12.3	
200	27.9		19.1	

Order code for "Housing", option S, "GT18 two-chamber, stainless steel"

Nominal diameter [mm]	Lap joint flange		Lap joint flange, stamped plate	
	1.4306	S235JR	1.4301	S235JR
50	12.4		8.7	
80	14.7		10.3	
100	16.9		12.0	
150	23.7		15.2	
200	30.7		22.0	

Weight in US units

Compact version

All values (weight) refer to devices with ASME B16.5, Class 150 flanges. Weight information in [lbs].

Order code for "Housing", option C "GT20 two-chamber, aluminum coated"

Nominal diameter [in]	Lap joint flange	
	316L	A105
2	18.8	
3	28.6	
4	38.0	
6	49.8	
8	77.4	

Order code for "Housing", option S "GT18 two-chamber, stainless steel"

Nominal diameter [in]	Lap joint flange	
	316L	A105
2	25.1	
3	34.9	
4	44.3	
6	56.1	
8	83.7	

Accessories

Replacement tool

Weight [kg]	Weight [lbs]
3.66	8.07

Flow conditioner

Weight in SI units

DN [mm]	Pressure rating	Weight [kg]
50	PN 10/16	0.5
	Class 150	0.5
80	PN 10/16	1.4

DN [mm]	Pressure rating	Weight [kg]
100	Class 150	1.2
	PN 10/16	2.4
	Class 150	2.7
150	PN 10/16	6.3
	Class 150	6.3
200	PN 10	11.5
	Class 150	12.3

Weight in US units

DN [in]	Pressure rating	Weight [lbs]
2	Class 150	1.1
3	Class 150	2.6
4	Class 150	6.0
6	Class 150	14.0
8	Class 150	27.0

Materials

Transmitter housing

- Order code for "Housing", option **C**: aluminum coating AlSi10Mg
- Order code for "Housing", option **S**: stainless steel 1.4404/316L
- Window material: glass

Cable entries

Order code for "Housing", option C "GT20 two-chamber, aluminum coated"

Transmitter cable entries		
Electrical connection	Type of protection	Material
Cable gland M20 × 1.5	<ul style="list-style-type: none"> ■ Non-Ex ■ Ex ia 	Plastic
Thread G ½" via adapter	For non-Ex and Ex (except for CSA Ex d/XP)	Nickel-plated brass
Thread NPT ½" via adapter	For non-Ex and Ex	

Transmitter neck cable entries		
Electrical connection	Measuring path	Material
Cable gland M20 × 1.5	Two-path	Nickel-plated brass
Cable gland M12 × 1.5	Single-path	

Sensor cable entries	
Electrical connection	Material
Cable gland M12 × 1.5	Nickel-plated brass

Order code for "Housing", option S, "GT18 two-chamber, stainless steel"

Transmitter cable entries		
Electrical connection	Type of protection	Material
Cable gland M20 × 1.5	<ul style="list-style-type: none"> ■ Non-Ex ■ Ex ia 	Stainless steel 1.4404
Thread G ½" via adapter	For non-Ex and Ex (except for CSA Ex d/XP)	Stainless steel 1.4404/316L
Thread NPT ½" via adapter	For non-Ex and Ex	

Transmitter neck cable entries		
Electrical connection	Sensor version	Material
Cable gland M20 × 1.5	Two-path	Stainless steel 1.4305
Cable gland M12 × 1.5	Single-path	

Sensor cable entries		
Electrical connection	Sensor version	Material
Cable gland M20 × 1.5	Two-path	Stainless steel 1.4305
Cable gland M12 × 1.5	Single-path	

Sensor housing

Stainless steel (cold worked):

- 1.4404/316L
- 1.4435/316L

Process connections

- Stainless steel:
 - 1.4301/304
 - 1.4306/304L
 - 1.4404/316L
- Steel S235JR
- Carbon steel A105

 List of all available process connections (→  35)

Seals

- Transducer: HNBR
- Temperature sensor: AFM 34

Accessories

Replacement tool

- Knurled handle: aluminum
- Isolation valve: nickel-plated brass
- Shaft: brass
- Tensioning element: tempered steel

Flow conditioner

Stainless steel 1.4404/316L (in compliance with NACE MR0175-2003 and MR0103-2003)

Weather protection cover

Stainless steel 1.4301

Process connections

- Flanges:
 – EN 1092-1 (DIN 2501)
 – ASME B16.5



For information on the materials of the process connections (→ 34)

Operability

Operating concept

Operator-oriented menu structure for user-specific tasks

- Commissioning
- Operation
- Diagnostics
- Expert level

Quick and safe commissioning

- Guided menus ("Make-it-run" wizards) for applications
- Menu guidance with brief explanations of the individual parameter functions

Reliable operation

- Operation in the following languages:
 - Via local display: English, German, French, Spanish, Italian, Dutch, Portuguese, Polish, Russian, Turkish, Chinese, Japanese, Korean, Bahasa (Indonesian), Vietnamese, Czech, Swedish
 - Via "FieldCare" operating tool: English, German, French, Spanish, Italian, Dutch, Japanese
- Uniform operating philosophy applied to device and operating tools
- If replacing the electronic module, transfer the device configuration via the integrated memory (integrated HistoROM) which contains the process and measuring device data and the event logbook. No need to reconfigure.

Efficient diagnostics increase measurement availability

- Troubleshooting measures can be called up via the device and in the operating tools
- Diverse simulation options, logbook for events that occur and optional line recorder functions

Local operation

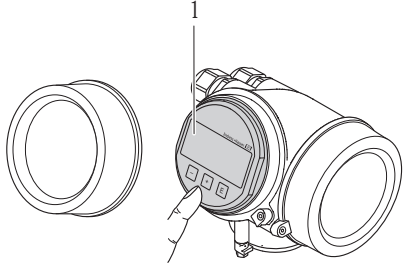
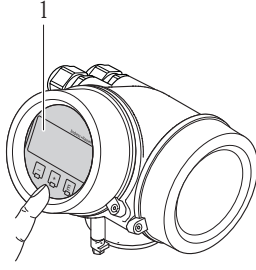
Order code for "Display; Operation", option C "SD02"	Order code for "Display; Operation", option E "SD03"
 <p style="text-align: right; font-size: small;">A0015544</p>	 <p style="text-align: right; font-size: small;">A0015546</p>
<p>1 Operation with push buttons</p>	<p>1 Operation with touch control</p>

Display elements

- 4-line display
- In the case of order code for "Display; Operation", option **E**: white background lighting; switches to red in event of device errors
- Format for displaying measured variables and status variables can be individually configured
- Permitted ambient temperature for the display: –20 to +60 °C (–4 to +140 °F)
 The readability of the display may be impaired at temperatures outside the temperature range.

Operating elements

- In the case of order code "Display; Operation", Option **C**: local operation with 3 push buttons (⊖, ⊕, ⊞)
- In the case of order code for "Display; Operation", option **E**: external operation via touch control; 3 optical keys: ⊖, ⊕, ⊞
- Operating elements also accessible in various hazardous areas

Additional functionality

- Data backup function
The device configuration can be saved in the display module.
- Data comparison function
The device configuration saved in the display module can be compared to the current device configuration.
- Data transfer function
The transmitter configuration can be transmitted to another device using the display module.

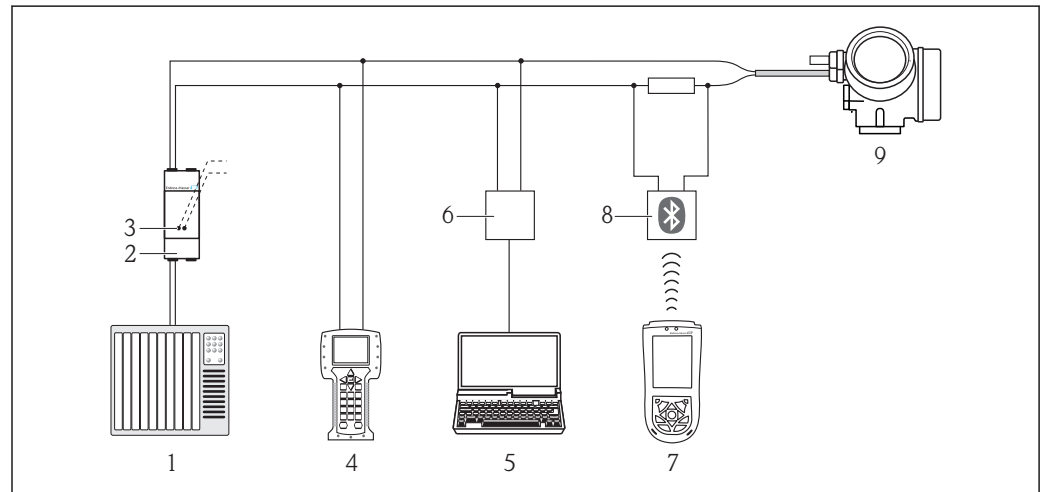
Remote operation**Via HART protocol**

A0013764

■ 14 Options for remote operation via HART protocol

- 1 Control system (e.g. PLC)
- 2 Transmitter power supply unit, e.g. RN221N (with communication resistor)
- 3 Connection for Commubox FXA195 and Field Communicator 475
- 4 Field Communicator 475
- 5 Computer with operating tool (e.g. FieldCare, AMS Device Manager, SIMATIC PDM)
- 6 Commubox FXA195 (USB)
- 7 Field Xpert SFX100
- 8 VIATOR Bluetooth modem with connecting cable
- 9 Transmitter

Via service interface (CDI)

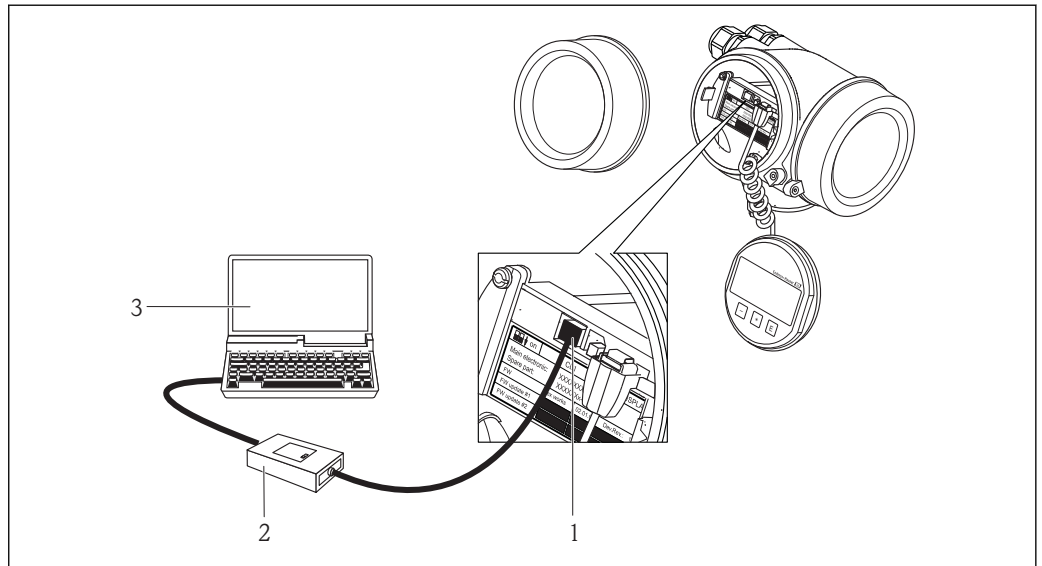

- 1 Service interface (CDI = Endress+Hauser Common Data Interface) of the measuring device
- 2 Commubox FXA291
- 3 Computer with "FieldCare" operating tool with COM DTM "CDI Communication FXA291"

A0014019

Certificates and approvals

CE mark

The measuring system is in conformity with the statutory requirements of the applicable EC Directives. These are listed in the corresponding EC Declaration of Conformity along with the standards applied.

Endress+Hauser confirms successful testing of the device by affixing to it the CE mark.

C-Tick symbol

The measuring system meets the EMC requirements of the "Australian Communications and Media Authority (ACMA)".

Ex approval

The measuring device is certified for use in hazardous areas and the relevant safety instructions are provided in the separate "Safety Instructions" (XA) document. Reference is made to this document on the nameplate.



The separate Ex documentation (XA) containing all the relevant explosion protection data is available from your Endress+Hauser sales center.

ATEX/IECEX

Currently, the following versions for use in hazardous areas are available:

Ex d

Category	Type of protection
II2G / Zone 1	Ex d[ia] IIC T6-T1 Gb

Ex ia

Category	Type of protection
II2G / Zone 1	Ex ia IIC T6-T1 Gb

cCSA_{US}

Currently, the following versions for use in hazardous areas are available:

XP

Category	Type of protection
Class I Division 1 Groups ABCD	XP (Ex d Flameproof version)

IS

Category	Type of protection
Class I Division 1 Groups ABCD	IS (Ex i Intrinsically safe version), Entity-Parameter*

NI

Category	Type of protection
Class I Division 2 Groups ABCD	NI (Non-incendive version), NIFW-Parameter*

*= Entity and NIFW parameters according to control drawings

NEPSI

Currently, the following versions for use in hazardous areas are available:

Ex d

Category	Type of protection
Zone 1	Ex d[ia] IIC T6-T1 Gb

Ex ia

Category	Type of protection
Zone 1	Ex ia IIC T6-T1 Gb

Pressure Equipment Directive

The devices can be ordered with or without a PED approval. If a device with a PED approval is required, this must be explicitly stated in the order.

- With the identification PED/G1/x (x = category) on the sensor nameplate, Endress+Hauser confirms conformity with the "Basic Safety Requirements" specified of Appendix I of the Pressure Equipment Directive 97/23/EC.
- Devices bearing this marking (PED) are suitable for the following types of medium:
Media in Group 1 and 2 with a vapor pressure greater than, or smaller and equal to 0.5 bar (7.3 psi)
- Devices not bearing this marking (PED) are designed and manufactured according to good engineering practice. They meet the requirements of Art.3 Section 3 of the Pressure Equipment Directive 97/23/EC. The range of application is indicated in tables 6 to 9 in Annex II of the Pressure Equipment Directive.

Other standards and guidelines

- EN 60529
Degrees of protection provided by enclosures (IP code)
- EN 61010-1
Protection Measures for Electrical Equipment for Measurement, Control, Regulation and Laboratory Procedures
- IEC/EN 61326
Emission in accordance with Class A requirements. Electromagnetic compatibility (EMC requirements)
- NAMUR NE 21
Electromagnetic compatibility (EMC) of industrial process and laboratory control equipment
- NAMUR NE 32
Data retention in the event of a power failure in field and control instruments with microprocessors
- NAMUR NE 43
Standardization of the signal level for the breakdown information of digital transmitters with analog output signal.

- NAMUR NE 53
Software of field devices and signal-processing devices with digital electronics
- NAMUR NE 80
The application of the pressure equipment directive to process control devices
- NAMUR NE 105
Specifications for integrating fieldbus devices in engineering tools for field devices
- NAMUR NE 107
Self-monitoring and diagnosis of field devices
- NAMUR NE 131
Requirements for field devices for standard applications

Ordering information

Detailed ordering information is available from the following sources:

- In the Product Configurator on the Endress+Hauser website: www.endress.com → Select country → Instruments → Select device → Product page function: Configure this product
- From your Endress+Hauser Sales Center: www.endress.com/worldwide

Product Configurator - the tool for individual product configuration

- Up-to-the-minute configuration data
- Depending on the device: Direct input of measuring point-specific information such as measuring range or operating language
- Automatic verification of exclusion criteria
- Automatic creation of the order code and its breakdown in PDF or Excel output format
- Ability to order directly in the Endress+Hauser Online Shop

Application packages

Many different application packages are available to enhance the functionality of the device. Such packages might be needed to address safety aspects or specific application requirements.

The application packages can be ordered from Endress+Hauser either directly with the device or subsequently. Detailed information on the order code in question is available from your local Endress+Hauser sales center or on the product page of the Endress+Hauser website: www.endress.com.

Diagnostics functions

Package	Description
HistoROM extended function	<p>Comprises extended functions concerning the event log and the activation of the measured value memory (data logger).</p> <p>Event log: Memory volume is extended from 20 message entries (basic version) to up to 100 entries.</p> <p>Data logging (line recorder):</p> <ul style="list-style-type: none"> ■ Memory capacity for up to 1000 measured values is activated. ■ 250 measured values can be output via each of the 4 memory channels. The recording interval can be defined and configured by the user. ■ Data logging is visualized via the local display or FieldCare.



Accessories

Various accessories, which can be ordered with the device or subsequently from Endress+Hauser, are available for the device. Detailed information on the order code in question is available from your local Endress+Hauser sales center or on the product page of the Endress+Hauser website: www.endress.com.

Device-specific accessories

For the transmitter







Accessories	Description
-------------	-------------

Prosonic Flow 200 transmitter	<p>Transmitter for replacement or storage. Use the order code to define the following specifications:</p> <ul style="list-style-type: none"> ■ Approvals ■ Output ■ Display / operation ■ Housing ■ Software <p> For details, see Installation Instructions EA00104D</p>
Weather protection cover	<p>Is used to protect the measuring device from the effects of the weather: e.g. rainwater, excess heating from direct sunlight or extreme cold in winter.</p> <p> For details, see Installation Instructions SD00333F</p>

For the sensor

Accessories	Description
Replacement tool	<p>Is used to remove the transducers on the fly for cleaning or replacement purposes.</p> <p> For details, see Installation Instructions EA00108D</p>
Flow conditioner	<p>Is used to shorten the necessary inlet run.</p>

Communication-specific accessories





Accessories	Description
Commubox FXA191 HART	<p>For intrinsically safe HART communication with FieldCare via the RS232C interface.</p> <p> For details, see "Technical Information" TI00237F</p>
Commubox FXA195 HART	<p>For intrinsically safe HART communication with FieldCare via the USB interface.</p> <p> For details, see "Technical Information" TI00404F</p>
Commubox FXA291	<p>Connects Endress+Hauser field devices with a CDI interface (= Endress+Hauser Common Data Interface) and the USB port of a computer or laptop.</p> <p> For details, see "Technical Information" TI00405C</p>
HART Loop Converter HMX50	<p>Is used to evaluate and convert dynamic HART process variables to analog current signals or limit values.</p> <p> For details, see "Technical Information" TI00429F and Operating Instructions BA00371F</p>
WirelessHART adapter	<p>Is used for the wireless connection of field devices. The WirelessHART adapter can be easily integrated into field devices and existing infrastructures, offers data protection and transmission safety and can be operated in parallel with other wireless networks with minimum cabling complexity.</p> <p> For details, see Operating Instructions BA00061S</p>
Fieldgate FXA320	<p>Gateway for the remote monitoring of connected 4-20 mA measuring devices via a Web browser.</p> <p> For details, see "Technical Information" TI00025S and Operating Instructions BA00053S</p>
Fieldgate FXA520	<p>Gateway for the remote diagnostics and remote configuration of connected HART measuring devices via a Web browser.</p> <p> For details, see "Technical Information" TI00025S and Operating Instructions BA00051S</p>

Field Xpert SFX100	<p>Compact, flexible and robust industry handheld terminal for remote configuration and for obtaining measured values via the HART current output (4-20 mA).</p> <p> For details, see Operating Instructions BA00060S</p>
--------------------	--

Service-specific accessories

Accessories	Description
Applicator	<p>Software for selecting and sizing Endress+Hauser measuring devices:</p> <ul style="list-style-type: none"> ■ Calculation of all the necessary data for identifying the optimum flowmeter: e.g. nominal diameter, pressure loss, accuracy or process connections. ■ Graphic illustration of the calculation results <p>Administration, documentation and access to all project-related data and parameters over the entire life cycle of a project.</p> <p>Applicator is available:</p> <ul style="list-style-type: none"> ■ Via the Internet: https://wapps.endress.com/applicator ■ On CD-ROM for local PC installation.
W@M	<p>Life cycle management for your plant</p> <p>W@M supports you with a wide range of software applications over the entire process: from planning and procurement, to the installation, commissioning and operation of the measuring devices. All the relevant device information, such as the device status, spare parts and device-specific documentation, is available for every device over the entire life cycle.</p> <p>The application already contains the data of your Endress+Hauser device. Endress+Hauser also takes care of maintaining and updating the data records.</p> <p>W@M is available:</p> <ul style="list-style-type: none"> ■ Via the Internet: www.endress.com/lifecyclemanagement ■ On CD-ROM for local PC installation.
FieldCare	<p>FDT-based plant asset management tool from Endress+Hauser.</p> <p>It can configure all smart field units in your system and helps you manage them. By using the status information, it is also a simple but effective way of checking their status and condition.</p> <p> For details, see Operating Instructions BA00027S and BA00059S</p>

System components

Accessories	Description
Memograph M graphic display recorder	<p>The Memograph M graphic data manager provides information on all the relevant measured variables. Measured values are recorded correctly, limit values are monitored and measuring points analyzed. The data are stored in the 256 MB internal memory and also on a SD card or USB stick.</p> <p> For details, see "Technical Information" TI00133R and Operating Instructions BA00247R</p>
RN221N	<p>Active barrier with power supply for safe separation of 4-20 mA standard signal circuits. Offers bidirectional HART transmission.</p> <p> For details, see "Technical Information" TI00073R and Operating Instructions BA00202R</p>
RNS221	<p>Supply unit for powering two 2-wire measuring devices solely in the non-Ex area. Bidirectional communication is possible via the HART communication jacks.</p> <p> For details, see "Technical Information" TI00081R and Brief Operating Instructions KA00110R</p>
Cerabar M	<p>The pressure transmitter for measuring the absolute and gauge pressure of gases, steam and liquids. It can be used to read in the operating pressure value via the HART protocol.</p> <p> For details, see "Technical Information" TI00426P, TI00436P and Operating Instructions BA00200P, BA00382P</p>

Cerabar S	<p>The pressure transmitter for measuring the absolute and gauge pressure of gases, steam and liquids. It can be used to read in the operating pressure value via the HART protocol.</p> <p> For details, see "Technical Information" TI00383P and Operating Instructions BA00271P</p>
-----------	---

Documentation



The following document types are available:

- On the CD-ROM supplied with the device
- In the Download Area of the Endress+Hauser Internet site: www.endress.com → Download

Standard documentation

Device type	Communication	Document type	Documentation code
9B2B**-	---	Brief Operating Instructions	KA01096D
	HART	Operating Instructions	BA01031D
	HART	Description of Device Parameters	GP01012D

Supplementary device-dependent documentation

Device type	Document type	Approval	Documentation code
9B2B**-	Safety Instructions	ATEX/IECEX Ex d	XA01008D
		ATEX/IECEX Ex i	XA01009D
		cCSA _{US} XP	XA01010D
		cCSA _{US} IS	XA01011D
		NEPSI Ex d	XA01068D
		NEPSI Ex i	XA01069D
	Information on the Pressure Equipment Directive		SD00152D
	Installation Instructions		Specified for each individual accessory (→  39)

Registered trademarks

HART®

Registered trademark of the HART Communication Foundation, Austin, USA

Applicator®, FieldCare®, Field Xpert™, HistoROM®

Registered or registration-pending trademarks of the Endress+Hauser Group

Instruments International

Endress+Hauser
Instruments International AG
Kaegenstrasse 2
4153 Reinach
Switzerland

Tel.+41 61 715 81 00
Fax+41 61 715 25 00
www.endress.com
info@ii.endress.com

Endress+Hauser 
People for Process Automation