

Operating Instructions

Levelflex FMP50

HART

Guided wave radar

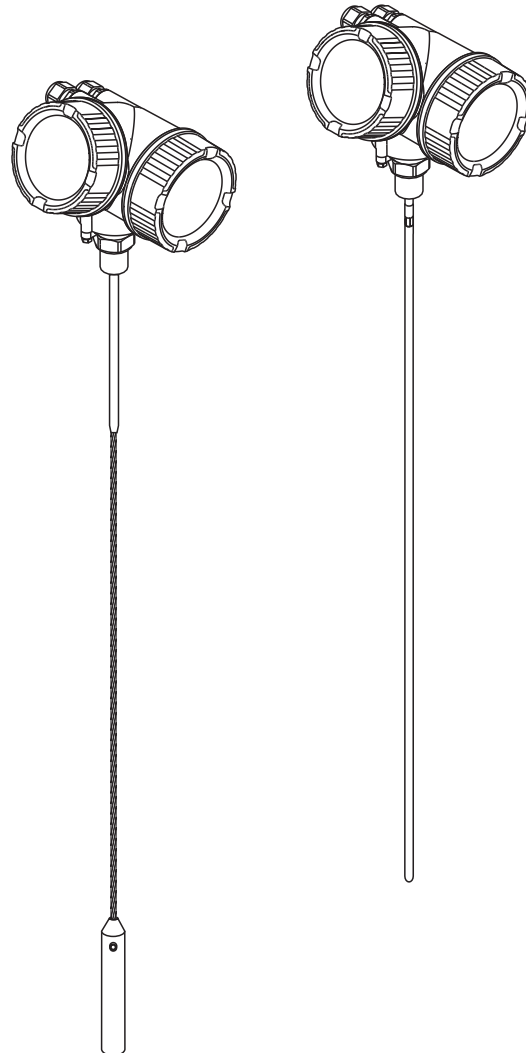

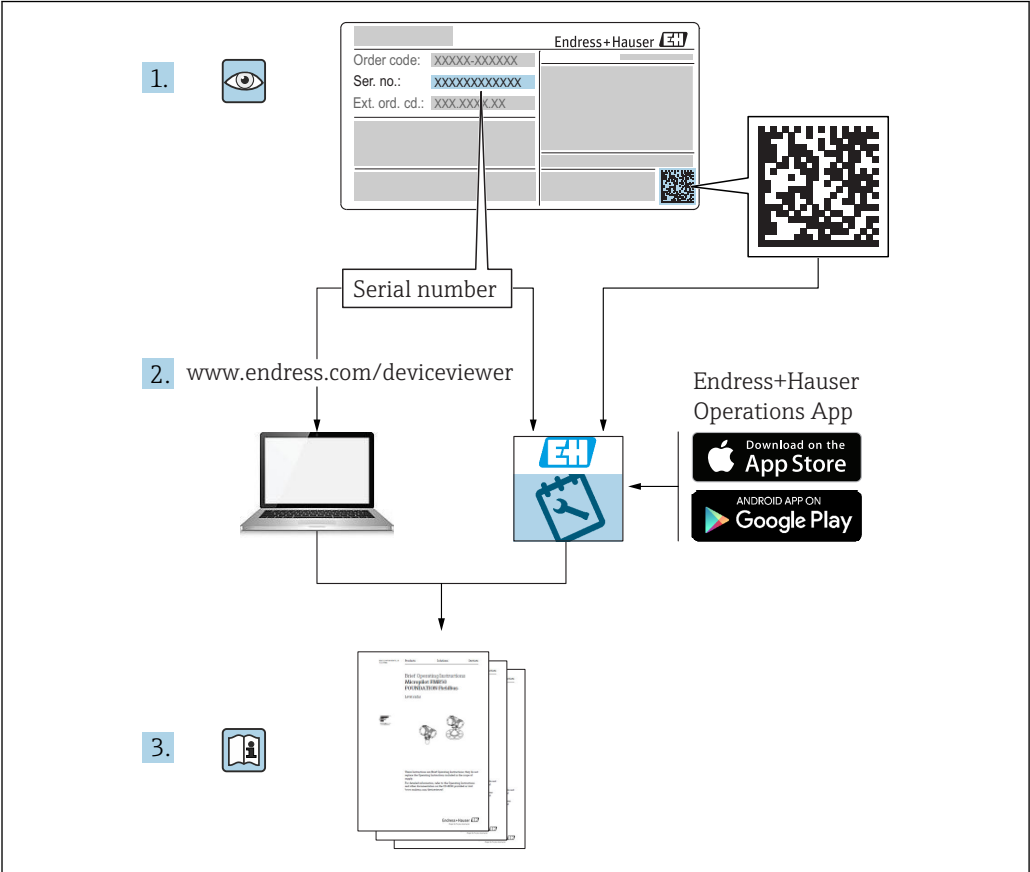

A0023555

Table of contents

1	Important document information	5	6.2	Mounting the device	39
1.1	Document function	5	6.2.1	Required mounting tools	39
1.2	Symbols	5	6.2.2	Shortening the probe	39
1.2.1	Safety symbols	5	6.2.3	Mounting the device	40
1.2.2	Electrical symbols	5	6.2.4	Mounting the "Sensor remote" version	41
1.2.3	Tool symbols	5	6.2.5	Turning the transmitter housing	43
1.2.4	Symbols for certain types of information	6	6.2.6	Turning the display	44
1.2.5	Symbols in graphics	6	6.3	Post-installation check	46
1.2.6	Symbols at the device	7	7	Electrical connection	47
1.3	Supplementary documentation	8	7.1	Connection conditions	47
1.4	Terms and abbreviations	9	7.1.1	Terminal assignment	47
1.5	Registered trademarks	10	7.1.2	Cable specification	53
2	Basic safety instructions	11	7.1.3	Device plug connectors	54
2.1	Requirements for the personnel	11	7.1.4	Power supply	55
2.2	Designated use	11	7.1.5	Overvoltage protection	58
2.3	Workplace safety	12	7.2	Connecting the measuring device	58
2.4	Operational safety	12	7.2.1	Opening connection compartment cover	59
2.5	Product safety	12	7.2.2	Connecting	59
2.5.1	CE mark	12	7.2.3	Plug-in spring-force terminals	60
2.5.2	EAC conformity	12	7.2.4	Closing connection compartment cover	60
2.6	Safety Instructions (XA)	13	7.3	Post-connection check	61
2.6.1	Ex-marking in case of connected FHX50 remote display	15	8	Operation options	62
3	Product description	16	8.1	Overview	62
3.1	Product design	16	8.1.1	Local operation	62
3.1.1	Levelflex FMP50	16	8.1.2	Operation with remote display and operating module FHX50	63
3.1.2	Electronics housing	17	8.1.3	Operation via Bluetooth® wireless technology	64
4	Incoming acceptance and product identification	18	8.1.4	Remote operation	65
4.1	Incoming acceptance	18	8.2	Structure and function of the operating menu	66
4.2	Product identification	18	8.2.1	Structure of the operating menu	66
4.2.1	Nameplate	19	8.2.2	User roles and related access authorization	68
5	Storage, Transport	20	8.2.3	Data access - Security	68
5.1	Storage conditions	20	8.3	Display and operating module	73
5.2	Transport product to the measuring point	20	8.3.1	Display appearance	73
6	Mounting	21	8.3.2	Operating elements	76
6.1	Mounting requirements	21	8.3.3	Entering numbers and text	77
6.1.1	Suitable mounting position	21	8.3.4	Opening the context menu	79
6.1.2	Applications with restricted mounting space	23	8.3.5	Envelope curve on the display and operating module	80
6.1.3	Notes on the mechanical load of the probe	24	9	Device integration via the HART protocol	81
6.1.4	Notes on the process connection	26	9.1	Overview of the Device Description files (DD)	81
6.1.5	Securing the probe	29			
6.1.6	Special mounting conditions	31			





1 Important document information

1.1 Document function





These Operating Instructions contain all the information that is required in various phases of the life cycle of the device: from product identification, incoming acceptance and storage, to mounting, connection, operation and commissioning through to troubleshooting, maintenance and disposal.

1.2 Symbols



1.2.1 Safety symbols



Symbol	Meaning
	DANGER! This symbol alerts you to a dangerous situation. Failure to avoid this situation will result in serious or fatal injury.
	WARNING! This symbol alerts you to a dangerous situation. Failure to avoid this situation can result in serious or fatal injury.
	CAUTION! This symbol alerts you to a dangerous situation. Failure to avoid this situation can result in minor or medium injury.
	NOTE! This symbol contains information on procedures and other facts which do not result in personal injury.

1.2.2 Electrical symbols





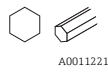







Symbol	Meaning
	Direct current
	Alternating current
	Direct current and alternating current
	Ground connection A grounded terminal which, as far as the operator is concerned, is grounded via a grounding system.
	Protective Earth (PE) A terminal which must be connected to ground prior to establishing any other connections. The ground terminals are situated inside and outside the device: <ul style="list-style-type: none"> ▪ Inner ground terminal: Connects the protective earth to the mains supply. ▪ Outer ground terminal: Connects the device to the plant grounding system.

1.2.3 Tool symbols



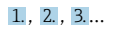



Symbol	Meaning
	Torx screwdriver
	Flat blade screwdriver

Symbol	Meaning
 A0011219	Cross-head screwdriver
 A0011221	Allen key
 A0011222	Hexagon wrench



1.2.4 Symbols for certain types of information

Symbol	Meaning
	Permitted Procedures, processes or actions that are permitted.
	Preferred Procedures, processes or actions that are preferred.
	Forbidden Procedures, processes or actions that are forbidden.
	Tip Indicates additional information.
	Reference to documentation.
	Reference to page.
	Reference to graphic.
	Notice or individual step to be observed.
	Series of steps.
	Result of a step.
	Help in the event of a problem.
	Visual inspection.

1.2.5 Symbols in graphics

Symbol	Meaning
	Item numbers
	Series of steps
	Views
	Sections
	Hazardous area Indicates a hazardous area.
	Safe area (non-hazardous area) Indicates the non-hazardous area.

1.2.6 Symbols at the device

Symbol	Meaning
	Safety instructions Observe the safety instructions contained in the associated Operating Instructions.
	Temperature resistance of the connection cables Specifies the minimum value of the temperature resistance of the connection cables.

1.3 Supplementary documentation

Document	Purpose and content of the document
Technical Information TI01000F (FMP50)	Planning aid for your device The document contains all the technical data on the device and provides an overview of the accessories and other products that can be ordered for the device.
Brief Operating Instructions KA01053F (FMP50, HART)	Guide that takes you quickly to the 1st measured value The Brief Operating Instructions contain all the essential information from incoming acceptance to initial commissioning.
Description of Device Parameters GP01000F (FMP5x, HART)	Reference for your parameters The document provides a detailed explanation of each individual parameter in the operating menu. The description is aimed at those who work with the device over the entire life cycle and perform specific configurations.
Special documentation SD00326F	Functional Safety Manual The document is part of the Operating Instructions and serves as a reference for application-specific parameters and notes.
Special documentation SD01872F	Manual for Heartbeat Verification and Heartbeat Monitoring The document contains descriptions of the additional parameters and technical data which are available with the Heartbeat Verification and Heartbeat Monitoring application packages.

 For an overview of the scope of the associated Technical Documentation, refer to the following:

- The *W@M Device Viewer* : Enter the serial number from the nameplate (www.endress.com/deviceviewer)
- The *Endress+Hauser Operations App*: Enter the serial number from the nameplate or scan the 2-D matrix code (QR code) on the nameplate.

1.4 Terms and abbreviations

Term/abbreviation	Explanation
BA	Document type "Operating Instructions"
KA	Document type "Brief Operating Instructions"
TI	Document type "Technical Information"
SD	Document type "Special Documentation"
XA	Document type "Safety Instructions"
PN	Nominal pressure
MWP	Maximum Working Pressure The MWP can also be found on the nameplate.
ToF	Time of Flight
FieldCare	Scalable software tool for device configuration and integrated plant asset management solutions
DeviceCare	Universal configuration software for Endress+Hauser HART, PROFIBUS, FOUNDATION Fieldbus and Ethernet field devices
DTM	Device Type Manager
DD	Device Description for HART communication protocol
ϵ_r (DC value)	Relative dielectric constant
Operating tool	The term "operating tool" is used in place of the following operating software: <ul style="list-style-type: none"> ■ FieldCare / DeviceCare, for operation via HART communication and PC ■ SmartBlue (app), for operation using an Android or iOS smartphone or tablet.
BD	Blocking Distance; no signals are analyzed within the BD.
PLC	Programmable Logic Controller
CDI	Common Data Interface
PFS	Pulse Frequency Status (Switching output)

1.5 Registered trademarks

HART®

Registered trademark of the FieldComm Group, Austin, USA

Bluetooth®

The Bluetooth® word mark and logos are registered trademarks owned by the Bluetooth SIG, Inc. and any use of such marks by Endress+Hauser is under license. Other trademarks and trade names are those of their respective owners.

Apple®

Apple, the Apple logo, iPhone, and iPod touch are trademarks of Apple Inc., registered in the U.S. and other countries. App Store is a service mark of Apple Inc.

Android®

Android, Google Play and the Google Play logo are trademarks of Google Inc.

KALREZ®, VITON®

Registered trademark of DuPont Performance Elastomers L.L.C., Wilmington, USA

TEFLON®

Registered trademark of E.I. DuPont de Nemours & Co., Wilmington, USA

TRI CLAMP®

Registered trademark of Alfa Laval Inc., Kenosha, USA

2 Basic safety instructions

2.1 Requirements for the personnel

The personnel for installation, commissioning, diagnostics and maintenance must fulfill the following requirements:

- ▶ Trained, qualified specialists must have a relevant qualification for this specific function and task.
- ▶ Are authorized by the plant owner/operator.
- ▶ Are familiar with federal/national regulations.
- ▶ Before starting work, read and understand the instructions in the manual and supplementary documentation as well as the certificates (depending on the application).
- ▶ Follow instructions and comply with basic conditions.

The operating personnel must fulfill the following requirements:

- ▶ Are instructed and authorized according to the requirements of the task by the facility's owner-operator.
- ▶ Follow the instructions in this manual.

2.2 Designated use

Application and measured materials

The measuring device described in these Operating Instructions is intended only for level measurement of liquids. Depending on the version ordered the device can also measure potentially explosive, flammable, poisonous and oxidizing materials.

Observing the limit values specified in the "Technical data" and listed in the Operating Instructions and supplementary documentation, the measuring device may be used for the following measurements only:

- ▶ Measured process variables: level
- ▶ Calculated process variables: Volume or mass in arbitrarily shaped vessels (calculated from the level by the linearization functionality)

To ensure that the measuring device remains in proper condition for the operation time:

- ▶ Use the measuring device only for measured materials against which the process-wetted materials are adequately resistant.
- ▶ Observe the limit values in "Technical data".

Incorrect use

The manufacturer is not liable for damage caused by improper or non-designated use.

Verification for borderline cases:

- ▶ For special measured materials and cleaning agents, Endress+Hauser is glad to provide assistance in verifying the corrosion resistance of wetted materials, but does not accept any warranty or liability.

Residual risk

The electronics housing and its built-in components such as display module, main electronics module and I/O electronics module may heat to 80 °C (176 °F) during operation through heat transfer from the process as well as power dissipation within the electronics. During operation the sensor may assume a temperature near the temperature of the measured material.

Danger of burns due to heated surfaces!

- ▶ For high process temperatures: Install protection against contact in order to prevent burns.

2.3 Workplace safety

For work on and with the device:

- ▶ Wear the required personal protective equipment according to federal/national regulations.

2.4 Operational safety

Risk of injury.

- ▶ Operate the device in proper technical condition and fail-safe condition only.
- ▶ The operator is responsible for interference-free operation of the device.

Conversions to the device

Unauthorized modifications to the device are not permitted and can lead to unforeseeable dangers.

- ▶ If, despite this, modifications are required, consult with the manufacturer.

Repair

To ensure continued operational safety and reliability,

- ▶ Carry out repairs on the device only if they are expressly permitted.
- ▶ Observe federal/national regulations pertaining to repair of an electrical device.
- ▶ Use original spare parts and accessories from the manufacturer only.

Hazardous area

To eliminate a danger for persons or for the facility when the device is used in the hazardous area (e.g. explosion protection, pressure vessel safety):

- ▶ Based on the nameplate, check whether the ordered device is permitted for the intended use in the hazardous area.
- ▶ Observe the specifications in the separate supplementary documentation that is an integral part of these Instructions.

2.5 Product safety

This measuring device is designed in accordance with good engineering practice to meet state-of-the-art safety requirements, has been tested, and left the factory in a condition in which it is safe to operate. It meets general safety standards and legal requirements.

NOTICE

Loss of degree of protection by opening of the device in humid environments

- ▶ If the device is opened in a humid environment, the degree of protection indicated on the nameplate is no longer valid. This may also impair the safe operation of the device.

2.5.1 CE mark

The measuring system meets the legal requirements of the applicable EC guidelines. These are listed in the corresponding EC Declaration of Conformity together with the standards applied.

Endress+Hauser confirms successful testing of the device by affixing to it the CE mark.

2.5.2 EAC conformity

The measuring system meets the legal requirements of the applicable EAC guidelines. These are listed in the corresponding EAC Declaration of Conformity together with the standards applied.

Endress+Hauser confirms successful testing of the device by affixing to it the EAC mark.

2.6 Safety Instructions (XA)

Depending on the approval, the following Safety Instructions (XA) are supplied with the device. They are an integral part of the Operating Instructions.

Feature 010	Approval	Available for	Feature 020: "Power Supply; Output"				
			A ¹⁾	B ²⁾	C ³⁾	E ⁴⁾ /G ⁵⁾	K ⁶⁾ /L ⁷⁾
BA	ATEX II 1G Ex ia IIC T6 Ga	FMP50	XA00496F	XA01125F	XA01126F	XA00516F	-
BB	ATEX II 1/2G Ex ia IIC T6 Ga/Gb	FMP50	XA00496F	XA01125F	XA01126F	XA00516F	-
BC	ATEX II 1/2G Ex d[ia] IIC T6 Ga/Gb	FMP50	XA00499F	XA00499F	XA00499F	XA00519F	XA01133F
BG	ATEX II 3G Ex nA IIC T6 Gc	FMP50	XA00498F	XA01130F	XA01131F	XA00518F	XA01132F
BH	ATEX II 3G Ex ic IIC T6 Gc	FMP50	XA00498F	XA01130F	XA01131F	XA00518F	-
B2	ATEX II 1/2G Ex ia IIC T6 Ga/Gb, 1/2D Ex ia IIIC Da/Db	FMP50	XA00502F	XA00502F	XA00502F	XA00522F	-
B3	ATEX II 1/2G Ex d[ia] IIC T6 Ga/Gb, 1/2 D Ex t IIIC Da/Db	FMP50	XA00503F	XA00503F	XA00503F	XA00523F	XA01136F
B4	ATEX II 1/2G Ex ia IIC T6 Ga/Gb, Ex d[ia] IIC T6 Ga/Gb	FMP50	XA00500F	XA01134F	XA01135F	XA00520F	-
CB	CSA C/US IS Cl.I Div.1 Gr.A-D	FMP50	XA00530F	XA00530F	XA00530F	XA00571F	XA00530F
CC	CSA C/US XP Cl.I Div.1 Gr.A-D	FMP50	XA00529F	XA00529F	XA00529F	XA00570F	XA00529F
C2	CSA C/US IS Cl.I,II,III Div.1 Gr.A-G, NI Cl.1 Div.2, Ex ia	FMP50	XA00530F	XA00530F	XA00530F	XA00571F	XA00530F
C3	CSA C/US XP Cl.I,II,III Div.1 Gr.A-G, NI Cl.1 Div.2, Ex d	FMP50	XA00529F	XA00529F	XA00529F	XA00570F	XA00529F
FA	FM IS Cl.I Div.1 Gr.A-D	FMP50	XA00531F	XA00531F	XA00531F	XA00573F	XA00531F
FB	FM IS Cl.I,II,III Div.1 Gr.A-G, AEx ia, NI Cl.1 Div.2	FMP50	XA00531F	XA00531F	XA00531F	XA00573F	XA00531F
FC	FM XP Cl.I Div.1 Gr.A-D	FMP50	XA00532F	XA00532F	XA00532F	XA00572F	XA00532F
FD	FM XP Cl.I,II,III Div.1 Gr.A-G, AEx d, NI Cl.1 Div.2	FMP50	XA00532F	XA00532F	XA00532F	XA00572F	XA00532F
GA	EAC Ex ia IIC T6 Ga	FMP50	XA01380F	XA01380F	XA01380F	XA01381F	XA01380F
GB	EAC Ex ia IIC T6 Ga/Gb	FMP50	XA01380F	XA01380F	XA01380F	XA01381F	XA01380F
GC	EAC Ex d[ia] IIC T6 Ga/Gb	FMP50	XA01382F	XA01382F	XA01382F	XA01383F	XA01382F
IA	IEC Ex ia IIC T6 Ga	FMP50	XA00496F	XA01125F	XA01126F	XA00516F	-
IB	IEC Ex ia IIC T6 Ga/Gb	FMP50	XA00496F	XA01125F	XA01126F	XA00516F	-
IC	IEC Ex d[ia] IIC T6 Ga/Gb	FMP50	XA00499F	XA00499F	XA00499F	XA00519F	XA01133F
IG	IEC Ex nA IIC T6 Gc	FMP50	XA00498F	XA01130F	XA01131F	XA00518F	XA01132F
IH	IEC Ex ic IIC T6 Gc	FMP50	XA00498F	XA01130F	XA01131F	XA00518F	-
I2	IEC Ex ia IIC T6 Ga/Gb, Ex ia IIIC Da/Db	FMP50	XA00502F	XA00502F	XA00502F	XA00522F	-
I3	IEC Ex d [ia] IIC T6 Ga/Gb, Ex t IIIC Da/Db	FMP50	XA00503F	XA00503F	XA00503F	XA00523F	XA01136F
I4	IEC Ex II 1/2G Ex ia IIC T6 Ga/Gb, Ex d[ia] IIC T6 Ga/Gb	FMP50	XA00500F	XA01134F	XA01135F	XA00520F	-
KA	KC Ex ia IIC T6 Ga	FMP50	XA01169F	-	XA01169F	-	-
KB	KC Ex ia IIC T6 Ga/Gb	FMP50	XA01169F	-	XA01169F	-	-
KC	KC Ex d[ia] IIC T6	FMP50	-	-	XA01170F	-	-
MA	INMETRO Ex ia IIC T6 Ga	FMP50	XA01038F	XA01038F	XA01038F	-	XA01038F
MC	INMETRO Ex d[ia] IIC T6 Ga/Gb	FMP50	XA01041F	XA01041F	XA01041F	-	XA01041F
MH	INMETRO Ex ic IIC T6 Gc	FMP50	XA01040F	XA01040F	XA01040F	-	XA01040F
NA	NEPSI Ex ia IIC T6 Ga	FMP50	XA00634F	XA00634F	XA00634F	XA00640F	XA00634F
NB	NEPSI Ex ia IIC T6 Ga/Gb	FMP50	XA00634F	XA00634F	XA00634F	XA00640F	XA00634F
NC	NEPSI Ex d[ia] IIC T6 Ga/Gb	FMP50	XA00636F	XA00636F	XA00636F	XA00642F	XA00636F
NG	NEPSI Ex nA II T6 Gc	FMP50	XA00635F	XA00635F	XA00635F	XA00641F	XA00635F

Feature 010	Approval	Available for	Feature 020: "Power Supply; Output"				
			A ¹⁾	B ²⁾	C ³⁾	E ⁴⁾ /G ⁵⁾	K ⁶⁾ /L ⁷⁾
NH	NEPSI Ex ic IIC T6 Gc	FMP50	XA00635F	XA00635F	XA00635F	XA00641F	XA00635F
N2	NEPSI Ex ia IIC T6 Ga/Gb, Ex iaD 20/21 T85...90°C	FMP50	XA00638F	XA00638F	XA00638F	XA00644F	XA00638F
N3	NEPSI Ex d[ia] IIC T6 Ga/Gb, DIP A20/21 T85...90°C IP66	FMP50	XA00639F	XA00639F	XA00639F	XA00645F	XA00639F
8A	FM/CSA IS+XP Cl.I,II,III Div.1 Gr.A-G	FMP50	XA00531F XA00532F	XA00531F XA00532F	XA00531F XA00532F	XA00572F XA00573F	XA00531F XA00532F

- 1) A: 2-wire; 4-20mA HART
- 2) B: 2-wire; 4-20mA HART, switch output
- 3) C: 2-wire; 4-20mA HART, 4-20mA
- 4) E: 2-wire; FOUNDATION Fieldbus, switch output
- 5) G: 2-wire; PROFIBUS PA, switch output
- 6) K: 4-wire 90-253VAC; 4-20mA HART
- 7) L: 4-wire 10,4-48VDC; 4-20mA HART



For certified devices the relevant Safety Instructions (XA) are indicated on the nameplate.

2.6.1 Ex-marking in case of connected FHX50 remote display

If the device is prepared for the remote display FHX50 (product structure: feature 030: "Display, Operation", option L or M), the Ex marking of some certificates changes according to the following table ¹⁾:

Feature 010 ("Approval")	Feature 030 ("Display, Operation")	Ex-marking
BG	L, M or N	ATEX II 3G Ex nA [ia Ga] IIC T6 Gc
BH	L, M or N	ATEX II 3G Ex ic [ia Ga] IIC T6 Gc
B3	L, M or N	ATEX II 1/2G Ex d [ia] IIC T6 Ga/Gb, ATEX II 1/2D Ex ta [ia Db] IIIC Txx°C Da/Db
IG	L, M or N	IECEX Ex nA [ia Ga] IIC T6 Gc
IH	L, M or N	IECEX Ex ic [ia Ga] IIC T6 Gc
I3	L, M or N	IECEX Ex d [ia] IIC T6 Ga/Gb, IECEX Ex ta [ia Db] IIIC Txx°C Da/Db

1) The marking of certificates not mentioned in this table are not affected by the FHX50.

3 Product description

3.1 Product design

3.1.1 Levelflex FMP50

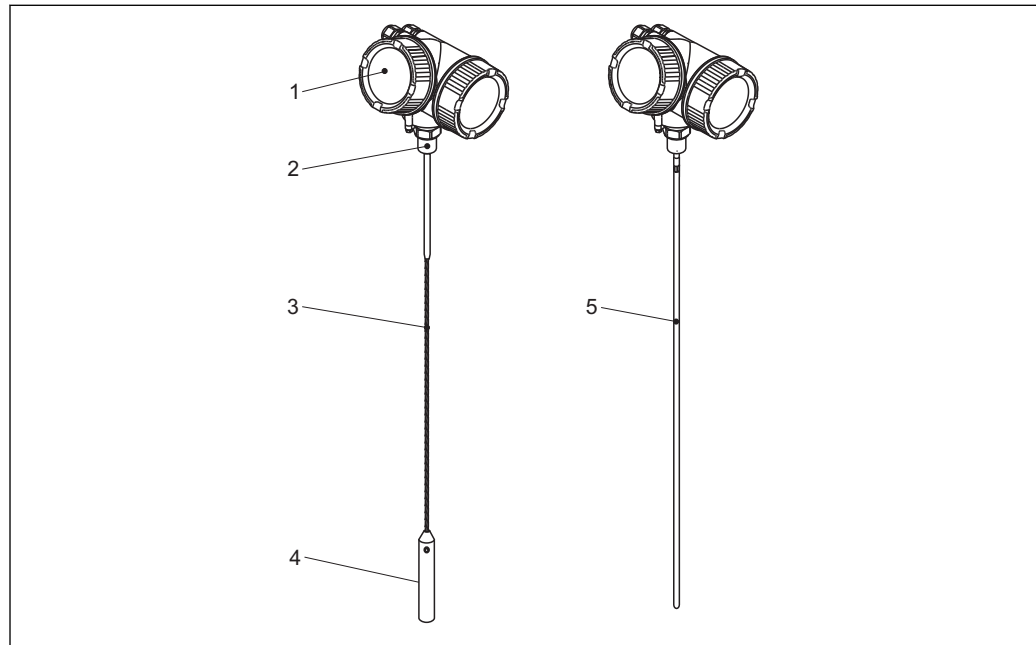

A0013771

1 Design of the Levelflex

- 1 Electronics housing
- 2 Process connection (Thread)
- 3 Rope probe
- 4 End-of-probe weight
- 5 Rod probe

3.1.2 Electronics housing

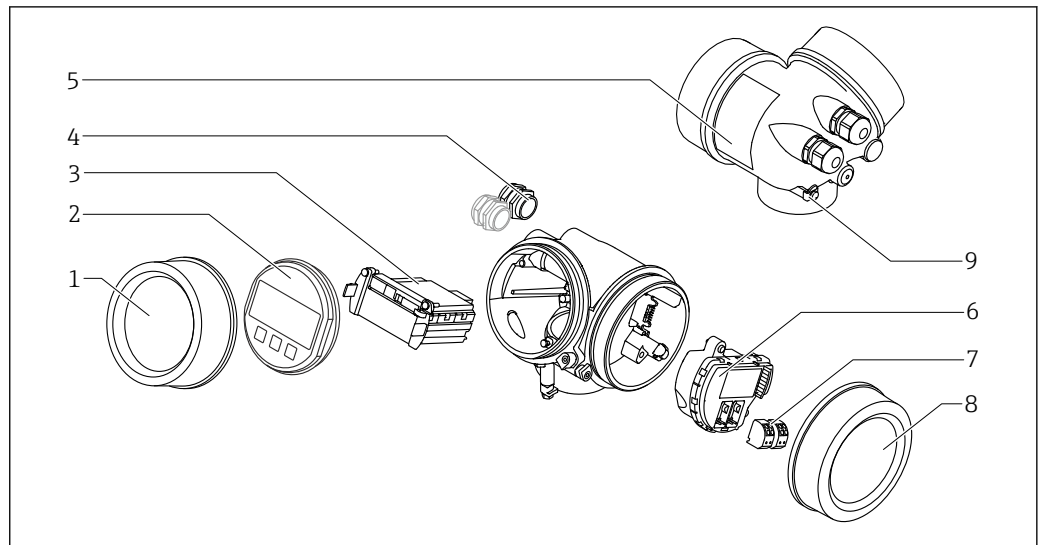

A0012422

2 Design of the electronics housing

- 1 Electronics compartment cover
- 2 Display module
- 3 Main electronics module
- 4 Cable glands (1 or 2, depending on instrument version)
- 5 Nameplate
- 6 I/O electronics module
- 7 Terminals (pluggable spring terminals)
- 8 Connection compartment cover
- 9 Grounding terminal

4 Incoming acceptance and product identification

4.1 Incoming acceptance

Upon receipt of the goods check the following:

- Are the order codes on the delivery note and the product sticker identical?
- Are the goods undamaged?
- Do the nameplate data match the ordering information on the delivery note?
- If required (see nameplate): Are the Safety Instructions (XA) present?



If one of these conditions is not satisfied, contact your Endress+Hauser Sales Center.

4.2 Product identification

The following options are available for identification of the measuring device:

- Nameplate specifications
- Order code with breakdown of the device features on the delivery note
- Enter serial numbers from nameplates in *W@M Device Viewer* (www.endress.com/deviceviewer): All information about the measuring device is displayed.
- Enter the serial number from the nameplates into the *Endress+Hauser Operations App* or scan the 2-D matrix code (QR code) on the nameplate with the *Endress+Hauser Operations App*: all the information for the measuring device is displayed.

4.2.1 Nameplate

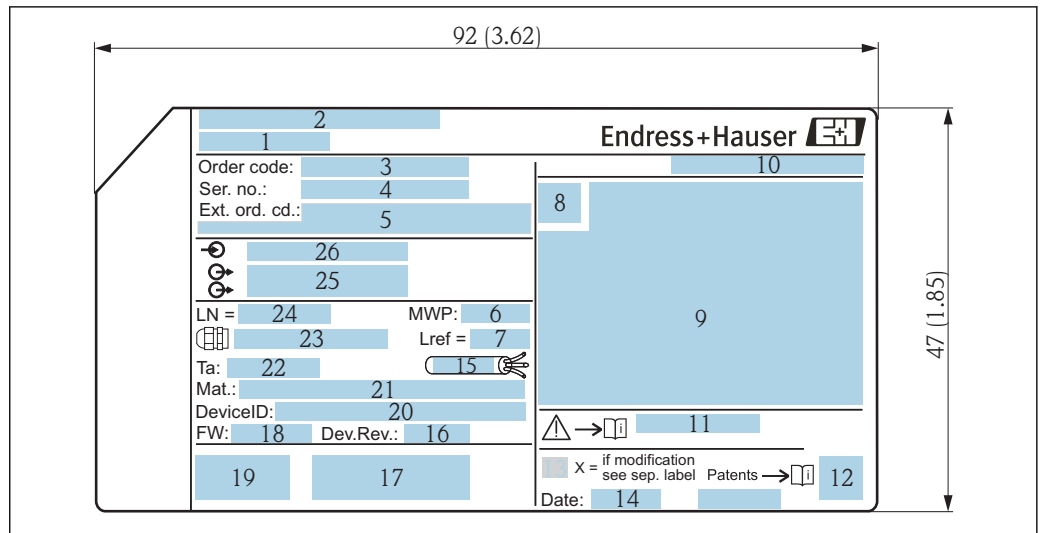

3 Nameplate of the Levelflex; Dimensions: mm (in)

- 1 Device name
- 2 Address of manufacturer
- 3 Order code
- 4 Serial number (Ser. no.)
- 5 Extended order code (Ext. ord. cd.)
- 6 Process pressure
- 7 Gas phase compensation: reference distance
- 8 Certificate symbol
- 9 Certificate and approval relevant data
- 10 Degree of protection: e.g. IP, NEMA
- 11 Document number of the Safety Instructions: e.g. XA, ZD, ZE
- 12 2-D matrix code (QR code)
- 13 Modification mark
- 14 Manufacturing date: year-month
- 15 Permitted temperature range for cable
- 16 Device revision (Dev.Rev.)
- 17 Additional information about the device version (certificates, approvals, communication): e.g. SIL, PROFIBUS
- 18 Firmware version (FW)
- 19 CE mark, C-Tick
- 20 DeviceID
- 21 Material in contact with process
- 22 Permitted ambient temperature (T_a)
- 23 Size of the thread of the cable glands
- 24 Length of probe
- 25 Signal outputs
- 26 Operating voltage

i Only 33 digits of the extended order code can be indicated on the nameplate. If the extended order code exceeds 33 digits, the rest will not be shown. However, the complete extended order code can be viewed in the operating menu of the device in the **Extended order code 1 to 3** parameter.

5 Storage, Transport

5.1 Storage conditions

- Permitted storage temperature: -40 to +80 °C (-40 to +176 °F)
- Use the original packaging.

5.2 Transport product to the measuring point

⚠ WARNING

Housing or probe may be damaged or break away.

Risk of injury!

- ▶ Transport the measuring device to the measuring point in its original packaging or at the process connection.
- ▶ Do not fasten lifting devices (hoisting slings, lifting eyes etc.) at the housing or the probe but at the process connection. Take into account the mass center of the device in order to avoid unintended tilting.
- ▶ Comply with the safety instructions, transport conditions for devices over 18kg (39.6lbs) (IEC61010).

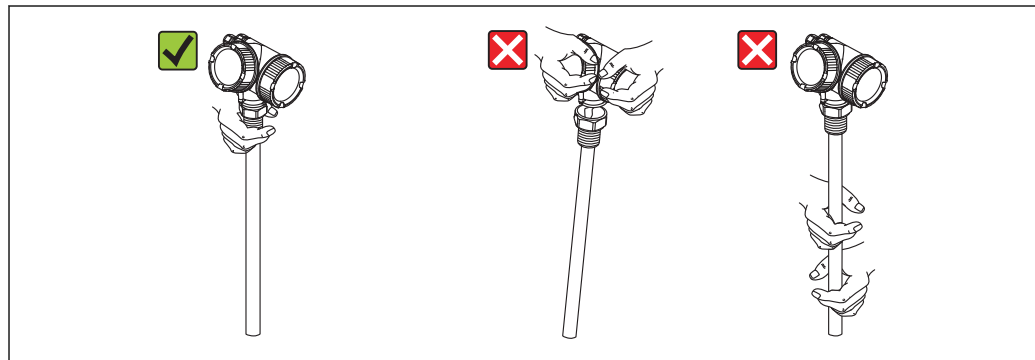

A0014264

6 Mounting

6.1 Mounting requirements

6.1.1 Suitable mounting position

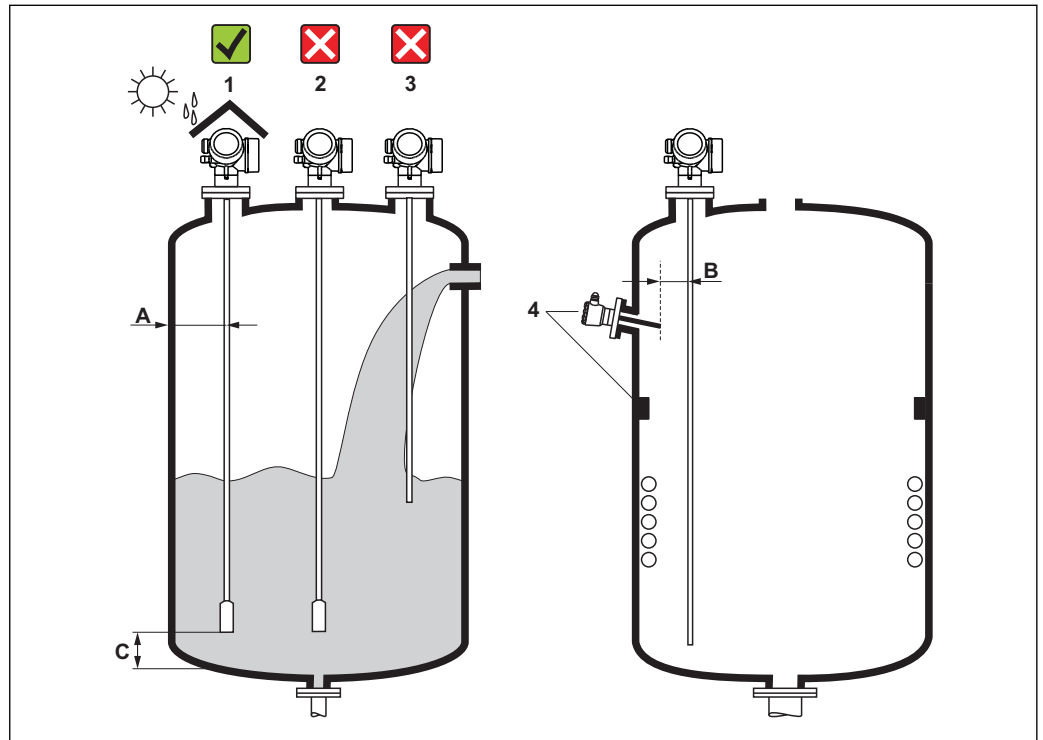

4 Mounting requirements for Levelflex

A0012606

Mounting distances

- Distance (A) between wall and rod or rope probe:
 - for smooth metallic walls: > 50 mm (2 in)
 - for plastic walls: > 300 mm (12 in) to metallic parts outside the vessel
 - for concrete walls: > 500 mm (20 in), otherwise the available measuring range may be reduced.
- Distance (B) between rod or rope probe and internal fittings in the vessel: > 300 mm (12 in)
- When using more than one Levelflex:
 - Minimum distance between the sensor axes: 100 mm (3.94 in)
- Distance (C) from end of probe to bottom of the vessel:
 - Rope probe: > 150 mm (6 in)
 - Rod probe: > 10 mm (0.4 in)

Additional conditions

- When mounting in the open, a weather protection cover (1) may be installed to protect the device against extreme weather conditions.
 - In metallic vessels: Preferably do not mount the probe in the center of the vessel (2), as this would lead to increased interference echoes.
If a central mounting position can not be avoided, it is crucial to perform an interference echo suppression(mapping) after the commissioning of the device.
 - Do not mount the probe in the filling curtain (3).
 - Avoid buckling the rope probe during installation or operation (e.g. through product movement against silo wall) by selecting a suitable mounting location.
- i** With suspended rope probes (probe end not fixed at the bottom) the distance between the probe rope and internal fittings in the tank must not fall below 300 mm (12") during the entire process. A sporadic contact between the probe weight and the cone of the vessel, however, does not influence the measurement as long as the dielectric constant of the medium is at least $DC = 1.8$.
- i** When mounting the electronics housing into a recess (e.g. in a concrete ceiling), observe a minimum distance of 100 mm (4 inch) between the cover of the terminal compartment / electronics compartment and the wall. Otherwise the connection compartment / electronics compartment is not accessible after installation.

6.1.2 Applications with restricted mounting space

Mounting with remote sensor

The device version with a remote sensor is suited for applications with restricted mounting space. In this case the electronics housing is mounted at a separate position from which it is easier accessible.

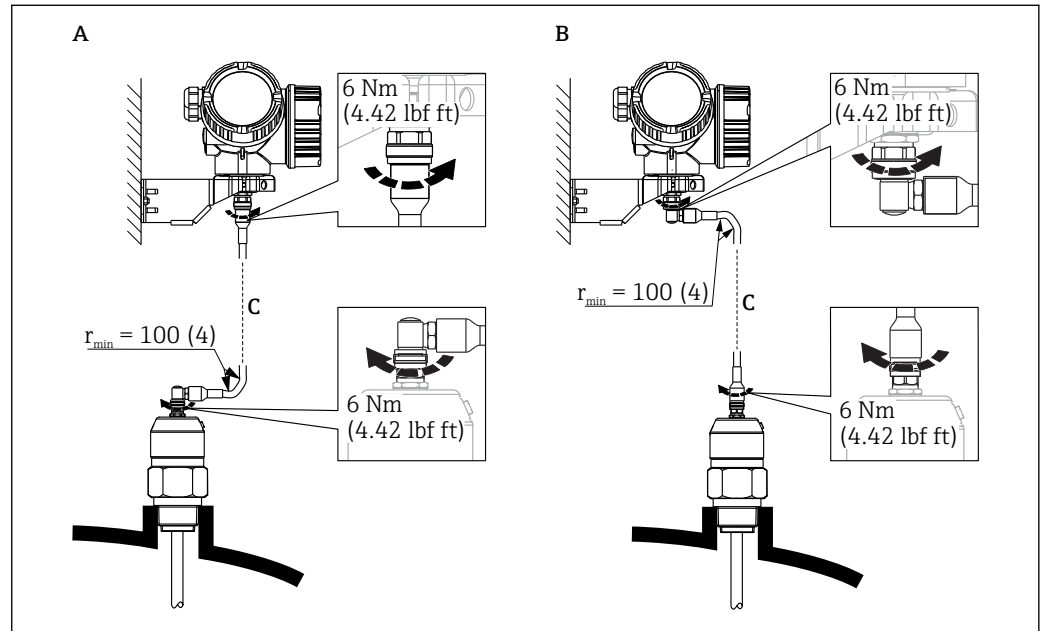

A Angled plug at the probe
 B Angled plug at the electronics housing
 C Length of the remote cable as ordered

- Product structure, feature 600 "Probe Design":
 - Option MB "Sensor remote, 3m/9ft cable"
 - Option MC "Sensor remote, 6m/18ft cable"
 - Option MB "Sensor remote, 9m/27ft cable"
 - The remote cable is supplied with these device versions
 Minimum bending radius: 100 mm (4 inch)
 - A mounting bracket for the electronics housing is supplied with these device versions.
 Mounting options:
 - Wall mounting
 - Pipe mounting; diameter: 42 to 60 mm (1-1/4 to 2 inch)
 - The connection cable has got one straight and one angled plug (90°). Depending on the local conditions the angled plug can be connected at the probe or at the electronics housing.
- i** Probe, electronics and connection cable are adjusted to match each other. They are marked by a common serial number. Only components with the same serial number shall be connected to each other.

6.1.3 Notes on the mechanical load of the probe

Tensile load limit of rope probes

Sensor	Feature 060	Probe	Tensile load limit [kN]
FMP50	LA, LB	Rope 4mm (1/6") 316	2

Bending strength of rod probes

Sensor	Feature 060	Probe	Bending strength [Nm]
FMP50	AA, AB	Rod 8mm (1/3") 316L	10

Bending load (torque) through fluid flow

The formula for calculating the bending torque M impacting on the probe:

$$M = c_w \cdot \rho / 2 \cdot v^2 \cdot d \cdot L \cdot (L_N - 0.5 \cdot L)$$

with:

c_w : Friction factor

ρ [kg/m³]: Density of the medium

v [m/s]: Velocity of the medium perpendicular to the probe rod

d [m]: Diameter of the probe rod

L [m]: Level

L_N [m]: Probe length

Calculation example

Friction factor c_w 0,9 (on the assumption of a turbulent current - high Reynolds number)

Density ρ [kg/m³] 1000 (e.g. water)

Probe diameter d [m] 0,008

$L = L_N$ (worst case)

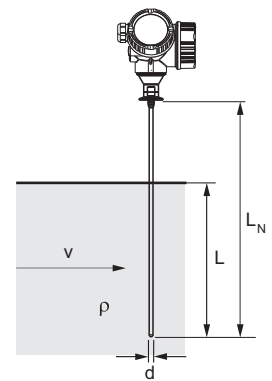

A0014175

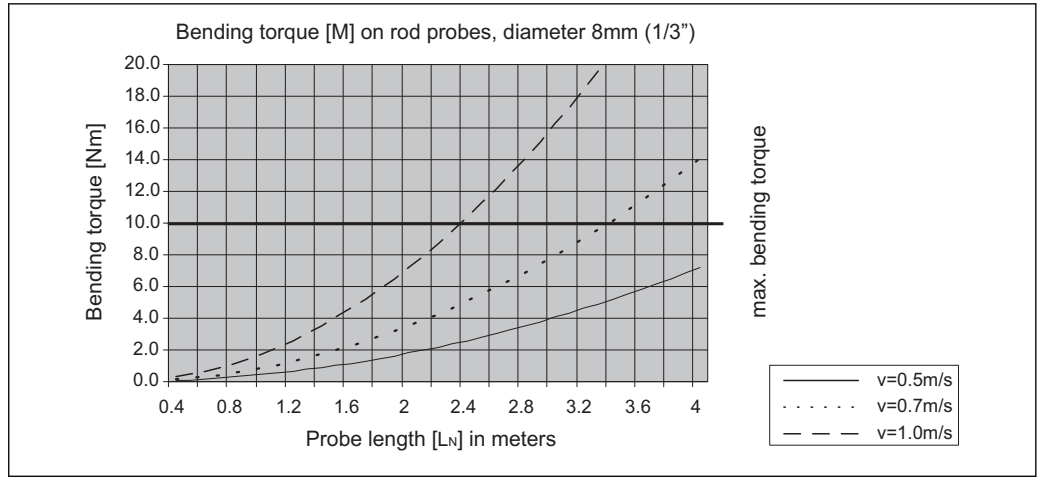

A0014182-EN

6.1.4 Notes on the process connection

Probes are mounted to the process connection with threaded connections or flanges. If during this installation there is the danger that the probe end moves so much that it touches the tank floor or cone at times, the probe must, if necessary, be shortened and fixed down →  29.

Threaded connection

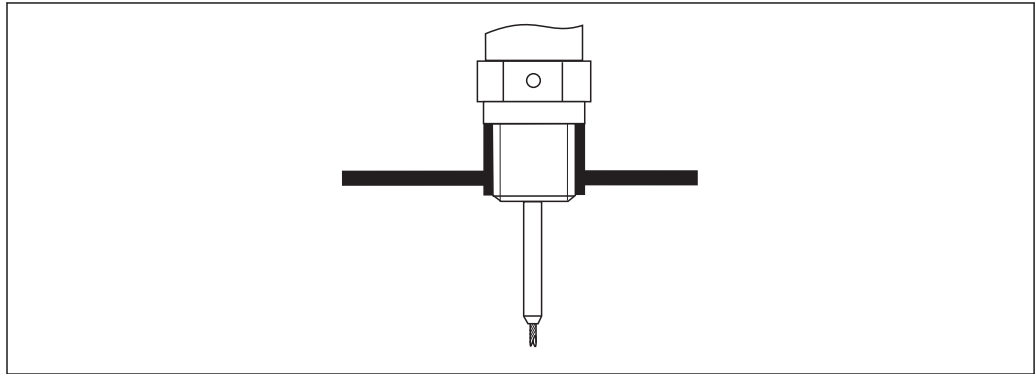

A0015121

 5 *Mounting with threaded connection; flush with the container ceiling*

Seal

The thread as well as the type of seal comply to DIN 3852 Part 1, screwed plug form A.

They can be sealed with the following types of sealing rings:

Thread G3/4": According to DIN 7603 with the dimensions 27 x 32 mm

Please use a sealing ring according to this standard in the form A, C or D and of a material that is resistant to the application.

Nozzle mounting

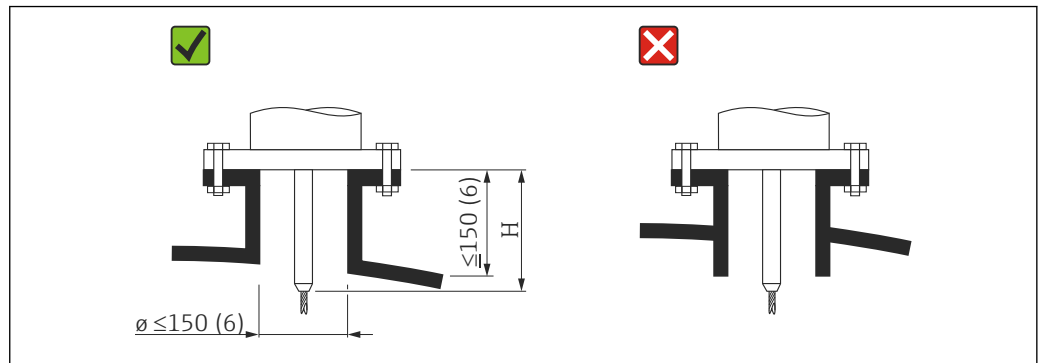

A0015122

H Length of the center rod or the rigid part of the rope probe

- Permissible nozzle diameter: ≤ 150 mm (6 in).
For larger diameters the near range measuring capability may be reduced.
For nozzles $\geq \text{DN}300$: → 28.
- Permissible nozzle height²⁾: ≤ 150 mm (6 in).
For a larger height the near range measuring capability may be reduced.
- The end of the nozzle should be flush with the tank ceiling in order to avoid ringing effects.

i With thermally insulated vessels the nozzle should also be insulated in order to prevent condensate formation.

2) Larger nozzle heights on request

Installation in nozzles \geq DN300

If installation in \geq 300mm/12" nozzles is unavoidable, installation must be carried out in accordance with the following sketch.

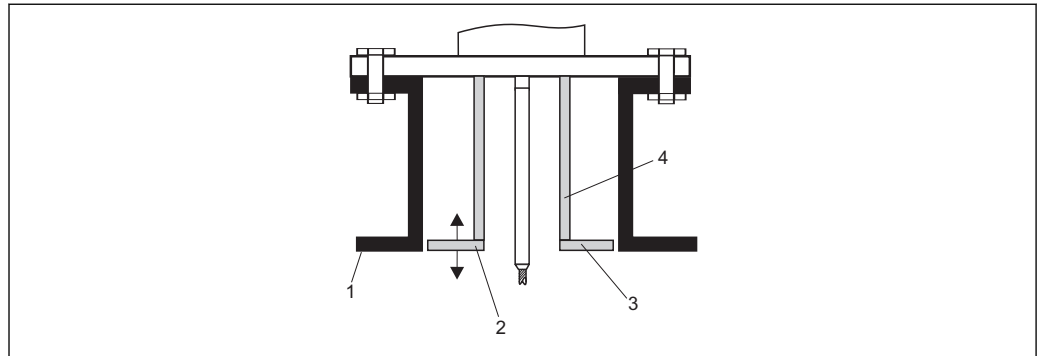

A0014199

- 1 Lower edge of the nozzle
- 2 Approx. flush with the lower edge of the nozzle (\pm 50 mm/2")
- 3 Plate
- 4 Pipe ϕ 150 to 180 mm (6 to 7 inch)

Nozzle diameter	Plate diameter
300 mm (12")	280 mm (11")
\geq 400 mm (16")	\geq 350 mm (14")

6.1.5 Securing the probe

Securing rope probes

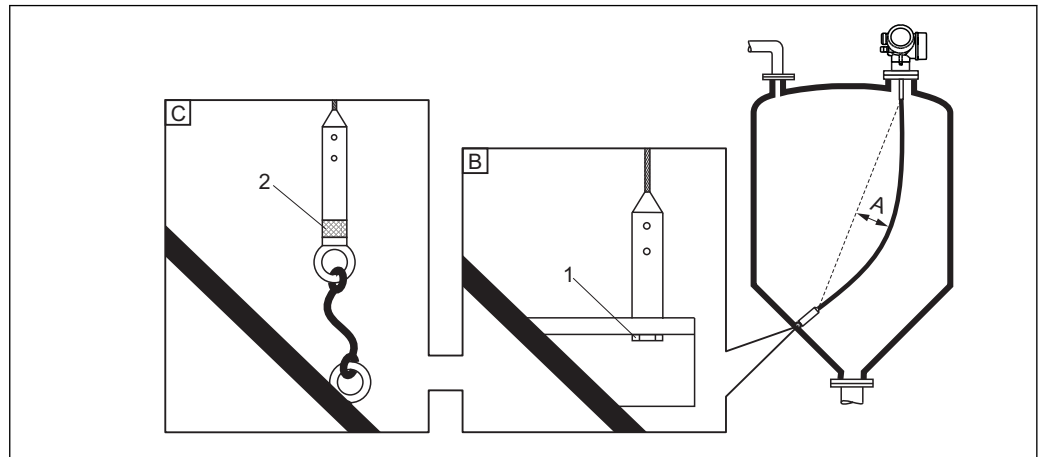

- A Sag of the rope: ≥ 1 cm per 1m of the probe length (0.12 inch per 1 ft of the probe length)
 B Reliably grounded end of probe
 C Reliably isolated end of probe
 1: Mounting and contact with a bolt
 2 Mounting kit isolated

- The end of the probe needs to be secured under the following conditions:
if otherwise the probe sporadically comes into contact with the wall of the vessel, the outlet cone, internal fittings or other parts of the installation.
- The end of probe can be secured at its internal thread
rope 4 mm (1/6"), 316: M 14
- The fixing must be either reliably grounded or reliably insulated. If it is not possible to mount the probe weight with a reliably insulated connection, it can be secured using an isolated eyelet, which is available as an accessory.
- In the case of a grounded fixing the search for a positive end-of-probe signal must be activated. Otherwise an automatic probe length correction is impossible.
Navigation: Expert → Sensor → EOP evaluation → EOP search mode
Setting: **Positive EOP** option

Securing rod probes

- For WHG approvals: For probe lengths ≥ 3 m (10 ft) a support is required.
- In general, rod probes must be supported if there is a horizontal flow (e.g. from an agitator) or in the case of strong vibrations.
- Rod probes may only be supported at the end of the probe.

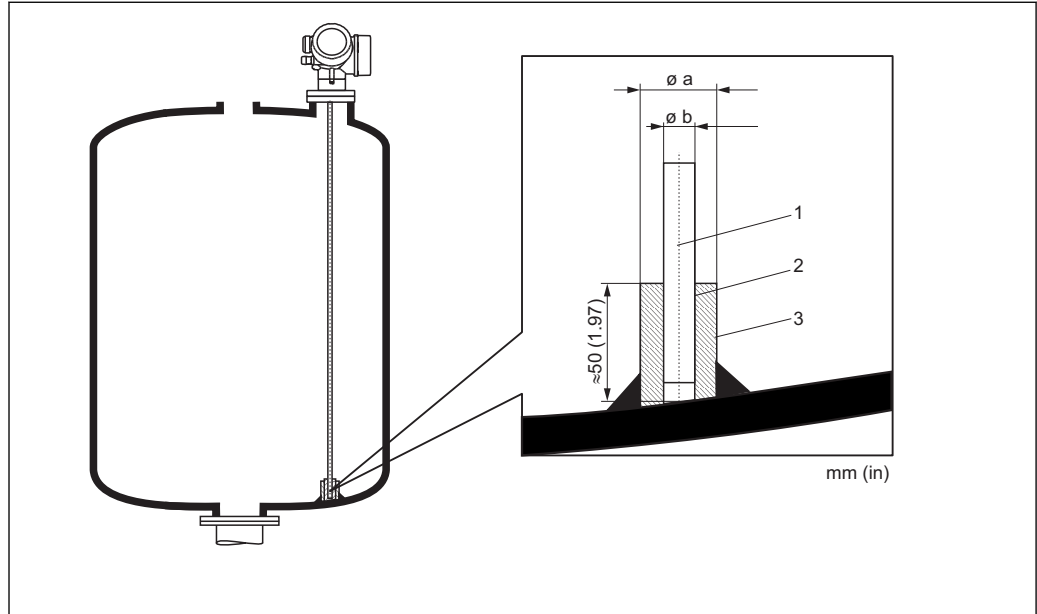

A0014127

- 1 Probe rod
- 2 Sleeve bored tight to ensure electrical contact between the rod and sleeve!
- 3 Short metal pipe, e.g. welded in place

ϕ probe	ϕa [mm (inch)]	ϕb [mm (inch)]
8 mm (1/3")	< 14 (0.55)	8.5 (0.34)

NOTICE

Poor grounding of the end of probe may cause measuring errors.

- ▶ Apply a narrow sleeve which has good electrical contact to the probe.

NOTICE

Welding may damage the main electronics module.

- ▶ Before welding: Ground the probe and dismount electronics.

6.1.6 Special mounting conditions

Bypasses and stilling wells

i In bypass and stilling well applications it is recommended to use a centering disks or stars.

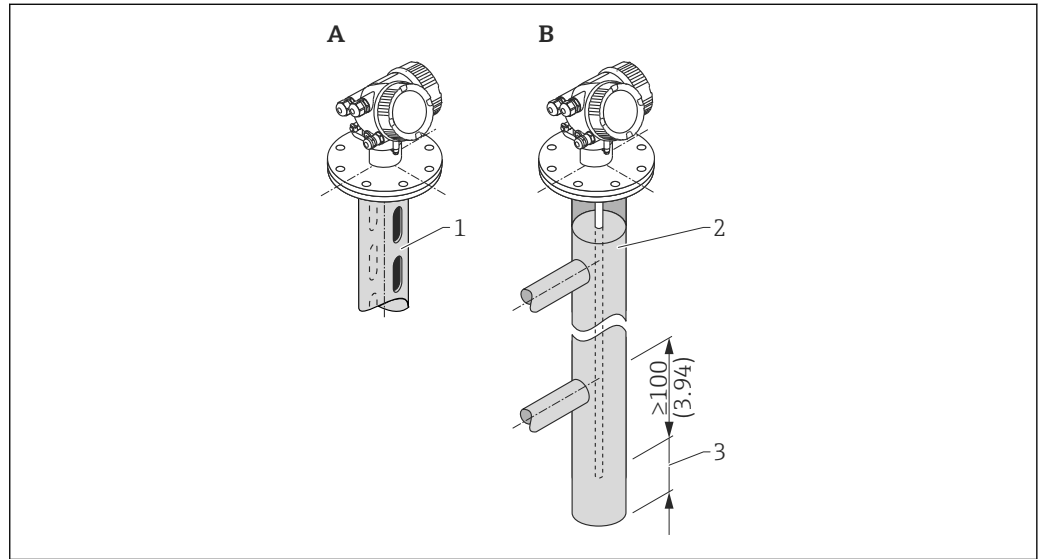

A0014129

- 1 Mounting in a stilling well
- 2 Mounting in a bypass
- 3 Minimum distance between end of probe and lower edge of the bypass; see table below

Minimum distance between end of probe and lower edge of the bypass

Type of probe	Minimum distance
Rope	10 mm (0.4 in)
Rod	10 mm (0.4 in)
Coax	10 mm (0.4 in)

- Pipe diameter: > 40 mm (1.6") for rod probes
- Rod probe installation can take place up to a diameter size of 150 mm (6 in). In the event of larger diameters, FMP51 with a coax probe is recommended.
- Side disposals, holes or slits and welded joints that protrude up to approx. 5 mm (0.2") inwards do not influence the measurement.

- The pipe may not exhibit any steps in diameter.
- The probe must be 100 mm longer than the lower disposal.
- Within the measuring range, the probe must not get into contact with the pipe wall. If necessary, secure the probe by retaining or tensioning. All rope probes are prepared for tensioning in containers (tensioning weight with anchor hole).

 For bypasses with condensate formation (water) and a medium with low dielectric constant (e.g. hydrocarbons):

In the course of time the bypass is filled with condensate up to the lower disposal and for low levels the the level echo is superimposed by the condensate echo. Thus in this range the condensate level is measured instead of the correct level. Only higher levels are measured correctly. To prevent this, position the lower disposal 100 mm (4 in) below the lowest level to be measured and apply a metallic centering disk at the height of the lower edge of the lower disposal.

 With heat insulated tanks the bypass should also be insulated in order to prevent condensate formation.

 For information on bypass solutions from Endress+Hauser please contact your Endress+Hauser sales representative.

Underground tanks

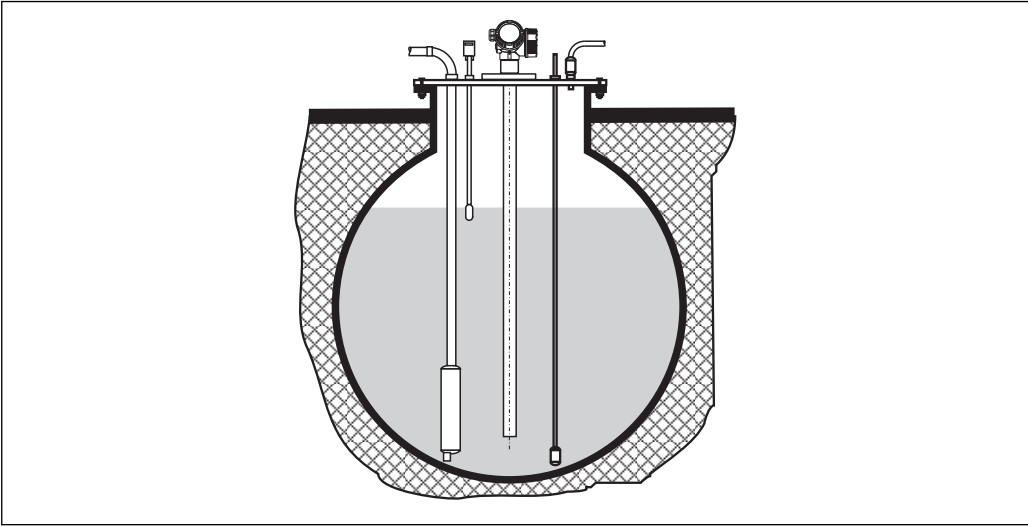

A0014142

Use FMP51 with a coax probe for nozzles with large diameters in order to avoid reflections at the nozzle wall.

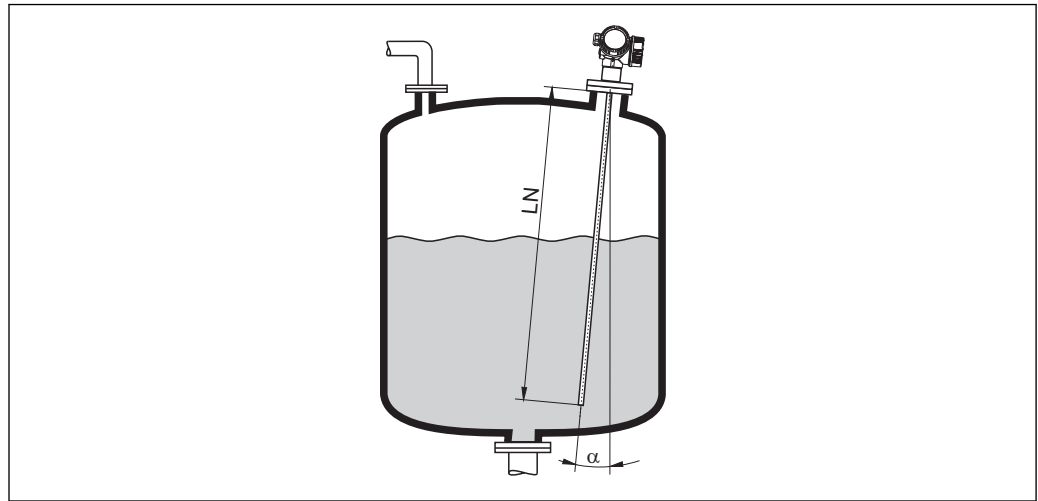
Installation at an angle

A0014145

- For mechanical reasons, the probe should be installed as vertically as possible.
- With inclined installations the probe length has to be adjusted in dependence to the installation angle.
 - Up to LN = 1 m (3.3 ft): $\alpha = 30^\circ$
 - Up to LN = 2 m (6.6 ft): $\alpha = 10^\circ$
 - Up to LN = 4 m (13.1 ft): $\alpha = 5^\circ$

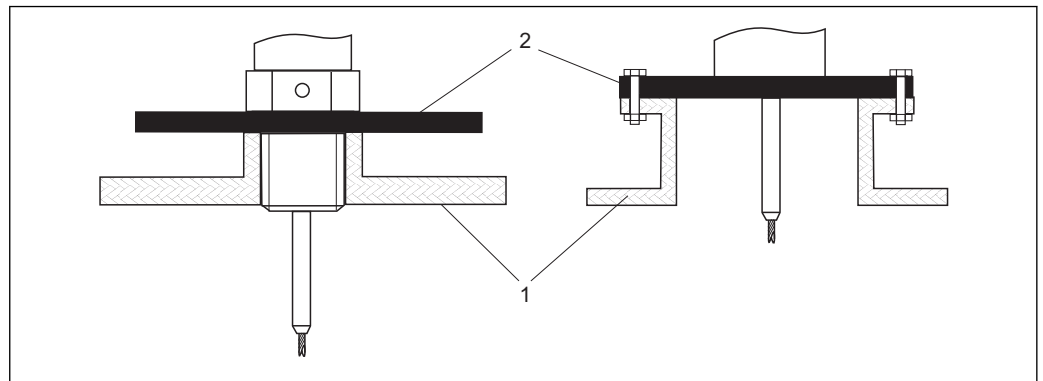
Non-metallic vessels

- 1 *Non-metallic vessel*
- 2 *Metal sheet or metal flange*

To ensure reliable measurements in non-metallic vessels mount a metal sheet with a diameter of at least 200 mm (8 in) to the probe at the process connection. Its orientation must be perpendicular to the probe.

Plastic or glass tanks: Mounting the probe externally at the wall

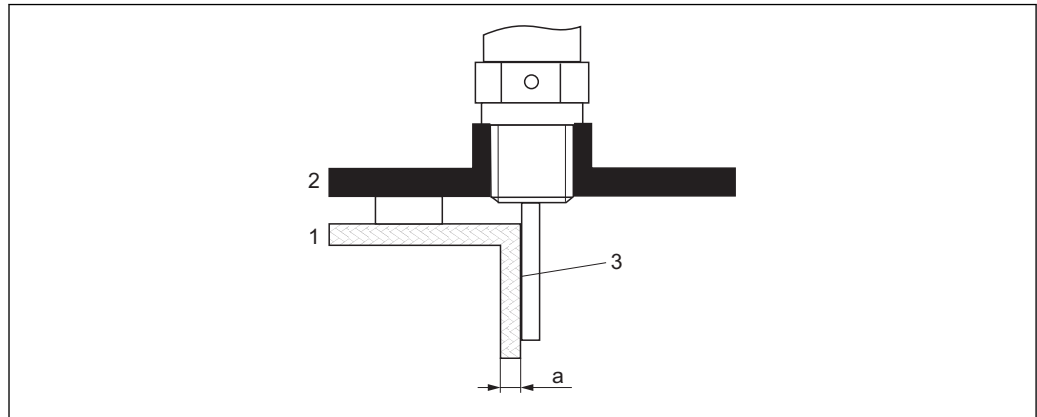

A0014150

- 1 Plastic or glass tank
- 2 Metall sheet with threaded sleeve
- 3 No free space between tank wall and probe!

Requirements

- The dielectric constant of the medium must be at least $DC > 7$.
- The tank wall must be non-conductive.
- Maximum wall thickness (a):
 - Plastic: < 15 mm (0.6")
 - Glass: < 10 mm (0.4")
- There may be no metallic reinforcements fixed to the tank.

Mounting conditions:

- The probe must be mounted directly to the tank wall (no open space)
- A plastic half pipe with a diameter of approx. 200 mm (8"), or some other protective unit, must be affixed externally to the probe to prevent any influences on the measurement.
- If the tank diameter is less than 300 mm (12"):
 - A metallic grounding sheet must be installed at the opposite side of the tank. The sheet must be conductively connected to the process connection and cover about the half of the vessel's circumference.
- If the tank diameter exceeds 300 mm (12"):
 - A metal sheet with a diameter of at least 200 mm (8") must be mounted to the probe at the process connection. Its orientation must be perpendicular to the probe (see above).

Calibration for external probe mounting

If the probe is mounted externally at the wall of the tank, the speed of signal propagation will be reduced. There are two possibilities to compensate for this effect.

Compensation with the gas phase compensation factor

The effect of the dielectric wall can be compared to the effect of a dielectric gas phase. Thus it can be compensated for in the same manner. The compensation factor is given by the quotient of the actual probe length L_N and the probe length measured when the tank is empty.

- i** The device looks for the end of probe signal in the subtracted curve. Thus, the value of the measured probe length depends on the mapping. In order to obtain an exact value, it is advisable to determine the probe length manually using the envelope curve display in FieldCare.

Step	Parameter	Action
1	Expert → Sensor → Gas phase compensation → GPC mode	Select the Const. GPC factor option.
2	Expert → Sensor → Gas phase compensation → Const. GPC factor	Enter quotient: "(Actual probe length)/(Measured probe length)".

Compensation via the calibration parameters

If an actual gas phase has to be compensated for, the gas phase compensation functionality is no longer available for a correction of the external mounting. In this case the calibration parameters (**Empty calibration** and **Full calibration**) must be adjusted and a value longer than the actual probe length has to be entered into the **Present probe length** parameter. The correction factor for these three parameters is given by the quotient of the probe length measured when the tank is empty and the actual probe length LN.

 The device looks for the end of probe signal in the subtracted curve. Thus, the value of the measured probe length depends on the mapping. In order to obtain an exact value, it is advisable to determine the probe length manually using the envelope curve display in FieldCare.

Step	Parameter	Action
1	Setup → Empty calibration	Increase parameter value by "(Measured probe length)/(Actual probe length)".
2	Setup → Full calibration	Increase parameter value by "(Measured probe length)/(Actual probe length)".
3	Setup → Advanced setup → Probe settings → Probe length correction → Confirm probe length	Select the Manual input option.
4	Setup → Advanced setup → Probe settings → Probe length correction → Present probe length	Enter measured probe length.

Vessels with heat insulation

i If process temperatures are high, the device must be included in normal tank insulation to prevent the electronics heating up as a result of heat radiation or convection. The insulation may not exceed beyond the points labeled "MAX" in the drawings.

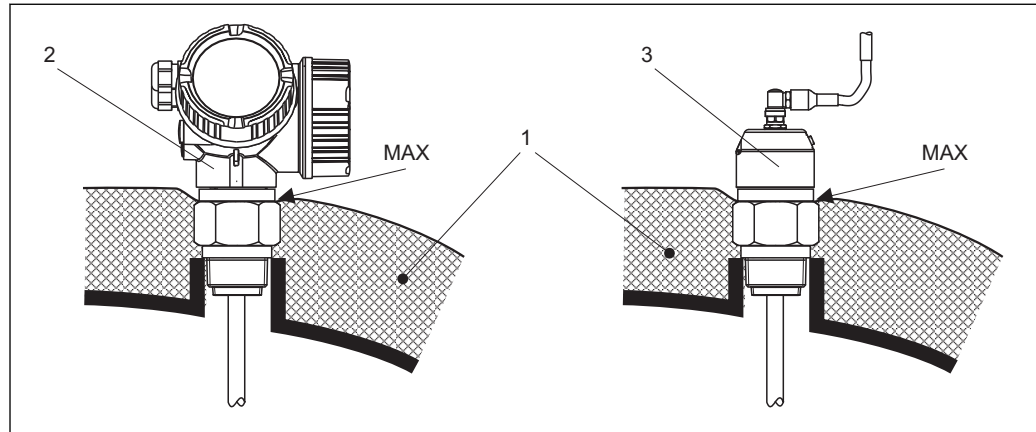

A0014653

6 Process connection with thread - FMP50

- 1 Tank insulation
- 2 Compact device
- 3 Sensor remote (feature 600)

6.2 Mounting the device

6.2.1 Required mounting tools

- For mounting thread 3/4": Hexagonal wrench 36 mm
- To shorten rod or coax probes: Saw
- To shorten rope probes:
 - Allen key AF 3 mm (for 4mm ropes) or AF 4 mm (for 6 mm ropes)
 - Saw or bolt cutter
- For flanges and other process connections: appropriate mounting tools
- To turn the housing: Hexagonal wrench 8 mm

6.2.2 Shortening the probe

Shortening rod probes

Rod probes must be shortened if the distance to the container floor or outlet cone is less than 10 mm (0.4 in). The rods of a rod probe are shortened by sawing at the bottom end.

 Rod probes of FMP52 can **not** be shortened as they are coated.

Shortening rope probes

Rope probes must be shortened if the distance to the container floor or outlet cone is less than 150 mm (6 in).

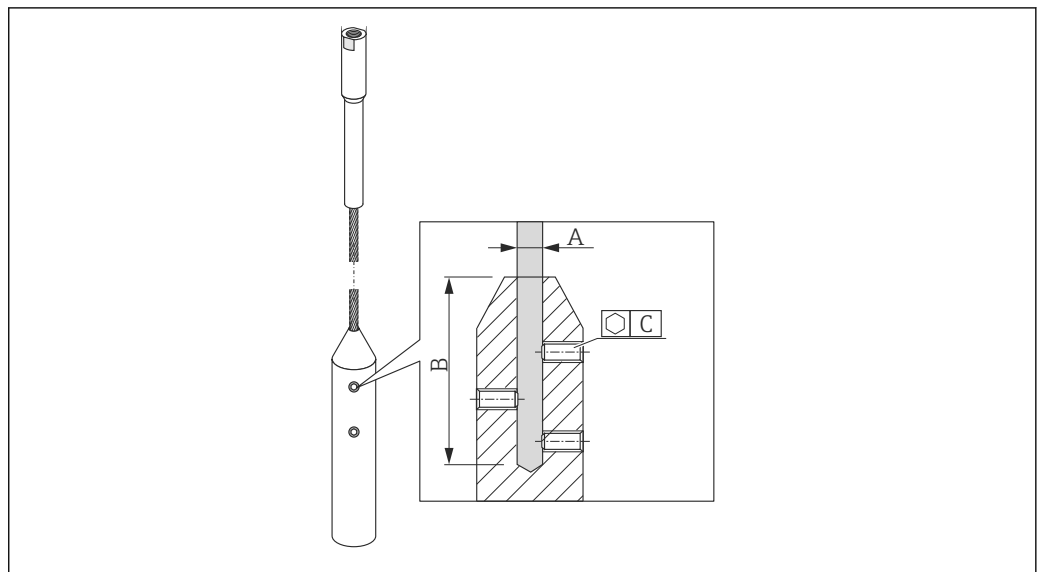

A0021693

Rope material	A	B	C	Torque for set screws
316	4 mm (0.16 in)	40 mm (1.6 in)	3 mm	5 Nm (3.69 lbf ft)

1. Using an Allen key, loosen the set screws at the end-of-probe weight. Note: The set screws have got a clamping coating in order to prevent accidental loosening. Thus an increased torque might be necessary to loosen them.
2. Remove released rope from the weight.
3. Measure off new rope length.
4. Wrap adhesive tape around the rope at the point to be shortened to prevent it from fanning out.

5. Saw off the rope at a right angle or cut it off with a bolt cutter.
6. Insert the rope completely into the weight.
7. Screw the set screws into place. Due to the clamping coating of the setscrews application of a screw locking fluid is not necessary.

Entering the new probe length

After shortening the probe:

1. Go to the **Probe settings** submenu and perform a probe length correction.
- 2.

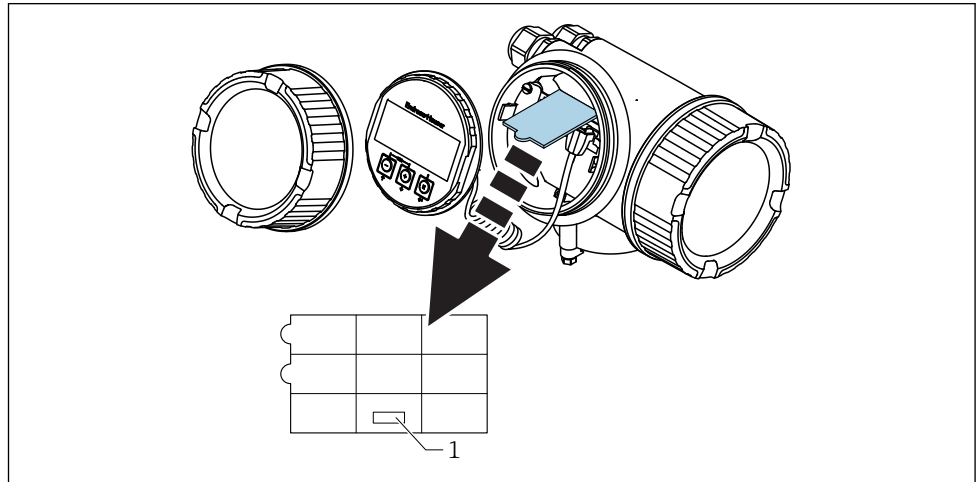

A0014241

1 Field for the new probe length

For documentation purposes, enter the new probe length into the Quick Setup which can be found in the electronics housing behind the display module.

6.2.3 Mounting the device

Mounting devices with thread

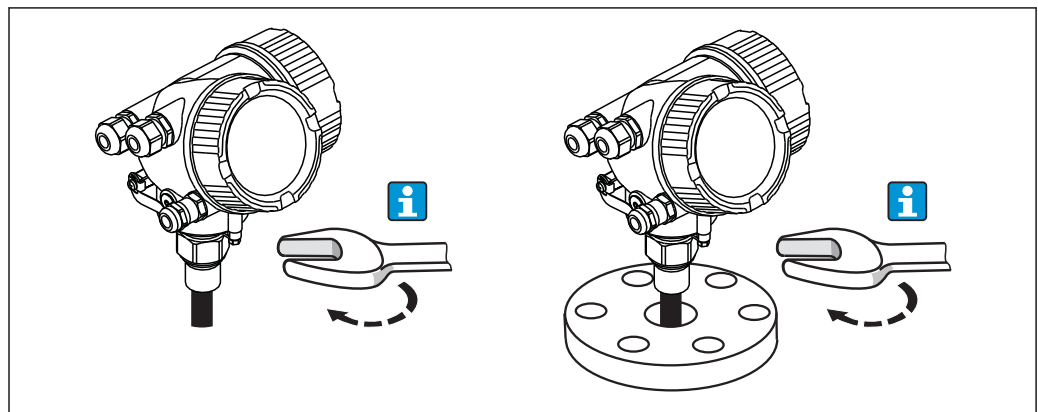

A0012528

Devices with mounting thread are screwed into a welding boss or a flange and are usually also secured with these.

- i
 - Tighten with the hexagonal nut only:
 - Thread 3/4": Hexagonal wrench 36 mm
 - Thread 1-1/2": Hexagonal wrench 55 mm
 - Maximum permissible torque:
 - Thread 3/4": 45 Nm
 - Thread 1-1/2": 450 Nm
 - Recommended torque when using the supplied aramid fibre seal and a process pressure of 40 bar (580 psi):
 - Thread 3/4": 25 Nm
 - Thread 1-1/2": 140 Nm
 - When installing in metal containers, take care to ensure good metallic contact between the process connection and container.

Mounting rope probes

NOTICE

Electrostatic discharges may damage the electronics.

- ▶ Earth the housing before lowering the rope into the vessel.

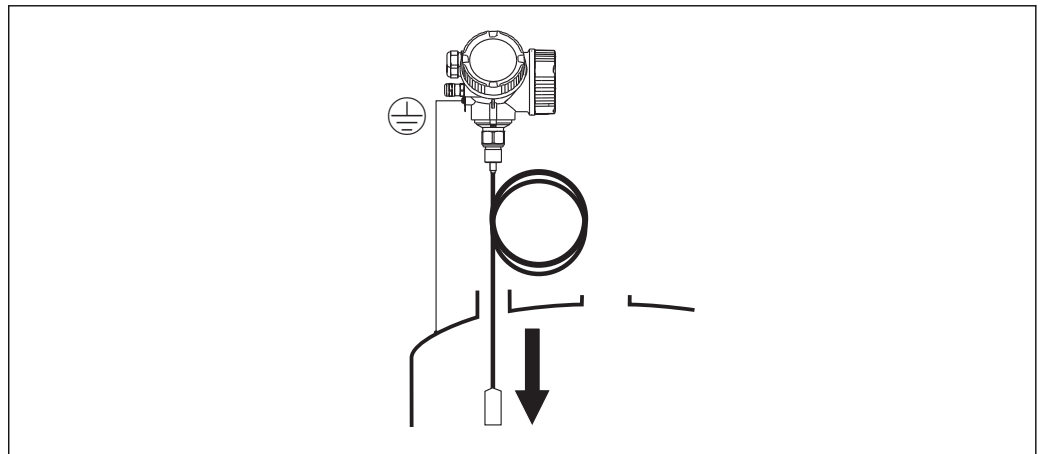

A0012852

When lowering the rope probe into the vessel, observe the following:

- Uncoil rope and lower it slowly and carefully into the vessel.
- Do not kink the rope.
- Avoid any backlash, since this might damage the probe or the vessel fittings.

6.2.4 Mounting the "Sensor remote" version

i This section is only valid for devices of the version "Probe Design" = "Sensor remote" (feature 600, option MB/MC/MD).

For the version "Probe design" = "Sensor remote" the following is supplied:

- The probe with the process connection
- The electronics housing
- The mounting bracket for wall or pipe mounting of the electronics housing
- The connection cable (length as ordered). The cable has got one straight and one angled plug (90°). Depending on the local conditions the angled plug can be connected at the probe or at the electronics housing.

⚠ CAUTION

The plugs of the connection cable may be damaged by mechanical stress.

- ▶ Mount the probe and the electronics housing tightly before connecting the cable.
- ▶ Lay the cable such that it is not exposed to mechanical stress. Minimum bending radius: 100 mm (4").
- ▶ When connecting the cable: Connect the straight plug before the angled one. Torque for both coupling nuts: 6 Nm.

i Probe, electronics and connection cable are adjusted to match each other. They are marked by a common serial number. Only components with the same serial number shall be connected to each other.

i If the measuring point is exposed to strong vibrations, an additional locking compound (e.g. Loctite 243) can be applied at the plug connectors.

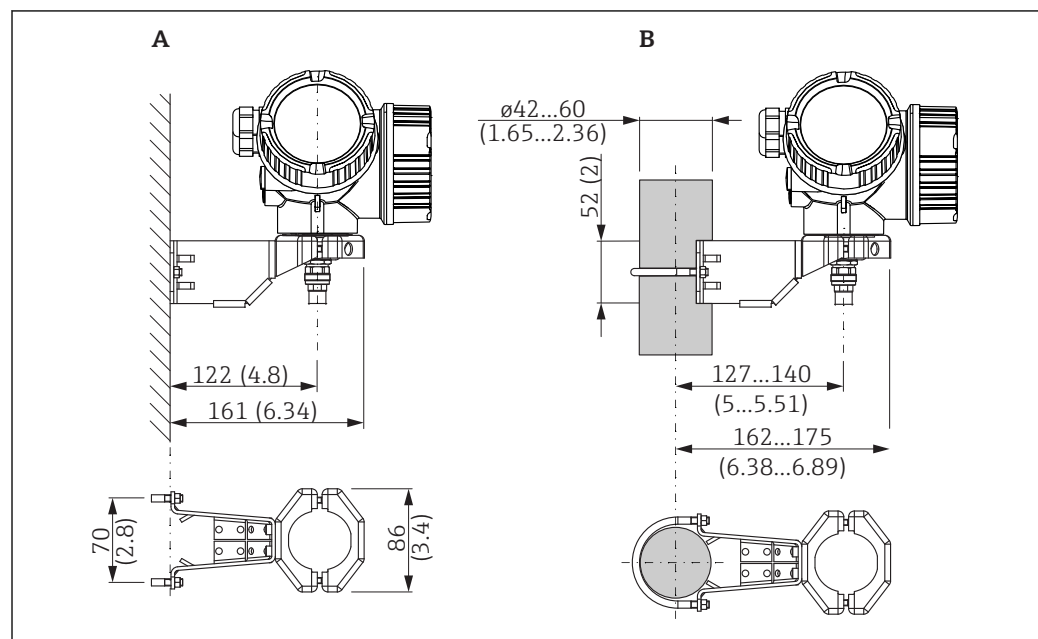
Mounting the electronics housing

7 Mounting the electronics housing using the mounting bracket; dimensions: mm (in)

A Wall mounting

B Pipe mounting

Connecting the cable**Required tools:**

Open-end wrench 18AF

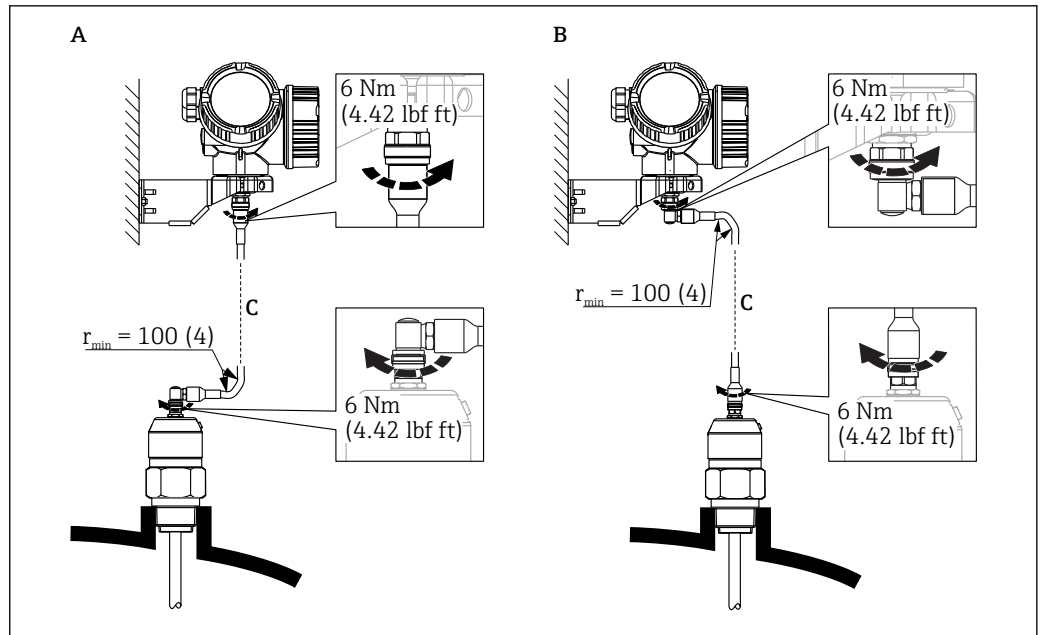

8 Connecting the cable. There are the following possibilities:

- A Angled plug at the probe
- B Angled plug at the electronics housing
- C Length of the remote cable as ordered

6.2.5 Turning the transmitter housing

To provide easier access to the connection compartment or display module, the transmitter housing can be turned:

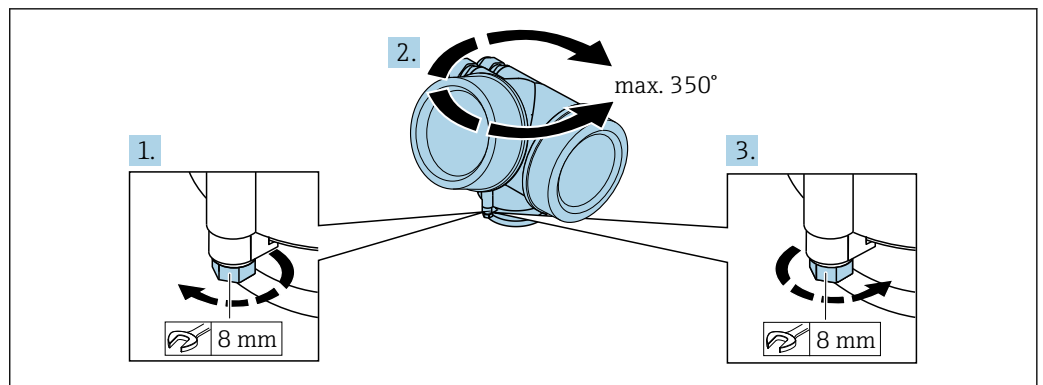

1. Unscrew the securing screw using an open-ended wrench.
2. Rotate the housing in the desired direction.
3. Tighten the securing screw (1.5 Nm for plastic housing; 2.5 Nm for aluminum or stainless steel housing).

6.2.6 Turning the display

Opening cover

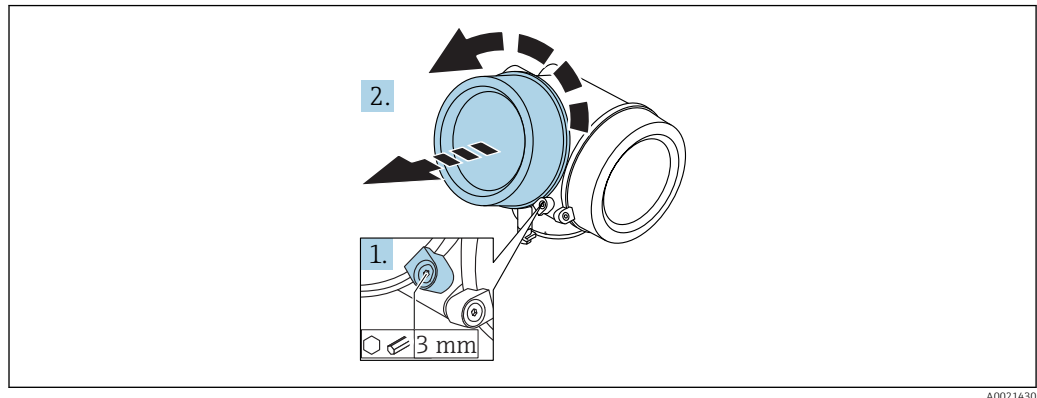

1. Loosen the screw of the securing clamp of the electronics compartment cover using an Allen key (3 mm) and turn the clamp 90° counterclockwise.
2. Unscrew cover and check lid gasket, replace if necessary.

Turning the display module

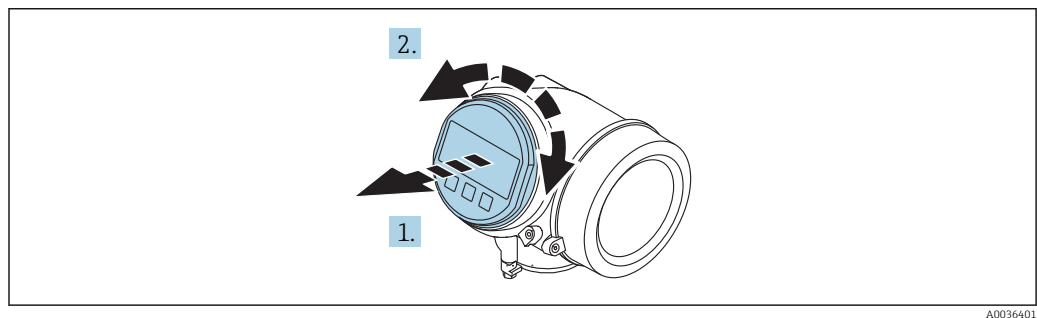

1. Pull out the display module with a gentle rotational movement.
2. Rotate the display module to the desired position: max. $8 \times 45^\circ$ in each direction.
3. Feed the coiled cable into the gap between the housing and main electronics module and plug the display module into the electronics compartment until it engages.

Closing electronics compartment cover

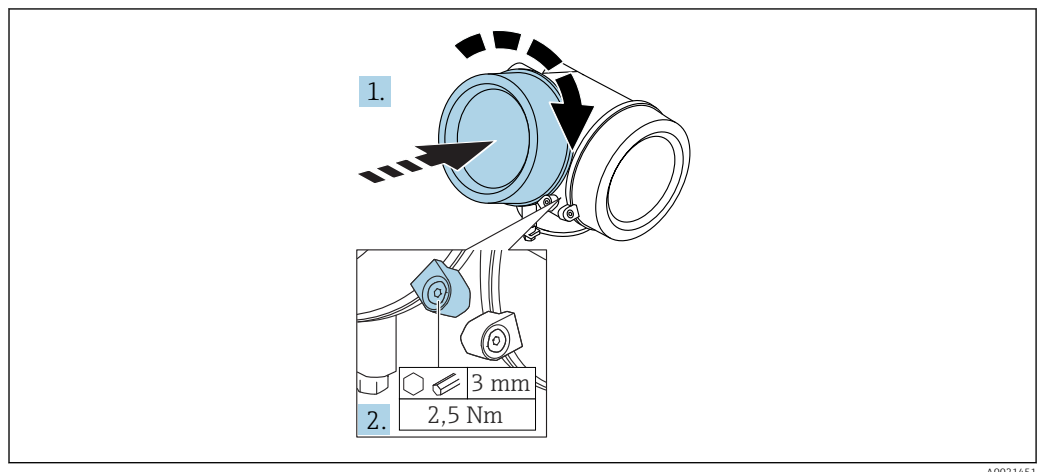

1. Screw back firmly electronics compartment cover.
2. Turning securing clamp 90 ° clockwise and tighten the clamp with 2.5 Nm using the Allen key (3 mm).

6.3 Post-installation check

<input type="radio"/>	Is the device undamaged (visual inspection)?
<input type="radio"/>	Does the device conform to the measuring point specifications? For example: <ul style="list-style-type: none">▪ Process temperature▪ Process pressure (refer to the chapter on "Material load curves" of the "Technical Information" document)▪ Ambient temperature range▪ Measuring range
<input type="radio"/>	Are the measuring point identification and labeling correct (visual inspection)?
<input type="radio"/>	Is the device adequately protected from precipitation and direct sunlight?
<input type="radio"/>	Are the securing screw and securing clamp tightened securely?

7 Electrical connection

7.1 Connection conditions

7.1.1 Terminal assignment

Terminal assignment 2-wire: 4-20 mA HART

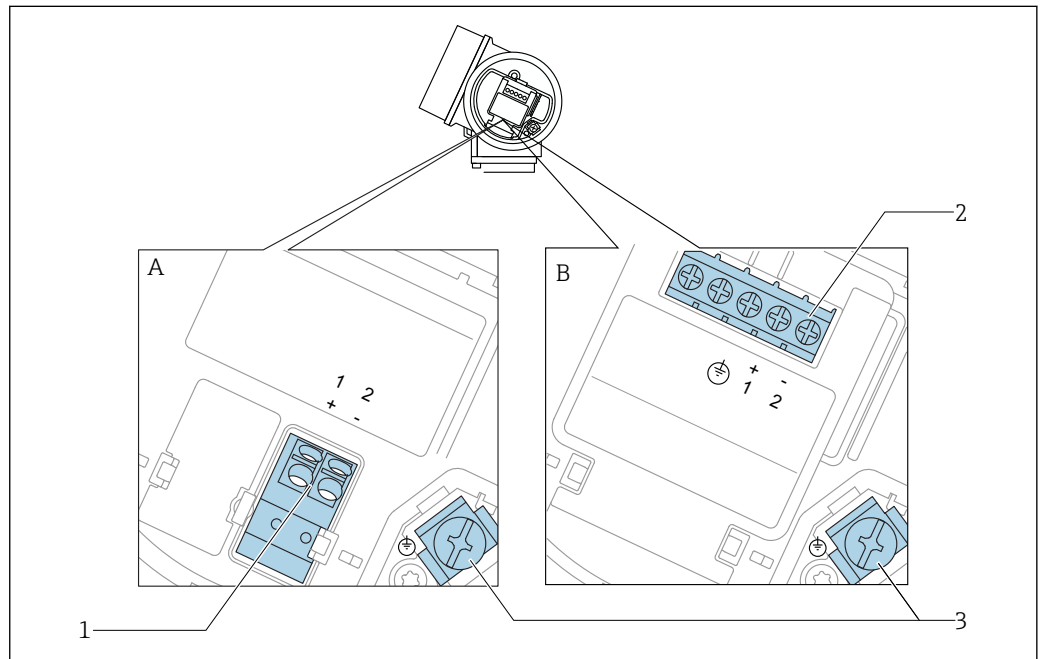

9 Terminal assignment 2-wire: 4-20 mA HART

A Without integrated overvoltage protection

B With integrated overvoltage protection

1 Connection 4-20 mA HART passive: terminals 1 and 2, without integrated overvoltage protection

2 Connection 4-20 mA HART passive: terminals 1 and 2, with integrated overvoltage protection

3 Terminal for cable screen

Block diagram 2-wire: 4-20 mA HART

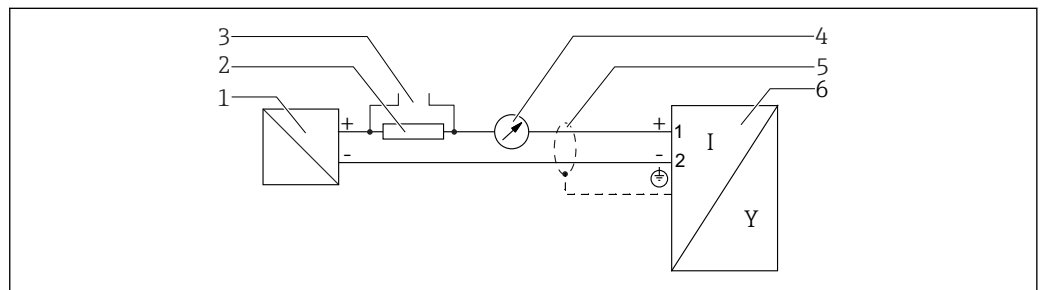

10 Block diagram 2-wire: 4-20 mA HART

1 Active barrier with power supply (e.g. RN221N); observe terminal voltage

2 HART communication resistor ($\geq 250 \Omega$); observe maximum load

3 Connection for Commubox FXA195 or FieldXpert SFX350/SFX370 (via VIATOR Bluetooth modem)

4 Analog display device; observe maximum load

5 Cable screen; observe cable specification

6 Measuring device

Terminal assignment 2-wire: 4-20 mA HART, switch output

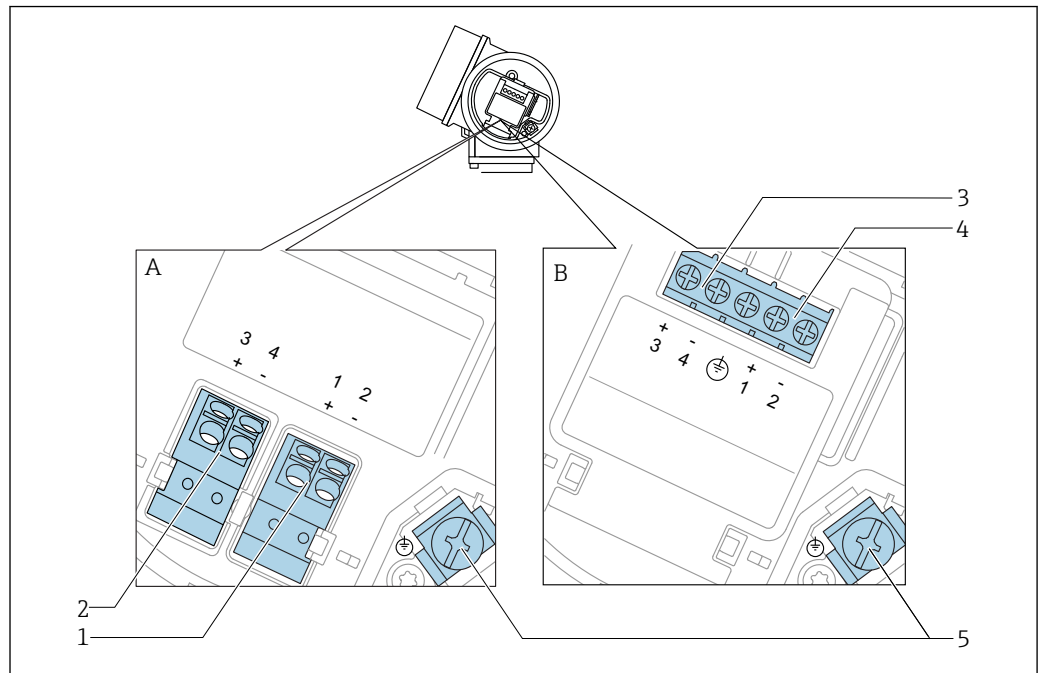

A0036500

11 Terminal assignment 2-wire: 4-20 mA HART, switch output

- A Without integrated overvoltage protection
- B With integrated overvoltage protection
- 1 Connection 4-20 mA HART passive: terminals 1 and 2, without integrated overvoltage protection
- 2 Connection switch output (Open Collector): terminals 3 and 4, without integrated overvoltage protection
- 3 Connection switch output (Open Collector): terminals 3 and 4, with integrated overvoltage protection
- 4 Connection 4-20 mA HART passive: terminals 1 and 2, with integrated overvoltage protection
- 5 Terminal for cable screen

Block diagram 2-wire: 4-20 mA HART, switch output

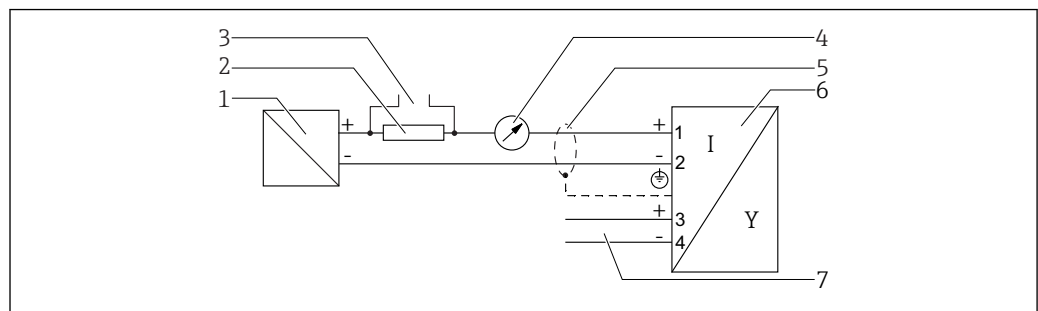

A0036501

12 Block diagram 2-wire: 4-20 mA HART, switch output

- 1 Active barrier with power supply (e.g. RN221N); observe terminal voltage
- 2 HART communication resistor ($\geq 250 \Omega$); observe maximum load
- 3 Connection for Commubox FXA195 or FieldXpert SFX350/SFX370 (via VIATOR Bluetooth modem)
- 4 Analog display device; observe maximum load
- 5 Cable screen; observe cable specification
- 6 Measuring device
- 7 Switch output (Open Collector)

Terminal assignment 2-wire: 4-20 mA HART, 4-20 mA

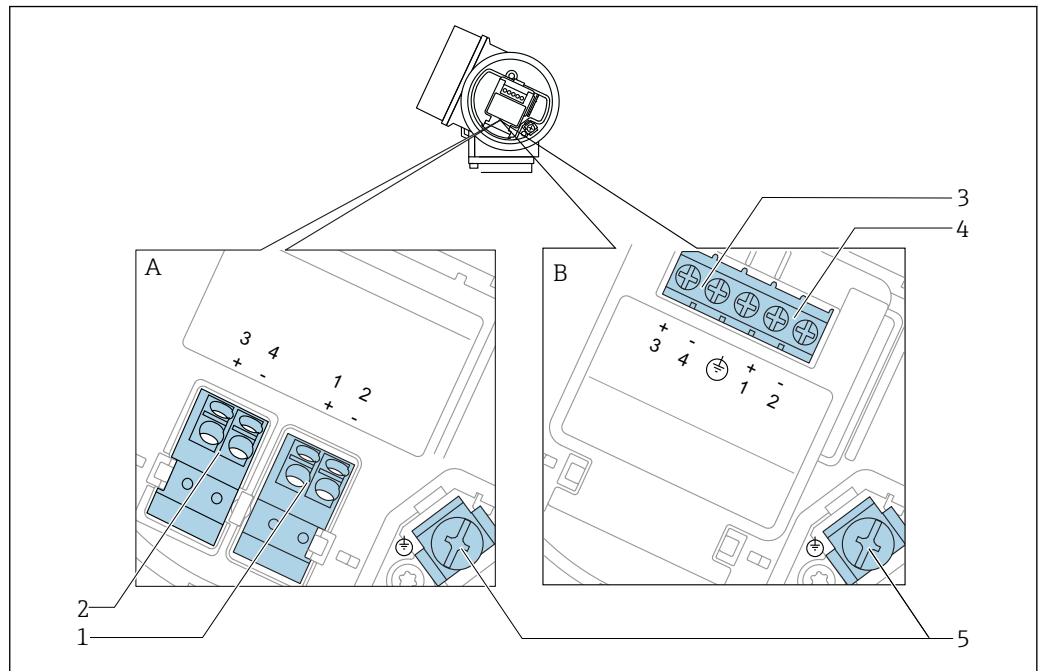

A0036500

13 Terminal assignment 2-wire: 4-20 mA HART, 4-20 mA

A Without integrated overvoltage protection

B With integrated overvoltage protection

1 Connection current output 1, 4-20 mA HART passive: terminals 1 and 2, without integrated overvoltage protection

2 Connection current output 2, 4-20 mA: terminals 3 and 4, without integrated overvoltage protection

3 Connection current output 2, 4-20 mA: terminals 3 and 4, with integrated overvoltage protection

4 Connection current output 1, 4-20 mA HART passive: terminals 1 and 2, with integrated overvoltage protection

5 Terminal for cable screen

Block diagram 2-wire: 4-20 mA HART, 4-20 mA

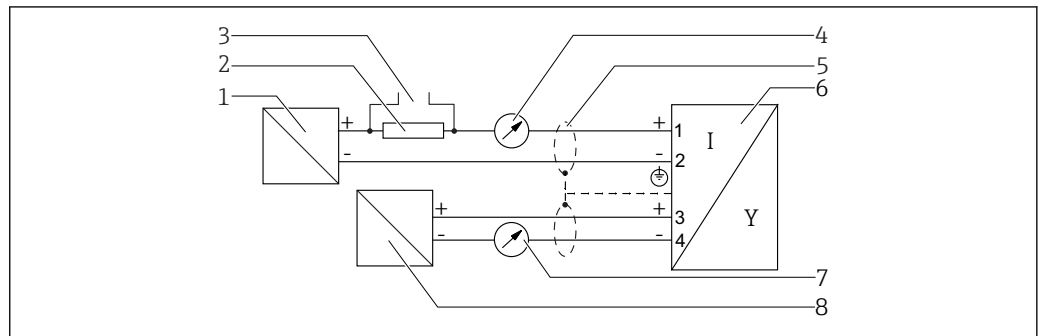

A0036502

14 Block diagram 2-wire: 4-20 mA HART, 4-20 mA

1 Active barrier with power supply (e.g. RN221N); observe terminal voltage

2 HART communication resistor ($\geq 250 \Omega$); observe maximum load

3 Connection for Commubox FXA195 or FieldXpert SFX350/SFX370 (via VIATOR Bluetooth modem)

4 Analog display device; observe maximum load

5 Cable screen; observe cable specification

6 Measuring device

7 Analog display device; observe maximum load

8 Active barrier with power supply (e.g. RN221N), current output 2; observe terminal voltage

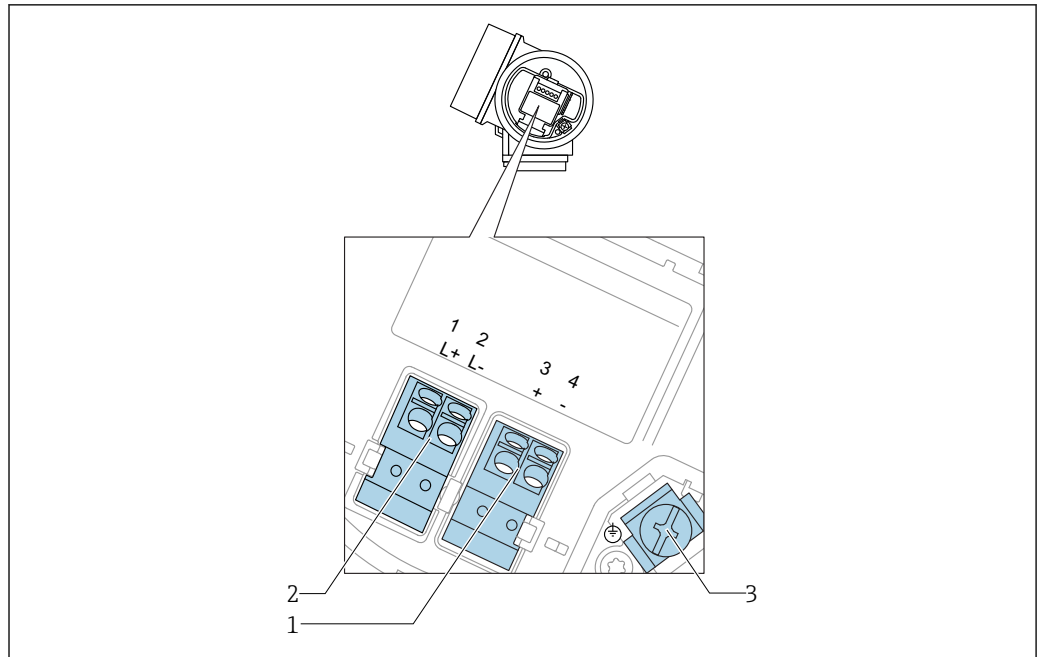
Terminal assignment 4-wire: 4-20 mA HART (10.4 to 48 V_{DC})

A0036516

15 Terminal assignment 4-wire: 4-20 mA HART (10.4 to 48 V_{DC})

- 1 Connection 4-20 mA HART (active): terminals 3 and 4
- 2 Connection supply voltage: terminals 1 and 2
- 3 Terminal for cable screen

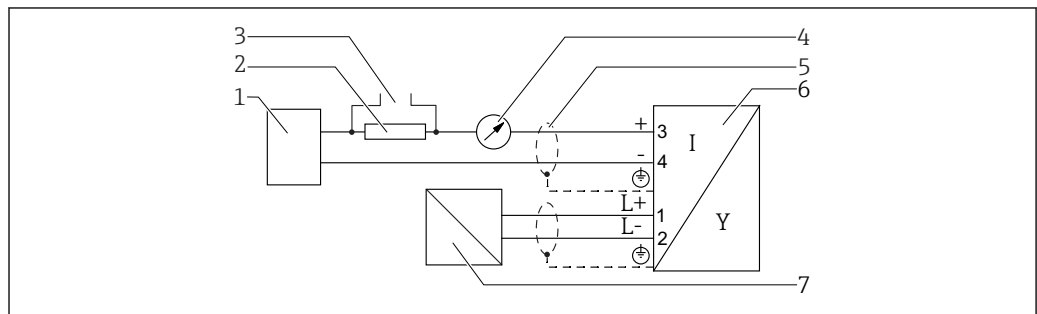
Block diagram 4-wire: 4-20 mA HART (10.4 to 48 V_{DC})

A0036526

16 Block diagram 4-wire: 4-20 mA HART (10.4 to 48 V_{DC})

- 1 Evaluation unit, e.g. PLC
- 2 HART communication resistor ($\geq 250 \Omega$); observe maximum load
- 3 Connection for Commubox FXA195 or FieldXpert SFX350/SFX370 (via VIATOR Bluetooth modem)
- 4 Analog display device; observe maximum load
- 5 Cable screen; observe cable specification
- 6 Measuring device
- 7 Supply voltage; observe terminal voltage, observe cable specification

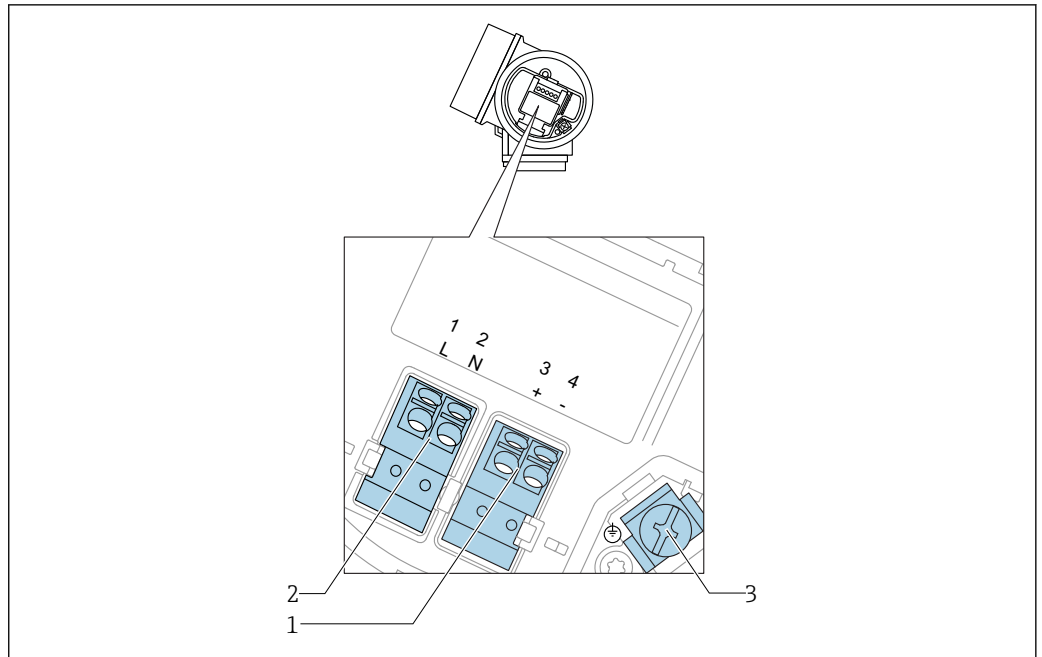
Terminal assignment 4-wire: 4-20 mA HART (90 to 253 V_{AC})

A0036519

17 Terminal assignment 4-wire: 4-20 mA HART (90 to 253 V_{AC})

- 1 Connection 4-20 mA HART (active): terminals 3 and 4
- 2 Connection supply voltage: terminals 1 and 2
- 3 Terminal for cable screen

CAUTION

To ensure electrical safety:

- ▶ Do not disconnect the protective connection.
- ▶ Disconnect the supply voltage before disconnecting the protective earth.

- i** Connect protective earth to the internal ground terminal (3) before connecting the supply voltage. If necessary, connect the potential matching line to the external ground terminal.
- i** In order to ensure electromagnetic compatibility (EMC): Do **not** only ground the device via the protective earth conductor of the supply cable. Instead, the functional grounding must also be connected to the process connection (flange or threaded connection) or to the external ground terminal.
- i** An easily accessible power switch must be installed in the proximity of the device. The power switch must be marked as a disconnector for the device (IEC/EN61010).

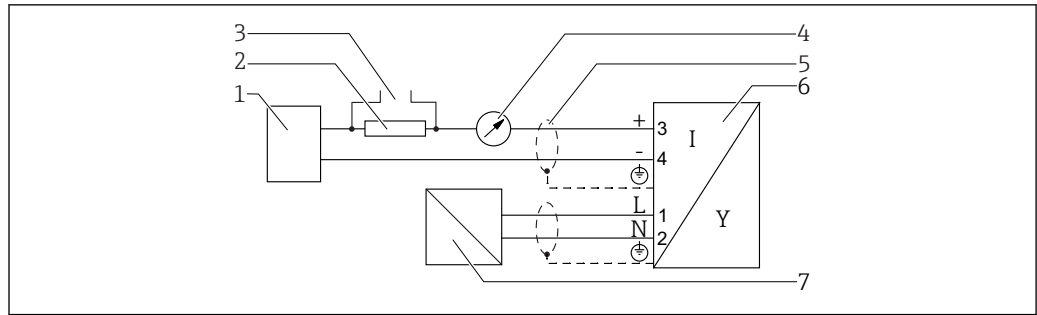
Block diagram 4-wire: 4-20 mA HART (90 to 253 V_{AC})

A0036527

18 Block diagram 4-wire: 4-20 mA HART (90 to 253 V_{AC})

- 1 Evaluation unit, e.g. PLC
- 2 HART communication resistor ($\geq 250 \Omega$); observe maximum load
- 3 Connection for Commubox FXA195 or FieldXpert SFX350/SFX370 (via VIATOR Bluetooth modem)
- 4 Analog display device; observe maximum load
- 5 Cable scree; observe cable specification
- 6 Measuring device
- 7 Supply voltage; observe terminal voltage, observe cable specification

Connection examples for the switch output

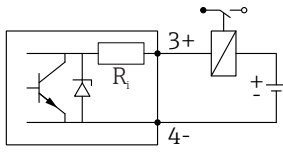
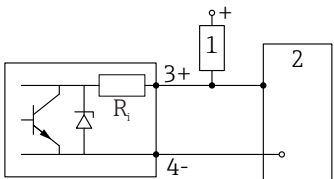
 <p>19 Connection of a relay</p> <p>Suitable relays (examples):</p> <ul style="list-style-type: none"> ▪ Solid-state relay: Phoenix Contact OV-24DC/480AC/5 with mounting rail connector UMK-1 OM-R/AMS ▪ Electromechanical relay: Phoenix Contact PLC-RSC-12DC/21 	 <p>20 Connection of a digital input</p> <p>1 Pull-up resistor 2 Digital input</p>
--	--

i For optimum interference immunity we recommend to connect an external resistor (internal resistance of the relay or Pull-up resistor) of < 1 000 Ω.

7.1.2 Cable specification

- **Devices without integrated overvoltage protection**
Pluggable spring-force terminals for wire cross-sections 0.5 to 2.5 mm² (20 to 14 AWG)
- **Devices with integrated overvoltage protection**
Screw terminals for wire cross-sections 0.2 to 2.5 mm² (24 to 14 AWG)
- For ambient temperature T_U ≥ 60 °C (140 °F): use cable for temperature T_U + 20 K.

HART

- A normal device cable suffices if only the analog signal is used.
- A shielded cable is recommended if using the HART protocol. Observe grounding concept of the plant.
- For 4-wire devices: Standard device cable is sufficient for the power line.

7.1.3 Device plug connectors

i For the versions with fieldbus plug connector (M12 or 7/8"), the signal line can be connected without opening the housing.

Pin assignment of the M12 plug connector

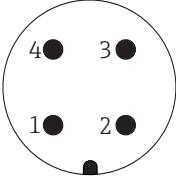
 <small>A0011175</small>	Pin	Meaning
	1	Signal +
	2	not connected
	3	Signal -
	4	Ground

Pin assignment of the 7/8" plug connector

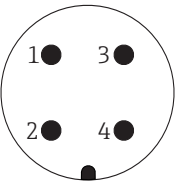
 <small>A0011176</small>	Pin	Meaning
	1	Signal -
	2	Signal +
	3	Not connected
	4	Screen

7.1.4 Power supply

2-wire, 4-20mA HART, passive

2-wire; 4-20mA HART¹⁾

"Approval" ²⁾	Terminal voltage U at the device	Maximum load R, depending on the supply voltage U ₀ at the supply unit
<ul style="list-style-type: none"> ▪ Non-Ex ▪ Ex nA ▪ Ex ic ▪ CSA GP 	11.5 to 35 V ^{3) 4)}	<p style="text-align: right; font-size: small;">A0035511</p>
Ex ia / IS	11.5 to 30 V ⁴⁾	
<ul style="list-style-type: none"> ▪ Ex d / XP ▪ Ex ic[ia] ▪ Ex tD / DIP 	13.5 to 30 V ^{4) 5)}	<p style="text-align: right; font-size: small;">A0034969</p>

- 1) Feature 020 of the product structure: option A
- 2) Feature 010 of the product structure
- 3) For ambient temperatures $T_a \leq -30\text{ °C}$ (-22 °F) a minimum voltage of 14 V is required for the sartup of the device at the minimum error current (3,6 mA). For ambient temperatures $T_a \geq 60\text{ °C}$ (140 °F) a minimum voltage of 12V is required for the sartup of the device at the minimum error current (3,6 mA). The sartup current can be parametrized. If the device is operated with a fixed current $I \geq 4,5\text{ mA}$ (HART multidrop mode), a voltage of $U \geq 11,5\text{ V}$ is sufficient throughout the entire range of ambient temperatures.
- 4) If the Bluetooth modem is used, the minimum supply voltage increases by 2 V.
- 5) For ambient temperatures $T_a \leq -20\text{ °C}$ (-4 °F) a minimum voltage of 16 V is required for the sartup of the device at the minimum error current (3.6 mA).

2-wire; 4-20 mA HART, switch output ¹⁾

"Approval" ²⁾	Terminal voltage U at the device	Maximum load R, depending on the supply voltage U ₀ at the supply unit
<ul style="list-style-type: none"> ■ Non-Ex ■ Ex nA ■ Ex nA[ia] ■ Ex ic ■ Ex ic[ia] ■ Ex d[ia] / XP ■ Ex ta / DIP ■ CSA GP 	13.5 to 35 V ^{3) 4)}	<p style="text-align: right; font-size: small;">A0034971</p>
<ul style="list-style-type: none"> ■ Ex ia / IS ■ Ex ia + Ex d[ia] / IS + XP 	13.5 to 30 V ^{3) 4)}	

- 1) Feature 020 of the product structure: option B
- 2) Feature 010 of the product structure
- 3) For ambient temperatures $T_a \leq -30\text{ °C}$ (-22 °F) a minimum voltage of 16 V is required for the startup of the device at the minimum error current (3.6 mA).
- 4) If the Bluetooth modem is used, the minimum supply voltage increases by 2 V.

2-wire; 4-20mA HART, 4-20mA ¹⁾

"Approval" ²⁾	Terminal voltage U at the device	Maximum load R, depending on the supply voltage U ₀ at the supply unit
any	Channel 1: 13.5 to 30 V ^{3) 4) 5)}	<p style="text-align: right; font-size: small;">A0034969</p>
	Channel 2: 12 to 30 V	

- 1) Feature 020 of the product structure: option C
- 2) Feature 010 of the product structure
- 3) For ambient temperatures $T_a \leq -30\text{ °C}$ (-22 °F) a minimum voltage of 16 V is required for the startup of the device at the minimum error current (3.6 mA).
- 4) For ambient temperatures $T_a \leq -40\text{ °C}$ (-40 °F), the maximum terminal voltage must be restricted to $U \leq 28\text{ V}$.
- 5) If the Bluetooth modem is used, the minimum supply voltage increases by 2 V.

Polarity reversal protection	Yes
Admissible residual ripple at f = 0 to 100 Hz	$U_{SS} < 1 \text{ V}$
Admissible residual ripple at f = 100 to 10000 Hz	$U_{SS} < 10 \text{ mV}$

4-wire, 4-20mA HART, active

"Power supply; Output" ¹⁾	Terminal voltage	Maximum load R_{\max}
K: 4-wire 90-253VAC; 4-20mA HART	90 to 253 V _{AC} (50 to 60 Hz), overvoltage category II	500 Ω
L: 4-wire 10,4-48VDC; 4-20mA HART	10.4 to 48 V _{DC}	

1) Feature 020 of the product structure

7.1.5 Overvoltage protection

If the measuring device is used for level measurement in flammable liquids which requires the use of overvoltage protection according to DIN EN 60079-14, standard for test procedures 60060-1 (10 kA, pulse 8/20 μs), an overvoltage protection module has to be installed.

Integrated overvoltage protection module

An integrated overvoltage protection module is available for 2-wire HART as well as PROFIBUS PA and FOUNDATION Fieldbus devices.

Product structure: Feature 610 "Accessory mounted", option NA "Overvoltage protection".

Technical data	
Resistance per channel	2 × 0.5 Ω max.
Threshold DC voltage	400 to 700 V
Threshold impulse voltage	< 800 V
Capacitance at 1 MHz	< 1.5 pF
Nominal arrest impulse voltage (8/20 μs)	10 kA

External overvoltage protection module

HAW562 or HAW569 from Endress+Hauser are suited as external overvoltage protection.



For detailed information please refer to the following documents:

- HAW562: TI01012K
- HAW569: TI01013K

7.2 Connecting the measuring device**⚠ WARNING****Risk of explosion!**

- ▶ Observe applicable national standards.
- ▶ Comply with the specifications in the Safety Instructions (XA).
- ▶ Use specified cable glands only.
- ▶ Check to ensure that the power supply matches the information on the nameplate.
- ▶ Switch off the power supply before connecting the device.
- ▶ Connect the potential matching line to the outer ground terminal before applying the power supply.

Required tools/accessories:

- For devices with a cover lock: Allen key AF3
- Wire stripper
- When using stranded cables: One ferrule for every wire to be connected.

7.2.1 Opening connection compartment cover

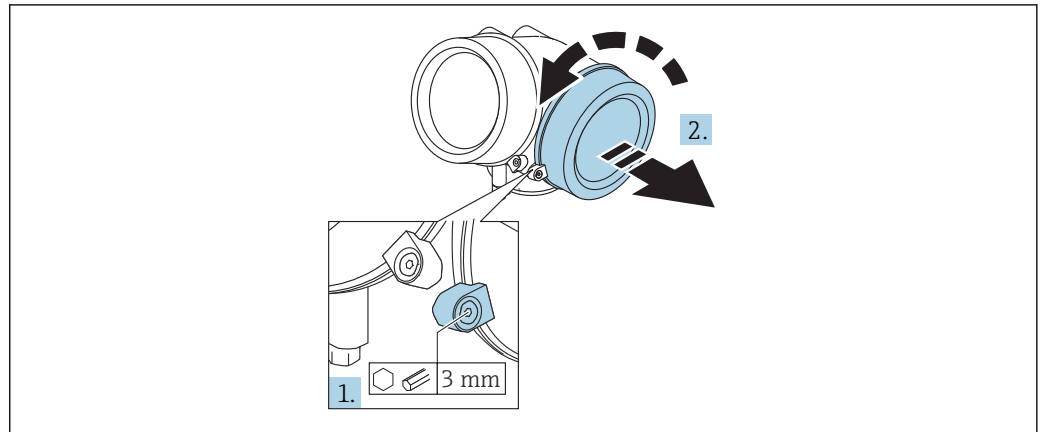

A0021490

1. Loosen the screw of the securing clamp of the connection compartment cover using an Allen key (3 mm) and turn the clamp 90° clockwise.
2. Afterwards unscrew connection compartment cover and check lid gasket, replace if necessary.

7.2.2 Connecting

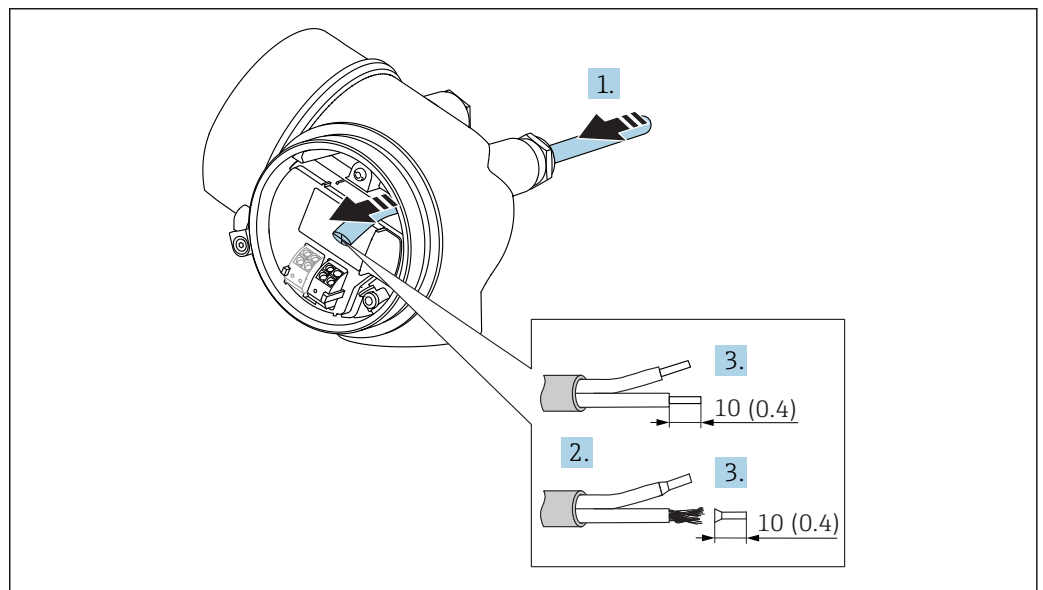

A0036418

21 Dimensions: mm (in)

1. Push the cable through the cable entry . To ensure tight sealing, do not remove the sealing ring from the cable entry.
2. Remove the cable sheath.
3. Strip the cable ends over a length of 10 mm (0.4 in). In the case of stranded cables, also fit ferrules.
4. Firmly tighten the cable glands.

5. Connect the cable in accordance with the terminal assignment.

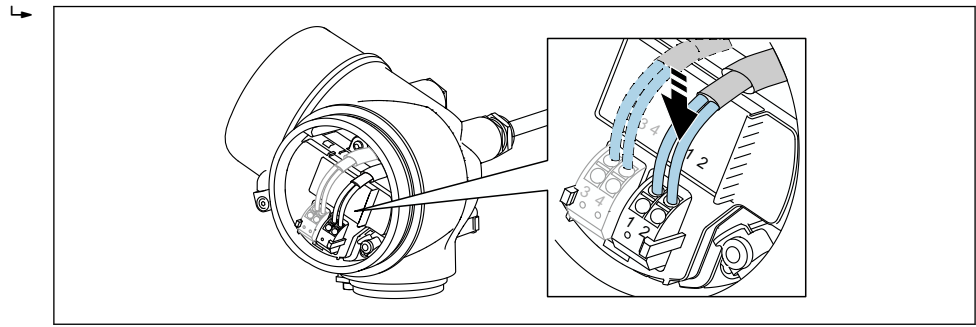

A0034682

6. If using shielded cables: Connect the cable shield to the ground terminal.

7.2.3 Plug-in spring-force terminals

In the case of devices without integrated overvoltage protection, electrical connection is via plug-in spring-force terminals. Rigid conductors or flexible conductors with ferrules can be inserted directly into the terminal without using the lever, and create a contact automatically.

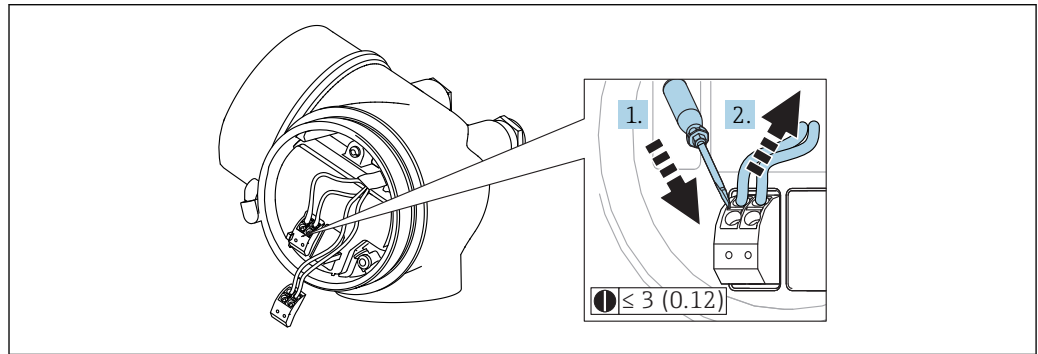

A0013661

22 Dimensions: mm (in)

To remove cables from the terminal:

1. Using a flat-blade screwdriver ≤ 3 mm, press down on the slot between the two terminal holes
2. while simultaneously pulling the cable end out of the terminal.

7.2.4 Closing connection compartment cover

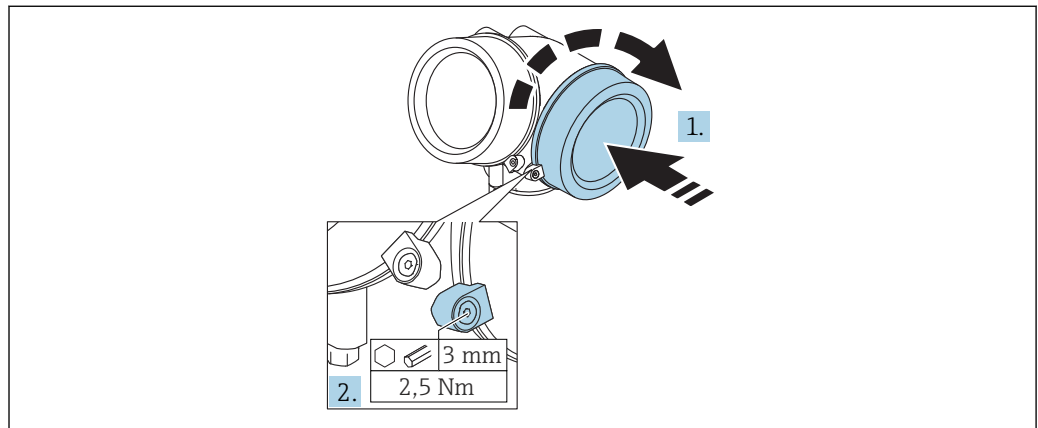

A0021491

1. Screw back firmly connection compartment cover.
2. Turning securing clamp 90 ° counterclockwise and tighten the clamp with 2.5 Nm (1.84 lbf ft) again using the Allen key (3 mm).

7.3 Post-connection check

<input type="checkbox"/>	Is the device or cable undamaged (visual check)?
<input type="checkbox"/>	Do the cables comply with the requirements ?
<input type="checkbox"/>	Do the cables have adequate strain relief?
<input type="checkbox"/>	Are all cable glands installed, securely tightened and leak-tight?
<input type="checkbox"/>	Does the supply voltage match the specifications on the nameplate?
<input type="checkbox"/>	Is the terminal assignment correct?
<input type="checkbox"/>	If required: Has protective ground connection been established ?
<input type="checkbox"/>	If supply voltage is present, is the device ready for operation and do values appear on the display module?
<input type="checkbox"/>	Are all housing covers installed and securely tightened?
<input type="checkbox"/>	Is the securing clamp tightened correctly?

8 Operation options

8.1 Overview

8.1.1 Local operation

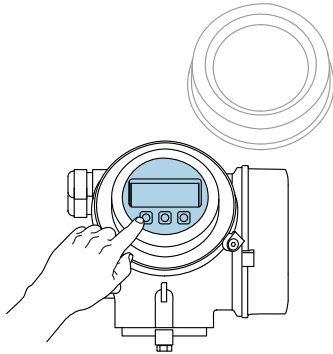
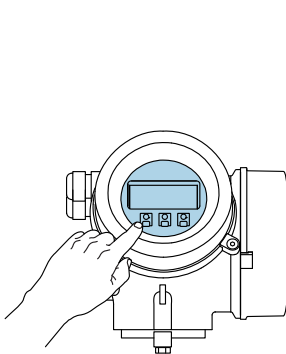
Operation with	<i>Pushbuttons</i>	<i>Touch Control</i>
Order code for "Display; Operation"	Option C "SD02"	Option E "SD03"
		
Display elements	4-line display	4-line display white background lighting; switches to red in event of device error
	Format for displaying measured variables and status variables can be individually configured	
	Permitted ambient temperature for the display: -20 to +70 °C (-4 to +158 °F) The readability of the display may be impaired at temperatures outside the temperature range.	
Operating elements	local operation with 3 push buttons (⊕, ⊖, ⊞)	external operation via touch control; 3 optical keys: ⊕, ⊖, ⊞
	Operating elements also accessible in various hazardous areas	
Additional functionality	Data backup function The device configuration can be saved in the display module.	
	Data comparison function The device configuration saved in the display module can be compared to the current device configuration.	
	Data transfer function The transmitter configuration can be transmitted to another device using the display module.	

8.1.2 Operation with remote display and operating module FHX50

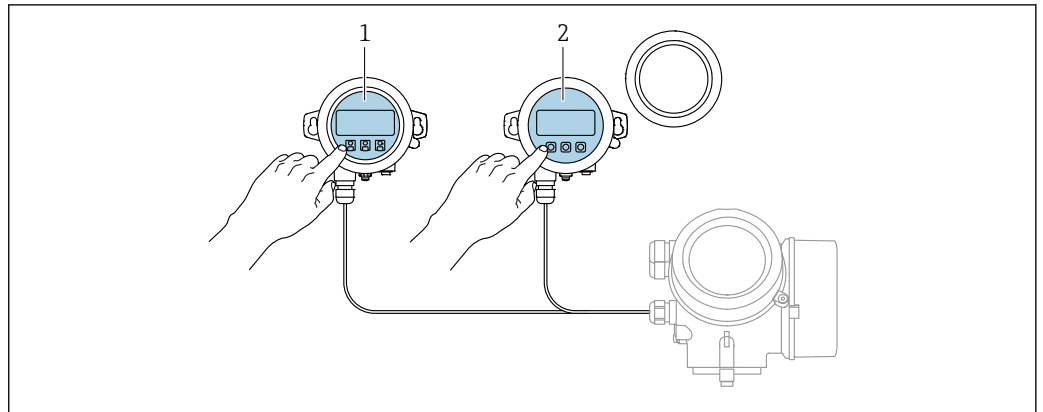

A0036314

23 FHX50 operating options

- 1 Display and operating module SD03, optical keys; can be operated through the glass of the cover
- 2 Display and operating module SD02, push buttons; cover must be removed

8.1.3 Operation via Bluetooth® wireless technology

Requirements

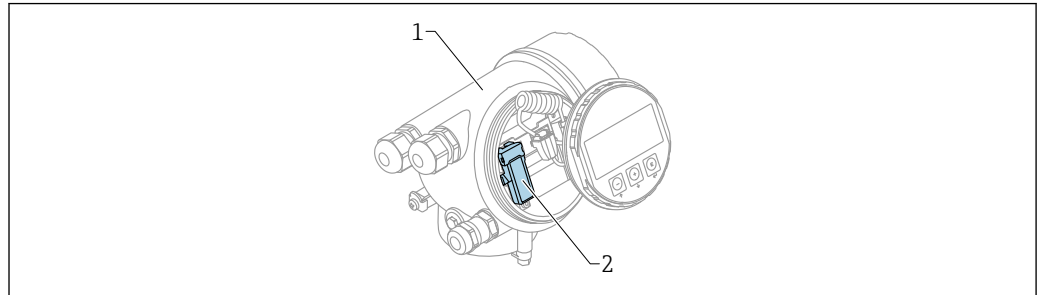

A0036790

24 Device with Bluetooth module

- 1 Electronics housing of the device
- 2 Bluetooth module

This operation option is only available for devices with Bluetooth module. There are the following options:

- The device has been ordered with a Bluetooth module:
Feature 610 "Accessory Mounted", option NF "Bluetooth"
- The Bluetooth module has been ordered as an accessory (ordering number: 71377355) and has been mounted. See Special Documentation SD02252F.

Operation via SmartBlue (app)

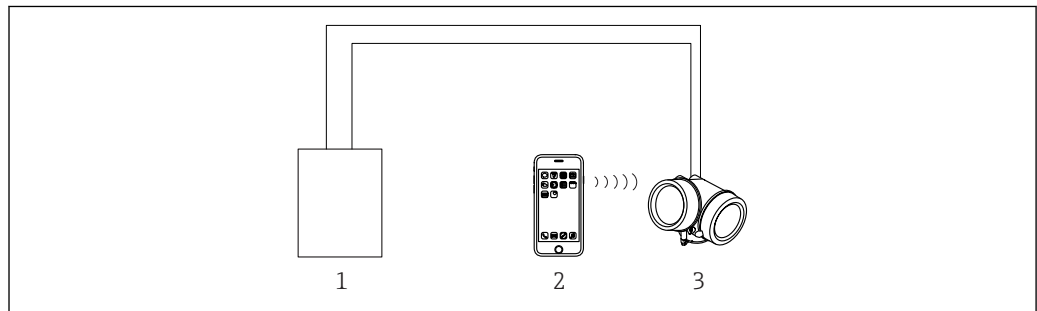

A0034939

25 Operation via SmartBlue (app)

- 1 Transmitter power supply unit
- 2 Smartphone / tablet with SmartBlue (app)
- 3 Transmitter with Bluetooth module

8.1.4 Remote operation

Via HART protocol

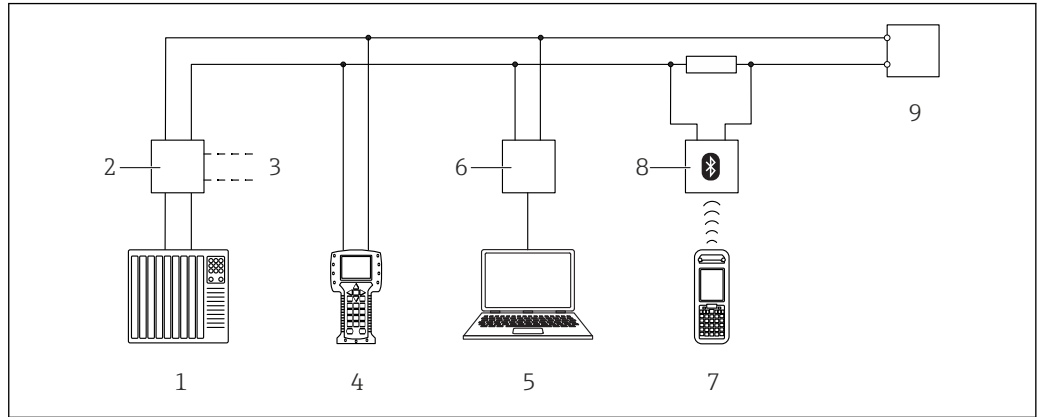

A0036169

26 Options for remote operation via HART protocol

- 1 PLC (Programmable Logic Controller)
- 2 Transmitter power supply unit, e.g. RN221N (with communication resistor)
- 3 Connection for Commubox FXA191, FXA195 and Field Communicator 375, 475
- 4 Field Communicator 475
- 5 Computer with operating tool (e.g. DeviceCare/FieldCare, AMS Device Manager, SIMATIC PDM)
- 6 Commubox FXA191 (RS232) or FXA195 (USB)
- 7 Field Xpert SFX350/SFX370
- 8 VIATOR Bluetooth modem with connecting cable
- 9 Transmitter

DeviceCare/FieldCare via service interface (CDI)

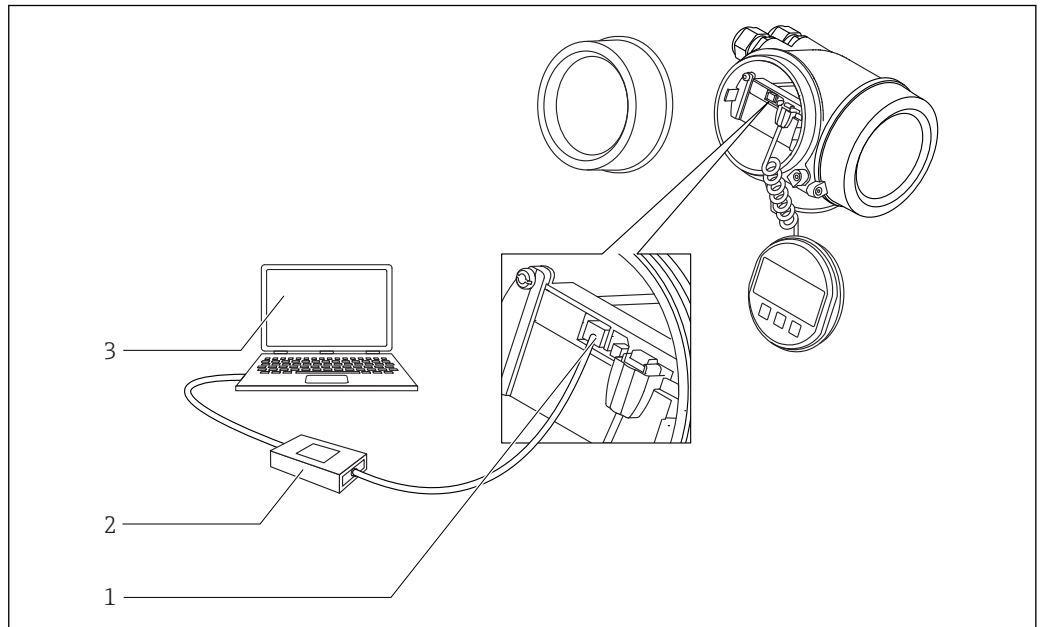

A0032466

27 DeviceCare/FieldCare via service interface (CDI)

- 1 Service interface (CDI) of the instrument (= Endress+Hauser Common Data Interface)
- 2 Commubox FXA291
- 3 Computer with DeviceCare/FieldCare operating tool

8.2 Structure and function of the operating menu

8.2.1 Structure of the operating menu

Menu	Submenu / parameter	Meaning
	Language ¹⁾	Defines the operating language of the on-site display
Commissioning ²⁾		Launches the interactive wizard for guided commissioning. Additional settings generally do not need to be made in the other menus when the wizard is finished.
Setup	Parameter 1 ... Parameter N	Once values have been set for these parameters, the measurement should generally be completely configured.
	Advanced setup	Contains additional submenus and parameters: <ul style="list-style-type: none"> ▪ to adapt the device to special measuring conditions. ▪ to process the measured value (scaling, linearization). ▪ to configure the signal output.
Diagnostics	Diagnostic list	Contains up to 5 currently active error messages.
	Event logbook ³⁾	Contains the last 20 messages (which are no longer active).
	Device information	Contains information for identifying the device.
	Measured values	Contains all current measured values.
	Data logging	Contains the history of the individual measuring values.
	Simulation	Is used to simulate measured values or output values.
	Device check	Contains all parameters needed to check the measurement capability of the device.
Expert ⁵⁾ Contains all parameters of the device (including those that are already in one of the other menus). This menu is organized according to the function blocks of the device. The parameters of the Expert menu are described in: GPO1000F (HART)	System	Contains all higher-order device parameters that do not concern the measurement or measured value communication.
	Sensor	Contains all parameters needed to configure the measurement.
	Output	<ul style="list-style-type: none"> ▪ Contains all parameters needed to configure the current output. ▪ Contains all parameters needed to configure the switch output (PFS).

Menu	Submenu / parameter	Meaning
	Communication	Contains all parameters needed to configure the digital communication interface.
	Diagnostics	Contains all parameters needed to detect and analyze operational errors.

- 1) If operating via operating tools (e.g. FieldCare), the "Language" parameter is located under "Setup → Advanced setup → Display"
- 2) Only if operating via an FDT/DTM system
- 3) only available with local operation
- 4) only available if operating via DeviceCare or FieldCare
- 5) On entering the "Expert" menu, an access code is always requested. If a customer specific access code has not been defined, "0000" has to be entered.

8.2.2 User roles and related access authorization

The two user roles **Operator** and **Maintenance** have different write access to the parameters if a device-specific access code has been defined. This protects the device configuration via the local display from unauthorized access →  68.

Access authorization to parameters

User role	Read access		Write access	
	Without access code (from the factory)	With access code	Without access code (from the factory)	With access code
Operator	✓	✓	✓	--
Maintenance	✓	✓	✓	✓

If an incorrect access code is entered, the user obtains the access rights of the **Operator** role.

 The user role with which the user is currently logged on is indicated by the **Access status display** parameter (for display operation) or **Access status tooling** parameter (for tool operation).

8.2.3 Data access - Security

Write protection via access code

Using the device-specific access code, the parameters for the measuring device configuration are write-protected and their values can no longer be changed via local operation.

Define access code via local display

1. Navigate to: Setup → Advanced setup → Administration → Define access code → Define access code
2. Define a max. 4-digit numeric code as an access code.
3. Repeat the same code in **Confirm access code** parameter.
 - ↳ The -symbol appears in front of all write-protected parameters.



Define access code via operating tool (e.g. FieldCare)

1. Navigate to: Setup → Advanced setup → Administration → Define access code
2. Define a max. 4-digit numeric code as an access code.
 - ↳ Write protection is active.



Parameters that can always be changed

The write protection does not include certain parameters that do not affect the measurement. Despite the defined access code, they can always be modified, even if the other parameters are locked.



The device automatically locks the write-protected parameters again if a key is not pressed for 10 minutes in the navigation and editing view. The device locks the write-protected parameters automatically after 60 s if the user skips back to the measured value display mode from the navigation and editing view.

-  If write access is activated via access code, it can be also be deactivated only via the access code →  69.
- In the "Description of Device Parameters" documents, each write-protected parameter is identified with the -symbol.

Disabling write protection via access code

If the -symbol appears on the local display in front of a parameter, the parameter is write-protected by a device-specific access code and its value cannot be changed at the moment using the local display →  68.

The locking of the write access via local operation can be disabled by entering the device-specific access code.

1. After you press , the input prompt for the access code appears.
2. Enter the access code.
 - ↳ The -symbol in front of the parameters disappears; all previously write-protected parameters are now re-enabled.

Deactivation of the write protection via access code

Via local display

1. Navigate to: Setup → Advanced setup → Administration → Define access code → Define access code
2. Enter **0000**.
3. Repeat **0000** in **Confirm access code** parameter.
 - ↳ The write protection is deactivated. Parameters can be changed without entering an access code.

Via an operating tool (e.g. FieldCare)

1. Navigate to: Setup → Advanced setup → Administration → Define access code
2. Enter **0000**.
 - ↳ The write protection is deactivated. Parameters can be changed without entering an access code.

Write protection via write protection switch

Unlike parameter write protection via a user-specific access code, this allows write access to the entire operating menu - except for the **"Contrast display" parameter** - to be locked.

The parameter values are now read only and cannot be edited any more (exception **"Contrast display" parameter**):

- Via local display
- Via service interface (CDI)
- Via HART protocol

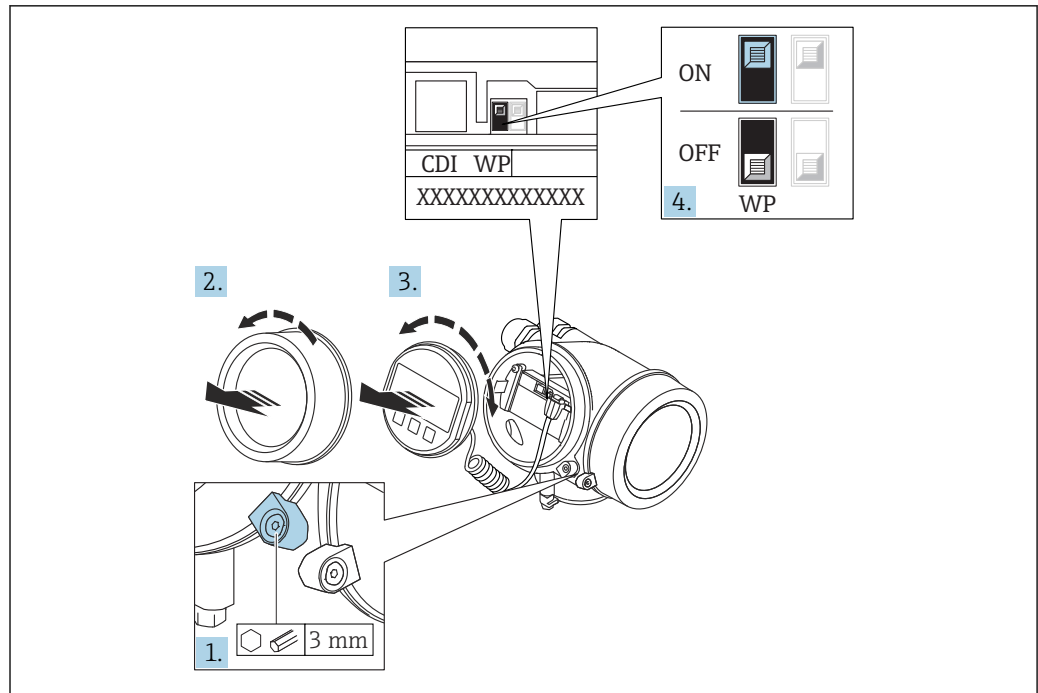

A0026157

1. Loosen the securing clamp.
2. Unscrew the electronics compartment cover.
3. Pull out the display module with a gentle rotational movement. To make it easier to access the lock switch, attach the display module to the edge of the electronics compartment.

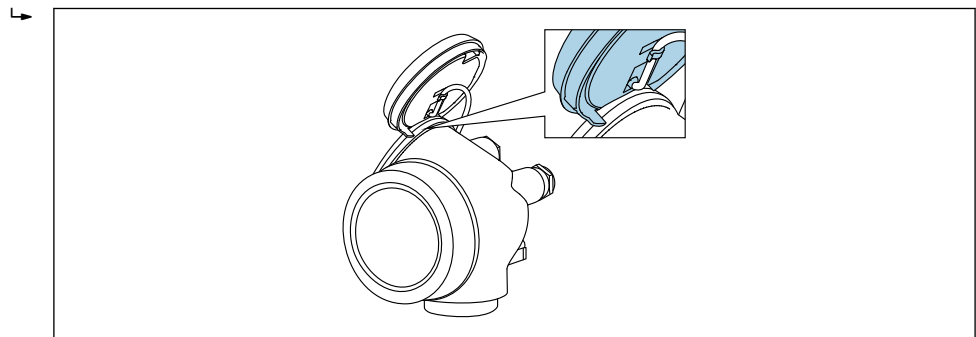

A0036086

4. Setting the write protection switch (WP) on the main electronics module to the **ON** position enables hardware write protection. Setting the write protection switch (WP) on the main electronics module to the **OFF** position (factory setting) disables hardware write protection.
 - ↳ If the hardware write protection is enabled: The **Hardware locked** option is displayed in the **Locking status** parameter. In addition, on the local display the -symbol appears in front of the parameters in the header of the operational display and in the navigation view.

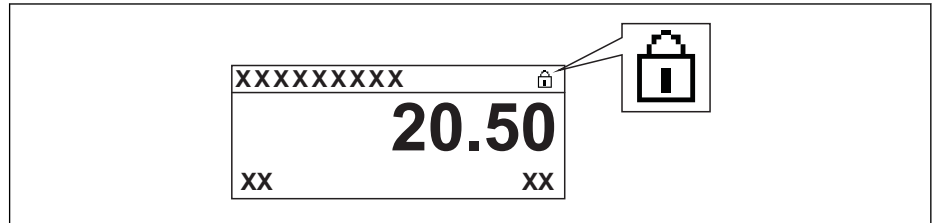

A0015870

If the hardware write protection is disabled: No option is displayed in the **Locking status** parameter. On the local display, the -symbol disappears from in front of the parameters in the header of the operational display and in the navigation view.

5. Feed the cable into the gap between the housing and main electronics module and plug the display module into the electronics compartment in the desired direction until it engages.
6. Reverse the removal procedure to reassemble the transmitter.

Enabling and disabling the keypad lock

The keypad lock makes it possible to block access to the entire operating menu via local operation. As a result, it is no longer possible to navigate through the operating menu or change the values of individual parameters. Users can only read the measured values on the operational display.

The keypad lock is switched on and off via the context menu.

Switching on the keypad lock



For the SD03 display only

The keypad lock is switched on automatically:

- If the device has not been operated via the display for > 1 minute.
- Each time the device is restarted.

To activate the keylock manually:

1. The device is in the measured value display.
Press for at least 2 seconds.
↳ A context menu appears.
2. In the context menu select the **Keylock on** option.
↳ The keypad lock is switched on.



If the user attempts to access the operating menu while the keypad lock is active, the message **Keylock on** appears.

Switching off the keypad lock

1. The keypad lock is switched on.
Press for at least 2 seconds.
↳ A context menu appears.
2. In the context menu select the **Keylock off** option.
↳ The keypad lock is switched off.

Bluetooth® wireless technology

Signal transmission via Bluetooth® wireless technology uses a cryptographic technique tested by the Fraunhofer Institute

- The device is not visible via *Bluetooth*® wireless technology without the SmartBlue app
- Only one point-to-point connection between **one** sensor and **one** smartphone or tablet is established

8.3 Display and operating module

8.3.1 Display appearance

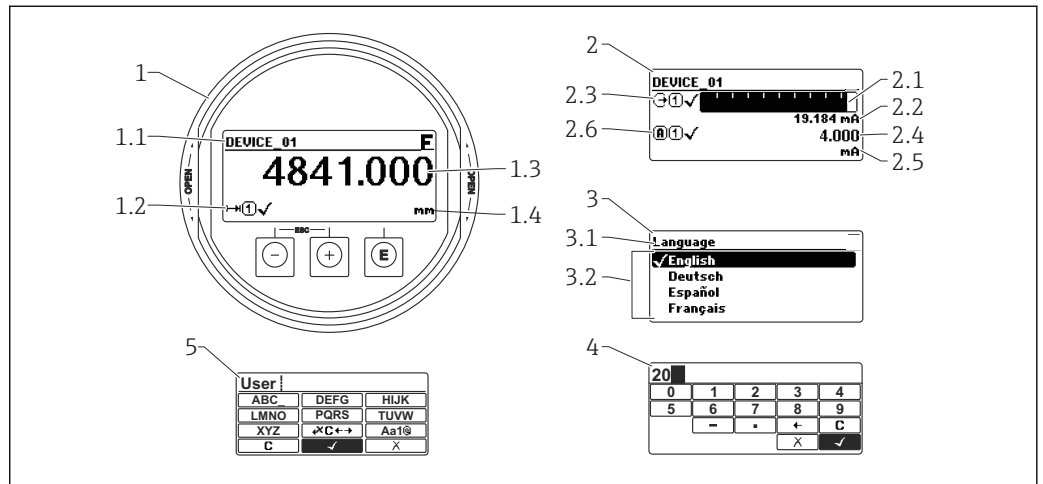





A0012635

28 Appearance of the display and operation module for on-site operation

- 1 Measured value display (1 value max. size)
- 1.1 Header containing tag and error symbol (if an error is active)
- 1.2 Measured value symbols
- 1.3 Measured value
- 1.4 Unit
- 2 Measured value display (1 bargraph + 1 value)
- 2.1 Bargraph for measured value 1
- 2.2 Measured value 1 (including unit)
- 2.3 Measured value symbols for measured value 1
- 2.4 Measured value 2
- 2.5 Unit for measured value 2
- 2.6 Measured value symbols for measured value 2
- 3 Representation of a parameter (here: a parameter with selection list)
- 3.1 Header containing parameter name and error symbol (if an error is active)
- 3.2 Selection list; marks the current parameter value.
- 4 Input matrix for numbers
- 5 Input matrix for alphanumeric and special characters



Display symbols for the submenus

Symbol	Meaning
 <small>A0018367</small>	Display/operation Is displayed: <ul style="list-style-type: none"> in the main menu next to the selection "Display/operation" in the header, if you are in the "Display/operation" menu
 <small>A0018364</small>	Setup Is displayed: <ul style="list-style-type: none"> in the main menu next to the selection "Setup" in the header, if you are in the "Setup" menu
 <small>A0018365</small>	Expert Is displayed: <ul style="list-style-type: none"> in the main menu next to the selection "Expert" in the header, if you are in the "Expert" menu
 <small>A0018366</small>	Diagnostics Is displayed: <ul style="list-style-type: none"> in the main menu next to the selection "Diagnostics" in the header, if you are in the "Diagnostics" menu











Status signals

F <small>A0032902</small>	"Failure" A device error is present. The measured value is no longer valid.
C <small>A0032903</small>	"Function check" The device is in service mode (e.g. during a simulation).
S <small>A0032904</small>	"Out of specification" The device is operated: <ul style="list-style-type: none"> Outside of its technical specifications (e.g. during startup or a cleaning) Outside of the configuration carried out by the user (e.g. level outside configured span)
M <small>A0032905</small>	"Maintenance required" Maintenance is required. The measured value is still valid.







Display symbols for the locking state

Symbol	Meaning
 <small>A0013148</small>	Display parameter Marks display-only parameters which can not be edited.
 <small>A0013150</small>	Device locked <ul style="list-style-type: none"> In front of a parameter name: The device is locked via software and/or hardware. In the header of the measured value screen: The device is locked via hardware.

Measured value symbols

Symbol	Meaning
Measured values	
 <small>A0032892</small>	Level
 <small>A0032893</small>	Distance
 <small>A0032908</small>	Current output
 <small>A0032894</small>	Measured current
 <small>A0032895</small>	Terminal voltage
 <small>A0032896</small>	Temperature of the electronics or the sensor
Measuring channels	
 <small>A0032897</small>	Measuring channel 1
 <small>A0032898</small>	Measuring channel 2
Status of the measured value	
 <small>A0018361</small>	<p>Status "Alarm"</p> <p>The measurement is interrupted. The output assumes the defined alarm value. A diagnostic message is generated.</p>
 <small>A0018360</small>	<p>Status "Warning"</p> <p>The device continues measuring. A diagnostic message is generated.</p>

8.3.2 Operating elements

Key	Meaning
 <small>A0018330</small>	<p>Minus key</p> <p><i>For menu, submenu</i> Moves the selection bar upwards in a picklist.</p> <p><i>For text and numeric editor</i> In the input mask, moves the selection bar to the left (backwards).</p>
 <small>A0018329</small>	<p>Plus key</p> <p><i>For menu, submenu</i> Moves the selection bar downwards in a picklist.</p> <p><i>For text and numeric editor</i> In the input mask, moves the selection bar to the right (forwards).</p>
 <small>A0018328</small>	<p>Enter key</p> <p><i>For measured value display</i></p> <ul style="list-style-type: none"> ▪ Pressing the key briefly opens the operating menu. ▪ Pressing the key for 2 s opens the context menu. <p><i>For menu, submenu</i></p> <ul style="list-style-type: none"> ▪ Pressing the key briefly Opens the selected menu, submenu or parameter. ▪ Pressing the key for 2 s for parameter: If present, opens the help text for the function of the parameter. <p><i>For text and numeric editor</i></p> <ul style="list-style-type: none"> ▪ Pressing the key briefly <ul style="list-style-type: none"> – Opens the selected group. – Carries out the selected action. ▪ Pressing the key for 2 s confirms the edited parameter value.
 <small>A0032909</small>	<p>Escape key combination (press keys simultaneously)</p> <p><i>For menu, submenu</i></p> <ul style="list-style-type: none"> ▪ Pressing the key briefly <ul style="list-style-type: none"> – Exits the current menu level and takes you to the next higher level. – If help text is open, closes the help text of the parameter. ▪ Pressing the key for 2 s returns you to the measured value display ("home position"). <p><i>For text and numeric editor</i> Closes the text or numeric editor without applying changes.</p>
 <small>A0032910</small>	<p>Minus/Enter key combination (press and hold down the keys simultaneously)</p> <p>Reduces the contrast (brighter setting).</p>
 <small>A0032911</small>	<p>Plus/Enter key combination (press and hold down the keys simultaneously)</p> <p>Increases the contrast (darker setting).</p>



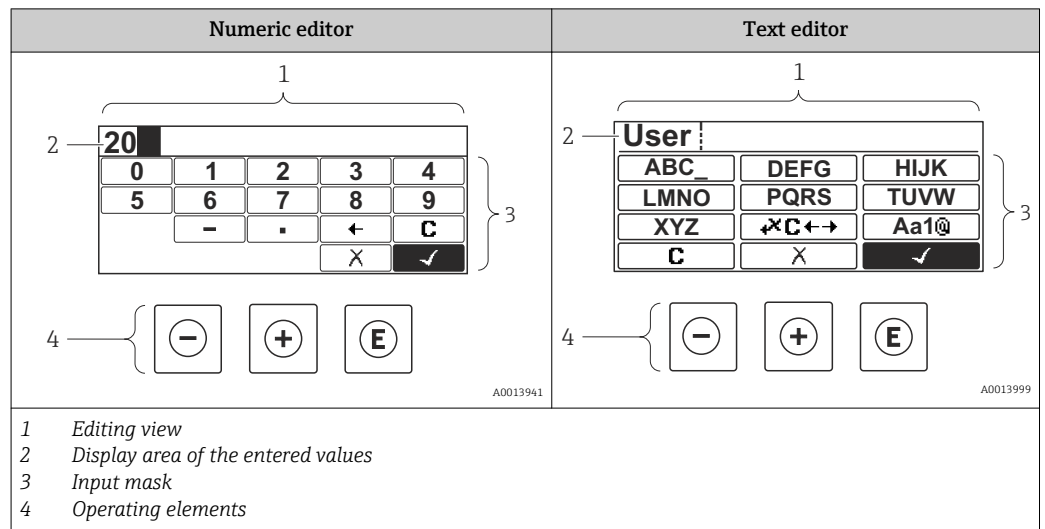



8.3.3 Entering numbers and text



Input mask





The following input symbols are available in the input mask of the numeric and text editor:

Numeric editor symbols

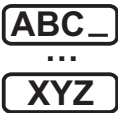
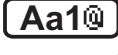



Symbol	Meaning
 <small>A0013998</small>	Selection of numbers from 0 to 9.
 <small>A0016619</small>	Inserts decimal separator at the input position.
 <small>A0016620</small>	Inserts minus sign at the input position.
 <small>A0013985</small>	Confirms selection.
 <small>A0016621</small>	Moves the input position one position to the left.
 <small>A0013986</small>	Exits the input without applying the changes.
 <small>A0014040</small>	Clears all entered characters.

Text editor symbols

Symbol	Meaning
 <small>A0013997</small>	Selection of letters from A to Z
 <small>A0013981</small>	Toggle <ul style="list-style-type: none"> Between upper-case and lower-case letters For entering numbers For entering special characters

 <small>A0013985</small>	Confirms selection.
 <small>A0013987</small>	Switches to the selection of the correction tools.
 <small>A0013986</small>	Exits the input without applying the changes.
 <small>A0014040</small>	Clears all entered characters.

Correction symbols under 

Symbol	Meaning
 <small>A0032907</small>	Clears all entered characters.
 <small>A0018324</small>	Moves the input position one position to the right.
 <small>A0018326</small>	Moves the input position one position to the left.
 <small>A0032906</small>	Deletes one character immediately to the left of the input position.

8.3.4 Opening the context menu

Using the context menu, the user can call up the following menus quickly and directly from the operational display:

- Setup
- Conf. backup disp.
- Env. curve
- Keylock on



Opening and closing the context menu

The user is in the operational display.

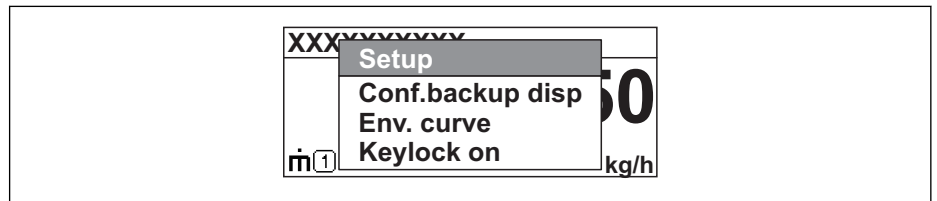

1. Press  for 2 s.
 - ↳ The context menu opens.



A0033110-EN

2. Press  +  simultaneously.
 - ↳ The context menu is closed and the operational display appears.

Calling up the menu via the context menu

1. Open the context menu.
2. Press  to navigate to the desired menu.
3. Press  to confirm the selection.
 - ↳ The selected menu opens.

8.3.5 Envelope curve on the display and operating module

In order to assess the measuring signal, the envelope curve and - if a mapping has been recorded - the mapping curve can be displayed:

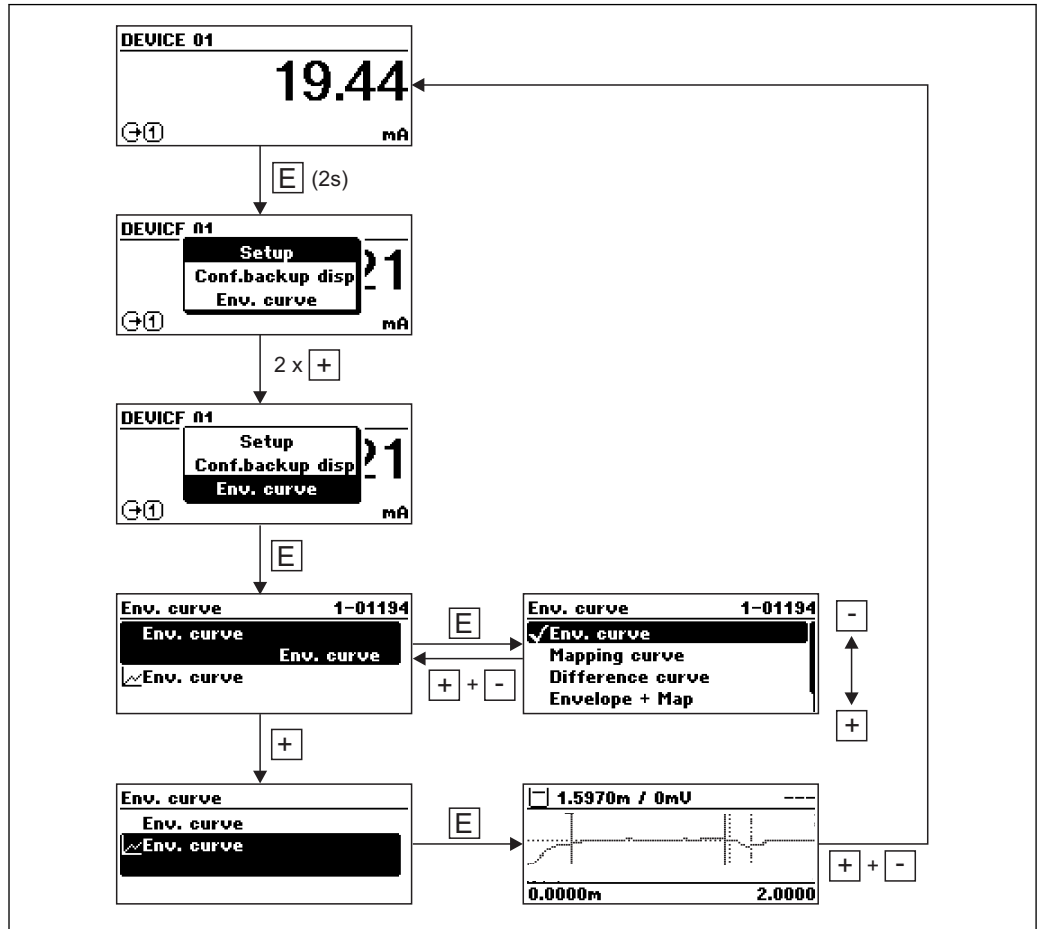

A0014277

9 Device integration via the HART protocol

9.1 Overview of the Device Description files (DD)

HART

Manufacturer ID	0x11
Device type	0x1122
HART specification	7.0
DD files	For information and files see: <ul style="list-style-type: none"> ▪ www.endress.com ▪ www.fieldcommgroup.org

9.2 HART device variables and measuring values

On delivery the following measuring values are assigned to the HART device variables:

Device variables for level measurements

Device variable	Measuring value
Primary variable (PV)	Level linearized
Secondary variable (SV)	Unfiltered distance
Tertiary variable (TV)	Absolute echo amplitude
Quaternary variable (QV)	Relative echo amplitude

 The allocation of the measuring values to the device variables can be changed in the following submenu:

Expert → Communication → Output

10 Commissioning via SmartBlue (app)

10.1 Requirements

Device requirements

Commissioning via SmartBlue is only possible if the device has a Bluetooth module.

System requirements SmartBlue

SmartBlue is available as download for Android devices from the Google Play Store and for iOS devices from the iTunes Store.

- iOS devices:
 - iPhone 4S or higher from iOS9.0; iPad2 or higher from iOS9.0; iPod Touch 5th generation or higher from iOS9.0
- Devices with Android:
 - from Android 4.4 KitKat and *Bluetooth*® 4.0

Initial password

The ID of the Bluetooth module serves as the initial password used to establish the first connection to the device. It can be found:

- on the information sheet which is supplied with the device. This serial number specific sheet is also stored in *W@M*.
- on the nameplate of the Bluetooth module.

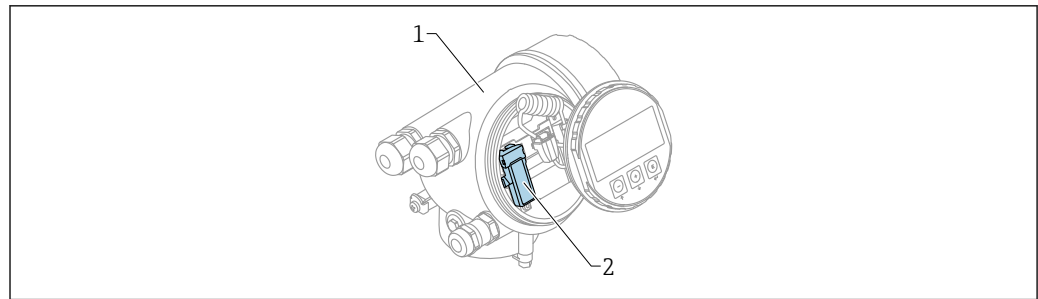

A0036790

29 Device with Bluetooth module

1 Electronics housing of the device

2 Nameplate of the Bluetooth module; the ID on this nameplate serves as initial password.

- i** All login data (including the password changed by the user) are not stored in the device but in the Bluetooth module. This must be taken into account when the module is removed from one device and inserted into a different device.

10.2 Commissioning

Download and install SmartBlue

1. To download the app, scan the QR code or enter "SmartBlue" in the search field

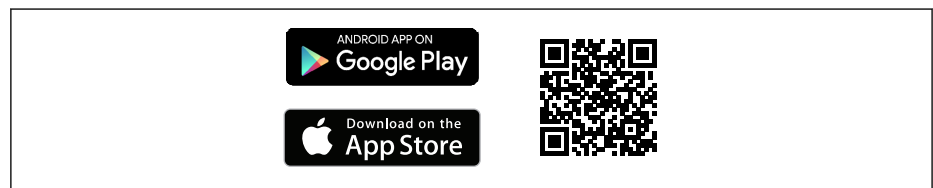

A0033202

30 Download link

2. Start SmartBlue



A0029747

31 SmartBlue pictogram

3. Select device from displayed livelist (available devices only)

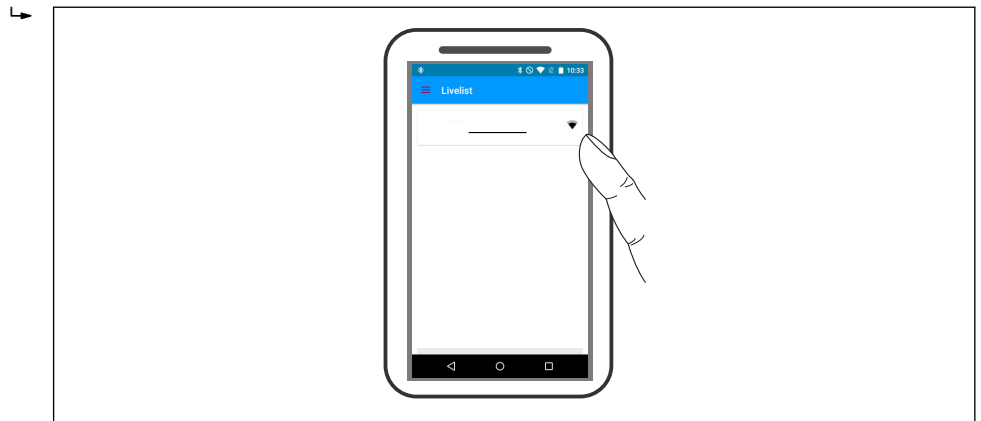

A0029502

32 Livelist

i Only one point-to-point connection can be established between **one** sensor and **one** smartphone or tablet.

4. Perform login

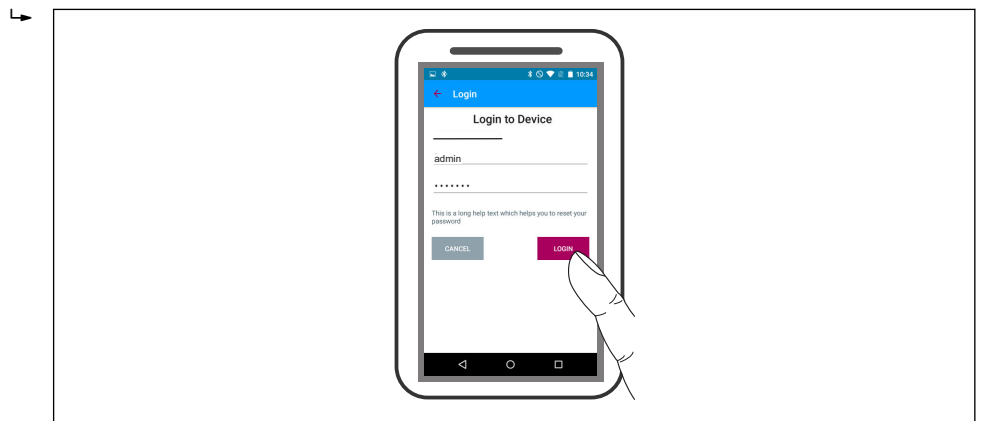

A0029503

33 Login

- 5. Enter user name -> admin
- 6. Enter initial password -> ID of the Bluetooth module
- 7. Change the password after logging in for the first time

8. By wiping from the side, additional information (e.g. main menu) can be dragged into the image

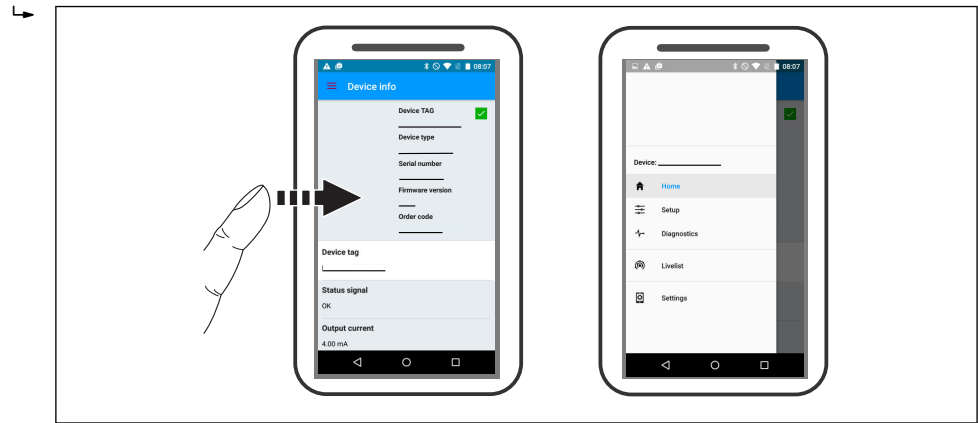

A0029504

34 Main menu

i Envelope curves can be displayed and recorded

Additionally to the envelope curve, the following values are displayed:

- D = Distance
- L = Level
- A = Absolute amplitude
- In the case of screenshots, the displayed section (zoom function) is saved
- In video sequences, always the whole area without zoom function is saved

It is also possible to send envelope curves (video sequences) using the relevant smartphone or tablet functions.

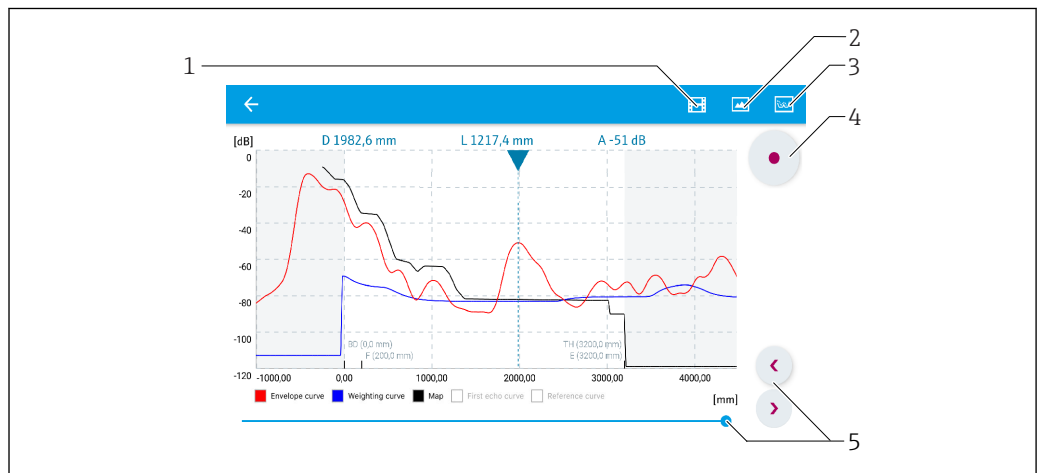

A0029486

35 Envelope curve display (example) in SmartBlue; Android view

- 1 Record video
- 2 Create screenshot
- 3 Navigation to mapping menu
- 4 Start / stop video recording
- 5 Move time on time axis

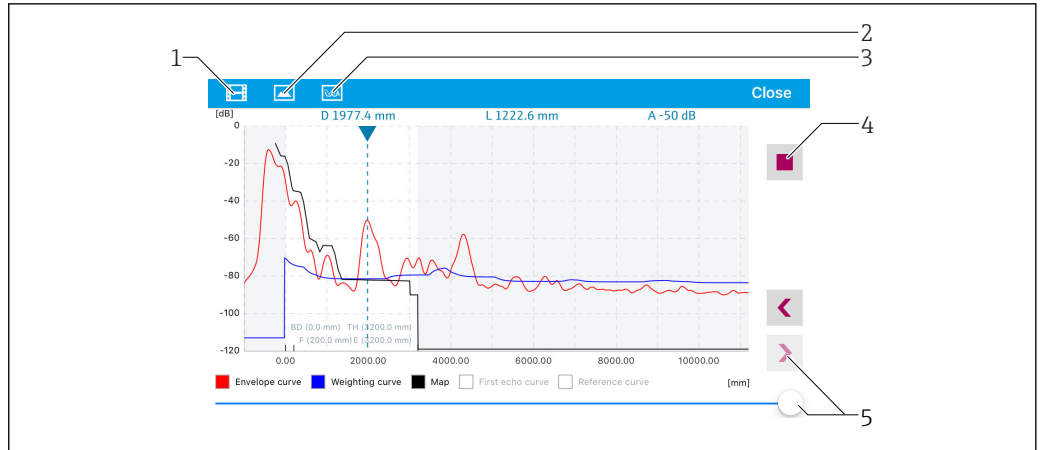

A0029487

36 Envelope curve display (example) in SmartBlue; IoS view

- 1 Record video
- 2 Create screenshot
- 3 Navigation to mapping menu
- 4 Start / stop video recording
- 5 Move time on time axis

11 Commissioning via wizard

A wizard guiding the user through the initial setup is available in FieldCare and DeviceCare ³⁾.

1. Connect the device to FieldCare or DeviceCare →  65.
2. Open the device in FieldCare or DeviceCare.
 - ↳ The dashboard (home page) of the device appears:

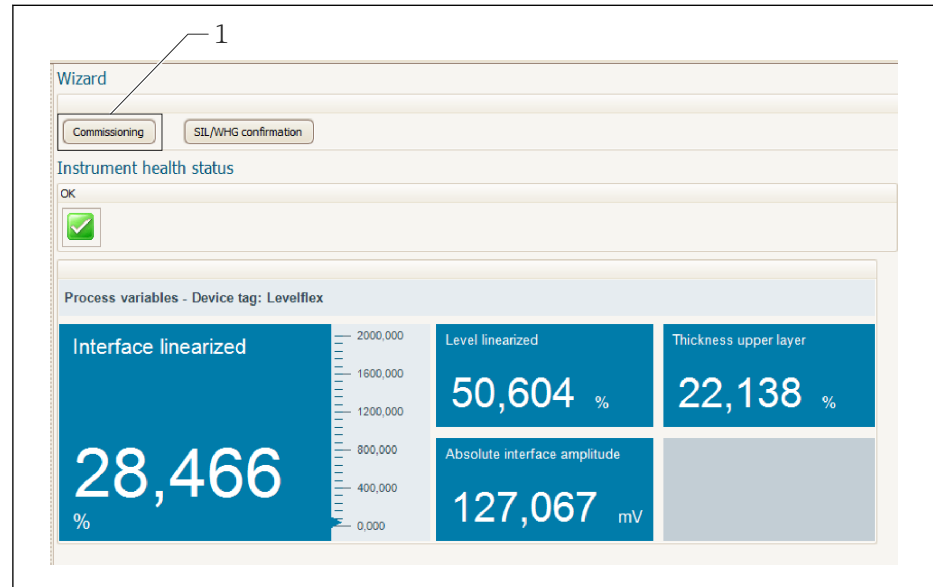

1 "Commissioning" button calls up the wizard.

3. Click on "Commissioning" to call up the wizard.
 4. Enter or select the appropriate value for each parameter. These values are immediately written to the device.
 5. Click "Next" to switch to the next page.
 6. After finishing the last page, click "End of sequence" to close the wizard.
- i** If the wizard is cancelled before all necessary parameters have been set, the device may be in an undefined state. A reset to the default settings is recommended in this case.

3) DeviceCare is available for download at www.software-products.endress.com. The download requires a registration in the Endress+Hauser software portal.

12 Commissioning via operating menu

12.1 Installation and function check

Make sure that all final checks have been completed before you start up your measuring point:

- Checklist "Post-installation check" → 46
- Checklist "Post-connection check" → 61

12.2 Setting the operating language

Factory setting: English or ordered local language

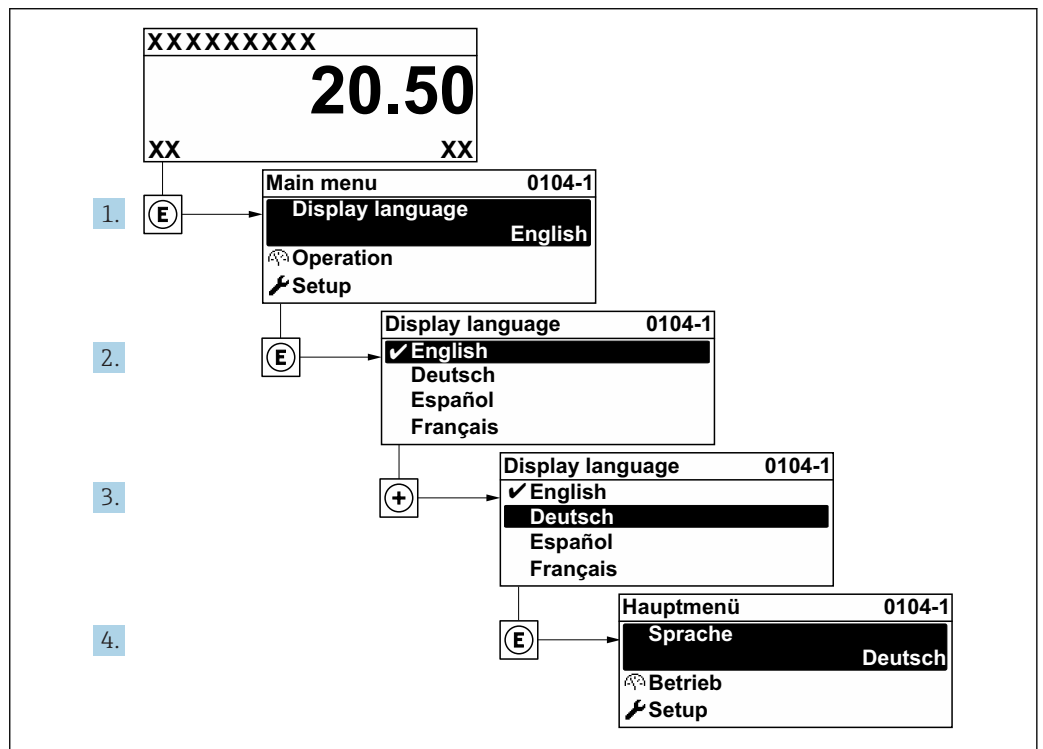

37 Using the example of the local display

A0029420

12.3 Configuration of a level measurement

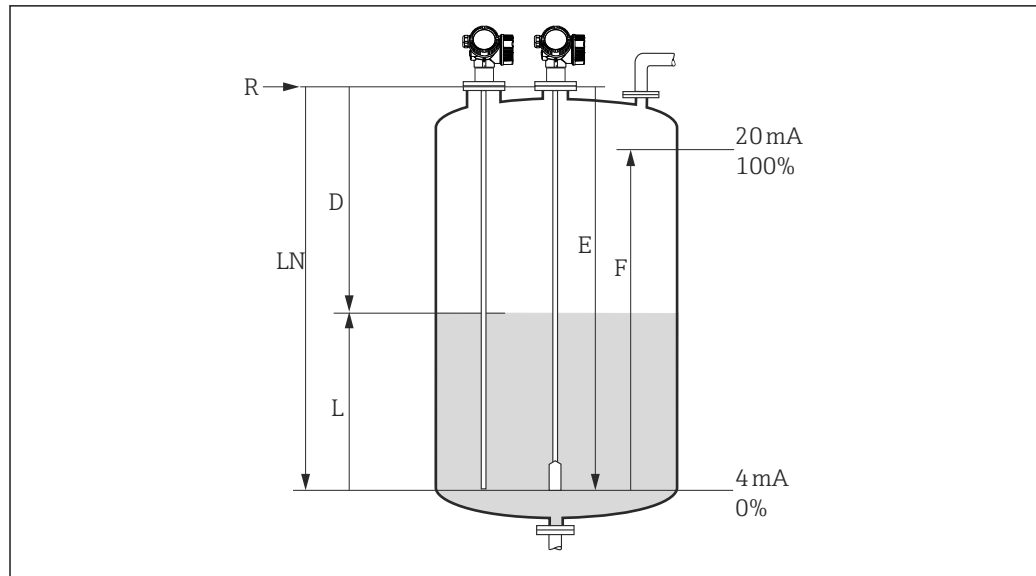

A0011360

38 Configuration parameters for level measurements in liquids

<i>LN</i>	Length of probe
<i>R</i>	Reference point of the measurement
<i>D</i>	Distance
<i>L</i>	Level
<i>E</i>	Empty calibration (= Zero point)
<i>F</i>	Full calibration (= Span)

i If for rope probes the DC value is less than 7, then measurement is not possible in the area of the straining weight. In these cases, the maximum recommended value for the empty calibration E is $LN - 250 \text{ mm}$ ($LN - 10 \text{ in}$).

1. Setup → Device tag
 - ↳ Enter tag for measuring point.
2. Navigate to: Setup → Distance unit
 - ↳ Select distance unit.
3. Navigate to: Setup → Tank type
 - ↳ Select tank type.
4. For Tank type = Bypass / pipe:
 - Navigate to: Setup → Tube diameter
 - ↳ Enter the diameter of the bypass or stilling well.
5. Navigate to: Setup → Medium group
 - ↳ Select medium group: (**Water based (DC >= 4)** or **Others**)
6. Navigate to: Setup → Empty calibration
 - ↳ Enter the distance E between the reference point R and the minimum level (0%).
7. Navigate to: Setup → Full calibration
 - ↳ Enter distance F between the minimum (0%) and maximum (100%) level.
8. Navigate to: Setup → Level
 - ↳ Displays the measured level L.
9. Navigate to: Setup → Distance
 - ↳ Displays the distance D between the reference point R and the level L.
10. Navigate to: Setup → Signal quality
 - ↳ Displays the signal quality of the level echo.

11. For operation via local display:
Navigate to: Setup → Mapping → Confirm distance
 - ↳ Compare the displayed distance to the real distance in order to start the recording of the mapping curve if required.
12. For operation via operating tool:
Navigate to: Setup → Confirm distance
 - ↳ Compare the displayed distance to the real distance in order to start the recording of the mapping curve if required.

12.4 Recording the reference curve

After the configuration of the measurement it is recommended to record the current envelope curve as a reference curve. The reference curve can be used later on in the process for diagnostic purposes. To record the reference curve use the **Save reference curve** parameter.

Navigation in the menu

Expert → Diagnostics → Envelope diagnostics → Save reference curve

Meaning of the options

- No
No action
- Yes
The current envelope curve is saved as reference curve.

 In devices which have been delivered with software version 01.00.zz or 01.01.zz, this submenu is only visible for the "Service" user role.

 The reference curve can only be displayed in the envelope curve diagram of FieldCare after it has been loaded from the device into FieldCare. This is performed by the "Load Reference Curve" function in FieldCare:



 39 The "Load Reference Curve" function

12.5 Configuration of the on-site display

12.5.1 Factory settings of the on-site display for level measurements

Parameter	Factory setting for devices with 1 current output	Factory setting for devices with 2 current outputs
Format display	1 value, max. size	1 value, max. size
Value 1 display	Level linearized	Level linearized
Value 2 display	Distance	Distance
Value 3 display	Current output 1	Current output 1
Value 4 display	None	Current output 2

12.5.2 Adjustment of the on-site display

The on-site display can be adjusted in the following menu:
Setup → Advanced setup → Display

12.6 Configuration of the current outputs

12.6.1 Factory setting of the current outputs for level measurements

Current output	Allocated measuring value	4mA value	20mA value
1	Level linearized	0% or the corresponding linearized value	100% or the corresponding linearized value
2 ¹⁾	Relative echo amplitude	0 mV	2 000 mV

1) for devices with 2 current outputs

12.6.2 Adjustment of the current outputs

The current outputs can be adjusted in the following submenus:

Basic settings

Setup → Advanced setup → Current output 1 to 2

Advanced settings

Expert → Output 1 to 2 → Current output 1 to 2

See "Description of Device Parameters" GP01000F

12.7 Configuration management

After commissioning, you can save the current device configuration, copy it to another measuring point or restore the previous device configuration. You can do so using the **Configuration management** parameter and its options.

Navigation path in the operating menu

Setup → Advanced setup → Configuration backup display → Configuration management

Meaning of the options

- **Cancel**

No action is executed and the user exits the parameter.

- **Execute backup**

A backup copy of the current device configuration in the HistoROM (built-in in the device) is saved to the display module of the device. The backup copy comprises the transmitter and sensor data of the device.

- **Restore**

The last backup copy of the device configuration is copied from the display module to the HistoROM of the device. The backup copy comprises the transmitter and sensor data of the device.

- **Duplicate**

The transmitter configuration is duplicated to another device using the transmitter display module. The following parameters, which characterize the individual measuring point are **not** included in the transmitted configuration:

- HART date code
- HART short tag
- HART message
- HART descriptor
- HART address
- Device tag
- Medium type



- **Compare**

The device configuration saved in the display module is compared to the current device configuration of the HistoROM. The result of this comparison is displayed in the **Comparison result** parameter.

- **Clear backup data**

The backup copy of the device configuration is deleted from the display module of the device.



 While this action is in progress, the configuration cannot be edited via the local display and a message on the processing status appears on the display.

 If an existing backup is restored to a different device using the **Restore** option, it may occur that some device functionalities are no longer available. In some cases even a device reset →  193 will not restore the original status..

In order to transmit a configuration to a different device, the **Duplicate** option should always be used.

12.8 Protection of the settings against unauthorized changes





There are two ways to protect the settings against unauthorized changes:

- Via parameter settings (software locking) →  68
- Via locking switch (hardware locking) →  69

13 Diagnostics and troubleshooting

13.1 General trouble shooting

13.1.1 General errors

Error	Possible cause	Remedial action
Device does not respond.	Supply voltage does not match the value indicated on the nameplate.	Connect the correct voltage.
	The polarity of the supply voltage is wrong.	Correct the polarity.
	The cables do not contact the terminals properly.	Ensure electrical contact between the cable and the terminal.
Values on the display invisible	Contrast setting is too weak or too strong.	<ul style="list-style-type: none"> ▪ Increase contrast by pressing  and  simultaneously. ▪ Decrease contrast by pressing  and  simultaneously.
	The plug of the display cable is not connected correctly.	Connect the plug correctly.
	Display is defective.	Replace display.
"Communication error" is indicated on the display when starting the device or connecting the display	Electromagnetic interference	Check grounding of the device.
	Broken display cable or display plug.	Replace display.
Duplicating of the parameters from one device to another via the display doesn't work. Only the "Save" and "Abort" options are available.	Display with backup is not recognized if no data backup has been performed at the device before.	Connect display (with the backup) and restart the device.
Output current <3.6 mA	Signal cable connection incorrect.	Check connection.
	Electronics is defective.	Replace electronics.
HART communication does not function.	Communication resistor missing or incorrectly installed.	Install the communication resistor(250 Ω) correctly.
	Commubox connected incorrectly.	Connect Commubox correctly.
	Commubox not switched to HART mode.	Set the selection switch of the Commubox to the HART position.
CDI communication does not work.	Wrong setting of the COM port on the computer.	Check the setting of the COM port on the computer and change it if necessary.
Device measures incorrectly.	Parametrization error	Check and adjust parameterization.
Device not accessible via SmartBlue	No Bluetooth connection	Enable Bluetooth function on smartphone or tablet.
	Device already linked to another smartphone / tablet	Disconnect device from smartphone/tablet.
	Bluetooth module not connected.	Connect Bluetooth module (see SD02252F).
Login via SmartBlue not possible	Device is being put into operation for the first time	Enter initial password (ID of the Bluetooth module) and change.
Device cannot be operated via SmartBlue	Incorrect password entered	Enter correct password
	Password forgotten	Contact Endress+Hauser Service (www.addresses.endress.com)

13.1.2 Error - SmartBlue operation

Error	Possible cause	Solution
Device is not visible in the live list	No Bluetooth connection	Enable Bluetooth® function on smartphone or tablet
		Bluetooth® function of sensor disabled, perform recovery sequence
Device is not visible in the live list	The device is already connected with another smartphone/tablet	Only one point-to-point connection is established between a sensor and a smartphone or tablet
Device is visible in the live list but cannot be accessed via SmartBlue	Android end device	Is the location function enabled for the app, was it approved the first time?
		GPS or positioning function must be activated for certain Android versions in conjunction with Bluetooth®
		Activate GPS - close the app fully and restart - enable the positioning function for the app
Device is visible in the live list but cannot be accessed via SmartBlue	Apple end device	Log in as standard Enter user name "admin" Enter initial password (ID of the Bluetooth module) paying attention to lower/upper case
Login via SmartBlue not possible	Device is being put into operation for the first time	Enter initial password (ID of the Bluetooth module) and change; paying attention to lower/upper case
Device cannot be operated via SmartBlue	Incorrect password entered	Enter correct password
Device cannot be operated via SmartBlue	Password forgotten	Contact the Endress+Hauser Service department (www.addresses.endress.com)

13.1.3 Parametrization errors

Parametrization errors for level measurements

Error	Possible cause	Remedial action
Measured value wrong	If measured distance (Setup → Distance) matches the real distance: Calibration error	<ul style="list-style-type: none"> ▪ Check and adjust the Empty calibration parameter (→ 142) if necessary. ▪ Check and adjust the Full calibration parameter (→ 142) if necessary. ▪ Check and adjust linearization if necessary (Linearization submenu (→ 157)).
	If measured distance (Setup → Distance) does not match the real distance: An interference echo affects the measurement.	Perform mapping (Confirm distance parameter (→ 145)).
No change of the measured value when emptying/filling the tank	An interference echo affects the measurement.	Perform mapping (Confirm distance parameter (→ 145)).
	Build-up at the probe.	Clean the probe.
	Error in the echo tracking	Deactivate echo tracking: Expert → Sensor → Echo tracking → Evaluation mode = History off .
The diagnostic message Echo lost appears after switching on the supply voltage.	Echo threshold too high.	Check the Medium group parameter (→ 141). If necessary select a more detailed setting in the Medium property parameter (→ 151).
	Level echo suppressed.	Delete mapping and record new mapping curve if required (Record map parameter (→ 146)).
Device displays a level when the tank is empty.	Incorrect probe length	Carry out probe length correction (Confirm probe length parameter (→ 172)).
	Interference echo	Carry out mapping over entire probe while the tank is empty (Confirm distance parameter (→ 145)).
Wrong slope of the level in the entire measuring range	Wrong tank type selected.	Set Tank type parameter (→ 140) correctly.

13.2 Diagnostic information on local display

13.2.1 Diagnostic message

Faults detected by the self-monitoring system of the measuring device are displayed as a diagnostic message in alternation with the measured value display.

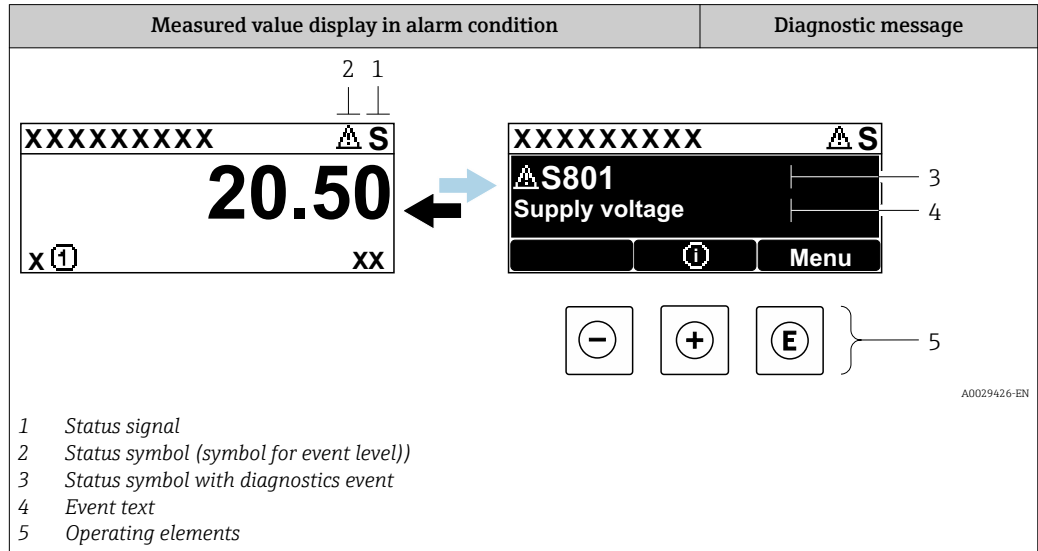

Status signals

F <small>A0032902</small>	"Failure (F)" option A device error is present. The measured value is no longer valid.
C <small>A0032903</small>	"Function check (C)" option The device is in service mode (e.g. during a simulation).
S <small>A0032904</small>	"Out of specification (S)" option The device is operated: <ul style="list-style-type: none"> ▪ Outside of its technical specifications (e.g. during startup or a cleaning) ▪ Outside of the configuration carried out by the user (e.g. level outside configured span)
M <small>A0032905</small>	"Maintenance required (M)" option Maintenance is required. The measured value is still valid.

Status symbol (symbol for event level)

⊗	"Alarm" status The measurement is interrupted. The signal outputs take on the defined alarm condition. A diagnostic message is generated.
⚠	"Warning" status The device continues to measure. A diagnostic message is generated.

Diagnostics event and event text

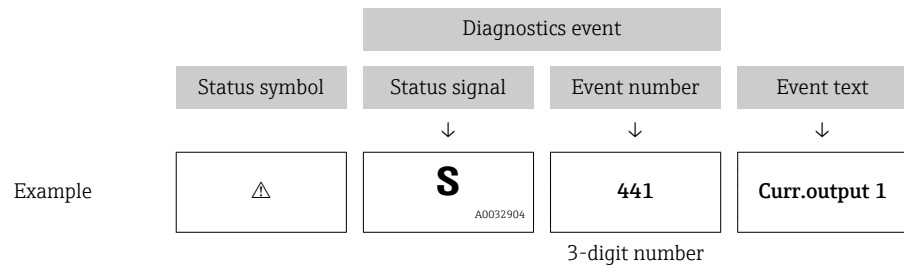

The fault can be identified using the diagnostics event. The event text helps you by providing information about the fault. In addition, the corresponding symbol is displayed before the diagnostics event.



If two or more diagnostic messages are pending simultaneously, only the message with the highest priority is shown. Additional pending diagnostic messages can be shown in the **Diagnostic list** submenu.

-  Past diagnostic messages that are no longer pending are shown as follows:
 - On the local display:
in the **Event logbook** submenu
 - In FieldCare:
via the "Event List /HistoROM" function.

Operating elements

Operating functions in menu, submenu	
	Plus key Opens the message about the remedial measures.
	Enter key Opens the operating menu.

13.2.2 Calling up remedial measures

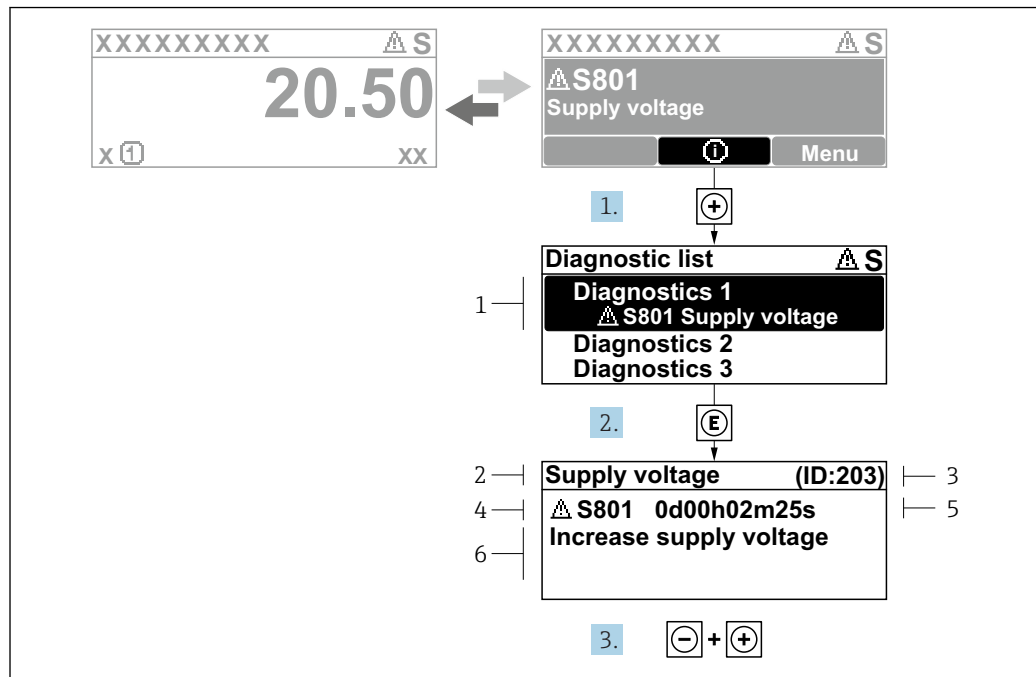

40 Message for remedial measures

- 1 Diagnostic information
- 2 Short text
- 3 Service ID
- 4 Diagnostic behavior with diagnostic code
- 5 Operation time of occurrence
- 6 Remedial measures

The user is in the diagnostic message.

1. Press \oplus (Ⓢ-Symbol).
 - ↳ **Diagnostic list** submenu opens.
2. Select the desired diagnostic event with \oplus or \ominus and press E .
 - ↳ The message for the remedial measures for the selected diagnostic event opens.
3. Press \ominus + \oplus simultaneously.
 - ↳ The message for the remedial measures closes.

The user is in the **Diagnostics** menu at an entry for a diagnostics event, e.g. in **Diagnostic list** submenu or in **Previous diagnostics**.

1. Press E .
 - ↳ The message for the remedial measures for the selected diagnostic event opens.
2. Press \ominus + \oplus simultaneously.
 - ↳ The message for the remedial measures closes.

13.3 Diagnostic event in the operating tool

If a diagnostic event is present in the device, the status signal appears in the top left status in the operating tool along with the corresponding symbol for event level in accordance with NAMUR NE 107:

- Failure (F)
- Function check (C)
- Out of specification (S)
- Maintenance required (M)

A: Via the operating menu

1. Navigate to the **Diagnostics** menu.
 - ↳ In the **Actual diagnostics** parameter, the diagnostic event is shown with event text.
2. On the right in the display range, hover the cursor over the **Actual diagnostics** parameter.

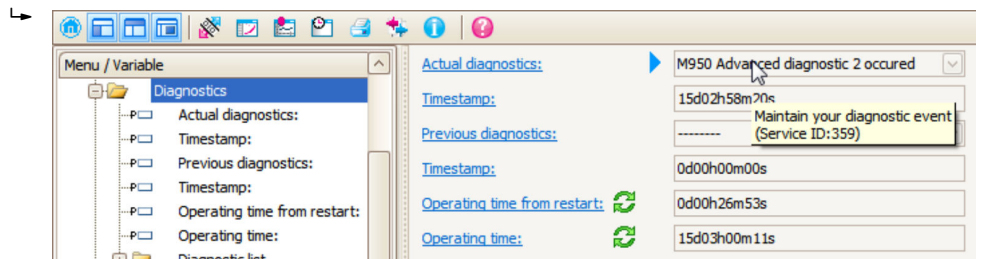

A tool tip with remedial measures for the diagnostic event appears.

B: Via the "Create documentation" function

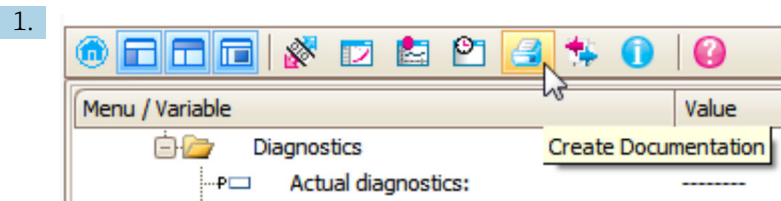

Select the "Create documentation" function.

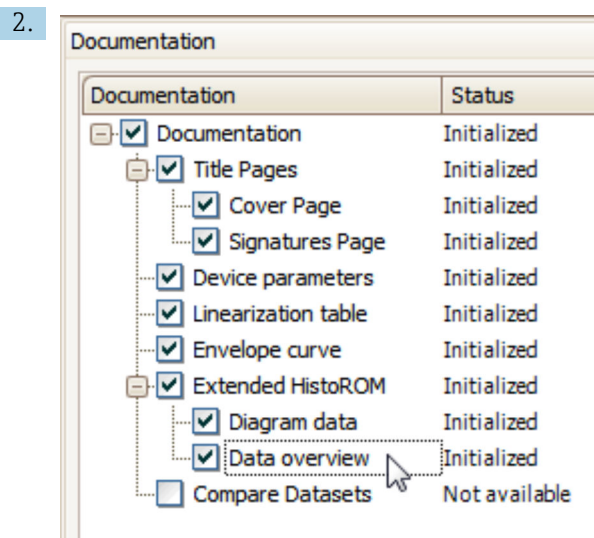

Make sure "Data overview" is marked.

3. Click "Save as ..." and save a PDF of the protocol.
 - ↳ The protocol contains the diagnostic messages and remedy information.

C: Via the "Eventlist / Extended HistoROM" function

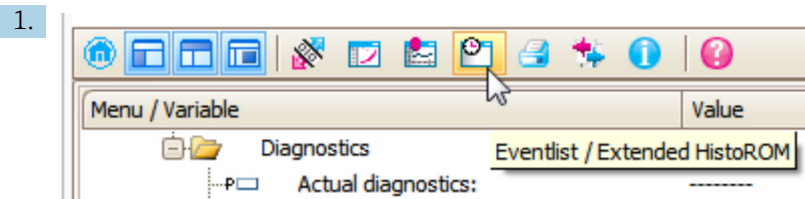

Select the "Eventlist / Extended HistoROM" function.



Select the "Load Eventlist" function.

- ↳ The list of events, including remedy information, is shown in the "Data overview" window.

13.4 Diagnostic list

In the **Diagnostic list** submenu submenu, up to 5 currently pending diagnostic messages can be displayed. If more than 5 messages are pending, the messages with the highest priority are shown on the display.

Navigation path

Diagnostics → Diagnostic list

Calling up and closing the remedial measures

1. Press \square .
 - ↳ The message for the remedial measures for the selected diagnostic event opens.
2. Press \square + \oplus simultaneously.
 - ↳ The message about the remedial measures closes.

13.5 List of diagnostic events

Diagnostic number	Short text	Remedy instructions	Status signal [from the factory]	Diagnostic behavior [from the factory]
Diagnostic of sensor				
003	Broken probe detected	1. Check map 2. Check sensor	F	Alarm
046	Build-up detected	Clean sensor	F	Alarm
104	HF cable	and check sealing 1. Dry HF cable connection 2. Change HF cable	F	Alarm
105	HF cable	1. Tighten HF cable connection 2. Check sensor 3. Change HF cable	F	Alarm
106	Sensor	1. Check sensor 2. Check HF cable 3. Contact service	F	Alarm
Diagnostic of electronic				
242	Software incompatible	1. Check software 2. Flash or change main electronics module	F	Alarm
252	Modules incompatible	1. Check if correct electronic modul is plugged 2. Replace electronic module	F	Alarm
261	Electronic modules	1. Restart device 2. Check electronic modules 3. Change I/O Modul or main electronics	F	Alarm
262	Module connection	1. Check module connections 2. Change electronic modules	F	Alarm
270	Main electronic failure	Change main electronic module	F	Alarm
271	Main electronic failure	1. Restart device 2. Change main electronic module	F	Alarm
272	Main electronic failure	1. Restart device 2. Contact service	F	Alarm
273	Main electronic failure	1. Emergency operation via display 2. Change main electronics	F	Alarm
275	I/O module defective	Change I/O module	F	Alarm
276	I/O module faulty	1. Restart device 2. Change I/O module	F	Alarm
276	I/O module faulty		F	Alarm
282	Data storage	1. Restart device 2. Contact service	F	Alarm
283	Memory content	1. Transfer data or reset device 2. Contact service	F	Alarm
311	Electronic failure	Maintenance required! 1. Do not perform reset 2. Contact service	M	Warning
Diagnostic of configuration				
410	Data transfer	1. Check connection 2. Retry data transfer	F	Alarm
411	Up-/download active	Up-/download active, please wait	C	Warning
412	Processing download	Download active, please wait	C	Warning

Diagnostic number	Short text	Remedy instructions	Status signal [from the factory]	Diagnostic behavior [from the factory]
431	Trim 1 to 2	Carry out trim	C	Warning
435	Linearization	Check linearization table	F	Alarm
437	Configuration incompatible	1. Restart device 2. Contact service	F	Alarm
438	Dataset	1. Check data set file 2. Check device configuration 3. Up- and download new configuration	M	Warning
441	Current output 1 to 2	1. Check process 2. Check current output settings	S	Warning
484	Failure mode simulation	Deactivate simulation	C	Alarm
485	Simulation measured value	Deactivate simulation	C	Warning
491	Current output 1 to 2 simulation	Deactivate simulation	C	Warning
494	Switch output simulation	Deactivate simulation switch output	C	Warning
495	Diagnostic event simulation	Deactivate simulation	C	Warning
585	Simulation distance	Deactivate simulation	C	Warning
Diagnostic of process				
801	Energy too low	Increase supply voltage	S	Warning
803	Current loop	1. Check wiring 2. Change I/O module	F	Alarm
825	Operating temperature	1. Check ambient temperature 2. Check process temperature	S	Warning
825	Operating temperature		F	Alarm
921	Change of reference	1. Check reference configuration 2. Check pressure 3. Check sensor	S	Warning
936	EMC interference	Check installation on EMC	F	Alarm
941	Echo lost	Check parameter 'DC value'	F	Alarm ¹⁾
942	In safety distance	1. Check level 2. Check safety distance 3. Reset self holding	S	Alarm ¹⁾
943	In blocking distance	Reduced accuracy Check level	S	Warning
944	Level range	Reduced accuracy Level at process connection	S	Warning
950	Advanced diagnostic 1 to 2 occurred	Maintain your diagnostic event	M	Warning ¹⁾

1) Diagnostic behavior can be changed.

13.6 Event logbook

13.6.1 Event history

A chronological overview of the event messages that have occurred is provided in the **Event list** submenu ⁴⁾.

Navigation path

Diagnostics → Event logbook → Event list

A maximum of 100 event messages can be displayed in chronological order.



Die Ereignishistorie umfasst Einträge zu:

- Diagnostic events
- Information events

In addition to the operation time of its occurrence, each event is also assigned a symbol that indicates whether the event has occurred or is ended:

- Diagnostic event
 - ☉: Event has occurred
 - ☿: Event has ended
- Information event
 - ☉: Event has occurred

Calling up and closing the remedial measures

1. Press 
 - ↳ The message for the remedial measures for the selected diagnostic event opens.
2. Press  +  simultaneously.
 - ↳ The message about the remedial measures closes.

13.6.2 Filtering the event logbook

Using the **Filter options** parameter, you can define which category of event messages is displayed in the **Event list** submenu.

Navigation path

Diagnostics → Event logbook → Filter options

Filter categories

- All
- Failure (F)
- Function check (C)
- Out of specification (S)
- Maintenance required (M)
- Information

13.6.3 Overview of information events

Info number	Info name
I1000	----- (Device ok)
I1089	Power on
I1090	Configuration reset
I1091	Configuration changed

4) This submenu is only available for operation via local display. In the case of operation via FieldCare, the event list can be displayed with the "Event List / HistoROM" functionality of FieldCare.

Info number	Info name
I1092	Embedded HistoROM deleted
I1110	Write protection switch changed
I1137	Electronic changed
I1151	History reset
I1154	Reset terminal voltage min/max
I1155	Reset electronic temperature
I1156	Memory error trend
I1157	Memory error event list
I1184	Display connected
I1185	Display backup done
I1186	Restore via display done
I1187	Settings downloaded with display
I1188	Display data cleared
I1189	Backup compared
I1256	Display: access status changed
I1264	Safety sequence aborted
I1335	Firmware changed
I1397	Fieldbus: access status changed
I1398	CDI: access status changed
I1512	Download started
I1513	Download finished
I1514	Upload started
I1515	Upload finished
I1554	Safety sequence started
I1555	Safety sequence confirmed
I1556	Safety mode off

13.7 Firmware history

Date	Firmware version	Modifications	Documentation (FMP50, HART)		
			Operating Instructions	Description of Parameters	Technical Information
07.2010	01.00.zz	Original software	BA01000F/00/EN/05.10	GP01000F/00/EN/05.10	TI01000F/00/EN/05.10
01.2011	01.01.zz	<ul style="list-style-type: none"> ▪ SIL integrated ▪ Improvements and bugfixes ▪ additional languages 	<ul style="list-style-type: none"> ▪ BA01000F/00/EN/10.10 ▪ BA01000F/00/EN/13.11 ▪ BA01000F/00/EN/14.12 	<ul style="list-style-type: none"> ▪ GP01000F/00/EN/10.10 ▪ GP01000F/00/EN/13.11 	<ul style="list-style-type: none"> ▪ TI01000F/00/EN/10.10 ▪ TI01000F/00/EN/13.11 ▪ TI01000F/00/EN/14.12 ▪ TI01000F/00/EN/15.12
02.2014	01.02.zz	<ul style="list-style-type: none"> ▪ Support of SD03 ▪ additional languages ▪ HistoROM functionality enhanced ▪ "Advanced Diagnostic" function block integrated ▪ Improvements and bugfixes 	<ul style="list-style-type: none"> ▪ BA01000F/00/EN/15.13 ▪ BA01000F/00/EN/16.14 	<ul style="list-style-type: none"> ▪ GP01000F/00/EN/14.13 ▪ GP01000F/00/EN/15.14 	<ul style="list-style-type: none"> ▪ TI01000F/00/EN/16.13 ▪ TI01000F/00/EN/17.14
04.2016	01.03.zz	<ul style="list-style-type: none"> ▪ Update to HART 7 ▪ All 17 operating languages available in the device ▪ Improvements and bugfixes 	<ul style="list-style-type: none"> ▪ BA01000F/00/EN/17.16 ▪ BA01000F/00/EN/18.16¹⁾ ▪ BA01000F/00/EN/20.18²⁾ 	GP01000F/00/EN/16.16	<ul style="list-style-type: none"> ▪ TI01000F/00/EN/18.16 ▪ TI01000F/00/EN/20.16¹⁾ ▪ TI01000F/00/EN/22.18²⁾

- 1) Contains information on the Heartbeat wizards which are available in the latest DTM version for DeviceCare and FieldCare.
- 2) Contains information on the Bluetooth interface.



The firmware version can explicitly be ordered via the product structure. In this way it is possible to ensure compatibility of the firmware version with an existing or planned system integration.

14 Maintenance

The measuring device requires no special maintenance.

14.1 Exterior cleaning

When exterior-cleaning the device, always use cleaning agents that do not attack the surface of the housing and the seals.

15 Repairs

15.1 General information on repairs

15.1.1 Repair concept

The Endress+Hauser repair concept assumes that the devices have a modular design and that repairs can be done by the Endress+Hauser service or specially trained customers.

Spare parts are contained in suitable kits. They contain the related replacement instructions.

For more information on service and spare parts, contact the Service Department at Endress+Hauser.

15.1.2 Repairs to Ex-approved devices

When carrying out repairs to Ex-approved devices, please note the following:

- Repairs to Ex-approved devices may only be carried out by trained personnel or by the Endress+Hauser Service.
- Comply with the prevailing standards, national Ex-area regulations, safety instructions (XA) and certificates.
- Only use original spare parts from Endress+Hauser.
- When ordering a spare part, please note the device designation on the nameplate. Only replace parts with identical parts.
- Carry out repairs according to the instructions. On completion of repairs, carry out the specified routine test on the device.
- Only Endress+Hauser Service may convert a certified device into a different certified variant.
- Document all repair work and conversions.

15.1.3 Replacement of an electronics module

If an electronics module has been replaced, it is not necessary to perform a new basic setup as the calibration parameters are stored in the HistoROM which is located in the housing. However, after exchanging the main electronics module it may be necessary to record a new mapping (interference echo suppression).

15.1.4 Replacement of a device

After a complete device or electronic module has been replaced, the parameters can be downloaded into the instrument again in one of the following ways:

- Via the display module
Condition: The configuration of the old device has been saved in the display module
→  190.
- Via FieldCare
Condition: The configuration of the old device has been saved to the computer via FieldCare.

You can continue to measure without carrying out a new setup. Only a linearization and a tank map (interference echo suppression) have to be recorded again.

15.2 Spare parts

- A few interchangeable measuring device components are identified by a spare part nameplate. This contains information about the spare part.
- The connection compartment cover of the device contains a spare part nameplate that includes the following information:
 - A list of the most important spare parts for the measuring device, including their ordering information.
 - The URL for the *W@M Device Viewer* (www.endress.com/deviceviewer): There, all spare parts for the measuring device are listed, including the order code, and can be ordered. If available, the corresponding Installation Instructions can also be downloaded there.

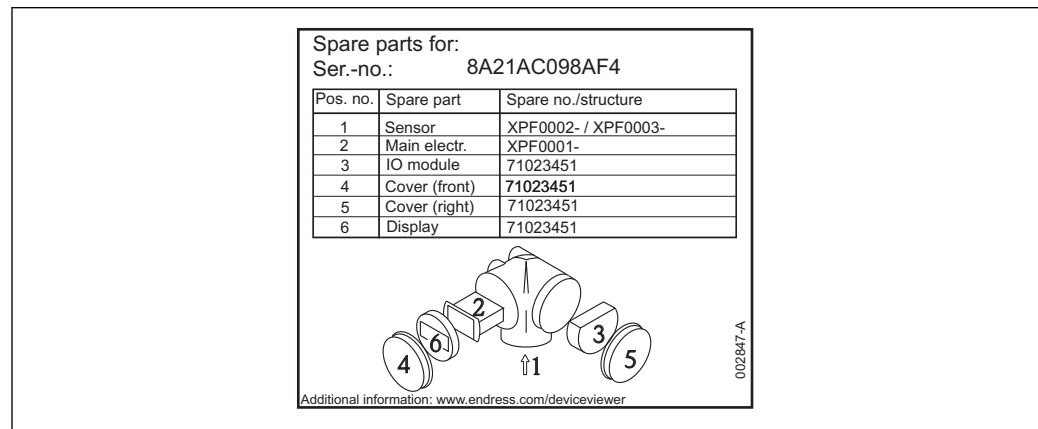

41 Example for spare part nameplate in connection compartment cover

- i** Measuring device serial number:
 - Is located on the device and spare part nameplate.
 - Can be read out via the "Serial number" parameter in the "Device information" submenu.

15.3 Return

The measuring device must be returned if it is need of repair or a factory calibration, or if the wrong measuring device has been delivered or ordered. Legal specifications require Endress+Hauser, as an ISO-certified company, to follow certain procedures when handling products that are in contact with the medium.

To ensure safe, swift and professional device returns, please refer to the procedure and conditions for returning devices provided on the Endress+Hauser website at <http://www.endress.com/support/return-material>

15.4 Disposal



Observe the following notes during disposal:

- Observe valid federal/national regulations.
- Ensure proper separation and reuse of the device components.

16 Accessories

16.1 Device-specific accessories

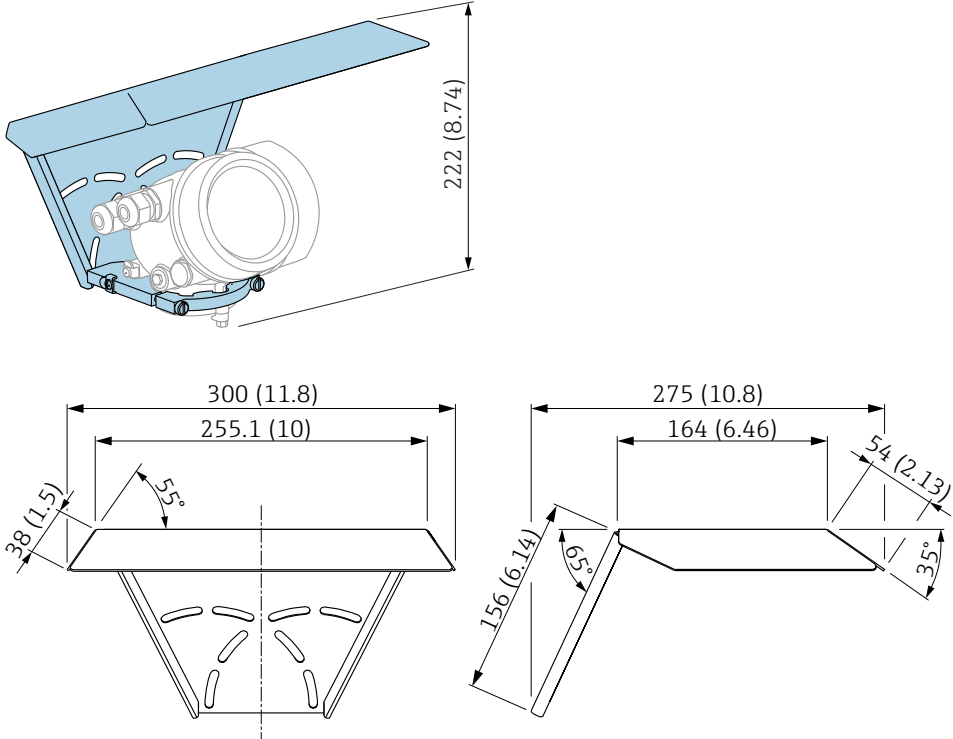
16.1.1 Weather protection cover

Accessory	Description
Weather protection cover	 <p data-bbox="1476 869 1528 882">A0015466</p> <p data-bbox="1476 1279 1528 1292">A0015472</p> <p data-bbox="416 1303 925 1332">☑ 42 Weather protection cover; Dimensions: mm (in)</p> <p data-bbox="416 1357 1492 1435">  The weather protection cover can be ordered together with the device (product structure, feature 620 "Accessory Enclosed", option PB "Weather Protection Cover"). Alternatively, it can be separately ordered as an accessory; order code 71162242. </p>

16.1.2 Mounting bracket for the electronics housing

Accessory	Description
Mounting bracket for the electronics housing	<div style="display: flex; justify-content: space-around;"> <div style="text-align: center;"> <p>A</p> </div> <div style="text-align: center;"> <p>B</p> </div> </div> <p> 43 Mounting bracket for the electronics housing; Dimensions: mm (in) </p> <p> A Wall mounting B Pipe mounting </p> <p> For the "Sensor remote" device version (see feature 060 of the product structure), the mounting bracket is part of the delivery. If required, it can also be ordered as an accessory (order code 71102216). </p> <p style="text-align: right; font-size: small;">A0014793</p>

16.1.3 Mounting kit, isolated

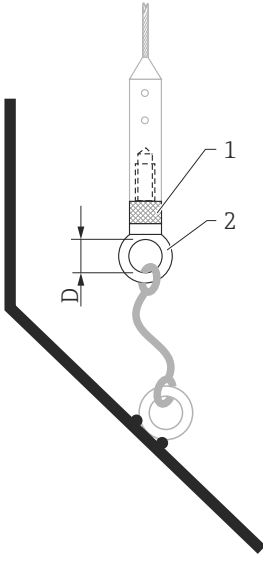
Accessory	Description
<p>Mounting kit, isolated can be used for FMP50</p>	<div style="text-align: right; font-size: small; margin-bottom: 10px;">A0013586</div>  <p>☑ 44 Scope of supply of the mounting kit:</p> <p>1 Insulating sleeve 2 Eye-bolt</p> <p>For reliably insulated fixing of the probe. Maximum process temperature: 150 °C (300 °F)</p> <p>For rope probes 4 mm (1/6 in) or 6 mm (1/4 in) with PA>steel:</p> <ul style="list-style-type: none"> ▪ Diameter D = 20 mm (0.8 in) ▪ Order-No.: 52014249 <p>For rope probes 6 mm (1/4 in) or 8 mm (1/3 in) with PA>steel:</p> <ul style="list-style-type: none"> ▪ Diameter D = 25 mm (1 in) ▪ Order-No.: 52014250 <p>Due to the risk of electrostatic charge, the insulating sleeve is not suitable for use in hazardous areas. In these cases the fixing must be reliably grounded.</p> <p>i The mounting kit can also be ordered directly with the device (see the Levelflex product structure, feature 620 "Accessory Enclosed", option PG "Mounting kit, isolated, rope").</p>

16.1.4 Centering star

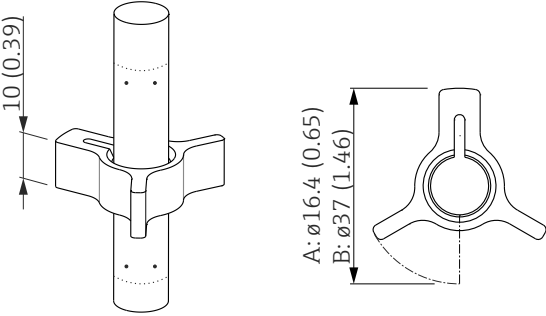
Accessory	Description
Centering star PFA <ul style="list-style-type: none"> ■ ϕ 16.4 mm (0.65 in) ■ ϕ 37 mm (1.46 in) can be used for FMP50	 <p style="text-align: right; font-size: small;">A0014577</p> <p>A For 8 mm (0.3 in) probes B: For 12 mm (0.47 in) and 16 mm (0.63 in) probes</p> <p>The centering star is suitable for probes with a rod diameter of 8 mm (0.3 in), 12 mm (0.47 in) and 16 mm (0.63 in) (also coated rod probes) and can be used in pipes from DN40 (1½") up to DN50 (2"). See also Operating Instructions BA00378F/00/A2.</p> <ul style="list-style-type: none"> ■ Material: PFA ■ Admissible process temperature: -200 to +250 °C (-382 to +482 °F) ■ Order code <ul style="list-style-type: none"> - Probe 8 mm (0.3 in): 71162453 - Probe 12 mm (0.47 in): 71157270 - Probe 16 mm (0.63 in): 71069065

16.1.5 Remote display FHX50

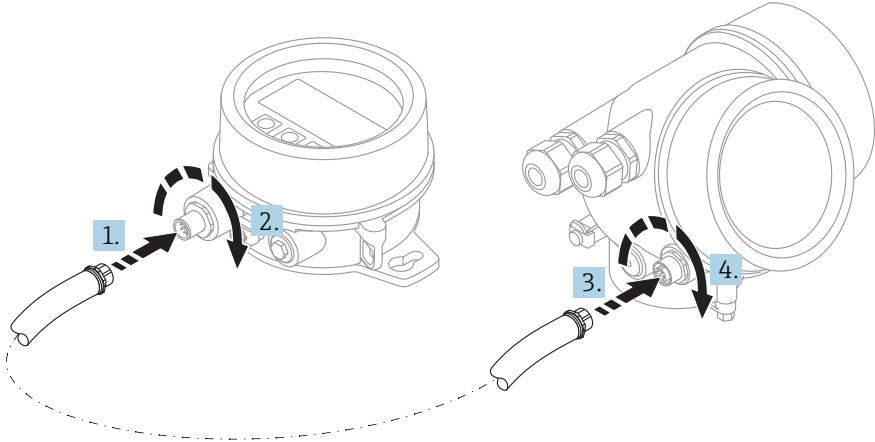
Accessories	Description
Remote display FHX50	<div style="text-align: center;">  </div> <p style="text-align: right; font-size: small;">A0019128</p> <ul style="list-style-type: none"> ▪ Material: <ul style="list-style-type: none"> - Plastic PBT - 316L/1.4404 - Aluminum ▪ Degree of protection: IP68 / NEMA 6P and IP66 / NEMA 4x ▪ Suitable for display modules: <ul style="list-style-type: none"> - SD02 (push buttons) - SD03 (touch control) ▪ Connecting cable: <ul style="list-style-type: none"> - Cable supplied with device up to 30 m (98 ft) - Standard cable supplied by customer up to 60 m (196 ft) ▪ Ambient temperature range: -40 to 80 °C (-40 to 176 °F) ▪ Ambient temperature range (option): -50 to 80 °C (-58 to 176 °F) ¹⁾ <p> i ▪ If the remote display should be used, order the device version "Prepared for display FHX50" (feature 030, version L, M or N). For the FHX50, you must select option A: "Prepared for display FHX50" under feature 050 "Measuring device version". </p> <p> i ▪ If the device version "Prepared for display FHX50" was not originally ordered and a FHX50 display is to be retrofitted, you must select version B "Not prepared for display FHX50" under feature 050: "Measuring device version" when ordering the FHX50. In this case, a retrofit kit for the device is supplied with the FHX50. The kit can be used to prepare the device so that the FHX50 can be used. </p> <p> i Use of the FHX50 may be restricted for transmitters with an approval. A device can only be retrofitted with the FHX50 if the option L, M or N ("Prepared for FHX50") is listed under <i>Basic specifications</i>, item 4 "Display, operation" in the Safety Instructions (XA) for the device. Also pay attention to the Safety Instructions (XA) of the FHX50. </p> <p> i Retrofitting is not possible on transmitters with: <ul style="list-style-type: none"> ▪ An approval for use in areas with flammable dust (dust ignition-proof approval) ▪ Ex nA type of protection </p> <p> i For details, see document SD01007F. </p>

1) This range is valid if option JN "Ambient temperature transmitter -50 °C (-58 °F)" has been selected in ordering feature 580 "Test, Certificate". If the temperature is permanently below -40 °C (-40 °F), failure rates may be increased.

16.1.6 Overvoltage protection

Accessory	Description
Overvoltage protection for 2-wire-devices OVP10 (1 channel) OVP20 (2 channel)	<div data-bbox="327 324 715 660" style="text-align: center;"> </div> <div data-bbox="1380 667 1436 683" style="text-align: right; font-size: small;">A0021734</div> <p>Technical data</p> <ul style="list-style-type: none"> ▪ Resistance per channel: $2 * 0.5 \Omega_{max}$ ▪ Threshold DC voltage: 400 to 700 V ▪ Threshold impulse voltage: < 800 V ▪ Capacitance at 1 MHz: < 1.5 pF ▪ Nominal arrest impulse voltage (8/20 μs): 10 kA ▪ Suited for wire cross-sections: 0.2 to 2.5 mm² (24 to 14 AWG) <p>i Ordering with device The overvoltage protection module is preferably ordered with the device. See product structure, feature 610 "Accessory mounted", option NA "Overvoltage protection". Separate ordering of the module is only necessary if a device is to be retrofitted with the overvoltage protection.</p> <p>i Order code for retrofitting</p> <ul style="list-style-type: none"> ▪ For 1-channel devices (feature 020, option A) OVP10: 71128617 ▪ For 2-channel devices (feature 020, option B, C, E or G) OVP20 : 71128619 <p>Housing lid for retrofitting In order to keep the necessary safety distances, the housing lid needs to be replaced if the device is retrofitted with the overvoltage protection. Depending on the housing type, the order code of the suitable lid is as follows:</p> <ul style="list-style-type: none"> ▪ GT18 housing: Lid 71185516 ▪ GT19 housing: Lid 71185518 ▪ GT20 housing: Lid 71185516 <p>i Restrictions for retrofitting Depending on the approval of the transmitter the usage of the OVP module may be restricted. A device may only be retrofitted with an OVP module if the option NA (overvoltage protection) is quoted under <i>Optional Specifications</i> in the Safety Instructions (XA) pertaining to the device.</p> <p>i For details refer to SD01090F.</p>

16.1.7 Bluetooth module for HART devices

Accessory	Description
Bluetooth module	<div data-bbox="416 324 1066 766" data-label="Image"> </div> <div data-bbox="1476 779 1528 792" data-label="Text"> <p>A0036493</p> </div> <ul style="list-style-type: none"> ▪ Quick and easy commissioning via SmartBlue (app) ▪ No additional tools or adapters required ▪ Signal curve via SmartBlue (app) ▪ Encrypted single point-to-point data transmission (tested by Fraunhofer institute) and password protected communication via Bluetooth® wireless technology ▪ Range under reference conditions: > 10 m (33 ft) <p>i When using the Bluetooth module the minimum supply voltage increases by up to 3 V.</p> <p>i Ordering with device The Bluetooth module is preferably ordered with the device. See product structure, feature 610 "Accessory Mounted", option NF "Bluetooth". A separate order is only necessary in case of retrofitting.</p> <p>i Order code for retrofitting Bluetooth module (BT10): 71377355</p> <p>i Restrictions in case of retrofitting Depending on the approval of the transmitter, application of the Bluetooth module may be restricted. A device may only be retrofitted with a Bluetooth module if the option <i>NF</i> (Bluetooth) is listed in the associated Safety Instructions (<i>XA</i>) under <i>Optional specifications</i>.</p> <p>i For details refer to SD02252F.</p>

16.2 Communication-specific accessories

Accessory	Description
Commubox FXA195 HART	For intrinsically safe HART communication with FieldCare via the USB interface.  For details refer to Technical Information TI00404F

Accessory	Description
Commubox FXA291	Connects Endress+Hauser field devices with CDI interface (= Endress+Hauser Common Data Interface) to the USB interface of a computer. Order code: 51516983  For details refer to Technical Information TI00405C

Accessory	Description
HART Loop Converter HMX50	Evaluates the dynamic HART variables and converts them to analog current signals or limit values. Order code: 71063562  For details refer to Technical Information TI00429F and Operating Instructions BA00371F

Accessory	Description
WirelessHART Adapter SWA70	Connects field devices to a WirelessHART network. The WirelessHART adapter can be mounted directly at a HART device and is easily integrated into an existing HART network. It ensures safe data transmission and can be operated in parallel with other wireless networks.  For details refer to Operating Instructions BA00061S

Accessories	Description
Connect Sensor FXA30/FXA30B	Fully integrated, battery-powered gateway for simple applications with SupplyCare Hosting. Up to 4 field devices with 4 to 20 mA communication (FXA30/FXA30B), serial Modbus (FXA30B) or HART (FXA30B) can be connected. With its robust design and ability to run for years on the battery, it is ideal for remote monitoring in isolated locations. Version with LTE (USA, Canada and Mexico only) or 3G mobile transmission for worldwide communication.  For details, see "Technical Information" TI01356S and Operating Instructions BA01710S.

Accessories	Description
Fieldgate FXA42	Fieldgates enable communication between connected 4 to 20 mA, Modbus RS485 and Modbus TCP devices and SupplyCare Hosting or SupplyCare Enterprise. The signals are transmitted either via Ethernet TCP/IP, WLAN or mobile communications (UMTS). Advanced automation capabilities are available, such as an integrated Web-PLC, OpenVPN and other functions.  For details, see "Technical Information" TI01297S and Operating Instructions BA01778S.



Accessories	Description
SupplyCare Enterprise SCE30B	Inventory management software that visualizes levels, volumes, masses, temperatures, pressures, densities or other tank parameters. The parameters are recorded and transmitted by means of gateways of the type Fieldgate FXA42. This Web-based software is installed on a local server and can also be visualized and operated with mobile terminals such as a smartphone or tablet.  For details, see "Technical Information" TI01228S and Operating Instructions BA00055S

Accessories	Description
SupplyCare Hosting SCH30	Inventory management software that visualizes levels, volumes, masses, temperatures, pressures, densities or other tank parameters. The parameters are recorded and transmitted by means of gateways of the type Fieldgate FXA42, FXA30 and FXA30B. SupplyCare Hosting is offered as a hosting service (Software as a Service, SaaS). In the Endress+Hauser portal, the user is provided with the data over the Internet.  For details, see "Technical Information" TI01229S and Operating Instructions BA00050S.



Accessory	Description
Field Xpert SFX350	Field Xpert SFX350 is a mobile computer for commissioning and maintenance. It enables efficient device configuration and diagnostics for HART and FOUNDATION fieldbus devices in the non-Ex area .  For details, see Operating Instructions BA01202S

Accessory	Description
Field Xpert SFX370	Field Xpert SFX370 is a mobile computer for commissioning and maintenance. It enables efficient device configuration and diagnostics for HART and FOUNDATION fieldbus devices in the non-Ex area and the Ex area .  For details, see Operating Instructions BA01202S

16.3 Service-specific accessories

Accessory	Description
DeviceCare SFE100	Configuration tool for HART, PROFIBUS and FOUNDATION Fieldbus devices  Technical Information TI01134S  <ul style="list-style-type: none"> ▪ DeviceCare is available for download at www.software-products.endress.com. The download requires a registration in the Endress+Hauser software portal. ▪ Alternatively, a DeviceCare DVD can be ordered with the device. Product structure: Feature 570 "Service", Option IV "Tooling DVD (DeviceCare Setup)".
FieldCare SFE500	FDT-based Plant Asset Management tool. Helps to configure and maintain all field devices of your plant. By supplying status information it also supports the diagnosis of the devices.  Technical Information TI00028S





















16.4 System components

























Accessory	Description
Graphic Data Manager Memograph M	<p>The graphic data manager Memograph M provides information on all the relevant process variables. Measured values are recorded correctly, limit values are monitored and measuring points analyzed. The data are stored in the 256 MB internal memory and also on an SD card or USB stick.</p> <p> For details refer to Technical Information TI00133R and Operating Instructions BA00247R</p>
RN22.1N	<p>Active barrier with power supply for safe separation of 4 to 20 mA current circuits. Provides bi-directional HART transmission.</p> <p> For details refer to Technical Information TI00073R and Operating Instructions BA00202R</p>
RNS221	<p>Transmitter supply for 2-wire sensors or transmitters exclusively for non-Ex areas. Provides bi-directional communication using the HART communication sockets.</p> <p> For details refer to Technical Information TI00081R and Operating Instructions KA00110R</p>

17 Operating menu

17.1 Overview of the operating menu (SmartBlue)

Navigation  SmartBlue

Setup	→  140
Device tag	→  140
Distance unit	→  140
Tank type	→  140
Tube diameter	→  141
Medium group	→  141
Empty calibration	→  142
Full calibration	→  142
Level	→  143
Distance	→  143
Signal quality	→  144
Confirm distance	→  145
Present mapping	→  146
Mapping end point	→  146
Record map	→  146
► Advanced setup	→  149
Locking status	→  149
Access status tooling	→  149
Enter access code	→  150
► Level	→  151
Medium type	→  151

Medium property	→  151
Process property	→  152
Advanced process conditions	→  153
Level unit	→  154
Blocking distance	→  154
Level correction	→  155
► Linearization	→  157
Linearization type	→  159
Unit after linearization	→  160
Free text	→  161
Level linearized	→  161
Maximum value	→  162
Diameter	→  162
Intermediate height	→  162
Table mode	→  163
Table number	→  164
Level	→  164
Level	→  165
Customer value	→  165
Activate table	→  165
► Probe settings	→  171
Probe grounded	→  171
Present probe length	→  171
Confirm probe length	→  172























▶ Safety settings	→ 166
Output echo lost	→ 166
Value echo lost	→ 166
Ramp at echo lost	→ 167
Blocking distance	→ 154
▶ Current output 1 to 2	→ 174
Assign current output	→ 174
Current span	→ 175
Fixed current	→ 175
Damping output	→ 176
Failure mode	→ 176
Failure current	→ 177
Output current 1 to 2	→ 177
▶ Switch output	→ 178
Switch output function	→ 178
Assign status	→ 179
Assign limit	→ 179
Assign diagnostic behavior	→ 179
Switch-on value	→ 180
Switch-on delay	→ 181
Switch-off value	→ 181
Switch-off delay	→ 182
Failure mode	→ 182

Switch status	→ 182
Invert output signal	→ 182
Diagnostics	→ 196
Actual diagnostics	→ 196
Timestamp	→ 196
Previous diagnostics	→ 196
Timestamp	→ 197
Operating time from restart	→ 197
Operating time	→ 190
▶ Diagnostic list	→ 198
Diagnostics 1 to 5	→ 198
Timestamp 1 to 5	→ 198
▶ Measured values	→ 203
Distance	→ 143
Level linearized	→ 161
Output current 1 to 2	→ 177
Measured current 1	→ 204
Terminal voltage 1	→ 204
▶ Device information	→ 200
Device tag	→ 200
Serial number	→ 200
Firmware version	→ 200
Device name	→ 200
Order code	→ 201
Extended order code 1 to 3	→ 201

Device revision	→ 201
Device ID	→ 201
Device type	→ 202
Manufacturer ID	→ 202
► Simulation	→ 209
Assign measurement variable	→ 210
Process variable value	→ 210
Current output 1 to 2 simulation	→ 210
Value current output 1 to 2	→ 211
Switch output simulation	→ 211
Switch status	→ 211
Device alarm simulation	→ 212

17.2 Overview of the operating menu (display module)

Navigation  Operating menu

























Language	→  184
Setup	→  140
Device tag	→  140
Distance unit	→  140
Tank type	→  140
Tube diameter	→  141
Medium group	→  141
Empty calibration	→  142
Full calibration	→  142
Level	→  143
Distance	→  143
Signal quality	→  144
Mapping	→  148
Confirm distance	→  148
Mapping end point	→  148
Record map	→  148
Distance	→  148
Advanced setup	→  149
Locking status	→  149
Access status display	→  150
Enter access code	→  150
Level	→  151
Medium type	→  151

Medium property	→ 151
Process property	→ 152
Advanced process conditions	→ 153
Level unit	→ 154
Blocking distance	→ 154
Level correction	→ 155
► Linearization	→ 157
Linearization type	→ 159
Unit after linearization	→ 160
Free text	→ 161
Maximum value	→ 162
Diameter	→ 162
Intermediate height	→ 162
Table mode	→ 163
► Edit table	
Level	→ 164
Customer value	→ 165
Activate table	→ 165
► Safety settings	→ 166
Output echo lost	→ 166
Value echo lost	→ 166
Ramp at echo lost	→ 167
Blocking distance	→ 154
► SIL/WHG confirmation	→ 169

▶ Deactivate SIL/WHG	→ 170
Reset write protection	→ 170
Code incorrect	→ 170
▶ Probe settings	→ 171
Probe grounded	→ 171
▶ Probe length correction	→ 173
Confirm probe length	→ 173
Present probe length	→ 173
▶ Current output 1 to 2	→ 174
Assign current output	→ 174
Current span	→ 175
Fixed current	→ 175
Damping output	→ 176
Failure mode	→ 176
Failure current	→ 177
Output current 1 to 2	→ 177
▶ Switch output	→ 178
Switch output function	→ 178
Assign status	→ 179
Assign limit	→ 179
Assign diagnostic behavior	→ 179
Switch-on value	→ 180
Switch-on delay	→ 181
Switch-off value	→ 181
Switch-off delay	→ 182

Failure mode	→ 182
Switch status	→ 182
Invert output signal	→ 182
► Display	→ 184
Language	→ 184
Format display	→ 184
Value 1 to 4 display	→ 186
Decimal places 1 to 4	→ 186
Display interval	→ 186
Display damping	→ 187
Header	→ 187
Header text	→ 188
Separator	→ 188
Number format	→ 188
Decimal places menu	→ 188
Backlight	→ 189
Contrast display	→ 189
► Configuration backup display	→ 190
Operating time	→ 190
Last backup	→ 190























Configuration management	→ 190
Comparison result	→ 191
▶ Administration	→ 193
▶ Define access code	→ 195
Define access code	→ 195
Confirm access code	→ 195
Device reset	→ 193
🔍 Diagnostics	→ 196
Actual diagnostics	→ 196
Previous diagnostics	→ 196
Operating time from restart	→ 197
Operating time	→ 190
▶ Diagnostic list	→ 198
Diagnostics 1 to 5	→ 198
▶ Event logbook	→ 199
Filter options	→ 199
▶ Event list	→ 199
▶ Device information	→ 200
Device tag	→ 200
Serial number	→ 200
Firmware version	→ 200
Device name	→ 200
Order code	→ 201
Extended order code 1 to 3	→ 201
Device revision	→ 201

























Device ID	→  201
Device type	→  202
Manufacturer ID	→  202
▶ Measured values	→  203
Distance	→  143
Level linearized	→  161
Output current 1 to 2	→  177
Measured current 1	→  204
Terminal voltage 1	→  204
▶ Data logging	→  205
Assign channel 1 to 4	→  205
Logging interval	→  206
Clear logging data	→  206
▶ Display channel 1 to 4	→  207
▶ Simulation	→  209
Assign measurement variable	→  210
Process variable value	→  210
Current output 1 to 2 simulation	→  210
Value current output 1 to 2	→  211
Switch output simulation	→  211
Switch status	→  211
Device alarm simulation	→  212
▶ Device check	→  213
Start device check	→  213
Result device check	→  213

Last check time	→ 213
Level signal	→ 214
Launch signal	→ 214

17.3 Overview of the operating menu (operating tool)

Navigation  Operating menu

























Setup	→  140
Device tag	→  140
Distance unit	→  140
Tank type	→  140
Tube diameter	→  141
Medium group	→  141
Empty calibration	→  142
Full calibration	→  142
Level	→  143
Distance	→  143
Signal quality	→  144
Confirm distance	→  145
Present mapping	→  146
Mapping end point	→  146
Record map	→  146
► Advanced setup	→  149
Locking status	→  149
Access status tooling	→  149
Enter access code	→  150
► Level	→  151
Medium type	→  151
Medium property	→  151
Process property	→  152

Advanced process conditions	→  153
Level unit	→  154
Blocking distance	→  154
Level correction	→  155
► Linearization	→  157
Linearization type	→  159
Unit after linearization	→  160
Free text	→  161
Level linearized	→  161
Maximum value	→  162
Diameter	→  162
Intermediate height	→  162
Table mode	→  163
Table number	→  164
Level	→  164
Level	→  165
Customer value	→  165
Activate table	→  165
► Safety settings	→  166
Output echo lost	→  166
Value echo lost	→  166
Ramp at echo lost	→  167
Blocking distance	→  154
► SIL/WHG confirmation	→  169

▶ Deactivate SIL/WHG	→ 170
Reset write protection	→ 170
Code incorrect	→ 170
▶ Probe settings	→ 171
Probe grounded	→ 171
Present probe length	→ 171
Confirm probe length	→ 172
▶ Current output 1 to 2	→ 174
Assign current output	→ 174
Current span	→ 175
Fixed current	→ 175
Damping output	→ 176
Failure mode	→ 176
Failure current	→ 177
Output current 1 to 2	→ 177
▶ Switch output	→ 178
Switch output function	→ 178
Assign status	→ 179
Assign limit	→ 179
Assign diagnostic behavior	→ 179
Switch-on value	→ 180
Switch-on delay	→ 181
Switch-off value	→ 181
Switch-off delay	→ 182
Failure mode	→ 182





Switch status	→ 182
Invert output signal	→ 182
► Display	→ 184
Language	→ 184
Format display	→ 184
Value 1 to 4 display	→ 186
Decimal places 1 to 4	→ 186
Display interval	→ 186
Display damping	→ 187
Header	→ 187
Header text	→ 188
Separator	→ 188
Number format	→ 188
Decimal places menu	→ 188
Backlight	→ 189
Contrast display	→ 189
► Configuration backup display	→ 190
Operating time	→ 190
Last backup	→ 190
Configuration management	→ 190

Backup state	→ 📄 191
Comparison result	→ 📄 191
▶ Administration	→ 📄 193
Define access code	→ 📄 195
Device reset	→ 📄 193
🔍 Diagnostics	→ 📄 196
Actual diagnostics	→ 📄 196
Timestamp	→ 📄 196
Previous diagnostics	→ 📄 196
Timestamp	→ 📄 197
Operating time from restart	→ 📄 197
Operating time	→ 📄 190
▶ Diagnostic list	→ 📄 198
Diagnostics 1 to 5	→ 📄 198
Timestamp 1 to 5	→ 📄 198
▶ Device information	→ 📄 200
Device tag	→ 📄 200
Serial number	→ 📄 200
Firmware version	→ 📄 200
Device name	→ 📄 200
Order code	→ 📄 201
Extended order code 1 to 3	→ 📄 201
Device revision	→ 📄 201
Device ID	→ 📄 201

Device type	→  202
Manufacturer ID	→  202
▶ Measured values	→  203
Distance	→  143
Level linearized	→  161
Output current 1 to 2	→  177
Measured current 1	→  204
Terminal voltage 1	→  204
▶ Data logging	→  205
Assign channel 1 to 4	→  205
Logging interval	→  206
Clear logging data	→  206
▶ Simulation	→  209
Assign measurement variable	→  210
Process variable value	→  210
Current output 1 to 2 simulation	→  210
Value current output 1 to 2	→  211
Switch output simulation	→  211
Switch status	→  211
Device alarm simulation	→  212
▶ Device check	→  213
Start device check	→  213
Result device check	→  213
Last check time	→  213



Level signal	→ 214
Launch signal	→ 214
▶ Heartbeat	→ 215

17.4 "Setup" menu



- i
 - 
 -  : Marks the navigation path to the parameter via the display and operating module.
 -  : Marks the navigation path to the parameter via an operating tool (e.g. FieldCare).
 -  : Marks parameters which can be locked via the software locking.

Navigation   Setup



Device tag

- Navigation**   Setup → Device tag
- Description** Enter a unique name for the measuring point to identify the device quickly within the plant.
- Factory setting** FMP5x

Distance unit



- Navigation**   Setup → Distance unit
- Description** Used for the basic calibration (Empty / Full).
- Selection**
- | <i>SI units</i> | <i>US units</i> |
|---|--|
| <ul style="list-style-type: none"> ▪ mm ▪ m | <ul style="list-style-type: none"> ▪ ft ▪ in |
- Factory setting** m

Tank type





- Navigation**   Setup → Tank type
- Prerequisite** **Medium type** (→  151) = **Liquid**
- Description** Select tank type.
- Selection**
- Metallic
 - Bypass / pipe
 - Non metallic
 - Mounted outside
 - Coaxial
- Factory setting** Depending on the probe

- Additional information**
- Depending on the probe some of the options mentioned above may not be available or there may be additional options.
 - For coax probes and probes with metallic center washer **Tank type** parameter corresponds to the type of probe and cannot be changed.



Tube diameter 

- Navigation**   Setup → Tube diameter
- Prerequisite** **Tank type** (→  140) = **Bypass / pipe**
- Description** Specify diameter of bypass or stilling well.
- User entry** 0 to 9.999 m
- Factory setting** 0.0384 m

Medium group 

- Navigation**   Setup → Medium group
- Prerequisite** **Medium type** (→  151) = **Liquid**
- Description** Select medium group.
- Selection**
- Others
 - Water based (DC >= 4)
- Factory setting** Others
- Additional information** This parameter roughly specifies the dielectric constant (DC) of the medium. For a more detailed definition of the DC use the **Medium property** parameter (→  151).
The **Medium group** parameter presets the **Medium property** parameter (→  151) as follows:

Medium group	Medium property (→  151)
Others	Unknown
Water based (DC >= 4)	DC 4 ... 7

-  The **Medium property** parameter can be changed at a later point of time. However, when doing so, the **Medium group** parameter retains its value. Only the **Medium property** parameter is relevant for the signal evaluation.
-  The measuring range may be reduced for small dielectric constants. For details refer to the Technical Information (TI) of the respective device.

Empty calibration

**Navigation** Setup → Empty calibration**Description**

Distance between process connection and minimum level (0%).

User entry

Depending on the probe

Factory setting

Depending on the probe

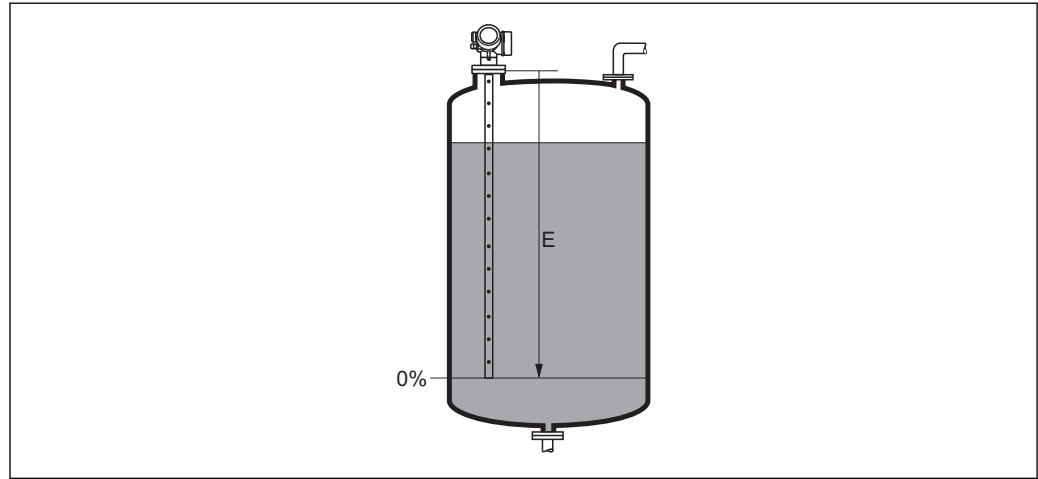
Additional information

A0013178

 45 *Empty calibration (E) for level measurements in liquids*

Full calibration

**Navigation** Setup → Full calibration**Description**

Distance between minimum level (0%) and maximum level (100%).

User entry

Depending on the probe

Factory setting

Depending on the probe

Additional information

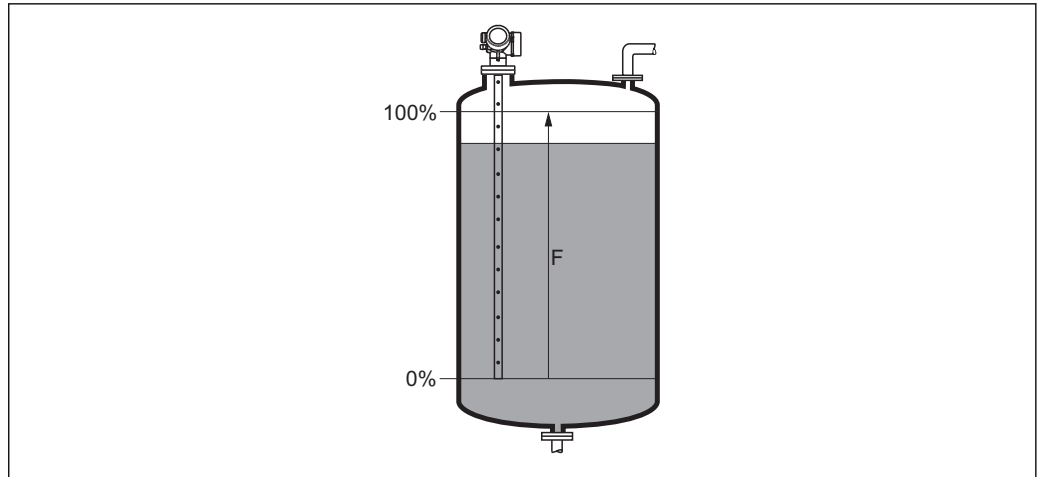

A0013186

46 Full calibration (F) for level measurements in liquids

Level

Navigation

Setup → Level

Description

Displays measured level L_L (before linearization).

Additional information

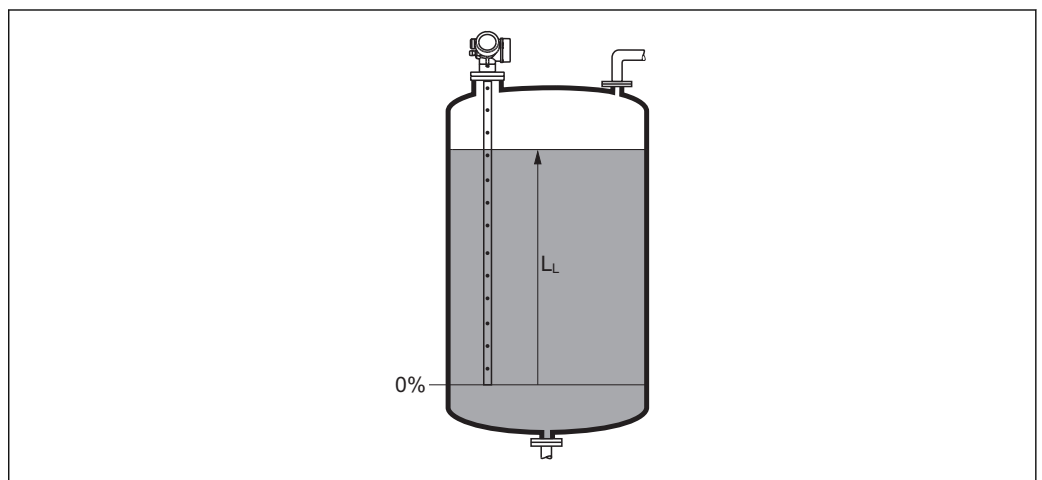

A0013194

47 Level in case of liquid measurements

i The unit is defined in the **Level unit** parameter (→ 154).

Distance

Navigation

Setup → Distance

Description

Displays the measured distance D_L between the reference point (lower edge of the flange or threaded connection) and the level.

Additional information

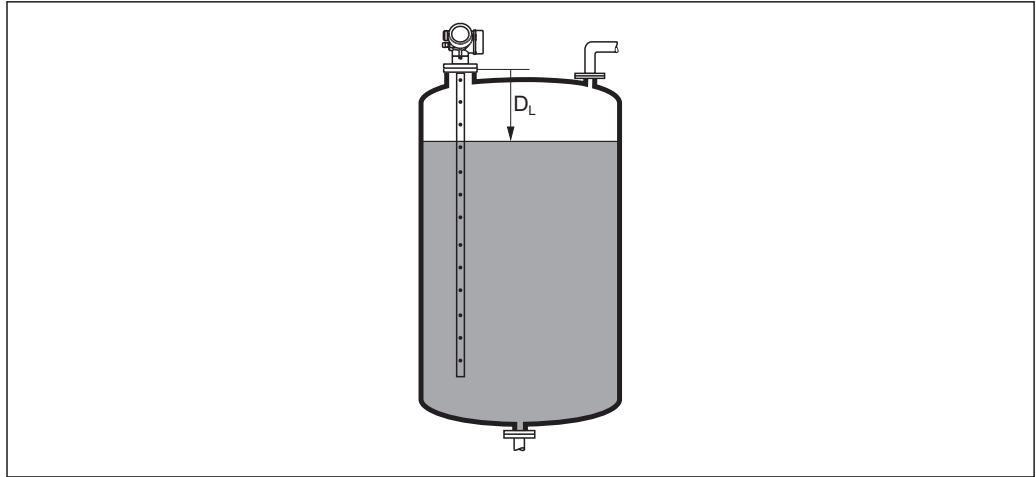

A0013196

48 Distance for liquid measurements

i The unit is defined in the **Distance unit** parameter (→ 140).

Signal quality

Navigation

Setup → Signal quality

Description

Displays the signal quality of the evaluated echo.

Additional information

Meaning of the display options





- **Strong**
The evaluated echo exceeds the threshold by at least 10 mV.
- **Medium**
The evaluated echo exceeds the threshold by at least 5 mV.
- **Weak**
The evaluated echo exceeds the threshold by less than 5 mV.
- **No signal**
The device does not find a usable echo.

The signal quality indicated in this parameter always refers to the currently evaluated echo: either the level/interface echo⁵⁾ or the end-of-probe echo. To differentiate between these two, the quality of the end-of-probe echo is always displayed in brackets.

i In case of a lost echo (**Signal quality = No signal**) the device generates the following error message:

- F941, for **Output echo lost** (→ 166) = **Alarm**.
- S941, if another option has been selected in **Output echo lost** (→ 166).

5) Of these two echos the one with the lower quality is indicated.

Confirm distance 	
Navigation	 Setup → Confirm distance
Description	Specify, whether the measured distance matches the real distance. Depending on the selection the device automatically sets the range of mapping.
Selection	<ul style="list-style-type: none"> ■ Manual map ■ Distance ok ■ Distance unknown ■ Distance too small[*] ■ Distance too big[*] ■ Tank empty ■ Delete map
Factory setting	Distance unknown
Additional information	<p>Meaning of the options</p> <ul style="list-style-type: none"> ■ Manual map To be selected if the range of mapping is to be defined manually in the Mapping end point parameter (→  146). In this case it is not necessary to confirm the distance. ■ Distance ok To be selected if the measured distance matches the actual distance. The device performs a mapping. ■ Distance unknown To be selected if the actual distance is unknown. A mapping can not be performed in this case. ■ Distance too small To be selected if the measured distance is smaller than the actual distance. The device searches for the next echo and returns to the Confirm distance parameter. The distance is recalculated and displayed. The comparison must be repeated until the displayed distance matches the actual distance. After this, the recording of the map can be started by selecting Distance ok. ■ Distance too big⁶⁾ To be selected if the measured distance exceeds the actual distance. The device adjusts the signal evaluation and returns to the Confirm distance parameter. The distance is recalculated and displayed. The comparison must be repeated until the displayed distance matches the actual distance. After this, the recording of the map can be started by selecting Distance ok. ■ Tank empty To be selected if the tank is completely empty. The device records a mapping covering the complete measuring range. ■ Factory map To be selected if the present mapping curve (if one exists) is to be deleted. The device returns to the Confirm distance parameter and a new mapping can be recorded. <p> When operating via the display module, the measured distance is displayed together with this parameter for reference purposes.</p> <p> If the teaching procedure with the Distance too small option or the Distance too big option is quit before the distance has been confirmed, a map is not recorded and the teaching procedure is reset after 60 s.</p>





* Visibility depends on order options or device settings

6) Only available for "Expert → Sensor → Echo tracking → **Evaluation mode** parameter" = "Short time history" or "Long time history"



Present mapping

Navigation	 Setup → Present mapping
Description	Indicates up to which distance a mapping has already been recorded.

Mapping end point

Navigation	 Setup → Mapping end point
Prerequisite	Confirm distance (→  145) = Manual map or Distance too small
Description	Specify new end of the mapping.
User entry	0 to 200 000.0 m
Factory setting	0.1 m
Additional information	<p>This parameter defines up to which distance the new mapping is to be recorded. The distance is measured from the reference point, i.e. from the lower edge of the mounting flange or the threaded connection.</p> <p> For reference purposes the Present mapping parameter (→  146) is displayed together with this parameter. It indicates up to which distance a mapping has already been recorded.</p>

Record map

Navigation	 Setup → Record map
Prerequisite	Confirm distance (→  145) = Manual map or Distance too small
Description	Start recording of the map.
Selection	<ul style="list-style-type: none"> ■ No ■ Record map ■ Delete map
Factory setting	No

Additional information**Meaning of the options****■ No**

The map is not recorded.



■ Record map

The map is recorded. After the recording is completed, the new measured distance and the new mapping range appear on the display. When operating via the local display, these values must be confirmed by pressing .

■ Delete map

The mapping (if one exists) is deleted and the device displays the recalculated measured distance and the mapping range. When operating via the local display, these values must be confirmed by pressing .

17.4.1 "Mapping" wizard

 The **Mapping** wizard is only available when operating via the local display. When operating via an operating tool, all parameters concerning the mapping are located directly in the **Setup** menu (→  140).

 In the **Mapping** wizard two parameters are displayed simultaneously on the display module at any one time. The upper parameter can be edited, whereas the lower parameter is displayed for reference purposes only.

Navigation  Setup → Mapping

Confirm distance

Navigation  Setup → Mapping → Confirm distance

Description →  145

Mapping end point

Navigation  Setup → Mapping → Mapping end point

Description →  146

Record map

Navigation  Setup → Mapping → Record map

Description →  146

Distance





Navigation  Setup → Mapping → Distance

Description →  143





17.4.2 "Advanced setup" submenu

Navigation  Setup → Advanced setup





Locking status

Navigation	  Setup → Advanced setup → Locking status
Description	Indicates the write protection with the highest priority that is currently active.
User interface	<ul style="list-style-type: none"> ▪ Hardware locked ▪ SIL locked ▪ CT active - defined parameters ▪ WHG locked ▪ Temporarily locked
Additional information	<p>Meaning and priorities of the types of write protection</p> <ul style="list-style-type: none"> ▪ Hardware locked (priority 1) The DIP switch for hardware locking is activated on the main electronics module. This locks write access to the parameters. ▪ SIL locked (priority 2) The SIL mode is activated. Writing access to the relevant parameters is denied. ▪ WHG locked (priority 3) The WHG mode is activated. Writing access to the relevant parameters is denied. ▪ Temporarily locked (priority 4) Write access to the parameters is temporarily locked on account of internal processes in progress in the device (e.g. data upload/download, reset etc.). The parameters can be modified as soon as the processes are complete. <p> On the display module, the -symbol appears in front of parameters that cannot be modified since they are write-protected.</p>





Access status tooling

Navigation	 Setup → Advanced setup → Access status tooling
Description	Shows the access authorization to the parameters via the operating tool.
Additional information	<p> The access authorization can be changed via the Enter access code parameter (→  150).</p> <p> If additional write protection is active, this restricts the current access authorization even further. The write protection status can be viewed via the Locking status parameter (→  149).</p>

Access status display

Navigation	 Setup → Advanced setup → Access status display
Prerequisite	The device has a local display.
Description	Indicates access authorization to parameters via local display.
Additional information	<p> The access authorization can be changed via the Enter access code parameter (→  150).</p> <p> If additional write protection is active, this restricts the current access authorization even further. The write protection status can be viewed via the Locking status parameter (→  149).</p>



Enter access code

Navigation	 Setup → Advanced setup → Enter access code
Description	Enter access code to disable write protection of parameters.
User entry	0 to 9999
Additional information	<ul style="list-style-type: none"> ▪ For local operation, the customer-specific access code, which has been defined in the Define access code parameter (→  193), has to be entered. ▪ If an incorrect access code is entered, the user retains his current access authorization. ▪ The write protection affects all parameters marked with the -symbol in this document. On the local display, the -symbol in front of a parameter indicates that the parameter is write-protected. ▪ If no key is pressed for 10 min, or the user switches from the navigation and editing mode back to the measured value display mode, the device automatically locks the write-protected parameters after another 60 s. <p> Please contact your Endress+Hauser Sales Center if you lose your access code.</p>





"Level" submenu

Navigation   Setup → Advanced setup → Level

Medium type 

Navigation	  Setup → Advanced setup → Level → Medium type
Description	Specify type of medium.
User interface	<ul style="list-style-type: none"> ■ Liquid ■ Solid
Factory setting	FMP50, FMP51, FMP52, FMP53, FMP54, FMP55: Liquid
Additional information	 This parameter determines the value of several other parameters and strongly influences the complete signal evaluation. Therefore, it is strongly recommended not to change the factory setting.

Medium property 

Navigation	  Setup → Advanced setup → Level → Medium property
Prerequisite	EOP level evaluation ≠ Fix DC
Description	Specify relative dielectric constant ϵ_r of the medium.
Selection	<ul style="list-style-type: none"> ■ Unknown ■ DC 1.4 ... 1.6 ■ DC 1.6 ... 1.9 ■ DC 1.9 ... 2.5 ■ DC 2.5 ... 4 ■ DC 4 ... 7 ■ DC 7 ... 15 ■ DC > 15
Factory setting	Dependent on Medium type (→  151) and Medium group (→  141).

Additional information

Dependency on "Medium type" and "Medium group"

Medium type (→ ⓘ 151)	Medium group (→ ⓘ 141)	Medium property
Solid		Unknown
Liquid	Water based (DC >= 4)	DC 4 ... 7
	Others	Unknown

-  For dielectric constants (DC values) of many media commonly used in various industries refer to:
 - the Endress+Hauser DC manual (CP01076F)
 - the Endress+Hauser "DC Values App" (available for Android and iOS)

-  For **EOP level evaluation = Fix DC**, the exact dielectric constant has to be entered into the **DC value** parameter. Therefore, the **Medium property** parameter is not available in this case.

Process property



Navigation

  Setup → Advanced setup → Level → Process property

Description

Specify typical rate of level change.

Selection

For "Medium type" = "Liquid"

- Very fast > 10 m (400 in)/min
- Fast > 1 m (40 in)/min
- Standard < 1 m (40in) /min
- Medium < 10 cm (4in) /min
- Slow < 1 cm (0.4in) /min
- No filter / test

For "Medium type" = "Solid"

- Very fast > 100 m (333 ft) /h
- Fast > 10 m (33 ft) /h
- Standard < 10 m (33 ft) /h
- Medium < 1 m (3ft) /h
- Slow < 0.1 m (0.3ft) /h
- No filter / test

Factory setting

Standard < 1 m (40in) /min

Additional information

The device adjusts the signal evaluation filters and the damping of the output signal to the typical rate of level change defined in this parameter:

For "Operating mode" = "Level" and "Medium type" = "Liquid"

Process property	Step response time / s
Very fast > 10 m (400 in)/min	5
Fast > 1 m (40 in)/min	5
Standard < 1 m (40in) /min	14
Medium < 10 cm (4in) /min	39
Slow < 1 cm (0.4in) /min	76
No filter / test	< 1

For "Operating mode" = "Level" and "Medium type" = "Solid"

Process property	Step response time / s
Very fast > 100 m (333 ft) /h	37
Fast > 10 m (33 ft) /h	37
Standard < 10 m (33 ft) /h	74
Medium < 1 m (3ft) /h	146
Slow < 0.1 m (0.3ft) /h	290
No filter / test	< 1

For "Operating mode" = "Interface" or "Interface with capacitance"

Process property	Step response time / s
Very fast > 10 m (400 in)/min	5
Fast > 1 m (40 in)/min	5
Standard < 1 m (40in) /min	23
Medium < 10 cm (4in) /min	47
Slow < 1 cm (0.4in) /min	81
No filter / test	2.2

Advanced process conditions



Navigation

Setup → Advanced setup → Level → Advanced process conditions

Description

Specify additional process conditions (if required).

Selection

- None
- Oil/Water condensate
- Probe near tank bottom
- Build up
- Foam (>5cm/0,16ft)

Factory setting

None

Additional information

Meaning of the options

- **Oil/Water condensate** (only **Medium type = Liquid**)
Makes sure that in the case of two-phase media only the total level is detected (example: oil/condensate application).
- **Probe near tank bottom** (only for **Medium type = Liquid**)
Improves the empty detection, especially if the probe is mounted close to the tank bottom.
- **Build up**
Enables a safe empty-detection even if the end-of-probe signal has shifted due to build-up.
- **Foam (>5cm/0,16ft)** (only for **Medium type = Liquid**)
Optimizes the signal evaluation in applications with foam formation.

Level unit

Navigation	Setup → Advanced setup → Level → Level unit	
Description	Select level unit.	
Selection	<i>SI units</i> <ul style="list-style-type: none"> ■ % ■ m ■ mm 	<i>US units</i> <ul style="list-style-type: none"> ■ ft ■ in
Factory setting	%	
Additional information	<p>The level unit may differ from the distance unit defined in the Distance unit parameter (→ 140):</p> <ul style="list-style-type: none"> ■ The unit defined in the Distance unit parameter is used for the basic calibration (Empty calibration (→ 142) and Full calibration (→ 142)). ■ The unit defined in the Level unit parameter is used to display the (nonlinearized) level. 	

Blocking distance

Navigation	Setup → Advanced setup → Level → Blocking distance	
Description	Specify upper blocking distance UB.	
User entry	0 to 200 m	
Factory setting	<ul style="list-style-type: none"> ■ For rod and rope probes up to 8 m (26 ft): 200 mm (8 in) ■ For rod and rope probes above 8 m (26 ft): 0.025 * Sondenlänge 	
Additional information	<p>Signals in the upper blocking distance are only evaluated if they have been outside the blocking distance when the device was switched on and move into the blocking distance due to a level change during operation. Signals which are already in the blocking distance when the device is switched on, are ignored.</p> <p> This behavior is only valid if the following two conditions are met:</p> <ul style="list-style-type: none"> ■ Expert → Sensor → Echo tracking → Evaluation mode = Short time history or Long time history) ■ Expert → Sensor → Gas phase compensation → GPC mode= On, Without correction or External correction <p>If one of these conditions is not met, signals in the blocking distance will always be ignored.</p> <p> If required, a different behavior for signals in the blocking distance can be defined by the Endress+Hauser service.</p>	

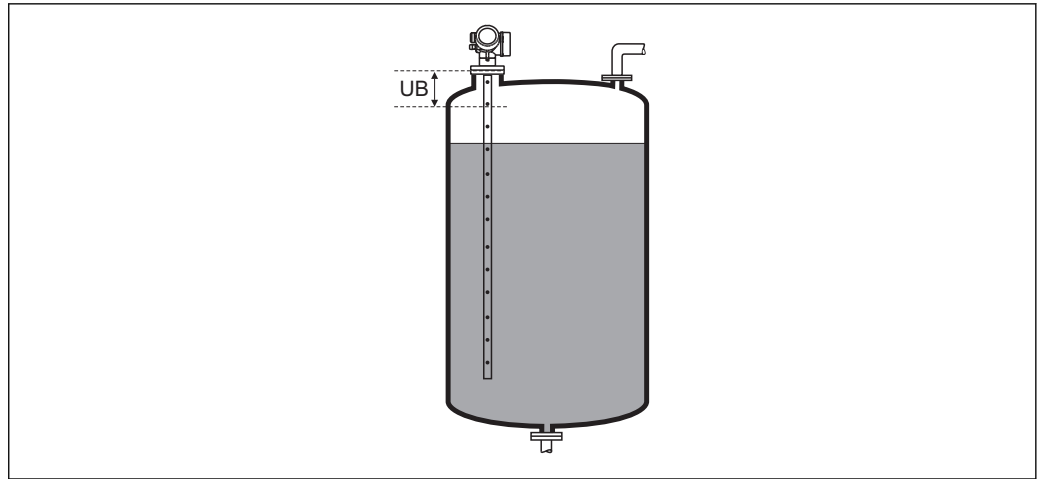

A0013219

49 Blocking distance (UB) for liquid measurements

Level correction



Navigation	☰☰ Setup → Advanced setup → Level → Level correction
Description	Specify level correction (if required).
User entry	-200 000.0 to 200 000.0 %
Factory setting	0.0 %
Additional information	The value specified in this parameter is added to the measured level (before linearization).

"Linearization" submenu

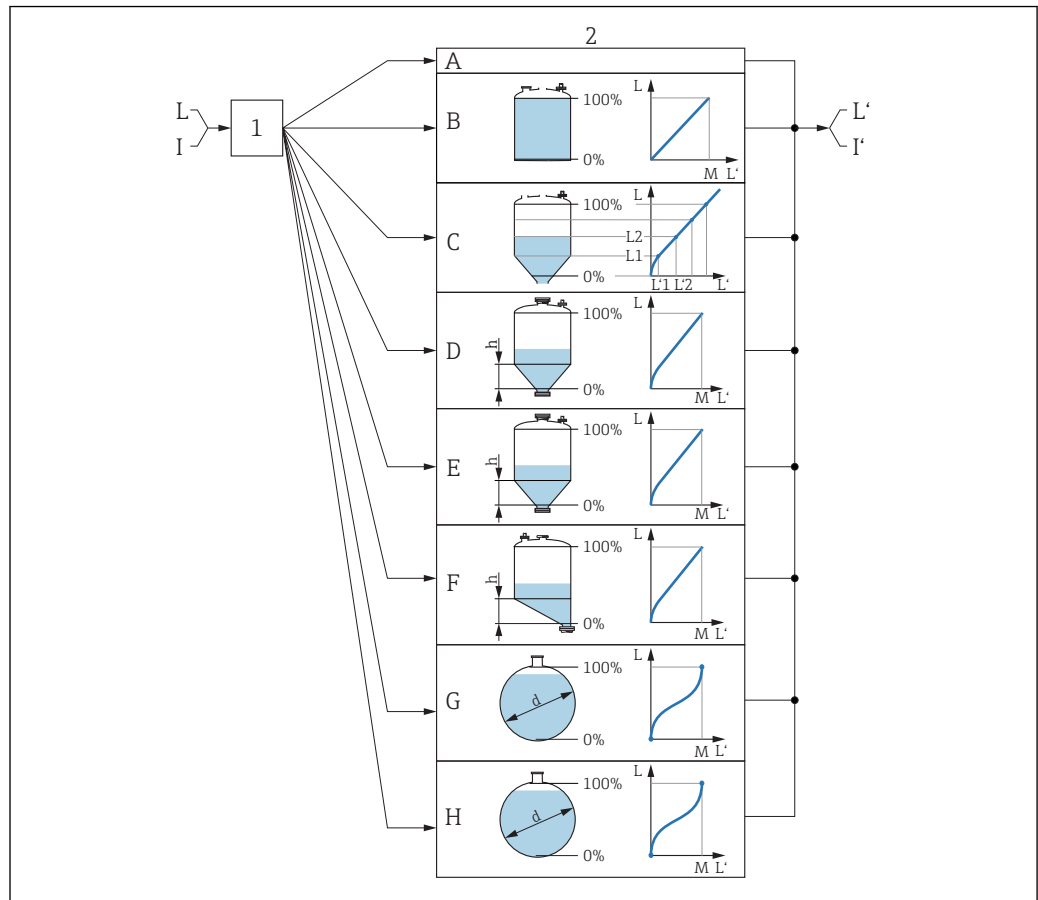











A0016084

50 Linearization: Transformation of the level and (if relevant) the interface height into a volume or weight; the transformation is dependent on the shape of the vessel.

- 1 Selection of linearization type and unit
- 2 Configuration of the linearization
- A Linearization type (→ 159) = None
- B Linearization type (→ 159) = Linear
- C Linearization type (→ 159) = Table
- D Linearization type (→ 159) = Pyramid bottom
- E Linearization type (→ 159) = Conical bottom
- F Linearization type (→ 159) = Angled bottom
- G Linearization type (→ 159) = Horizontal cylinder
- H Linearization type (→ 159) = Sphere
- I For "Operating mode" = "Interface" or "Interface with capacitance": Interface before linearization (measured in distance units)
- I' For "Operating mode" = "Interface" or "Interface with capacitance": Interface after linearization (corresponds to volume or weight)
- L Level before linearization (measured in distance units)
- L' Level linearized (→ 161) (corresponds to volume or weight)
- M Maximum value (→ 162)
- d Diameter (→ 162)
- h Intermediate height (→ 162)













Structure of the submenu on the display module

Navigation  Setup → Advanced setup → Linearization

► Linearization		
Linearization type		→  159
Unit after linearization		→  160
Free text		→  161
Maximum value		→  162
Diameter		→  162
Intermediate height		→  162
Table mode		→  163
► Edit table		
	Level	→  164
	Customer value	→  165
Activate table		→  165

Structure of the submenu in an operating tool (e.g. FieldCare)

Navigation  Setup → Advanced setup → Linearization

► Linearization	
Linearization type	→  159
Unit after linearization	→  160
Free text	→  161
Level linearized	→  161
Maximum value	→  162
Diameter	→  162
Intermediate height	→  162
Table mode	→  163
Table number	→  164
Level	→  164
Level	→  165
Customer value	→  165
Activate table	→  165

Description of parameters

Navigation  Setup → Advanced setup → Linearization

Linearization type 

Navigation  Setup → Advanced setup → Linearization → Linearization type

Description Select linearization type.

- Selection**
- None
 - Linear
 - Table
 - Pyramid bottom
 - Conical bottom
 - Angled bottom
 - Horizontal cylinder
 - Sphere

Factory setting None

Additional information

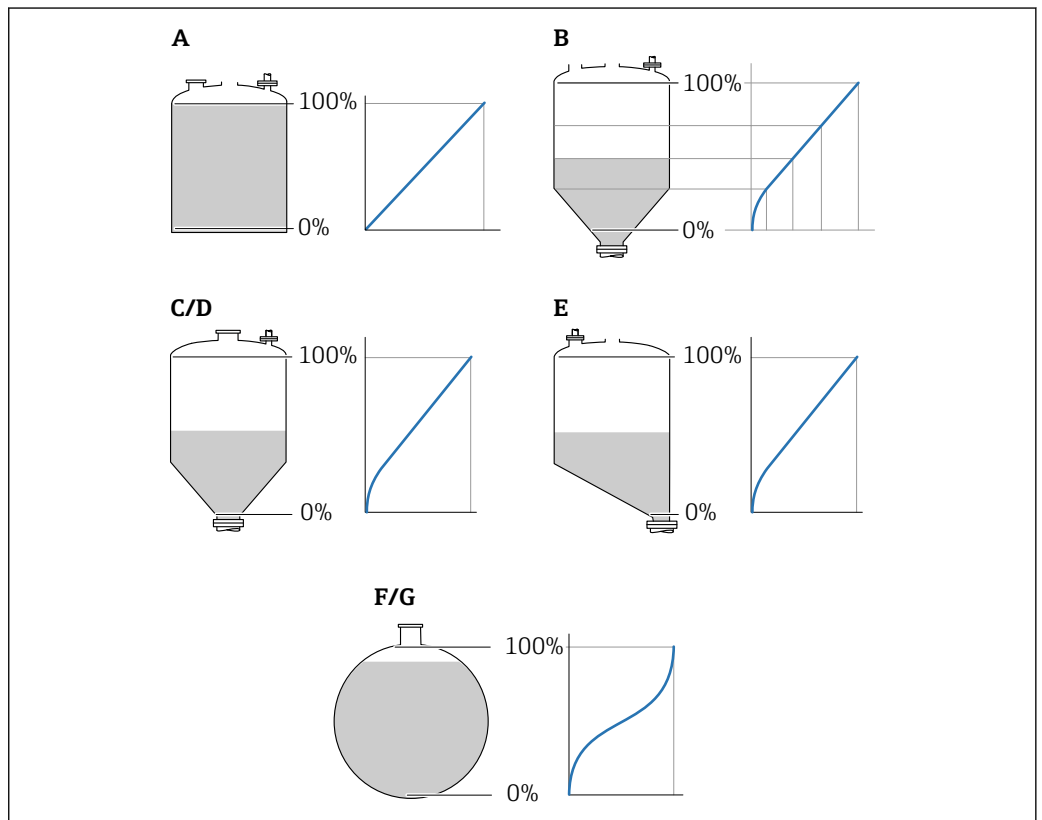

 51 *Linearization types*

- A None
- B Table
- C Pyramid bottom
- D Conical bottom
- E Angled bottom
- F Sphere
- G Horizontal cylinder



A0021476

Meaning of the options**■ None**

The level is transmitted in the level unit without linearization.





■ Linear

The output value (volume/weight) is directly proportional to the level L. This is valid, for example, for vertical cylinders. The following additional parameters have to be specified:

- **Unit after linearization** (→  160)
- **Maximum value** (→  162): Maximum volume or weight

■ Table



The relationship between the measured level L and the output value (volume/weight) is given by a linearization table consisting of up to 32 pairs of values "level - volume" or "level - weight", respectively. The following additional parameters have to be specified:

- **Unit after linearization** (→  160)
- **Table mode** (→  163)
- For each table point: **Level** (→  164)
- For each table point: **Customer value** (→  165)
- **Activate table** (→  165)

■ Pyramid bottom



The output value corresponds to the volume or weight in a silo with pyramid bottom.

The following additional parameters have to be specified:

- **Unit after linearization** (→  160)
- **Maximum value** (→  162): Maximum volume or weight
- **Intermediate height** (→  162): The height of the pyramid

■ Conical bottom



The output value corresponds to the volume or weight in a tank with conical bottom. The following additional parameters have to be specified:

- **Unit after linearization** (→  160)
- **Maximum value** (→  162): Maximum volume or weight
- **Intermediate height** (→  162): The height of the conical part of the tank

■ Angled bottom



The output value corresponds to the volume or weight in a silo with an angled bottom.

The following additional parameters have to be specified:

- **Unit after linearization** (→  160)
- **Maximum value** (→  162): Maximum volume or weight
- **Intermediate height** (→  162): Height of the angled bottom



■ Horizontal cylinder

The output value corresponds to the volume or weight in a horizontal cylinder. The following additional parameters have to be specified:

- **Unit after linearization** (→  160)
- **Maximum value** (→  162): Maximum volume or weight
- **Diameter** (→  162)

■ Sphere

The output value corresponds to the volume or weight in a spherical tank. The following additional parameters have to be specified:

- **Unit after linearization** (→  160)
- **Maximum value** (→  162): Maximum volume or weight
- **Diameter** (→  162)

Unit after linearization**Navigation**

  Setup → Advanced setup → Linearization → Unit after linearization

Prerequisite

Linearization type (→  159) ≠ None

Description

Select unit of the linearized value.



Selection	<i>SI units</i> <ul style="list-style-type: none"> ▪ STon ▪ t ▪ kg ▪ cm³ ▪ dm³ ▪ m³ ▪ hl ▪ l ▪ % ▪ mm ▪ m 	<i>US units</i> <ul style="list-style-type: none"> ▪ lb ▪ UsGal ▪ ft³ ▪ ft ▪ in 	<i>Imperial units</i> impGal
------------------	---	---	---------------------------------

Custom-specific units



Free text

Factory setting %

Additional information The selected unit is only used to be indicated on the display. The measured value is **not** transformed according to the selected unit.

 It is also possible to configure a distance-to-distance linearization, i.e. a transformation from the level unit to a different distance unit. To do so, select the **Linear** linearization mode. In order to define the new level unit, select the **Free text** option in the **Unit after linearization** parameter and enter the required unit into the **Free text** parameter (→  161).

Free text 

Navigation   Setup → Advanced setup → Linearization → Free text

Prerequisite **Unit after linearization** (→  160) = **Free text**

Description Enter unit symbol.



User entry Up to 32 alphanumerical characters (letters, numbers, special characters)

Factory setting Free text



Level linearized

Navigation  Setup → Advanced setup → Linearization → Level linearized





Description Displays linearized level.

Additional information  The unit is defined by the **Unit after linearization** parameter →  160.



Maximum value

Navigation	  Setup → Advanced setup → Linearization → Maximum value
Prerequisite	Linearization type (→  159) has one of the following values: <ul style="list-style-type: none"> ■ Linear ■ Pyramid bottom ■ Conical bottom ■ Angled bottom ■ Horizontal cylinder ■ Sphere
Description	Linearized value corresponding to a level of 100%.
User entry	-50 000.0 to 50 000.0 %
Factory setting	100.0 %

Diameter

Navigation	  Setup → Advanced setup → Linearization → Diameter
Prerequisite	Linearization type (→  159) has one of the following values: <ul style="list-style-type: none"> ■ Horizontal cylinder ■ Sphere
Description	Diameter of the cylindrical or spherical tank.
User entry	0 to 9 999.999 m
Factory setting	2 m
Additional information	The unit is defined in the Distance unit parameter (→  140).

Intermediate height

Navigation	  Setup → Advanced setup → Linearization → Intermediate height
Prerequisite	Linearization type (→  159) has one of the following values: <ul style="list-style-type: none"> ■ Pyramid bottom ■ Conical bottom ■ Angled bottom
Description	Height of the pyramid, conical or angled bottom.
User entry	0 to 200 m
Factory setting	0 m

Additional information

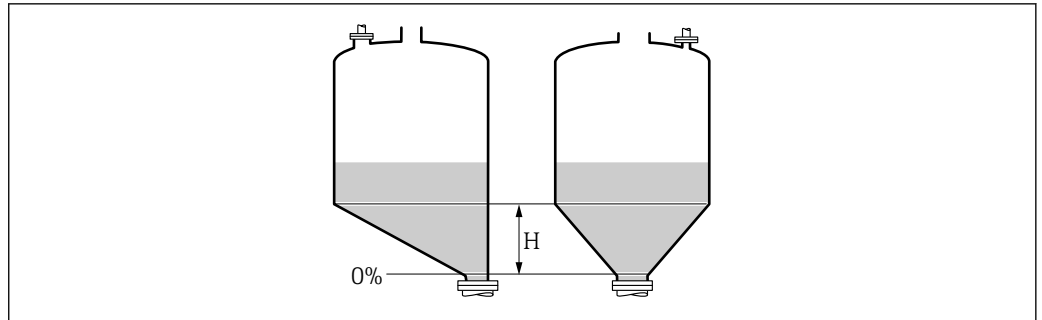

A0013264

H Intermediate height

The unit is defined in the **Distance unit** parameter (→ [140](#)).

Table mode



Navigation

Setup → Advanced setup → Linearization → Table mode

Prerequisite

Linearization type (→ [159](#)) = Table

Description

Select editing mode of the linearization table.

Selection

- Manual
- Semiautomatic
- Clear table
- Sort table

Factory setting

Manual

Additional information

Meaning of the options

- **Manual**
The level and the associated linearized value are entered manually for each linearization point.
- **Semiautomatic**
The level is measured by the device for each linearization point. The associated linearized value is entered manually.
- **Clear table**
Deletes the existing linearization table.
- **Sort table**
Rearranges the linearization points into an ascending order.

Conditions the linearization table must meet:



- The table may consist of up to 32 pairs of values "Level - Linearized Value".
- The table must be monotonic (monotonically increasing or decreasing).
- The first linearization point must refer to the minimum level.
- The last linearization point must refer to the maximum level.

Before entering a linearization table, the values for **Empty calibration** (→ [142](#)) and **Full calibration** (→ [142](#)) must be set correctly.

If values of the table need to be changed after the full or empty calibration have been changed, a correct evaluation is only ensured if the existing table is deleted and the complete table is entered again. To do so delete the existing table (**Table mode** (→ [163](#)) = **Clear table**). Then enter a new table.



How to enter the table

■ Via FieldCare

The table points can be entered via the **Table number** (→  164), **Level** (→  164) and **Customer value** (→  165) parameters. As an alternative, the graphic table editor may be used: Device Operation → Device Functions → Additional Functions → Linearization (Online/Offline)

■ Via local display

Select the **Edit table** submenu to call up the graphic table editor. The table is displayed and can be edited line by line.

 The factory setting for the level unit is "%". If you want to enter the linearization table in physical units, you must select the appropriate unit in the **Level unit** parameter (→  154) beforehand.



 If a decreasing table is entered, the values for 20 mA and 4 mA of the current output are interchanged. That means: 20 mA refers to the lowest level, whereas 4 mA refers to the highest level.

Table number 

Navigation  Setup → Advanced setup → Linearization → Table number

Prerequisite **Linearization type** (→  159) = **Table**

Description Select table point you are going to enter or change.



User entry 1 to 32

Factory setting 1

Level (Manual) 

Navigation  Setup → Advanced setup → Linearization → Level

Prerequisite



- **Linearization type** (→  159) = **Table**
- **Table mode** (→  163) = **Manual**

Description Enter level value of the table point (value before linearization).



User entry Signed floating-point number

Factory setting 0 %





Level (Semiautomatic)

Navigation	 Setup → Advanced setup → Linearization → Level
Prerequisite	<ul style="list-style-type: none"> ▪ Linearization type (→  159) = Table ▪ Table mode (→  163) = Semiautomatic
Description	Displays measured level (value before linearization). This value is transmitted to the table.

Customer value

Navigation	 Setup → Advanced setup → Linearization → Customer value
Prerequisite	Linearization type (→  159) = Table
Description	Enter linearized value for the table point.
User entry	Signed floating-point number
Factory setting	0 %





Activate table

Navigation	  Setup → Advanced setup → Linearization → Activate table
Prerequisite	Linearization type (→  159) = Table
Description	Activate (enable) or deactivate (disable) the linearization table.
Selection	<ul style="list-style-type: none"> ▪ Disable ▪ Enable
Factory setting	Disable
Additional information	<p>Meaning of the options</p> <ul style="list-style-type: none"> ▪ Disable The measured level is not linearized. If Linearization type (→  159) = Table at the same time, the device issues error message F435. ▪ Enable The measured level is linearized according to the table. <p> When editing the table, the Activate table parameter is automatically reset to Disable and must be reset to Enable after the table has been entered.</p>





"Safety settings" submenu

Navigation  Setup → Advanced setup → Safety settings

Output echo lost 

Navigation	 Setup → Advanced setup → Safety settings → Output echo lost
Description	Output signal in case of a lost echo.
Selection	<ul style="list-style-type: none"> ■ Last valid value ■ Ramp at echo lost ■ Value echo lost ■ Alarm
Factory setting	Last valid value
Additional information	<p>Meaning of the options</p> <ul style="list-style-type: none"> ■ Last valid value The last valid value is kept in the case of a lost echo. ■ Ramp at echo lost⁷⁾ In the case of a lost echo the output value is continuously shifted towards 0% or 100%. The slope of the ramp is defined in the Ramp at echo lost parameter (→  167). ■ Value echo lost⁷⁾ In the case of a lost echo the output assumes the value defined in the Value echo lost parameter (→  166). ■ Alarm In the case of a lost echo the device generates an alarm; see the Failure mode parameter (→  176)

Value echo lost 

Navigation	 Setup → Advanced setup → Safety settings → Value echo lost
Prerequisite	Output echo lost (→  166) = Value echo lost
Description	Output value in case of a lost echo
User entry	0 to 200 000.0 %
Factory setting	0.0 %
Additional information	<p>Use the unit which has been defined for the measured value output:</p> <ul style="list-style-type: none"> ■ without linearization: Level unit (→  154) ■ with linearization: Unit after linearization (→  160)

7) Only visible if "Linearization type" (→  159) = "None"

Ramp at echo lost



Navigation Setup → Advanced setup → Safety settings → Ramp at echo lost

Prerequisite **Output echo lost (→ 166) = Ramp at echo lost**

Description Slope of the ramp in the case of a lost echo

User entry Signed floating-point number

Factory setting 0.0 %/min

Additional information

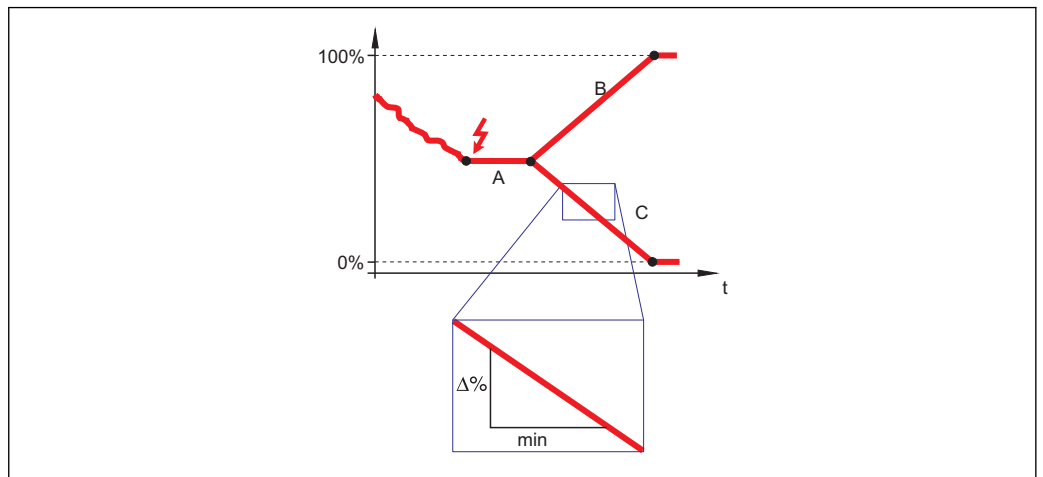

A0013269

- A Delay time echo lost
- B Ramp at echo lost (→ 167) (positive value)
- C Ramp at echo lost (→ 167) (negative value)

- The unit for the slope of the ramp is "percentage of the measuring range per minute" (%/min).
- For a negative slope of the ramp: The measured value is continuously decreased until it reaches 0%.
- For a positive slope of the ramp: The measured value is continuously increased until it reaches 100%.

Blocking distance



Navigation Setup → Advanced setup → Safety settings → Blocking distance

Description Specify upper blocking distance UB.

User entry 0 to 200 m

- Factory setting**
- For rod and rope probes up to 8 m (26 ft): 200 mm (8 in)
 - For rod and rope probes above 8 m (26 ft): 0.025 * Sondenlänge

Additional information Signals in the upper blocking distance are only evaluated if they have been outside the blocking distance when the device was switched on and move into the blocking distance

due to a level change during operation. Signals which are already in the blocking distance when the device is switched on, are ignored.

- i** This behavior is only valid if the following two conditions are met:
- Expert → Sensor → Echo tracking → Evaluation mode = **Short time history** or **Long time history**)
 - Expert → Sensor → Gas phase compensation → GPC mode= **On, Without correction** or **External correction**

If one of these conditions is not met, signals in the blocking distance will always be ignored.

- i** If required, a different behavior for signals in the blocking distance can be defined by the Endress+Hauser service.

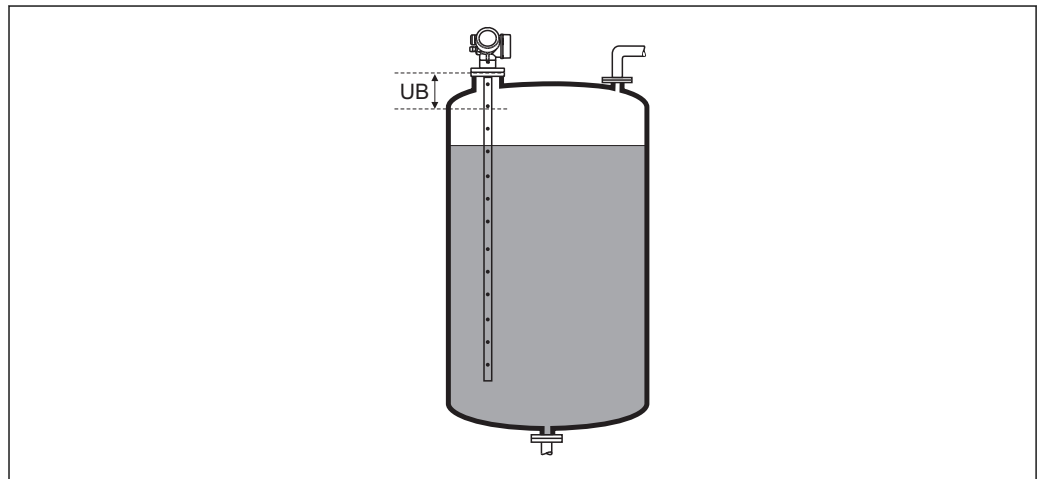

A0013219

52 Blocking distance (UB) for liquid measurements



"SIL/WHG confirmation" wizard

 The **SIL/WHG confirmation** wizard is only available for devices with SIL or WHG approval (Feature 590: "Additional Approval", option LA: "SIL" or LC: "WHG overflow prevention") which are currently **not** in the SIL- or WHG-locked state.

The **SIL/WHG confirmation** wizard is required to lock the device according to SIL or WHG. For details refer to the "Functional Safety Manual" of the respective device, which describes the locking procedure and the parameters of the sequence.

Navigation  Setup → Advanced setup → SIL/WHG confirmation

"Deactivate SIL/WHG" wizard

 The **Deactivate SIL/WHG** wizard (→  170) is only visible if the device is SIL-locked or WHG-locked. For details refer to the "Functional Safety Manual" of the respective device.

Navigation  Setup → Advanced setup → Deactivate SIL/WHG

Reset write protection







Navigation	 Setup → Advanced setup → Deactivate SIL/WHG → Reset write protection
Description	Enter unlocking code.
User entry	0 to 65 535
Factory setting	0



Code incorrect



Navigation	 Setup → Advanced setup → Deactivate SIL/WHG → Code incorrect
Description	Indicates that a wrong unlocking code has been entered. Select procedure.
Selection	<ul style="list-style-type: none"> ■ Reenter code ■ Abort sequence
Factory setting	Reenter code



"Probe settings" submenu

The **Probe settings** submenu helps to ensure that the end of probe signal within the envelope curve is correctly assigned by the evaluation algorithm. The assignment is correct if the length of probe indicated by the device matches the actual length of the probe. The automatic probe length correction can only be performed if the probe is installed in the vessel and is completely uncovered (no medium). For partially filled vessels and if the probe length is known, select **Confirm probe length** (→  172) = **Manual input** in order to enter the value manually.

-  If a mapping (interference echo suppression) has been recorded after shortening the probe, it is no longer possible to perform an automatic probe length correction. In this case there are two options:
 - Delete the map using the **Record map** parameter (→  146) before performing the automatic probe length correction. After the probe length correction, a new map can be recorded using the **Record map** parameter (→  146).
 - Alternative: Select **Confirm probe length** (→  172) = **Manual input** and enter the probe length manually into the **Present probe length** parameter →  171.
-  An automatic probe length correction is only possible after the correct option has been selected in the **Probe grounded** parameter (→  171).

Navigation   Setup → Advanced setup → Probe settings

Probe grounded	
<hr/>	
Navigation	  Setup → Advanced setup → Probe settings → Probe grounded
Prerequisite	Operating mode = Level
Description	Specify whether the probe is grounded.
Selection	<ul style="list-style-type: none"> ▪ No ▪ Yes
Factory setting	No

Present probe length	
<hr/>	
Navigation	 Setup → Advanced setup → Probe settings → Present probe length
Description	<ul style="list-style-type: none"> ▪ In most cases: Displays the length of the probe according to the currently measured end-of-probe signal. ▪ For Confirm probe length (→  172) = Manual input: Enter actual length of probe.
User entry	0 to 200 m
Factory setting	4 m

Confirm probe length
**Navigation**

Setup → Advanced setup → Probe settings → Confirm probe length

Description

Select, whether the value displayed in the **Present probe length** parameter → 171 matches the actual length of the probe. Based on this input, the device performs a probe length correction.

Selection

- Probe length OK
- Probe length too small
- Probe length too big
- Probe covered
- Manual input
- Probe length unknown

Factory setting



Probe length OK

Additional information**Meaning of the options**

- **Probe length OK**
To be selected if the indicated length is correct. An adjustment is not required. The device quits the sequence.
- **Probe length too small**
To be selected if the displayed length is smaller than the actual length of the probe. A different end of probe signal is allocated and the newly calculated length is displayed in the **Present probe length** parameter → 171. This procedure has to be repeated until the displayed value matches the actual length of the probe.
- **Probe length too big**
To be selected if the displayed length is bigger than the actual length of the probe. A different end of probe signal is allocated and the newly calculated length is indicated in the **Present probe length** parameter → 171. This procedure has to be repeated until the displayed value matches the actual length of the probe.
- **Probe covered**
To be selected if the probe is (partially or completely) covered. A probe length correction is impossible in this case. The device quits the sequence.
- **Manual input**
To be selected if no automatic probe length correction is to be performed. Instead, the actual length of the probe must be entered manually into the **Present probe length** parameter → 171 ⁸⁾.
- **Probe length unknown**
To be selected if the actual length of the probe is unknown. A probe length correction is impossible in this case and the device quits the sequence.

8) When operated via FieldCare, the **Manual input** option needs not to be selected explicitly. In FieldCare the length of the probe can always be edited.

"Probe length correction" wizard

 The **Probe length correction** wizard is only available when operating via the local display. When operating via an operating tool, all parameters concerning the probe length correction are located directly in the **Probe settings** submenu (→  171).

Navigation  Setup → Advanced setup → Probe settings → Probe length correction

Confirm probe length 

Navigation  Setup → Advanced setup → Probe settings → Probe length correction → Confirm probe length



Description →  172

Present probe length 

Navigation  Setup → Advanced setup → Probe settings → Probe length correction → Present probe length

Description →  171

"Current output 1 to 2" submenu

 The **Current output 2** submenu (→  174) is only available for devices with two current outputs.

Navigation  Setup → Advanced setup → Current output 1 to 2

Assign current output 1 to 2 

Navigation  Setup → Advanced setup → Current output 1 to 2 → Assign current output



Description Select process variable for current output.

- Selection**
- Level linearized
 - Distance
 - Electronic temperature
 - Relative echo amplitude
 - Analog output adv. diagnostics 1
 - Analog output adv. diagnostics 2

- Factory setting**
- For level measurements**
- Current output 1: Level linearized
 - Current output 2 ⁹⁾: Level linearized

Additional information *Definition of the current range for the process variables*

Process variable	4 mA value	20 mA value
Level linearized	0 % ¹⁾ or the associated linearized value	100 % ²⁾ or the associated linearized value
Distance	0 (i.e. level is at the reference point)	Empty calibration (→  142) (i.e. level is at 0 %)
Electronic temperature	-50 °C (-58 °F)	100 °C (212 °F)
Relative echo amplitude	0 mV	2 000 mV
Analog output adv. diagnostics 1/2	depending on the parametrization of the Advanced Diagnostics	

- 1) the 0% level is defined by **Empty calibration** parameter (→  142)
 2) The 100% level is defined by **Full calibration** parameter (→  142)

 It may be necessary to adjust the 4mA and 20mA values to the application (especially in the case of the **Analog output adv. diagnostics 1/2** option).

- This can be done by the following parameters:
- Expert → Output → Current output 1 to 2 → Turn down
 - Expert → Output → Current output 1 to 2 → 4 mA value
 - Expert → Output → Current output 1 to 2 → 20 mA value

9) only for devices with two current outputs

Current span



Navigation

Setup → Advanced setup → Current output 1 to 2 → Current span

Description

Determines the current range used to transmit the measured value. '4...20mA': Measured variable: 4 ...20 mA '4...20mA NAMUR': Measured variable: 3.8 ... 20.5 mA '4...20mA US': Measured variable: 3.9 ... 20.8 mA 'Fixed current': Measured variable transmitted via HART only Note: Currents below 3.6 mA or above 21.95 mA can be used to signal an alarm.

Selection

- 4...20 mA
- 4...20 mA NAMUR
- 4...20 mA US
- Fixed current

Factory setting

4...20 mA NAMUR

Additional information

Meaning of the options

Option	Current range for process variable	Lower alarm signal level	Upper alarm signal level
4...20 mA	4 to 20.5 mA	< 3.6 mA	> 21.95 mA
4...20 mA NAMUR	3.8 to 20.5 mA	< 3.6 mA	> 21.95 mA
4...20 mA US	3.9 to 20.8 mA	< 3.6 mA	> 21.95 mA
Fixed current	Constant current, defined in the Fixed current parameter (→ 175).		

- In the case of an error, the output current assumes the value defined in the **Failure mode** parameter (→ 176).
- If the measured value is out of the measuring range, diagnostic message **Current output** is issued.
- In a HART multidrop loop only one device can use the analog current to transmit a signal. For all other devices one must set:
 - **Current span = Fixed current**
 - **Fixed current (→ 175) = 4 mA**

Fixed current



Navigation

Setup → Advanced setup → Current output 1 to 2 → Fixed current

Prerequisite

Current span (→ 175) = Fixed current

Description

Define constant value of the output current.

User entry

4 to 22.5 mA

Factory setting

4 mA

Damping output

Navigation	Setup → Advanced setup → Current output 1 to 2 → Damping output
Description	Reaction time of the output signal on fluctuation in the measured value.
User entry	0.0 to 999.9 s
Factory setting	0.0 s
Additional information	Fluctuations of the measured value affect the output current with an exponential delay, the time constant τ of which is defined in this parameter. With a small time constant the output reacts immediately to changes of the measured value. With a big time constant the reaction of the output is more delayed. For $\tau = 0$ (factory setting) there is no damping.

Failure mode

Navigation	Setup → Advanced setup → Current output 1 to 2 → Failure mode
Prerequisite	Current span (→ 175) ≠ Fixed current
Description	Defines which current the output assumes in the case of an error. 'Min.': < 3.6mA 'Max.': > 21.95mA 'Last valid value': Last valid value before occurrence of the error. 'Actual value': Output current is equal to the measured value; error is ignored. 'Defined value': User defined value.
Selection	<ul style="list-style-type: none"> ▪ Min. ▪ Max. ▪ Last valid value ▪ Actual value ▪ Defined value
Factory setting	Max.
Additional information	<p>Meaning of the options</p> <ul style="list-style-type: none"> ▪ Min. The current output adopts the value of the lower alarm level according to the Current span parameter (→ 175). ▪ Max. The current output adopts the value of the upper alarm level according to the Current span parameter (→ 175). ▪ Last valid value The current remains constant at the last value it had before the error occurred. ▪ Actual value The output current follows the actual measured value; the error is ignored. ▪ Defined value The output current assumes the value defined in the Failure current parameter (→ 177). <p> The error behavior of other output channels is not influenced by these settings but is defined in separate parameters.</p>

Failure current





Navigation	Setup → Advanced setup → Current output 1 to 2 → Failure current
Prerequisite	Failure mode (→ 176) = Defined value
Description	Defines which current the output assumes in case of an error.
User entry	3.59 to 22.5 mA
Factory setting	22.5 mA

Output current 1 to 2

Navigation	Setup → Advanced setup → Current output 1 to 2 → Output current 1 to 2
Description	Shows the actual calculated value of the output current.

"Switch output" submenu

 The **Switch output** submenu (→  178) is only visible for devices with switch output.¹⁰⁾

Navigation  Setup → Advanced setup → Switch output

Switch output function**Navigation**

 Setup → Advanced setup → Switch output → Switch output function

Description

Defines the function of the switch output. 'Off' The switch output is always open (non-conductive) 'On' The switch output is always closed (conductive). 'Diagnostic behavior' The switch output is normally closed and is only opened if a diagnostic event is present. 'Limit' The switch output is normally closed and is only opened if a measured variable exceeds a defined limit. 'Digital output' The switch output is controlled by one of the digital output blocks of the device.





Selection

- Off
- On
- Diagnostic behavior
- Limit
- Digital Output

Factory setting

Off

Additional information**Meaning of the options**

- **Off**
The output is always open (non-conductive).
- **On**
The output is always closed (conductive).
- **Diagnostic behavior**
The output is normally closed and is only opened if a diagnostic event is present. The **Assign diagnostic behavior** parameter (→  179) determines for which type of event the output is opened.
- **Limit**
The output is normally closed and is only opened if a measured variable exceeds or falls below a defined limit. The limit values are defined by the following parameters:
 - **Assign limit** (→  179)
 - **Switch-on value** (→  180)
 - **Switch-off value** (→  181)
- **Digital Output**
The switching state of the output tracks the output value of a DI function block. The function block is selected in the **Assign status** parameter (→  179).

 The **Off** and **On** options can be used to simulate the switch output.

¹⁰⁾ Ordering feature 020 "Power supply; Output", option B, E or G

Assign status
**Navigation**

Setup → Advanced setup → Switch output → Assign status

Prerequisite**Switch output function (→ 178) = Digital Output****Selection**

- Off
- Digital output AD 1
- Digital output AD 2

Factory setting

Off

Additional information

The **Digital output AD 1** and **Digital output AD 2** options refer to the Advanced Diagnostic Blocks. A switch signal generated in these blocks can be transmitted via the switch output.

Assign limit
**Navigation**

Setup → Advanced setup → Switch output → Assign limit

Prerequisite**Switch output function (→ 178) = Limit****Selection**

- Off
- Level linearized
- Distance
- Interface linearized *
- Interface distance *
- Thickness upper layer *
- Terminal voltage
- Electronic temperature
- Measured capacitance *
- Relative echo amplitude
- Relative interface amplitude *
- Absolute echo amplitude
- Absolute interface amplitude *

Factory setting

Off

Assign diagnostic behavior
**Navigation**

Setup → Advanced setup → Switch output → Assign diagnostic behavior

Prerequisite**Switch output function (→ 178) = Diagnostic behavior****Description**

Defines to which behavior of diagnostic events the switch output reacts.

* Visibility depends on order options or device settings

Selection

- Alarm
- Alarm or warning
- Warning

Factory setting Alarm

Switch-on value 🔒

Navigation  Setup → Advanced setup → Switch output → Switch-on value

Prerequisite **Switch output function** (→  178) = **Limit**

Description Defines the switch-on point. The output is closed if the assigned process variable rises above this point.

User entry Signed floating-point number

Factory setting 0

Additional information The switching behavior depends on the relative position of the **Switch-on value** and **Switch-off value** parameters:

Switch-on value > Switch-off value

- The output is closed if the measured value is larger than **Switch-on value**.
- The output is opened if the measured value is smaller than **Switch-off value**.

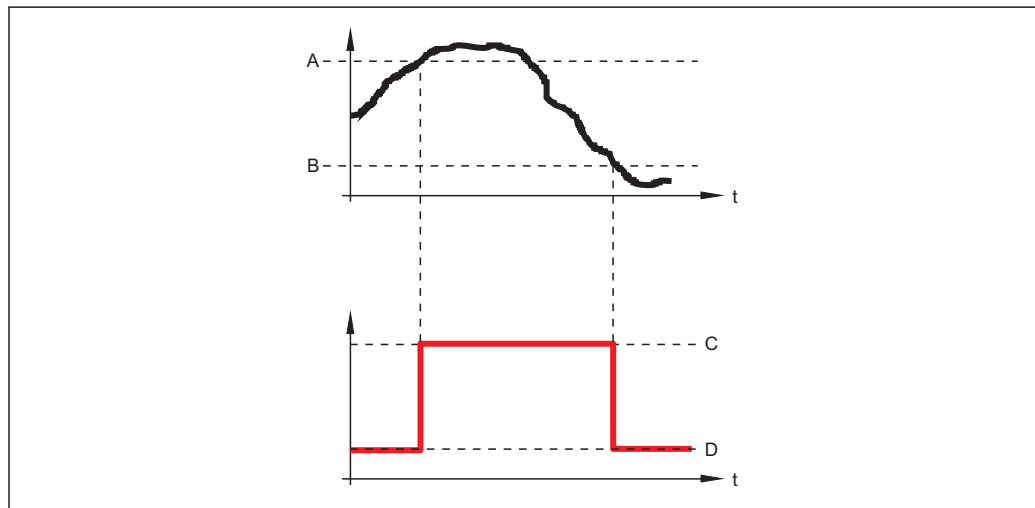

A0015585

- A *Switch-on value*
- B *Switch-off value*
- C *Output closed (conductive)*
- D *Output opened (non-conductive)*

Switch-on value < Switch-off value

- The output is closed if the measured value is smaller than **Switch-on value**.
- The output is opened if the measured value is larger than **Switch-off value**.

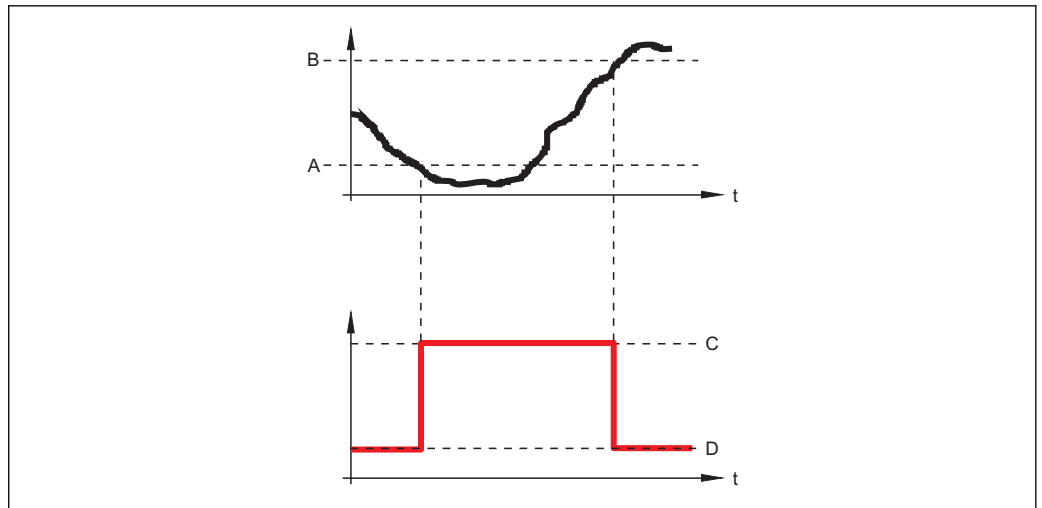

A0015586

- A Switch-on value
- B Switch-off value
- C Output closed (conductive)
- D Output opened (non-conductive)

Switch-on delay



Navigation Setup → Advanced setup → Switch output → Switch-on delay

Prerequisite **▪ Switch output function (→ 178) = Limit**
▪ Assign limit (→ 179) ≠ Off

Description Defines the delay applied before the output is switched on.

User entry 0.0 to 100.0 s

Factory setting 0.0 s

Switch-off value



Navigation Setup → Advanced setup → Switch output → Switch-off value

Prerequisite **Switch output function (→ 178) = Limit**

Description Defines the switch-off point. The output is opened if the assigned process variable falls below this point.

User entry Signed floating-point number

Factory setting 0

Additional information The switching behavior depends on the relative position of the **Switch-on value** and **Switch-off value** parameters; description: see the **Switch-on value** parameter (→ 180).

Switch-off delay



Navigation	Setup → Advanced setup → Switch output → Switch-off delay
Prerequisite	<ul style="list-style-type: none"> ▪ Switch output function (→ 178) = Limit ▪ Assign limit (→ 179) ≠ Off
Description	Defines the delay applied before the output is switched off.
User entry	0.0 to 100.0 s
Factory setting	0.0 s

Failure mode



Navigation	Setup → Advanced setup → Switch output → Failure mode
Prerequisite	Switch output function (→ 178) = Limit or Digital Output
Description	Defines the state of the switch output in case of an error.
Selection	<ul style="list-style-type: none"> ▪ Actual status ▪ Open ▪ Closed
Factory setting	Open

Additional information

Switch status

Navigation	Setup → Advanced setup → Switch output → Switch status
Description	Current status of the switch output.

Invert output signal



Navigation	Setup → Advanced setup → Switch output → Invert output signal
Description	'No' The switch output behaves as per its parameter setting. 'Yes' The switching behavior is inverted as compared to its parameter setting.
Selection	<ul style="list-style-type: none"> ▪ No ▪ Yes

Factory setting

No

Additional information**Meaning of the options**■ **No**

The behavior of the switch output is as described above.

■ **Yes**The states **Open** and **Closed** are inverted as compared to the description above.

"Display" submenu

 The **Display** submenu is only visible if a display module is connected to the device.

Navigation  Setup → Advanced setup → Display

Language**Navigation**

 Setup → Advanced setup → Display → Language

Description

Set display language.

Selection

- English
- Deutsch *
- Français *
- Español *
- Italiano *
- Nederlands *
- Portuguesa *
- Polski *
- русский язык (Russian) *
- Svenska *
- Türkçe *
- 中文 (Chinese) *
- 日本語 (Japanese) *
- 한국어 (Korean) *
- Bahasa Indonesia *
- tiếng Việt (Vietnamese) *
- čeština (Czech) *

Factory setting

The language selected in feature 500 of the product structure.
If no language has been selected: **English**

Additional information**Format display****Navigation**

 Setup → Advanced setup → Display → Format display

Description

Select how measured values are shown on the display.

Selection

- 1 value, max. size
- 1 bargraph + 1 value
- 2 values
- 1 value large + 2 values
- 4 values

Factory setting

1 value, max. size

* Visibility depends on order options or device settings

Additional information



A0019963

53 "Format display" = "1 value, max. size"

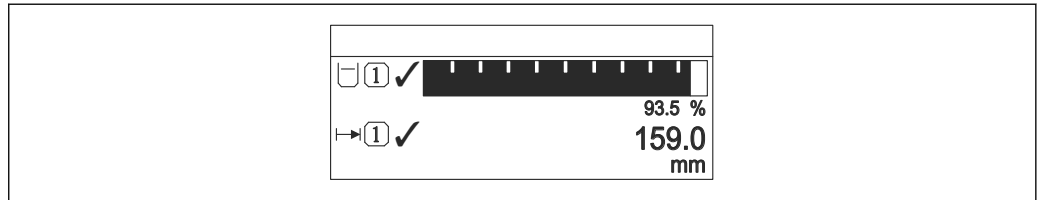

A0019964

54 "Format display" = "1 bargraph + 1 value"

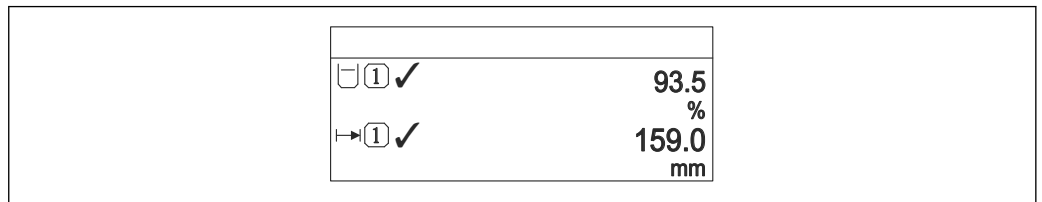

A0019965

55 "Format display" = "2 values"

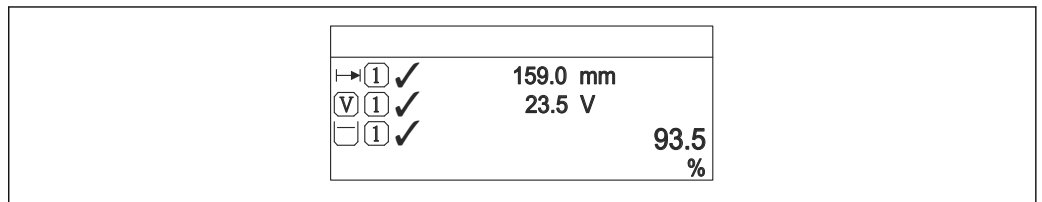

A0019966

56 "Format display" = "1 value large + 2 values"

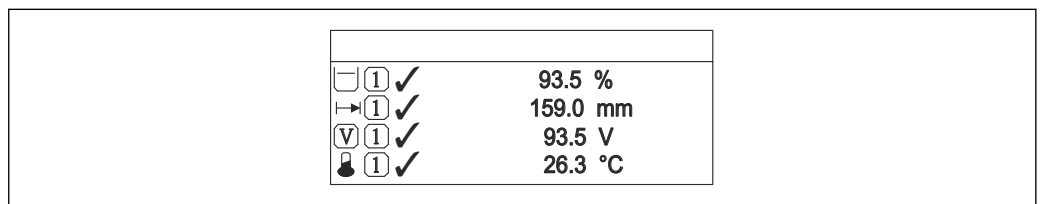

A0019968

57 "Format display" = "4 values"

- i
■
 The **Value 1 to 4 display** → 186 parameters specify which measured values are shown on the display and in which order.
- If more measured values are specified than the current display mode permits, the values alternate on the device display. The display time until the next change is configured in the **Display interval** parameter (→ 186).

Value 1 to 4 display

Navigation Setup → Advanced setup → Display → Value 1 display

Description Select the measured value that is shown on the local display.

Selection

- Level linearized
- Distance
- Interface linearized *
- Interface distance *
- Thickness upper layer *
- Current output 1
- Measured current
- Current output 2 *
- Terminal voltage
- Electronic temperature
- Measured capacitance *
- Analog output adv. diagnostics 1
- Analog output adv. diagnostics 2

Factory setting

For level measurements

- Value 1 display: Level linearized
- Value 2 display: Distance
- Value 3 display: Current output 1
- Value 4 display: None

Decimal places 1 to 4

Navigation Setup → Advanced setup → Display → Decimal places 1

Description This selection does not affect the measurement and calculation accuracy of the device.

Selection

- x
- x.x
- x.xx
- x.xxx
- x.xxxx

Factory setting x.xx

Additional information The setting does not affect the measuring or computational accuracy of the device.

Display interval

Navigation Setup → Advanced setup → Display → Display interval

Description Set time measured values are shown on display if display alternates between values.

* Visibility depends on order options or device settings

User entry	1 to 10 s
Factory setting	5 s
Additional information	This parameter is only relevant if the number of selected measuring values exceeds the number of values the selected display format can display simultaneously.

Display damping



Navigation	Setup → Advanced setup → Display → Display damping
Description	Set display reaction time to fluctuations in the measured value.
User entry	0.0 to 999.9 s
Factory setting	0.0 s

Header



Navigation	Setup → Advanced setup → Display → Header
Description	Select header contents on local display.
Selection	<ul style="list-style-type: none"> ■ Device tag ■ Free text
Factory setting	Device tag

Additional information

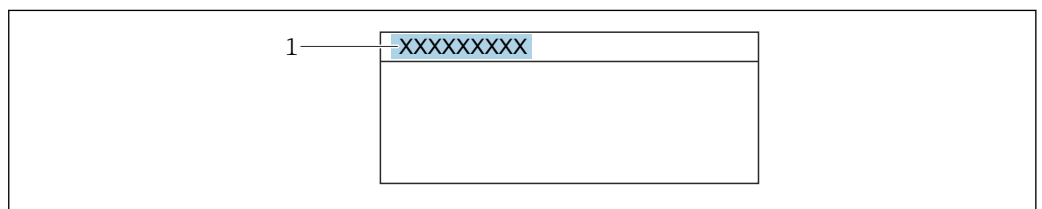



A0029422

1 Position of the header text on the display



Meaning of the options

- **Device tag**
Is defined in the **Device tag** parameter (→ 140)
- **Free text**
Is defined in the **Header text** parameter (→ 188)



Header text 

Navigation	  Setup → Advanced setup → Display → Header text
Prerequisite	Header (→  187) = Free text
Description	Enter display header text.
Factory setting	-----
Additional information	The number of characters which can be displayed depends on the characters used.



Separator 

Navigation	  Setup → Advanced setup → Display → Separator
Description	Select decimal separator for displaying numerical values.
Selection	<ul style="list-style-type: none"> ▪ . ▪ ,
Factory setting	.

Number format 



Navigation	  Setup → Advanced setup → Display → Number format
Description	Choose number format for the display.
Selection	<ul style="list-style-type: none"> ▪ Decimal ▪ ft-in-1/16"
Factory setting	Decimal
Additional information	The ft-in-1/16" option is only valid for distance units.

Decimal places menu 







Navigation	  Setup → Advanced setup → Display → Decimal places menu
Description	Select number of decimal places for the representation of numbers within the operating menu.

Selection	<ul style="list-style-type: none"> ■ X ■ X.X ■ X.XX ■ X.XXX ■ X.XXXX
Factory setting	x.xxxx
Additional information	<ul style="list-style-type: none"> ■ Is only valid for numbers in the operating menu (e.g. Empty calibration, Full calibration), but not for the measured value display. The number of decimal places for the measured value display is defined in the Decimal places 1 to 4 →  186 parameters. ■ The setting does not affect the accuracy of the measurement or the calculations.

Backlight

Navigation	  Setup → Advanced setup → Display → Backlight
Prerequisite	The device has the SD03 local display (with optical keys).
Description	Switch the local display backlight on and off.
Selection	<ul style="list-style-type: none"> ■ Disable ■ Enable
Factory setting	Disable
Additional information	<p>Meaning of the options</p> <ul style="list-style-type: none"> ■ Disable Switches the backlight off. ■ Enable Switches the backlight on. <p> Regardless of the setting in this parameter the backlight may be automatically switched off by the device if the supply voltage is too low.</p>

Contrast display

Navigation	  Setup → Advanced setup → Display → Contrast display
Description	Adjust local display contrast setting to ambient conditions (e.g. lighting or reading angle).
User entry	20 to 80 %
Factory setting	Dependent on the display.
Additional information	<p> Setting the contrast via push-buttons:</p> <ul style="list-style-type: none"> ■ Darker: press the   buttons simultaneously. ■ Brighter: press the   buttons simultaneously.

"Configuration backup display" submenu

 This submenu is only visible if a display module is connected to the device.

The configuration of the device can be saved to the display module at a certain point of time (backup). The saved configuration can be restored to the device if required, e.g. in order to bring the device back into a defined state. The configuration can also be transferred to a different device of the same type using the display module.

Navigation  Setup → Advanced setup → Configuration backup display

Operating time

Navigation  Setup → Advanced setup → Configuration backup display → Operating time

Description Indicates how long the device has been in operation.

Additional information *Maximum time*
9999 d (≈ 27 years)

Last backup

Navigation  Setup → Advanced setup → Configuration backup display → Last backup

Description Indicates when the last data backup was saved to the display module.

Configuration management



Navigation  Setup → Advanced setup → Configuration backup display → Configuration management



Description Select action for managing the device data in the display module.

- Selection**
- Cancel
 - Execute backup
 - Restore
 - Duplicate
 - Compare
 - Clear backup data

Factory setting Cancel



Additional information

Meaning of the options

- **Cancel**
No action is executed and the user exits the parameter.
 - **Execute backup**
A backup copy of the current device configuration in the HistoROM (built-in in the device) is saved to the display module of the device.
 - **Restore**
The last backup copy of the device configuration is copied from the display module to the HistoROM of the device.
 - **Duplicate**
The transmitter configuration is duplicated to another device using the transmitter display module. The following parameters, which characterize the individual measuring point are **not** included in the transmitted configuration:
 - HART date code
 - HART short tag
 - HART message
 - HART descriptor
 - HART address
 - Device tag
 - Medium type
 - **Compare**
The device configuration saved in the display module is compared to the current device configuration of the HistoROM. The result of this comparison is displayed in the **Comparison result** parameter (→  191).
 - **Clear backup data**
The backup copy of the device configuration is deleted from the display module of the device.
-  While this action is in progress, the configuration cannot be edited via the local display and a message on the processing status appears on the display.
-  If an existing backup is restored to a different device using the **Restore** option, it may occur that some device functionalities are no longer available. In some cases even a device reset will not restore the original status.
- In order to transmit a configuration to a different device, the **Duplicate** option should always be used.

Backup state

Navigation

  Setup → Advanced setup → Configuration backup display → Backup state

Description

Displays which backup action is currently in progress.

Comparison result

Navigation

  Setup → Advanced setup → Configuration backup display → Comparison result

Description

Comparison between present device data and display backup.

Additional information**Meaning of the display options****■ Settings identical**

The current device configuration of the HistoROM is identical to the backup copy in the display module.

■ Settings not identical

The current device configuration of the HistoROM is not identical to the backup copy in the display module.

■ No backup available

There is no backup copy of the device configuration of the HistoROM in the display module.

■ Backup settings corrupt

The current device configuration of the HistoROM is corrupt or not compatible with the backup copy in the display module.

■ Check not done

The device configuration of the HistoROM has not yet been compared to the backup copy in the display module.

■ Dataset incompatible

The data sets are incompatible and can not be compared.



To start the comparison, set **Configuration management** (→  190) = **Compare**.













If the transmitter configuration has been duplicated from a different device by **Configuration management** (→  190) = **Duplicate**, the new device configuration in the HistoROM is only partially identical to the configuration stored in the display module: Sensor specific properties (e.g. the mapping curve) are not duplicated. Thus, the result of the comparison will be **Settings not identical**.



"Administration" submenu

Navigation  Setup → Advanced setup → Administration

Define access code 

Navigation	 Setup → Advanced setup → Administration → Define access code
Description	Define release code for write access to parameters.
User entry	0 to 9999
Factory setting	0
Additional information	<p> If the factory setting is not changed or 0 is defined as the access code, the parameters are not write-protected and the configuration data of the device can then always be modified. The user is logged on in the <i>Maintenance</i> role.</p> <p> The write protection affects all parameters marked with the  symbol in this document. On the local display, the  symbol in front of a parameter indicates that the parameter is write-protected.</p> <p> Once the access code has been defined, write-protected parameters can only be modified if the access code is entered in the Enter access code parameter (→  150).</p> <p> Please contact your Endress+Hauser Sales Center if you lose your access code.</p> <p> For display operation: The new access code is only valid after it has been confirmed in the Confirm access code parameter (→  195).</p>

Device reset 

Navigation	  Setup → Advanced setup → Administration → Device reset
Description	Reset the device configuration - either entirely or in part - to a defined state.
Selection	<ul style="list-style-type: none"> ■ Cancel ■ To factory defaults ■ To delivery settings ■ Of customer settings ■ To transducer defaults ■ Restart device
Factory setting	Cancel

Additional information**Meaning of the options****■ Cancel**

No action

■ To factory defaults

All parameters are reset to the order-code specific factory setting.

■ To delivery settings

All parameters are reset to the delivery setting. The delivery setting may differ from the factory default if customer specific settings have been ordered.

This option is only visible if customer specific settings have been ordered.

■ Of customer settings

All customer parameters are reset to their factory setting. Service parameters, however, remain unchanged.

■ To transducer defaults

Every measurement-related parameter is reset to its factory setting. Service parameters and communication-related parameters, however, remain unchanged.

■ Restart device

The restart resets every parameter which is stored in the volatile memory (RAM) to the factory setting (e.g. measured value data). The device configuration remains unchanged.

"Define access code" wizard

 The **Define access code** wizard is only available when operating via the local display. When operating via an operating tool, the **Define access code** parameter is located directly in the **Administration** submenu. The **Confirm access code** parameter is not available for operation via operating tool.

Navigation  Setup → Advanced setup → Administration → Define access code

Define access code 

Navigation  Setup → Advanced setup → Administration → Define access code → Define access code

Description →  193

Confirm access code 

Navigation  Setup → Advanced setup → Administration → Define access code → Confirm access code

Description Confirm the entered access code.

User entry 0 to 9999

Factory setting 0

17.5 "Diagnostics" menu

Navigation  Diagnostics

Actual diagnostics



Navigation  Diagnostics → Actual diagnostics

Description Displays current diagnostic message.

Additional information The display consists of:

- Symbol for event behavior
- Code for diagnostic behavior
- Operating time of occurrence
- Event text

 If several messages are active at the same time, the messages with the highest priority is displayed.

 Information on what is causing the message, and remedy measures, can be viewed via the  symbol on the display.

Timestamp

Navigation  Diagnostics → Timestamp

Description Displays the timestamp for the currently active diagnostic message.



Previous diagnostics

Navigation  Diagnostics → Previous diagnostics

Description Displays the last diagnostic message which has been active before the current message.

Additional information The display consists of:

- Symbol for event behavior
- Code for diagnostic behavior
- Operating time of occurrence
- Event text

 The condition displayed may still apply. Information on what is causing the message, and remedy measures, can be viewed via the  symbol on the display.

Timestamp

Navigation  Diagnostics → Timestamp

Description Shows the timestamp of the previous diagnostic message.

Operating time from restart

Navigation   Diagnostics → Operating time from restart

Description Displays the time the device has been in operation since the last device restart.

Operating time

Navigation   Diagnostics → Operating time

Description Indicates how long the device has been in operation.

Additional information *Maximum time*
9999 d (≈ 27 years)

17.5.1 "Diagnostic list" submenu

Navigation  Diagnostics → Diagnostic list

Diagnostics 1 to 5

Navigation	 Diagnostics → Diagnostic list → Diagnostics 1
Description	Display the current diagnostics messages with the highest to fifth-highest priority.
Additional information	The display consists of: <ul style="list-style-type: none">■ Symbol for event behavior■ Code for diagnostic behavior■ Operating time of occurrence■ Event text

Timestamp 1 to 5



Navigation	 Diagnostics → Diagnostic list → Timestamp
Description	Timestamp of the diagnostic message.

17.5.2 "Event logbook" submenu

 The **Event logbook** submenu is only available when operating via the local display. When operating via FieldCare, the event list can be displayed in the FieldCare function "Event List / HistoROM".

Navigation  Diagnostics → Event logbook



Filter options



Navigation	 Diagnostics → Event logbook → Filter options
Description	Define which category of event messages is shown in the Events list submenu.
Selection	<ul style="list-style-type: none"> ▪ All ▪ Failure (F) ▪ Function check (C) ▪ Out of specification (S) ▪ Maintenance required (M) ▪ Information (I)
Factory setting	All
Additional information	 <ul style="list-style-type: none"> ▪ This parameter is only used for operation via the local display. ▪ The status signals are categorized according to NAMUR NE 107.

"Event list" submenu

The **Event list** submenu displays the history of past events of the category selected in the **Filter options** parameter (→  199). A maximum of 100 events are displayed in chronological order.

The following symbols indicate whether an event has occurred or has ended:

- : Event has occurred
- : Event has ended

 Information on what is causing the message, and remedy instructions, can be viewed via the -button.

Display format

- For event messages in category I: information event, event text, "recording event" symbol and time the event occurred
- For event messages in category F, M, C, S (status signal): diagnostics event, event text, "recording event" symbol and time the event occurred

Navigation  Diagnostics → Event logbook → Event list

17.5.3 "Device information" submenu

Navigation  Diagnostics → Device information

Device tag

Navigation  Diagnostics → Device information → Device tag

Description Enter the name for the measuring point.

Factory setting FMP5x

Serial number

Navigation  Diagnostics → Device information → Serial number

Description Shows the serial number of the measuring device.

Additional information  **Uses of the serial number**

- To identify the device quickly, e.g. when contacting Endress+Hauser.
- To obtain specific information on the device using the Device Viewer:
www.endress.com/deviceviewer

 The serial number is also indicated on the nameplate.

Firmware version

Navigation  Diagnostics → Device information → Firmware version

Description Shows the device firmware version installed.











User interface xx.yy.zz

Additional information  For firmware versions differing only in the last two digits ("zz") there is no difference concerning functionality or operation.



Device name

Navigation  Diagnostics → Device information → Device name



Description Shows the name of the transmitter.

Order code		
Navigation	  Diagnostics → Device information → Order code	
Description	Shows the device order code.	
Additional information	The order code is generated from the extended order code, which defines all device features of the product structure. In contrast, the device features can not be read directly from the order code.	
Extended order code 1 to 3		
Navigation	  Diagnostics → Device information → Extended order code 1	
Description	Display the three parts of the extended order code.	
Additional information	The extended order code indicates the version of all the features of the product structure and thus uniquely identifies the device.	
Device revision		
Navigation	  Diagnostics → Device information → Device revision	
Description	Shows the device revision with which the device is registered with the HART Communication Foundation.	
Additional information	The device revision is used to allocate the correct Device Description file (DD) to the device.	
Device ID		
Navigation	  Diagnostics → Device information → Device ID	
Description	Shows the device ID for identifying the device in a HART network.	
Additional information	In addition to the Device type and Manufacturer ID, the Device ID is part of the unique device identification (Unique ID) which characterizes each HART device unambiguously.	

Device type

Navigation	  Diagnostics → Device information → Device type
Description	Shows the device type with which the measuring device is registered with the HART Communication Foundation.
Additional information	The device type is needed to allocate the suitable Device Description (DD) to the device.

Manufacturer ID

Navigation	  Diagnostics → Device information → Manufacturer ID
Description	Use this function to view the manufacturer ID with which the measuring device is registered with the HART Communication Foundation.
User interface	2-digit hexadecimal number
Factory setting	0x11 (for Endress+Hauser)

17.5.4 "Measured values" submenu

Navigation  Diagnostics → Measured values

Distance

Navigation  Diagnostics → Measured values → Distance

Description Displays the measured distance D_L between the reference point (lower edge of the flange or threaded connection) and the level.

Additional information

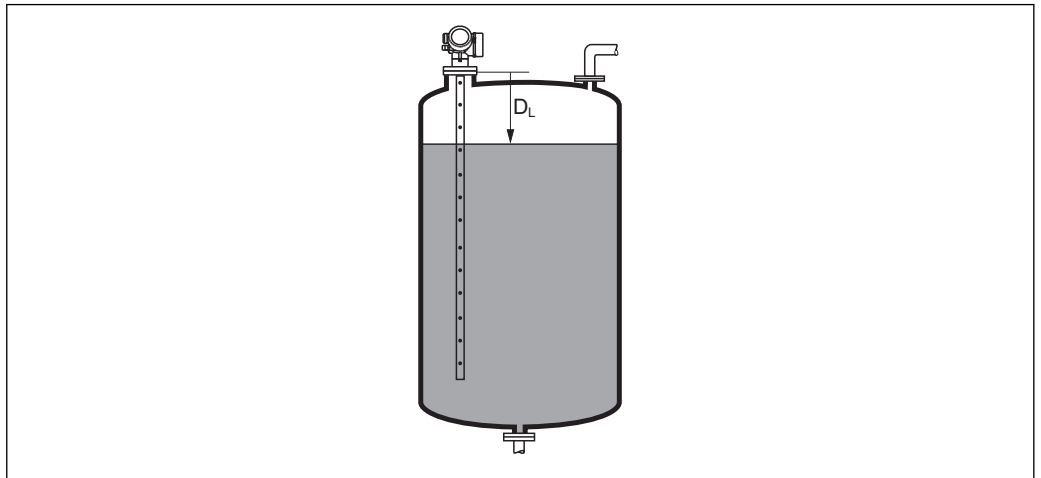

A0013198



 58 Distance for liquid measurements

 The unit is defined in the **Distance unit** parameter (→  140).

Level linearized

Navigation  Diagnostics → Measured values → Level linearized

Description Displays linearized level.

Additional information  The unit is defined by the **Unit after linearization** parameter →  160.

Output current 1 to 2

Navigation  Diagnostics → Measured values → Output current 1 to 2

Description Shows the actual calculated value of the output current.

Measured current 1

Navigation	 Diagnostics → Measured values → Measured current 1
Prerequisite	Only available for current output 1
Description	Shows the current value of the current output which is currently measured.

Terminal voltage 1

Navigation	 Diagnostics → Measured values → Terminal voltage 1
Description	Shows the current terminal voltage that is applied at the output.

17.5.5 "Data logging" submenu

Navigation  Diagnostics → Data logging

Assign channel 1 to 4

Navigation  Diagnostics → Data logging → Assign channel 1 to 4

Description Assign a process variable to logging channel.

Selection

- Off
- Level linearized
- Distance
- Unfiltered distance
- Interface linearized *
- Interface distance *
- Unfiltered interface distance
- Thickness upper layer *
- Current output 1
- Measured current
- Current output 2 *
- Terminal voltage
- Electronic temperature
- Measured capacitance *
- Absolute echo amplitude
- Relative echo amplitude
- Absolute interface amplitude *
- Relative interface amplitude *
- Absolute EOP amplitude
- EOP shift
- Noise of signal
- Calculated DC value *
- Analog output adv. diagnostics 1
- Analog output adv. diagnostics 2

Factory setting Off

Additional information A total of 1000 measured values can be logged. This means:

- 1000 data points if 1 logging channel is used
- 500 data points if 2 logging channels are used
- 333 data points if 3 logging channels are used
- 250 data points if 4 logging channels are used

If the maximum number of data points is reached, the oldest data points in the data log are cyclically overwritten in such a way that the last 1000, 500, 333 or 250 measured values are always in the log (ring memory principle).

 The logged data are deleted if a new option is selected in this parameter.

* Visibility depends on order options or device settings

Logging interval

Navigation	Diagnostics → Data logging → Logging interval Diagnostics → Data logging → Logging interval
Description	Define the logging interval t_{log} for data logging. This value defines the time interval between the individual data points in the memory.
User entry	1.0 to 3 600.0 s
Factory setting	30.0 s
Additional information	<p>This parameter defines the interval between the individual data points in the data log, and thus the maximum loggable process time T_{log} :</p> <ul style="list-style-type: none"> ▪ If 1 logging channel is used: $T_{log} = 1000 \cdot t_{log}$ ▪ If 2 logging channels are used: $T_{log} = 500 \cdot t_{log}$ ▪ If 3 logging channels are used: $T_{log} = 333 \cdot t_{log}$ ▪ If 4 logging channels are used: $T_{log} = 250 \cdot t_{log}$ <p>Once this time elapses, the oldest data points in the data log are cyclically overwritten such that a time of T_{log} always remains in the memory (ring memory principle).</p> <p> The logged data are deleted if this parameter is changed.</p> <p><i>Example</i></p> <p>When using 1 logging channel</p> <ul style="list-style-type: none"> ▪ $T_{log} = 1000 \cdot 1 \text{ s} = 1000 \text{ s} \approx 16.5 \text{ min}$ ▪ $T_{log} = 1000 \cdot 10 \text{ s} = 1000 \text{ s} \approx 2.75 \text{ h}$ ▪ $T_{log} = 1000 \cdot 80 \text{ s} = 80\,000 \text{ s} \approx 22 \text{ h}$ ▪ $T_{log} = 1000 \cdot 3\,600 \text{ s} = 3\,600\,000 \text{ s} \approx 41 \text{ d}$

Clear logging data

Navigation	Diagnostics → Data logging → Clear logging data Diagnostics → Data logging → Clear logging data
Description	Clear the entire logging data.
Selection	<ul style="list-style-type: none"> ▪ Cancel ▪ Clear data
Factory setting	Cancel

"Display channel 1 to 4" submenu

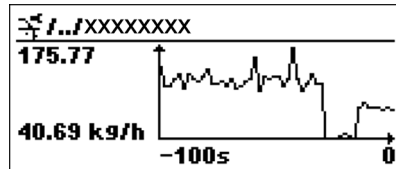

i The **Display channel 1 to 4** submenus are only available for operation via the local display. When operating via FieldCare, the logging diagram can be displayed in the FieldCare function "Event List / HistoROM" .

The **Display channel 1 to 4** submenus invoke a diagram of the logging history of the respective channel.



- x-axis: depending on the number of selected channels, 250 to 1000 measured values of a process variable are displayed.
- y-axis: covers the approximate measured value span and constantly adapts this to the measurement.







i To return to the operating menu, press \oplus and \ominus simultaneously.

Navigation   Diagnostics → Data logging → Display channel 1 to 4

17.5.6 "Simulation" submenu







The **Simulation** submenu is used to simulate specific measuring values or other conditions. This helps to check the correct configuration of the device and connected control units.

Conditions which can be simulated

Condition to be simulated	Associated parameters
Specific value of a process variable	<ul style="list-style-type: none"> ▪ Assign measurement variable (→  210) ▪ Process variable value (→  210)
Specific value of the output current	<ul style="list-style-type: none"> ▪ Current output simulation (→  210) ▪ Value current output (→  211)
Specific state of the switch output	<ul style="list-style-type: none"> ▪ Switch output simulation (→  211) ▪ Switch status (→  211)
Existence of an alarm	Device alarm simulation (→  212)

Structure of the submenu



Navigation  Expert → Diagnostics → Simulation

► Simulation		
Assign measurement variable	→	 210
Process variable value	→	 210
Current output 1 to 2 simulation	→	 210
Value current output 1 to 2	→	 211
Switch output simulation	→	 211
Switch status	→	 211
Device alarm simulation	→	 212



Description of parameters

Navigation  Expert → Diagnostics → Simulation

Assign measurement variable

Navigation	 Expert → Diagnostics → Simulation → Assign measurement variable
Selection	<ul style="list-style-type: none"> ■ Off ■ Level ■ Interface * ■ Thickness upper layer * ■ Level linearized ■ Interface linearized ■ Thickness linearized
Factory setting	Off
Additional information	<ul style="list-style-type: none"> ■ The value of the variable to be simulated is defined in the Process variable value parameter (→  210). ■ If Assign measurement variable ≠ Off, a simulation is active. This is indicated by a diagnostic message of the <i>Function check (C)</i> category.

Process variable value

Navigation	 Expert → Diagnostics → Simulation → Process variable value
Prerequisite	Assign measurement variable (→  210) ≠ Off
User entry	Signed floating-point number
Factory setting	0
Additional information	Downstream measured value processing and the signal output use this simulation value. In this way, users can verify whether the measuring device has been configured correctly.



Current output 1 to 2 simulation

Navigation	 Expert → Diagnostics → Simulation → Current output 1 to 2 simulation
Description	Switch the simulation of the current output on and off.
Selection	<ul style="list-style-type: none"> ■ Off ■ On



* Visibility depends on order options or device settings

Factory setting	Off
Additional information	An active simulation is indicated by a diagnostic message of the <i>Function check (C)</i> category.



Value current output 1 to 2

Navigation	  Expert → Diagnostics → Simulation → Value current output 1 to 2
Prerequisite	Current output simulation (→  210) = On
Description	Defines the value of the simulated output current.
User entry	3.59 to 22.5 mA
Factory setting	3.59 mA
Additional information	The current output assumes the value specified in this parameter. In this way, users can verify the correct adjustment of the current output and the correct function of connected control units.

Switch output simulation



Navigation	  Expert → Diagnostics → Simulation → Switch output simulation
Description	Switch the simulation of the switch output on and off.
Selection	<ul style="list-style-type: none"> ■ Off ■ On
Factory setting	Off

Switch status

Navigation	  Expert → Diagnostics → Simulation → Switch status
Prerequisite	Switch output simulation (→  211) = On
Description	Current status of the switch output.
Selection	<ul style="list-style-type: none"> ■ Open ■ Closed
Factory setting	Open

Additional information The switch status assumes the value defined in this parameter. This helps to check correct operation of connected control units.

Device alarm simulation

Navigation   Expert → Diagnostics → Simulation → Device alarm simulation

Description Switch the device alarm on and off.



Selection

- Off
- On

Factory setting Off

Additional information When selecting the **On** option, the device generates an alarm. This helps to check the correct output behavior of the device in the case of an alarm.
An active simulation is indicated by the diagnostic message  **C484 Failure mode simulation**.

Diagnostic event simulation

Navigation   Expert → Diagnostics → Simulation → Diagnostic event simulation

Description Select the diagnostic event to be simulated. Note: To terminate the simulation, select 'Off'.



Factory setting Off

Additional information When operated via the local display, the selection list can be filtered according to the event categories (**Diagnostic event category** parameter).



17.5.7 "Device check" submenu

Navigation   Diagnostics → Device check



Start device check

Navigation	  Diagnostics → Device check → Start device check
Description	Start a device check.
Selection	<ul style="list-style-type: none"> ■ No ■ Yes
Factory setting	No
Additional information	In the case of a lost echo a device check can not be performed.



Result device check

Navigation	  Diagnostics → Device check → Result device check
Description	Displays the result of the device check.
Additional information	<p>Meaning of the display options</p> <ul style="list-style-type: none"> ■ Installation ok Measurement possible without restrictions. ■ Accuracy reduced A measurement is possible. However, the measuring accuracy may be reduced due to the signal amplitudes. ■ Measurement capability reduced A measurement is currently possible. However, there is the risk of an echo loss. Check the mounting position of the device and the dielectric constant of the medium. ■ Check not done No device check has been performed.



Last check time

Navigation	  Diagnostics → Device check → Last check time
Description	Displays the operating time at which the last device check has been performed.

Level signal

Navigation	  Diagnostics → Device check → Level signal
Prerequisite	Device check has been performed.
Description	Displays result of the device check for the level signal.
User interface	<ul style="list-style-type: none">▪ Check not done▪ Check not OK▪ Check OK
Additional information	For Level signal = Check not OK : Check the mounting position of the device and the dielectric constant of the medium.

Launch signal

Navigation	  Diagnostics → Device check → Launch signal
Prerequisite	Device check has been performed.
Description	Displays result of the display check for the launch signal.
User interface	<ul style="list-style-type: none">▪ Check not done▪ Check not OK▪ Check OK
Additional information	For Launch signal = Check not OK : Check the mounting position of the device. In non-metallic vessels use a metal plate or a metal flange.

17.5.8 "Heartbeat" submenu

 The **Heartbeat** submenu is only available via **FieldCare** or **DeviceCare**. It contains the wizards which are part of the **Heartbeat Verification** and **Heartbeat Monitoring** application packages.

Detailed description

SD01872F

Navigation  Diagnostics → Heartbeat

Index

A

Access authorization to parameters	
Read access	68
Write access	68
Access code	68
Incorrect input	68
Access status display (Parameter)	150
Access status tooling (Parameter)	149
Accessories	
Communication specific	118
Device specific	111
Service specific	119
Activate table (Parameter)	165
Actual diagnostics (Parameter)	196
Administration (Submenu)	193
Advanced process conditions (Parameter)	153
Advanced setup (Submenu)	149
Application	11
Residual risk	11
Assign channel 1 to 4 (Parameter)	205
Assign current output (Parameter)	174
Assign diagnostic behavior (Parameter)	179
Assign limit (Parameter)	179
Assign measurement variable (Parameter)	210
Assign status (Parameter)	179

B

Backlight (Parameter)	189
Backup state (Parameter)	191
Blocking distance (Parameter)	154, 167
Bluetooth® wireless technology	64
Bypass	31

C

CE mark	12
Cleaning	108
Clear logging data (Parameter)	206
Code incorrect (Parameter)	170
Comparison result (Parameter)	191
Configuration backup display (Submenu)	190
Configuration management (Parameter)	190
Configuration of a level measurement	88
Confirm access code (Parameter)	195
Confirm distance (Parameter)	145, 148
Confirm probe length (Parameter)	172, 173
Context menu	79
Contrast display (Parameter)	189
Current output 1 to 2 (Submenu)	174
Current output 1 to 2 simulation (Parameter)	210
Current span (Parameter)	175
Customer value (Parameter)	165

D

Damping output (Parameter)	176
Data logging (Submenu)	205
DD	81

Deactivate SIL/WHG (Wizard)	170
Decimal places 1 (Parameter)	186
Decimal places menu (Parameter)	188
Declaration of Conformity	12
Define access code	68
Define access code (Parameter)	193, 195
Define access code (Wizard)	195
Designated use	11
Device alarm simulation (Parameter)	212
Device check (Submenu)	213
Device Descriptions	81
Device ID (Parameter)	201
Device information (Submenu)	200
Device name (Parameter)	200
Device replacement	109
Device reset (Parameter)	193
Device revision (Parameter)	201
Device tag (Parameter)	140, 200
Device type (Parameter)	202
Diagnostic event	
In the operating tool	101
Diagnostic event simulation (Parameter)	212
Diagnostic events	98
Diagnostic list	102
Diagnostic list (Submenu)	198
Diagnostic message	98
Diagnostics	
Symbols	98
Diagnostics (Menu)	196
Diagnostics 1 (Parameter)	198
Diagnostics event	99
Diameter (Parameter)	162
DIP switch	
see Write protection switch	
Display (Submenu)	184
Display and operating module FHX50	63
Display channel 1 to 4 (Submenu)	207
Display damping (Parameter)	187
Display interval (Parameter)	186
Display module	73
Display symbols for submenus	74
Display symbols for the locking state	74
Disposal	110
Distance (Parameter)	143, 148, 203
Distance unit (Parameter)	140
Document	
Function	5
Document function	5

E

Electronics housing	
Design	17
Empty calibration (Parameter)	142
Enter access code (Parameter)	150
Envelope curve display	80
Event history	105

Event level
 Explanation 98
 Symbols 98
 Event list (Submenu) 199
 Event logbook (Submenu) 199
 Event text 99
 Events list 105
 Extended order code 1 (Parameter) 201
 Exterior cleaning 108
 External mounting 36

F
 Failure current (Parameter) 177
 Failure mode (Parameter) 176, 182
 FHX50 63
 Filter options (Parameter) 199
 Filtering the event logbook 105
 Firmware version (Parameter) 200
 Fixed current (Parameter) 175
 Format display (Parameter) 184
 Free text (Parameter) 161
 Full calibration (Parameter) 142
 FV (HART device variable) 81

H
 Hardware write protection 69
 HART device variables 81
 HART protocol 65
 HART-Integration 81
 Header (Parameter) 187
 Header text (Parameter) 188
 Heartbeat (Submenu) 215
 Heat insulation 38
 Housing
 Design 17
 Turning 43

I
 Input mask 77
 Intermediate height (Parameter) 162
 Invert output signal (Parameter) 182

K
 Keypad lock
 Disabling 72
 Switching on 72

L
 Language (Parameter) 184
 Last backup (Parameter) 190
 Last check time (Parameter) 213
 Launch signal (Parameter) 214
 Level (Parameter) 143, 164, 165
 Level (Submenu) 151
 Level correction (Parameter) 155
 Level linearized (Parameter) 161, 203
 Level measurement configuration 88
 Level signal (Parameter) 214
 Level unit (Parameter) 154
 Linearization (Submenu) 157, 158, 159

Linearization type (Parameter) 159
 Local display 62
 see Diagnostics message
 see In alarm condition
 Locking status (Parameter) 149
 Logging interval (Parameter) 206

M
 Maintenance 108
 Manage device configuration 93
 Manufacturer ID (Parameter) 202
 Mapping (Wizard) 148
 Mapping end point (Parameter) 146, 148
 Maximum value (Parameter) 162
 Measured current 1 (Parameter) 204
 Measured materials 11
 Measured value symbols 75
 Measured values (Submenu) 203
 Medium group (Parameter) 141
 Medium property (Parameter) 151
 Medium type (Parameter) 151
 Menu
 Diagnostics 196
 Setup 140
 Mounting position for level measurements 21

N
 Non-metallic vessels 35
 Number format (Parameter) 188

O
 Operating elements
 Diagnostics message 99
 Operating module 73
 Operating time (Parameter) 190, 197
 Operating time from restart (Parameter) 197
 Operational safety 12
 Order code (Parameter) 201
 Output current 1 to 2 (Parameter) 177, 203
 Output echo lost (Parameter) 166
 Overvoltage protection
 General information 58

P
 Present mapping (Parameter) 146
 Present probe length (Parameter) 171, 173
 Previous diagnostics (Parameter) 196
 Probe grounded (Parameter) 171
 Probe length correction (Wizard) 173
 Probe settings (Submenu) 171
 Process property (Parameter) 152
 Process variable value (Parameter) 210
 Product safety 12
 PV (HART device variable) 81

R
 Ramp at echo lost (Parameter) 167
 Read access 68
 Record map (Parameter) 146, 148
 Registered trademarks 10

- Remedial measures
 - Calling up 100
 - Closing 100
- Remote operation 65
- Repair concept 109
- Replacing a device 109
- Requirements for personnel 11
- Reset write protection (Parameter) 170
- Result device check (Parameter) 213
- Return 110
- Rod probe
 - Design 16
- Rod probes
 - Bending strength 24
 - Shortening 39
- Rope probe
 - Design 16
- Rope probes
 - Shortening 39
 - Tensile load 24
- S**
- Safety instructions
 - Basic 11
- Safety Instructions (XA) 13
- Safety settings (Submenu) 166
- Securing rod probes 30
- Securing rope probes 29
- Seilsonden
 - Montage 41
- Separator (Parameter) 188
- Serial number (Parameter) 200
- Service interface (CDI) 65
- Setting the operating language 87
- Settings
 - Manage device configuration 93
 - Operating language 87
- Setup (Menu) 140
- Signal quality (Parameter) 144
- SIL/WHG confirmation (Wizard) 169
- Simulation (Submenu) 209, 210
- Spare parts 110
 - Nameplate 110
- Start device check (Parameter) 213
- Status signals 74, 98
- Stilling well 31
- Störungsbehebung 95
- Submenu
 - Administration 193
 - Advanced setup 149
 - Configuration backup display 190
 - Current output 1 to 2 174
 - Data logging 205
 - Device check 213
 - Device information 200
 - Diagnostic list 198
 - Display 184
 - Display channel 1 to 4 207
 - Event list 199
 - Event logbook 199
 - Events list 105
 - Heartbeat 215
 - Level 151
 - Linearization 157, 158, 159
 - Measured values 203
 - Probe settings 171
 - Safety settings 166
 - Simulation 209, 210
 - Switch output 178
 - SV (HART device variable) 81
 - Switch output (Submenu) 178
 - Switch output function (Parameter) 178
 - Switch output simulation (Parameter) 211
 - Switch status (Parameter) 182, 211
 - Switch-off delay (Parameter) 182
 - Switch-off value (Parameter) 181
 - Switch-on delay (Parameter) 181
 - Switch-on value (Parameter) 180
 - Symbols
 - For correction 77
 - In the text and numeric editor 77
 - System components 120
 - T**
 - Table mode (Parameter) 163
 - Table number (Parameter) 164
 - Tank type (Parameter) 140
 - Terminal voltage 1 (Parameter) 204
 - Threaded connection 40
 - Timestamp (Parameter) 196, 197, 198
 - Tools 39
 - Transmitter
 - Turning the display 44
 - Turning the display module 44
 - Transmitter housing
 - Turning 43
 - Tube diameter (Parameter) 141
 - Turning the display 44
 - Turning the display module 44
 - TV (HART device variable) 81
 - U**
 - Underground tanks 33
 - Unit after linearization (Parameter) 160
 - V**
 - Value 1 display (Parameter) 186
 - Value current output 1 to 2 (Parameter) 211
 - Value echo lost (Parameter) 166
 - W**
 - W@M Device Viewer 110
 - Wizard
 - Deactivate SIL/WHG 170
 - Define access code 195
 - Mapping 148
 - Probe length correction 173
 - SIL/WHG confirmation 169
 - Workplace safety 12

Write access	68
Write protection	
Via access code	68
Via write protection switch	69
Write protection switch	69



www.addresses.endress.com
