

# Operating Instructions

## CNGmass DCI

### HART

Coriolis flowmeter

For fueling with compressed natural gas (CNG)

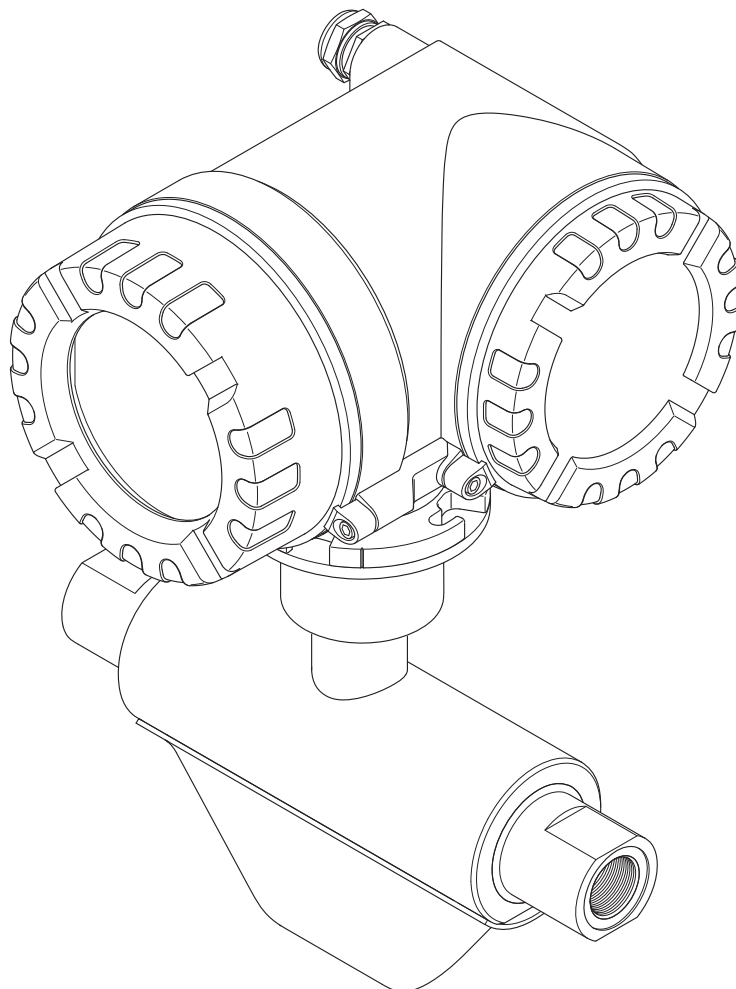



## Table of contents

<b>1</b>	<b>Safety instructions</b> .....	<b>4</b>	<b>9</b>	<b>Maintenance</b> .....	<b>59</b>
1.1	Designated use .....	4	9.1	External cleaning .....	59
1.2	Installation, commissioning and operation .....	4	<b>10</b>	<b>Accessories</b> .....	<b>60</b>
1.3	Operational safety .....	4	10.1	Device-specific accessories .....	60
1.4	Return .....	5	10.2	Communication-specific accessories .....	60
1.5	Notes on safety conventions and icons .....	5	10.3	Service-specific accessories .....	60
1.6	Symbols on nameplates .....	5	10.4	System components .....	61
<b>2</b>	<b>Identification</b> .....	<b>6</b>	<b>11</b>	<b>Troubleshooting</b> .....	<b>62</b>
2.1	Device designation .....	6	11.1	Troubleshooting instructions .....	62
2.2	Certificates and approvals .....	9	11.2	System error messages .....	63
2.3	Registered trademarks .....	9	11.3	Process error messages .....	67
<b>3</b>	<b>Incoming acceptance, transport and storage</b> .....	<b>10</b>	11.4	Process errors without messages .....	68
3.1	Incoming acceptance .....	10	11.5	Response of outputs to errors .....	69
3.2	Transport .....	10	11.6	Spare parts .....	70
3.3	Storage .....	10	11.7	Return .....	76
<b>4</b>	<b>Installation</b> .....	<b>11</b>	11.8	Disposal .....	76
4.1	Installation conditions .....	11	11.9	Software history .....	76
4.2	Installation instructions .....	12	<b>12</b>	<b>Technical data</b> .....	<b>77</b>
4.3	Post-installation check .....	15	12.1	Applications .....	77
<b>5</b>	<b>Wiring</b> .....	<b>16</b>	12.2	Function and system design .....	77
5.1	Shielding and grounding .....	16	12.3	Input .....	77
5.2	Connecting the remote version .....	17	12.4	Output .....	78
5.3	Connecting the measuring unit .....	18	12.5	Power supply .....	78
5.4	Degree of protection .....	21	12.6	Performance characteristics .....	79
5.5	Post-connection check .....	22	12.7	Installation .....	79
<b>6</b>	<b>Operation</b> .....	<b>23</b>	12.8	Environment .....	80
6.1	Display and operating elements .....	23	12.9	Process .....	80
6.2	Brief guide to the function matrix .....	26	12.10	Mechanical construction .....	81
6.3	Error messages .....	28	12.11	Operability .....	81
6.4	Communication .....	29	12.12	Certificates and approvals .....	82
<b>7</b>	<b>Commissioning</b> .....	<b>40</b>	12.13	Accessories/spare parts .....	83
7.1	Function check .....	40	12.14	Documentation .....	83
7.2	Switching on the measuring device .....	40	<b>Index</b> .....	<b>84</b>	
7.3	Quick Setup .....	41			
7.4	Configuration .....	49			
7.5	Adjustment .....	52			
7.6	Memory (HistoROM) .....	53			
<b>8</b>	<b>Custody transfer measurement</b> .....	<b>54</b>			
8.1	Suitability for custody transfer measurement, approval by the Standards Authorities, repeated calibration due to legal metrology controls .....	54			
8.2	Definition of terms .....	55			
8.3	Verification process .....	56			

# 1 Safety instructions

## 1.1 Designated use

The measuring device described in these operating instructions may be used for measuring the mass or volume flow measurement of Compressed Natural Gas (CNG).

Resulting from incorrect use or from use other than that designated the operational safety of the measuring devices can be suspended. The manufacturer accepts no liability for damages being produced from this.



## 1.2 Installation, commissioning and operation

Note the following points:

- Installation, connection to the electricity supply, commissioning and maintenance of the measuring device must be carried out by trained, qualified specialists authorized to perform such work by the facility's owner-operator. The specialist must have read and understood these Operating Instructions and must follow the instructions they contain.
- The device must be operated by persons authorized and trained by the facility's owner-operator. Strict compliance with the instructions in the Operating Instructions is mandatory.
- The CNGmass is a device for measuring gas under high pressure. Therefore, professional design of the system and proper installation of all pressure-bearing parts is of vital importance for long-term safe operation.
- Endress+Hauser will be happy to assist in clarifying the corrosion resistance properties of materials wetted by special fluids, including fluids used for cleaning. However, small changes of temperature, concentration or degree of contamination in the process can result in differences in corrosion resistance. Therefore, Endress+Hauser provides no warranty and assumes no liability with regard to corrosion resistance of fluid wetted materials in any given application. The user is responsible for choosing suitable fluid wetted materials in the process.
- The installer must ensure that the measuring system is correctly wired in accordance with the wiring diagrams.
- Invariably, local regulations governing the maintenance and repair of electrical devices apply.

## 1.3 Operational safety

Note the following points:

- Measuring systems for use in hazardous environments are accompanied by separate "Ex documentation", which is an integral part of these Operating Instructions. Strict compliance with the installation instructions and ratings as stated in this supplementary documentation is mandatory. The symbol on the front of this supplementary Ex documentation indicates the approval and the inspection body ( Europe, NEC/CEC<sup>1)</sup>, NEPSI).
- The housing of the sensor is equipped with a rupture disk to prevent the pressure in the sensor housing from increasing in the event of an error. As long as the adhesive label (→  7) is intact, the rupture disk is also intact.
- The measuring device complies with the general safety requirements in accordance with EN 61010, the EMC requirements of IEC/EN 61326, and NAMUR recommendation NE 21.
- The manufacturer reserves the right to modify technical data without prior notice. Your Endress+Hauser distributor will supply you with current information and any updates to these Operating Instructions.

---

1) NEC (National Electrical Code) / CEC (Canadian Electrical Code)

- Danger - hot surfaces. Hot fluids passing through the measuring tube increase the surface temperature of the sensor housing. Temperatures close to the fluid temperature must be expected. If fluid temperatures are high, take suitable measures to protect against scalding from the hot surfaces.

## 1.4 Return

- Do not return a measuring device if you are not absolutely certain that all traces of hazardous substances have been removed, e.g. substances which have penetrated crevices or diffused through plastic.
- Costs incurred for waste disposal and injury (burns, etc.) due to inadequate cleaning will be charged to the owner-operator.
- Please note the measures on →  76.

## 1.5 Notes on safety conventions and icons

The devices are designed to meet state-of-the-art safety requirements, have been tested, and left the factory in a condition in which they are safe to operate. The devices comply with the applicable standards and regulations in accordance with EN 61010 "Safety requirements for electrical equipment for measurement, control and laboratory use". They can, however, be a source of danger if used incorrectly or for other than the designated use. Consequently, always pay particular attention to the safety instructions indicated in these Operating Instructions by the following icons:



Warning!

"Warning" indicates an action or procedure which, if not performed correctly, can result in injury or a safety hazard. Comply strictly with the instructions and proceed with care.



Caution!

"Caution" indicates an action or procedure which, if not performed correctly, can result in incorrect operation or destruction of the measuring device. Comply strictly with the instructions.



Note!

"Note" indicates an action or procedure which, if not performed correctly, can have an indirect effect on operation or trigger an unexpected response on the part of the device.

## 1.6 Symbols on nameplates

The following symbol appears on nameplates (refer to the corresponding documentation):



In the case of devices for potentially explosive atmospheres, a documentation code appears, representing supplementary Ex documentation that it is mandatory to read.

## 2 Identification

The following options are available for identification of the measuring device:

- Nameplate specifications.
- Order code with breakdown of the device features on the delivery note.
- Enter serial numbers from nameplates in *W@M Device Viewer* ([www.endress.com/deviceviewer](http://www.endress.com/deviceviewer)): All information about the measuring device is displayed.

For an overview of the scope of the Technical Documentation provided, refer to the following:

- The chapters "Documentation" →  83.
- The *W@M Device Viewer*: Enter the serial number from the nameplate ([www.endress.com/deviceviewer](http://www.endress.com/deviceviewer)).

### Reorder

The measuring device is reordered using the order code.

Extended order code:

- The device type (product root) and basic specifications (mandatory features) are always listed.
- Of the optional specifications (optional features), only the safety and approval-related specifications are listed (e.g. LA). If other optional specifications are also ordered, these are indicated collectively using the # placeholder symbol (e.g. #LA#).
- If the ordered optional specifications do not include any safety and approval-related specifications, they are indicated by the + placeholder symbol (e.g. 8DF\*\* -AACCCAAD2S1+).

### 2.1 Device designation

The "CNGmass DCI" flow measuring system consists of the following components:

- Transmitter
- Sensor

Two versions are available:

- Compact version: transmitter and sensor form a single mechanical unit.
- Remote version: transmitter and sensor are installed separately.

### 2.1.1 Nameplate of the transmitter

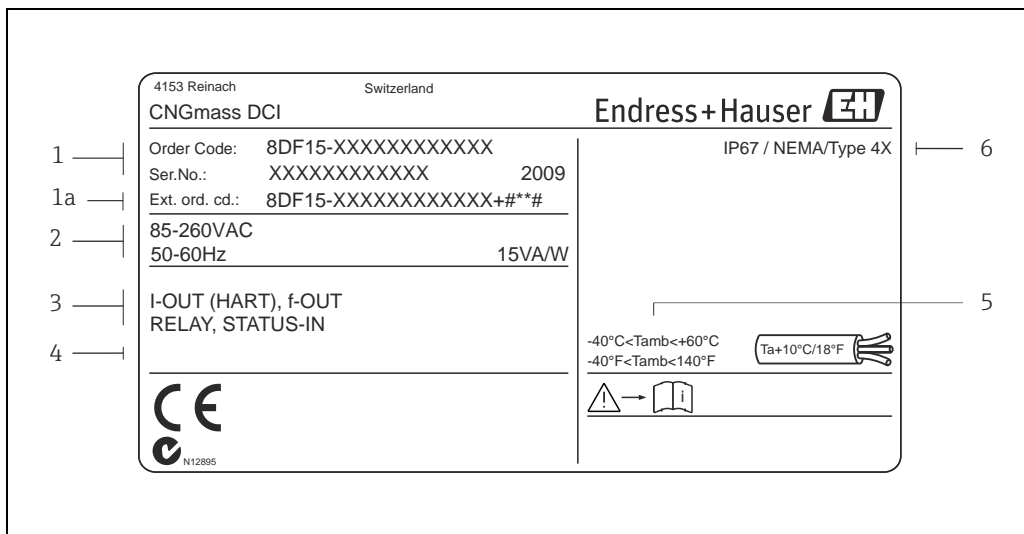

Fig. 1: Nameplate specifications for the transmitter (example)

- 1 Order code/serial number: See the specifications on the order confirmation for the meanings of the individual letters and digits
- 2 Power supply/ frequency: 85 to 260 V AC/ 50 to 60 Hz  
Power consumption: 15 VA / 15 W
- 3 Available inputs / outputs
- 4 Reserved for information on special products
- 5 Ambient temperature range
- 6 Degree of protection

### 2.1.2 Nameplate of the sensor

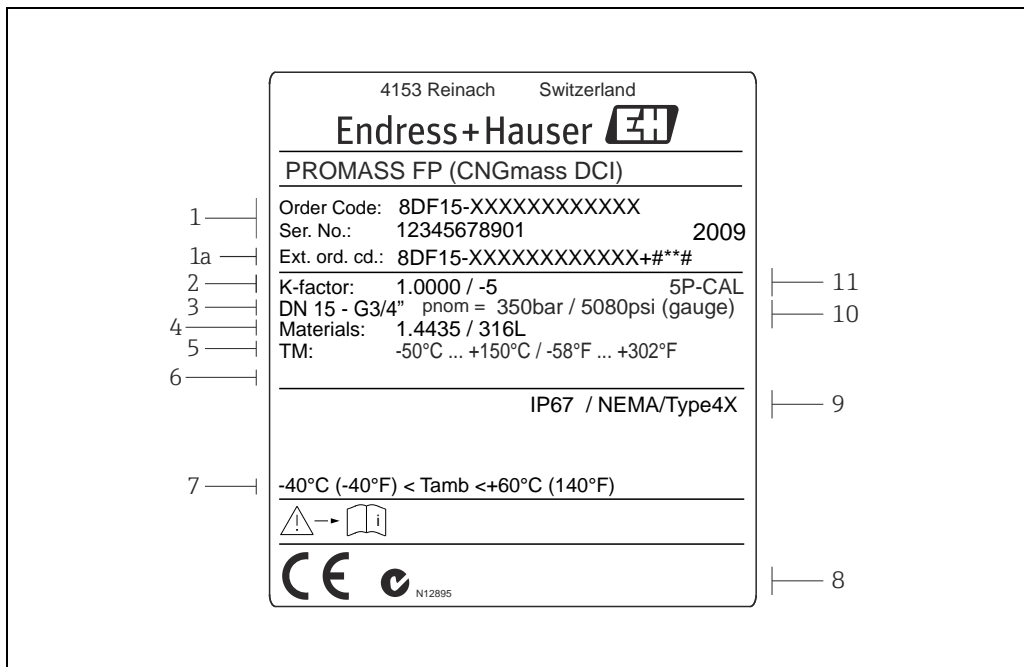
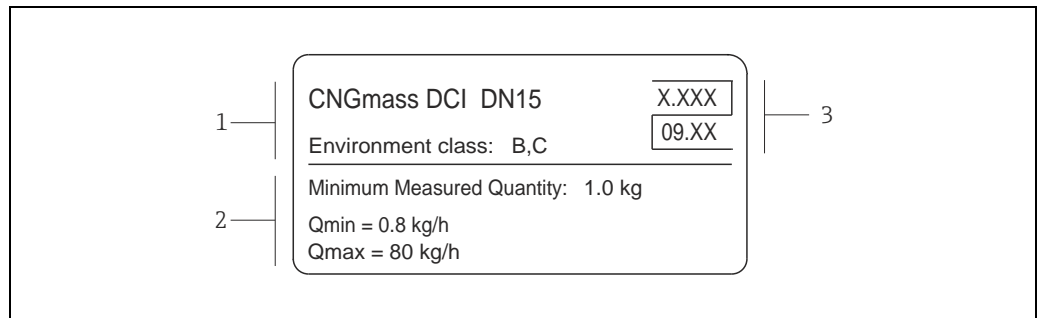

Fig. 2: Nameplate specifications for the sensor (example)

- 1 Order code/serial number: See the specifications on the order confirmation for the meanings of the individual letters and digits
- 2 Calibration factor
- 3 Flange nominal diameter
- 4 Material
- 5 Max. fluid temperature
- 6 Reserved for information on special products
- 7 Ambient temperature range
- 8 Reserved for additional information on device version (approvals, certificates)
- 9 Degree of protection
- 10 Nominal pressure: 350 bar
- 11 Additional information: with 5-point calibration

### 2.1.3 Additional nameplate for suitability for custody transfer measurement



A0011591-en

Fig. 3: Nameplate specifications for suitability for custody transfer measurement (example)

- 1 Ambient classes
- 2 Measured quantities
- 3 Symbol for custody transfer consisting of the number and issue date

### 2.1.4 Nameplate for connections

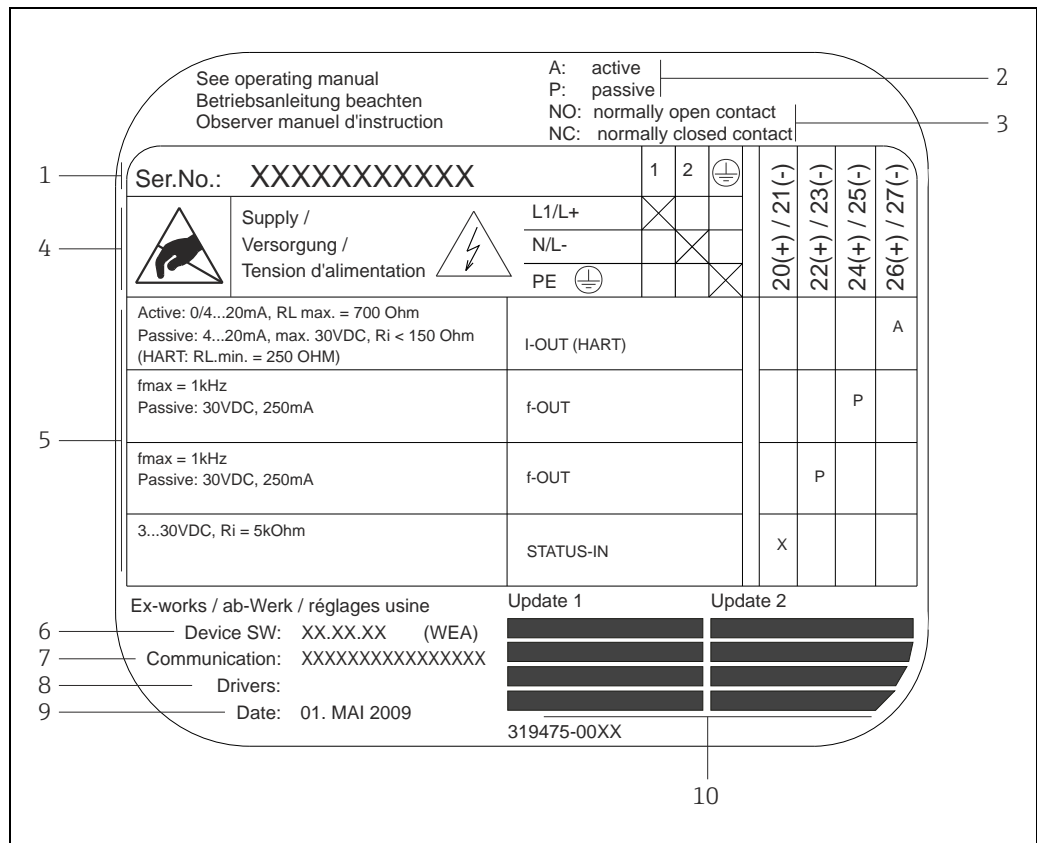

A0002015

Fig. 4: Nameplate specifications for transmitter connections (example)

- 1 Serial number
- 2 Possible configuration of current output
- 3 Possible configuration of relay contacts
- 4 Terminal assignment, cable for power supply: 85 to 260 V AC, 20 to 55 V AC, 16 to 62 V DC
  - Terminal No. 1: L1 for AC, L+ for DC
  - Terminal No. 2: N for AC, L- for DC
- 5 Signals present at inputs and outputs, possible configuration and terminal assignment (20 to 27),  
→ also "Electrical values of inputs/outputs" → 77
- 6 Version of device software currently installed (incl. language group)
- 7 Installed communication type
- 8 Information on current communication software (Device Revision and Device Description)
- 9 Date of installation
- 10 Current updates to data specified in points 6 to 9



## 2.2 Certificates and approvals

The devices are designed in accordance with good engineering practice to meet state-of-the-art safety requirements, have been tested, and left the factory in a condition in which they are safe to operate.

The measuring devices comply with the applicable standards and regulations in accordance with EN 61010-1, "Safety requirements for electrical equipment for measurement, control and laboratory use" and with the EMC requirements of IEC/EN 61326. The measuring system described in these Operating Instructions thus complies with the statutory requirements of the EC Directives. Endress+Hauser confirms successful testing of the device by affixing to it the CE mark.

The measuring system meets the EMC requirements of the Australian Communications and Media Authority (ACMA).

## 2.3 Registered trademarks

HART®

Registered trademarks of HART Communication Foundation, Austin, USA

Applicator®, FieldCare®, HistoROM™, S-DAT®, T-DAT®

Registered or registration-pending trademarks of the Endress+Hauser Group

## 3 Incoming acceptance, transport and storage

### 3.1 Incoming acceptance

On receipt of the goods, check the following points:

- Is the packaging or content damaged?
- Is anything missing from the shipment and does the scope of supply match your order?

### 3.2 Transport

Comply with the following instructions when unpacking the device and transporting it to its final location:

- Transport the devices in the containers in which they are delivered.
- The covers or caps fitted to the process connections prevent mechanical damage to the sealing faces and the ingress of foreign matter to the measuring tube during transportation and storage. Consequently, do not remove these covers or caps until immediately before installation.

### 3.3 Storage

Note the following points:

- Pack the measuring device in such a way as to protect it reliably against impact for storage (and transportation). The original packaging provides optimum protection.
- The permitted storage temperature is  $-40$  to  $+80$  °C ( $-40$  to  $176$  °F).
- Do not remove the protective caps on the process connections until you are ready to install the device.
- The measuring device must be protected against direct sunlight during storage in order to avoid unacceptably high surface temperatures.

## 4 Installation

### 4.1 Installation conditions

The measuring device is to be installed in a de-energized state free from outside loads or strain.

#### 4.1.1 Dimensions

All the dimensions and lengths of the sensor and transmitter are provided in the separate documentation entitled "Technical Information", →  83.

#### 4.1.2 Inlet and outlet runs

No special precautions need to be taken for fittings which create turbulence (valves, elbows, T-pieces etc.).

#### 4.1.3 Vibrations

The high oscillation frequency of the measuring tubes ensures that the correct operation of the measuring system is not influenced by pipe vibrations. Consequently, the sensors require no special measures for attachment.

#### 4.1.4 Limiting flow

Limiting flow information can be found in the separate "Technical Information" document, →  83.

#### 4.1.5 Special installation instructions

##### Rupture disk

Make sure that the function and operation of the rupture disk is not impeded through the installation of the device. The position of the rupture disk is indicated on a sticker applied over it. If the rupture disk is triggered, the sticker is destroyed. The disk can therefore be visually monitored. For additional information that is relevant to the process (→  80).

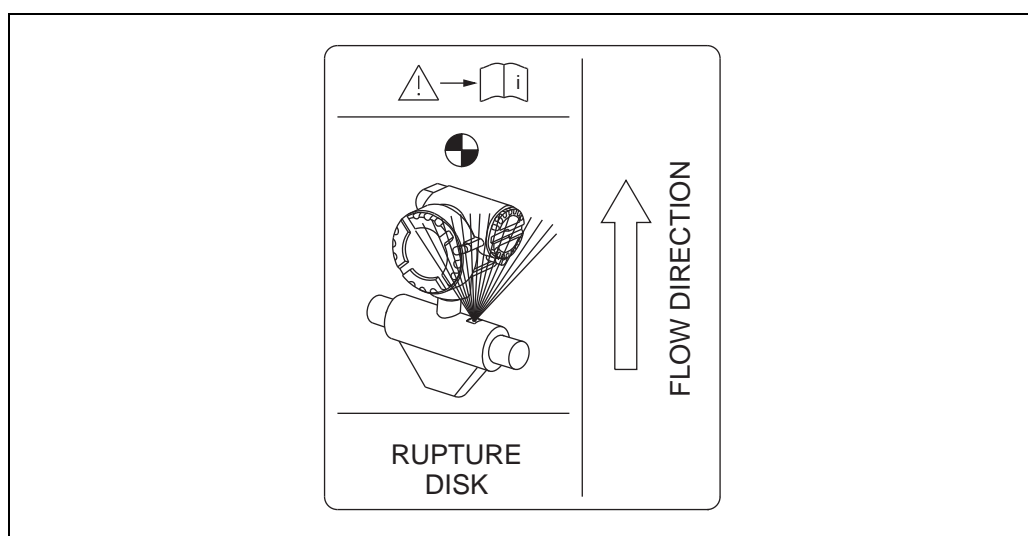

Fig. 5: Indication label for the rupture disk

A0006920

## 4.2 Installation instructions

### 4.2.1 Turning the transmitter housing

#### Turning the aluminum field housing



#### Warning!

The turning mechanism in devices with EEx d/de or NEC/CEC Cl. I Div. 1 classification is not the same as that described here. The procedure for turning these housings is described in the Ex-specific documentation.

1. Loosen the two securing screws.
2. Turn the bayonet catch as far as it will go.
3. Carefully lift the transmitter housing as far as it will go.
4. Turn the transmitter housing to the desired position (max.  $2 \times 90^\circ$  in either direction).
5. Lower the housing into position and reengage the bayonet catch.
6. Retighten the two securing screws.

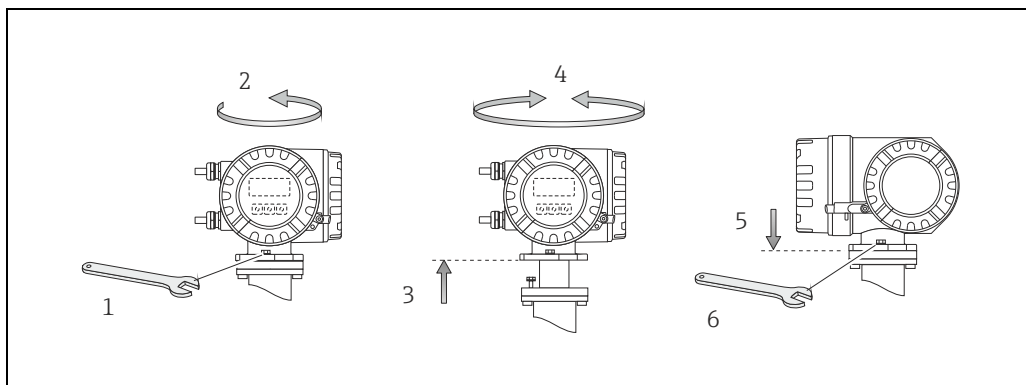

Fig. 6: Turning the transmitter housing (aluminum field housing)

A0004302

## 4.2.2 Installing the wall-mount housing

There are various ways of installing the wall-mount housing:

- Mounted directly on the wall
- Installation in control panel (separate mounting set, accessories) → 14
- Pipe mounting (separate mounting set, accessories) → 14



Caution!

- At the mounting location, ensure that the permitted ambient temperature range ( $-20$  to  $+60$  °C ( $-4$  to  $+140$  °F), optional  $-40$  to  $+60$  °C ( $-40$  to  $+140$  °F)) is not exceeded. Install the device in a shady location. Avoid direct sunlight.
- Always install the wall-mount housing in such a way that the cable entries are pointing down.

### Mounted directly on the wall

1. Drill the holes → 7.
2. Remove the cover of the connection compartment (a).
3. Push the two securing screws (b) through the appropriate bores (c) in the housing.
  - Securing screws (M6): max.  $\varnothing$  6.5 mm (0.26")
  - Screw head: max.  $\varnothing$  10.5 mm (0.41")
4. Secure the transmitter housing to the wall as indicated.
5. Screw the cover of the connection compartment (a) firmly onto the housing.

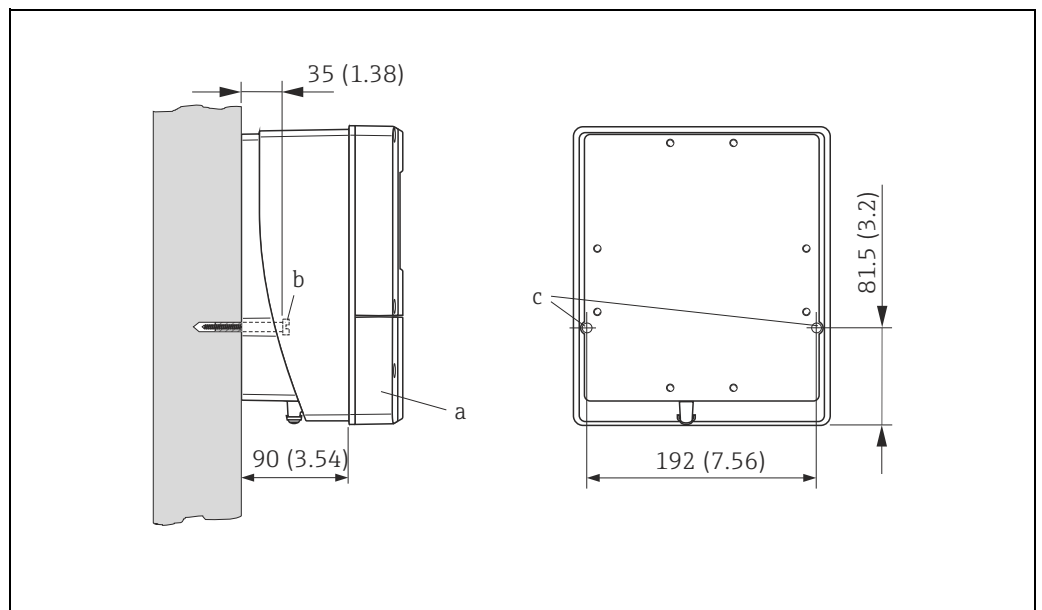



Fig. 7: Mounted directly on the wall

A0001130

### Installation in control panel

1. Prepare the opening in the panel →  8.
2. Slide the housing into the opening in the panel from the front.
3. Screw the fasteners onto the wall-mount housing.
4. Screw the threaded rods into the holders and tighten them until the housing is secured on the panel wall. Afterwards, tighten the locking nuts. Additional support is not necessary.

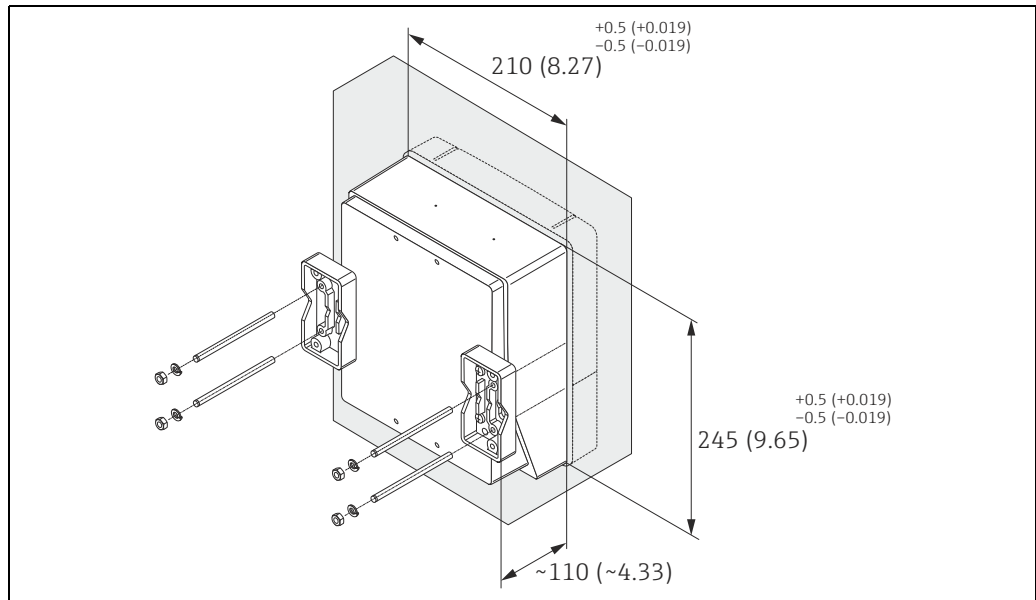

Fig. 8: Panel installation (wall-mount housing)

### Pipe mounting

The assembly should be performed by following the instructions in →  9.



Caution!

If a warm pipe is used for installation, ensure that the housing temperature does not exceed the permitted value of +60 °C (+140 °F).

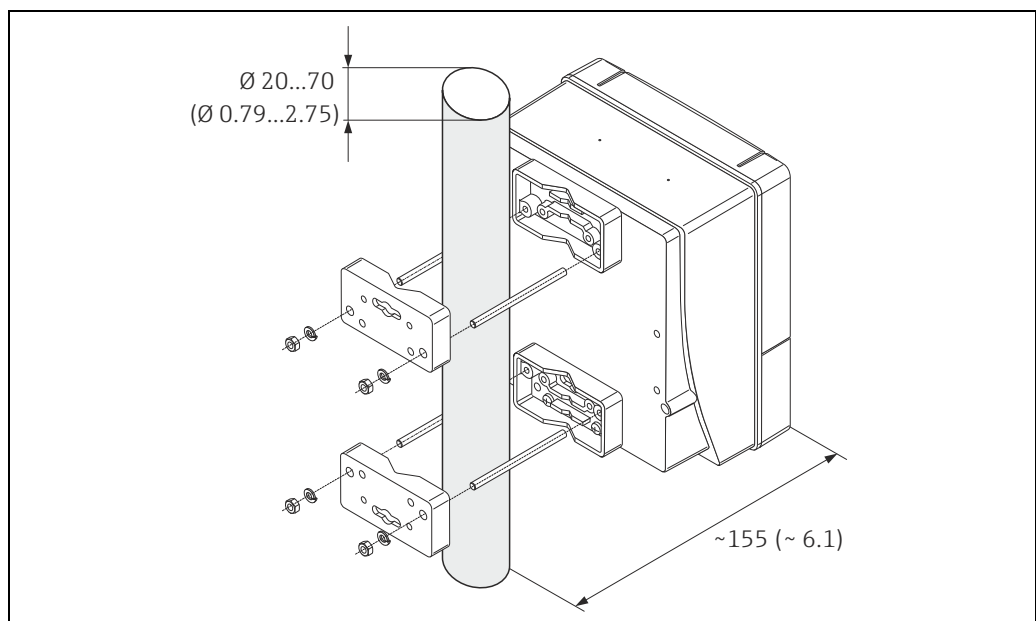

Fig. 9: Pipe mounting (wall-mount housing)

### 4.2.3 Turning the local display

1. Unscrew cover of the electronics compartment from the transmitter housing.
2. Press the side latches on the display module and remove the module from the electronics compartment cover plate.
3. Rotate the display to the desired position (max.  $4 \times 45^\circ$  in both directions), and reset it onto the electronics compartment cover plate.
4. Screw the cover of the electronics compartment firmly back onto the transmitter housing.

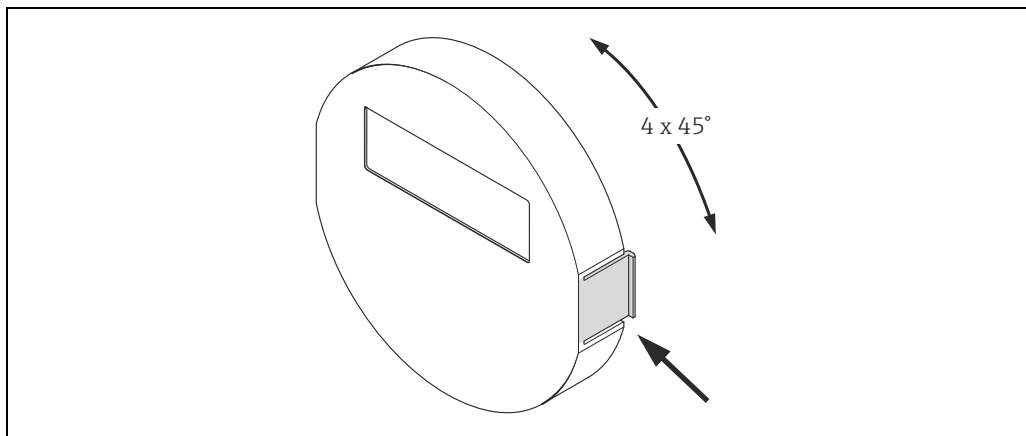

Fig. 10: Turning the local display (field housing)

### 4.3 Post-installation check

Perform the following checks after installing the measuring device in the pipe:

Device condition and specifications	Notes
Is the device damaged (visual inspection)?	-
Does the device correspond to specifications at the measuring point, including process temperature and pressure, ambient temperature, measuring range etc.?	→ 7
Installation	Notes
Does the arrow on the sensor nameplate match the direction of flow through the pipe?	-
Are the measuring point number and labeling correct (visual inspection)?	-
Is the orientation chosen for the sensor correct, in other words suitable for sensor type, fluid properties (outgassing, with entrained solids) and fluid temperature?	→ 11
Process environment / process conditions	Notes
Is the measuring device protected against moisture and direct sunlight?	-

## 5 Wiring



### Warning!

When connecting Ex-certified devices, see the notes and diagrams in the Ex-specific supplement to these Operating Instructions. Please do not hesitate to contact your Endress+Hauser sales office if you have any questions.



### Note!

The measuring device does not have an internal disconnecting device. Therefore, assign a switch or circuit breaker to the measuring device with which the voltage supply line can be disconnected from the power system.

### 5.1 Shielding and grounding

When planning the shielding and grounding for a fieldbus system, there are three important points to consider:

- Electromagnetic compatibility (EMC)
- Explosion protection
- Employee safety

To ensure the optimum electromagnetic compatibility of systems, it is important that the system components and above all the cables, which connect the components, are shielded and that no portion of the system is unshielded. Ideally, the cable shields are connected to the normally metal housings of the connected field devices. Since these are generally connected to the protective ground, the shield of the bus cable is grounded many times. Make sure that the stripped and twisted lengths of cable shield to the terminals are as short as possible.

This approach, which provides the best electromagnetic compatibility and employee safety, can be used without restriction in systems with optimum potential equalization.

In the case of systems without potential equalization, a mains frequency (50 Hz) equalizing current can flow between two grounding points which can destroy the cable in unfavorable cases, e.g. when it exceeds the permissible shield current.

To suppress the low frequency equalizing currents on systems without potential equalization, it is therefore recommended to connect the cable shield directly to the building ground (or protective ground) at one end only and to use capacitive coupling to connect all other grounding points.



### Caution!

The legal EMC requirements are fulfilled **only** when the cable shield is grounded on both sides.



## 5.2 Connecting the remote version

### 5.2.1 Connecting cable for sensor/transmitter



Warning!

- Risk of electric shock. Switch off the power supply before opening the device. Do not install or wire the device while it is connected to the power supply. Failure to comply with this precaution can result in irreparable damage to the electronics.
- Risk of electric shock. Connect the protective ground to the ground terminal on the housing before the power supply is applied.
- You may only connect the sensor to the transmitter with the same serial number. Communication errors can occur if this is not observed when connecting the devices.

1. Remove the cover (d) from the connection compartment or sensor housing.
2. Feed the connecting cable (e) through the appropriate cable runs.
3. Establish the wiring between the sensor and transmitter in accordance with the wiring diagram (→ 11 or wiring layout in the screw cap).
4. Seal the connection compartment or the transmitter housing again.

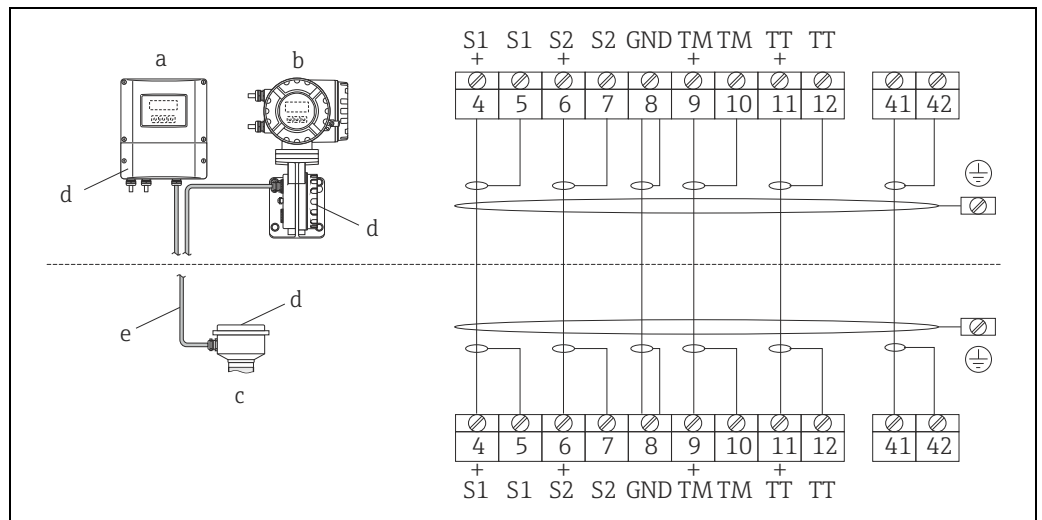

Fig. 11: Connecting the remote version

- a Transmitter wall-mount housing: non-hazardous area
- b Transmitter wall-mount housing: ATEX II2G / Zone 1 / NEC/CEC → separate Ex documentation
- c Sensor connection housing
- d Cover of connection compartment or connection housing
- e Connecting cable

Terminal No.: 4/5 = gray; 6/7 = green; 8 = yellow; 9/10 = pink; 11/12 = white; 41/42 = brown

### 5.2.2 Cable specification, connecting cable

The specifications of the cable connecting the transmitter and the sensor of the remote version are as follows:

- $6 \times 0.38 \text{ mm}^2$  (20 AWG) PVC cable with common shield and individually shielded cores
- Conductor resistance:  $\leq 50 \text{ } \Omega/\text{km}$  ( $\leq 0.015 \text{ } \Omega/\text{ft}$ )
- Capacitance core/shield:  $\leq 140 \text{ pF/m}$  ( $\leq 42.7 \text{ pF/ft}$ )
- Cable length: max. 20 m (65.6 ft)
- Permanent operating temperature: max.  $+105 \text{ } ^\circ\text{C}$  ( $+221 \text{ } ^\circ\text{F}$ )



Note!

The cable must be installed securely, to prevent movement.

## 5.3 Connecting the measuring unit

### 5.3.1 Transmitter connection



#### Warning!

- Risk of electric shock. Switch off the power supply before opening the device. Do not install or wire the device while it is connected to the power supply. Failure to comply with this precaution can result in irreparable damage to the electronics.
- Risk of electric shock. Connect the protective ground to the ground terminal on the housing before the power supply is applied unless special protection measures have been taken (e. g. galvanically isolated power supply SELV or PELV).
- Compare the specifications on the nameplate with the local supply voltage and frequency. The national regulations governing the installation of electrical equipment also apply.

1. Remove the cover of the connection compartment (a) from the transmitter housing.
2. Feed the power supply cable (b), signal cable (g) and fieldbus cable (d) through the appropriate cable entries.
3. Perform wiring in accordance with the respective terminal assignment and the associated wiring diagram.



#### Caution!

- Risk of damaging the fieldbus cable. Observe the information about shielding and grounding the fieldbus cable (→ 16).
  - We recommend that the fieldbus cable not be looped using conventional cable glands. If even just one measuring device is subsequently replaced, the bus communication will have to be interrupted.
4. Screw the cover of the connection compartment (a) firmly onto the transmitter housing.

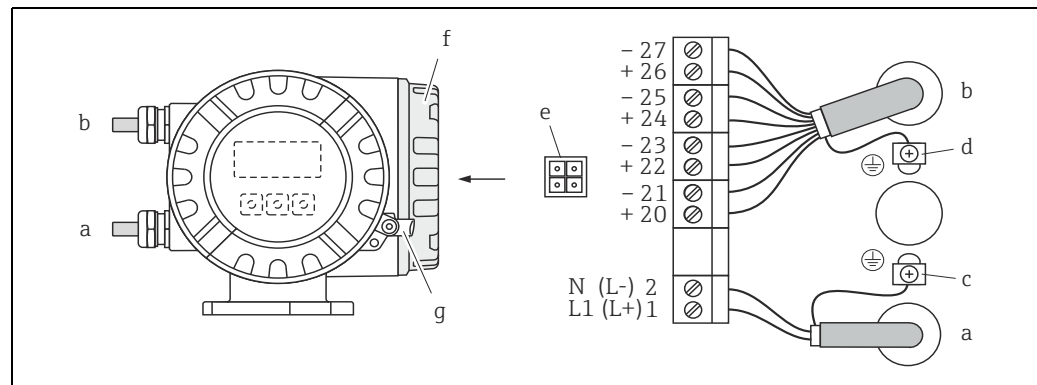

Fig. 12: Connecting the transmitter (field housing), cable cross-section: max. 2.5 mm<sup>2</sup> (14 AWG)

- a Cable for power supply: 85 to 260 V AC, 20 to 55 V AC, 16 to 62 V DC  
 - Terminal **No. 1**: L1 for AC, L+ for DC  
 - Terminal **No. 2**: N for AC, L- for DC
- b Signal cable: Terminals **No. 20 to 27** → 19
- c Ground terminal for protective ground
- d Ground terminal for signal cable shield
- e Service adapter for connecting service interface FXA193 (FieldCare)
- f Cover of the connection compartment
- g Securing clamp

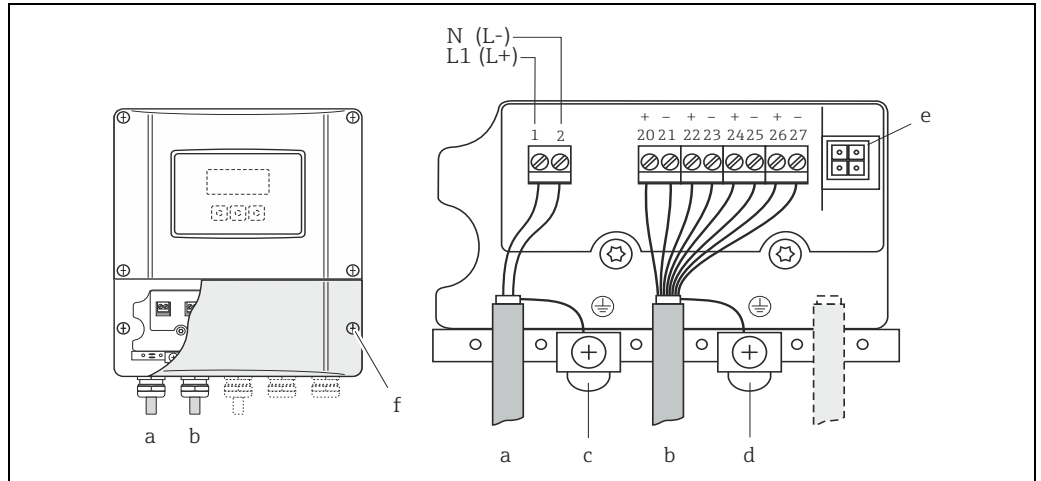

Fig. 13: Connecting the transmitter (wall-mount housing), cable cross-section: max. 2.5 mm<sup>2</sup> (14 AWG)<sup>2</sup>

- a Cable for power supply: 85 to 260 V AC, 20 to 55 V AC, 16 to 62 V DC
  - Terminal No. 1: L1 for AC, L+ for DC
  - Terminal No. 2: N for AC, L- for DC
- b Signal cable: Terminals No. 20 to 27 → 19
- c Ground terminal for protective ground
- d Ground terminal for signal cable shield
- e Service adapter for connecting service interface FXA193 (FieldCare)
- f Cover of the connection compartment

### 5.3.2 Terminal assignment

Electrical values for inputs → 77.

Electrical values for outputs → 78.

Order characteristic for "inputs/outputs"	Terminal No. (inputs/outputs)			
	20 (+) / 21 (-)	22 (+) / 23 (-)	24 (+) / 25 (-)	26 (+) / 27 (-)
Fixed communication boards (permanent assignment)				
S	-	-	Frequency output, Ex i, passive	Current output, Ex i, active, HART
T	-	-	Frequency output, Ex i, passive	Current output, Ex i, passive, HART
Flexible communication boards				
D	Status input	Relay output	Frequency output	Current output, HART
M	Status input	Frequency output 2	Frequency output 1	Current output, HART
1	Relay output	Frequency output 2	Frequency output 1	Current output, HART
2	Relay output	Current output 2	Frequency output	Current output 1, HART

### 5.3.3 HART connection

Users have the following connection options at their disposal:

- Direct connection to transmitter by means of terminals 26 (+) / 27 (-)
- Connection by means of the 4 to 20 mA circuit



Note!

- The measuring circuit's minimum load must be at least 250  $\Omega$ .
- The CURRENT SPAN function must be set to "4 to 20 mA" (individual options → "Description of Device Parameters" manual).
- See also the documentation issued by the HART Communication Foundation, and in particular HCF LIT 20: "HART, a technical summary".

#### Connection of the HART handheld communicator

See also the documentation issued by the HART Communication Foundation, and in particular HCF LIT 20: "HART, a technical summary".

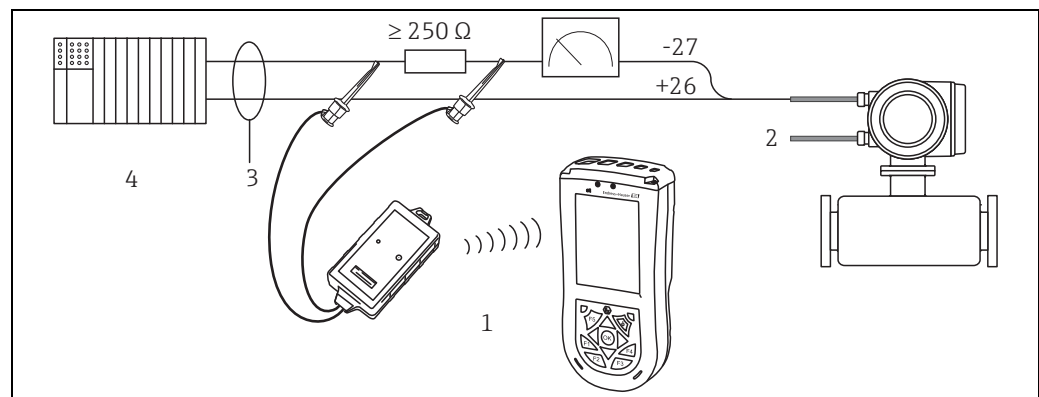

Fig. 14: Electrical connection of HART handheld terminal

- 1 HART handheld terminal
- 2 Auxiliary energy
- 3 Shielding
- 4 Other switching units or PLC with passive input

#### Connection of a PC with an operating software

In order to connect a PC with operating software (e.g. FieldCare), a HART modem (e.g. Commubox FXA195) is needed.

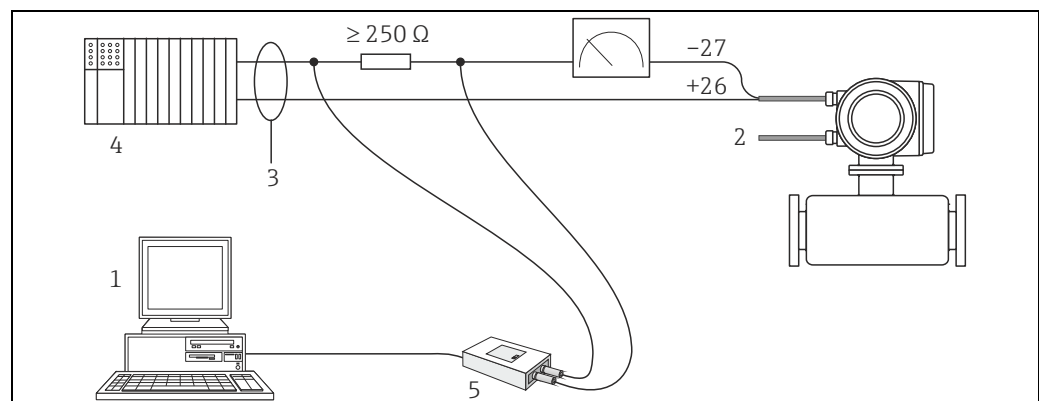





Fig. 15: Electrical connection of a PC with operating software

- 1 PC with operating software
- 2 Auxiliary energy
- 3 Shielding
- 4 Other switching units or PLC with passive input
- 5 HART modem, e.g. Commubox FXA195

## 5.4 Degree of protection

The measuring device fulfills all the requirements for IP 67.

Compliance with the following points is mandatory following installation in the field or servicing, in order to ensure that IP 67 protection is maintained:

- The housing seals must be clean and undamaged when inserted into their grooves. The seals must be dried, cleaned or replaced if necessary.
- The screws and screw covers must be firmly tightened.
- The cables used for connection must be of the specified outside diameter →  78, Cable entries.
- The cable entries must be firmly tightened (point **a** →  16).
- The cable must loop down in front of the cable entry ("water trap") (point **b** →  16). This arrangement prevents moisture penetrating the entry.



Note!

The cable entries may not point up.

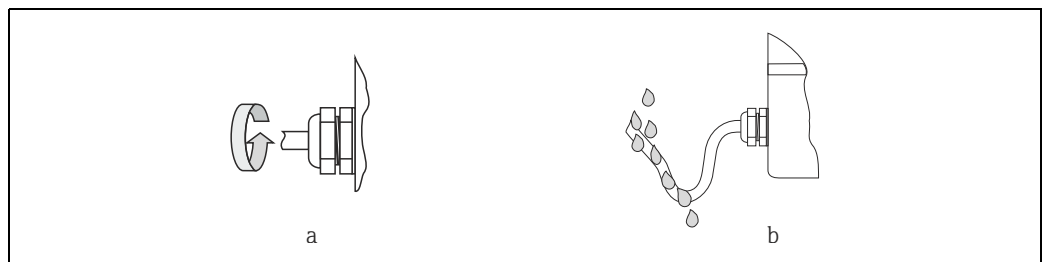

Fig. 16: Installation instructions, cable entries

- Remove all unused cable entries and insert plugs instead.
- Do not remove the grommet from the cable entry.





Caution!

Do not loosen the screws of the sensor housing, as otherwise the degree of protection guaranteed by Endress+Hauser no longer applies.

## 5.5 Post-connection check

Perform the following checks after completing electrical installation of the measuring device:

Device condition and specifications	Notes
Are cables or the device damaged (visual inspection)?	–
Electrical connection	Notes
Does the supply voltage match the specifications on the nameplate?	85 to 260 V AC (45 to 65 Hz) 20 to 55 V AC (45 to 65 Hz) 16 to 62 V DC
Do the cables comply with the specifications?	→  17
Do the cables have adequate strain relief?	–
Is the cable type route completely isolated? Without loops and crossovers?	–
Are the power supply and signal cables correctly connected?	→ Wiring diagram inside the cover of the terminal compartment
Are all screw terminals firmly tightened?	–
Are all cable entries installed, firmly tightened and correctly sealed? Cables looped as "water traps"?	→  21, "Degree of protection" section
Are all housing covers installed and firmly tightened?	–

## 6 Operation

### 6.1 Display and operating elements

The local display enables you to read all important parameters directly at the measuring point and configure the device using the "Quick Setup" or the function matrix. The display consists of four lines; this is where measured values and/or status variables (direction of flow, empty pipe, bar graph etc.) are displayed. You can change the assignment of display lines to different variables to suit your needs and preferences (→ "Description of Device Parameters" manual, GP00001D).

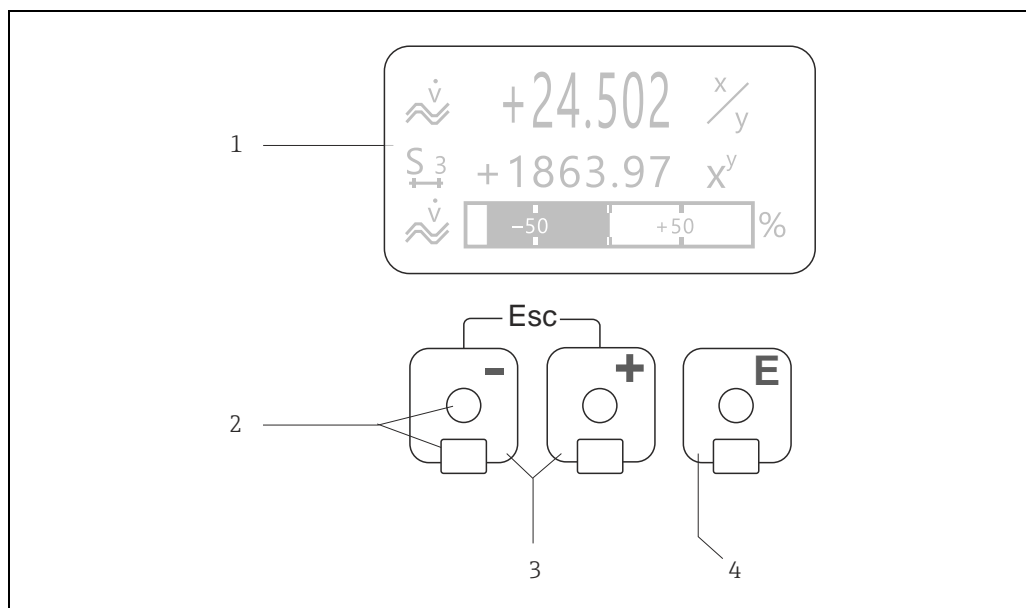

Fig. 17: Display and operating elements

- 1 **Liquid crystal display**  
The backlit, four-line liquid crystal display shows measured values, dialog texts, fault messages and notice messages. HOME position (operating mode) is the term given to the display during normal operation.  
Readings displayed
- 2 **Optical sensors for "Touch Control"**
- 3 **Plus/minus keys**
  - HOME position → Direct access to totalizer values and actual values of inputs/outputs
  - Enter numerical values, select parameters
  - Select different blocks, groups and function groups within the function matrix

Press the +/- keys (  $\square/\square$  ) simultaneously to trigger the following functions:

  - Exit the function matrix step by step → HOME position
  - Press and hold the  $\square/\square$  keys for longer than 3 seconds → Return directly to home position
  - Cancel data entry
- 4 **Enter key**
  - HOME position → Entry into the function matrix
  - Save the numerical values you input or settings you change

### 6.1.1 Readings displayed (operation mode)

The display area consists of three lines in all; this is where measured values are displayed, and/or status variables (direction of flow, bar graph etc.). You can change the assignment of display lines to different variables to suit your needs and preferences (→ "Description of Device Parameters" manual).

#### Multiplex mode

A maximum of two different display variables can be assigned to each line. Variables multiplexed in this way alternate every 10 seconds on the display.

#### Error messages

Display and presentation of system/process errors →  28

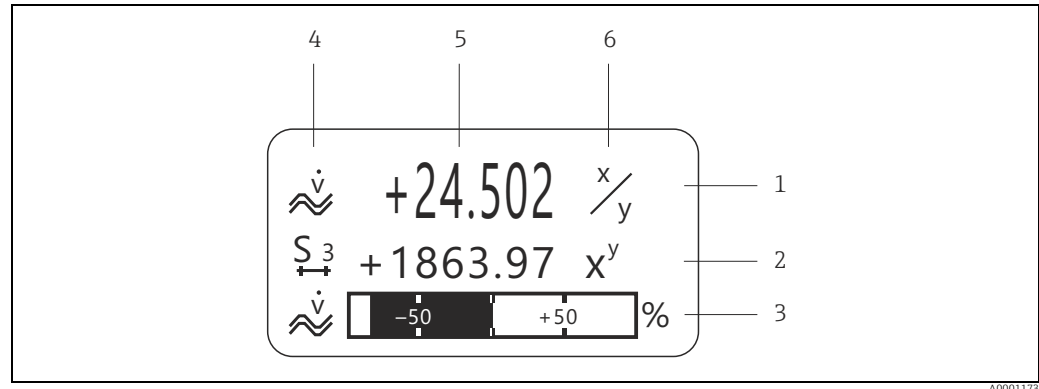



Fig. 18: Typical display for normal operating mode (HOME position)

- 1 Main display line: shows primary measured values, e.g. mass flow in [kg/h]
- 2 Additional line: shows measured variables and status variables, e.g. totalizer No. 3 in [t]
- 3 Information line: shows additional information on the measured variables and status variables, e.g. bar graph display of the full scale value achieved by the mass flow
- 4 "Info icons" field: icons representing additional information on the measured values are shown in this field. For a full list of the icons and their meanings see →  25
- 5 "Measured values" field: the current measured values appear in this field
- 6 "Unit of measure" field: the units of measure and time defined for the current measured values appear in this field

### 6.1.2 Additional display functions

From HOME position, use the  keys to open an "Info Menu" containing the following information:

- Totalizer (including overflow)
- Actual values or states of the configured inputs/outputs
- Device TAG number (user-definable)













 → Scan of individual values within the Info Menu

 (Esc key) → Back to HOME position



### 6.1.3 Icons

The icons which appear in the field on the left make it easier to read and recognize measured variables, device status, and error messages.

Icon	Meaning	Icon	Meaning
S	System error	P	Process error
	Fault message (with effect on outputs)	!	Notice message (without effect on outputs)
1 to n	Current output 1 to n	P 1 to n	Pulse output 1 to n
F 1 to n	Frequency output	S 1 to n	Status/relay output 1 to n (or status input)
$\Sigma$ 1 to n	Totalizer 1 to n		
 A0001181	Measuring mode; PULSATING FLOW	 A0001182	Measuring mode; SYMMETRY (bidirectional)
 A0001183	Measuring mode; STANDARD	 A0001184	Counting mode, totalizer; BALANCE (forward and reverse flow)
 A0001185	Counting mode, totalizer; forward	 A0001186	Counting mode, totalizer; reverse
 A0001187	Status input	 A0001188	Volume flow
 A0001200	Fluid density	 A0001208	Reference density
 A0001207	Medium temperature	 a0001206	Configuration via remote operation Active device operation via: <ul style="list-style-type: none"> <li>▪ HART, e.g. FieldCare, Field Xpert</li> </ul>

## 6.2 Brief guide to the function matrix



Note!

- See the general notes → 27
- Function descriptions → see the "Description of Device Parameters" manual

1. HOME position → → Entry into the function matrix.
2. Select a block (e.g. OUTPUTS).
3. Select a group (e.g. CURRENT OUTPUT 1).
4. Select a function group (e.g. SETTINGS).
5. Select a function (e.g. TIME CONSTANT).  
Change parameter / enter numerical values:  
  - Select or enter enable code, parameters, numerical values
  - Save your entries
6. Exit the function matrix:
  - Press and hold down Esc key ( ) for longer than 3 seconds → HOME position.
  - Repeatedly press Esc key ( ) → Return step by step to HOME position.

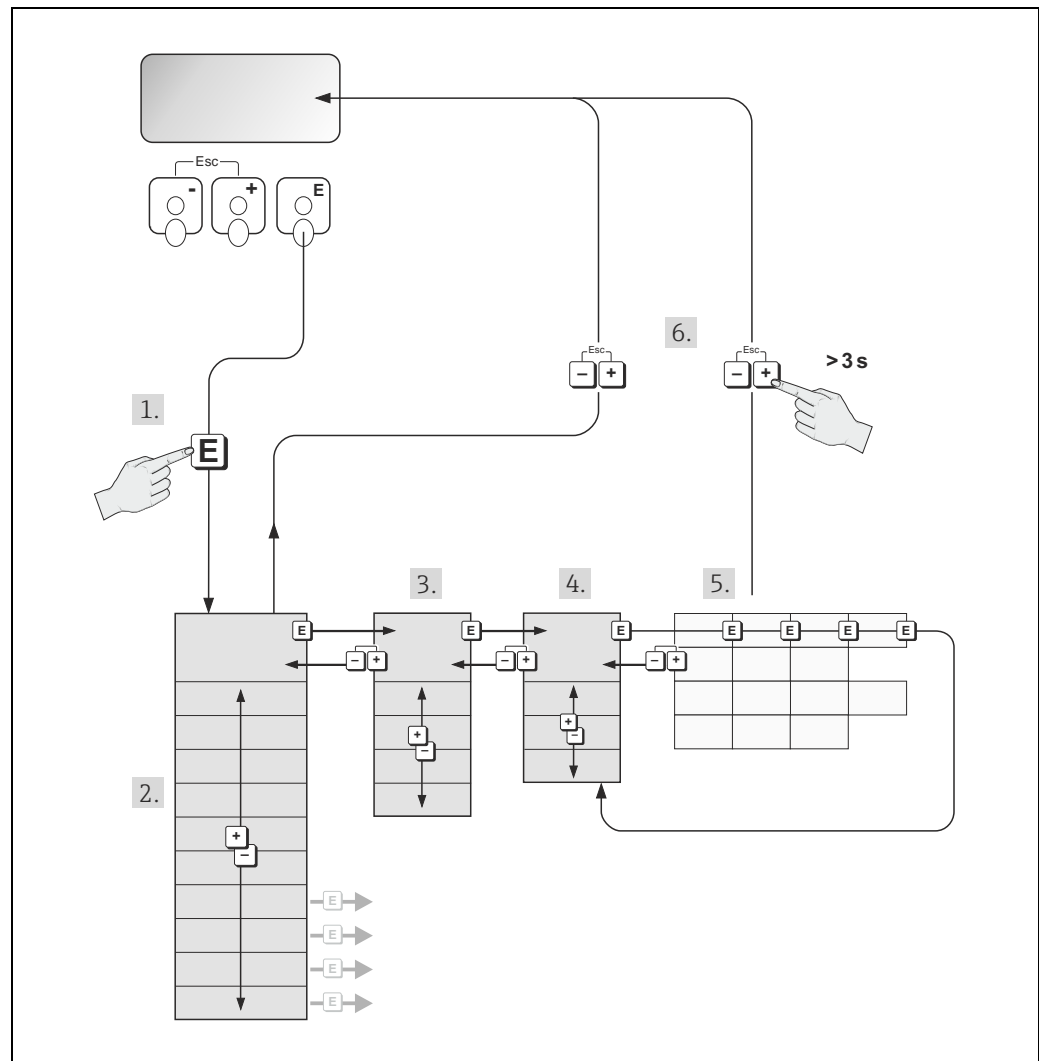



Fig. 19: Selecting functions and configuring parameters (function matrix)

A0001210

### 6.2.1 General notes

The Quick Setup menu contains the default settings that are adequate for commissioning. Complex measuring operations on the other hand necessitate additional functions that you can configure as necessary and customize to suit your process parameters. The function matrix, therefore, comprises a multiplicity of additional functions which, for the sake of clarity, are arranged on a number of menu levels (blocks, groups, and function groups).

Comply with the following instructions when configuring functions:

- You select functions as described already →  26. Each cell in the function matrix is identified by a numerical or letter code on the display.
- You can switch off certain functions (OFF). If you do so, related functions in other function groups will no longer be displayed.
- Certain functions prompt you to confirm your data entries. Press P to select "SURE | YES |" and press F to confirm. This saves your setting or starts a function, as applicable.
- Return to the HOME position is automatic if no key is pressed for 5 minutes.
- Programming mode is disabled automatically if a key is not pressed within 60 seconds following automatic return to the HOME position.



Caution!

All functions are described in detail, as is the function matrix itself, in the "Description of Device Parameters" manual which is a separate part of these Operating Instructions.



Note!

- The transmitter continues to measure while data entry is in progress, i.e. the current measured values are output via the signal outputs in the normal way.
- If the supply voltage fails all preset and parameterized values remain safely stored in the EEPROM.

### 6.2.2 Enabling the programming mode

The function matrix can be disabled. Disabling the function matrix rules out the possibility of inadvertent changes to device functions, numerical values or factory settings. A numerical code (factory setting = 84) has to be entered before settings can be changed.

If you use a code number of your choice, you exclude the possibility of unauthorized persons accessing data (→ "Description of Device Parameters" manual).

Comply with the following instructions when entering codes:

- If programming is disabled and the  operating elements are pressed in any function, a prompt for the code automatically appears on the display.
- If "0" is entered as the customer's code, programming is always enabled.
- Your Endress+Hauser representative can be of assistance if you mislay your personal code.



Caution!

Changing certain parameters such as all sensor characteristics, for example, influences numerous functions of the entire measuring system, particularly measuring accuracy. There is no need to change these parameters under normal circumstances and consequently, they are protected by a special code known only to Endress+Hauser representatives. Please contact Endress+Hauser if you have any questions.

### 6.2.3 Disabling the programming mode

Programming mode is disabled if you do not press an operating element within 60 seconds following automatic return to the HOME position.

Programming can also be disabled by entering any number (other than the customer's code) in the "ACCESS CODE" function.

## 6.3 Error messages

### 6.3.1 Type of error

Errors that occur during commissioning or measuring are displayed immediately. If two or more system or process errors occur, the error with the highest priority is the one shown on the display.

The measuring system distinguishes between two types of error:

- **System error**

This group comprises all device errors, e.g. communication errors, hardware errors etc. →  63

- **Process error**

This group includes all application errors, e.g. fluid not homogeneous etc. →  67

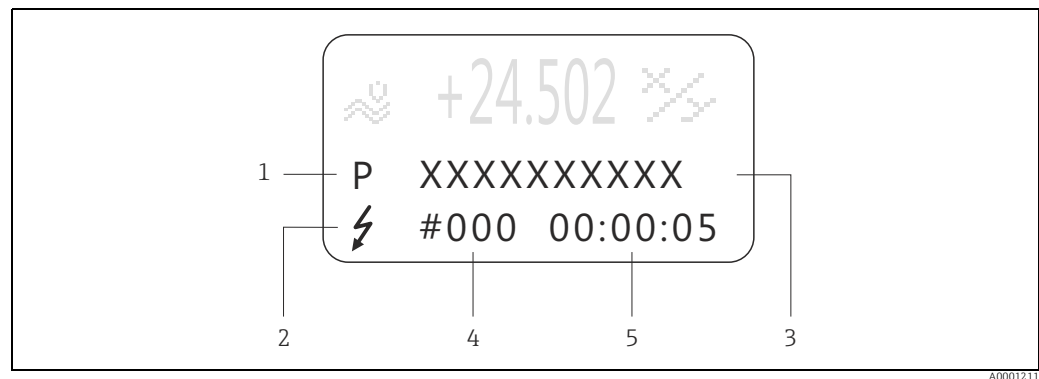

Fig. 20: Error messages on the display (example)

- 1 Error type: P = process error, S = system error
- 2 Error message type: ⚡ = Fault message, ! = Notice message
- 3 Error designation: e.g. FLUID INHOM. = fluid is not homogeneous
- 4 Error number: e.g. #702
- 5 Duration of most recent error occurrence (in hours, minutes and seconds)

### 6.3.2 Error message type

The measuring device always assigns system and process errors which occur to two types of error messages (**fault or notice messages**), resulting in different weightings. Serious system errors, e.g. module defects, are always identified and classed as "fault messages" by the measuring device.

#### Notice message (!)

- The error in question has no effect on the current operating mode and on the outputs of the measuring device.
- Displayed as → Exclamation mark (!), type of error (S: system error, P: process error)

#### Fault message (⚡)

- The error in question interrupts or stops running operation and has a direct effect on the outputs. The response of the outputs (failsafe mode) can be defined by means of functions in the function matrix.
- Displayed as → Lightning flash (⚡), type of error (S: system error, P: process error)



Note!

- Error conditions can be output via the relay outputs or fieldbus communication.
- If an error message occurs, an upper or lower signal level for the breakdown information according to NAMUR recommendation NE 43 can be output via the current output.

### 6.3.3 Confirming error messages

For the sake of plant and process safety, the measuring device can be configured in such a way that fault messages displayed (⚡) always have to be rectified and acknowledged locally by pressing [E]. Only then do the error messages disappear from the display. This option can be switched on or off by means of the "ACKNOWLEDGE FAULT MESSAGES" function (→ "Description of Device Parameters" manual).



Note!

- Fault messages (⚡) can also be reset and confirmed via the status input.
- Notice messages (!) do not require acknowledgment. Note, however, that they remain visible until the cause of the error has been rectified.

## 6.4 Communication

In addition to local operation, the measuring device can be configured and measured values can be obtained by means of the HART protocol. Digital communication takes place using the 4 to 20 mA current output HART → [E] 20.

The HART protocol allows the transfer of measuring and device data between the HART master and the field devices for configuration and diagnostics purposes.

The HART master, e.g. a handheld terminal or PC-based operating programs (such as FieldCare), require device description (DD) files which are used to access all the information in a HART device. Information is exclusively transferred using so-called "commands".

There are three different command groups:

#### ■ Universal Commands

These are associated with the following functionalities for example: Universal commands are supported and used by all HART devices.

- Recognizing HART devices
- Reading digital measured values (volume flow, totalizer etc.)

#### ■ Common Practice Commands

Common practice commands offer functions which are supported and can be executed by most but not all field devices.

#### ■ Device-specific Commands

These commands allow access to device-specific functions which are not HART standard. Such commands access individual field device information, amongst other things, such as empty/full pipe calibration values, low flow cut off settings etc.



Note!

The measuring device has access to all three command classes.

List of all "Universal Commands" and "Common Practice Commands": → [E] 31.

### 6.4.1 Operating options

For the complete operation of the measuring device, including device-specific commands, there are DD files available to the user to provide the following operating aids and programs:



Note!

- In the CURRENT RANGE function (current output 1), the HART protocol demands the setting "4-20 mA HART" or "4-20 mA (25 mA) HART".
- HART write protection can be disabled or enabled by means of a jumper on the I/O board → 39.

#### HART handheld terminal Field Xpert

Selecting device functions with a HART Communicator is a process involving a number of menu levels and a special HART function matrix.

The HART manual in the carrying case of the HART Communicator contains more detailed information on the device.

#### Operating program "FieldCare"

FieldCare is Endress+Hauser's FDT-based plant asset management tool and allows the configuration and diagnosis of intelligent field devices. By using status information, you also have a simple but effective tool for monitoring devices. The Proline flowmeters are accessed via a HART interface FXA 195 or via the service interface FXA193.

### 6.4.2 Current device description files

The following table illustrates the suitable device description file for the operating tool in question and then indicates where these can be obtained.

HART protocol:

<b>Valid for software:</b>	3.01.00	→ Function DEVICE SOFTWARE
<b>Device data HART</b>		
Manufacturer ID:	11 <sub>hex</sub> (ENDRESS+HAUSER)	→ Function MANUFACT ID
Device ID:	55 <sub>hex</sub>	→ Function DEVICE ID
<b>HART version data:</b>	Device Revision 8 / DD Revision 1	
<b>Software release:</b>	01.2010	
<b>Operating program:</b>	<b>Sources for obtaining device descriptions:</b>	
Field Xpert handheld terminal	<ul style="list-style-type: none"> <li>■ Use update function of handheld terminal</li> </ul>	
Fieldcare / DTM	<ul style="list-style-type: none"> <li>■ <a href="http://www.endress.com">www.endress.com</a> (→ Download →Software →Driver)</li> <li>■ CD-ROM (Endress+Hauser order number 56004088)</li> </ul>	

### 6.4.3 Device and process variables

#### Device variables

The following device variables are available using the HART protocol:

Code (decimal)	Device variable	Code (decimal)	Device variable
0	OFF (unassigned)	8	Reference density
2	Mass flow	9	Temperature
5	Volume flow	250	Totalizer 1
6	Corrected volume flow	251	Totalizer 2
7	Density	252	Totalizer 3

#### Process variables

At the factory, the process variables are assigned to the following device variables:

- Primary process variable (PV) → Mass flow
- Secondary process variable (SV) → Totalizer 1
- Third process variable (TV) → Density
- Fourth process variable (FV) → Temperature



Note!





You can set or change the assignment of device variables to process variables using Command 51 → 35.

### 6.4.4 Universal/Common practice HART commands

#### Universal Commands



Command No. HART command / Access type	Command data (numeric data in decimal form)	Response data (numeric data in decimal form)
0 Read unique device identifier Access type = read	none	<p>Device identification delivers information on the device and the manufacturer. It cannot be changed.</p> <p>The response consists of a 12-byte device ID:</p> <ul style="list-style-type: none"> <li>- Byte 0: Fixed value 254</li> <li>- Byte 1: Manufacturer ID, 17 = Endress+Hauser</li> <li>- Byte 2: Device type ID, e.g. 85 = CNGmass DCI</li> <li>- Byte 3: Number of preambles</li> <li>- Byte 4: Universal commands rev. no.</li> <li>- Byte 5: Device-spec. commands rev. no.</li> <li>- Byte 6: Software revision</li> <li>- Byte 7: Hardware revision</li> <li>- Byte 8: Additional device information</li> <li>- Byte 9-11: Device identification</li> </ul>
1 Read primary process variable Access type = read	none	<ul style="list-style-type: none"> <li>- Byte 0: HART unit code of the primary process variable</li> <li>- Bytes 1-4: Primary process variable</li> </ul> <p><i>Factory setting:</i> Primary process variable = Mass flow</p> <p> Note!</p> <ul style="list-style-type: none"> <li>■ You can set the assignment of device variables to process variables using Command "51".</li> <li>■ Manufacturer-specific units are represented using the HART unit code "240".</li> </ul>

## Universal Commands







Command No. HART command / Access type	Command data (numeric data in decimal form)	Response data (numeric data in decimal form)
2 Read the primary process variable as current in mA and percentage of the set measuring range Access type = read	none	<ul style="list-style-type: none"> <li>- Bytes 0-3: Actual current of the primary process variable in mA</li> <li>- Bytes 4-7: Percentage of the set measuring range</li> </ul> <p><i>Factory setting:</i> Primary process variable = Mass flow</p> <p> <b>Note!</b> You can set the assignment of device variables to process variables using Command "51".</p>
3 Read the primary process variable as current in mA and four (preset using Command 51) dynamic process variables Access type = read	none	<p>24 bytes are sent as a response:</p> <ul style="list-style-type: none"> <li>- Bytes 0-3: Primary process variable current in mA</li> <li>- Byte 4: HART unit code of the primary process variable</li> <li>- Bytes 5-8: Primary process variable</li> <li>- Byte 9: HART unit code of the second process variable</li> <li>- Bytes 10-13: Second process variable</li> <li>- Byte 14: HART unit code of the third process variable</li> <li>- Bytes 15-18: Third process variable</li> <li>- Byte 19: HART unit code of the fourth process variable</li> <li>- Bytes 20-23: Fourth process variable</li> </ul> <p><i>Factory setting:</i></p> <ul style="list-style-type: none"> <li>■ Primary process variable = Mass flow</li> <li>■ Second process variable = Totalizer 1</li> <li>■ Third process variable = Density</li> <li>■ Fourth process variable = Temperature</li> </ul> <p> <b>Note!</b></p> <ul style="list-style-type: none"> <li>■ You can set the assignment of device variables to process variables using Command "51".</li> <li>■ Manufacturer-specific units are represented using the HART unit code "240".</li> </ul>
6 Set HART short form address Access type = write	<p>Byte 0: desired address (0 to 15)</p> <p><i>Factory setting:</i> 0</p> <p> <b>Note!</b> With an address &gt;0 (multidrop mode), the current output of the primary process variable is set to 4 mA.</p>	Byte 0: active address
11 Read unique device identification using the TAG (measuring point designation) Access type = read	Bytes 0-5: TAG	<p>Device identification delivers information on the device and the manufacturer. It cannot be changed.</p> <p>The response consists of a 12-byte device ID if the given TAG agrees with the one saved in the measuring device:</p> <ul style="list-style-type: none"> <li>- Byte 0: Fixed value 254</li> <li>- Byte 1: Manufacturer ID, 17 = Endress+Hauser</li> <li>- Byte 2: Device type ID, 85 = CNGmass DCI</li> <li>- Byte 3: Number of preambles</li> <li>- Byte 4: Universal commands rev. no.</li> <li>- Byte 5: Device-spec. commands rev. no.</li> <li>- Byte 6: Software revision</li> <li>- Byte 7: Hardware revision</li> <li>- Byte 8: Additional device information</li> <li>- Byte 9-11: Device identification</li> </ul>
12 Read user message Access type = read	none	<p>Bytes 0-24: User message</p> <p> <b>Note!</b> You can write the user message using Command "17".</p>







## Universal Commands

Command No. HART command / Access type		Command data (numeric data in decimal form)	Response data (numeric data in decimal form)
13	Read TAG, descriptor and date Access type = read	none	<ul style="list-style-type: none"> <li>- Bytes 0-5: TAG</li> <li>- Bytes 6-17: Descriptor</li> <li>- Byte 18-20: Date</li> </ul> <p> Note! You can write the TAG, descriptor and date using Command "18".</p>
14	Read sensor information on primary process variable	none	<ul style="list-style-type: none"> <li>- Bytes 0-2: Sensor serial number</li> <li>- Byte 3: HART unit code of sensor limits and measuring range of the primary process variable</li> <li>- Bytes 4-7: Upper sensor limit</li> <li>- Bytes 8-11: Lower sensor limit</li> <li>- Bytes 12-15: Minimum span</li> </ul> <p> Note!</p> <ul style="list-style-type: none"> <li>■ Die The data relate to the primary process variable (= Mass flow).</li> <li>■ Manufacturer-specific units are represented using the HART unit code "240".</li> </ul>
15	Read output information of primary process variable Access type = read	none	<ul style="list-style-type: none"> <li>- Byte 0: Alarm selection ID</li> <li>- Byte 1: Transfer function ID</li> <li>- Byte 2: HART unit code for the set measuring range of the primary process variable</li> <li>- Bytes 3-6: Upper range, value for 20 mA</li> <li>- Bytes 7-10: Start of measuring range, value for 4 mA</li> <li>- Bytes 11-14: Attenuation constant in [s]</li> <li>- Byte 15: Write protection ID</li> <li>- Byte 16: OEM manufacturer ID, 17 = Endress+Hauser</li> </ul> <p><i>Factory setting:</i> Primary process variable = Mass flow</p> <p> Note!</p> <ul style="list-style-type: none"> <li>■ You can set the assignment of device variables to process variables using Command "51".</li> <li>■ Manufacturer-specific units are represented using the HART unit code "240".</li> </ul>
16	@Read the device production number Access type = read	none	Bytes 0-2: Production number
17	Write user message Access = write	You can save any 32-character long text in the device under this parameter: Bytes 0-23: Desired user message	Displays the current user message in the device: Bytes 0-23: Current user message in the device
18	Write TAG, descriptor and date Access = write	With this parameter, you can store an 8 character TAG, a 16 character descriptor and a date: <ul style="list-style-type: none"> <li>- Bytes 0-5: TAG</li> <li>- Bytes 6-17: Descriptor</li> <li>- Byte 18-20: Date</li> </ul>	Displays the current information in the device: <ul style="list-style-type: none"> <li>- Bytes 0-5: TAG</li> <li>- Bytes 6-17: Descriptor</li> <li>- Byte 18-20: Date</li> </ul>

## Common Practice Commands

Command No. HART command / Access type	Command data (numeric data in decimal form)	Response data (numeric data in decimal form)	
34	Write damping value for primary process variable Access = write	Bytes 0-3: Damping value of the primary process variable in seconds  <i>Factory setting:</i> Primary process variable = Mass flow	Displays the current damping value in the device: Bytes 0-3: Damping value in seconds
35	Write measuring range of primary process variable Access = write	Write the desired measuring range: – Byte 0: HART unit code of the primary process variable – Bytes 1-4: End of measuring range, value for 20 mA – Bytes 5-8: Start of measuring range, value for 4 mA  <i>Factory setting:</i> Primary process variable = Mass flow  Note! ▪ You can set the assignment of device variables to process variables using Command "51". ▪ If the HART unit code is not the correct one for the process variable, the device will continue with the last valid unit.	The currently set measuring range is displayed as a response: – Byte 0: HART unit code for the set measuring range of the primary process variable – Bytes 1-4: Upper range, value for 20 mA – Bytes 5-8: Start of measuring range, value for 4 mA   Note! Manufacturer-specific units are represented using the HART unit code "240".
38	Device status reset (Configuration changed) Access = write	none	none
40	Simulate output current of primary process variable Access = write	Simulation of the desired output current of the primary process variable. An entry value of 0 exits the simulation mode: Byte 0-3: Output current in mA  <i>Factory setting:</i> Primary process variable = Mass flow  Note! You can set the assignment of device variables to process variables with Command "51".	The momentary output current of the primary process variable is displayed as a response: Byte 0-3: Output current in mA
42	Perform master reset Access = write	none	none
44	Write unit of primary process variable Access = write	Set unit of primary process variable. Only unit which are suitable for the process variable are transferred to the device: Byte 0: HART unit code  <i>Factory setting:</i> Primary process variable = Mass flow  Note! ▪ If the written HART unit code is not the correct one for the process variable, the device will continue with the last valid unit. ▪ If you change the unit of the primary process variable, this has no impact on the system units.	The current unit code of the primary process variable is displayed as a response: Byte 0: HART unit code   Note! Manufacturer-specific units are represented using the HART unit code "240".
48	Read additional device status Access = read	none	The device status is displayed in extended form as the response: Coding: → table →  36

Common Practice Commands

Command No. HART command / Access type		Command data (numeric data in decimal form)	Response data (numeric data in decimal form)
50	Read assignment of the device variables to the four process variables Access = read	none	<p>Display of the current variable assignment of the process variables:</p> <ul style="list-style-type: none"> <li>- Byte 0: Device variable code to the primary process variable</li> <li>- Byte 1: Device variable code to the second process variable</li> <li>- Byte 2: Device variable code to the third process variable</li> <li>- Byte 3: Device variable code to the fourth process variable</li> </ul> <p><i>Factory setting:</i></p> <ul style="list-style-type: none"> <li>■ Primary process variable: Code 1 for mass flow</li> <li>■ Second process variable: Code 250 for totalizer 1</li> <li>■ Third process variable: Code 7 for density</li> <li>■ Fourth process variable: Code 9 for temperature</li> </ul> <p> Note! You can set the assignment of device variables to process variables with Command "51".</p>
51	Write assignments of the device variables to the four process variables Access = write	<p>Setting of the device variables to the four process variables:</p> <ul style="list-style-type: none"> <li>- Byte 0: Device variable code to the primary process variable</li> <li>- Byte 1: Device variable code to the second process variable</li> <li>- Byte 2: Device variable code to the third process variable</li> <li>- Byte 3: Device variable code to the fourth process variable</li> </ul> <p><i>Code of the supported device variables:</i> → Data →  31</p> <p><i>Factory setting:</i></p> <ul style="list-style-type: none"> <li>■ Primary process variable = Mass flow</li> <li>■ Second process variable = Totalizer 1</li> <li>■ Third process variable = Density</li> <li>■ Fourth process variable = Temperature</li> </ul>	<p>The variable assignment of the process variables is displayed as a response:</p> <ul style="list-style-type: none"> <li>- Byte 0: Device variable code to the primary process variable</li> <li>- Byte 1: Device variable code to the second process variable</li> <li>- Byte 2: Device variable code to the third process variable</li> <li>- Byte 3: Device variable code to the fourth process variable</li> </ul>
53	Write device variable unit Access = write	<p>This command sets the unit of the given device variables. Only those units which suit the device variable are transferred:</p> <ul style="list-style-type: none"> <li>- Byte 0: Device variable code</li> <li>- Byte 1: HART unit code</li> </ul> <p><i>Code of the supported device variables:</i> → Data →  31</p> <p> Note!</p> <ul style="list-style-type: none"> <li>■ If the written unit is not the correct one for the device variable, the device will continue with the last valid unit.</li> <li>■ If you change the unit of the device variable, this has no impact on the system units.</li> </ul>	<p>The current unit of the device variables is displayed in the device as a response:</p> <ul style="list-style-type: none"> <li>- Byte 0: Device variable code</li> <li>- Byte 1: HART unit code</li> </ul> <p> Note! Manufacturer-specific units are represented using the HART unit code "240".</p>
59	Write number of preambles in response message Access = write	<p>This parameter sets the number of preambles which are inserted in the response messages: Byte 0: Number of preambles (2 to 20)</p>	<p>As a response, the current number of the preambles is displayed in the response message: Byte 0: Number of preambles</p>

### 6.4.5 Device status/Error messages

You can read the extended device status, in this case, current error messages, via Command "48". The command delivers bit-encoded information (→ table below).



Note!

For a detailed explanation of the device status and error messages and their elimination, see → 63

Byte-bit	Error No.	Short error description →  62
0-0	001	Serious device error
0-1	011	Measuring amplifier has faulty EEPROM
0-2	012	Error when accessing data of the measuring amplifier EEPROM
1-1	031	S-DAT: Defective or missing
1-2	032	S-DAT: Error accessing saved values
1-3	041	T-DAT: Defective or missing
1-4	042	T-DAT: Error accessing saved values
1-5	051	I/O board and the amplifier board are not compatible.
3-3	111	Totalizer checksum error
3-4	121	I/O board and the amplifier board (software versions) are not compatible.
3-6	205	T-DAT: Data download not successful
3-7	206	T-DAT: Data upload not successful
4-3	251	Internal communication fault on the amplifier board.
4-4	261	No data reception between amplifier and I/O board
5-7	339	Flow buffer: The temporarily buffered flow portions (measuring mode for pulsating flow) could not be cleared or output within 60 seconds.
6-0	340	
6-1	341	
6-2	342	
6-3	343	Frequency buffer: The temporarily buffered flow portions (measuring mode for pulsating flow) could not be cleared or output within 60 seconds.
6-4	344	
6-5	345	
6-6	346	
6-7	347	Pulse buffer: The temporarily buffered flow portions (measuring mode for pulsating flow) could not be cleared or output within 60 seconds.
7-0	348	
7-1	349	
7-2	350	

Byte-bit	Error No.	Short error description → 62
7-3	351	Current output: The actual value for the flow lies outside the set limits.
7-4	352	
7-5	353	
7-6	354	
7-7	355	Frequency output: The actual value for the flow lies outside the set limits.
8-0	356	
8-1	357	
8-2	358	Pulse output: Pulse output frequency is out of range.
8-3	359	
8-4	360	
8-5	361	
8-6	362	The measuring tube oscillation frequency is outside the permitted range.
9-0	379	
9-1	380	The temperature sensor on the measuring tube is likely defective.
9-2	381	
9-3	382	
9-4	383	The temperature sensor on the carrier tube is likely defective.
9-5	384	
9-6	385	One of the measuring tube coils (on the inlet or outlet side) is probably defective.
9-7	386	
10-0	387	Amplifier error
10-1	388	
10-2	389	
10-3	390	Max. permitted batching time has been exceeded.
11-6	471	
11-7	472	Underbatching: the minimum quantity was not reached. Overbatching: the maximum permitted batching quantity was exceeded.
12-0	473	The predefined batch quantity point was exceeded. End of filling process approaching.
12-1	474	Maximum flow value entered is overshoot.
12-7	501	New amplifier software version is loaded. Currently no other commands are possible.
13-0	502	Upload and download of device files. Currently no other commands are possible.
13-2	571	Batching process in progress (valves are open)
13-3	572	Batching process has been stopped (valves are closed)
13-5	586	The fluid properties do not allow normal measuring operation.
13-6	587	Extreme process conditions exist. The measuring system can therefore not be started.
13-7	588	Overdriving of the internal analog to digital converter. A continuation of the measurement is no longer possible.
14-3	601	Positive zero return active

Byte-bit	Error No.	Short error description → 62
14-7	611	Simulation current output active
15-0	612	
15-1	613	
15-2	614	
15-3	621	Simulation frequency output active
15-4	622	
15-5	623	
15-6	624	
15-7	631	Simulation pulse output active
16-0	632	
16-1	633	
16-2	634	
16-3	641	Simulation status output active
16-4	642	
16-5	643	
16-6	644	
16-7	651	Simulation relay output active
17-0	652	
17-1	653	
17-2	654	
17-3	661	Simulation current input active
17-4	662	
17-5	663	
17-6	664	
17-7	671	Simulation status input active
18-0	672	
18-1	673	
18-2	674	
18-3	691	Simulation of response to error (outputs) active
18-4	692	Simulation of volume flow active
19-0	700	The process fluid density is outside the upper or lower limit values set in the "EPD" function
19-1	701	The maximum current value for the measuring tube exciter coils has been reached, since certain process fluid characteristics are extreme.
19-2	702	Frequency control is not stable, due to inhomogeneous fluid.
19-3	703	NOISE LIM. CH0 Overdriving of the internal analog to digital converter. A continuation of the measurement is still possible.
19-4	704	NOISE LIM. CH1 Overdriving of the internal analog to digital converter. A continuation of the measurement is still possible.
19-5	705	The electronics' measuring range will be exceeded. The mass flow is too high.
20-5	731	The zero point adjustment is not possible or has been canceled.
22-4	61	F-Chip is faulty or not plugged into the I/O board.
24-5	363	Current input: The actual value for the current lies outside the set limits.

### 6.4.6 Switching HART write protection on and off

A jumper on the I/O board provides the means of switching HART write protection on or off.



**Warning!**

Risk of electric shock. Exposed components carry dangerous voltages. Make sure that the power supply is switched off before you remove the cover of the electronics compartment.

1. Switch off power supply.
2. Remove the I/O board → 71 or → 73.
3. Switch HART write protection on or off, as applicable, by means of the jumper (→ 21).
4. Installation of the I/O board is the reverse of the removal procedure.

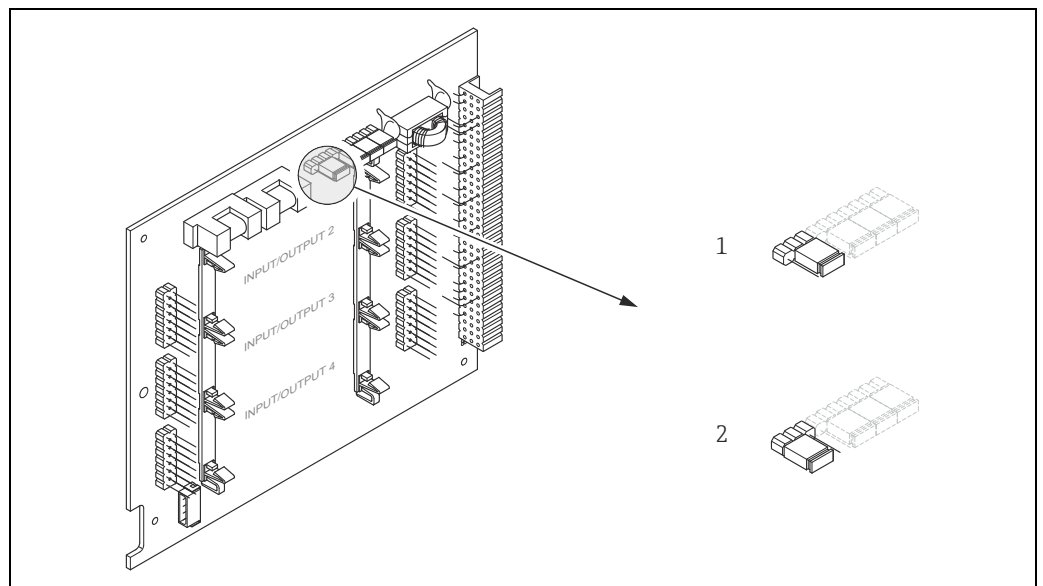

Fig. 21: Switching HART write protection on and off

- 1 Write protection OFF (default), that is: HART protocol unlocked
- 2 Write protection ON, that is: HART protocol locked

## 7 Commissioning

### 7.1 Function check

Make sure that all the final checks have been completed before commissioning the measuring point:

- Checklist for "Post-installation check" →  15.
- Checklist for "Post-connection check" →  22.

### 7.2 Switching on the measuring device

If the post-connection checks have been performed, the supply voltage can be switched on. The device is now operational.

The measuring device performs a number of power on self-tests. As this procedure progresses the following sequence of messages appears on the local display:

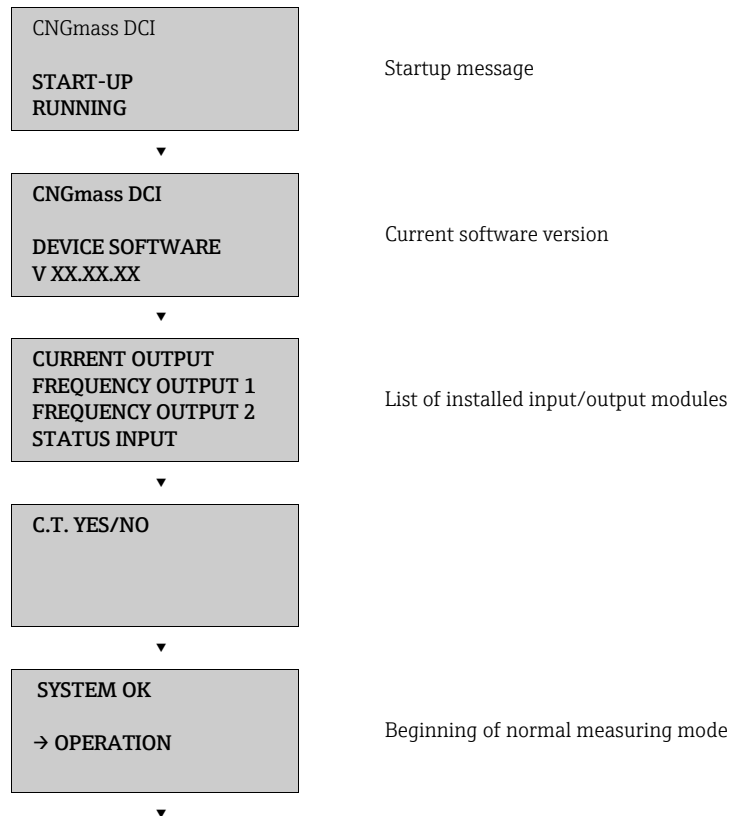

Normal measuring mode commences as soon as startup completes. Various measured value and/or status variables appear on the display (HOME position).





Note!  
If startup fails, an error message indicating the cause is displayed.



## 7.3 Quick Setup

In the case of measuring devices without a local display, the individual parameters and functions must be configured via the configuration program, e.g. FieldCare. If the measuring device is equipped with a local display, all the important device parameters for standard operation can be configured quickly and easily by means of the "Commissioning" Quick Setup menu.

- Quick Setup "Commissioning", see below
- Quick Setup "Pulsating Flow" →  43
- Quick Setup "Gas measurement" →  46

### 7.3.1 Quick Setup "Commissioning"



Note!

- The display returns to the function SETUP COMMISSIONING (1002) if you press the  key combination during parameter interrogation. The stored parameters remain valid.
- The "COMMISSIONING" Quick Setup must be performed before another Quick Setup is run.

- 1 The "DELIVERY SETTINGS" option sets every selected unit to the factory setting. The "ACTUAL SETTING" option accepts the units you previously configured.
- 2 Only units not yet configured in the ① current Setup are offered for selection in each cycle. The unit for mass, volume and corrected volume is derived from the corresponding flow unit.
- 3 The "YES" option remains visible until all the units have been configured. "NO" is the only option displayed when no further units are available.
- 4 The prompt only appears if a current and/ or pulse/frequency output is available. Only the outputs not yet configured in the current Setup are offered for selection in each cycle.
- 5 The "YES" option remains visible until all the outputs have been configured. "NO" is the only option displayed when no further outputs are available.
- 6 The "automatic parameterization of the display" option contains the following basic settings/factory settings:
 

YES	Main line = Mass flow
	Additional line = Totalizer 1
	Information line = Operating/system conditions
NO	The existing (selected) settings remain.
- 7 The process for executing other Quick Setups is described in the following chapters.

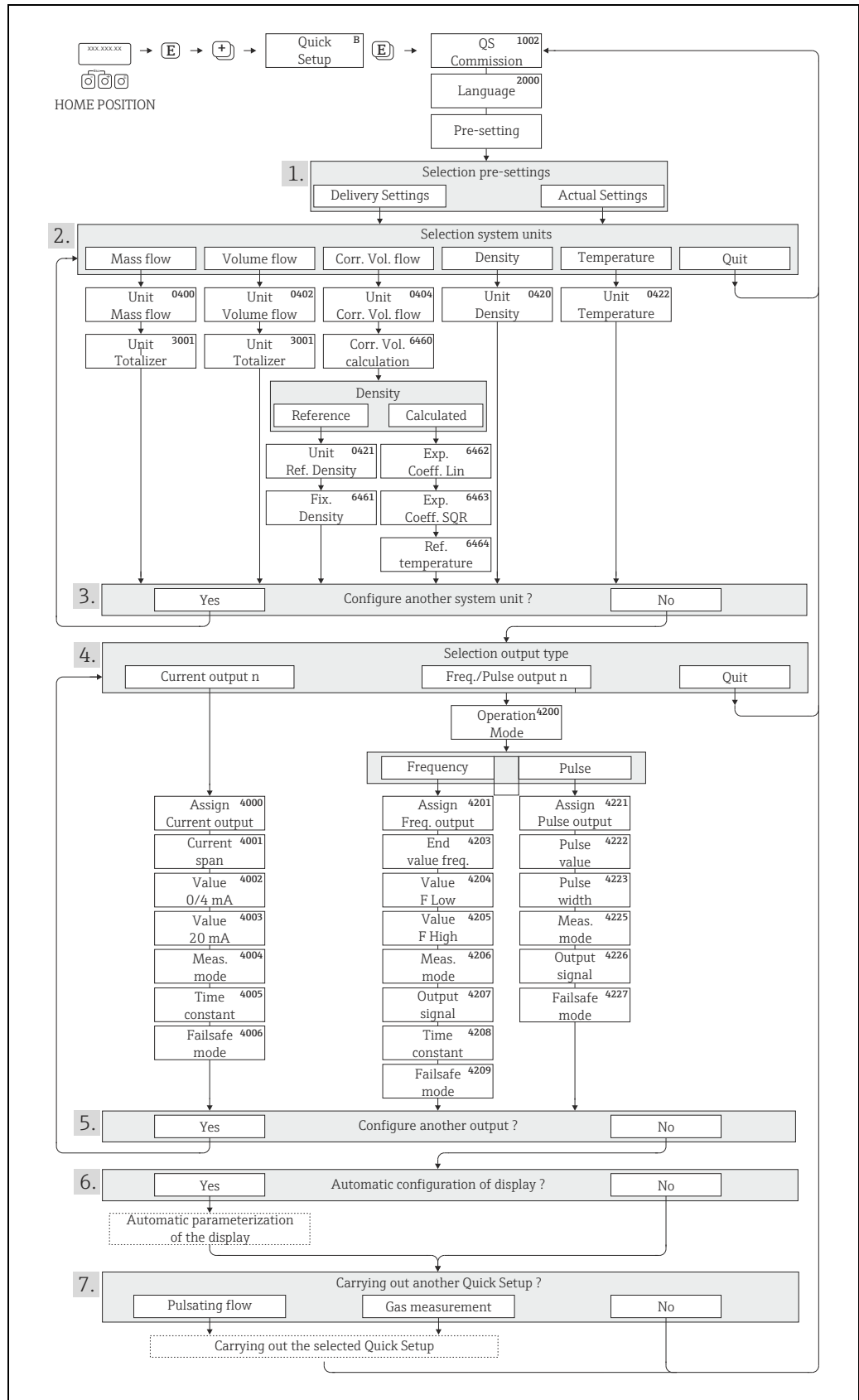

A0011949-EN

Fig. 22: Quick Setup for quick commissioning

### 7.3.2 Quick Setup "Pulsating Flow"



Note!

The "Pulsating Flow" Quick Setup is only available if the device has a current output or a pulse/ frequency output.

Certain types of pump such as reciprocating, peristaltic and cam-type pumps, for example, create a flow characterized by severe periodic fluctuations. Negative flows can occur with pumps of these types on account of the closing volume of the valves or valve leaks.



Note!

Before carrying out the Quick Setup "Pulsating Flow", the Quick Setup "Commissioning" has to be executed, → 41.

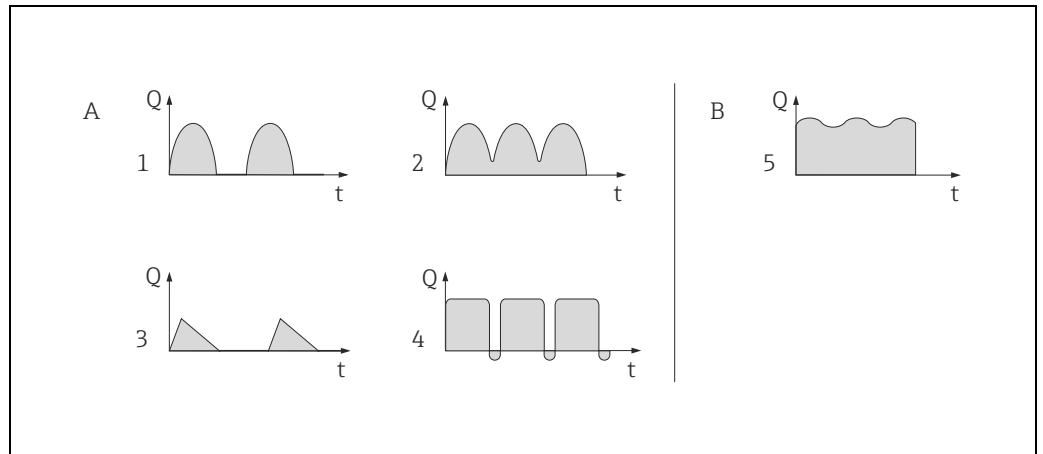

Fig. 23: Flow characteristics of various types of pump

A With severely pulsating flow  
B With low pulsating flow

- 1 1-cylinder cam pump
- 2 2-cylinder cam pump
- 3 Magnetic pump
- 4 Peristaltic pump, flexible connecting hose
- 5 Multi-cylinder reciprocating pump

#### Severely pulsating flow

Once several device functions have been configured in the "Pulsating flow" Quick Setup menu, flow fluctuations of this nature can be compensated over the entire flow range and pulsating fluid flows measured correctly. You will find detailed instructions on how to use this Quick Setup in the following section.



Note!

It is always advisable to work through the "Pulsating flow" Quick Setup menu if there is any uncertainty about the exact flow characteristic.

#### Slightly pulsating flow

If flow fluctuations are no more than minor, as is the case, for example with gear-type, three-cylinder or multi-cylinder pumps, it is **not** absolutely necessary to work through the Quick Setup menu. In cases of this nature, however, it is advisable to adapt the functions listed below in the function matrix (→ "Description of Device Parameters" manual) to suit local process conditions in order to ensure a stable, unvarying output signal:

- Measuring system damping: "FLOW DAMPING" function → Increase value
- Current output damping: "TIME CONSTANT" function → increase the value

## Performing the "Pulsating flow" Quick Setup

This Quick Setup menu guides you systematically through the setup procedure for all the device functions that have to be parameterized and configured for measuring pulsating flows. Note that this has no effect on values configured beforehand, such as measuring range, current range or full scale value.

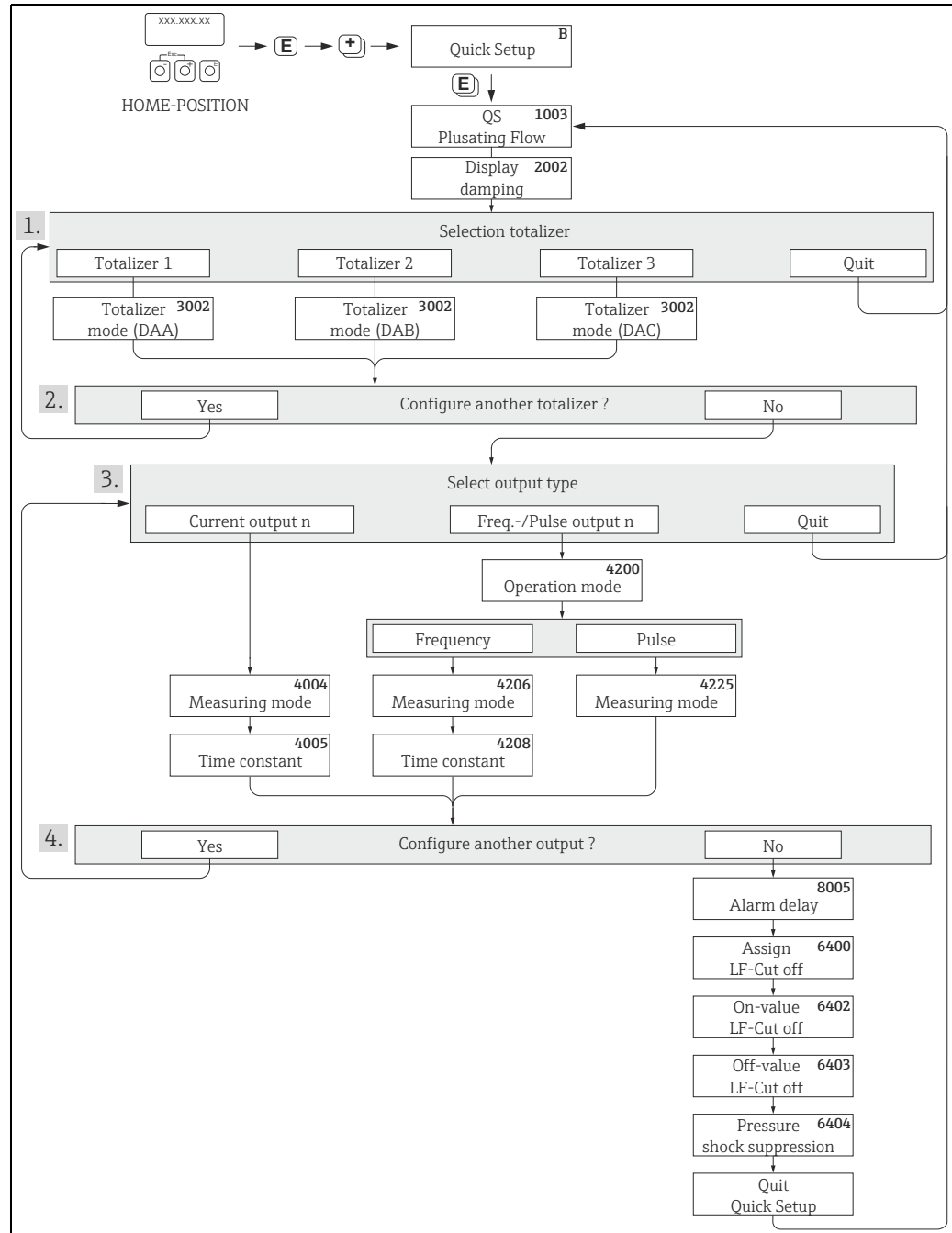

Fig. 24: Quick Setup for measuring severely pulsating flows

- 1 Only totalizers not yet configured in the current Setup are offered for selection in each cycle.
- 2 The "YES" option remains visible until all the totalizers have been configured. "NO" is the only option displayed when no further totalizers are available.
- 3 Only the output not yet configured in the current Setup is offered for selection in the second cycle.
- 4 The "YES" option remains visible until both outputs have been configured. "NO" is the only option displayed when no further outputs are available.



**Note!**

- The display returns to the function QUICK SETUP PULSATING FLOW (1003) if you press the key combination.
- You can call up the Setup menu either directly from the "COMMISSIONING" Quick Setup menu or manually by means of the function QUICK SETUP PULSATING FLOW (1003).

**Recommended settings**

Quick Setup "Pulsating flow"		
HOME position →  → MEASURED VARIABLE →  → QUICK SETUP →  → QS PULSATING FLOW (1003)		
Function No.	Function name	Selection with To next function with
1003	QS PULS. FLOW	YES After  is pressed by way of confirmation, the Quick Setup menu calls up all the subsequent functions in succession.



Basic configuration		
2002	DISPLAY DAMPING	1 s
3002	TOTALIZER MODE (DAA)	BALANCE (Totalizer 1)
3002	TOTALIZER MODE (DAB)	BALANCE (Totalizer 2)
3002	TOTALIZER MODE (DAC)	BALANCE (Totalizer 3)
Signal type for "CURRENT OUTPUT 1 to n"		
4004	MEASURING MODE	PULSATING FLOW
4005	TIME CONSTANT	1 s
Signal type for "FREQ./PULSE OUTPUT 1 to n" (for FREQUENCY mode of operation)		
4206	MEASURING MODE	PULSATING FLOW
4208	TIME CONSTANT	0 s
Signal type for "FREQ./PULSE OUTPUT 1 to n" (for PULSE mode of operation)		
4225	MEASURING MODE	PULSATING FLOW
Other settings		
8005	ALARM DELAY	0 s
6400	ASSIGN LOW FLOW CUTOFF	MASS FLOW
6402	ON-VALUE LOW FLOW CUT OFF	Setting depends on diameter: DN 8 = 2.0 [kg/h] or [l/h] DN 15 = 6.5 [kg/h] or [l/h] DN 25 = 18 [kg/h] or [l/h]
6403	OFF-VALUE LOW FLOW CUTOFF	50%
6404	PRESSURE SHOCK SUPPRESSION	0 s



Back to the HOME position:  
 → Press and hold down Esc key for longer than three seconds or  
 → Repeatedly press and release Esc key → Exit the function matrix step by step

### 7.3.3 Quick Setup "Gas measurement"

The measuring device is not only suitable for measuring liquid flow. Direct mass measurement based on the Coriolis principle is also possible for measuring the flow rate of gases.



Note!

- Before carrying out the Quick Setup "Gas measurement", the Quick Setup "Commissioning" has to be executed → 41.
- Only mass and Corrected volume flow can be measured and output with the gas measurement mode. Note that direct density and/or volume measurement is not possible.
- The flow ranges and measuring accuracy that apply to gas measurement are not the same as those for liquids.
- If corrected volume flow (e.g. in Nm<sup>3</sup>/h) is to be measured and output instead of the mass flow (e.g. in kg/h), change the setting for the CORRECTED VOLUME CALCULATION function to "FIXED REFERENCE DENSITY" in the "Commissioning" Quick Setup menu. Corrected volume flow can be assigned as follows:
  - to a display line,
  - to the current output,
  - to the pulse/frequency output.

#### Performing the "Gas Measurement" Quick Setup

This Quick Setup menu guides you systematically through the setup procedure for all the device functions that have to be parameterized and configured for gas measurement.

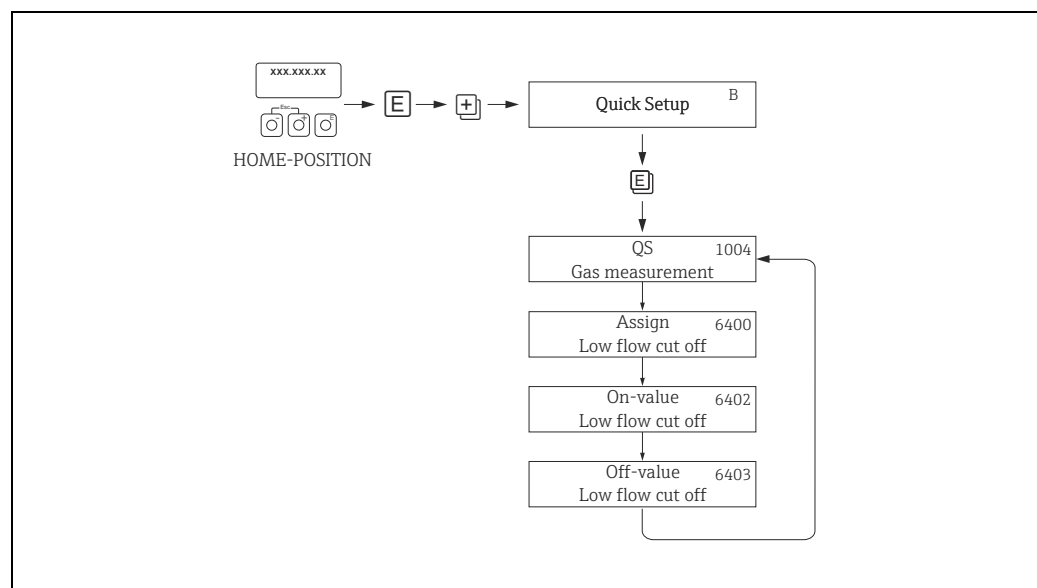









Fig. 25: Quick Setup "Gas measurement"

Recommended settings are found on the following page.

Quick Setup "Gas measurement"		
HOME position →  → MEASURED VARIABLE (A) MEASURED VARIABLE →  → QUICK SETUP (B) QUICK SETUP →  → QS-GAS MEASUREMENT (1004)		
Function No.	Function name	Setting to be selected (  ) (to next function with  )
1004	QS GAS MEASUREMENT	YES After  is pressed by way of confirmation, the Quick Setup menu calls up all the subsequent functions in succession.
▼		
6400	ASSIGN LOW FLOW CUTOFF	On account of the low mass flow involved when gas flows are measured, it is advisable not use a low flow cutoff. Setting: OFF
6402	ON-VALUE LOW FLOW CUT OFF	If the ASSIGNMENT LOW FLOW CUTOFF function was not set to "OFF", the following applies:  Setting: 0.0000 [unit]  User input: Flow rates for gas measurements are low, so the value for the switch-on point (= low flow cutoff) must be correspondingly low.
6403	OFF-VALUE LOW FLOW CUTOFF	If the ASSIGNMENT LOW FLOW CUTOFF function was not set to "OFF", the following applies:  Setting: 50%  User input: Enter the switch-off point as a positive hysteresis in %, referenced to the switch-on point.
▼		
Back to the HOME position: → Press and hold down Esc key  for longer than three seconds or → Repeatedly press and release Esc key  → Exit the function matrix step by step		



#### Note!

Quick Setup automatically deactivates the function EMPTY PIPE DETECTION (6420) so that the device can measure flow at low gas pressures.

### 7.3.4 Data back-up/transfer

You can use the T-DAT SAVE/LOAD function to transfer data (device parameters and settings) between the T-DAT (removable memory) and the EEPROM (device memory).

This is required for the following applications:

- Creating a backup: current data are transmitted from an EEPROM to the T-DAT.
- Replacing a transmitter: current data are copied from an EEPROM to the T-DAT, then transmitted to the EEPROM of the new transmitter.
- Duplicating data: current data are copied from an EEPROM to the T-DAT, then transmitted to EEPROMs of identical measuring points.



Note!

Installing and removing the T-DAT → 71.

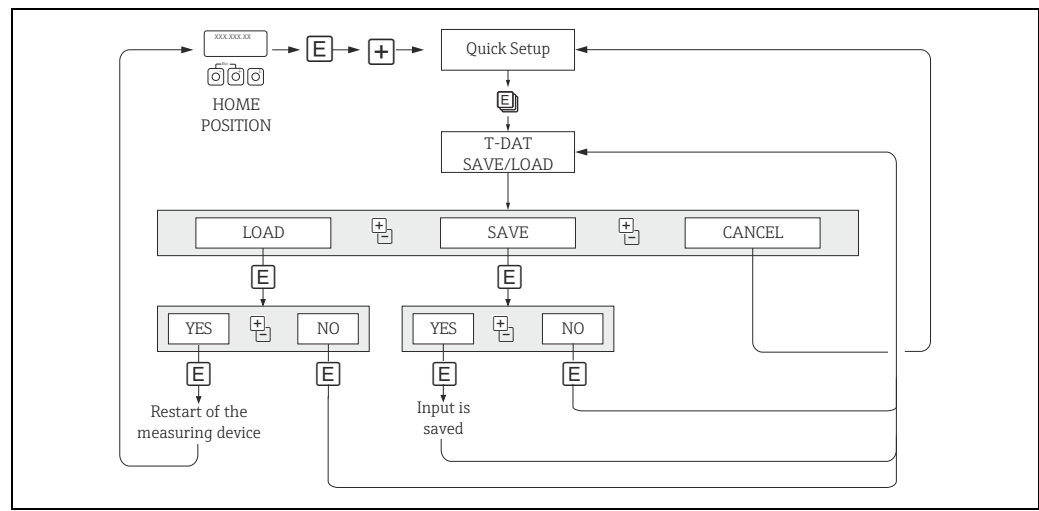

Fig. 26: Data storage/transmission with T-DAT SAVE/LOAD

Notes on the LOAD and SAVE options:

LOAD: Data are transmitted from the T-DAT to the EEPROM.



Note!

- Previously saved settings on the EEPROM are deleted.
- This option is only available if the T-DAT contains valid data.
- This selection can be made only if the software version of the T-DAT is the same or newer than that of the EEPROM. Otherwise, the error message "TRANSM. SW-DAT" appears after the restart and the LOAD function is subsequently no longer available.

SAVE: Data are transmitted from the EEPROM to the T-DAT.



## 7.4 Configuration



Warning!

In the case of explosion-protected equipment, observe a cooling or discharge time of 10 minutes before opening the device.

### 7.4.1 Current output: active/passive

The current outputs are configured as "active" or "passive" by means of various jumpers on the I/O board or the current submodule.



Warning!

Risk of electric shock. Exposed components carry dangerous voltages. Make sure that the power supply is switched off before you remove the cover of the electronics compartment.

1. Switch off power supply.
2. Remove the I/O board → 71.
3. Set the jumpers (→ 29).



Caution!

Risk of destroying the measuring device. Set the jumpers exactly as shown in → 27. Incorrectly set jumpers can cause overcurrents that would destroy either the measuring device or external devices connected to it.

4. Installation of the I/O board is the reverse of the removal procedure.

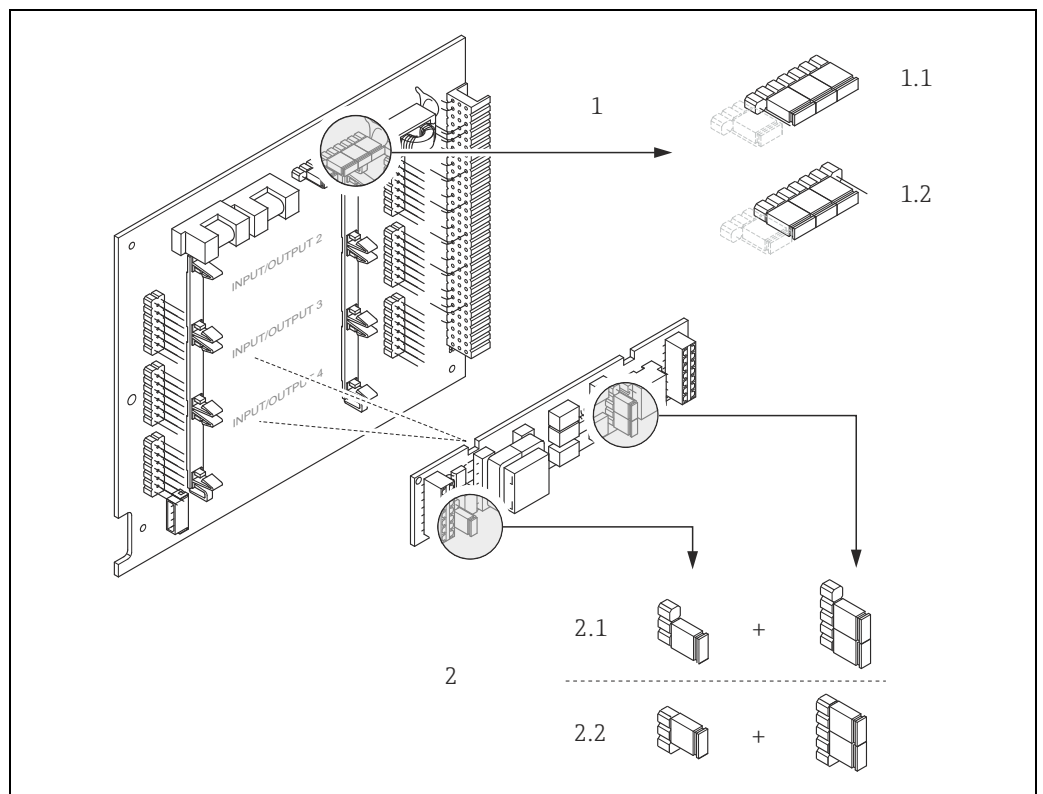

Fig. 27: Configuring current output with the aid of jumpers (I/O board)

- 1 Current output 1 with HART
- 1.1 Active current output (default)
- 1.2 Passive current output
- 2 Current output 2 (optional, plug-in module)
- 2.1 Active current output (default)
- 2.2 Passive current output

## 7.4.2 Pulse/frequency outputs 1 and 2

The configuration of the pulse/frequency outputs with line monitoring "On" or "Off" takes place by means of various jumpers on the pulse/frequency output submodule.



Warning!

Risk of electric shock. Exposed components carry dangerous voltages. Make sure that the power supply is switched off before you remove the cover of the electronics compartment.

1. Switch off power supply.
2. Remove the I/O board → 71.
3. Set the jumpers (→ 29).



Caution!

Risk of destroying the measuring device. Set the jumpers exactly as shown in the diagram. Incorrectly set jumpers can cause overcurrents that would destroy either the measuring device or external devices connected to it.

4. Installation of the I/O board is the reverse of the removal procedure.

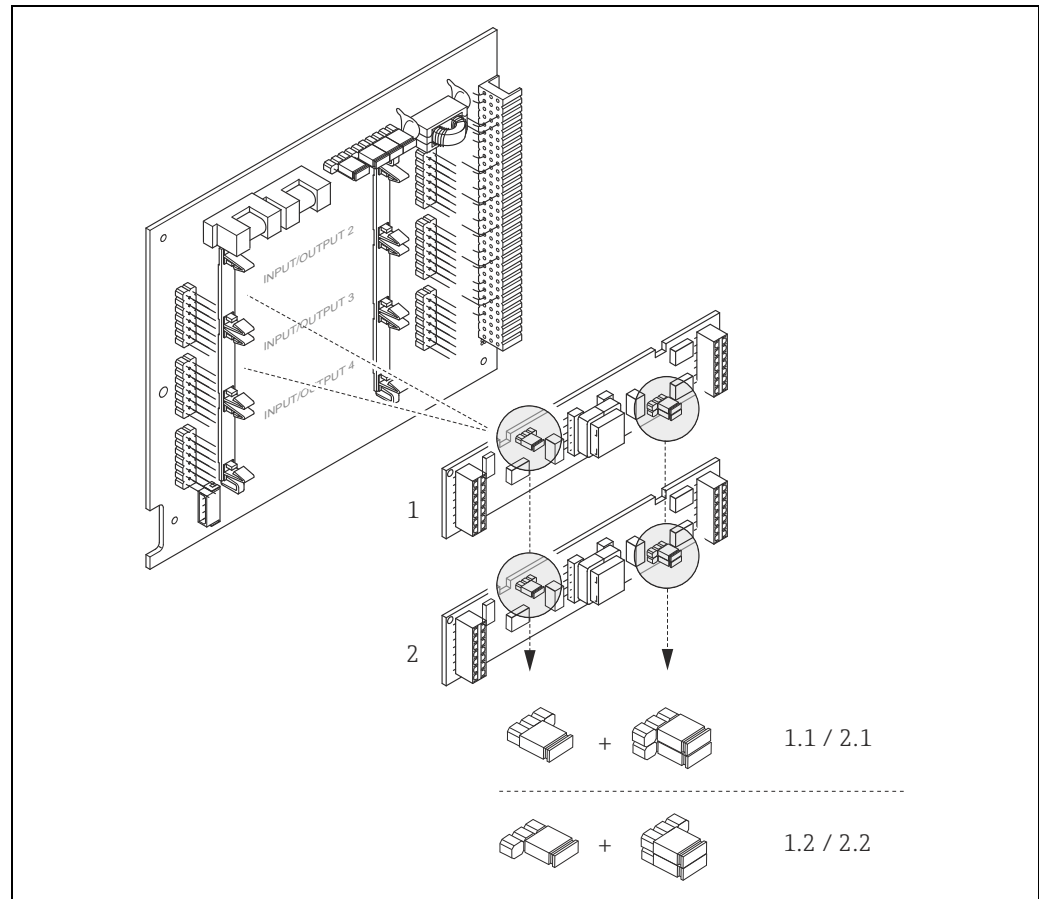

Fig. 28: Configuring pulse/frequency outputs with the aid of jumpers (I/O board)

- |     |                                      |
|-----|--------------------------------------|
| 1   | Pulse/frequency output 1             |
| 1.1 | Line monitoring ON (factory setting) |
| 1.2 | Line monitoring OFF                  |
| 2   | Pulse/frequency output 2             |
| 2.1 | Line monitoring ON (factory setting) |
| 2.2 | Line monitoring OFF                  |

### 7.4.3 Relay contacts: Normally closed/Normally open

The relay contact can be configured as normally open (NO or make) or normally closed (NC or break) contacts by means of two jumpers on the I/O board or on the pluggable submodule. This configuration can be called up at any time with the ACTUAL STATUS RELAY (4740) function.



**Warning!**

Risk of electric shock. Exposed components carry dangerous voltages. Make sure that the power supply is switched off before you remove the cover of the electronics compartment.

1. Switch off power supply.
2. Remove the I/O board → 71.
3. Set the jumpers (→ 29).



**Caution!**

- If you change the setting you must always change the positions of **both** jumpers. Note precisely the specified positions of the jumpers.
- Note that the position of the relay submodule on the I/O board can vary, depending on the version ordered, and that the terminal assignment in the connection compartment of the transmitter varies accordingly → 19.

4. Installation of the I/O board is the reverse of the removal procedure.

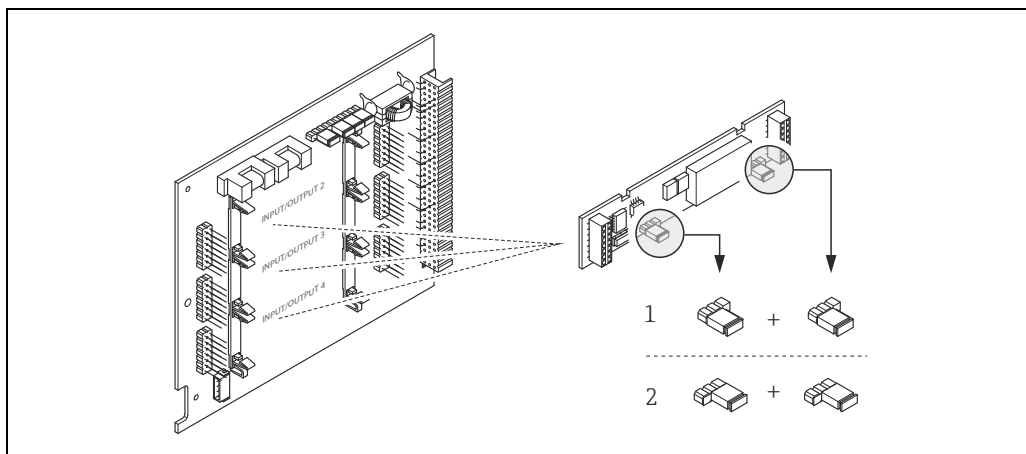

Fig. 29: Configuring relay contacts (NC / NO) using jumpers on the convertible I/O board (submodule).

- 1 Configured as NO contact (default, relay 1)
- 2 Configured as NC contact (default, relay 2, if installed)

## 7.5 Adjustment

### 7.5.1 Zero point adjustment

All measuring devices are calibrated with state-of-the-art technology. Calibration takes place under reference operating conditions → 79. Consequently zero point adjustment is generally **not** necessary for CNGmass DCI.

Experience shows that the zero point adjustment is advisable only in special cases:

- To achieve highest measuring accuracy also with very small flow rates.
- Under extreme process or operating conditions (e.g. very high process temperatures).

#### Preconditions for a zero point adjustment

Note the following before you perform a zero point adjustment:

- Adjustment can only be performed on homogeneous fluids.
- Zero point adjustment is performed at zero flow ( $v = 0 \text{ m/s}$ ). This can be achieved, for example, with shutoff valves upstream and/or downstream of the sensor or by using existing valves and gates.
  - Normal operation → valves 1 and 2 open
  - Zero point adjustment **with** pump pressure → Valve 1 open / valve 2 closed
  - Zero point adjustment **without** pump pressure → Valve 1 closed / valve 2 open

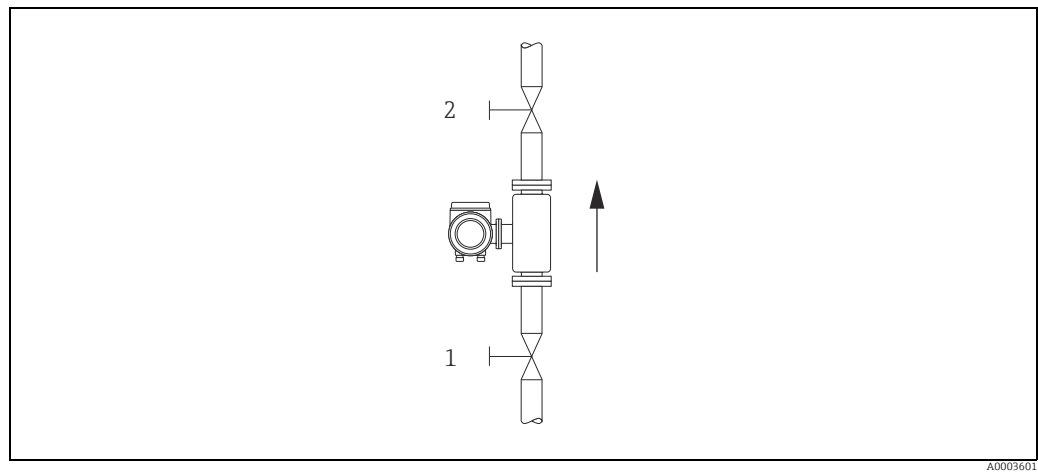

Fig. 30: Zero point adjustment and shutoff valves



#### Caution!

- The currently valid zero point value can be viewed using the "ZEROPOINT" function (→ "Description of Device Parameters" manual).

### Performing a zero point adjustment

1. Operate the system until operating conditions have settled.
2. Stop the flow ( $v = 0$  m/s).
3. Check the shutoff valves for leaks.
4. Check that operating pressure is correct.
5. Using the local display, select the ZEROPOINT ADJUSTMENT function in the function matrix: BASIC FUNCTIONS → PROCESSPARAMETER → ADJUSTMENT → ZERO POINT ADJUSTMENT
6. When you press  $\oplus$  or  $\ominus$  you are automatically prompted to enter the access code if the function matrix is still disabled. Enter the code (factory setting = 84).
7. Use  $\oplus$  or  $\ominus$  to select START and confirm with  $\boxplus$ .  
Select YES at the prompt and press  $\boxplus$  again to confirm.  
Zero point adjustment now starts.
  - The message "ZEROPOINT ADJUST RUNNING" appears on the display for 30 to 60 seconds while adjustment is in progress.
  - If the flow in the pipe exceeds 0.1 m/s, the following error message appears on the display: "ZERO ADJUST NOT POSSIBLE".
  - When the zero point adjustment completes, the "ZERO ADJUST." function reappears on the display.
8. Back to the HOME position:
  - Press and hold down Esc key ( $\text{Esc}$ ) for longer than three seconds or
  - Repeatedly press and release the Esc key ( $\text{Esc}$ ).

## 7.6 Memory (HistoROM)

At Endress+Hauser, the term HistoROM refers to various types of data storage modules on which process and measuring device data are stored. By unplugging and plugging such modules, device configurations can be duplicated onto other measuring devices, to cite just one example.

### 7.6.1 HistoROM/S-DAT (sensor-DAT)

The S-DAT is an exchangeable data storage device in which all sensor relevant parameters are stored, i.e., diameter, serial number, calibration factor, zero point.

### 7.6.2 HistoROM/T-DAT (transmitter-DAT)

The T-DAT is an exchangeable data storage device in which all transmitter parameters and settings are stored.

Storing of specific parameter settings from the EEPROM to the T-DAT and vice versa has to be carried out by the user (= manual save function). Detailed instructions regarding this can be found in the manual "Description of Device Parameters", GP00001D/ (function "T-DAT SAVE/LOAD", No. 1009).

## 8 Custody transfer measurement

CNGmass DCI is a flowmeter that is suitable for custody transfer measurement.

### 8.1 Suitability for custody transfer measurement, approval by the Standards Authorities, repeated calibration due to legal metrology controls

Only once it has been approved by the authority for legal metrology controls may the measuring device be regarded as verified and used for applications subject to legal metrology controls. The associated seal on the measuring device ensures this status.



Caution!

Only flowmeters verified by the Standards Authorities may be used for invoicing in applications subject to legal metrology controls. Country-specific requirements and regulations (such as the German Calibration Law) must be observed.

#### 8.1.1 Approval for custody transfer

The following guidelines for the custody transfer process were developed in accordance with the following authorities for legal metrology controls:

- PTB, Germany
- NMI, The Netherlands
- METAS, Switzerland
- BEV, Austria
- NTEP, USA
- MC, Canada
- Rosstandart, Russia

#### 8.1.2 Special features of working in the custody transfer mode

##### Switching on the power supply in custody transfer mode

If the measuring device is started in custody transfer mode, for example after a power outage, system error No. 271 "POWER BRK. DOWN" flashes on the local display. The fault message can be acknowledged or reset using the "Enter" key or by means of the status input configured accordingly.



Note!

It is not mandatory to reset the fault message for correct operation.

## 8.2 Definition of terms

Terms used in the subject area "suitability for custody transfer measurement for liquids other than water"

Additional devices	Equipment that does not have a direct effect on the measurement but which is needed to ensure correct measuring or make it easier (e.g. gas display units, filters, pumps etc.)
Adjust	Adjustment on site (zero point, density) under operating conditions. Is performed by the facility's owner-operator.
Ancillary equipment	Equipment used for direct further processing of the measurement result (e.g. printers, quantity convertors, price calculators, pre-set devices etc.).
Calibrate	Determine and save correction values for the individual measuring device to get as close as possible to the "real" value with the measured value.
Counter	Device for measuring, saving and displaying the variables subject to mandatory verification (mass, volume, density etc.)
Measured error	(Also known as limit of permissible error, error limit or inaccuracy). Relative measurement error, derived from the quotient (measured value - "true" measured value) : "true" measured value in percent.
Measuring system	Measuring device that includes the counter and all the ancillary equipment and additional devices.
$Q_{max}$	Maximum flow of the counter while observing the error limits.
$Q_{min}$	Minimum flow as of which the counter must observe the error limits.
Quantity convertor	Unit for automatically converting the measured value determined to another variable (pressure, temperature, density etc.) or nonvolatile saved conversion values for the fluid.
Reapproval	Verified measuring devices can be reapproved if they observe the applicable limits of error in legal metrology and meet any other requirements which applied when they were initially verified. The authority responsible provides you with information as to how long the verification is valid.
Repair	Upon request, the authority responsible can give companies that repair verified measuring devices (repairers) the authority to mark repaired devices (repairer mark) if they have the equipment necessary for repair and adjustment and have properly trained specialist staff. Endress+Hauser is authorized to carry out repair work on verified measuring devices.
Stamp points	To be provided on all parts of the measuring system which cannot otherwise be protected against any alteration (=falsification) to measured value determination and processing. Lead stamping is preferably used, but adhesive seals are also permitted. They may only be affixed by an authorized party, namely authority for legal metrology controls or service team with field service mark.
Suitable for custody transfer measurement	A measuring system or a part of the system, for example counters or accessory equipment, has the (type) "approval for national verification" of a (national) approval center.
Verified	The measuring system has been inspected and sealed on site by a representative of the authority for legal metrology controls. This must be arranged by the facility's owner-operator.
Verify	Inspection of a measuring system to determine the measured error from the "true" value with subsequent system sealing. Verification can only be carried out on site by the authority for legal metrology controls responsible.

## 8.3 Verification process

### 8.3.1 Setting up custody transfer mode

The measuring device has to be operational and not set to custody transfer mode.

1. Configure the functions important for custody transfer measurement, such as the output configuration, custody transfer variable and the measuring mode.
  - In the "CUSTODY TRANSFER" block (function block Z; functions Z001 to Z008), the outputs relevant for custody transfer measurement can be set to custody transfer and the current custody transfer status can be displayed.
  - In the "OUTPUTS" block (function block E), the custody transfer variables can be assigned to the existing outputs.
  - In the "INPUTS" block (function block F), a switching behavior is assigned to the input. For NTEP and MC only: The "CUSTODY TRANSFER" block is hidden. All relevant outputs are set to custody transfer.



Note!

Please refer to the separate "Description of Device Parameters" manual for a detailed description of the functions.

2. Once all the functions relevant to custody transfer have been configured, the custody transfer code is entered in the "ACCESS CODE (2020)" cell.

**Custody transfer code: 8400**

The functions are locked once you enter the custody transfer code. These functions are marked with a keyhole symbol (🔒) in the separate "Description of Device Parameters" manual.

3. The lead stamping of the device (→  31).
4. The device is suitable for custody transfer measurement. The flow measurement may now be used in applications subject to legal metrology controls.



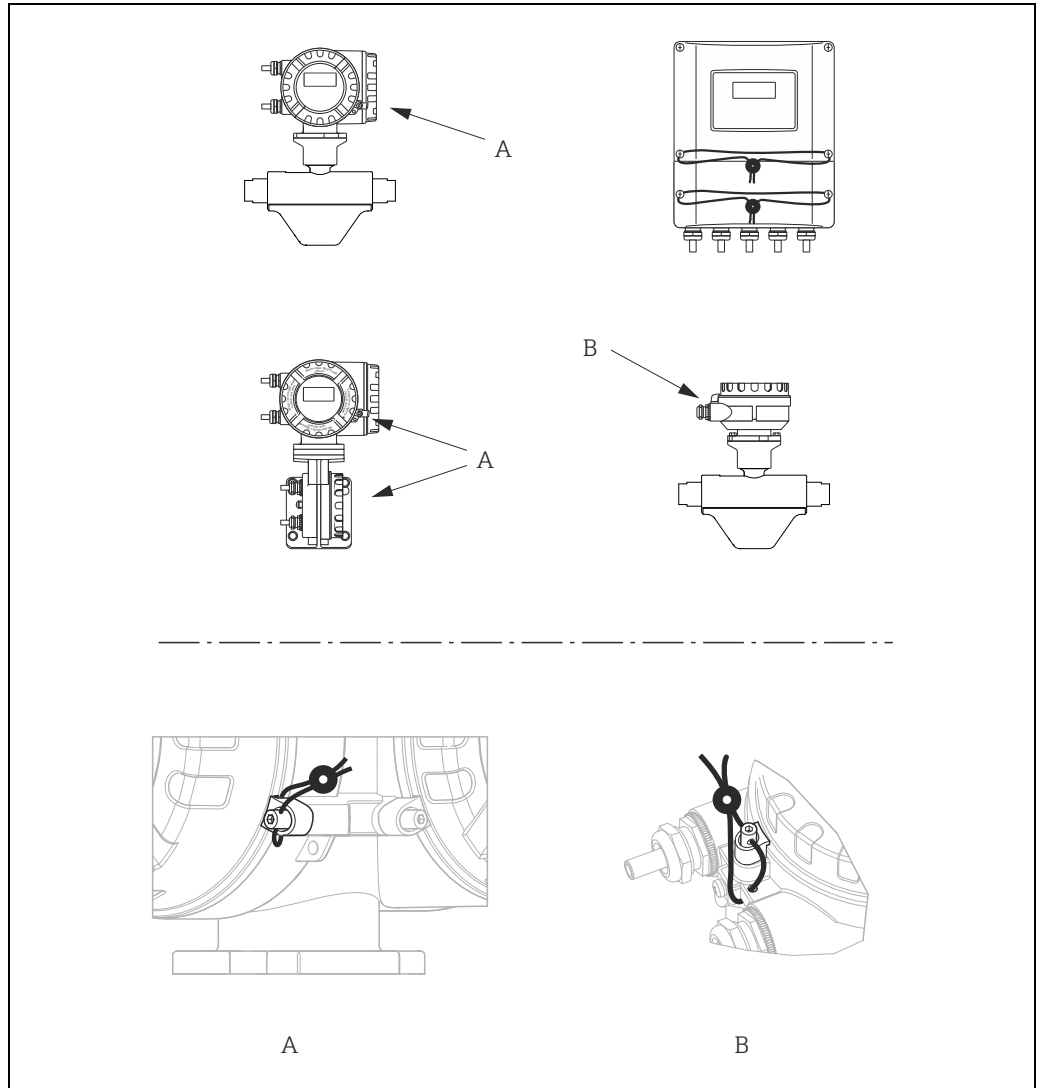

Fig. 31: Examples of how to seal the various device versions.

A0011835

### 8.3.2 Disabling custody transfer mode

The measuring device has to be operational and already set to custody transfer mode.

1. Disconnect the device from the operating voltage.
2. Remove the custody transfer seals.



Warning!

In the case of explosion-protected equipment, observe a cooling or discharge time of 10 minutes before opening the device.

3. Open the cover of the transmitter housing electronics compartment.  
Detailed procedure for the compact version/wall-mount housing →  71.
4. Remove the S-DAT
5. Reconnect the device to the power supply.
6. The device runs through the startup cycle.  
After startup, the error message "#031 SENSOR HW-DAT" is displayed.



Note!

This error message appears because the S-DAT has been removed.  
This does not have any effect on the subsequent steps.

7. Disconnect the device from the power supply again.
8. Reinsert the S-DAT.
9. Screw the covers of the electronics compartment and the display module back on.
10. Reconnect the device to the power supply.
11. The device runs through the startup cycle.  
During startup, the message "CUSTODY TRANSFER NO" appears on the display.
12. The device is now operational and is not in custody transfer mode.



Note!

To set the device back to custody transfer mode, proceed as described on →  56.

## **9 Maintenance**

No special maintenance work is required.

### **9.1 External cleaning**

When cleaning the exterior of measuring devices, always use cleaning agents that do not attack the surface of the housing and the seals.

## 10 Accessories

Various accessories, which can be ordered with the device or subsequently from Endress+Hauser, are available for the device. Detailed information on the order code in question is available from your local Endress+Hauser sales center or on the product page of the Endress+Hauser website: [www.endress.com](http://www.endress.com).

### 10.1 Device-specific accessories

#### 10.1.1 For the Transmitter

Accessories	Description
Mounting set for transmitter	<p>Mounting set for wall-mount housing (remote version). Suitable for:</p> <ul style="list-style-type: none"> <li>▪ Wall mounting</li> <li>▪ Pipe mounting</li> <li>▪ Installation in control panel</li> </ul> <p>Mounting set for aluminum field housing: Suitable for pipe mounting (¾" to 3")</p>

### 10.2 Communication-specific accessories

Accessories	Description
HART Communicator Field Xpert handheld terminal	<p>Handheld terminal for remote parameterization and for obtaining measured values via the current output HART (4 to 20 mA).</p> <p>Contact your Endress +Hauser representative for more information.</p>
Commubox FXA195 HART	<p>The Commubox FXA195 connects intrinsically safe smart transmitters with the HART protocol with the USB port of a personal computer. This enables remote operation of the transmitter with operating software (e.g. FieldCare). Power is supplied to the Commubox via the USB port.</p>

### 10.3 Service-specific accessories

Accessories	Description
Applicator	<p>Software for selecting and sizing Endress+Hauser measuring devices:</p> <ul style="list-style-type: none"> <li>▪ Calculation of all the necessary data for identifying the optimum flowmeter: e.g. nominal diameter, pressure loss, accuracy or process connections</li> <li>▪ Graphic illustration of the calculation results</li> </ul> <p>Administration, documentation and access to all project-related data and parameters over the entire life cycle of a project.</p> <p>Applicator is available:</p> <ul style="list-style-type: none"> <li>▪ Via the Internet: <a href="https://wapps.endress.com/applicator">https://wapps.endress.com/applicator</a></li> <li>▪ On CD-ROM for local PC installation</li> </ul>

Accessories	Description
W@M	<p>Life cycle management for your plant.</p> <p>W@M supports you with a wide range of software applications over the entire process: from planning and procurement, to the installation, commissioning and operation of the measuring devices. All the relevant device information, such as the device status, spare parts and device-specific documentation, is available for every device over the entire life cycle. The application already contains the data of your Endress+Hauser device. Endress+Hauser also takes care of maintaining and updating the data records.</p> <p>W@M is available:</p> <ul style="list-style-type: none"> <li>▪ Via the Internet: <a href="http://www.endress.com/lifecyclemanagement">www.endress.com/lifecyclemanagement</a></li> <li>▪ On CD-ROM for local PC installation</li> </ul>
Fieldcheck	<p>Tester/simulator for testing flowmeters in the field.</p> <p>When used in conjunction with the "FieldCare" software package, test results can be imported into a database, printed and used for official certification. Contact your Endress+Hauser representative for more information.</p>
FieldCare	<p>FieldCare is Endress+Hauser's FDT-based plant asset management tool and allows the configuration and diagnosis of intelligent field devices. By using status information, you also have a simple but effective tool for monitoring devices. The flowmeters are accessed via a service interface or via the service interface FXA193.</p>
FXA291	<p>Service interface from the measuring device to the PC for operation via FieldCare.</p>













## 10.4 System components

Accessories	Description
Memograph M graphic display recorder	<p>The Memograph M graphic display recorder provides information on all the relevant process variables. Measured values are recorded correctly, limit values are monitored and measuring points analyzed. The data are stored in the 256 MB internal memory and also on a DSD card or USB stick. Memograph M boasts a modular design, intuitive operation and a comprehensive security concept. The ReadWin<sup>®</sup> 2000 PC software is part of the standard package and is used for configuring, visualizing and archiving the data captured. The mathematics channels which are optionally available enable continuous monitoring of specific power consumption, boiler efficiency and other parameters which are important for efficient energy management.</p>

# 11 Troubleshooting

## 11.1 Troubleshooting instructions

Always start troubleshooting with the following checklist if faults occur after commissioning or during operation. The routine takes you directly to the cause of the problem and the appropriate remedial measures.

Check the display	
No display visible and no output signals present.	<ol style="list-style-type: none"> <li>1. Check the supply voltage → Terminal 1, 2</li> <li>2. Check device fuse →  75 85 to 260 V AC: 0.8 A slow-blow / 250 V 20 to 55 V AC and 16 to 62 V DC: 2 A slow-blow / 250 V</li> <li>3. Measuring electronics defective → order spare parts →  70.</li> </ol>
No display visible, but output signals are present.	<ol style="list-style-type: none"> <li>1. Check whether the ribbon-cable connector of the display module is correctly plugged into the amplifier board →  70.</li> <li>2. Display module defective → order spare parts →  70</li> <li>3. Measuring electronics defective → order spare parts →  70</li> </ol>
Display texts are in a foreign language.	Switch off power supply. Press and hold down both the  keys and switch on the measuring device. The display text will appear in English (default) and is displayed at maximum contrast.
Measured value indicated, but no signal at the current or pulse output	Measuring electronics defective → order spare parts →  70
▼	
Error messages on display	
<p>Errors that occur during commissioning or measuring are displayed immediately. Error messages consist of a variety of icons. The meanings of these icons are as follows (example):</p> <ul style="list-style-type: none"> <li>- Type of error: <b>S</b> = System error, <b>P</b> = Process error</li> <li>- Error message type:  = Fault message, <b>!</b> = Notice message</li> <li>- <b>FLUID INHOM.</b> = Error designation (e.g. fluid is not homogeneous)</li> <li>- <b>03:00:05</b> = Duration of error occurrence (in hours, minutes and seconds)</li> <li>- <b>#702</b> = Error number</li> </ul> <p> Caution! See the information on →  28.</p>	
Error number: No. 001 - 399 No. 501 - 699	System error (device error) has occurred →  63
Error number: No. 400 - 499 No. 700 - 799	Process error (application error) has occurred →  67
▼	
Other error (without error message)	
Some other error has occurred.	Diagnosis and rectification →  68

## 11.2 System error messages

Serious system errors are **always** recognized by the device as "Fault message", and are shown as a lightning flash (⚡) on the display. Fault messages immediately affect the outputs. Simulations and positive zero return, on the other hand, are classed and displayed as "Notice messages".



### Caution!

In the event of a serious fault, a flowmeter might have to be returned to the manufacturer for repair. Procedures must be carried out before you return a flowmeter to Endress+Hauser for repair or calibration → ☰ 5, → ☰ 76.



### Note!

- The listed error message types below correspond to the factory setting.
- See also the information on → ☰ 28.

No.	Error message / Type	Cause	Remedy / spare part
S = System error ⚡ = Fault message (with an effect on the inputs and outputs) ! = Notice message (without any effect on the inputs and outputs)			
<b>No. # 0xx → Hardware error</b>			
001	S: CRITICAL FAILURE ⚡: # 001	Serious device error.	Replace the amplifier board. Spare parts → ☰ 70.
011	S: AMP HW EEPROM ⚡: # 011	Amplifier: Defective EEPROM.	Replace the amplifier board. Spare parts → ☰ 70.
012	S: AMP SW EEPROM ⚡: # 012	Measuring amplifier: Error when accessing data of the EEPROM.	The EEPROM data blocks in which an error has occurred are displayed in the "TROUBLESHOOTING" function. Press Enter to acknowledge the errors in question; default values are automatically inserted instead of the erroneous parameter values.  Note! The measuring device has to be restarted if an error has occurred in a totalizer block (→ also error No. 111 / CHECKSUM TOTAL.).
031	S: SENSOR HW DAT ⚡: # 031	Sensor DAT: 1. S-DAT is defective. 2. S-DAT is not plugged into the amplifier board or is missing.	1. Replace the S-DAT. Spare parts → ☰ 70. Check the spare part set number to ensure that the new, replacement DAT is compatible with the measuring electronics. 2. Plug the S-DAT into the amplifier board → ☰ 71 or → ☰ 73.
032	S: SENSOR SW DAT ⚡: # 032	Sensor DAT: Error accessing the calibration values stored in the S-DAT.	1. Check whether the S-DAT is correctly plugged into the amplifier board → ☰ 71 or → ☰ 73. 2. Replace the S-DAT if it is defective. Spare parts → ☰ 70. Before replacing the DAT, check that the new, replacement DAT is compatible with the measuring electronics. Check the: – Spare part set number – Hardware revision code 3. Replace measuring electronics boards if necessary. Spare parts → ☰ 70.
041	S: TRANSM. HW DAT ⚡: # 041	Sensor DAT: 1. T-DAT is defective. 2. T-DAT is not plugged into the amplifier board or is missing.	1. Replace the T-DAT. Spare parts → ☰ 70. Check the spare part set number to ensure that the new, replacement DAT is compatible with the measuring electronics. 2. Plug the T-DAT into the amplifier board → ☰ 71 or → ☰ 73.

No.	Error message / Type	Cause	Remedy / spare part
042	S: TRANSM. SW DAT ⚡: # 042	Sensor DAT: Error accessing the calibration values stored in the S-DAT.	<ol style="list-style-type: none"> <li>1. Check whether the T-DAT is correctly plugged into the amplifier board → ☞ 71 or → ☞ 73.</li> <li>2. Replace the T-DAT if it is defective. Spare parts → ☞ 70. Before replacing the DAT, check that the new, replacement DAT is compatible with the measuring electronics. Check the: <ul style="list-style-type: none"> <li>- Spare part set number</li> <li>- Hardware revision code</li> </ul> </li> <li>3. Replace measuring electronics boards if necessary. Spare parts → ☞ 70.</li> </ol>
<b>No. # 1xx → Software error</b>			
121	S: A / C COMPATIB. !: # 121	<p>Due to different software versions, I/O board and amplifier board are only partially compatible (possibly restricted functionality).</p> <p> Note!</p> <ul style="list-style-type: none"> <li>- This message is only listed in the error history.</li> <li>- Nothing is displayed on the display.</li> </ul>	<p>Module with lower software version has either to be updated by FieldCare with the required software version or the module has to be replaced.</p> <p>Spare parts → ☞ 70.</p>
<b>No. # 2xx → Error in DAT / no communication</b>			
205	S: LOAD T-DAT !: # 205	<p>Transmitter DAT: Data backup (downloading) to T-DAT failed, or error when accessing (uploading) the calibration values stored in the T-DAT.</p>	<ol style="list-style-type: none"> <li>1. Check whether the T-DAT is correctly plugged into the amplifier board → ☞ 71 or → ☞ 73.</li> <li>2. Replace the T-DAT if it is defective. Spare parts → ☞ 70. Before replacing the DAT, check that the new, replacement DAT is compatible with the measuring electronics. Check the: <ul style="list-style-type: none"> <li>- Spare part set number</li> <li>- Hardware revision code</li> </ul> </li> <li>3. Replace measuring electronics boards if necessary. Spare parts → ☞ 70.</li> </ol>
206	S: SAVE T-DAT !: # 206		
251	S: COMMUNICATION I/O ⚡: # 251	Internal communication fault on the amplifier board.	Remove the amplifier board. Spare parts → ☞ 70.
261	S: COMMUNICATION I/O ⚡: # 261	No data reception between amplifier and I/O board or faulty internal data transfer.	Check the BUS contacts.
271	S: POWER BRK. DOWN ⚡: # 271	Power supply interrupted. Error message appears during device startup in custody transfer mode after a power failure.	Confirm with the ENTER key or reset via the auxiliary input (status input).
<b>No. # 3xx → System limits exceeded</b>			
339 to 342	S: STACK CUR OUT n ⚡: # 339...342	<p>The temporarily buffered flow portions (measuring mode for pulsating flow) could not be cleared or output within 60 seconds.</p>	<ol style="list-style-type: none"> <li>1. Change the upper or lower limit setting, as applicable.</li> <li>2. Increase or reduce flow, as applicable.</li> </ol> <p>Recommendations in the event of fault category = FAULT MESSAGE (⚡):</p> <ul style="list-style-type: none"> <li>- Configure the fault response of the output to "ACTUAL VALUE", so that the temporary buffer can be cleared. → ☞ 70.</li> <li>- Clear the temporary buffer by the measures described under Item 1.</li> </ul>
343 to 346	S: STACK FREQ. OUT n ⚡: # 343...346		



No.	Error message / Type	Cause	Remedy / spare part
347 to 350	S: STACK PULSE OUT n !: # 347 to 350	The temporarily buffered flow portions (measuring mode for pulsating flow) could not be cleared or output within 60 seconds.	<ol style="list-style-type: none"> <li>1. Increase the setting for pulse weighting.</li> <li>2. Increase the max. pulse frequency if the totalizer can handle a higher number of pulses.</li> <li>3. Increase or reduce flow, as applicable.</li> </ol> <p>Recommendations in the event of fault category = FAULT MESSAGE (⚡):</p> <ul style="list-style-type: none"> <li>- Configure the fault response of the output to "ACTUAL VALUE", so that the temporary buffer can be cleared. → ☰ 70.</li> <li>- Clear the temporary buffer by the measures described under Item 1.</li> </ul>
351 to 354	S: CURRENT RANGE n ⚡: # 351...354	Current output: The actual value for the flow lies outside the set limits.	<ol style="list-style-type: none"> <li>1. Change the upper or lower limit setting, as applicable.</li> <li>2. Increase or reduce flow, as applicable.</li> </ol>
355 to 358	S: FREQ. RANGE n !: # 355 to 358	Frequency output: The actual value for the flow lies outside the set limits.	<ol style="list-style-type: none"> <li>1. Change the upper or lower limit setting, as applicable.</li> <li>2. Increase or reduce flow, as applicable.</li> </ol>
359 to 362	S: PULSE RANGE ⚡: # 359...362	Pulse output: Pulse output frequency is out of range.	<ol style="list-style-type: none"> <li>1. Increase the setting for pulse weighting.</li> <li>2. When selecting the pulse width, choose a value that can still be processed by a connected counter (e.g. mechanical counter, PLC etc.).</li> </ol> <p><i>Determine the pulse width:</i></p> <ul style="list-style-type: none"> <li>- Version 1: Enter the minimum duration that a pulse must be present at the connected counter to ensure its registration.</li> <li>- Version 2: Enter the maximum (pulse) frequency as the half "reciprocal value" that a pulse must be present at the connected counter to ensure its registration.</li> </ul> <p>Example: The maximum input frequency of the connected counter is 10 Hz. The pulse width to be entered is:</p> $\frac{1}{2 \cdot 10 \text{ Hz}} = 50 \text{ ms}$ <p style="text-align: right;">a0004437</p> <ol style="list-style-type: none"> <li>3. Reduce flow.</li> </ol>
379 to 380	S: FREQ. LIM ⚡: # 379...380	The measuring tube oscillation frequency is outside the permitted range.  Causes: - Change the upper or lower limit setting, as applicable. - Increase or reduce flow, as applicable.	Contact your Endress+Hauser representative.
381	S: FLUIDTEMP.MIN. ⚡: # 381	The temperature sensor on the measuring tube is likely defective.	Check the following electrical connections before you contact your Endress+Hauser representative: - Verify that the sensor signal cable connector is correctly plugged into the amplifier board → ☰ 71 or → ☰ 73. - Remote version: Check sensor and transmitter terminal connections No. 9 and 10 → ☰ 17.
382	S: FLUIDTEMP.MAX. ⚡: # 382		
383	S: CARR.TEMP.MIN ⚡: # 383	The temperature sensor on the carrier tube is likely defective.	Check the following electrical connections before you contact your Endress+Hauser representative: - Verify that the sensor signal cable connector is correctly plugged into the amplifier board → ☰ 71 or → ☰ 73. - Remote version: Check sensor and transmitter terminal connections No. 11 and 12 → ☰ 17.
384	S: CARR.TEMP.MAX ⚡: # 384		

No.	Error message / Type	Cause	Remedy / spare part
385	S: INL.SENS.DEF. !:# 385	One of the measuring tube exciter coils (inlet) is likely defective.	Check the following electrical connections before you contact your Endress+Hauser representative: - Verify that the sensor signal cable connector is correctly plugged into the amplifier board → 71 or → 73. - Remote version: Check sensor and transmitter terminal connections No. 4, 5, 6 and 7 → 17.
386	S: OUTL.SENS.DEF. !:# 386	One of the measuring tube exciter coils (outlet) is likely defective.	
387	S: SEN.ASY.EXCEED !:# 387	One of the measuring tube exciter coils is likely defective.	
388 to 390	S: AMP. FAULT !:# 388...390	Amplifier error.	Contact your Endress+Hauser representative.
<b>No. # 5xx → Application error</b>			
501	S: SW.-UPDATE ACT. !:# 501	New amplifier or communication (I/O module) software version is loaded. Currently no other functions are possible.	Wait until process is finished. The device will restart automatically.
502	S: UP-/DOWNLOAD ACT. !:# 502	Up- or downloading the device data via configuration program. Currently no other functions are possible.	Wait until process is finished.
586	S: OSC. AMP. LIMIT !:# 586	The fluid properties do not allow a continuation of the measurement.  Causes: - Extremely high viscosity. - Process fluid is very inhomogeneous (gas or solid content).	Change or improve process conditions.
587	S: TUBE OSC. NOT !:# 587	Extreme process conditions exist. The measuring system can therefore not be started.	Change or improve process conditions.
588	S: GAIN RED.IMPOS !:# 588	Overdriving of the internal analog to digital converter.  Causes: - Cavitation - Extreme pressure pulses - High gas flow velocity  A continuation of the measurement is no longer possible.	Change or improve process conditions, e.g. by reducing the flow velocity.
<b>No. # 6xx → Simulation mode active</b>			
601	S: POSITIVE ZERO RETURN !:# 601	Positive zero return active.  Caution! This message has the highest display priority.	Switch off positive zero return.
611 to 614	S: SIM. CURR. OUT. n !:# 611 to 614	Simulation current output active.	
621 to 624	S: SIM. FREQ. OUT n !:# 621 to 624	Simulation frequency output active.	Switch off simulation.
631 to 634	S: SIM. PULSE n !:# 631 to 634	Simulation pulse output active.	Switch off simulation.
671 to 674	S: SIM. STAT. IN n !:# 671 to 674	Simulation status input active.	Switch off simulation.
691	S: SIM. FAILSAFE !:# 691	Simulation of response to error (outputs) active.	Switch off simulation.
692	S: SIM. MEASURAND !:# 692	Simulation of measuring variables (e.g. mass flow).	Switch off simulation.
698	S: DEV. TEST AKT. !:# 698	The measuring device is being checked on site via the test and simulation device.	-

## 11.3 Process error messages

Process errors can be defined as either "Fault" or "Notice" messages and can thereby be weighted differently. You can define messages in this way with the aid of the function matrix (→ "Description of Device Parameters" manual).



Note!

- The listed error message types below correspond to the factory setting.
- See also the information on → 28.

No.	Error message / Type	Cause	Remedy / spare part
P = Process error ⚡ = Fault message (with an effect on the inputs and outputs) ! = Notice message (without any effect on the inputs and outputs)			
700	P: EMPTY PIPE ⚡: # 700	The process fluid density is outside the upper or lower limit values set in the "EPD" function.  Causes: – Air in the measuring tube – Partly filled measuring tube	<ol style="list-style-type: none"> <li>1. Ensure that there is no gas content in the process liquid.</li> <li>2. Adapt the values in the "EPD RESPONSE TIME" function to the current process conditions.</li> </ol>
701	P: EXC. CURR. LIM ⚡: # 701	The maximum current value for the measuring tube exciter coils has been reached, since certain process fluid characteristics are extreme, e.g. high gas or solid content. The device continues to work correctly.	In particular with outgassing fluids and/or increased gas content, the following measures are recommended to increase system pressure: <ol style="list-style-type: none"> <li>1. Install the device at the outlet side of a pump.</li> <li>2. Install the device at the lowest point of an ascending pipeline.</li> </ol>
702	P: FLUID INHOM. ⚡: # 702	Frequency control is not stable, due to inhomogeneous process fluid, e.g. gas or solid content.	<ol style="list-style-type: none"> <li>3. Install a flow restriction, e.g. reducer or orifice plate, downstream from the device.</li> </ol>
703	P: NOISE LIM. CHO ⚡: # 703	Overdriving of the internal analog to digital converter.  Causes: – Cavitation – Extreme pressure pulses – High gas flow velocity	Change or improve process conditions, e.g. by reducing the flow velocity.
704	P: NOISE LIM. CH1 ⚡: # 704	A continuation of the measurement is still possible.	
705	P: FLOW LIMIT ⚡: # 705	The mass flow is too high. The electronics' measuring range will be exceeded.	Reduce flow.
731	P: ADJ. ZERO FAIL !: # 731	The zero point adjustment is not possible or has been canceled.	Make sure that zero point adjustment is carried out at "zero flow" only ( $v = 0$ m/s). →  52

## 11.4 Process errors without messages

Symptoms	Rectification
<p>Comment: You may have to change or correct certain settings of the function matrix in order to rectify faults. The functions outlined below, such as DISPLAY DAMPING, are described in detail in the "Description of Device Parameters" manual.</p>	
<p>Measured value reading fluctuates even though flow is steady.</p>	<ol style="list-style-type: none"> <li>1. Check the fluid for presence of gas bubbles.</li> <li>2. "TIME CONSTANT" function → increase value (→ OUTPUTS / CURRENT OUTPUT / CONFIGURATION)</li> <li>3. "DISPLAY DAMPING" function → increase value (→ USER INTERFACE / CONTROL / BASIC CONFIG.)</li> </ol>
<p>Flow values are negative, even though the fluid is flowing forwards through the pipe.</p>	<p>Change the "INSTALLATION DIRECTION SENSOR" function accordingly.</p>
<p>Measured-value reading or measured-value output pulsates or fluctuates, e.g. because of reciprocating pump, peristaltic pump, diaphragm pump or pump with similar delivery characteristic.</p>	<p>Run the "Pulsating Flow" Quick Setup → 43. If the problem persists despite these measures, a pulsation damper will have to be installed between pump and measuring device.</p>
<p>There are differences between the flowmeter's internal totalizer and the external metering device.</p>	<p>This symptom is due primarily to backflow in the piping, because the pulse output cannot subtract in the "STANDARD" or "SYMMETRY" measuring modes.</p> <p>The problem can be solved as follows: Allow for flow in both directions. Set the "MEASURING MODE" function to "PULSATING FLOW" for the pulse output in question.</p>
<p>Measured value reading shown on display, even though the fluid is at a standstill and the measuring tube is full.</p>	<ol style="list-style-type: none"> <li>1. Check the fluid for presence of gas bubbles.</li> <li>2. Activate the "ON-VAL. LF-CUTOFF" function, i.e. enter or increase the value for the low flow cut off (→ BASIC FUNCTION / PROCESSPARAMETER / CONFIGURATION).</li> </ol>
<p>The error cannot be eliminated or another error pattern is present. In these instances, please contact your Endress+Hauser service organization.</p>	<p>The following solutions are possible:</p> <p><b>Request the services of an Endress+Hauser service technician</b> If you request the services of a service technician, please be ready with the following information:</p> <ul style="list-style-type: none"> <li>- Brief error description</li> <li>- Nameplate specifications: order code and serial number → 6</li> </ul> <p><b>Return the devices to Endress+Hauser</b> Procedures must be carried out before you return a flowmeter to Endress+Hauser for repair or calibration → 5, → 76.</p> <p><b>Replace the transmitter electronics</b> Parts of the measuring electronics defective → order spare part → 76</p>

## 11.5 Response of outputs to errors



Note!

The failsafe mode of totalizers, current, pulse and frequency outputs can be customized by means of various functions in the function matrix. Detailed information → "Description of Device Parameters" manual.

You can use positive zero return to set the signals of the current, pulse and status outputs to their fallback value, for example when measuring has to be interrupted while a pipe is being cleaned. This function takes priority over all other device functions. Simulations, for example, are suppressed.

Failsafe mode of outputs and totalizers		
	Process/system error is present	Positive zero return is activated
<p> <b>Caution!</b> System or process errors defined as "Notice messages" have no effect whatsoever on the inputs and outputs. See also the information on → 28.</p>		
Current output	<p><b>MIN. CURRENT</b> The current output will be set to the lower value of the signal on alarm level depending on the setting selected in the CURRENT SPAN (→ "Description of Device Parameters" manual).</p> <p><b>MAX. CURRENT</b> The current output will be set to the upper value of the signal on alarm level depending on the setting selected in the CURRENT SPAN (→ "Description of Device Parameters" manual).</p> <p><b>HOLD VALUE</b> Measured value display on the basis of the last saved value preceding occurrence of the fault.</p> <p><b>ACTUAL VALUE</b> Measured value display on the basis of the current flow measurement. The fault is ignored.</p>	Output signal corresponds to "zero flow"
Pulse output	<p><b>FALLBACK VALUE</b> Signal output → no pulses</p> <p><b>HOLD VALUE</b> Last valid value (preceding occurrence of the fault) is output.</p> <p><b>ACTUAL VALUE</b> Fault is ignored, i.e. normal measured value output on the basis of ongoing flow measurement.</p>	Output signal corresponds to "zero flow"
Frequency output	<p><b>FALLBACK VALUE</b> Signal output → 0 Hz</p> <p><b>FAILSAFE VALUE</b> Output of the frequency specified in the FAILSAFE VALUE function.</p> <p><b>HOLD VALUE</b> Last valid value (preceding occurrence of the fault) is output.</p> <p><b>ACTUAL VALUE</b> Fault is ignored, i.e. normal measured value output on the basis of ongoing flow measurement.</p>	Output signal corresponds to "zero flow"
Totalizer	<p><b>STOP</b> The totalizers are paused until the fault is rectified.</p> <p><b>ACTUAL VALUE</b> The fault is ignored. The totalizer continues to count in accordance with the current flow value.</p> <p><b>HOLD VALUE</b> The totalizers continue to count the flow in accordance with the last valid flow value (before the error occurred).</p>	Totalizer stops

## 11.6 Spare parts

The previous sections contain detailed troubleshooting instructions → 62.

The measuring device, moreover, provides additional support in the form of continuous self-diagnosis and error messages.

Fault rectification can entail replacing defective components with tested spare parts. For an overview of the spare parts that can be delivered, see → 32.



Note!

Spare parts can be ordered directly from your Endress+Hauser representative by providing the serial number printed on the transmitter's nameplate (→ 6).

Spare parts are shipped as sets comprising the following parts:

- Spare part
- Additional parts, small items (threaded fasteners etc.)
- Mounting instructions
- Packaging

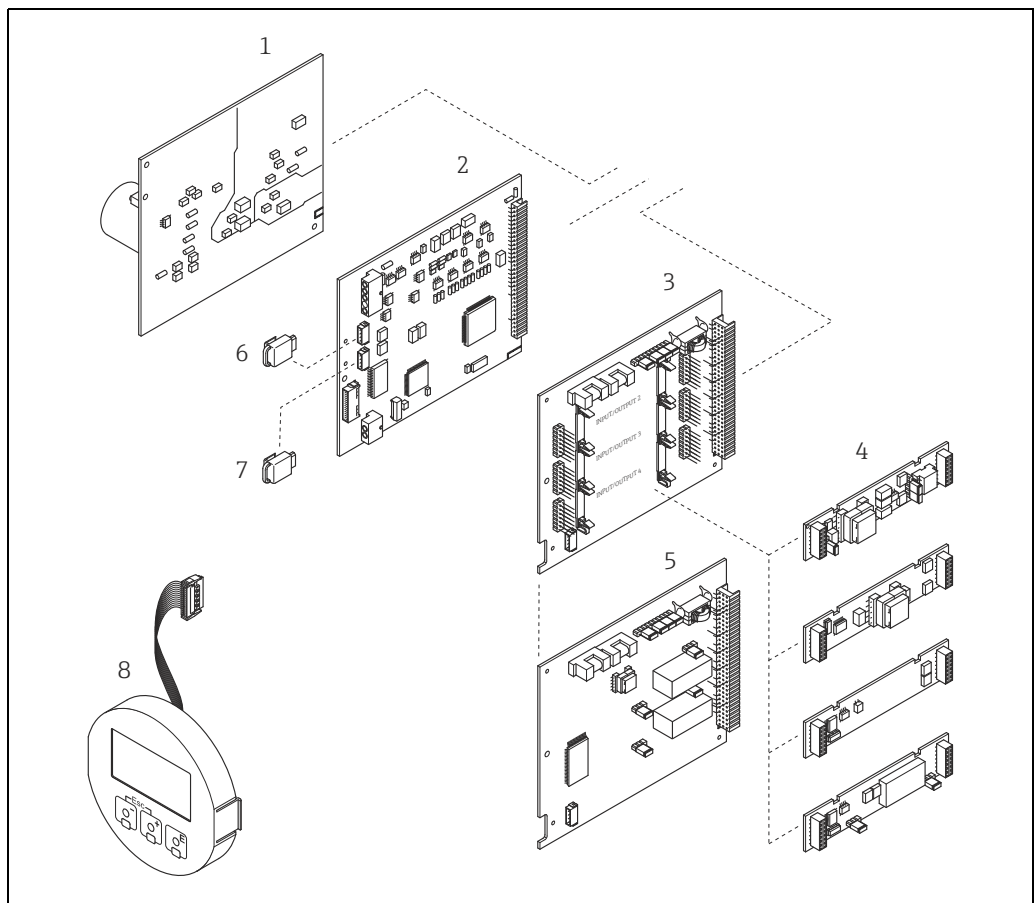

A0006363

Fig. 32: Spare parts for transmitter (field and wall-mount housings)

- 1 Power unit board (85 to 260 V AC, 20 to 55 V AC, 16 to 62 V DC)
- 2 Amplifier board
- 3 I/O board (COM module), flexible assignment
- 4 Pluggable input/output submodules
- 5 I/O board (COM module), permanent assignment
- 6 S-DAT (sensor data memory)
- 7 T-DAT (transmitter data memory)
- 8 Display module

## 11.6.1 Removing and installing printed circuit boards

### Field housing



#### Warning!

- Risk of electric shock. Exposed components carry dangerous voltages. Make sure that the power supply is switched off before you remove the cover of the electronics compartment.
- Risk of damaging electronic components (ESD protection).  
Static electricity can damage electronic components or impair their operability. Use a workplace with a grounded working surface purposely built for electrostatically sensitive devices.
- If you cannot guarantee that the dielectric strength of the measuring device is maintained in the following steps, then an appropriate inspection must be carried out in accordance with the manufacturer's specifications.



#### Caution!

Use only original Endress+Hauser parts.

Installing and removing the boards →  33:

1. Unscrew cover of the electronics compartment from the transmitter housing.
2. Remove the local display (1) as follows:
  - Press in the latches (1.1) at the side and remove the display module.
  - Disconnect the ribbon cable (1.2) of the display module from the amplifier board.
3. Remove the screws and remove the cover (2) from the electronics compartment.
4. Remove power unit board (4) and I/O board (6):  
Insert a thin pin into the hole (3) provided for the purpose and pull the board clear of its holder.
5. Remove submodules (6.1) (optional):  
No tools are required for removing the submodules (outputs) from the I/O board.  
Installation is also a no-tools operation.



#### Caution!

Only certain combinations of submodules on the I/O board are permissible →  19.  
The individual slots are marked and correspond to certain terminals in the connection compartment of the transmitter:

- Slot "INPUT / OUTPUT 3" = Terminals 22/23
- Slot "INPUT / OUTPUT 4" = Terminals 20/21

6. Remove amplifier board (5):
  - Disconnect the plug of the sensor signal cable (5.1) including S-DAT (5.3) from the board.
  - Gently disconnect the plug of the excitation current cable (5.2) from the board, i.e. without moving it back and forward.
  - Insert a thin pin into the hole (3) provided for the purpose and pull the board clear of its holder.
7. Installation is the reverse of the removal procedure.

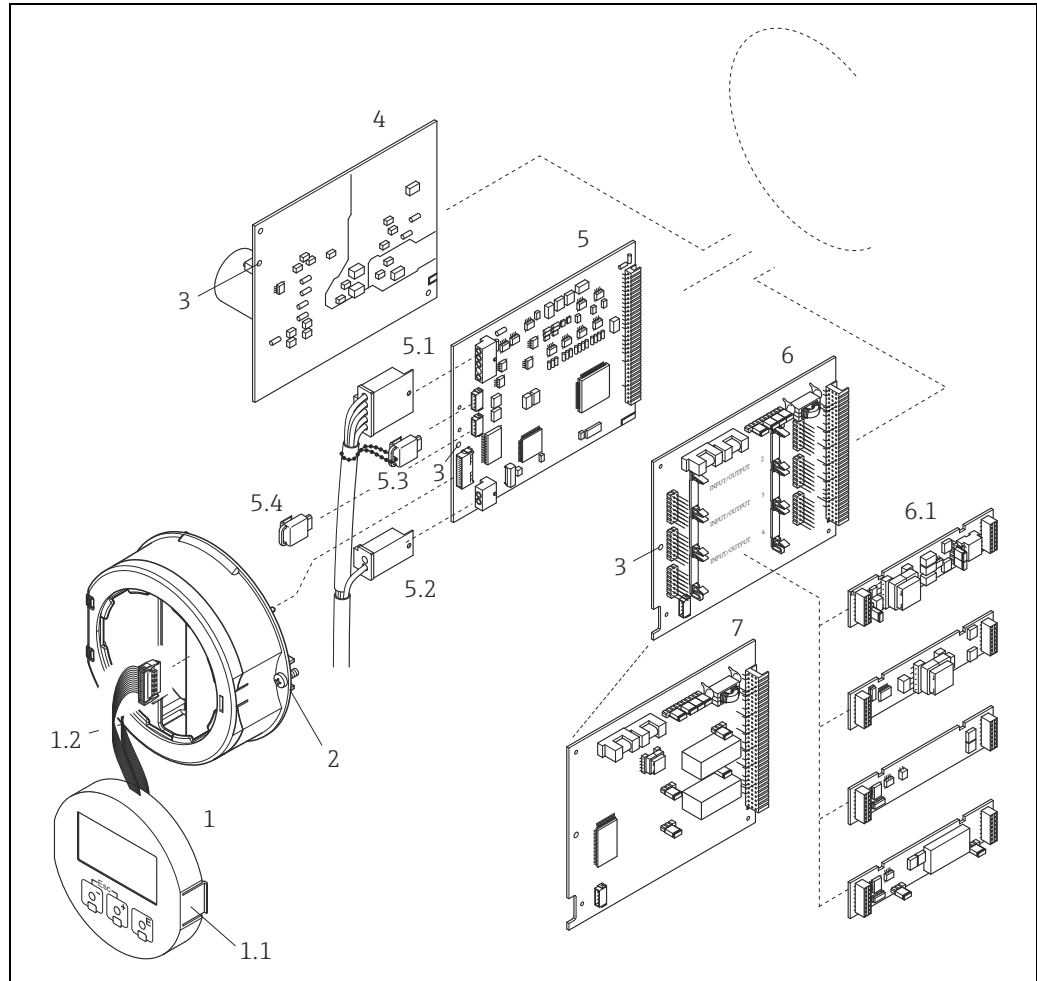

A0006364

Fig. 33: Field housing: removing and installing printed circuit boards

- 1 Local display
- 1.1 Latch
- 1.2 Ribbon cable (display module)
- 2 Screws of electronics compartment cover
- 3 Aperture for installing/removing boards
- 4 Power unit board
- 5 Amplifier board
- 5.1 Signal cable (sensor)
- 5.2 Excitation current cable (sensor)
- 5.3 S-DAT (sensor data memory)
- 5.4 T-DAT (transmitter data memory)
- 6 I/O board (flexible assignment)
- 6.1 Pluggable submodules (status input and current input, current output, pulse/frequency output and relay output)
- 7 I/O board (permanent assignment)



### Wall-mount housing



#### Warning!

- Risk of electric shock. Exposed components carry dangerous voltages. Make sure that the power supply is switched off before you remove the cover of the electronics compartment.
- Risk of damaging electronic components (ESD protection).  
Static electricity can damage electronic components or impair their operability. Use a workplace with a grounded working surface purposely built for electrostatically sensitive devices.
- If you cannot guarantee that the dielectric strength of the measuring device is maintained in the following steps, then an appropriate inspection must be carried out in accordance with the manufacturer's specifications.



#### Caution!

Use only original Endress+Hauser parts.

Installing and removing the boards →  34:

1. Remove the screws and open the hinged cover (1) of the housing.
2. Remove the screws securing the electronics module (2). Then push up electronics module and pull it as far as possible out of the wall-mount housing.
3. Disconnect the following cable plugs from amplifier board (7):
  - Sensor signal cable plug (7.1) including S-DAT (7.3)
  - Unplug excitation current cable (7.2):  
Gently disconnect the plug, i.e. without moving it back and forward.
  - Ribbon cable plug (3) of the display module.
4. Remove the cover (4) from the electronics compartment by loosening the screws.
5. Remove the boards (6, 7, 8):  
Insert a thin pin into the hole (5) provided for the purpose and pull the board clear of its holder.
6. Remove submodules (8.1) (optional):  
No tools are required for removing the submodules (outputs) from the I/O board. Installation is also a no-tools operation.



#### Caution!

Only certain combinations of submodules on the I/O board are permissible →  19.  
The individual slots are marked and correspond to certain terminals in the connection compartment of the transmitter:

Slot "INPUT / OUTPUT 2" = Terminals 24/25  
 Slot "INPUT / OUTPUT 3" = Terminals 22/23  
 Slot "INPUT / OUTPUT 4" = Terminals 20/21

7. Installation is the reverse of the removal procedure.

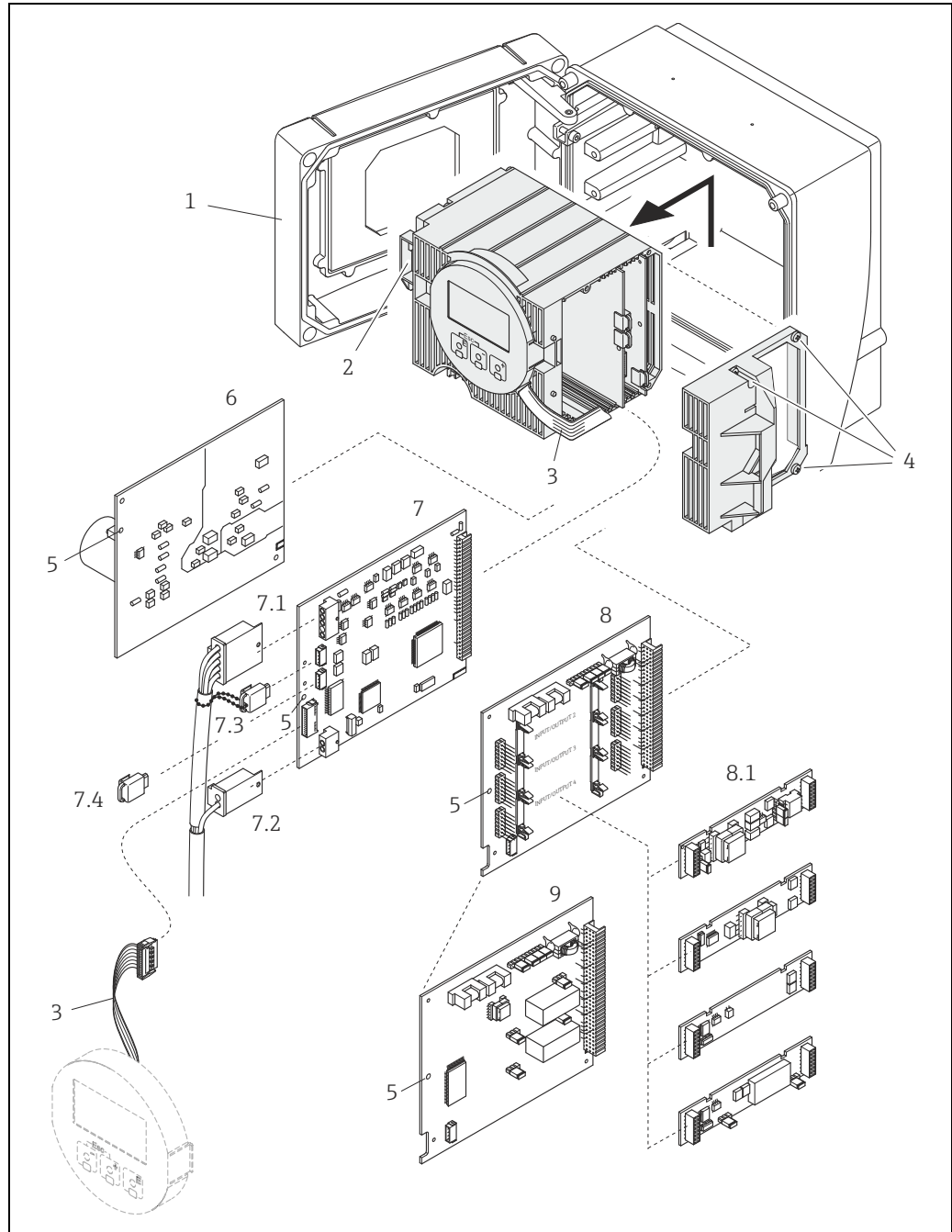

A0006365

Fig. 34: Wall-mount housing: removing and installing printed circuit boards

- 1 Housing cover
- 2 Electronics module
- 3 Ribbon cable (display module)
- 4 Screws of electronics compartment cover
- 5 Aperture for installing/removing boards
- 6 Power unit board
- 7 Amplifier board
- 7.1 Signal cable (sensor)
- 7.2 Excitation current cable (sensor)
- 7.3 S-DAT (sensor data memory)
- 7.4 T-DAT (transmitter data memory)
- 8 I/O board (flexible assignment)
- 8.1 Pluggable submodules (status input and current input, current output, pulse/frequency output and relay output)
- 9 I/O board (permanent assignment)

### 11.6.2 Replacing the device fuse



#### Warning!

Risk of electric shock. Exposed components carry dangerous voltages. Make sure that the power supply is switched off before you remove the cover of the electronics compartment.

The main fuse is on the power unit board → 35.

Replace the fuse as follows:

1. Switch off power supply.
2. Remove the power unit board → 71.
3. Remove the protection cap (1) and replace the device fuse (2).  
Only use the following fuse type:
  - 20 to 55 V AC / 16 to 62 V DC → 2.0 A slow-blow / 250 V; 5.2 × 20 mm
  - Power supply 85 to 260 V AC → 0.8 A slow-blow / 250 V; 5.2 × 20 mm
  - Ex-rated devices → Ex documentation
4. Installation is the reverse of the removal procedure.



#### Caution!

Use only original Endress+Hauser parts.

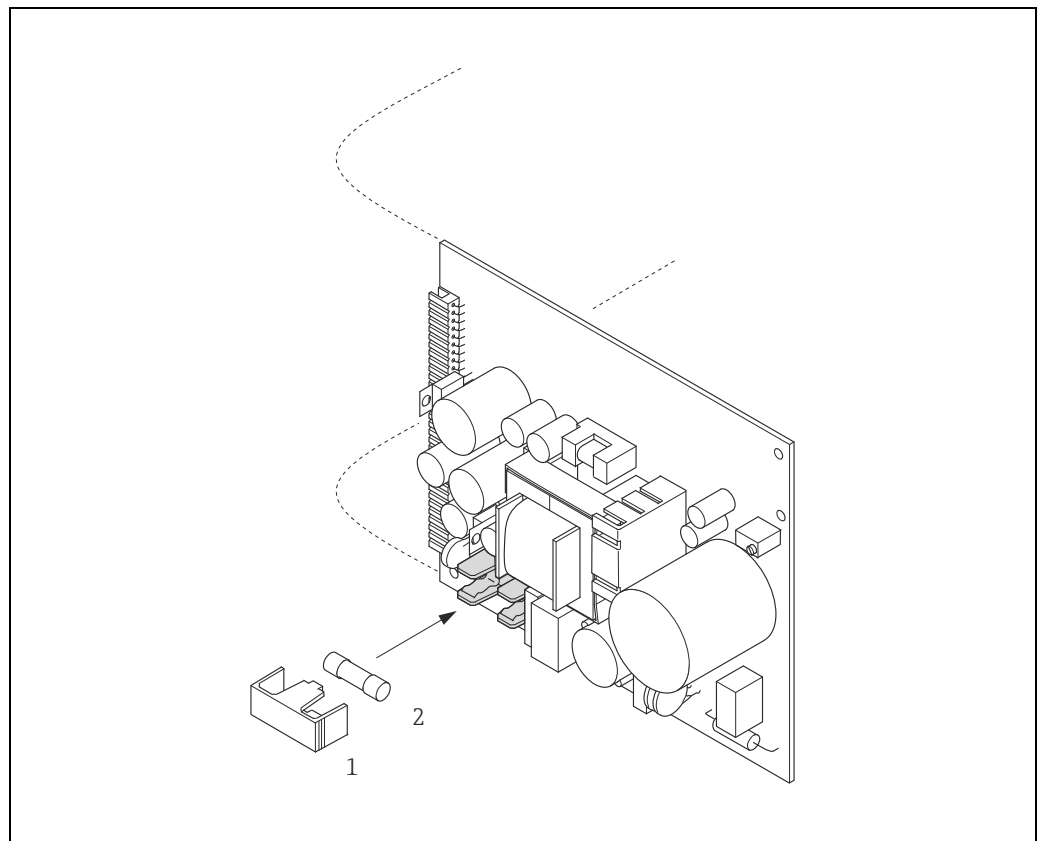

Fig. 35: Replacing the device fuse on the power unit board

- |   |                |
|---|----------------|
| 1 | Protective cap |
| 2 | Device fuse    |

A0001148

## 11.7 Return

The measuring device must be returned if repairs or a factory calibration are required, or if the wrong measuring device has been ordered or delivered. According to legal regulations, Endress+Hauser, as an ISO-certified company, is required to follow certain procedures when handling returned products that are in contact with medium

To ensure swift, safe and professional device returns, please read the return procedures and conditions on the Endress+Hauser website at [www.services.endress.com/return-material](http://www.services.endress.com/return-material).

## 11.8 Disposal

Observe the regulations applicable in your country.

## 11.9 Software history

Date	Software version	Changes to software	Operating Instructions
03.2016	3.01.xx	-	71316752 / 14.16
11.2015	3.01.xx	Original software	71235485/ 13.15
01.2010	3.01.00	Original software	71096458/ 10.09

## 12 Technical data

### 12.1 Applications

→  4

### 12.2 Function and system design

**Measuring principle** Mass flow measurement by the Coriolis principle

**Measuring system** →  6

### 12.3 Input

**Measured variable**

- Mass flow (proportional to the phase difference between two sensors mounted on the measuring tube which record differences in the pipe oscillation geometry during flow)
- Volume flow (measured from the mass flow and density)
- Fluid density (proportional to the resonance frequency of the measuring tube)
- Fluid temperature (measured with temperature sensors)

**Measuring range** Measuring ranges for Compressed Natural Gas (CNG), non-custody transfer operation.

DN		$\dot{m}_{\min(F)}$ to $\dot{m}_{\max(F)}$	
[mm]	[in]	[kg/min]	[lb/min]
8	$\frac{3}{8}$ "	0 to 30	0 to 66
15	$\frac{1}{2}$ "	0 to 80	0 to 175
25	1"	0 to 150	0 to 330



Note!

The values of the corresponding custody transfer certificate apply for custody transfer operation.

**Operable flow range** 1 : 100

**Input signal** *Status input (auxiliary input)*  
 U = 3 to 30 V DC,  $R_i = 3 \text{ k}\Omega$ , galvanically isolated.  
 Switching level: 3 to 30 V DC, polarity-independent.  
 Configurable for: totalizer reset, positive zero return, error message reset, start zero point adjustment.

## 12.4 Output

<b>Output signal</b>	<p><i>Current output</i></p> <p>Active/passive selectable, galvanically isolated, time constant selectable (0.05 to 100 s), full scale value selectable, temperature coefficient: typically 0.005% o.r. / °C, resolution: 0.5 µA</p> <ul style="list-style-type: none"> <li>■ Active: 0/4 to 20 mA, <math>R_L \geq 250 \Omega</math></li> <li>■ Passive: 4 to 20 mA; supply voltage <math>V_S</math>: 18 to 30 V DC; <math>R_i \geq 150 \Omega</math></li> </ul> <p>o.r. = of reading</p> <p><i>Pulse/frequency output</i></p> <p>Active/passive can be selected, galvanically isolated</p> <ul style="list-style-type: none"> <li>■ Active: 24 V DC, 25 mA (max. 250 mA during 20 ms), <math>R_L &gt; 100 \Omega</math></li> <li>■ Passive: open collector, 30 V DC, 250 mA</li> <li>■ Frequency output: end frequency 2 to 10000 Hz (<math>f_{max} = 12500</math> Hz), on/off ratio 1:1, pulse width max. 2 s</li> <li>■ Pulse output: pulse value and pulse polarity selectable, pulse width configurable (0.05 to 2000 ms)</li> </ul>
<b>Signal on alarm</b>	<p><i>Current output</i></p> <p>Failsafe mode selectable (for example, according to NAMUR Recommendation NE 43)</p> <p><i>Pulse/frequency output</i></p> <p>Failsafe mode selectable</p> <p><i>Relay output</i></p> <p>De-energized in the event of fault or power supply failure</p>
<b>Switching output</b>	<p><i>Relay output</i></p> <p>Normally closed (NC or break) or normally open (NO or make) contacts available (factory setting: relay 1 = normally open), max. 30 V / 0.5 A AC; 60 V / 0.1 A DC, galvanically isolated.</p>
<b>Load</b>	<p>→ "Output signal"</p>
<b>Galvanic isolation</b>	<p>All circuits for inputs, outputs, and power supply are galvanically isolated from each other.</p>

## 12.5 Power supply

<b>Terminal assignment</b>	<p>→  19</p>
<b>Supply voltage</b>	<p>85 to 260 V AC, 45 to 65 Hz                  20 to 55 V AC, 45 to 65 Hz                  16 to 62 V DC</p>
<b>Power consumption</b>	<p>AC: &lt; 15 VA (including sensor)                  DC: &lt; 15 W (including sensor)</p> <p>Switch-on current</p> <ul style="list-style-type: none"> <li>■ Max. 13.5 A (&lt; 50 ms) at 24 V DC</li> <li>■ Max. 3 A (&lt; 5 ms) at 260 V AC</li> </ul>
<b>Power supply failure</b>	<p>Lasting min. 1 power cycle:</p> <ul style="list-style-type: none"> <li>■ EEPROM or HistoROM T-DAT saves measuring system data if power supply fails.</li> <li>■ HistoROM/S-DAT: exchangeable data storage chip which stores the data of the sensor (nominal diameter, serial number, calibration factor, zero point etc.)</li> </ul>

**Electrical connections** →  16

**Potential equalization** No measures necessary.  
For explosion-protected equipment → separate Ex-documentation supplied

**Cable entries** Power supply and signal cables (inputs/outputs):

- Cable entry M20 × 1.5 (8 to 12 mm / 0.31 to 0.47")
- Threads for cable entries, ½" NPT, G ½"

Connecting cable for remote version:

- Cable entry M20 × 1.5 (8 to 12 mm / 0.31 to 0.47")
- Threads for cable entries, ½" NPT, G ½"

**Cable specifications** Remote version →  17

## 12.6 Performance characteristics

**Reference operating conditions** Error limits following ISO/DIS 11631:

- Fluid: water
- 15 to 45 °C (59 to 113 °F); 2 to 6 bar (29 to 87 psi)
- Calibration rigs returned to national calibration standards
- Zero point calibrated under operating conditions
- Density adjustment carried out

To obtain measured errors, use the Applicator sizing tool *Applicator*: →  60.

**Maximum measured error** **Mass flow**  
±0.5% of the quantity filled in typical CNG fueling.

**Repeatability** **Mass flow (gases)**  
■ ±0.25% of the quantity filled in typical CNG fueling.

**Influence of medium temperature** When there is a difference between the temperature for zero point adjustment and the process temperature, the typical measured error is ±0.0003% of the full scale value / °C.

**Influence of medium pressure** The following section shows the effect on accuracy of mass flow due to a difference between calibration pressure and process pressure is negligible.

## 12.7 Installation



**Installation instructions** →  11

**Connection cable length, remote version** Max. 20 m (max. 66 ft)

## 12.8 Environment

<b>Ambient temperature range</b>	Sensor and transmitter: <ul style="list-style-type: none"> <li>■ Standard: -20 to +60 °C (-4 to +140 °F)</li> <li>■ Optional: -40 to +60 °C (-40 to +140 °F)</li> </ul>
	Note! <ul style="list-style-type: none"> <li>■ Install the device in a shady location. Avoid direct sunlight, particularly in warm climatic regions.</li> <li>■ At ambient temperatures below -20 °C (-4 °F), the readability of the display may be impaired.</li> </ul>
<b>Storage temperature</b>	-40 to +80 °C (-40 to +175 °F), preferably at +20 °C (+68 °F)
<b>Degree of protection</b>	Standard: IP 67 (NEMA 4X) for transmitter and sensor
<b>Shock resistance</b>	According to IEC/EN 60068-2-31
<b>Vibration resistance</b>	According to IEC/EN 60068-2-31
<b>Electromagnetic compatibility (EMC)</b>	As per IEC/EN 61326

## 12.9 Process

<b>Medium temperature range</b>	-50 to +150 °C (-58 to +302 °F)
<b>Limiting medium pressure range</b>	Max. 350 bar (5080 psi)
<b>Pressure-temperature ratings</b>	An overview of the Pressure-temperature ratings for the process connections is provided in the "Technical Information" document.
<b>Rupture disk</b>	Triggering pressure in the housing 10 to 15 bar (145 to 218 psi), →  11 "Special mounting instructions".
<b>Flow rate</b>	→  77, "Measuring range"



## 12.10 Mechanical construction

### Design / dimensions

The dimensions and lengths of the sensor and transmitter are provided in the separate "Technical Information" document on the measuring device in question. This can be downloaded as a PDF file from [www.endress.com](http://www.endress.com). A list of the "Technical Information" documents available is provided in the "Documentation" section →  83.

### Weight

DN in mm (in)	8 (3/8")	15 (1/2")	25 (1")
Weight in kg	8.9	10.8	11.8
Weight in lb	19.6	23.8	26.0

### Material

#### Transmitter housing:

Powder coated die-cast aluminum

#### Housing of sensor/secondary containment

Acid-resistant and alkali-resistant external surface, stainless steel 1.4301 (304)

#### Process connections

Stainless steel 1.4404 (316)

#### Measuring tubes

Stainless steel 1.4435 (316L)

### Process connections

Cylindrical internal thread BSP (G) in accordance with ISO 228-1 with sealing surfaces in accordance with DIN 3852-2/ISO 1179-1:

- G 1/2" for DN 08
- G 3/4" for DN 15
- G 1" for DN 25



Note!

Sealed with profile seal in accordance with DIN 3869 or copper disk or steel seal disk with plastic lip.



## 12.11 Operability

### Local display

#### Display elements

- Liquid crystal display: illuminated, four lines with 16 characters per line
- Selectable display of different measured values and status variables
- At ambient temperatures below -20 °C (-4 °F), the readability of the display may be impaired.

#### Control elements

- Local operation with three optical sensors (  )
- Application specific Quick Setup menus for straightforward commissioning

<b>Language groups</b>	<p>Language groups available for operation in different countries:</p> <ul style="list-style-type: none"> <li>■ Western Europe and America (WEA): English, German, Spanish, Italian, French, Dutch and Portuguese</li> <li>■ Eastern Europe/Scandinavia (EES): English, Russian, Polish, Norwegian, Finnish, Swedish, Czech</li> <li>■ South and East Asia (SEA): English, Japanese, Indonesian</li> <li>■ China (CN): English, Chinese</li> </ul> <p> Note! You can change the language group via the operating program FieldCare.</p>
------------------------	--

<b>Remote operation</b>	Operation via HART protocol.
-------------------------	------------------------------

## 12.12 Certificates and approvals

<b>CE mark</b>	The measuring system is in conformity with the statutory requirements of the EC Directives. Endress+Hauser confirms successful testing of the device by affixing to it the CE mark.
----------------	---

<b>C-tick mark</b>	The measuring system meets the EMC requirements of the Australian Communications and Media Authority (ACMA).
--------------------	--

<b>Ex approval</b>	Information about currently available Ex versions (ATEX, NEC/CEC etc.) can be supplied by your Endress+Hauser representative on request. All explosion protection data are given in a separate documentation, which is also available upon request →  83.
--------------------	--

<b>Approval for custody transfer</b>	→  54.
--------------------------------------	---

<b>HART certification</b>	<p>The flowmeter has successfully passed all the test procedures carried out and is certified and registered by the HCF (Hart Communication Foundation). The device thus meets all the requirements of the following specifications:</p> <ul style="list-style-type: none"> <li>■ Certified in accordance with HART Revisions 5 and 7 (device certification number: available on request)</li> <li>■ The measuring device can also be operated with certified devices of other manufacturers (interoperability).</li> </ul>
---------------------------	---

<b>Pressure Equipment Directive</b>	<p>The measuring devices can be ordered with or without PED (Pressure Equipment Directive). If a device with PED is required, this must be ordered explicitly. For devices with nominal diameters less than or equal to DN 25 (1"), this is neither possible nor necessary.</p> <ul style="list-style-type: none"> <li>■ With the identification PED/G1/III on the sensor nameplate, Endress+Hauser confirms conformity with the "Basic safety requirements" of Appendix I of the Pressure Equipment Directive 97/23/EC.</li> <li>■ Devices with this identification (with PED) are suitable for the following types of fluid:             <ul style="list-style-type: none"> <li>– Fluids of Group 1 and 2 with a steam pressure greater than, or smaller and equal to 0.5 bar (7.3 psi)</li> <li>– Unstable gases</li> </ul> </li> <li>■ Devices without this identification (without PED) are designed and manufactured according to good engineering practice. They correspond to the requirements of Art. 3, Section 3 of the Pressure Equipment Directive 97/23/EC. Their application is illustrated in Diagrams 6 to 9 in Appendix II of the Pressure Equipment Directive 97/23/EC.</li> </ul>
-------------------------------------	---

**Other standards and guidelines**

- EN 60529  
Degrees of protection by housing (IP code)
- EN 61010-1  
Safety requirements for electrical equipment for measurement, control and laboratory use
- IEC/EN 61326  
Electromagnetic compatibility (EMC requirements)
- OIML R139  
Suitability for custody transfer measurement

**12.13 Accessories/spare parts**

→  60

**12.14 Documentation**

- Flow measurement (FA00005D)
- Description of Device Parameters (GP00001D)
- Technical Information (TI00098D)
- Ex-Supplementary documentation ATEX (II2G): (XA00135D)
- Ex-Supplementary documentation NEC/CEC (Div. 1): (XA00137D)
- Ex-Supplementary documentation NEPSI (Zone 1, Zone 21): (XA00138D)

# Index

## A

Ambient temperature .....	80
Applications .....	77
Applicator (Auslege-Software) .....	60
Approval by (the Standards Authorities) .....	54
Approval for custody transfer .....	54
Approvals .....	9

## B

Blocks .....	26
--------------	----

## C

Cable entries	
Degree of protection .....	21
Technical data .....	79
Cable specifications	
Remote version connecting cable .....	17
CE mark (Declaration of Conformity) .....	9
Certificates .....	9
Cleaning	
External cleaning .....	59
Code entry (function matrix) .....	27
Commissioning	
Current output .....	49
Quick Setup .....	42
Relay output .....	51
Zero point adjustment .....	52
Commubox FXA195 .....	60
Commubox FXA195 (electrical connection) .....	20
Communication .....	29
Connection	
See Electrical connection	
Current output	
Configuration active/passive .....	49
Technical data .....	78
Custody transfer measurement .....	54
Approval for custody transfer .....	54
Definition of terms .....	55
Disabling .....	58
Disabling custody transfer mode .....	58
Setting up .....	56
Setting up custody transfer mode .....	56
Special features of working in the custody transfer mode .....	54
Verification process .....	56

## D

Data back-up .....	48
Declaration of Conformity (CE mark) .....	9
Definitions of terms (custody transfer measurement) ..	55
Degree of protection .....	21, 80
Designated use .....	4, 77
Device description files .....	30
Device designation .....	6
Device parameters	
See "Description of Device Parameters" manual	
Disposal .....	76

Documentation .....	83
---------------------	----

## E

Electrical connection	
Cable specifications (remote version) .....	17
Commubox FXA195 .....	20
Degree of protection .....	21
HART handheld terminal .....	20
Post-connection check .....	22
Remote version .....	17
Error messages	
Confirming error messages .....	28
Process error (application error) .....	67
System error (device error) .....	63
Error types (system and process errors) .....	28
European Pressure Equipment Directive .....	82
Ex approval .....	82
External cleaning .....	59

## F

FieldCare .....	30
Fieldcheck (Test- und Simulationsgerät) .....	61
Frequency output .....	78
Function groups .....	26
Functions .....	26
Fuse, replacing .....	75
FXA193 .....	61
FXA195 .....	60

## G

Galvanic isolation .....	78
Grounding .....	16
Groups .....	26

## H

HART	
Command classes .....	29
Command No. .....	31
Electrical connection .....	20
Handheld terminal .....	30
HOME position (display operating mode) .....	23

## I

Incoming acceptance .....	10
Influence of medium pressure .....	79
Influence of medium temperature .....	79
Input signal .....	77
Installation .....	79
Installation conditions	
Dimensions .....	11
Vibrations .....	11
Installation instructions .....	79
Installation, commissioning and operation .....	4

## L

Length of connecting cable .....	79
Life Cycle Management .....	61

Load	78	Relay output	51
Local display		Repeatability	79
See Display		Repeatability (performance characteristics)	79
<b>M</b>		Repeated calibration due to legal metrology controls	54
Maintenance	59	<b>S</b>	
Material	81	Safety conventions	5
Maximum measured error	79	Safety instructions	4
Measured variables	77	S-DAT (HistoROM)	53
Measuring principle	77	Serial number	7–8
Measuring system	6	Shielding	16
<b>N</b>		Shock resistance	80
Nameplate		Signal on alarm	78
Connections	8	Software	
Sensor	7	Amplifier display	40
<b>O</b>		Spare parts	70
Operating conditions	79	Special features of working in the custody transfer mode	54
Operation		Standards, guidelines	82
Device description files	30	Status input	
FieldCare	30	Technical data	77
HART handheld terminal	30	Storage	10
Operational safety	4	Suitability for custody transfer measurement	54
Order code		Supply voltage (power supply)	78
Sensor	8	System error	
Transmitter	7	Definition	28
Output signal	78	Messages	63
<b>P</b>		<b>T</b>	
Performance characteristics		T-DAT (HistoROM)	53
Influence of medium pressure	79	T-DAT SAVE/LOAD (functionality)	48
Influence of medium temperature	79	Temperature ranges	
Maximum measured error	79	Ambient temperature	80
Repeatability	79	Storage temperature	80
Post-installation check (checklist)	15	Transmitter	
Power consumption	78	Electrical connection	18
Power supply (supply voltage)	78	Installing the wall-mount housing	13
Power supply failure	78	Turning the field housing (aluminum)	12
Pressure Equipment Directive	82	Transporting the sensor	10
Printed circuit boards (installation/removal)		Troubleshooting and remedy	62
Field housing	71	<b>V</b>	
Wall-mount housing	73	Verification process	56
Process error		Vibration resistance	80
Definition	28	Vibrations	11, 80
Process error messages	67	<b>W</b>	
Programming mode		W@M	61
Enabling	27	Wiring	16
Pulsating flow		See Electrical connection	
Quick Setup	43–44	<b>Z</b>	
Pulse output		Zero point adjustment	52
See Frequency output			
<b>Q</b>			
Quick Setup			
Commissioning	42		
Pulsating flow	43–44		
<b>R</b>			
Registered trademarks	9		

[www.addresses.endress.com](http://www.addresses.endress.com)

---