

Liquiline M CM42 Transmitter via PROFIBUS PA to the PlantPax Process Automation System

Using a 1788HP-EN2PA Linking Device



PlantPax
Process Automation System

Topic	Page
Preferred Integration	2
Application Overview	4
System Details	10
Installation	11
Configure EN2PA	22
Configure the Liquiline M CM42 Transmitter	46
Visualization	58
Additional Resources	63

Preferred Integration

Rockwell Automation and Endress+Hauser have strengthened their strategic alliance to provide complete process automation solutions that use best-in-class instrumentation, software, and control systems.

There are hundreds of different components in a typical plant: controllers, remote I/O, electrical drives, safety equipment, and sensors. Each must be integrated, configured, and optimized during start-up and operation. Recognizing the challenges this creates, Rockwell Automation and Endress+Hauser are focused on providing you with scalable, off-the-shelf solutions.

Endress+Hauser competence

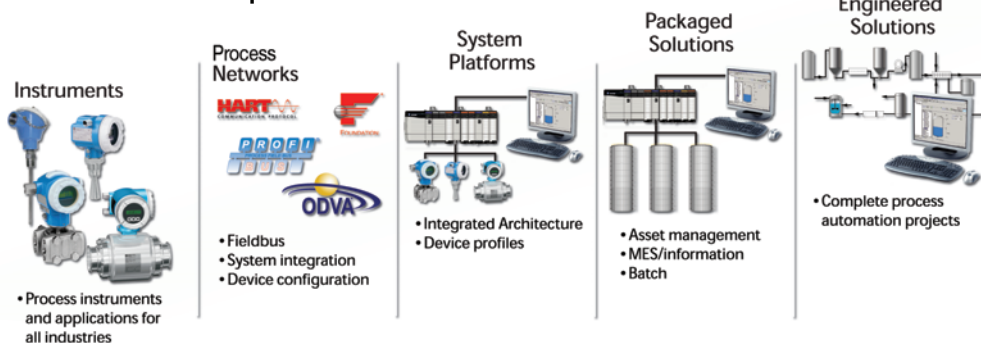

Rockwell Automation competence

To supply robust system solutions, Rockwell Automation pre-tests many third-party manufactured HART, FOUNDATION Fieldbus, and PROFIBUS PA field devices in the system test laboratory for compatibility with the Rockwell Automation PlantPAx process automation system. Each field device is connected to the PlantPAx system and is subjected to interoperability testing procedures similar to operating procedures in your plant. The results of each field test are recorded in a test report for integration planning purposes.

For Endress+Hauser field devices, an additional step provides an "Integration Document" and "Interoperability Statement" for each tested instrument. The Integration Document provides information on installation, configuration, startup, and operation of the integrated system. The Interoperability Statement is assurance that the Endress+Hauser field device meets PlantPAx system interoperability performance measures, as jointly established by Rockwell Automation and Endress+Hauser and verified through completion of common test procedures performed by either company. Both the Integration Document and Interoperability Statement help reduce risk with ease of integration.

The overall mission of the alliance is to provide you with proven solutions that combine field instrumentation with fieldbus networks, such as HART, FOUNDATION Fieldbus, and PROFIBUS PA networks, with asset management capabilities and Rockwell Automation's system capabilities to provide a total engineered solution.

Through preferred integration and support of increasing requirements for plant-wide control, the alliance offers the following benefits:

- Reduced integration costs throughout engineering, commissioning, and start-up
- Optimized plant availability and output
- Ensured product quality and consistency
- Optimized traceability to meet regulatory demands
- Predictive maintenance through intelligent instruments

For new construction, process improvements at an existing plant, or operating cost reductions, the alliance delivers the following:

- Preferred integration reduces risk, reduces integration costs, and protects investment with pre-engineered interoperability. Both companies believe open systems and standardized interfaces bring maximum benefits.
- Advanced diagnostics with plant-wide control provides better visibility of plant health and easier access to instrument diagnostics, which ultimately leads to faster troubleshooting and improves decision-making.
- Collaborative lifecycle management leads to improvements in design, engineering, and startup and support of plants. This collaboration increases productivity, manages information about instrumentation assets, optimizes plant assets, and results in a complete lifecycle management solution.

PlantPax
Process Automation System

Application Overview

This document provides a step-by-step approach to integrating an Endress+Hauser Liquiline M CM42 transmitter via PROFIBUS PA into a Rockwell Automation PlantPAx process automation system.

This Section	Describes
Application overview	Details about the field instrument and control system.
System details	Specifications on the required hardware and software components.
Installation	How to connect the measurement instrument to the EN2PA module.
Configuration	How to: <ul style="list-style-type: none"> • Configure the EN2PA module. • Configure the measurement instrument.
Visualization	How to implement and configure a graphical display of device information.

The ControlLogix platform provides a robust EtherNet/IP backbone for communication to process fieldbus networks. The PlantPAx architecture uses producer/consumer technology, allowing input information and output status to be shared by all ControlLogix controllers in the system.

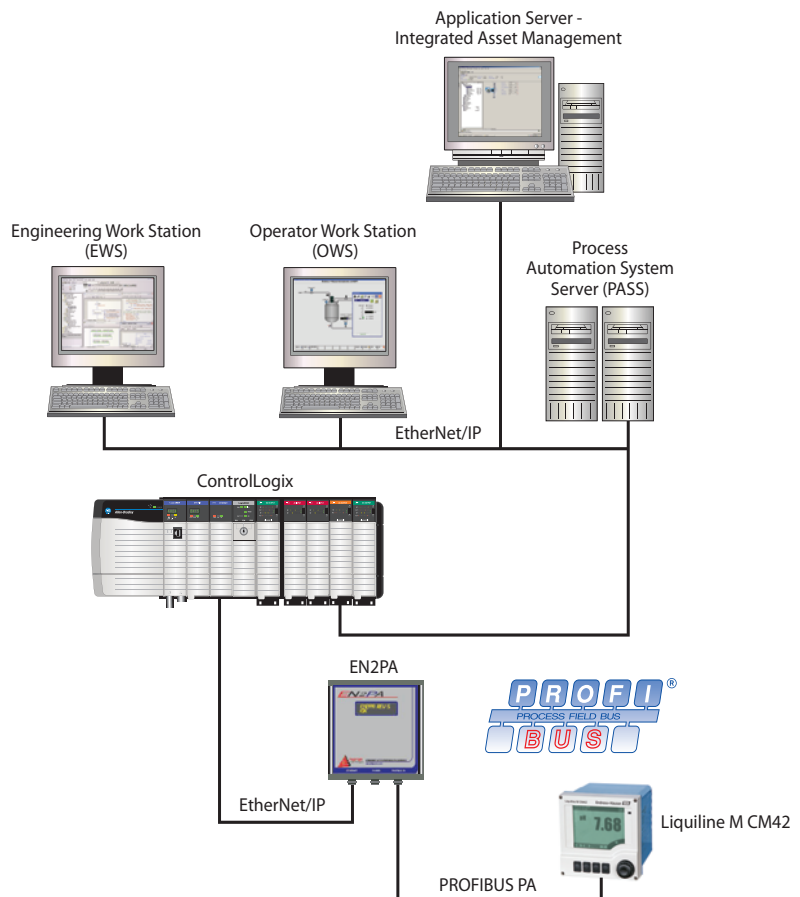

This integration document assumes you have a working knowledge of ControlLogix systems. For more details regarding the equipment and tasks described in this document, see [Additional Resources](#).

Liquiline M CM42 Transmitter

Liquiline M CM42 is a modular two-wire transmitter for all areas of process engineering. Depending on the ordered version, Liquiline has one or two analog current outputs or it can be connected to field buses. Liquiline is developed according to the international safety standard IEC 61508.

The extremely robust, corrosion-resistant plastic version and the hygienic stainless steel version are designed for the following applications:

- Chemical processes
- Pharmaceuticals industry
- Foodstuff technology
- Applications in hazardous locations

Your benefits:

- Cost-savings
 - Simple commissioning with Quick Setup and Navigator (multifunction button)
 - Thanks to Memosens technology, calibration in the plant is not required
 - Predictive maintenance system detects when a sensor has to be cleaned, calibrated or replaced
 - Less storage thanks to modular design
- Safe
 - Active display of cable interruption with Memosens version
 - Red alarm LED reports error immediately
 - User-guided commissioning, graphic display and plain text guidance
 - ATEX, FM, CSA, NEPSI
 - Code-protected commissioning and calibration
- Industry solutions
 - Modular concept: sensor module replaceable

Measuring System Examples

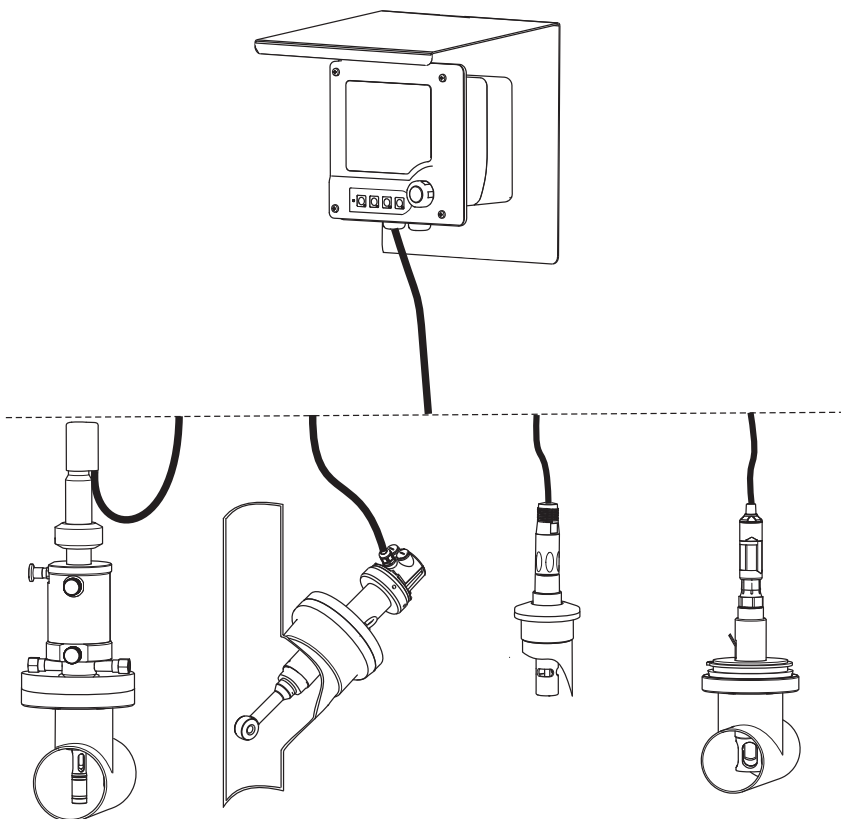

pH/ORP	Conductivity, Inductive Measurement	Conductivity, Conductive Measurement	Digital Sensor
<ul style="list-style-type: none"> • CM42-P/R... • Measuring cable CPK9 • Assembly Cleanfit CPA471 • Sensor Orbisint CPS11 	<ul style="list-style-type: none"> • CM42-I... • Assembly Dipfit CLA111 	<ul style="list-style-type: none"> • CM420C... • Measuring cable CPK9 • Sensor Condumax CLS16 	<ul style="list-style-type: none"> • CM42-M/N/O • Measuring cable CYK10 • Assembly Unifit CPA442 • Sensor CPS11D (pH: glass)/CPS471D (pH: ISFET)/COS21D (oxygen)

Measured Variables

pH / ORP (analog sensors)

- pH value
- Oxidation-reduction potential (ORP)
- Temperature

Conductivity (analog sensors)

- Conductivity
- Resistivity (conductive measurement only)
- Concentration

pH / ORP (digital sensors)

Oxygen (digital sensors)

- pH value
- Oxidation-reduction potential
- Oxygen
- Temperature

Signals from Instrument to Control System

Signal	Details	
Output signal	Max. load with a supply voltage of 24 V: 500 Ω Max. load with a supply voltage of 30 V: 750 Ω <ul style="list-style-type: none"> • PROFIBUS PA 	
Ex specification PROFIBUS PA and FOUNDATION Fieldbus	Suitable for use as a field device in a FISCO system.	
	Max. input voltage U_i	17.5 V
	Max. input current I_i	380 mA
	Max. input P_i	5.32 W
	Max. internal inductivity L_i	<10 μH
Max. internal capacity C_i	<5 nF	

Control System

The control system includes these components:

Component	Description
Controller	The ControlLogix controller is a modular, high performance controller, that uses RSLogix 5000 programming software to configure, program, and monitor a system. The ControlLogix controller is certified by TUV for SIL 1 and SIL 2 applications.
PROFIBUS PA linking device	The 1788HP-EN2PA is a PROFIBUS PA master linking an EtherNet/IP network to a PROFIBUS PA field device network capable of supporting process instrumentation. It is a true PA master linking directly to the PA network with built in PA power conditioners. The EN2PA and PA field devices are added directly into the RSLogix 5000 IO tree. The EN2PA supports FDT (Field Device Type) / DTM (Device Type Manager) technology.
Programming software	HSNetworxPA and RSLogix 5000 are the software tools used to create the configuration that will be stored in the Logix controller and the EN2PA and provide access to cyclic data to and from each field device. By using GSD files, from the field device manufacturer, HSNetworxPA is able to automatically configure each instrument on the network, transfer the configuration to the Logix controller and PA master which interpret the instrument specific data structures.
Visualization software	FactoryTalk View Site Edition software is an HMI software program for monitoring, controlling, and acquiring data from manufacturing operations throughout an enterprise. A generic display provides a graphical representation via faceplates of the field instrument connected to the EN2PA linking device.

Component	Description
Asset management software	<p>FactoryTalk AssetCentre, with a fully scalable design, provides a set of asset-centric focused tools for securely and centrally managing factory and process automation production environments. It secures access to the control system, tracks users' actions, managing asset configuration files, configuring process instruments, and provides backup and recovery of operating asset configurations.</p> <ul style="list-style-type: none"> • Change management — management of security, configuration and archiving of control assets. • Process device management — calibration and configuration for process instrumentation. • Condition monitoring — predict or prevent impending failures of process instrumentation with centralized device information. • Disaster recovery — for all assets and devices. <p>FactoryTalk AssetCentre is based on the open, industry-leading FDT/DTM technology integrated into the PlantPAx process automation system. It is a common environment and launch application for Device Type Manager (DTM). An expanding library of Device DTMs and an array of Communication DTMs are supported.</p> <hr style="border-top: 1px dashed black;"/> <p>FieldCare suite is Endress+Hauser's plant asset management solution based on a smart device configuration tool (FieldCare) integrated with a life cycle management tool (W@M).</p> <ul style="list-style-type: none"> • Easy to implement and to scale up into existing infrastructure. • Entire management of smart field devices supporting Ethernet, HART, PROFIBUS and in the next release FOUNDATION Fieldbus and wireless HART. • Supports the complete device life cycle management based on W@M starting with engineering through ordering, installation, configuration, commissioning, calibration, documentation management and spare parts handling. • Endures technology migration, by supporting all device DTMs but also through iDTM all DD based devices. It covers the complete scope of all smart devices. • Allows communication through third party systems supporting FDT/DTM technology. • Condition monitoring: used for preventive and predictive maintenance based on diagnostic information from field devices. <p>FieldCare suite enables you to step into the asset management world with a sustainable investment and offers the possibility to scale up to an integrated asset management solution.</p>

System Details

These components and specifications are recommended for preferred integration.

Hardware Components

Component	Catalog Number	Details
Liquiline M CM42 transmitter	CM42-MAA201EAS00	Firmware revision 10.04
ControlLogix controller	1756-L63 series B	Firmware revision 16.20
HIPROM 1788HP-EN2PA module	1788HP-EN2PA	Firmware revision 5.10

Software Components

Component	Catalog Number	Details
RSLogix 5000 Enterprise Series programming software, Professional edition Includes: <ul style="list-style-type: none"> • RSLinx Classic software • RSLinx Enterprise software 	9324-RLD700NXENE	Version 16.03
FactoryTalk View Site Edition (SE) software	9701-VWSXXXXXENE	Version 5, CPR 9
FactoryTalk AssetCentre server	9515-ASTSRVRENE	Version 15.21
FactoryTalk AssetCentre process device configuration	9515-ASTPRDCFENE	Version 15.21
FieldCare Standard Asset Management software (optional) Includes: <ul style="list-style-type: none"> • DTM library 	SFE551	Version 2.05
RSLinx Communication DTM software (optional)	1756-Backplane	Version 1.0.0
HSNetworxPA		Version 5.12

For specifications of the engineering workstation (EWS) and operator workstation (OWS), see the [Integrated Architecture for Process Control System Recommendations Manual, publication PROCES-RM001](#).

Installation

The following information is a summary of the installation procedures. See [Additional Resources](#) for complete installation instructions, including warnings.

Connect a Liquiline M CM42 Transmitter

Housing Grounding

You must connect the “Fixing plate” to the foundation ground with a separate functional ground line (2.5 mm² i14 AWG).

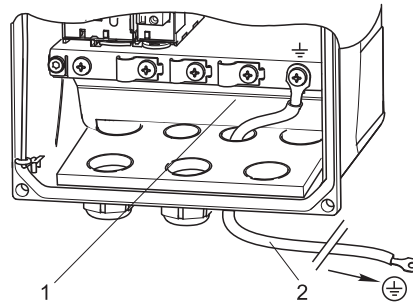

Item	Description
1	Fixing plate
2	2.5 mm ² (i14 AWG) functional ground

Stainless Steel Housing

You must connect the outer ground connection of the housing to the foundation ground with a separate line (GN/YE) ($\geq 2.5 \text{ mm}^2$ i14 AWG).

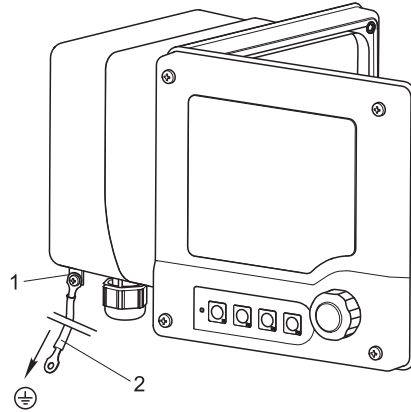

Item	Description
1	Outer ground connection
2	2.5 mm ² (i14 AWG) line (GN / YE)

Sensor Connection: pH / ORP

Following are figures of the glass electrodes with PML (symmetrical) view in device (CPU module) (left) and wiring diagram (right).

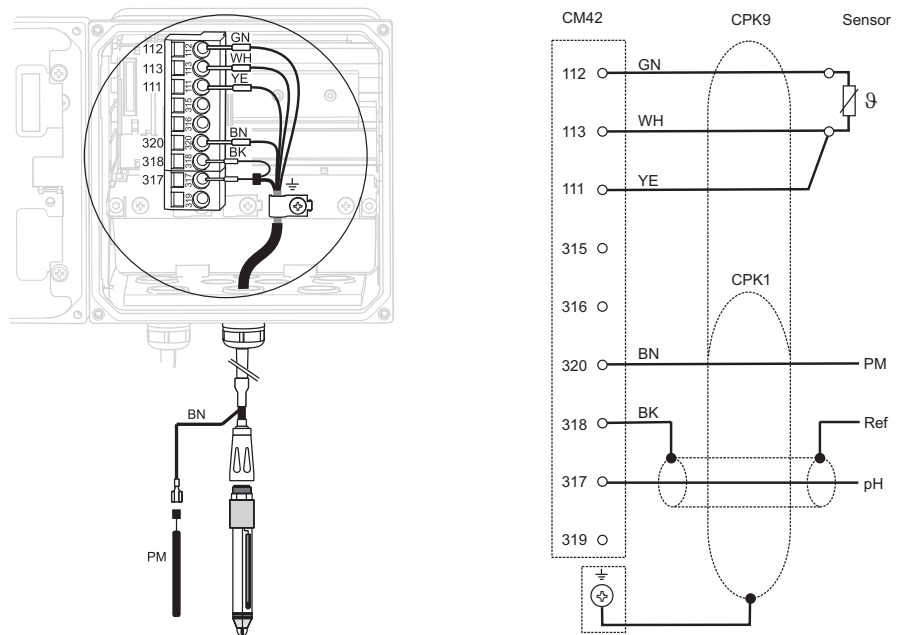

Following are figures of the glass electrodes without PMI (symmetrical) view in device (CPU module) (left) and wiring diagram (right).

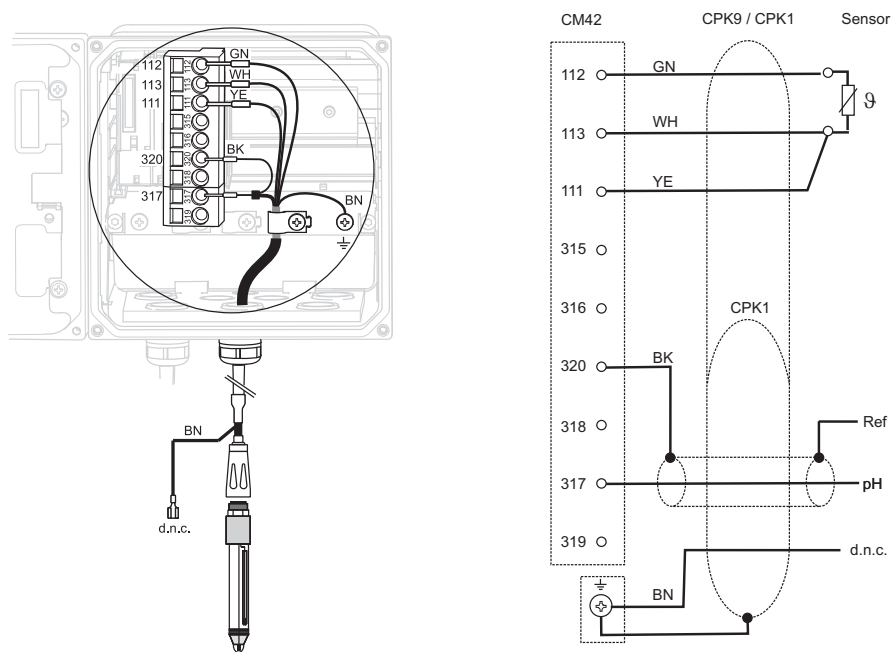

Following are figures of the ISFET sensors with PMI view in device (CPU module) (left) and wiring diagram (right).

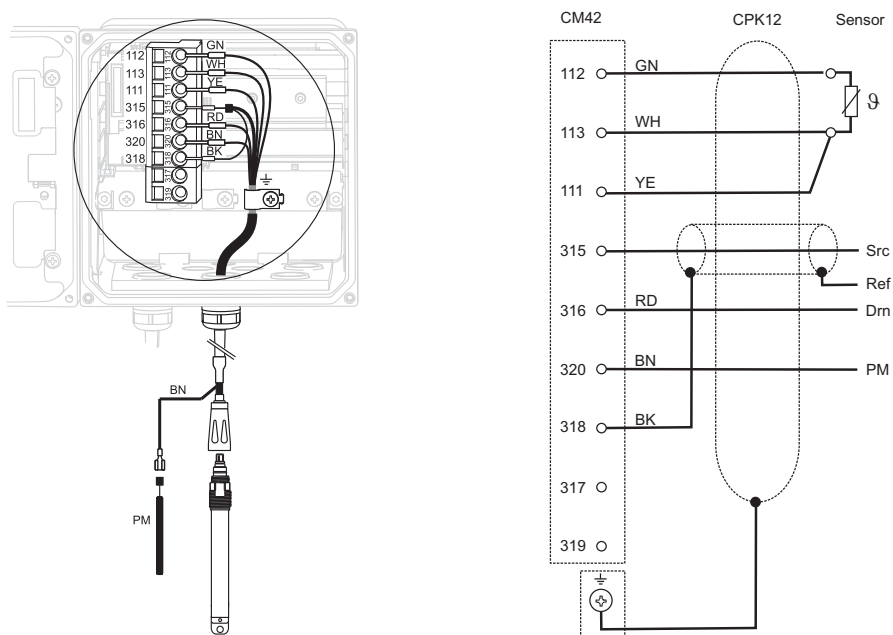

Following are figures of the ISFET sensors without PML view in device (CPU module) (left) and wiring diagram (right).

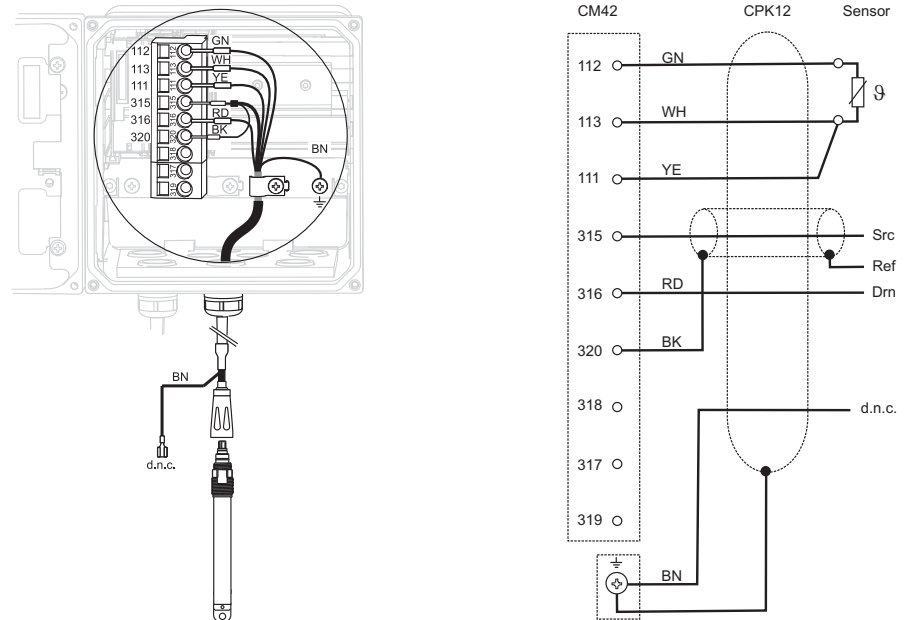

Following are figures of the Pfaudler electrode absolute wiring diagram (left) and the relative wiring diagram (type 18 / type 40 / Reiner) (right).

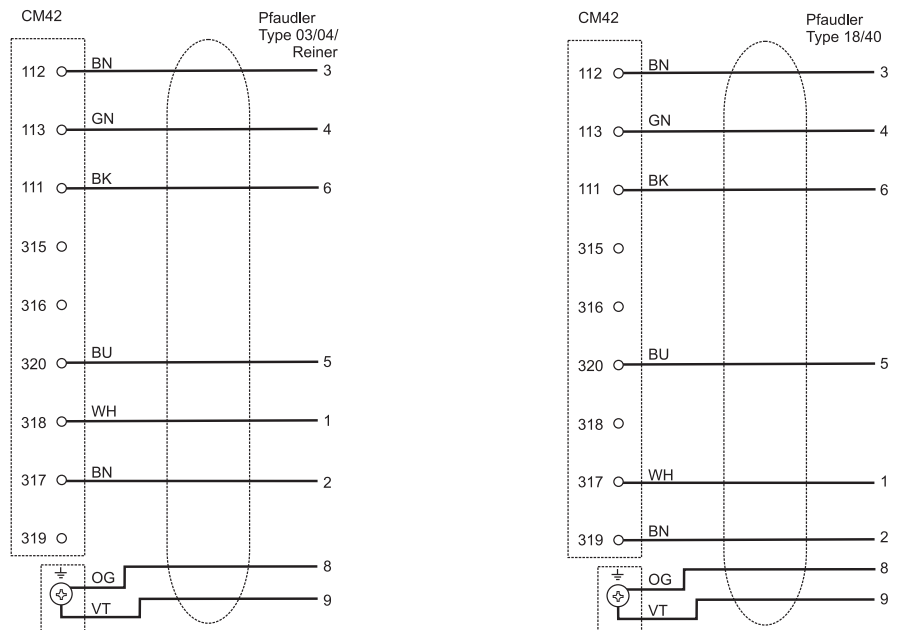

Sensor Connection: Conductivity

Following are figures of the conductive sensors, two-electrode sensors view in device (left) and wiring diagram (right).

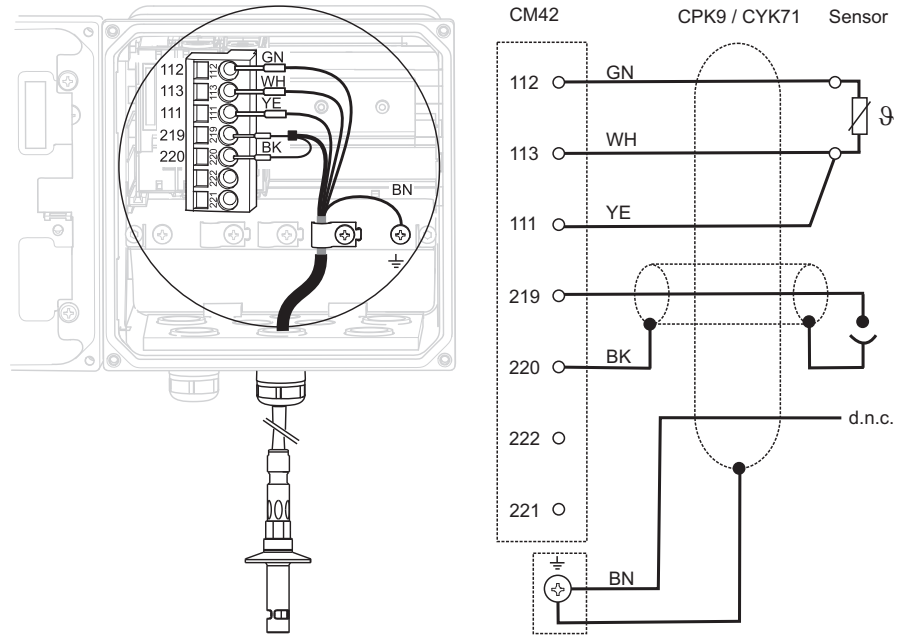

Following are figures of the conductive sensors, four-electrode sensors view in device (left) and wiring diagram (right).

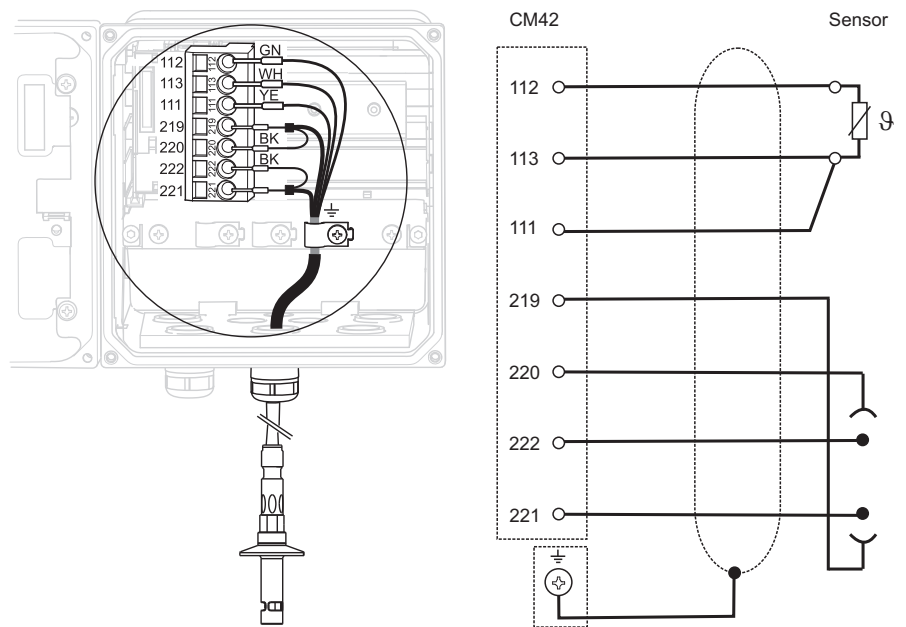

Following are figures of the inductive sensors view in device (left) and wiring diagram (right).

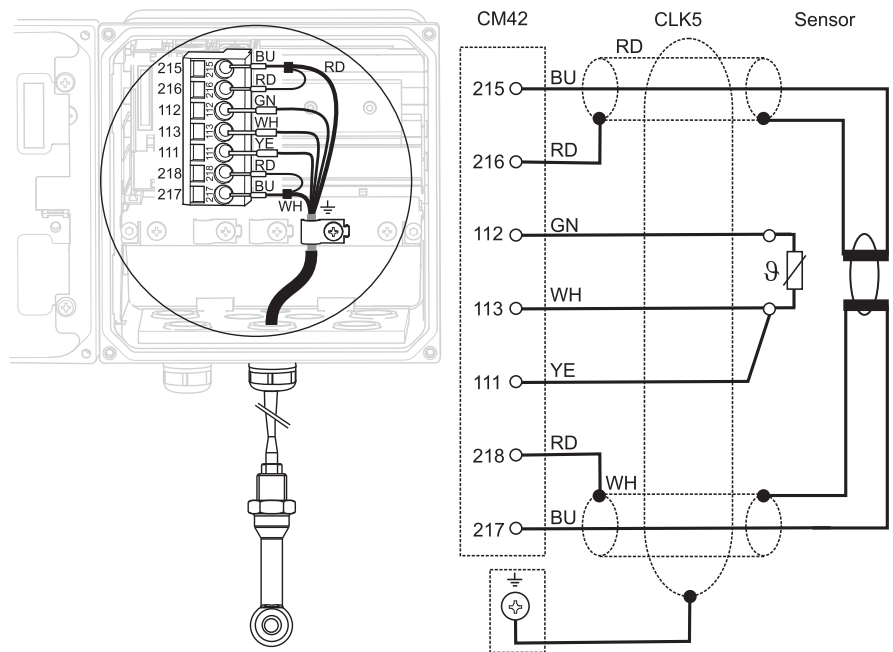

Sensor Connection: pH / ORP / ISFET / Oxygen (digital sensors)

Following are figures of the sensor connections: pH / ORP / ISFET / oxygen (digital sensors) view in device (left) and wiring diagram (right).

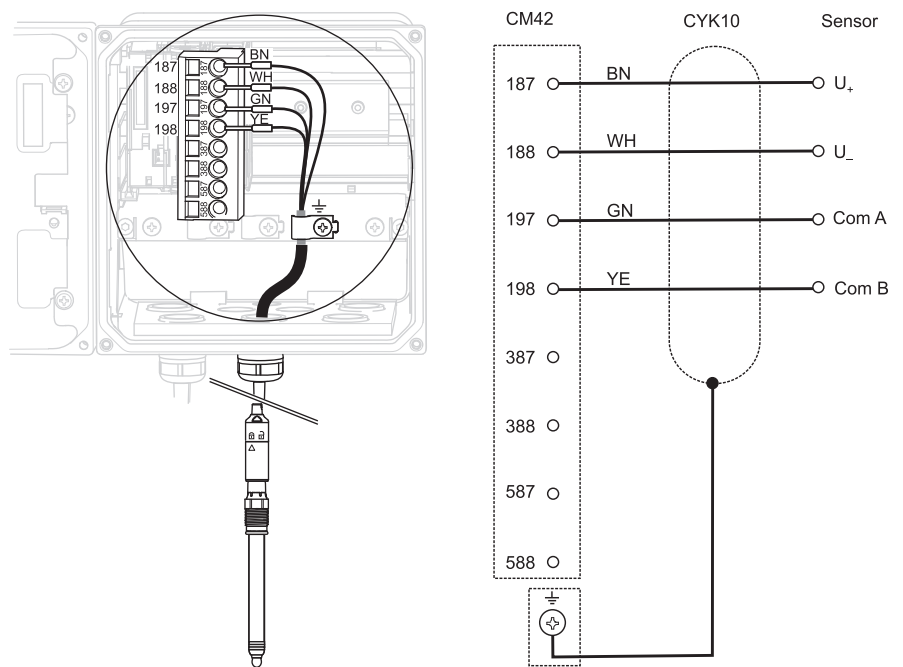

Supply and Signal Circuit

Note: Always use a Fieldbus cable that is grounded on both sides (device and PCS).

You can connect PROFIBUS devices in various ways:

1. Shielded two-wire cable, “Hard grounding” (generally to be preferred to capacitive grounding).
2. Shielded two-wire cable, “Capacitive grounding” (shield grounded in device via a capacitor, accessory “C module” necessary).
Use it if there is a risk of high equalizing currents. Not applicable for Ex versions!
3. Using the Fieldbus connection socket (accessories).

Hard Grounding

- Place the cable shield on the “Fixing plate.”
- Connect the cable wires as per the assignment.

Following are figures of the view in device (CPU module) (left) and the wiring diagram (right).

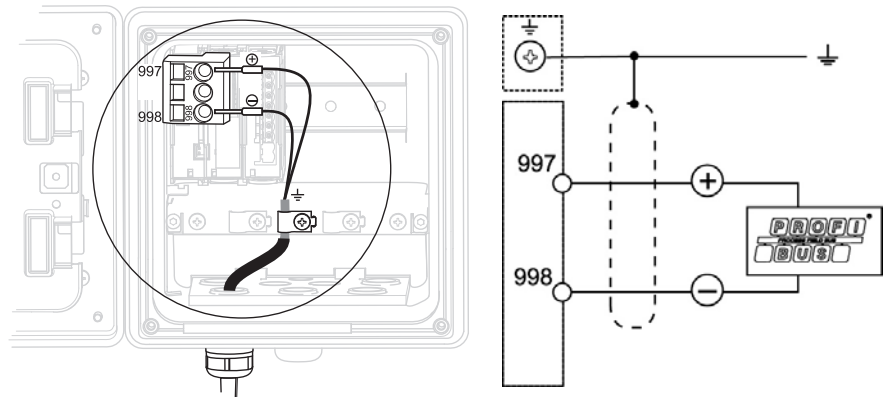

Capacitive Grounding

- Strip back the shield braiding, push the extension wire of the C module (pos. 1) onto the exposed shield, and fasten the clip:

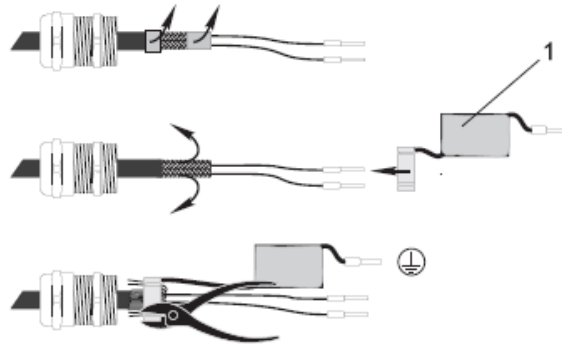

- Place the extension wire on the "Fixing plate."
- Connect the cable wires as per the assignment.

Following are figures of the view in device (CPU module) (left) and the wiring diagram (right).

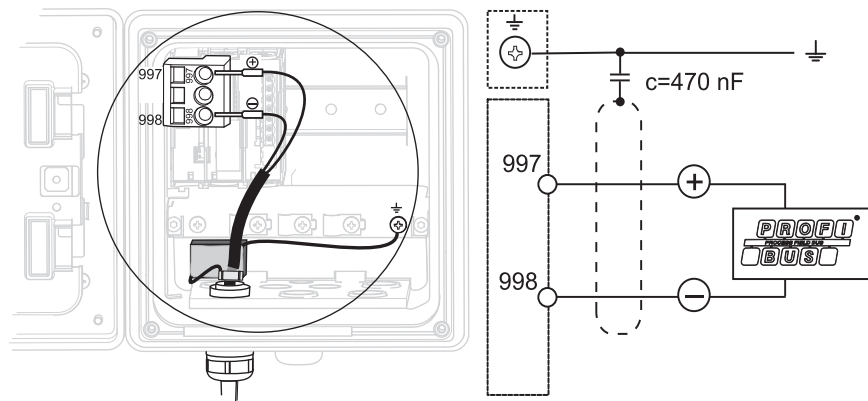

Fieldbus Connection Socket

1. Screw the fieldbus connection socket (accessories) into the housing bushing.
2. Trim the connection cores of the socket to approximately 15 cm (5.9 ").
3. Connect the cable cores as per the assignment. In doing so, you must place the cable shield (GN/YE) on the "Fixing plate."

Following are figures of the view in device (CPU module) (left) and the wiring diagram (right).

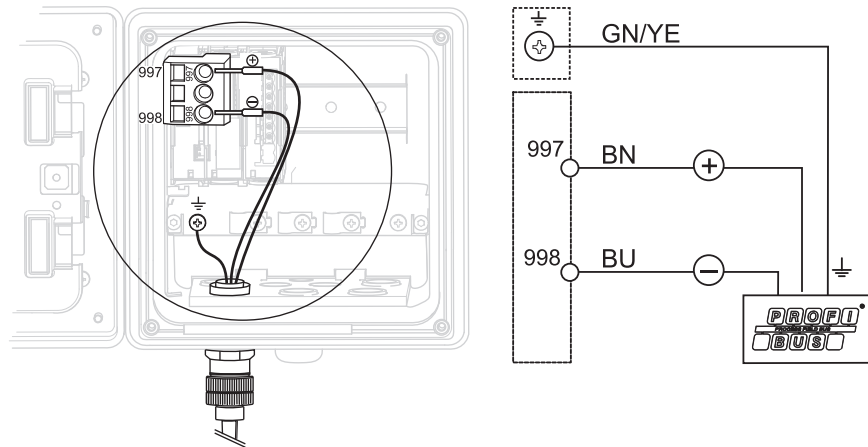

Fieldbus Connector

The connection technology of PROFIBUS PA allows measuring devices to be connected to the fieldbus via uniform mechanical connections, such as T-boxes, distribution modules, etc. This connection technology, which uses prefabricated distribution modules and plug-in connectors, offers substantial advantages over conventional wiring.

- Field devices can be removed, replaced or added at any time during normal operation. Communication is not interrupted.
- Installation and maintenance are significantly easier.
- Existing cable infrastructures can be used and expanded instantly, e.g. when constructing new star distributors using 4-channel or 8-channel distribution modules.

The device can therefore be supplied with the option of a ready-mounted fieldbus connector. Fieldbus connectors for retrofitting can be ordered from Endress+Hauser as a spare part. Please see [Endress+Hauser Support](#) and contact your representative.

M12 connector

- Four-pole metal connector for mounting on transmitter
- For connecting to connection box or cable jack

Connect a Field Instrument to EN2PA

The 1788HP-EN2PA linking device is designed to operate within the Rockwell Automation PlantPax system using EtherNet/IP as the communication backbone to the PROFIBUS PA process device network. All power required for the module's operation is derived from an external 24V power supply. For current consumption, please refer to electrical specifications in the EN2PA user manual.



PA BUS: Connector Pin 1 → PA “+” terminal, Connector Pin 3 → PA - terminal. Pin 4 is used for the cable shield.

24V Power Supply: Connector Pin 1 → “+” terminal, Connector Pin 2 → “-” terminal.

Ethernet: Connector Pin 1 & 3 and Connector Pin 2 & 4 are twisted pairs.

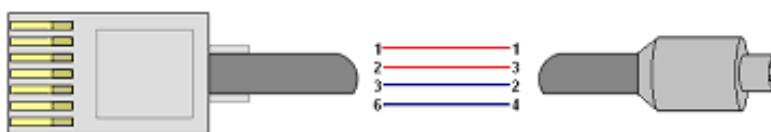

The positive terminal of the 1788HP-EN2PA's PROFIBUS PA connector must be connected to the positive terminal of all connected PROFIBUS PA instruments.

WARNING

If the positive and negative terminal of the EN2PA is not correctly connected to the positive and negative terminals of the respected PROFIBUS PA field devices it may cause permanent damages to the connected instruments.

IMPORTANT

The EN2PA module should be connected to a properly terminated network.

The current status of the linking device is conveyed to the user by means of the LCD display.

The following information is stored in the EN2PA and is available to the PlantPAx process automation system.

- Eight Input process variables (PVs) and eight Output PVs from up to 16 PROFIBUS PA field devices
- Diagnostics from the 1788HP-EN2PA module
- Extended diagnostics of each PROFIBUS field device

The EN2PA and field devices can be connected through a junction box (complying with IEC61158-2), such as the 1788HP-PAJB-4.

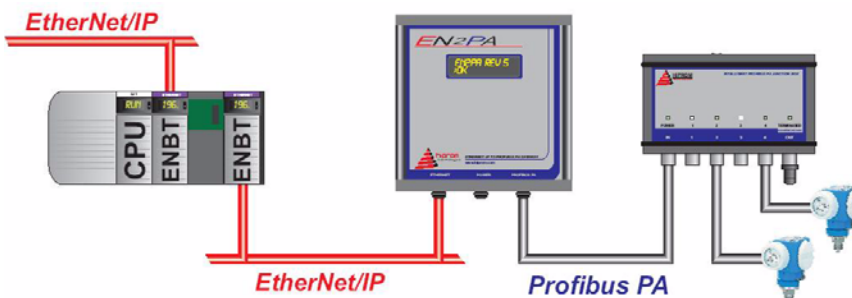

Configure EN2PA

A direct connection between the controller and the 1788HP-EN2PA is required to transfer data to and from the EN2PA.

IMPORTANT

Please make sure to install the EDS file for the EN2PA.

Establishing the Direct Connection

This section describes the procedures required to configure the EN2PA within the PlantPAx process automation system. Each EN2PA is owned by a single Logix controller. The 1756 Generic EtherNet/IP CIP Bridge is used in RSLogix 5000 to provide an interface for the PROFIBUS PA fieldbus network. Once this is added, a Generic CIP module is used to configure the master and each field device. The configuration is described in the tables below.

PA Master

Data Format		
CommFormat	Data - DINT	
Connection Parameters		
Description	Instance	Size
Input	65	4 (32 Bit)
Output	66	1 (32 Bit)
Configuration	68	4 (8 Bit)
Recommended RPI	150.0 ms (network dependent)	

Field Device

Data Format		
CommFormat	Data - DINT	
Connection Parameters		
Description	Instance	Size
Input	65	26 (32 Bit)
Output	66	10 (32 Bit)
Configuration	68	50 (8 Bit)
Recommended RPI	150.0 ms (network dependent)	

The following are the steps required to build a PROFIBUS PA tree in RSLogix 5000.

1. Right-click the 1756 Backplane and select New Module.

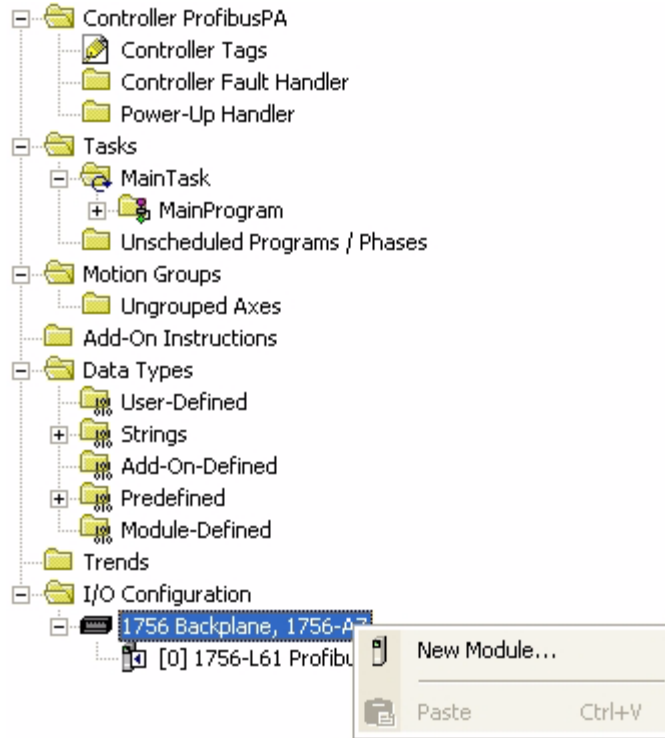

2. Select 1756-ENBT/A or 1756-EN2T/A.

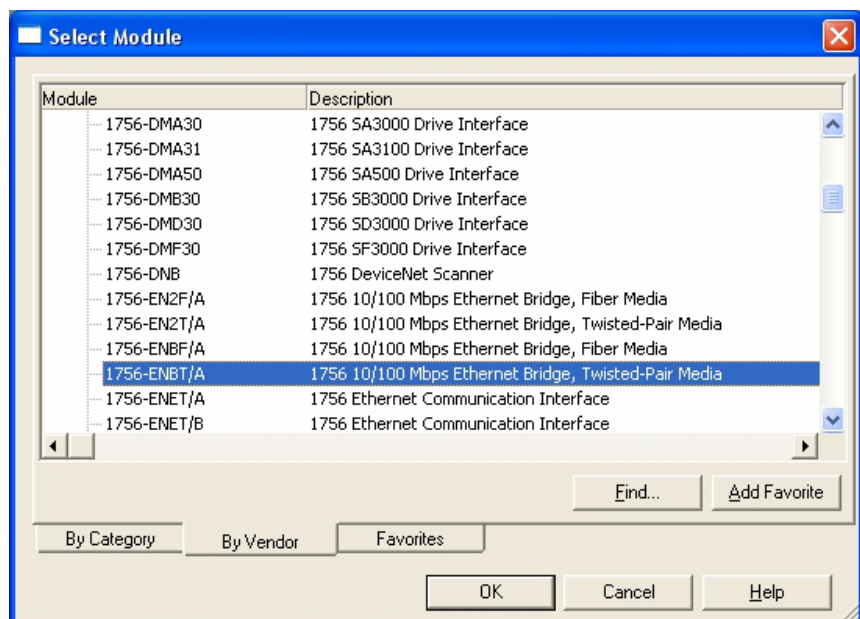

3. Configure the Ethernet Bridge.

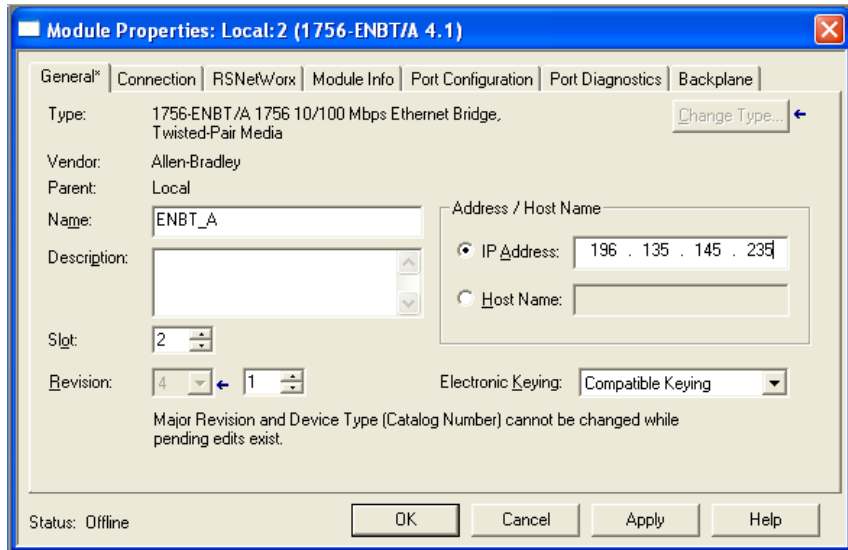

4. Right-click the Ethernet tree and select New Module.

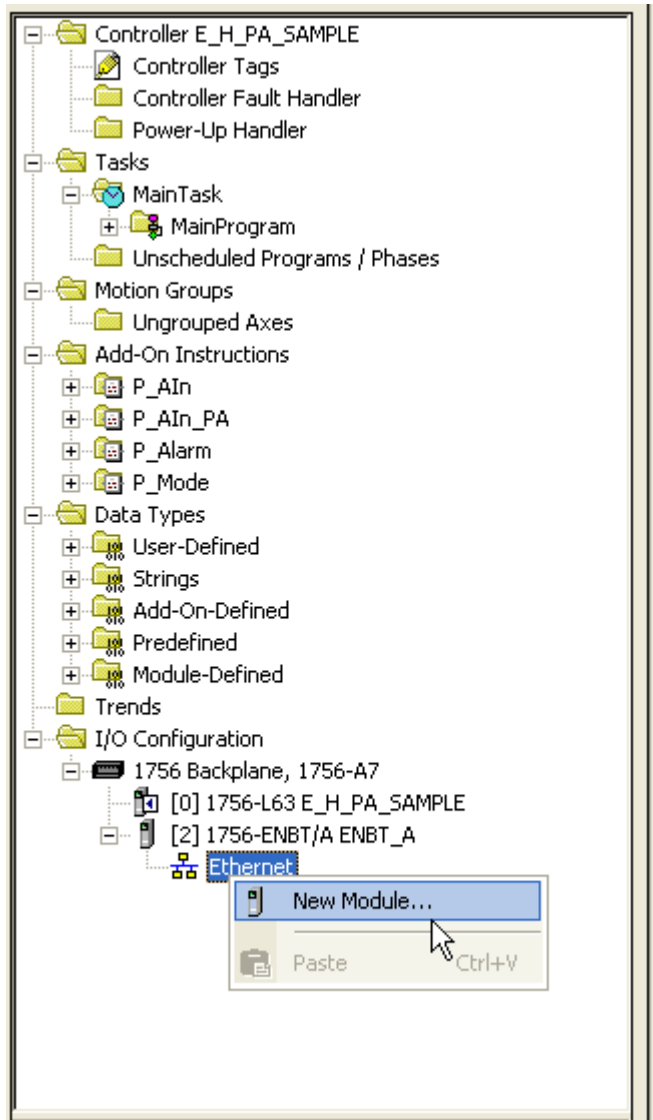
**IMPORTANT**

The name of the Ethernet Bridge in the RSLogix 5000 project must match the name of the PA Master in HSNetworkPA.

5. Select Generic EtherNet/IP CIP Bridge.

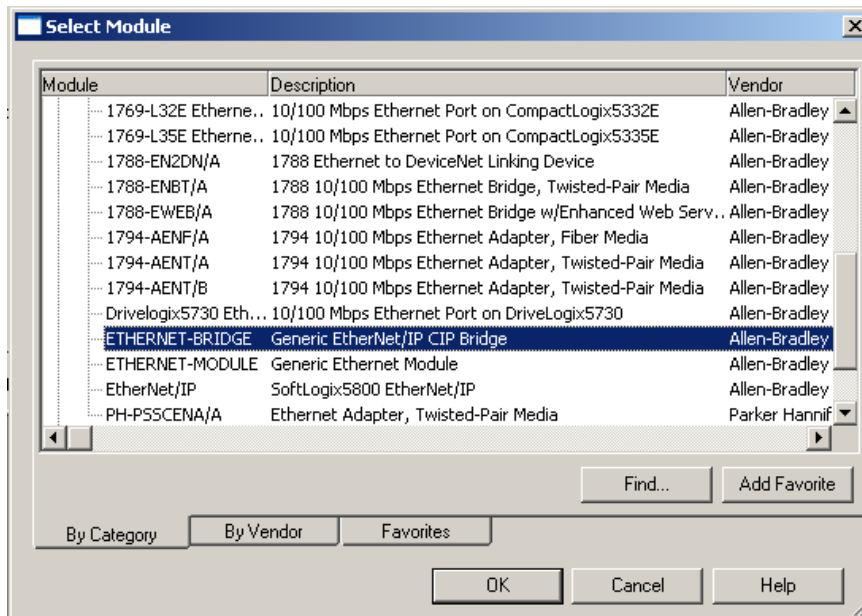

6. Configure the Generic EtherNet/IP CIP Bridge.

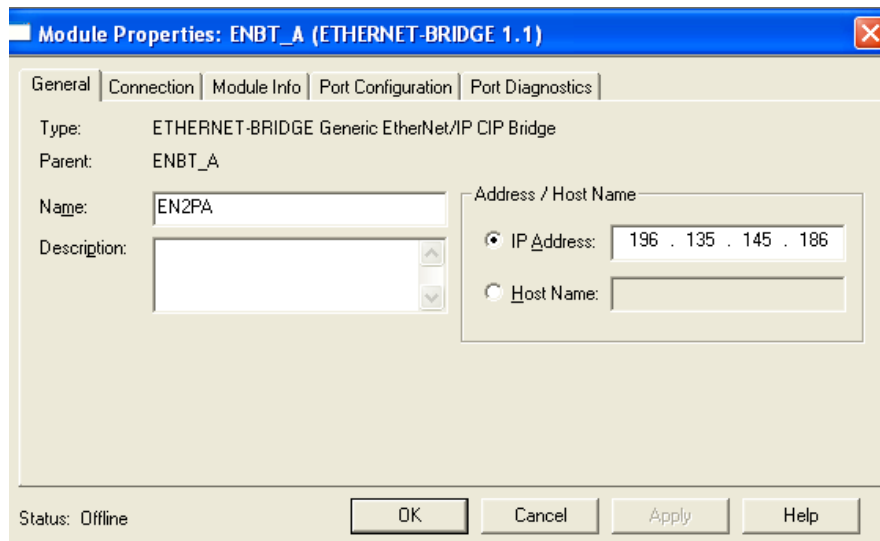

IMPORTANT The IP address of the Generic EtherNet/IP CIP Bridge in the RSLogix 5000 project must match the IP address of the EN2PA module.

7. Right-click the CIP Bus tree and select New Module.

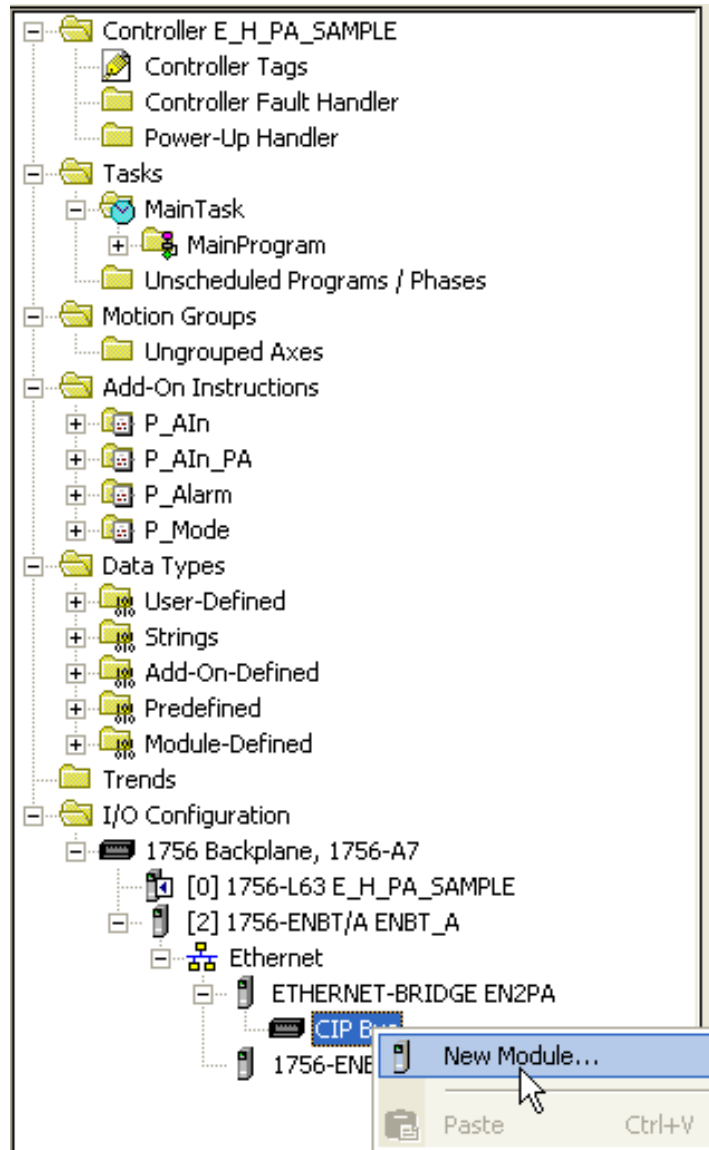

8. Select Generic CIP Module.

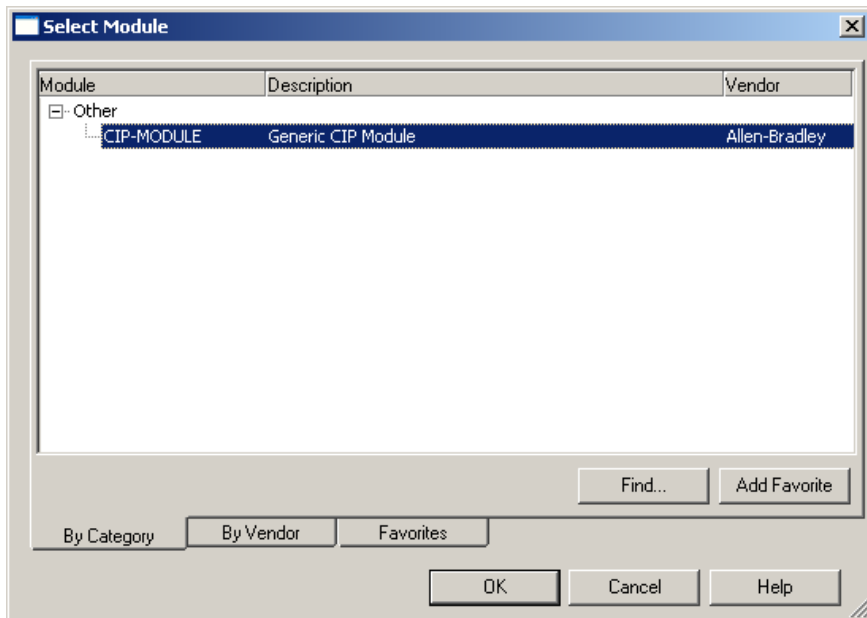

9. Configure the PA master parameters.

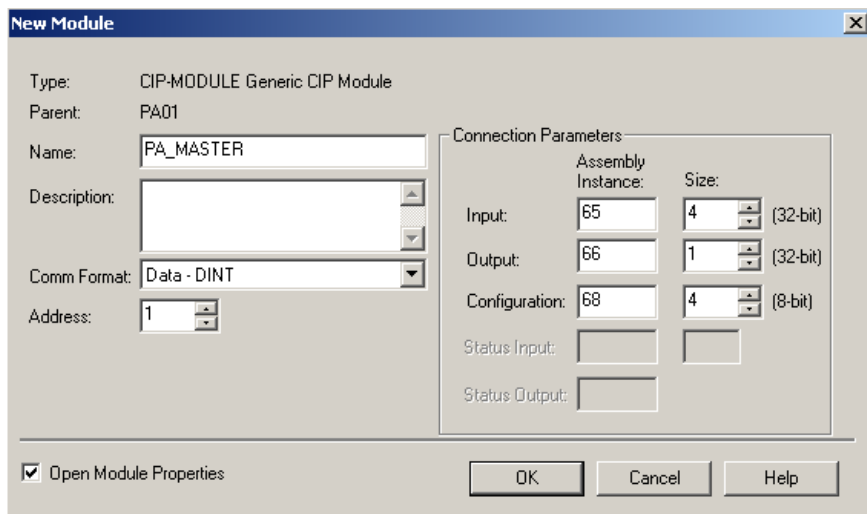

IMPORTANT

The address of the PA master must be the same as the EN2PA PROFIBUS PA node number. It is recommended that the user use the default address value 1.

10. Enter the recommended RPI of 150 ms for the PA master as indicated on page 22.

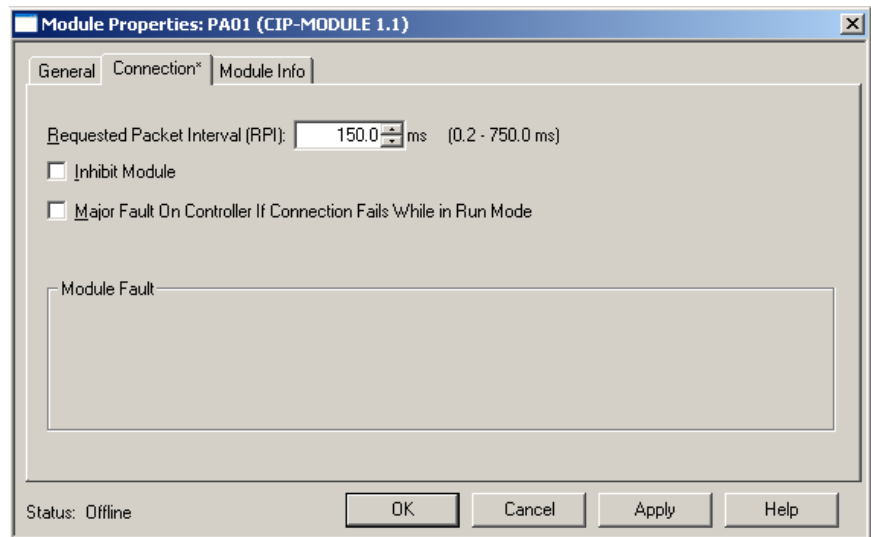

11. Configure the PROFIBUS field device parameters based on the recommendations on page 22.

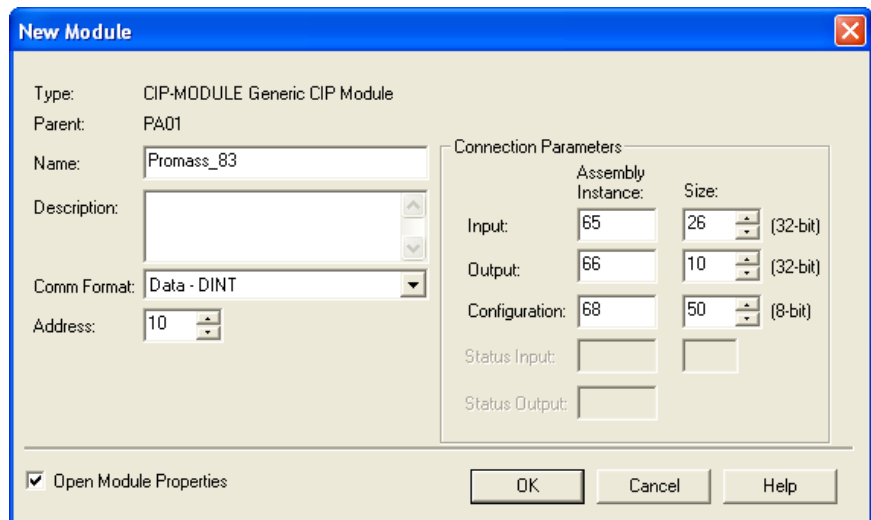

IMPORTANT

The recommended RPI of a PROFIBUS PA field device is the same as the PA Master, 150 ms. The address of each field device must be the same as the block and address selected in HSNetworkPA. This will ensure that the correct configuration is downloaded to the correct device and that the intended field device data is displayed in the correct *Generic CIP Module*.

The connection between the controller and 1788HP-EN2PA will fail if:

- The specified size of the Input, Output, or Configuration is incorrect
- The assembly instance of the Input, Output, or Configuration is incorrect
- An RPI is not set to recommended or reasonable interval

Download to the Logix Controller

1. After completing the RSLogix 5000 project and saving it to an offline file, go to the Communications tab.

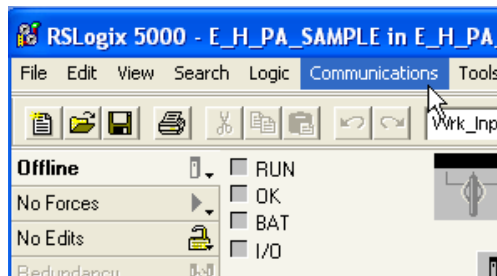

2. From the Communications tab, select Who Active. Who Active shows the RSLinx Classic communications driver that provides an Ethernet connection between the RSLogix 5000 engineering workstation and the controller.

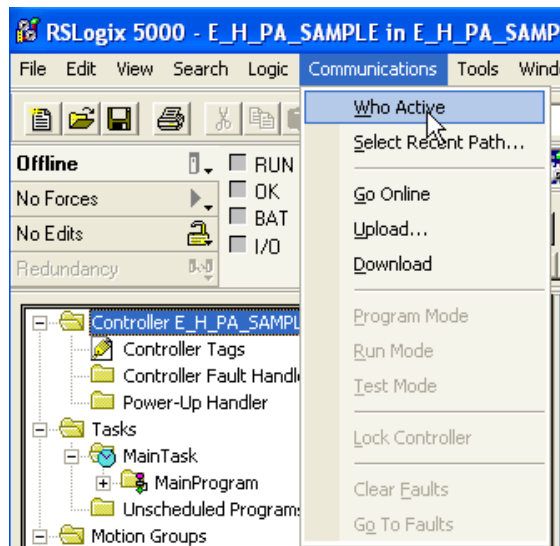

3. Select the controller and Download button.

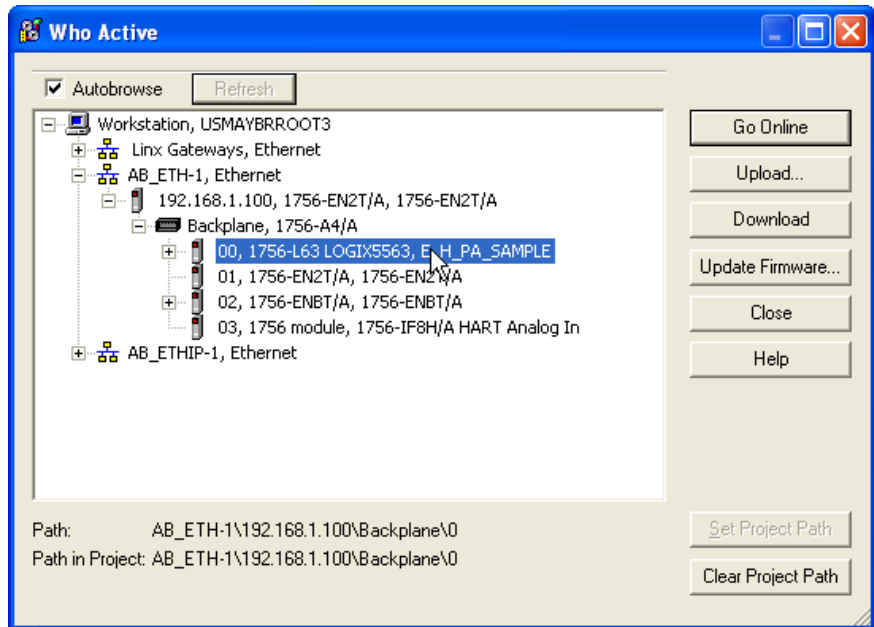

4. After the download completes successfully, place the controller in Run mode using the prompt or keyswitch.

IMPORTANT

The IO connection light blinks meaning that the EN2PA and controller connections must be configured using HSNetworkPA. Go to [Configure via HSNetworkPA](#).

The UDTs must be copied from the Hiprom supplied RSLogix 5000 file SAMPLE.ACD. This file is on the CD-ROM supplied with the EN2PA and downloadable from the Hiprom website, www.hiprom.com.

RSLogix 5000 Project File

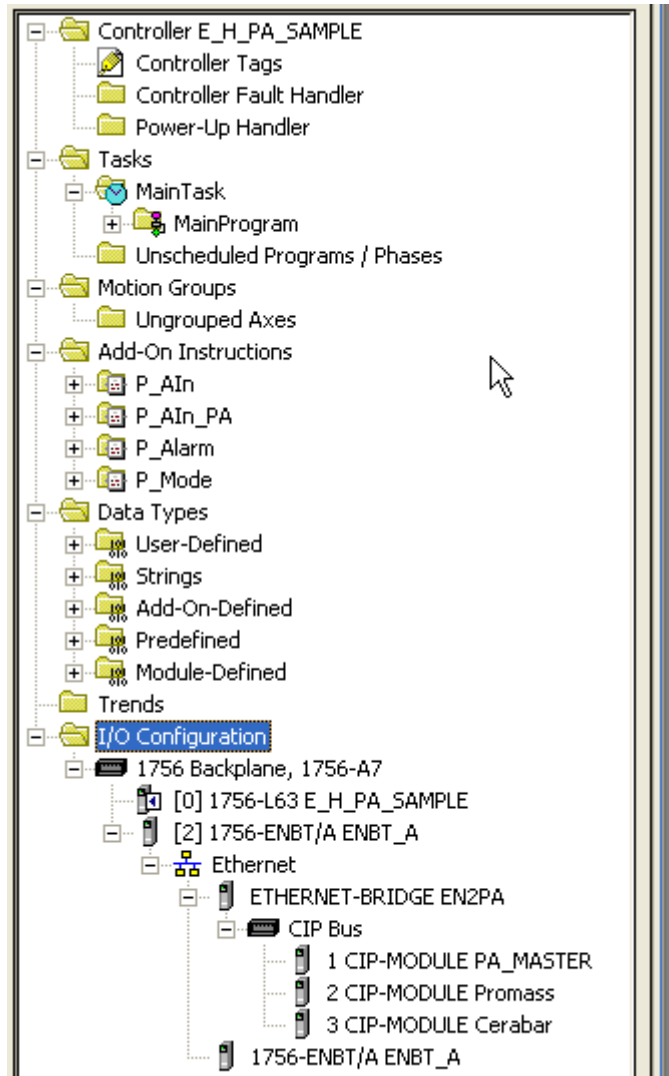

Controller Tag Database

Name	Value	Style	Data Type
PA01:1:C	{...}		AB:1756_MODULE:C:0
PA01:1:I	{...}		AB:1756_MODULE_DINT_16Bytes:I:0
PA01:1:O	{...}		AB:1756_MODULE_F_DINT_4Bytes:O:0
PA01:10:C	{...}		AB:1756_MODULE:C:0
PA01:10:I	{...}		AB:1756_MODULE_DINT_104Bytes:I:0
PA01:10:O	{...}		AB:1756_MODULE_DINT_40Bytes:O:0
Promass_83_PV	{...}		PAField_InputImage

Promass 83 Data, Status and Diagnostic Tags

Name	Value	Style	Data Type
Promass_83_PV	{...}		PAField_InputImage
Promass_83_PV.PVReal	{...}		zzzPAField_PVReals
Promass_83_PV.PVReal.PV1	0.0	Float	REAL
Promass_83_PV.PVReal.PV2	0.0	Float	REAL
Promass_83_PV.PVReal.PV3	0.0	Float	REAL
Promass_83_PV.PVReal.PV4	3.10746662...	Float	REAL
Promass_83_PV.PVReal.PV5	3.11535579...	Float	REAL
Promass_83_PV.PVReal.PV6	25.077698	Float	REAL
Promass_83_PV.PVReal.PV7	651.1628	Float	REAL
Promass_83_PV.PVReal.PV8	295.37155	Float	REAL
Promass_83_PV.PVIntegers	{...}		zzzPAField_PVInts
Promass_83_PV.PVStatus	{...}		zzzPAField_PVStatus
Promass_83_PV.PVStatus.PV1	-128	Decimal	SINT
Promass_83_PV.PVStatus.PV2	-128	Decimal	SINT
Promass_83_PV.PVStatus.PV3	-128	Decimal	SINT
Promass_83_PV.PVStatus.PV4	-128	Decimal	SINT
Promass_83_PV.PVStatus.PV5	-128	Decimal	SINT
Promass_83_PV.PVStatus.PV6	-128	Decimal	SINT
Promass_83_PV.PVStatus.PV7	-128	Decimal	SINT
Promass_83_PV.PVStatus.PV8	-128	Decimal	SINT
Promass_83_PV.Diagnostics	{...}		zzzPAField_Diagnostics
Promass_83_PV.Diagnostics.UnLine	0	Decimal	BOOL
Promass_83_PV.Diagnostics.Ready	0	Decimal	BOOL
Promass_83_PV.Diagnostics.ConfigFault	0	Decimal	BOOL
Promass_83_PV.Diagnostics.ExtDiag&v1	0	Decimal	BOOL
Promass_83_PV.Diagnostics.DiagSupport	0	Decimal	BOOL
Promass_83_PV.Diagnostics.InvalidSlaveResponse	0	Decimal	BOOL
Promass_83_PV.Diagnostics.ParameterFault	0	Decimal	BOOL
Promass_83_PV.Diagnostics.MasterLock	0	Decimal	BOOL
Promass_83_PV.Diagnostics.ParameterReq	0	Decimal	BOOL
Promass_83_PV.Diagnostics.StationDiag	0	Decimal	BOOL
Promass_83_PV.Diagnostics.WatchDog	0	Decimal	BOOL
Promass_83_PV.Diagnostics.FreezeMode	0	Decimal	BOOL
Promass_83_PV.Diagnostics.SyncMode	0	Decimal	BOOL
Promass_83_PV.Diagnostics.ExtDiagOverflow	0	Decimal	BOOL
Promass_83_PV.Diagnostics.Ident	16#152a	Hex	INT

Promass 83 Extended Diagnostic Data

Promass_83_PV.Diagnostics.ExtDiagnostics	{...}	Binary	DINT[6]
Promass_83_PV.Diagnostics.ExtDiagnostics[0]	2#0000_000...	Binary	DINT
Promass_83_PV.Diagnostics.ExtDiagnostics[1]	2#0000_000...	Binary	DINT
Promass_83_PV.Diagnostics.ExtDiagnostics[2]	2#0000_000...	Binary	DINT
Promass_83_PV.Diagnostics.ExtDiagnostics[3]	2#0000_000...	Binary	DINT
Promass_83_PV.Diagnostics.ExtDiagnostics[4]	2#0000_000...	Binary	DINT
Promass_83_PV.Diagnostics.ExtDiagnostics[5]	2#0000_000...	Binary	DINT

Information on the diagnostic and extended diagnostic bits can be found in the extended GSD file for the device.

IMPORTANT

Make sure you have the correct GSD file corresponding to the firmware version of the field instrument.

Configure via HSNetworkxPA

HSNetworkxPA is software used to create the configuration stored in the Logix controller and EN2PA for access to field device cyclic data. It is supplied with the EN2PA HSNetworkxPA on a CD-ROM or can be downloaded from the Hiprom website, www.hiprom.com. It must be installed on a personal computer running MS Windows XP. Typically HSNetworkxPA and RSLogix 5000 are on the same computer, such as an Engineering Workstation.

HSNetworkxPA

The following will describe how HSNetworkxPA will be used to scan the bus, view instrument diagnostic and configuration information, install GSD files, modify EN2PA parameters, and download configuration data to both the Logix controller and EN2PA.

IMPORTANT

The GSD file for a device must be in the GSD library before it can be added in HSNetworkxPA. This is done by selecting Import GSD Files under the GSD Wizard tab in the HSNetworkxPA. Select a GSD file and click Open.

Program Startup

1. Start HSNetworkxPA and a blank screen appears.

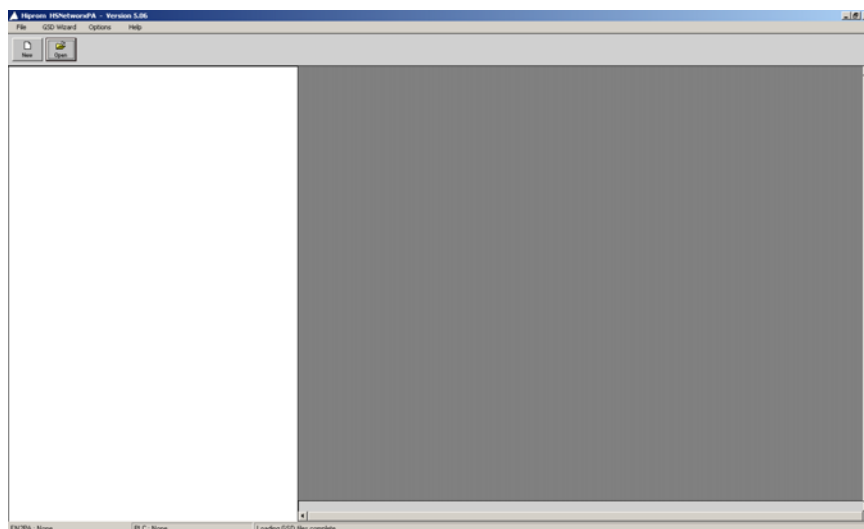

2. Create a new project by clicking the New button. A new project window appears.

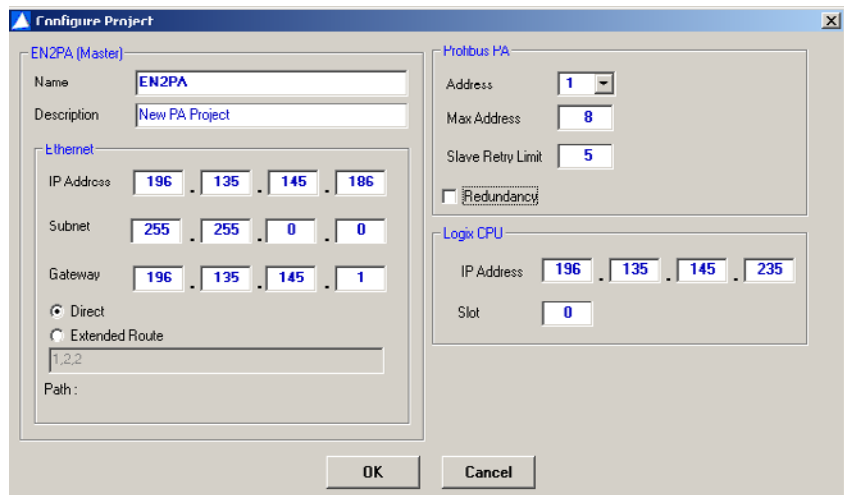

3. Enter the project name and description of the project that needs to be created.

IMPORTANT

The project name must be the same as the name of the Generic Ethernet/IP CIP Bridge module added in RSLogix 5000.

4. Under the Ethernet tab, enter the EN2PA IP Address, Subnet mask, and Gateway (if the module is powered, the IP Address, Subnet mask, and Gateway will be displayed on the LCD display).

IMPORTANT

The EN2PA IP Address, Subnet mask, and Gateway must match the actual node address of the EN2PA.

IMPORTANT

For each EN2PA installed, make sure to enter a different IP address based on your network requirements.

5. Select the appropriate option that describes the connection to the EN2PA. Select Direct when the PC with HSNetwork and the EN2PA are on the same network. Select Extended Route when the PC with HSNetwork and the EN2PA are on different Ethernet networks (if the user has the LAN network on one ENBT and the EN2PA Ethernet network on another ENBT).

IMPORTANT

Extended Route is the preferred way of connecting the EN2PA because it keeps the local network from increasing traffic on the control network.

6. When selecting Extended Route, enter the path configuration including “destination slot entering chassis” (1), “destination slot exiting chassis” (2) and “comms media (Ethernet=2)” (2). In this example, connection to the supervisory Ethernet network is slot 1 and connection to the IO Ethernet is slot 2.
7. Under PROFIBUS PA, select the PA master Address (this has to be the same as the address selected in RSLogix 5000), the max address used when scanning the bus (maximum of 18, as network will include no more than 17 devices - 16 PA instruments and a single PA master) and the retries when requesting data from a field device (usually remains at default).
8. Enter the IP address of the Logix controller. Indicate the slot number of the EtherNet/IP module within the ControlLogix chassis.
Note: Redundancy is only available with Version 6.
9. Select OK and the new project will be created.

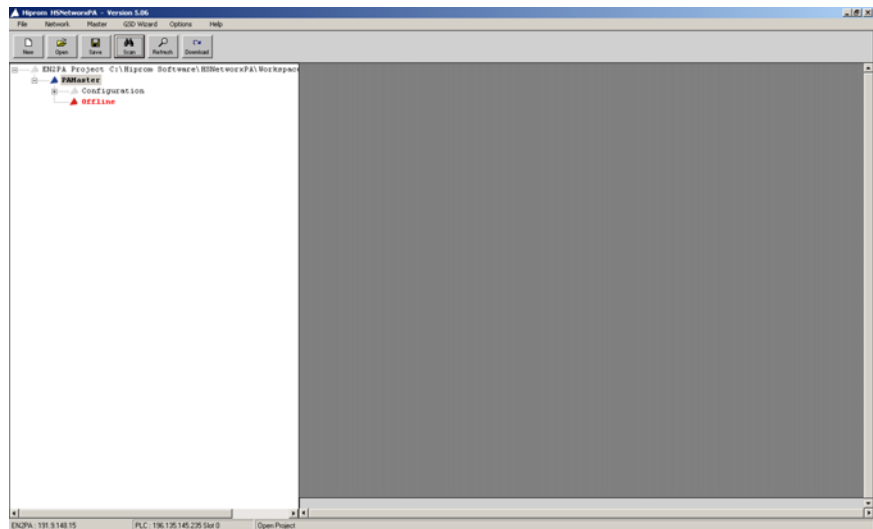

The PA Master will show that it is offline.

10. Press the Refresh button and the PA master will connect and display that it is online. Once it is online, expand the tree to view certain parameters and settings of the EN2PA. If the PA Master does not come online, verify that the EN2PA is powered and has the correct IP Address and Subnet mask.

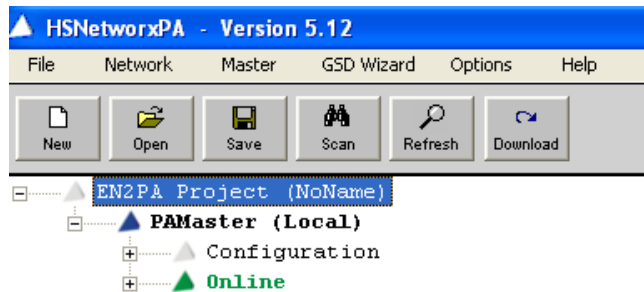

11. Choose whether the PROFIBUS PA devices will be added manually or automatically. Automatic is recommended if default device configuration is acceptable. Manual can be used, for example, to change the slot assignments in order to define different parameters for different slots.

IMPORTANT

The GSD file for a device must be in the GSD library before it can be added in HSNetworkPA. This is done by selecting Import GSD Files under the GSD Wizard tab in the HSNetworkPA. Select a GSD file and click Open.

Manually

1. Left-click the PA master to select it and then right-click to display the PA master's options.
2. Select Add Device from the list.

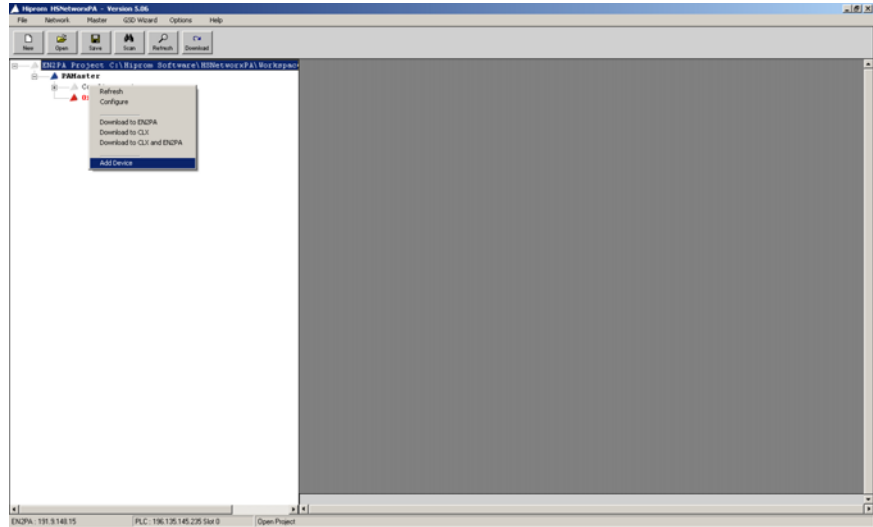

3. Select a device from the drop-down list. If your device does not appear in the drop down list, add the GSD file for the device to the GSD library as described on page 34.
4. Once a device is selected, a default configuration is set. Modify this by clicking on the drop-down menu of a slot and making a different selection if the device supports it. (This is discussed in detail in the section *Field Device Configuration*).

IMPORTANT

Make sure that the node number is the same as the device that is being set up and that the block number is the same as that is being used in the Logix controller.

5. Once all desired settings are selected, click OK and the device will be added to the PA master tree.

6. If the 1788HP-EN2PA is online and the device is connected, click the Refresh button and the specific device icon will go from red to green as shown below. The remaining devices can be set up in a similar way until all the required field devices have been added to the current 1788HP-EN2PA.

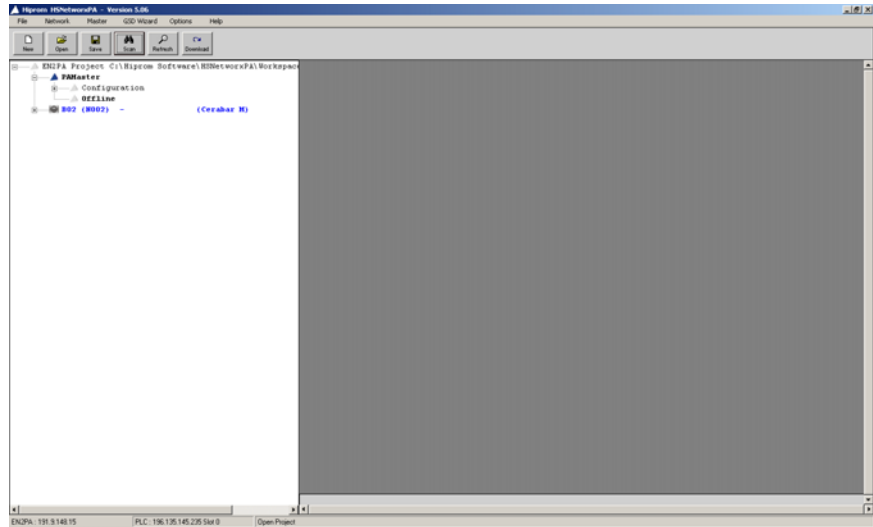

7. Once all the required field devices have been added and configured, download all of the devices' configurations to the selected Logix controller by clicking on the Download button. This will configure/reconfigure all the field devices connected to the 1788HP-EN2PA and download the configuration to the Logix controller where it is stored.

WARNING

Ensure that the EN2PA has already been setup in RSLogix 5000 and downloaded as shown in the section *Establishing the Direct Connection*. If this is not done, you will not be able to download the configuration of the Logix controller.

8. Save the HSNetworkx configuration by selecting File and then Save As from the drop down menu.

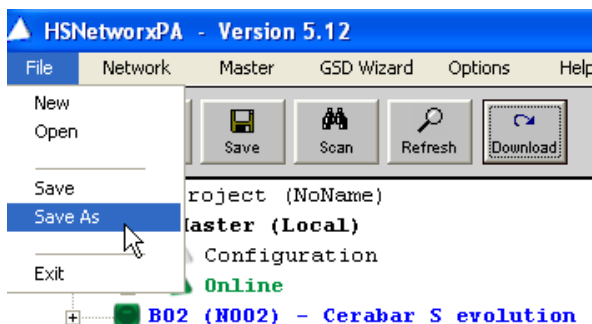

Give the configuration a unique name. Each EN2PA will have different configuration files identifying the Ethernet address, controller and set of instruments.

9. Save the PROFIBUS PA configuration to the RSLogix 5000 offline project. This eliminates the need to use HSNetworkxPA configuration in the event that the controller needs to be reloaded.

Automatic

The automatic setup is similar to the manual one with the exception of being able to scan the bus, and the instruments are added automatically rather than having to add the devices one by one.

1. Click the Scan button as shown below and the 1788HP-EN2PA will start scanning from node address 1 to the max address for the devices on the bus. If a device is received, it will take its IDENT (identification) number and compare it to the IDENT numbers of the GSD files located in the GSD library. Once a match has been found, the device will be added to the tree with a default configuration. If a device is found but there is no match in the GSD library, you will be prompted with the device node number and IDENT number. Once all devices have been successfully added, the tree will be finished.

IMPORTANT

The correct GSD file for the firmware version of the field device must be in the GSD library or the field device will not be added to HSNetworkPA.

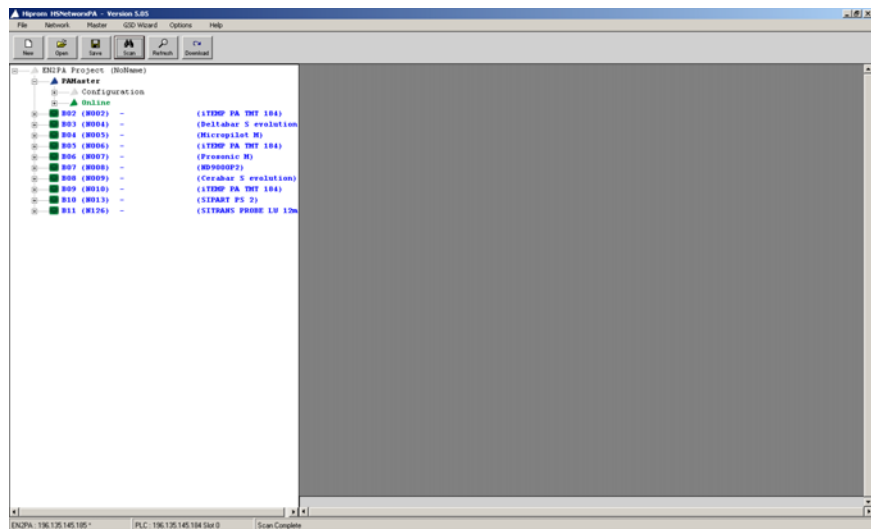

2. Configure each device by right-clicking a device and selecting the Configure tab.

- Download all of the devices' configurations to the selected Logix controller by clicking on the Download button. This will configure/reconfigure all the field devices connected to the 1788HP-EN2PA and download the configuration to the Logix controller where it is stored.

WARNING

Ensure that the module has already been setup in RSLogix 5000 and downloaded as shown in the section *Establishing the Direct Connection*. If this is not done, you will not be able to download the configuration to the Logix controller.

- Once the devices on the bus have been configured, the IO modules (field devices) on the CIP Bus under the EtherNet/IP CIP Bridge will establish a connection and cyclic data exchange will begin. The data of the devices can be seen in the input and output images of the various IO modules added.
- Save the HSNetworkx configuration by selecting File and then Save As from the drop down menu.

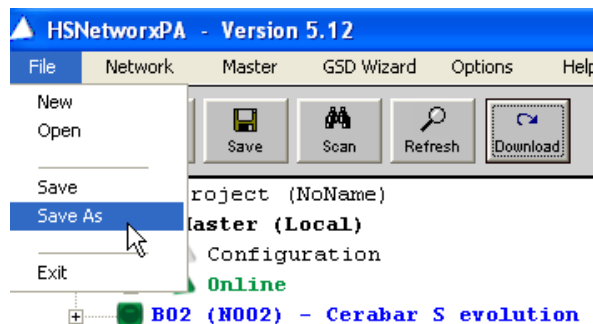

Give the configuration a unique name. Each EN2PA will have different configuration files identifying the Ethernet address, controller, and set of instruments.

- Save the PROFIBUS PA configuration to the RSLogix 5000 offline project. This eliminates the need to use HSNetworkxPA configuration in the event that the controller needs to be reloaded.

Field Device Configuration

Once a device has been added to the PA master tree, configure the inputs and outputs of the field device by right-clicking the device and selecting Configure.

Block

Change the block number of the field device by clicking the drop-down menu and selecting any of the allowable block numbers. Ensure that the block assigned to a specific field device is the same as the address that is used for the IO module in the CIP Bus under the 1788HP-EN2PA in RSLogix 5000.

IMPORTANT

If the PA master PROFIBUS node number is 1, it will not be able to use block 1.

Node

Change the node number of the field device by clicking the drop-down menu and selecting any of the allowable node numbers 1 - 126.

IMPORTANT

If the wrong node number is selected, the field device will not respond or configure. Also, the node number must be exactly the same as the block number or the HSNetworkPA download will not complete properly.

Device

If a different device is needed, click on the drop-down menu and select any of the listed devices (according to the GSD files in the GSD library).

WatchDog

If the WatchDog Enabled tick box has been set, the watchdog value is automatically calculated using the amount of field devices on the bus. Change this by entering new parameters and selecting Refresh.

TSDR

This is the fastest valid slave response set to the field device.

Group Ident

This allows certain field devices to be set into different groups. This is reserved for future use (default 0).

WatchDog Enable

This tick box enables the WatchDog and corresponds to the WatchDog time value.

Freeze Required

When freeze mode is activated, a global control message can be sent which keeps the inputs of the slave in a “frozen” state. This is reserved for future use (default unselected).

Sync Required

When sync mode is activated, a global control message can be sent which keeps the outputs of the slave in a momentary state. This is reserved for future use (default unselected).

Slave Lock

This allows the slave to be locked for another master on the bus. This is reserved for future use (default unselected).

Slave Unlock

Select this tick box to unlock the slave for other masters which allows cyclic data exchange.

Slot x

This allows different inputs, outputs, and parameters for the different allowable slots of the slave to be selected. Using the user manual supplied with the field device, select which parameter to use in which slot and in what format the parameter must be presented in the Controller. Press the drop-down menu and select the process variable type and use the second drop-down menu to select how the message is compiled. Some field devices have been assigned slots that support multiple inputs and outputs. In this case, select the amount of inputs and outputs and in what formats they are presented in the Controller. The 1788HP-EN2PA supports eight inputs and eight outputs per field device.

IMPORTANT

Some field devices support multiple inputs and/or outputs on a single slot. In this case, select the Manual Config tick box and manually enter the amount and format of the specific inputs and/or outputs.

The screenshot shows a dialog box titled "Slot Configuration" with two main sections: "INPUT FORMAT" and "OUTPUT FORMAT".

INPUT FORMAT:

Input	Format
<input checked="" type="checkbox"/> INPUT 1	Real with Status
<input checked="" type="checkbox"/> INPUT 2	4 Bytes
<input type="checkbox"/> INPUT 3	0 EmptySlot
<input type="checkbox"/> INPUT 4	0 EmptySlot
<input type="checkbox"/> INPUT 5	0 EmptySlot
<input type="checkbox"/> INPUT 6	0 EmptySlot
<input type="checkbox"/> INPUT 7	0 EmptySlot
<input type="checkbox"/> INPUT 8	0 EmptySlot

OUTPUT FORMAT:

Output	Format
<input checked="" type="checkbox"/> OUTPUT 1	1 Byte with Status
<input type="checkbox"/> OUTPUT 2	0 EmptySlot
<input type="checkbox"/> OUTPUT 3	0 EmptySlot
<input type="checkbox"/> OUTPUT 4	0 EmptySlot
<input type="checkbox"/> OUTPUT 5	0 EmptySlot
<input type="checkbox"/> OUTPUT 6	0 EmptySlot
<input type="checkbox"/> OUTPUT 7	0 EmptySlot
<input type="checkbox"/> OUTPUT 8	0 EmptySlot

At the bottom of the dialog are "OK" and "Cancel" buttons.

Configure the Liquiline M CM42 Transmitter

Configure via Quick Setup Menus on the Local Display

On the local display of the field instrument, use the Quick Setup menus to configure instrument parameters.

1. Connect the supply voltage.
2. Wait for the initialization to be complete.
3. Completely work through the “Quick Setup” submenu in “PARAM.”

Function name of display (local operation)	Bus parameter name
PARAM	
Quick Setup	
Language	DISPLAY_LANGUAGE
Date format	DISPLAY_DATE_FORMAT
Set date	
Time format	DISPLAY_TIME_FORMAT
Set time	
Temperature unit	DISPLAY_UNIT_TEMPERATURE
Buffer manufacturer	PH_CAL_BUFFER_MANUFACTURER
Temp. compensation	
Medium temperature (Temp. compensation="Man. comp.")	PH_CAL_TEMP_COMP_REF_VALUE

Configuring the Device Address

The address must always be configured for a PROFIBUS PA device. If the address is not configured correctly, the measuring device is not recognized by the process control system. All devices are delivered from the factory with the address 126. You can use this address to check the function of the device and to connect to a PROFIBUS PA network. You then have to change this address to integrate additional devices.

The following methods are available for configuring the address:

1. By means of Profibus communication
2. By means of hardware settings (DIL switch)

IMPORTANT

- Valid device addresses are in the range from 0 to 126.
- Each address may only be assigned once in a PROFIBUS PA network.

Configuring the Device Address by Means of PROFIBUS Communication

You configure the address by means of the "Set Slave Adr" service.

IMPORTANT

You can only configure the address via the bus if DIL switch 8 is set to "On" (= factory setting).

Configuring the Device Address by Means of Hardware (DIL Switch)

To configure the device address, you must open the housing and change the keys of the DIL switch on the CPU module. You set the address (0 to 126) using keys 1-7. To do so, you must set key 8 to the "Off" position (= hardware setting).

You can set any number between 0 and 126 by using binary code, e.g.:

■ 0:



■ 1 ($2^0=1$):



■ 18 ($2^1+2^4=2+16=18$):



Configure via FieldCare Software

FieldCare is the Endress+Hauser FDT-based plant asset management tool that lets you configure intelligent field instruments.

1. Start FieldCare and open a new project.

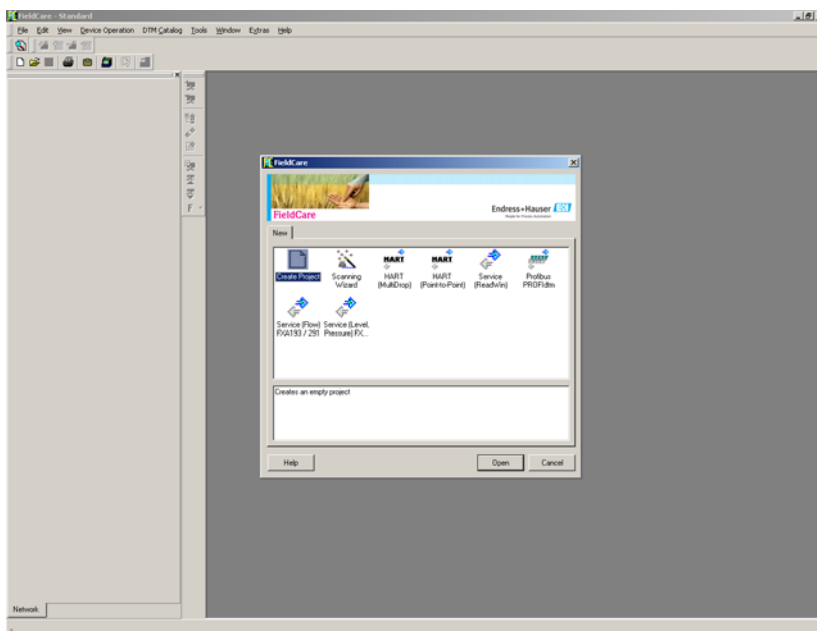

IMPORTANT

To optimize FieldCare performance, it is recommended that you verify that the correct DTMs are loaded in the catalog.

2. Choose the DTM Catalog menu and click Update.

- If there are DTMs listed in the dialog box's left pane, select desired DTMs and click Move.

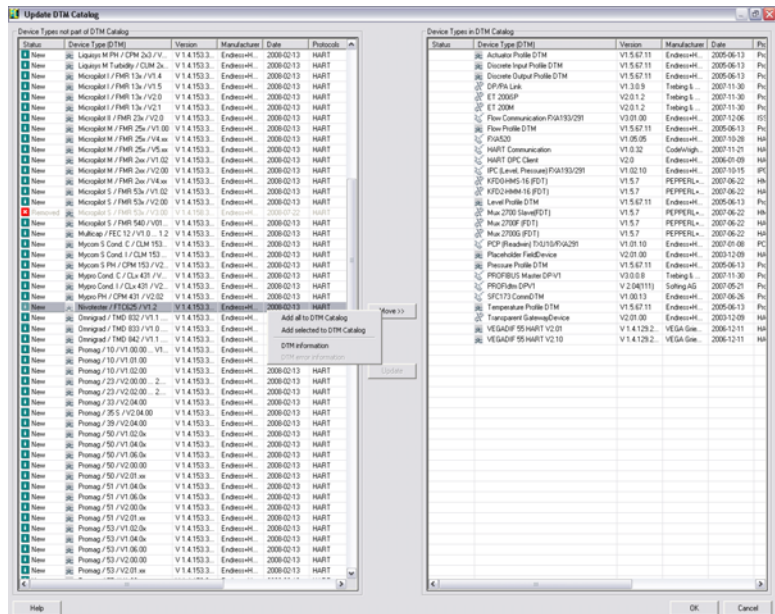

If you do not find the desired DTMs, or if the left pane of the dialog box is empty, click Update. FieldCare searches for DTMs installed on your computer. After the search, found DTMs are added to the dialog box's left pane.

If necessary, to remove DTMs, select the desired DTMs in right pane and click Move.

- Click OK to save your changes.

- From the Device Operation/Add Device menu, select HS Ethernet/IP and click OK.

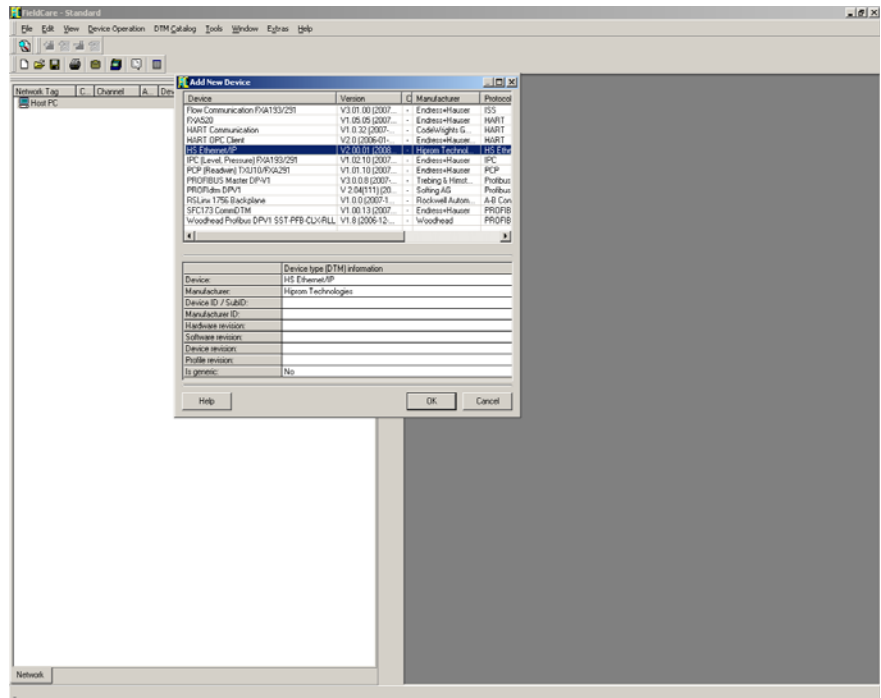

Direct Connection

1. Click on HS Ethernet IP- DTM. From the Device Operation/Add Device menu, select 1788HP-EN2PA and click OK.

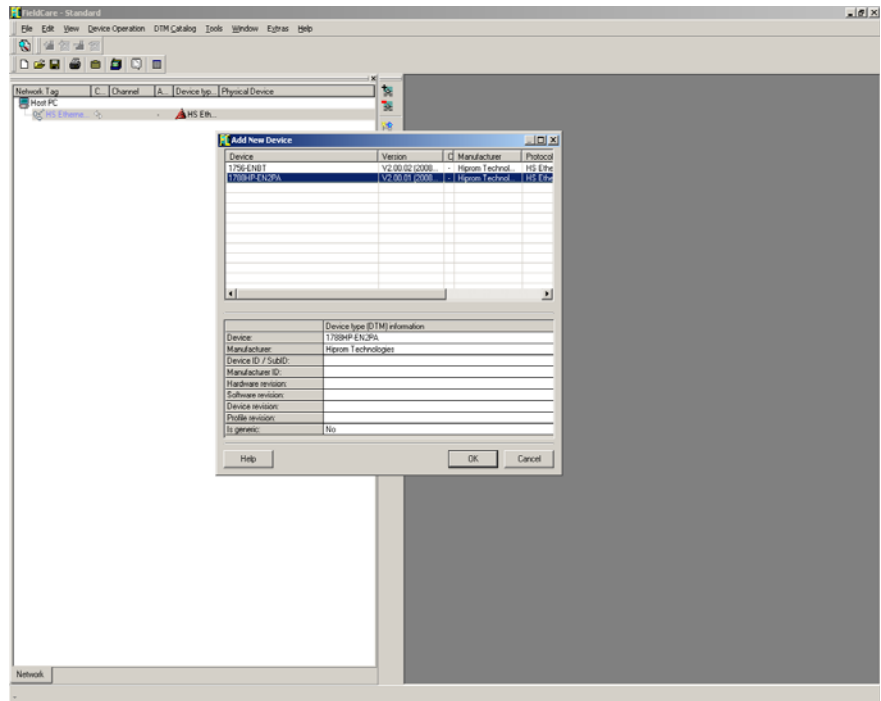

2. To configure the 1788HP-EN2PA, double-click 1788HP-EN2PA in the left pane.

3. Enter the 1788HP-EN2PA IP address and the Max Scan Address.

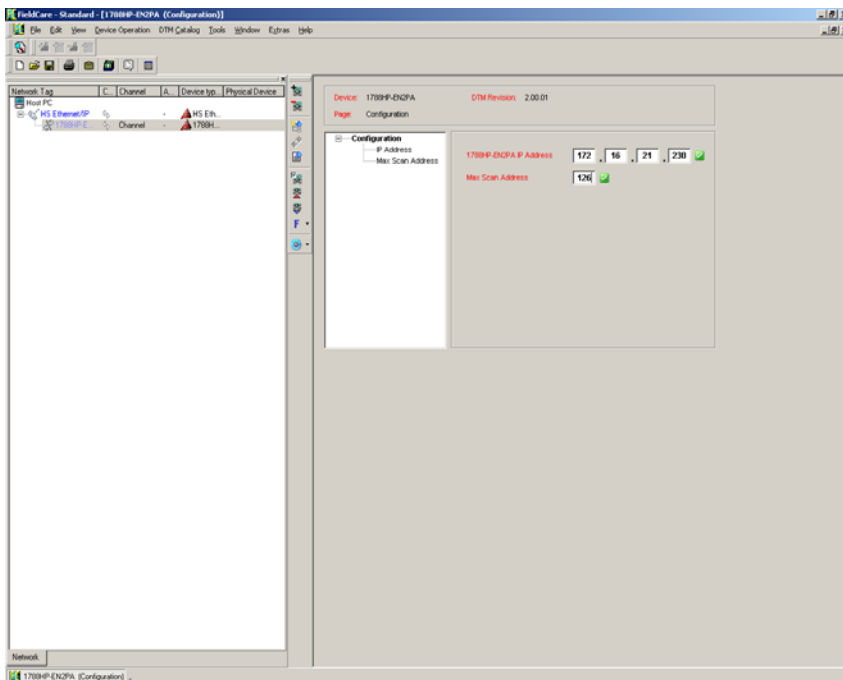

4. Click the Create Network icon.

5. When prompted, click OK.

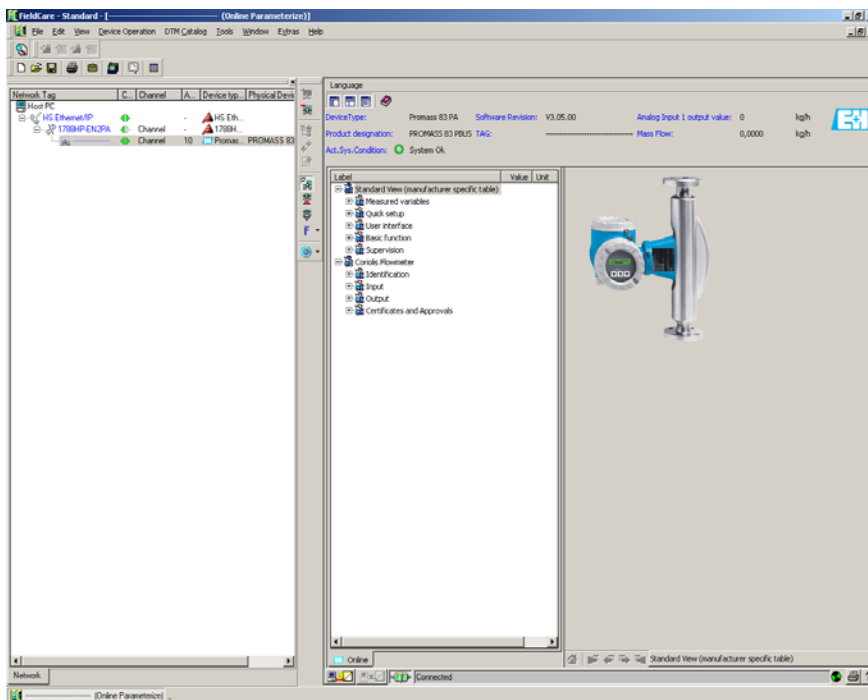

The Com DTM now scans the entire PROFIBUS PA network behind the 1788HP-EN2PA and searches for the right DTM.

If the right DTM is installed, the instrument comes up in the Explorer view on the left side.

IMPORTANT

If only one DTM is added to the network, the software automatically goes online. Otherwise a warning occurs that must be confirmed. To switch this behavior off, in the Fieldcare-context-menu Extras/Options, select After Scanning within Page Scanning.

Remote Connection

If you access the 1788HP-EN2PA via the ControlLogix Backplane, please follow steps 1 to 5 as described in the section [Direct Connection](#) and proceed as follows.

1. Click on HS Ethernet/IP. From the Device Operation/Add Device menu, select the 1756-ENBT and click OK.

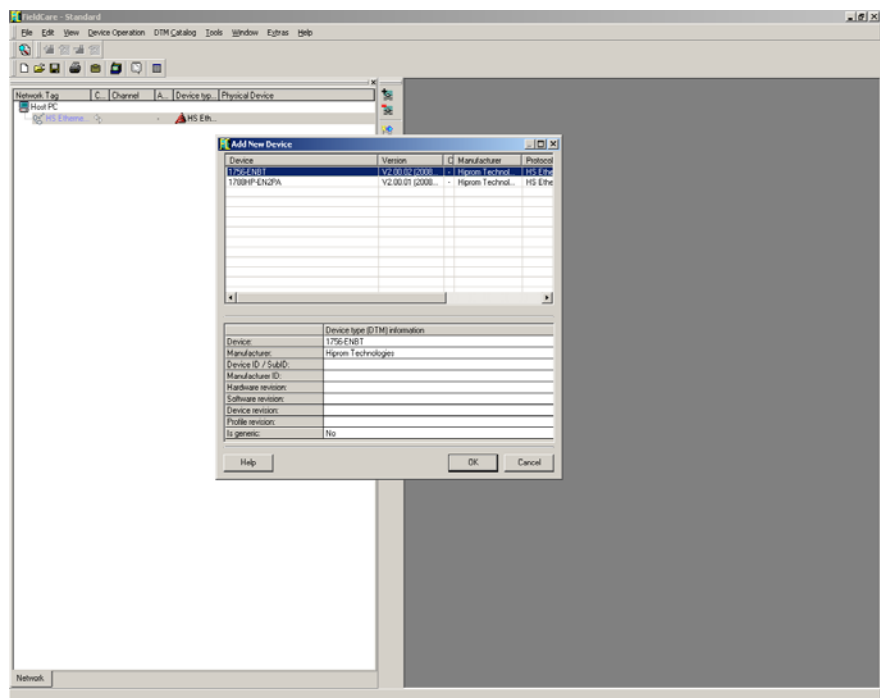

2. To configure the 1756-ENBT, double-click the 1756-ENBT in the left pane.

3. Enter the 1756-ENBT IP address and the 1756-ENBT Slot Number.

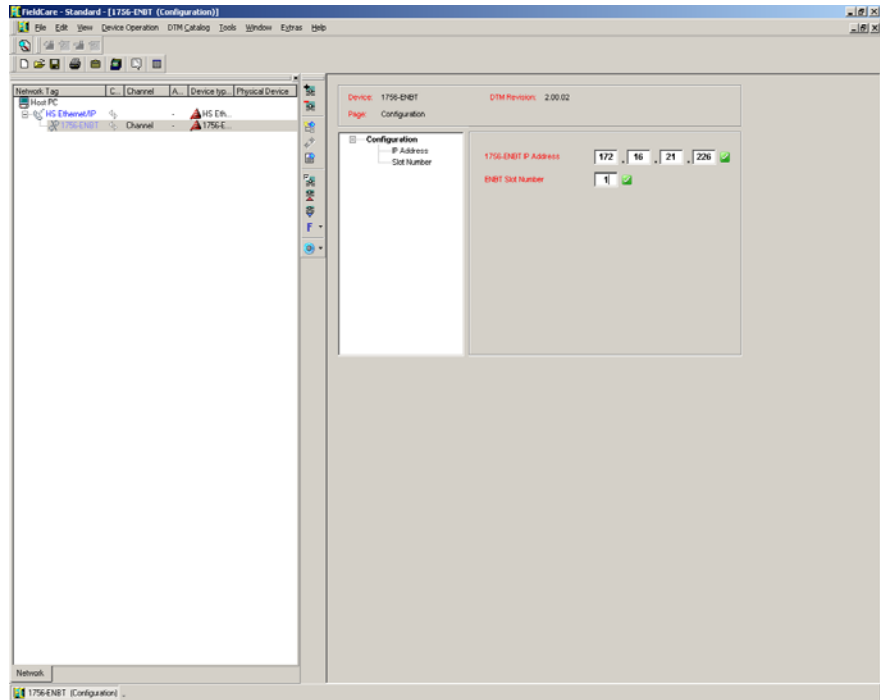

4. Click on 1756-ENBT. From the Device Operation/Add Device menu, select the 1756-Chassis and click OK.

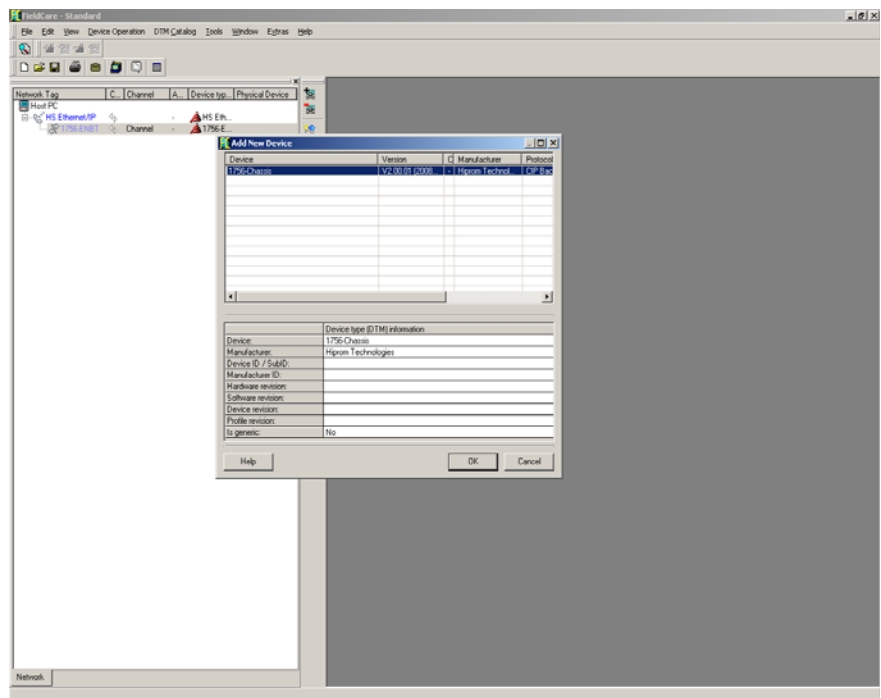

5. Click on 1756-Chassis. From the Device Operation/Add Device menu, select the 1756-ENBT and click OK.

6. Enter the 1756-ENBT IP address and the 1756-ENBT Slot Number.

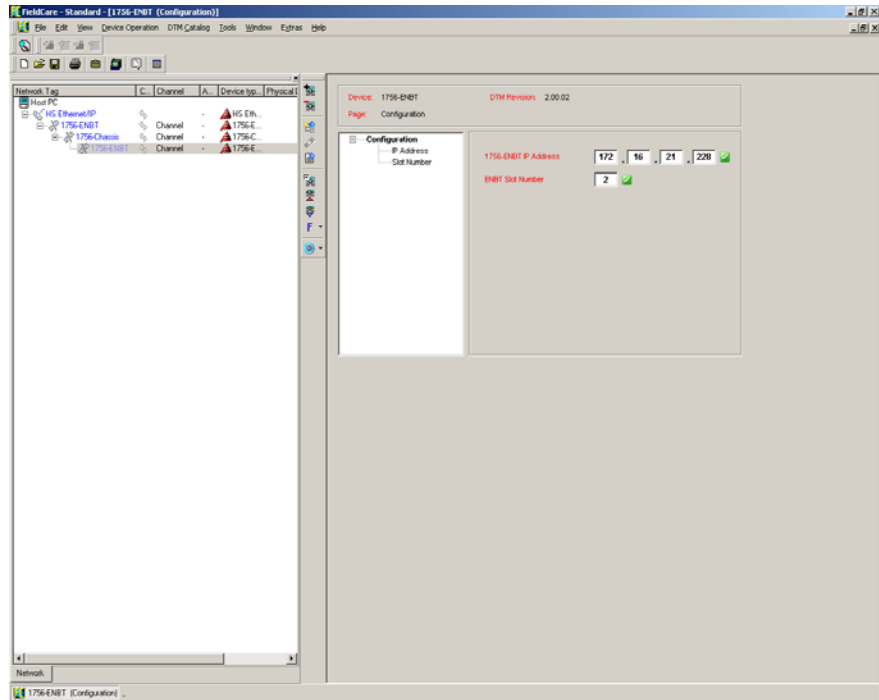

7. Click 1756-ENBT. From the Device Operation/Add Device menu, select the 1788HP-EN2PA and click OK.
8. To configure the 1788HP-EN2PA, double-click the 1788HP-EN2PA in the left pane.

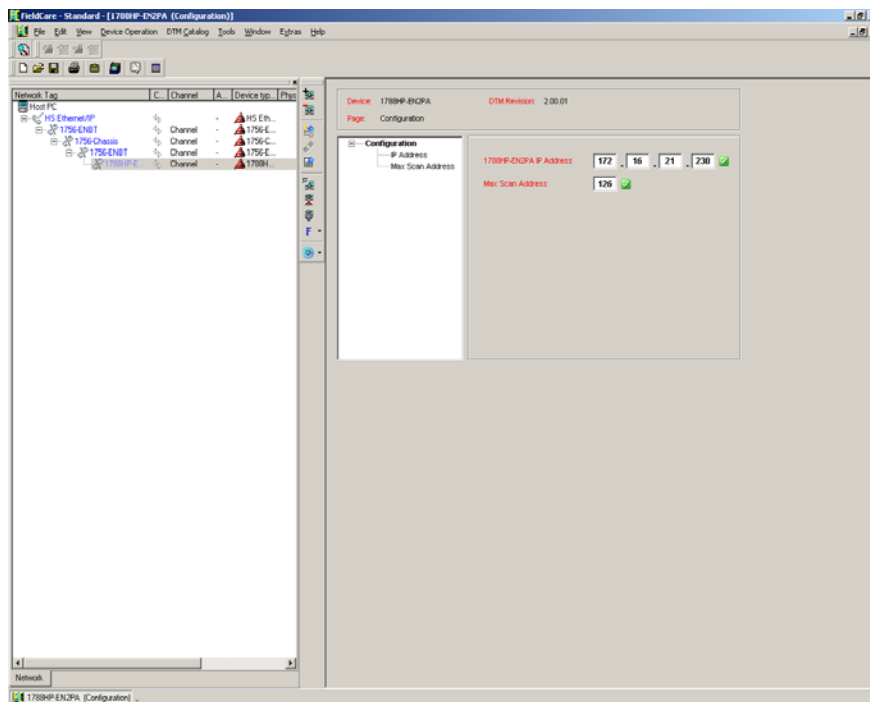
9. Enter the 1788HP-EN2PA IP address and the Max Scan Address.**10.** Click the Create Network icon.*Access Instrument Data*

You can use FieldCare software to access instrument data. The following examples show a Promass field instrument. Your screens may vary depending on the field instrument.

1. In an open FieldCare project, right-click on the instrument in the left pane and select Connect.
2. Double-click on the instrument in the left pane.

3. In the Online pane, select Device Data.

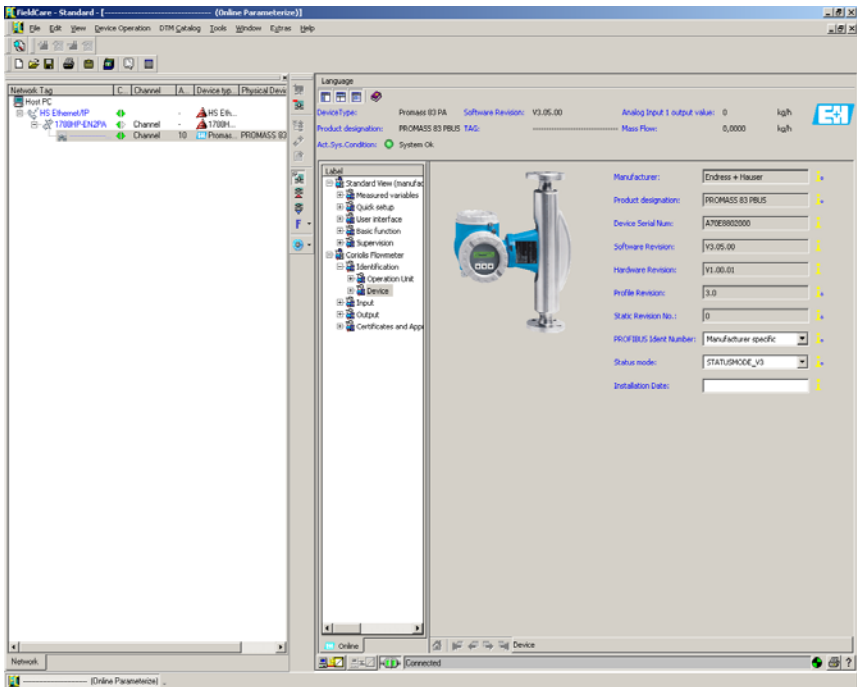

4. To view measured values, right-click on the instrument in the left pane and choose Observe.

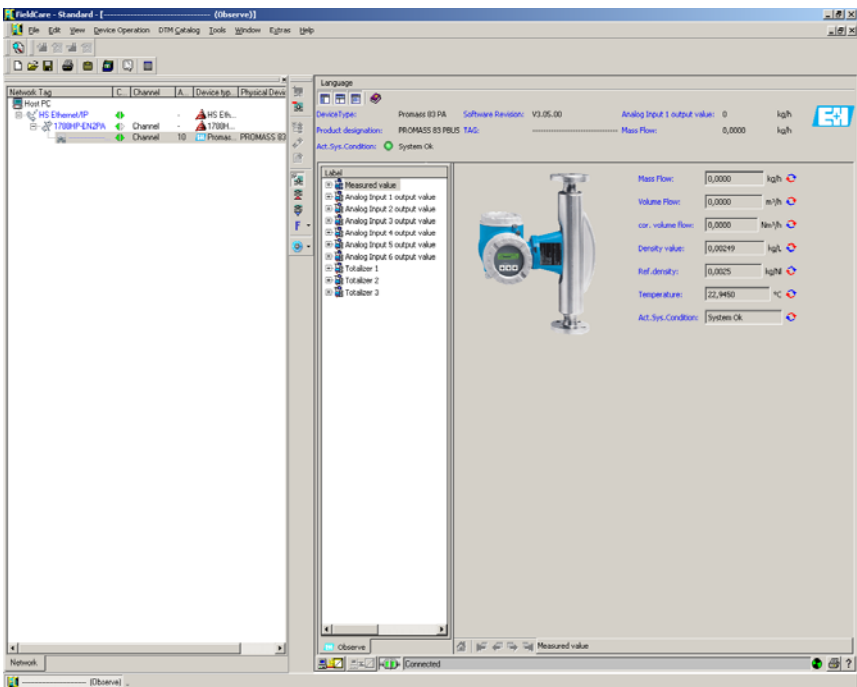

Visualization

In order to monitor the instruments using the pre-designed faceplates, the EN2PA must be set up as specified in this integration document and the manual. We also suggest developing a similar configuration to the one included in the RSLogix 5000 project provided by Rockwell Automation. The controller exchanges data between the devices, and the FactoryTalk View SE faceplates notify personnel what is happening in the plant.

The following information summarizes the Add-On Instructions and faceplates. See [Additional Resources](#) for more detailed information.

Add-On Instructions

An Add-On Instruction exchanges data between each process variable located in the process device and the faceplate installed on a display. The name of the specific instance of the Add-On Instruction becomes the link from the actual instrument to the faceplate on the graphic.

- Structured input data for each field instrument.

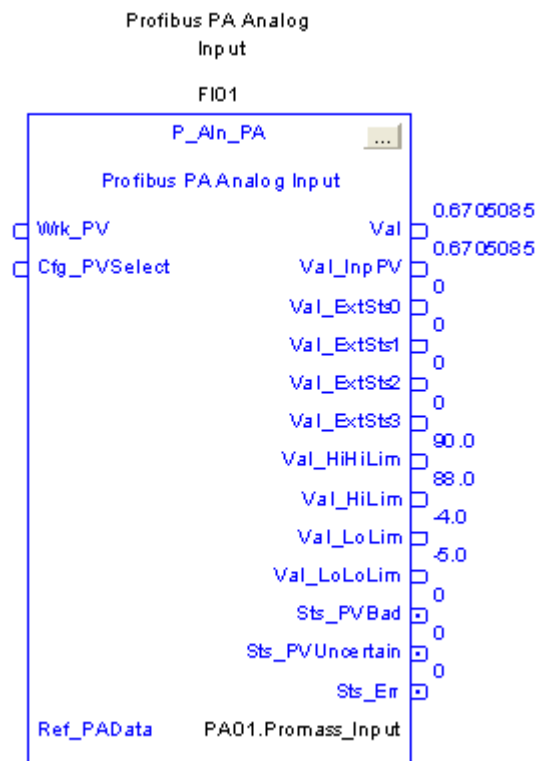

IMPORTANT

The P_Inp_PA Add-On Instruction uses embedded P_MODE and P_ALARM Add-On Instructions. These embedded Add-On Instructions must already be in the project before importing the P_Inp_PA Add-On Instruction.

Faceplates

The FactoryTalk View SE generic display provides a graphical representation of the instrument based on the information within each Add-On Instruction. Navigation buttons at the top of the faceplate change the information displayed. Status displays show information using a bar graph, numeric values, and trend displays. Other displays show specific alarms and warning indications.

Here are some examples of predesigned faceplates.

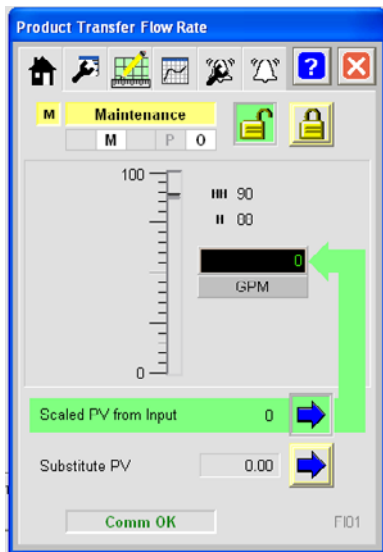

DESCRIPTION

Operator

	Threshold	Deadband
High-High Alarm	90.00	1.00
High Alarm	80.00	1.00
Low Alarm	10.00	1.00
Low-Low Alarm	5.00	1.00
Out of Range High	100.00	0.00
Out of Range Low	0.00	0.00

Bumpless Program/Operator Transition

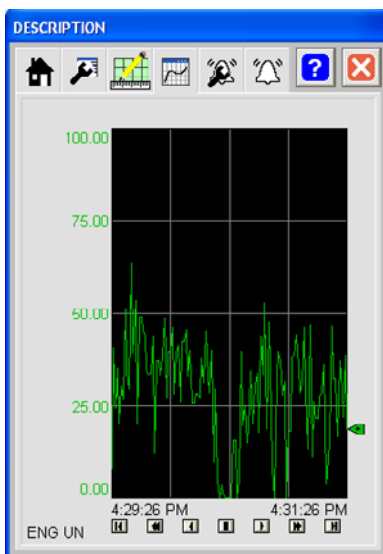
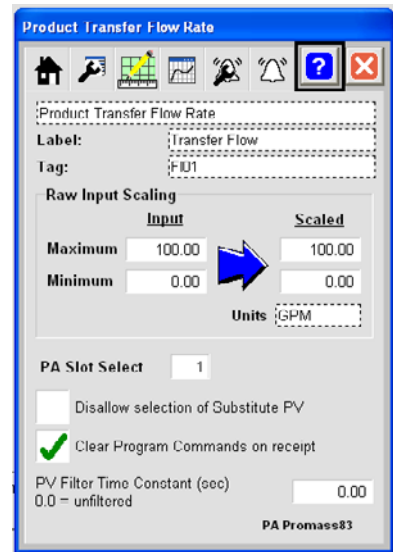

DESCRIPTION

Alarm Delay Time (seconds)	
High-High	5.000
High	5.000
Low	5.000
Low-Low	5.000
Device Fail	5.000

Alarm	Ack Reqd	Reset Reqd	Severity			
			1	2	3	4
High-High	<input checked="" type="checkbox"/>	<input type="checkbox"/>	<input type="checkbox"/>	<input type="checkbox"/>	<input type="checkbox"/>	<input type="checkbox"/>
High	<input checked="" type="checkbox"/>	<input type="checkbox"/>	<input type="checkbox"/>	<input type="checkbox"/>	<input type="checkbox"/>	<input type="checkbox"/>
Low	<input checked="" type="checkbox"/>	<input type="checkbox"/>	<input type="checkbox"/>	<input type="checkbox"/>	<input type="checkbox"/>	<input type="checkbox"/>
Low-Low	<input checked="" type="checkbox"/>	<input type="checkbox"/>	<input type="checkbox"/>	<input type="checkbox"/>	<input type="checkbox"/>	<input type="checkbox"/>
Device Fail	<input checked="" type="checkbox"/>	<input type="checkbox"/>	<input type="checkbox"/>	<input type="checkbox"/>	<input type="checkbox"/>	<input type="checkbox"/>

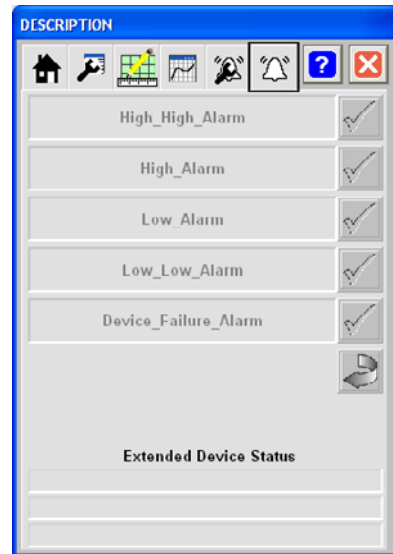

IMPORTANT

A unique global object and faceplate is available for each field instrument due to the display of instrument-specific extended diagnostic information.

The faceplates provide the following from the device:

- PROFIBUS PA process values (PV) - first, second, third, fourth, fifth, sixth, seventh, eighth from instrument
- PV fault status (communication fault)
- PROFIBUS PA device Extended Status

Configure the faceplates to provide the following:

- PROFIBUS PA PV range (minimum and maximum)
- Tag name
- Description
- Engineering units
- Mode (such as operator or program)
- High-high, high, low, low-low alarms
- Over-range and under-range alarms
- Alarm delay
- Alarm hysteresis

Extended Diagnostic Messages

PROFIBUS PA Extended Diagnostic Status provides information about an instrument when an instrument's transmitter or sensor is not running properly. It produces bit-based outputs that can be translated into specific error codes in order to help maintenance personnel determine more specific details about abnormal conditions with PROFIBUS PA instruments.

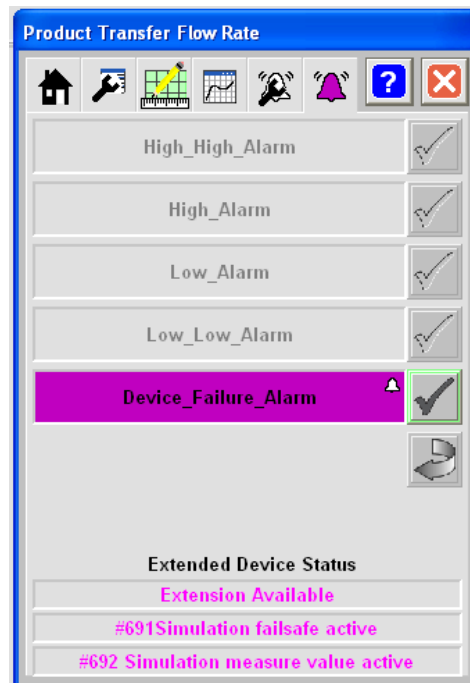

Additional Resources

Resource	Description
PROFIBUS PA Field Instruments	
Liquiline M CM42 Technical Information, publication TI381C/07/en	Specifications and details of the Liquiline M CM42 transmitter.
Liquiline M CM42 Operating Instructions (PROFIBUS PA), publication Part 1 (Commissioning): BA381C/07/en Part 2 (Operation): BA382C/07/en	How to install, wire, configure, and operate a Liquiline M CM42 transmitter.
www.products.endress.com/profibus-gsd	Download GSD file for field instrument.
Control System Components	
ControlLogix Controllers Installation Instructions, publication 1756-IN101	How to install and configure a ControlLogix controller.
ControlLogix Controllers User Manual, publication 1756-UM001	How to configure, operate, and maintain a ControlLogix controller.
HIPROM EN2PA User Manual	Describes the functionality, installation, configuration, and operation of the EN2PA module.
http://www.hiprom.com	Download firmware updates and updated documentation.
Operator Components	
Add-On Instructions and Faceplates for Visualizing PROFIBUS PA Instrument Data in FactoryTalk View SE, Knowledgebase document (Login required. Please contact your sales representative.)	How to implement the PROFIBUS PA Add-On-Instruction in controller logic to work with the FactoryTalk View faceplates for PROFIBUS PA instruments.
FactoryTalk View Site Edition User's Guide, publication VIEWSE-UM006	How to design, develop, and deploy FactoryTalk View SE applications.
Faceplates, Add-On Instructions, project files, etc. (Login required. Please contact your sales representative.)	Download AOIs, Faceplates and Global Object graphics, and project files.
www.products.endress.com/fieldcare	Information about FieldCare Asset Management software.
www.products.endress.com/dtm-download	Information about field instrument DTMs.
Process Control Information	
Integrated Architecture for Process Control System Recommendations Manual, publication PROCES-RM001	Process system recommendations that organize Rockwell Automation products functionally as system elements, which can then be applied in proven, scalable configurations for continuous and batch control.
http://www.rockwellautomation.com/process	Information about Rockwell Automation process control and Integration Documents.
http://literature.rockwellautomation.com	Available Rockwell Automation publications, including Integration Documents.
http://www.endress.com	Information about Endress+Hauser field instruments.

Rockwell Automation Support

Rockwell Automation provides technical information on the Web to assist you in using its products. At <http://support.rockwellautomation.com>, you can find technical manuals, a knowledge base of FAQs, technical and application notes, sample code and links to software service packs, and a MySupport feature that you can customize to make the best use of these tools.

For an additional level of technical phone support for installation, configuration, and troubleshooting, we offer TechConnect support programs. For more information, contact your local distributor or Rockwell Automation representative, or visit <http://support.rockwellautomation.com>.

Endress+Hauser Support

Please refer to your local Endress+Hauser Sales Center for precise information regarding the service support available in your area or visit <http://www.endress.com>.

Installation Assistance

If you experience a problem within the first 24 hours of installation, please review the information that's contained in this manual. You can also contact a special Customer Support number for initial help in getting your product up and running.

United States	1.440.646.3434 Monday – Friday, 8 a.m. – 5 p.m. EST
Outside United States	Please contact your local Rockwell Automation representative for any technical support issues.

New Product Satisfaction Return

Rockwell Automation tests all of its products to ensure that they are fully operational when shipped from the manufacturing facility. However, if your product is not functioning and needs to be returned, follow these procedures.

United States	Contact your distributor. You must provide a Customer Support case number (call the phone number above to obtain one) to your distributor in order to complete the return process.
Outside United States	Please contact your local Rockwell Automation representative for the return procedure.

Allen-Bradley, ControlLogix, FactoryTalk, PlantPAx, Rockwell Automation, RSLogix 5000, and TechConnect are trademarks of Rockwell Automation, Inc. Trademarks not belonging to Rockwell Automation are property of their respective companies.

Endress+Hauser is trusted by more than 100,000 customers to make their processes safe, efficient and environmentally friendly. We offer a range of measurement products, including level, flow, pressure, temperature, analytical and complete engineered solutions designed to help customers acquire, transmit, control and record process information needed to manage operations in a safe, reliable and profitable manner.

www.endress.com/worldwide

International:

Endress+Hauser
Instruments International
Kaegenstr. 2, CH-4153 Reinach/BL,
Switzerland
Tel: +41 61 715 81 00
Fax: +41 61 715 25

USA:

Endress+Hauser, Inc.
2350 Endress Place
Greenwood, IN 46143
Tel: (1) 317 535 7138
Fax: (1) 317 535 8498

Canada:

Endress+Hauser, Canada
1075 Sutton Drive
Burlington, ON L7L 5Z8
Tel: (1) 905 681 9292
Fax: (1) 905 681 9444

Mexico:

Endress+Hauser México, S.A. de C.V.
Fernando Montes de Oca 21 Edif A Piso3
San Nicolás, 54030 Tlalnepantla,
Edo de México
Tel: +52 55 5321 2080
Fax: +52 55 5321 2099

Rockwell Automation, Inc. (NYSE: ROK) is a leading global provider of industrial automation power, control and information solutions that help manufacturers achieve a competitive advantage in their businesses. The company brings together leading global brands in industrial automation which include Allen-Bradley controls and services and Rockwell Software factory management software.

www.rockwellautomation.com/solutions/process

Americas:

Rockwell Automation
1201 South Second Street,
Milwaukee, WI 53204-2496 USA
Tel: (1) 414 382 2000
Fax: (1) 414 382 4444

Europe/Middle East/ Africa:

Rockwell Automation
Vorstaan/Boulevard du Souverain 36,
1170 Brussels, Belgium
Tel: +32 2 663 0600
Fax: +32 2 663 0640

Asia Pacific:

Rockwell Automation
Level 14, Core F, Cyberport 3,
100 Cyberport Road, Hong Kong
Tel: +852 2887 4788
Fax: +852 2508 1846