

Operating Instructions

RMS621

Energy Manager

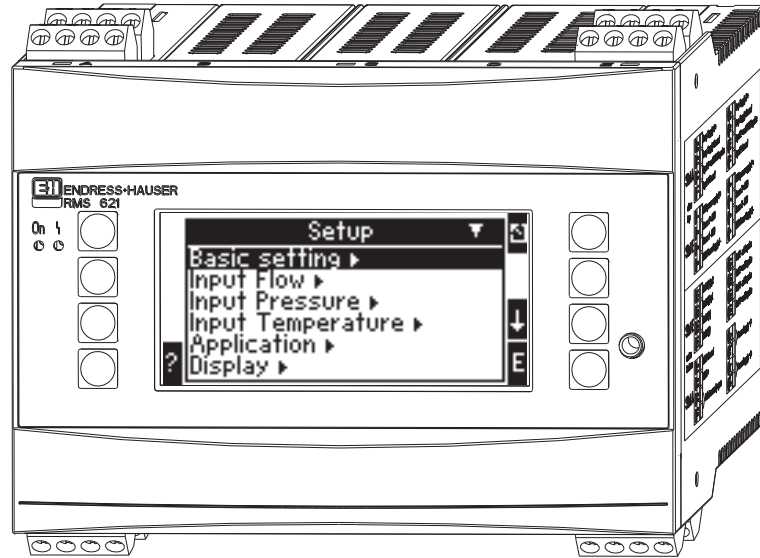

Brief overview

For quick and easy commissioning:

Safety instructions	→ 8
↓	
Installation	→ 11
↓	
Wiring	→ 13
↓	
Display and operating elements	→ 23
↓	
Commissioning	→ 31
Quick start via the navigator to device configuration for standard operation. Device configuration - explanation and use of all configurable device functions with the associated value ranges and settings. Application example - configuration of the device.	

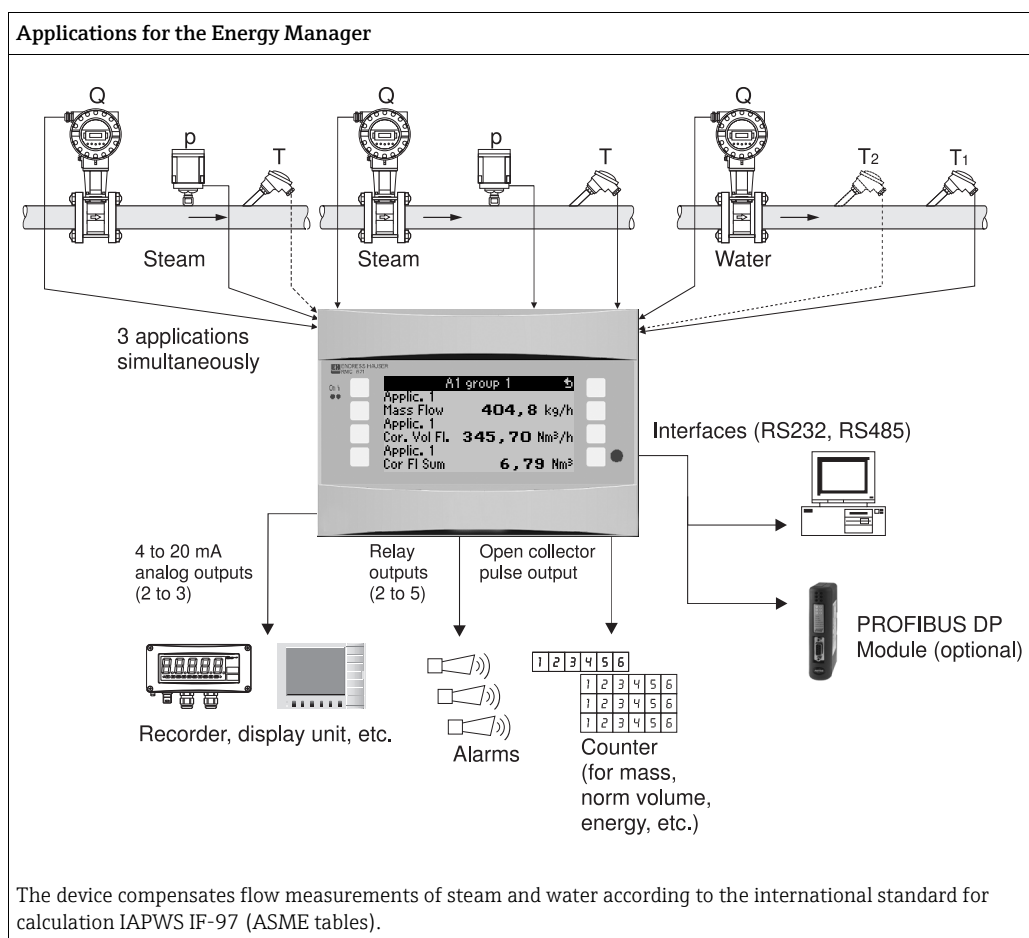





Brief operating instructions

The information contained in these Operating Instructions serves as a guide to help you commission your device easily, i.e. the most important settings are listed here but special functions (e.g. tables, corrections etc.) are not.

Configuring a measurement - Set-up example

Example 1: Steam heat (or steam mass)

Sensors: DPO10 (orifice), Cerabar T, TR 10

1. Connect device to the power source (terminal L/L+, 230 V)
2. Press any key → Setup (all parameters)
3. **Basic set-up**
Date-time (set up date and time) → 
Select system eng. units (select metric or American)
4. **Flow inputs** (flow 1)
Flow meter: Differential pressure
Diff. device: Orifice corner tap
Signal: 4 to 20 mA
Terminals: Select A10 and connect DP transmitter to terminals: A10(-)/82(+) (because of passive signal)
Curve: linear (also set up linear curve at the DP transmitter)
Set up start- and end-value (in mbar!)
Tube data: enter internal tube diameter and diameter ratio (β) as found on the manufacturers data sheet.
 If tube data is not known, for flow meter: select operating volume
Curve: linear (set up square rooted curve on the DP transmitter)
Set up start- and end-values (m^3/h)
5. **Pressure input** (Pressure 1)
Signal type: e.g. 4 to 20 mA
Terminals: Select A110 and connect Cerabar T to terminals: A110(-)/A83(+) (passive signal)
Type: Select absolute (-pressure measurement) or relative (-pressure measurement)
Set up start- and end-values of the pressure transmitter → 
6. **Temperature inputs** (temp. 1.1)
Signal type: Pt100
Sensor type: 3- or 4-wire
Select terminals E1-6 and connect Pt100 →  → .

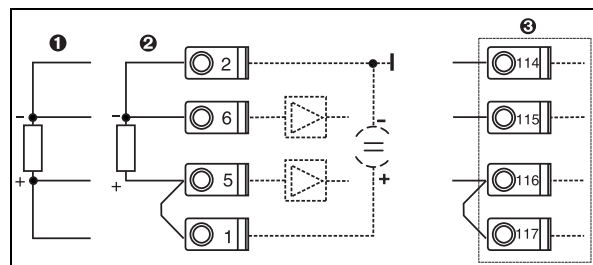

Temperature sensor connection, e.g. to input 1 (Slot E I)

- Pos. 1: 4-wire input
- Pos. 2: 3-wire input
- Pos. 3: 3-wire input e.g. optional temp. expansion card (Slot B I)

7. Application

Application 1: Steam heat

Steam type: super heated steam

Allocate flow 1, pressure 1 and temp. 1.1 to the steam measurement.

8. Display

Group 1

Display mask: 3 values

Value 1 (...4): Mass flow, Mass sum, Heat sum → 

Group 2: select to above system e.g. flow 1, pressure 1, temperature 1.1, heat flow 1.

9. Exit set-upExit set-up by operating ESC  a number of times and acknowledging with .**Display**

By operating any key you can enter the main menu and select the required group including all the relative display values: Display -> Group -> Group 1. All can also be displayed in an automatic scroll function: Setup -> Display -> Scrolled display (scroll using the arrow under group 6).

If a fault occurs the display automatically changes colour (blue/red). Detailed fault finding and elimination can be found in the relative chapter of these operating instructions.

Example 2: Water heat difference

Sensors: 2 x TST90, Promag 50

1. Connect device to the power source (terminal L/L+, 230 V)

2. Press any key → Menu → Setup (all parameters)

3. Basic set-upDate-time (set up date and time) → 

Select system eng. units (metric or American)

4. Flow input (flow 1)

Flow meter: Operating volume

Signal type: 4 to20 mA



Terminals: select A10 and connect the Prowirl to terminals: A10(+)/11(-) (active signal)

Set up start- and end-values

5. Temperature inputs (temp. 1.1 and temp. 1.2)

Signal type: Pt100

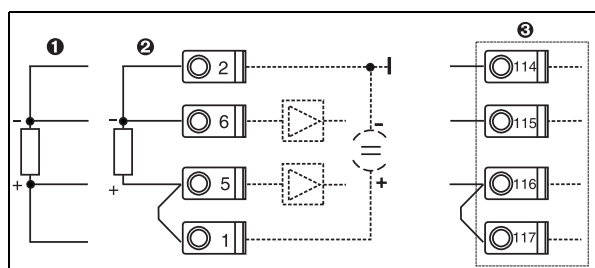
Sensor type: 3- or 4-wire

Terminals: select E1-6 and connect TST90 (temp. 1.1) → Terminals: select E3-8 and connect TST90 (temp. 1.2) →  → 

Temperature sensor connection, e.g. to input 1 (Slot E1)

Pos. 1: 4-wire input

Pos. 2: 3-wire input

Pos. 3: 3-wire input e.g. optional temp. expansion card (Slot B I)

6. Applications

Application 1: Water heat difference

Operating mode: Heating

Select "Flow 1"

Installation point: Cold (means return)

Allocate temperature sensors 1.1 and 1.2 to heat and cooling section.

7. Display

Group 1

Display mask: 3 values

Value 1 (...4): Flow 1, heat flow 1 and mass sum 1 → 

Group 2: select to above system e.g. temp. 1.1, temp. 1.2, mass flow 1, mass sum 1.

8. Exit set-up

Exit set-up by operating ESC  a number of times and acknowledging with .

Display

By operating any key you can enter the main menu and select the required group including all the relative display values: Display -> Group -> Group 1. All groups can also be displayed in an automatic scroll function: Setup -> Display -> Scrolled display (scroll using the arrow under group 6).

If a fault occurs the display automatically changes colour (blue/red). Detailed fault finding and elimination can be found in the relative chapter of these operating instructions.

An example of steam mass measurement using a Prowirl 77 can be found in the appendix of this operating manual.

Example 3



You will find a further example for a steam mass calculation using a Prowirl 77 in chapter 6.4.1 of the operating instructions.

Basic application settings

The values shown are only an indication in order to simplify the commissioning of the device, this means that only the most necessary settings are shown. Special functions (e.g. tables, corrections, etc.) are not shown.

Water applications

Input values: Flow, temperature 1, (temperature 2)

Flow Pulse/PFM (e.g. ProWirl)	Analog (e.g. Promag)	Differential pressure (e.g. Orifice)
Flow input	Flow input	Special flow meters
Flow meter: Operating volume	Flow meter: Operating volume	Differential pressure/Orifice/water
Terminals: – Flow meter with active signal connect to e.g. terminals A10(+)/11(-). – Flow meter with passive signal select e.g. terminals A10 and connect to terminals A10(-)/82(+). Terminal 82 is 24 V sensor power supply.		
k factor	Start/end value (m ³ /h)	Start/end value (mbar)
Temperature		
Select signal type and connect sensor(s) (see example). 2 temperature sensors are required for heat differential measurements.		
Application		
Application: Medium: water/steam		
Liquid application: e.g. water heat difference		
Operating mode: e.g. heating (this means inflow warm, return cold)		
Allocate sensors for flow and pressure measurement		
Allocate installation point, T warm/cold		

Only one temperature is required for water heat quantity. A direction signal terminal is required on changing flow direction (bi-directional operating mode).

Steam applications

Input variables: flow, pressure, temperature1, (temperature2)

Flow Pulse/PFM (e.g. Vortex)	Analog (e.g. Vortex)	Differential pressure (e.g. orifice)
Flow input	Flow input	Special flow meters
Flow sensor: operating volume	Flow sensor: operating volume	Differential pressure/orifice.../steam
Terminal connection – Flow transmitter with active signal: e.g. select terminal A10 and connect flow meter to terminal A10(+)/11(-). – Flow transmitter with passive signal: e.g. select terminal A10 and connect flow meter to terminal A10(-)/82(+). Terminal 82 is 24 V sensor power supply.		
K-factor	Start value/end value: ... (m ³ /h)	Start value/end value: ...(mbar)
Pressure		
Select signal type and terminal connection and connect sensor (see example).		
Type: Relative or absolute pressure?		
Temperature		
Select signal type and connect sensor(s) (see example). 2 temperature sensors are required for steam difference measurements.		
Application		
Application(1); medium: water/steam		
Application: e.g. steam mass/heat		
Steam type: e.g. superheated		
Allocate sensors for flow, pressure and temperature measurement		

1 Safety instructions

Safe operation of the Flow and Energy Manager is only guaranteed if these Operating Instructions have been read and the safety instructions have been observed.

1.1 Designated use

The Energy Manager is a unit for monitoring energy and flows in water and steam applications. It can be used in both heating and cooling systems. A large variety of different flow sensors, temperature and pressure sensors can be connected to the unit. The Energy Manager accepts the current/PFM/pulse or temperature signals from the individual sensors and from these calculates the liquid and energy values:

- Volume and mass
- Heat flow or energy
- Heat energy differential

all using the international calculation standard IAPWS-IF 97.

- The unit is classified as additional equipment and may not be used in a hazardous area.
- The manufacturer cannot take responsibility for any damage caused by misuse of the unit. It is not permitted to make any changes or reconstruction to the unit.
- The Energy Manager has been designed for use in an industrial environment and may only be used in an appropriately installed condition.

1.2 Installation, commissioning and operation

The unit is safely manufactured using state-of-the-art technology and complies with the respective EU regulations. The unit could be dangerous if it is incorrectly installed or used. Mechanical and electrical installation, commissioning and maintenance of the unit must only be carried out by skilled and qualified personnel. The skilled personnel must have read and understood these operating instructions and followed them carefully. Always make sure that the unit is correctly connected following the electrical connection diagrams (see Chap. 4 "Electrical installation"). The housing must only be opened by qualified skilled personnel.

1.3 Operational safety

Technical advancement

The manufacturer reserves the right to improve and update the technical details. For details of improvements or additions to these instructions, please contact your local sales organization.

1.4 Return





For a return, e.g. in case of repair, the device must be sent in protective packaging. The original packaging offers the best protection. Repairs must only be carried out by your supplier's service organization.



When sending for repair, please enclose a note with a description of the error and the application.

1.5 Notes on safety conventions and icons

The safety instructions in these Operating Instructions are labelled with the following safety icons and symbols:

Symbol	Bedeutung
 <small>A0011189-DE</small>	DANGER! This symbol alerts you to a dangerous situation. Failure to avoid this situation will result in serious or fatal injury.
 <small>A0011190-DE</small>	WARNING! This symbol alerts you to a dangerous situation. Failure to avoid this situation can result in serious or fatal injury.
 <small>A0011191-DE</small>	CAUTION! This symbol alerts you to a dangerous situation. Failure to avoid this situation can result in minor or medium injury.
 <small>A0011192-DE</small>	NOTICE This symbol contains information on procedures and other facts which do not result in personal injury.
	TIP Indicates additional information.

2 Identification

2.1 Device designation

2.1.1 Nameplate

Compare the nameplate on the device with the following diagram:

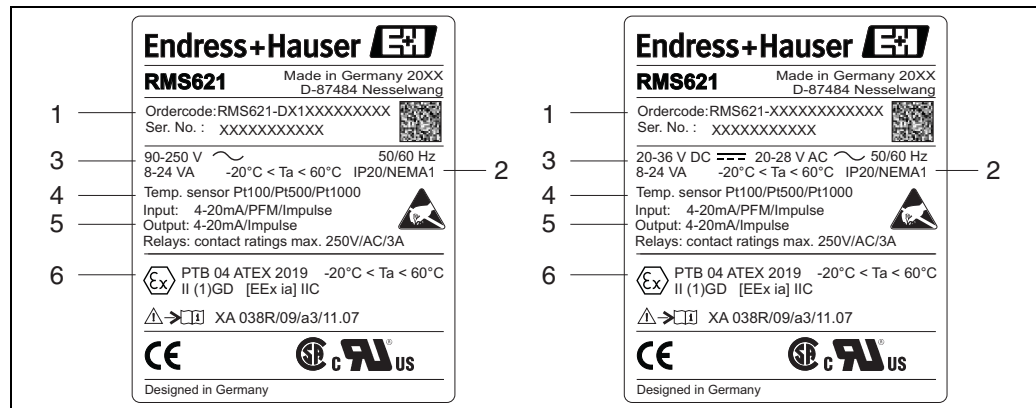

1: Energy Manager legend plate (example)

- 1 Order code and unit series number
- 2 Protection class and allowable ambient temperature
- 3 Power supply
- 4 Temperature sensor input
- 5 Available in/outputs
- 6 Approvals

2.2 Scope of delivery

The scope of delivery of the Energy Manager comprises:

- Energy Manager for top-hat rail mounting
- Operating Instructions
- CD-ROM with PC configuration software and interface cable RS232 (optional)
- Remote display for panel mounting (optional)
- Extension cards (optional)



Please note the device accessories in Section 8 'Accessories'.

2.3 Certificates and approvals

CE mark, declaration of conformity

The Energy Manager has been constructed and tested to state-of-the-art operational safety standards and left the factory in perfect condition as regards technical safety. The device meets the relevant standards and directives as per EN 61 010 "Safety requirements for electrical equipment for measurement, control and laboratory use".

Thus, the device described in these Operating Instructions meets the legal requirements of the EU Directives. The manufacturer confirms successful testing of the device by affixing to it the CE mark.

The device has been developed in accordance with the requirements of the Directives OIML R75 (heat counter) and EN-1434 (flow measurement).

Instrument safety as per UL 3111-1

CSA General Purpose

3 Installation

3.1 Installation conditions

NOTICE

Device overheating when using extension cards

- Aeration with an air flow of at least 0.5 m/s (1.6 fps) is required.

The permitted ambient temperature (see "Technical data" Section) must be observed when installing and operating. The device must be protected against the effects of heat.

3.1.1 Dimensions

Observe the device length of 135 mm (corresponds to 8TE). More dimensions can be found in Section 10 "Technical data".

3.1.2 Mounting location

Top-hat rail mounting as per EN 50 022-35 in the cabinet. The mounting location must be free from vibrations.

3.1.3 Orientation

No restrictions.

3.2 Installation instructions

Now snap the housing onto the top-hat rail by firstly hanging the device on the top-hat rail and then pressing it down gently until it engages (→  2, item 1 and 2).

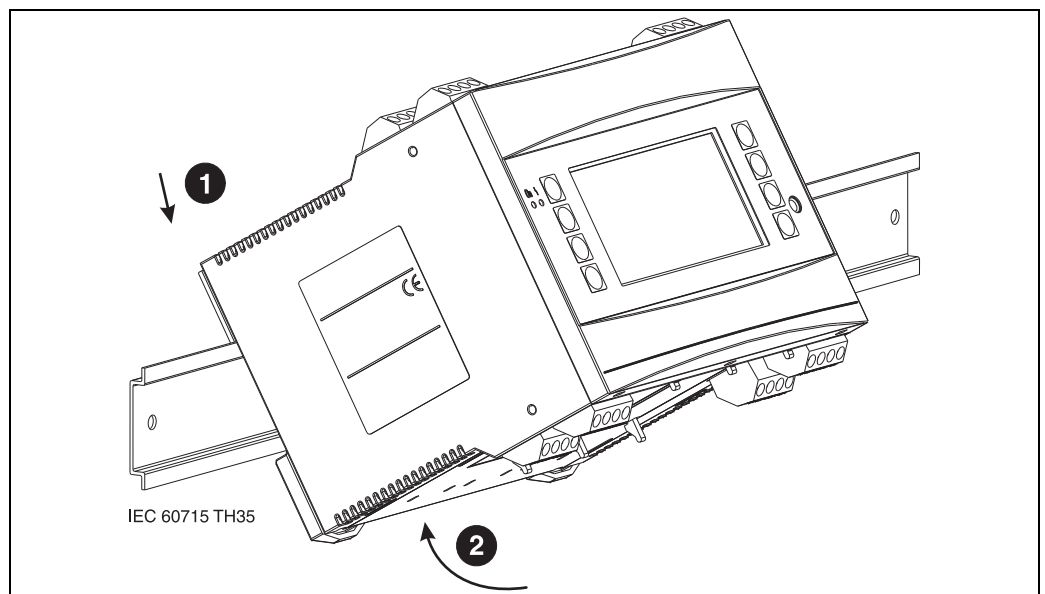

 2: Mounting device on top-hat rail



3.2.1 Installing extension cards

NOTICE

Device overheating when using extension cards

- ▶ Aeration with an air flow of at least 0.5 m/s (1.6 fps) is required.

You can equip the device with various extension cards. A maximum of three slots are available in the device for this. The slots for the extension cards are marked with B, C and D (→  3) on the device.

1. Make sure that the device is not connected to the power supply when installing and removing an extension card.
2. Remove the blanking cover from the slot (B, C or D) of the basic unit by pressing together the catches on the bottom of the Energy Manager (→  3, item 2), while at the same time pressing in the catch on the rear of the housing (e.g. with a screwdriver) (→  3, item 1). Now you can pull the blanking cover up out of the basic unit.
3. Insert the extension card into the basic unit from above. The extension card is not correctly installed until the catches on the bottom and rear of the device (→  3, items 1 and 2) lock into place. Ensure that the input terminals of the extension card are on top and the connection terminals are pointing to the front, as with the basic unit.
4. The device automatically recognizes the new extension card once the device has been correctly wired and has been commissioned (see 'Commissioning' Section).



If you remove an extension card and do not replace it with another card, you must seal the empty slot with a blanking cover.

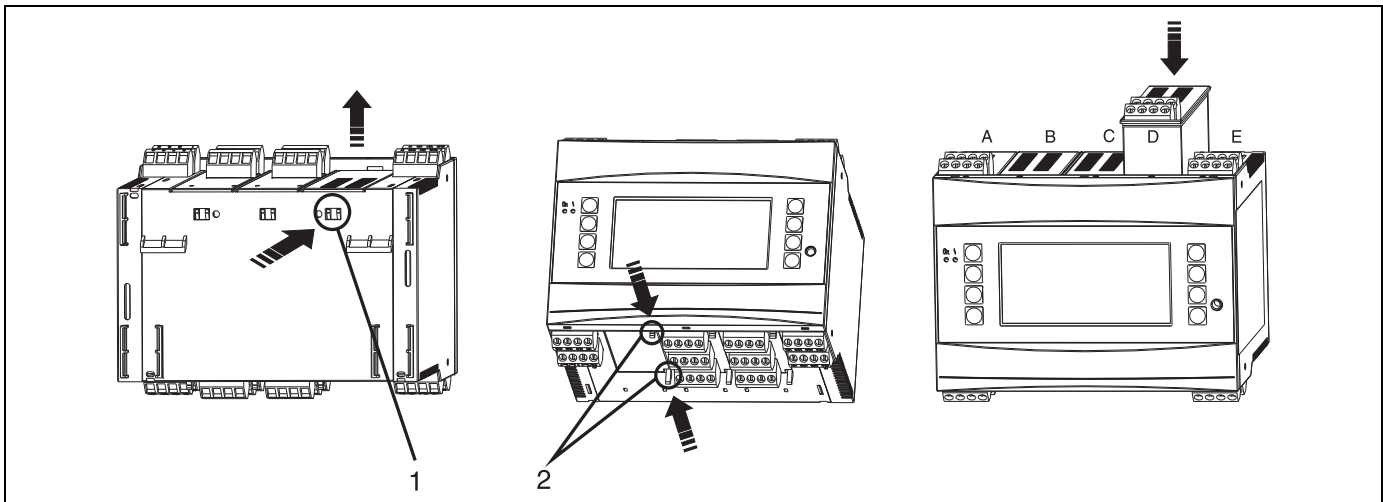

 3: Installing an extension card (example)

Item 1: catch on the rear of the device

Item 2: catches on the bottom of the device

Items A - E: identifier for slot assignment

3.3 Post-installation check

When using extension cards, ensure that the cards are sitting correctly in the device slots.



When using the device as a heat counter, observe the installation instructions EN 1434 Part 6 when mounting the device. This also includes the installation of the flow and temperature sensors.

4 Wiring

4.1 Quick wiring guide

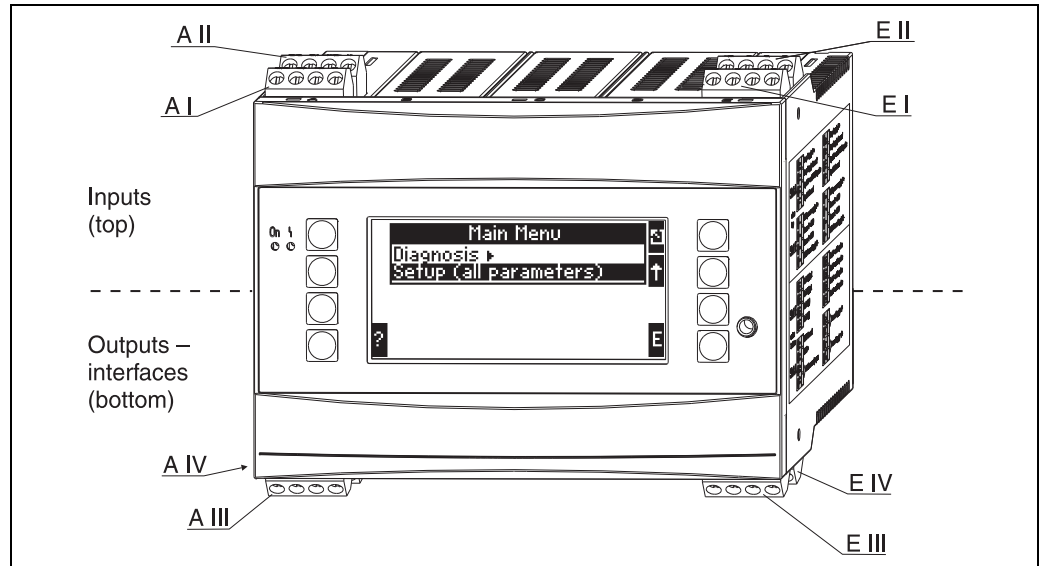

4: Slot assignment (basic unit)

Terminal assignment

Terminal (item no.)	Terminal assignment	Slot	Input
10	+ 0/4 to 20 mA/PFM/pulse input 1	A top, front (A I)	Current/PFM/pulse input 1
11	Ground for 0/4 to 20 mA/PFM/pulse input		
81	Sensor power supply ground 1		
82	24 V sensor power supply 1	A top, rear (A II)	Current/PFM/pulse input 2
110	+ 0/4 to 20 mA/PFM/pulse input 2		
11	Ground for 0/4 to 20 mA/PFM/pulse input		
81	Sensor power supply ground 2		
83	24 V sensor power supply 2	E top, front (E I)	RTD input 1
1	+ RTD power supply 1		
2	- RTD power supply 1		
5	+ RTD sensor 1		
6	- RTD sensor 1		
3	+ RTD power supply 2		
4	- RTD power supply 2		
7	+ RTD sensor 2		
8	- RTD sensor 2		
Terminal (item no.)	Terminal assignment	Slot	Output - interface
101	- RxTx 1	E bottom, front (E III)	RS485
102	+ RxTx 1		
103	- RxTx 2		RS485 (optional)
104	+ RxTx 2		

131	+ 0/4 to 20 mA/pulse output 1	E bottom, rear (E IV)	Current/pulse output 1
132	- 0/4 to 20 mA/pulse output 1		
133	+ 0/4 to 20 mA/pulse output 2		Current/pulse output 2
134	- 0/4 to 20 mA/pulse output 2		
52	Relay Common (COM)	A bottom, front (A III)	Relay 1
53	Relay normally open (NO)		
91	Sensor power supply ground		Additional sensor power supply
92	+ 24 V sensor power supply		
L/L+	L for AC L+ for DC	A bottom, rear (A IV) Power supply	
N/L-	N for AC L- for DC		

i The current/PFM/pulse inputs or the RTD inputs in the same slot are not galvanically isolated. There is a separation voltage of 500 V between the aforementioned inputs and outputs in various slots. Terminals with the same last digit are jumpered internally (Terminals 11 and 81).

4.2 Connecting the measuring unit

⚠ WARNING

Danger through electrical voltage

- ▶ Do not install or wire the device when it is connected to the power supply.

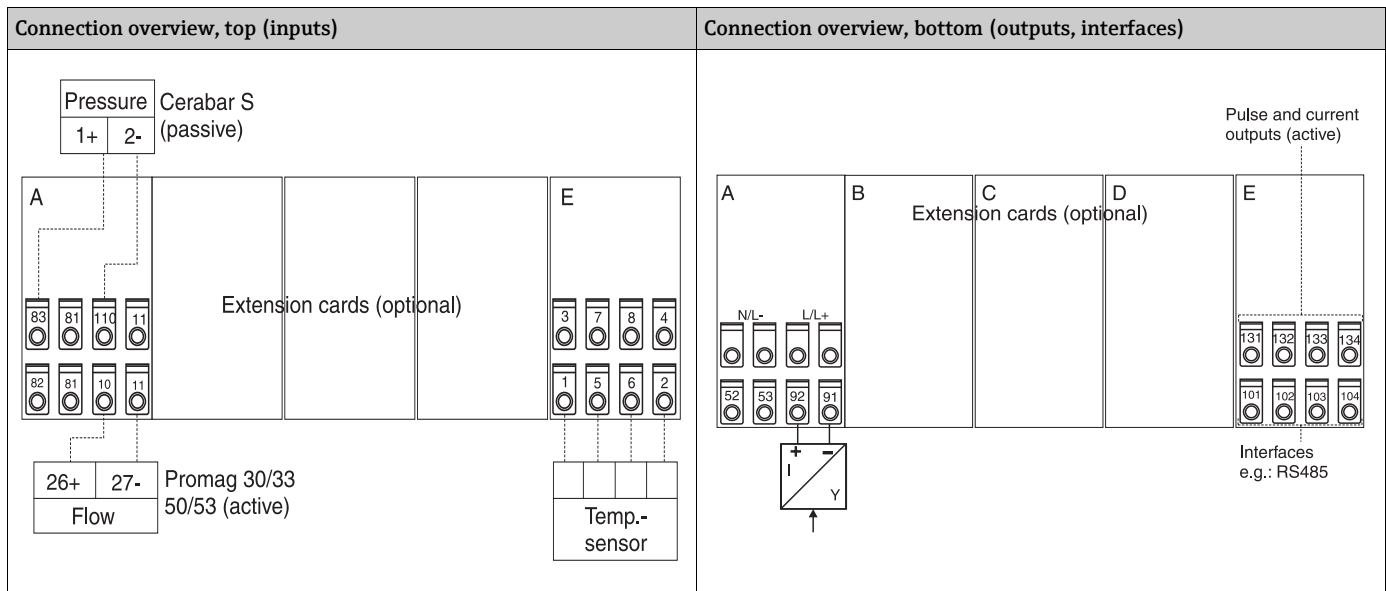

4.2.1 Power supply connection

NOTICE

Damage to the device through incorrect power supply connection

- ▶ Before wiring the device, ensure that the supply voltage corresponds to the specification on the nameplate
- ▶ For the 90 to 250 V AC version (mains connection), a switch marked as a separator, as well as an overvoltage organ (rated current ≤ 10 A), must be fitted in the supply line near the device (easy to reach).

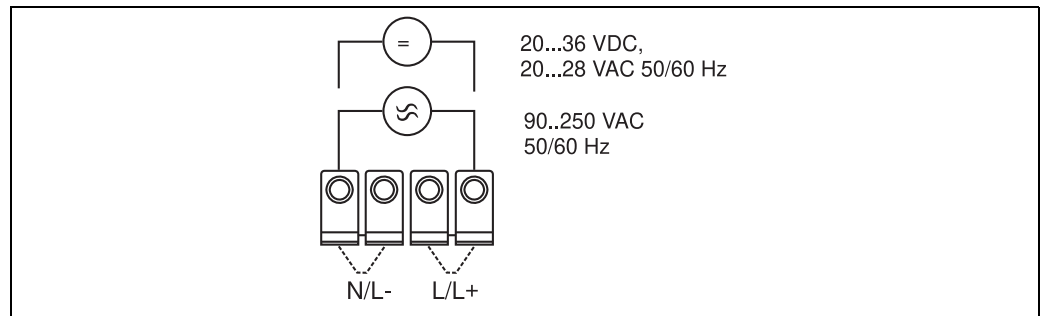

5: Power supply connection

4.2.2 Connecting external sensors



Active and passive sensors with analog, PFM or pulse signal and RTD sensors can be attached to the device.

Depending on the type of signal of the sensor in question, the terminals can be freely selected which means the Energy Manager can be used with great flexibility. This means that the terminals are not fixed to the sensor type, e.g. flow sensor-terminal 11, pressure sensor-terminal 12 etc. If the device is used as a heat counter in accordance with EN 1434, the connection regulations mentioned there apply.

Active sensors

Connection method for an active sensor (i.e. external power supply).

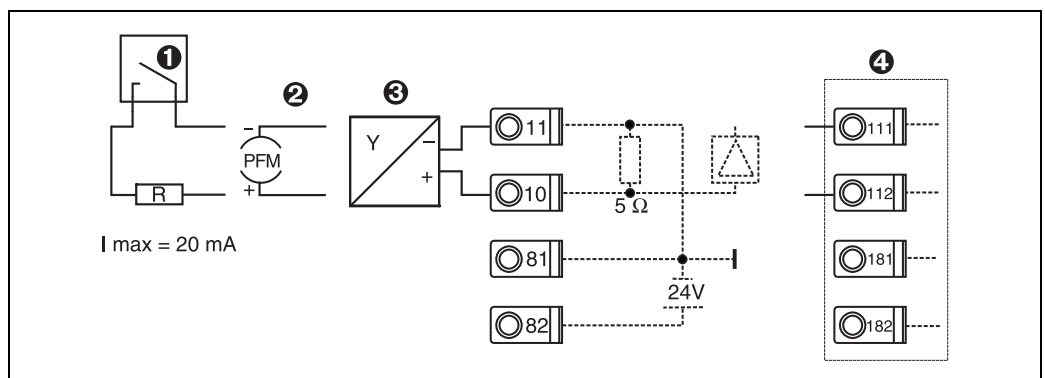

6: Connecting an active sensor, e.g. to input 1 (Slot A I).

Item 1: pulse signal

Item 2: PFM signal

Item 3: 2-wire transmitter (4 to 20 mA)

Item 4: active sensor connection, e.g. optional Universal extension card in slot B (slot BI, → 11)

Passive sensors

Connection method for sensors which are supplied with power by means of the sensor power supply integrated in the device.

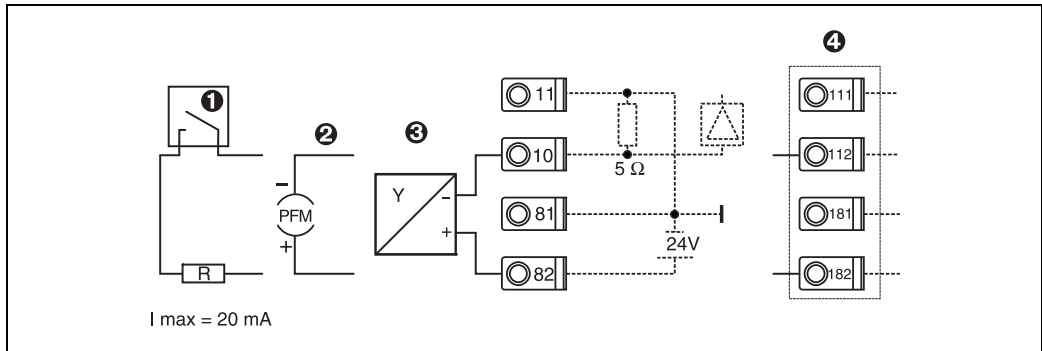

7: Connecting a passive sensor, e.g. to input 1 (slot A I).

Item 1: pulse signal

Item 2: PFM signal

Item 3: 2-wire transmitter (4-20 mA)

Item 4: passive sensor connection, e.g. optional Universal extension card in slot B (slot B I, → 11)

Temperature sensors

Connection for Pt100, Pt500 and Pt1000

i Terminals 1 and 5 (3 and 7) must be jumpered when connecting 3-wire sensors (see → 8).

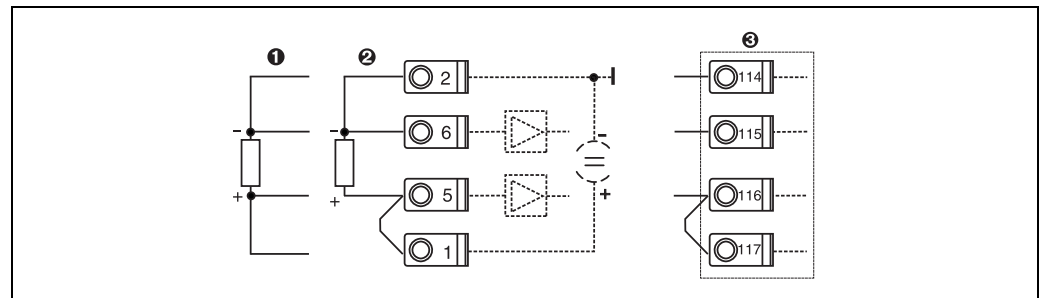

8: Connecting a temperature sensor, e.g. to input 1 (slot E I)

Item 1: 4-wire input

Item 2: 3-wire input

Item 3: 3-wire input, e.g. optional temperature extension card in slot B (slot B I, → 11)

E+H-specific devices

Flow sensors with PFM output

Set the Prowirl measuring device to PFM output (→ FU 20: ON, PF)

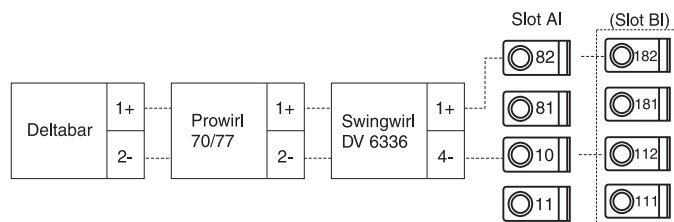

<p>Flow sensor with open collector output Select an appropriate dropping resistor R so that $I_{max.} = 20 \text{ mA}$ is not exceeded.</p>	
<p>Flow sensor with passive current output (4 to 20 mA)</p>	
<p>Flow sensor with active current output (0/4 to 20 mA)</p>	
<p>Flow sensor with active current output and status output (relay) for bidirectional flow measurement Select an appropriate dropping resistor R so that $I_{max.} = 20 \text{ mA}$ is not exceeded.</p> <ul style="list-style-type: none"> ▪ Item A: direction signal ▪ Item B: flow <p>When using a direction signal, select dropping resistor R such that the current output I is between 12 and 20 mA (e.g. 16 mA flows at $R = 1.500 \Omega$)</p>	
<p>Temperature sensor with temperature head transmitter (4 to 20 mA)</p>	

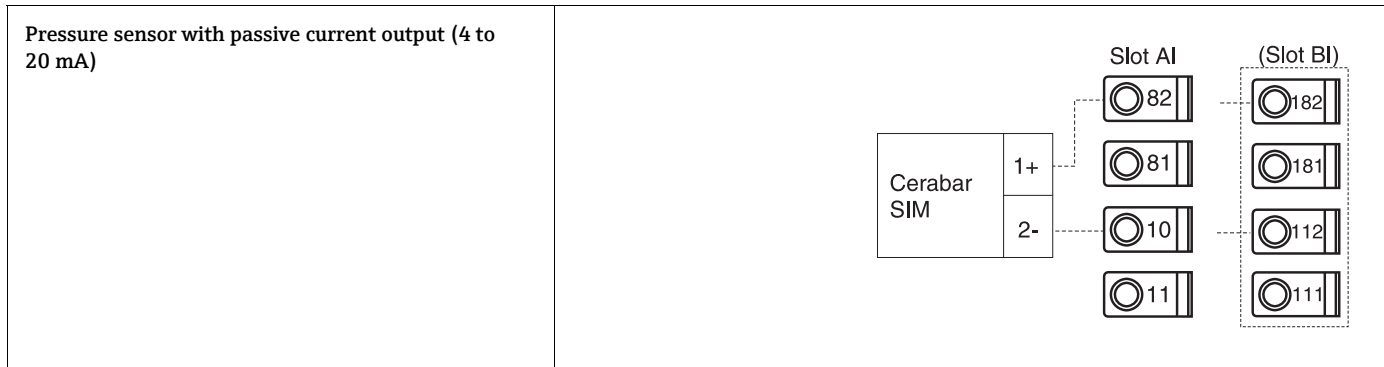

4.2.3 Connection of outputs

The device has two galvanically isolated outputs which can be configured as an analog output or an active pulse output. In addition, an output for connecting a relay and transmitter power supply is available. The number of outputs increases accordingly when the extension cards are installed (→ 19).

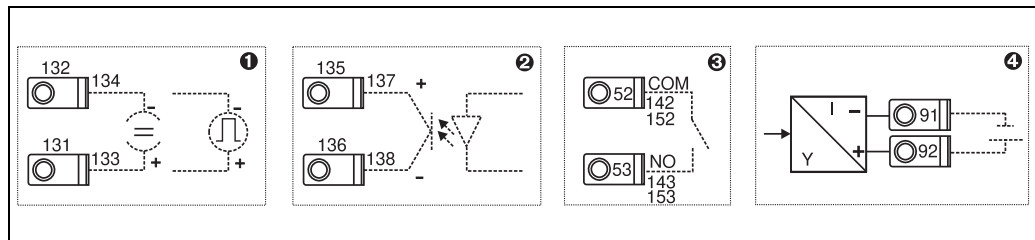

9: Connection of outputs

Item 1: pulse and current outputs (active)

Item 2: passive pulse output (open collector, only on one extension card)

Item 3: relay output (NO), e.g. slot A III (slot BIII, CIII, DIII on optional extension card)

Item 4: transmitter power supply (transmitter power supply unit) output

Interface connection

■ RS232 connection

The RS232 is contacted by means of the interface cable and the jack socket on the front of the housing.

■ RS485 connection

■ Optional: additional RS485 interface

Plug-in terminals 103/104, the interface is only active as long as the RS232 interface is not used.

■ PROFIBUS connection

Optional connection of Energy Manager to PROFIBUS DP via the serial RS485 interface with the external module HMS AnyBus Communicator for Profibus (see Section 8 'Accessories').

■ Optional: MBUS

Optional connection to MBUS via 2nd RS485 interface

■ Optional: Modbus

Optional connection to Modbus via 2nd RS485 interface

No communication via the RS232 interface (jack socket) is possible when the M-BUS or Modbus interface is enabled. The bus interface must be switched to RS232 at the device if data are being transmitted or read out with the PC configuration software.

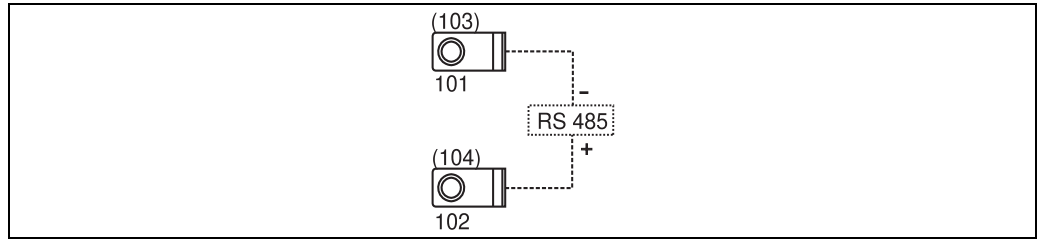

10: Interface connection

4.2.4 Extension card connection

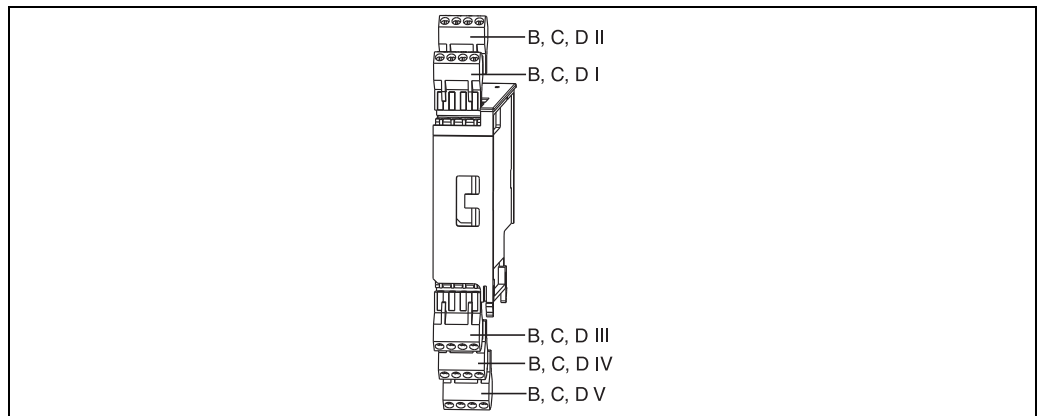

11: Extension card with terminals

Terminal assignment of Universal extension card

Terminal (item no.)	Terminal assignment	Slot	Input and output
182	24 V sensor power supply 1	B, C, D top, front (B I, C I, D I)	Current/PFM/pulse input 1
181	Sensor power supply ground 1		
112	+ 0/4 to 20 mA/PFM/pulse input 1		
111	Ground for 0/4 to 20 mA/PFM/pulse input		
183	24 V sensor power supply 2	B, C, D top, rear (B II, C II, D II)	Current/PFM/pulse input 2
181	Sensor power supply ground 2		
113	+ 0/4 to 20 mA/PFM/pulse input 2		
111	Ground for 0/4 to 20 mA/PFM/pulse input		
142	Relay 1 Common (COM)	B, C, D bottom, front (B III, C III, D III)	Relay 1
143	Relay 1 normally open (NO)		Relay 2
152	Relay 2 Common (COM)		
153	Relay 2 normally open (NO)		
131	+ 0/4 to 20 mA/pulse output 1	B, C, D bottom, center (B IV, C IV, D IV)	Current/pulse output 1 active
132	- 0/4 to 20 mA/pulse output 1		Current/pulse output 2 active
133	+ 0/4 to 20 mA/pulse output 2		
134	- 0/4 to 20 mA/pulse output 2		
135	+ pulse output 3 (open collector)	B, C, D bottom, rear (B V, C V, D V)	Passive pulse output
136	- pulse output 3		Passive pulse output
137	+ pulse output 4 (open collector)		
138	- pulse output 4		

Terminal assignment of temperature extension card

Terminal (item no.)	Terminal assignment	Slot	Input and output
117	+ RTD power supply 1	B, C, D top, front (B I, C I, D I)	RTD input 1
116	+ RTD sensor 1		
115	- RTD sensor 1		
114	- RTD power supply 1		
121	+ RTD power supply 2	B, C, D top, rear (B II, C II, D II)	RTD input 2
120	+ RTD sensor 2		
119	- RTD sensor 2		
118	- RTD power supply 2		
142	Relay 1 Common (COM)	B, C, D bottom, front (B III, C III, D III)	Relay 1
143	Relay 1 normally open (NO)		
152	Relay 2 Common (COM)		Relay 2
153	Relay 2 normally open (NO)		
131	+ 0/4 to 20 mA/pulse output 1	B, C, D bottom, center (B IV, C IV, D IV)	Current/pulse output 1 active
132	- 0/4 to 20 mA/pulse output 1		
133	+ 0/4 to 20 mA/pulse output 2		Current/pulse output 2 active
134	- 0/4 to 20 mA/pulse output 2		
135	+ pulse output 3 (open collector)	B, C, D bottom, rear (B V, C V, D V)	Passive pulse output
136	- pulse output 3		
137	+ pulse output 4 (open collector)		Passive pulse output
138	- pulse output 4		



The current/PFM/pulse inputs or the RTD inputs in the same slot are not galvanically isolated. There is a separation voltage of 500 V between the aforementioned inputs and outputs in various slots. Terminals with the same last digit are jumpered internally. (Terminals 111 and 181).

4.2.5 Connecting remote display/operating unit

Functional description

The remote display is an innovative addition to the powerful RMx621 top-hat rail devices. The user has the opportunity to optimally install the arithmetic unit to suit the installation and mount the display and operating unit in a user-friendly way at easily accessible locations. The display can be connected to both a top-hat rail device without, as well as a top-hat rail device with, an installed display/operating unit. A 4-pin cable is supplied to connect the remote display with the basic unit; other components are not necessary.



Only one display/operating element can be attached to a top-hat rail device and vice versa (point-to-point).

Installation/dimensions

Mounting instructions:

- The mounting location must be free from vibrations.
- The permitted ambient temperature during operation is -20 to +60 °C (-4 to +140 °F).
- Protect the device against the effects of heat.

Procedure for panel mounting:

1. Provide a panel cutout of 138+1.0 x 68+0.7 mm (5.43"+0.04" x 2.68"+0.03") (as per DIN 43700), the installation depth is 45 mm (1.77").
2. Push the device with the sealing ring through the panel cutout from the front.
3. Hold the device horizontal and, applying uniform pressure, push the securing frame over the rear of the housing against the panel until the retaining clips engage. Make sure the securing frame is seated symmetrically.

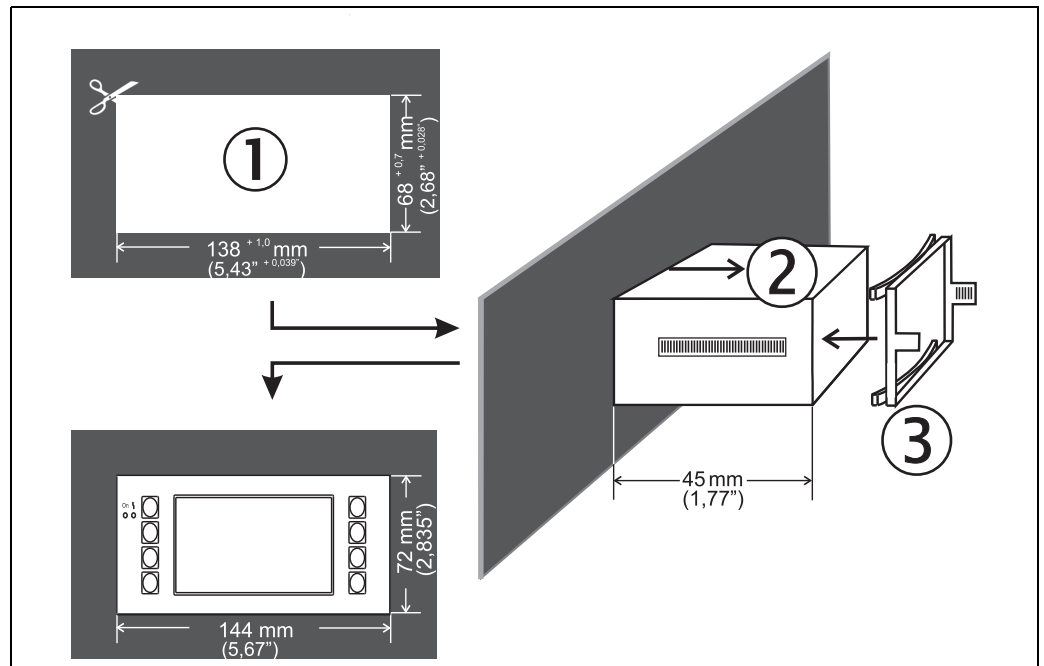

12: Panel mounting

Wiring

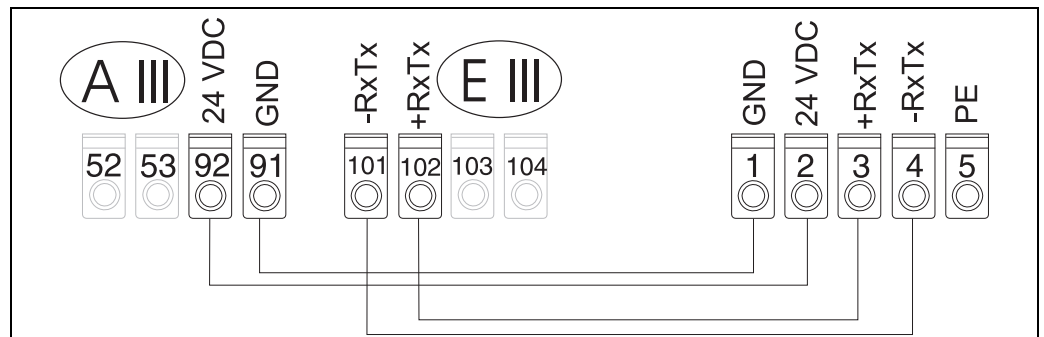

13: Terminal plan of remote display/operating unit

The remote display/operating unit is connected directly to the basic unit with the cable supplied.



When using a Modbus, M-BUS or PROFIBUS interface, the terminal assignment of the RxTx connections (terminals 103/104) may change. When connected to terminals 103/104, the display is out of service during communication with the PC operating software.

Please refer to the information in the additional Operating Instructions descriptions for the bus interfaces in question.

4.3 Post-connection check

After completing the device's electrical installation, carry out the following checks:

Device status and specifications	Notes
Is the device or cable damaged (visual inspection)?	-
Electrical connection	Notes
Does the supply voltage match the information on the nameplate?	90 to 250 V AC (50/60 Hz) 20 to 36 V DC 20 to 28 V AC (50/60 Hz)
Are all of the terminals firmly engaged in their correct slots? Is the coding on the individual terminals correct?	-
Are the mounted cables relieved of tension?	-
Are the power supply and signal cables connected correctly?	See wiring diagram on the housing
Are all of the screw terminals well-tightened?	-

5 Operation

5.1 Display and operating elements



Depending on the application and version, the Flow and Energy Manager offers a wide range of configuration options and software functions. Help text is available for nearly every operating item to assist when programming the device. This help text can be called up by pressing the "?" button. (The help text can be called up in every menu). Please note that the configuration options described below refer to a basic unit (without extension cards).

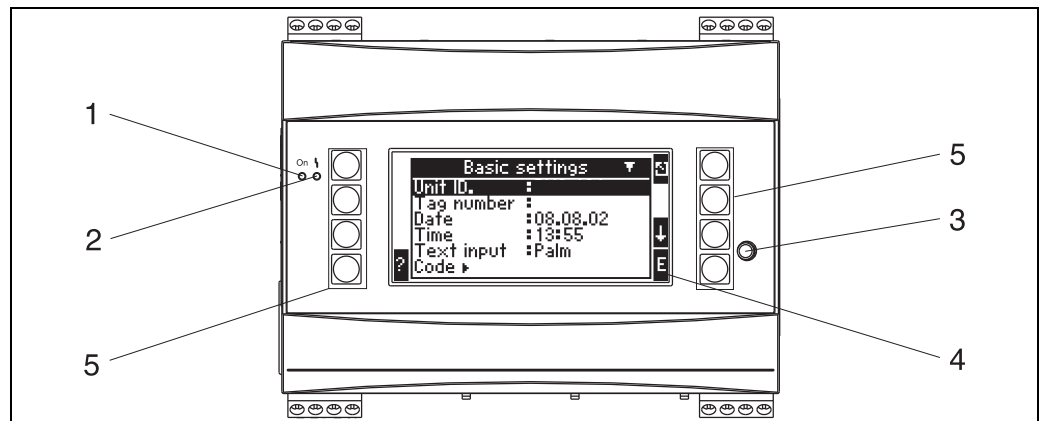

14: Display and operating elements

Item 1: operating display: LED green, lights up when supply voltage applied.

Item 2: fault indicator: LED red, operating status as per NAMUR NE 44

Item 3: serial interface connection: jack socket for PC connection for device configuration and measured value read-out with the PC software

Item 4: display 160 x 80 dot-matrix display with dialog text for configuring as well as measured value, limit value and fault message display. Should a fault occur, the background lighting changes from blue to red. The size of the characters displayed depends on the number of measured values to be displayed (see Section 6.4.3 'Display configuration').

Item 5: input keys; eight soft keys which have different functions, depending on the menu item. The current function of the keys is indicated on the display. Only the keys which are required in the operating menu in question are assigned with functions or can be used.

5.1.1 Display

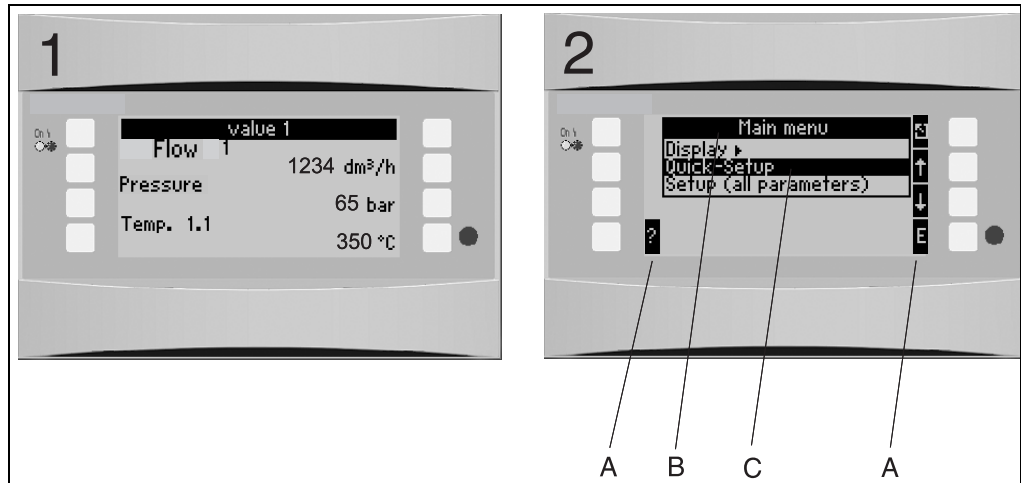

15: How the display of the energy computer appears

Item: 1: measured value display

Item: 2: display of configuration menu item

- A: row of key icons

- B: current configuration menu

- C: configuration menu activated for selection (highlighted in black).

5.1.2 Key icons

Key icon	Function
E	Change to submenus and select operating items. Edit and confirm configured values.
Z	Exit the current editing mask or the menu item currently active without saving any changes.
↑	Move the cursor up a line or a character.
↓	Move the cursor down a line or a character.
→	Move the cursor a character to the right.
←	Move the cursor a character to the left.
?	If Help text is available on an operating item, this is indicated with the question mark. The Help is called up by actuating this function key.
AB	Change to the editing mode of the Palm keyboard
ij/ij	Key field for upper case/lower case (only with Palm)
½	Key field for numerical entries (only with Palm)

5.2 Local operation

5.2.1 Entering text

There are two ways of entering text in the operating items (see: **Setup → Basic Setup → Text Input**):

- Standard: individual characters (letters, numbers, etc.) in the text field are defined by scrolling through the entire row of characters with the up/down cursor until the desired character is displayed.
- Palm: a visual key field appears for entering text. The characters on this keyboard are selected with the cursors. (see "Setup → Basic Setup")

Using the Palm keyboard

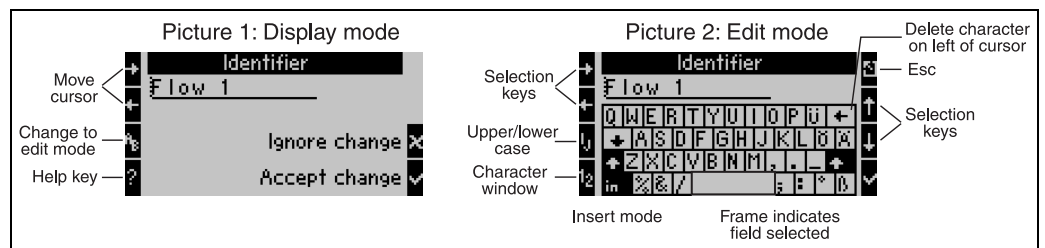

▣ 16: Example: editing an identifier with the Palm keyboard

- Using the cursor keys, place the cursor in front of the character before which another character should be entered. If the entire text should be deleted and rewritten, move the cursor completely to the right. (→ ▣ 16, graphic 1)
- Press the AB key to enter the editing mode
- Use the ij/IJ and ½ key to select upper/lower case or numerals. (→ ▣ 16, graphic 2)
- Use the cursors to select the key required and use the tick sign to confirm. If you want to delete text, select the key in the top right. (→ ▣ 16, graphic 2)
- Edit other characters in this way until the desired text has been entered.
- Press the Esc key to switch from the editing mode to the display mode and accept changes with the 'tick' key. (→ ▣ 16, graphic 1)

Notes

- ▀ The cursor cannot be moved in the editing mode (→ ▣ 16, graphic 2)! Use the Esc key to go to the previous window (→ ▣ 16, graphic 1) to move the cursor to the character which should be changed. Then confirm the AB key again.
- ▀ Special key functions:
 - in key: change to overwrite mode
 - key (top right): delete character

5.2.2 Lock configuration

The entire configuration can be protected against unintentional access by means of a four-digit code. This code is assigned in the submenu: **Basic Setup → Code**. All the parameters remain visible. If the value of a parameter should be changed, you are first asked for the user code.

In addition to the user code, there is also the alarm limit code. When this code is entered, only the alarm limits are enabled for change.

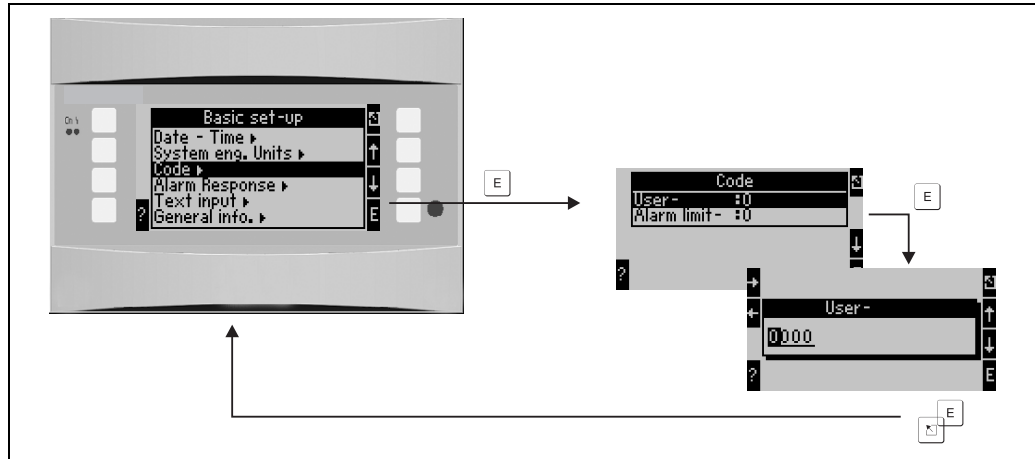

17: Configuring the user code

5.2.3 Operating example

A detailed description of onsite operation with an application as an example can be found in Section 6.4 'User-specific applications'.

5.3 Error message display

The user can configure how the device responds in the event of an error. The measuring range can be freely defined for all analog inputs and the alarm response can be defined for when the system exceeds the range limits. In addition, the alarm response can also be configured if special process errors occur (e.g. wet steam condition).

The alarm response affects the display, counters and outputs.

The alarm response of the device is defined in the operating item **Setup...Basic Setup...Alarm Response**.

Factory setting:

Process errors are always displayed as notice messages, i.e. the errors do not have any effect on the counters and outputs. The NAMUR guidelines apply for the range limits of the analog inputs (current). (3.6/3.8/20.5/21mA)

Free configuration:

The alarm response of the inputs and outputs, as well as of the application-related process errors, can be configured individually. In this way, the behavior of current value calculation, counters and outputs can be defined explicitly.





If the user resets the system from "Free Configuration" to "Factory Setting", all the operating items for setting the alarm response are reset to the default value (overwritten!).

Alarm response

A distinction is made between two types of alarm, namely "Notice" and "Fault"

	Notice	Fault
Current values	The current process values are calculated on the basis of the response configured (last value, fixed value, extrapolation). See under "Inputs".	
Counters	Normal operation (counters continue to count)	Deficits are recorded on a separate disturbance quantity counter (this can be shown on the display and be output via the pulse output) The response of the standard counters can be adjusted (default: counter stop).
Outputs	Outputs are not affected	Outputs react in accordance with the failsafe mode configured
Display	Color change and alarm message display can be configured	Color change to red, alarm message display can be configured

Symbols for displaying error messages

Icons appear along the top edge of the display next to the display parameter affected by the error which has occurred.	
	Signal overshooting ($x > 20.5$ mA) or undershooting ($x < 3.8$ mA)
	Error: fault or notice pending; → error list
	Phase transition: steam condensing, water boiling

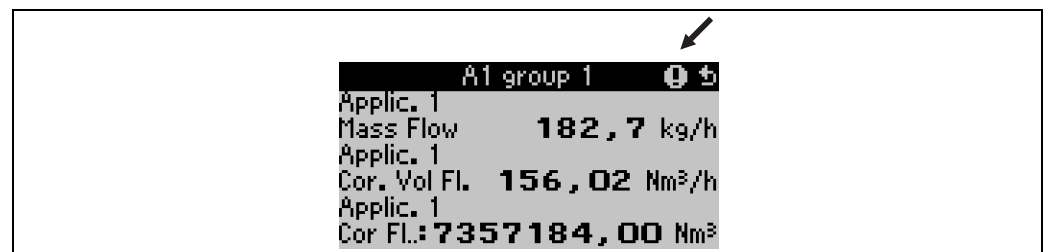

 18: Steam condensation error message (example)

G09-RMC621ZZ-20-10-xx-en-004

Configuration parameters for the alarm response of the inputs

a) Analog inputs

The signal range limits can be freely configured for all the analog inputs. Values for upper and lower range limits and cable open circuit limits have to be defined for this. See the example below.

Example: alarm response of the flow input (4 to 20 mA)

1. Select "Free Configuration" for the alarm response (Setup/Basic Setup/Alarm Response)

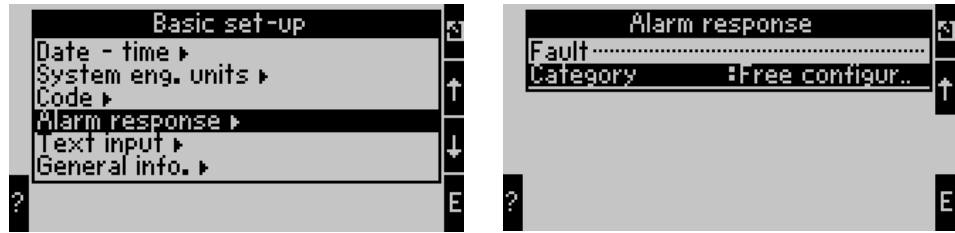

2. Select the flow input (Setup/Inputs/Flow..., called Promag here, for example) and assign the desired range limits and alarm functions under "Alarm Response".

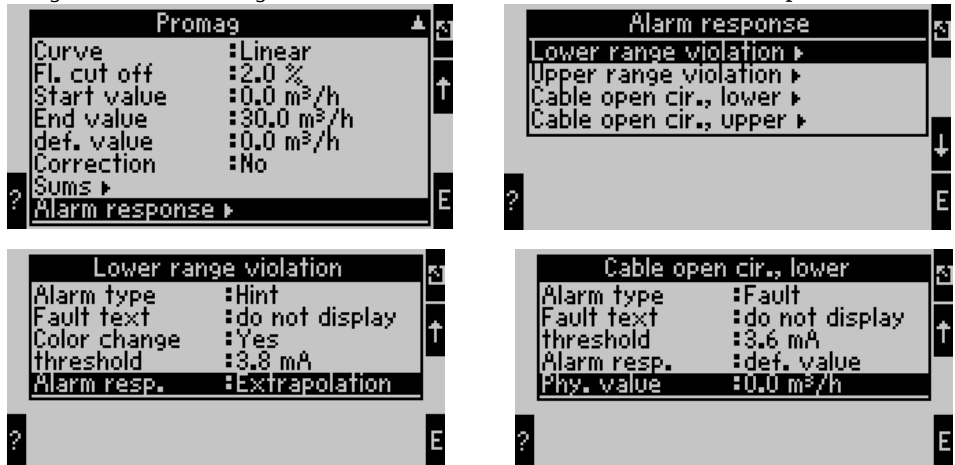

In this example, the flow value is extrapolated between 4 mA and the range violation point of 3.8 mA, extrapolated again between 3.8 mA and the cable open circuit limit of 3.6 mA and evaluated with the default value 0 below 3.6 mA.

Since "Fault" was selected as the alarm type for the cable open circuit, all the outputs of the application to which this input is assigned assume the configured failsafe mode (e.g. output a fixed value of 22 mA (see Section 6.3.3, Setup » Outputs).

The upper range limit and the upper cable open circuit are also configured in this way.

b) Temperature inputs

The response in the event of a cable open circuit (infinite resistance) can be defined for the temperature inputs (e.g. PT100) (the measuring range limits are fixed).

c) Pulse inputs

The alarm response cannot be defined for pulse inputs (incl. PFM signal), i.e. a cable open circuit or a frequency of 0 Hz are interpreted identically by the device.

Configuration parameters for the alarm response of the applications

The alarm response can be defined for the following process errors under Setup/Applications/Alarm Response.

Steam: wet steam alarm, phase transition

Gas: range overshoot



If an error occurs, the system continues calculating with the configured substitute value. At the same time, the error status (H = notice / S = fault) of all the inputs and the application is checked. If one of these statuses signals a fault, the device reacts as follows:

- Disturbance quantity counter records the deficits
- The analog output outputs an error current
- The status byte at the bus output is set to an 'invalid' value

Event buffer**Main Menu → Diagnosis → Event Buffer**

In the event buffer, the last 100 events, i.e. fault messages, notices, limit values, power failure etc. are recorded in chronological order with the time of occurrence and counter reading.

Error list

The error list provides assistance in quickly localizing current device errors. Up to ten alarms are listed in the error list in chronological order. In contrast to the event buffer, only the errors currently pending are displayed, i.e. rectified errors are cleared from the list.

5.4 Communication

In all devices and device versions, the parameters can be configured, altered and read out via the standard interface with the aid of PC operating software and an interface cable (see Section 8 'Accessories'). This is recommended in particular if extensive settings are to be made (e.g. when commissioning).

There is the additional option of reading out all the process and display values via the RS485 interface via MBUS, MODBUS or an external PROFIBUS module (HMS AnyBus Communicator for PROFIBUS-DP) (see 'Accessories' Section).

Configuring a device with PC operating software Readwin® 2000

1. Select a device » **Display/Change Unit Setup/New Unit F2**
2. Create a unit group (folder) and select **Create New Unit F2**. Fill in the "Unit Identifier" and select the serial interface.

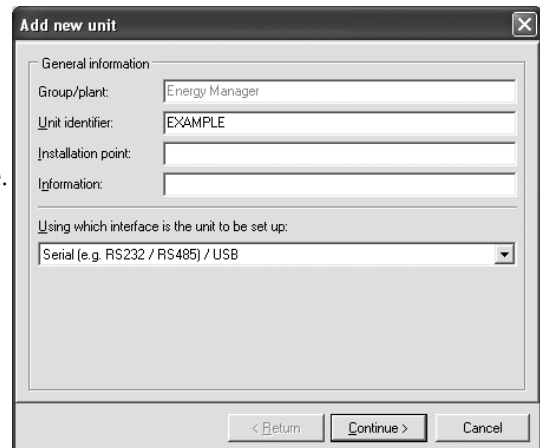

3. Configure the interface parameters.
4. The device address and the baudrate must match.
When using in a BUS system, under certain circumstances no direct communication between the PC and device is possible after the initial configuration. Please refer to the information in the additional Operating Instructions descriptions for the bus interfaces in question.
5. Configure the device and click the third icon from the left to transfer the settings.

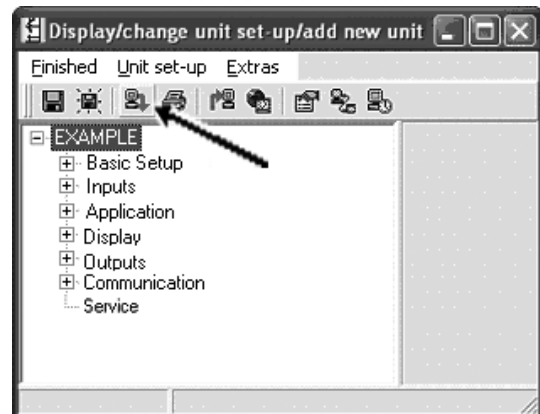
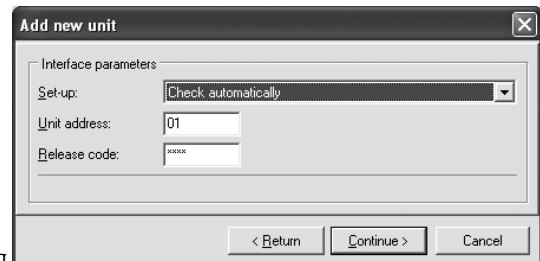

Detailed information for configuring the device using the PC operating software can be found in the accompanying Operating Instructions which are also located on the data carrier.

6 Commissioning

6.1 Function check

Make sure that all post-connection checks have been carried out before you commission your device:

- See Section 3.3 'Post-installation check'
- Checklist Section 4.3 'Post-connection check'

6.2 Switching on the measuring device

6.2.1 Basic unit

Once the operating voltage is applied, the green LED (= device operating) lights up if no fault is present.

- When the device is first commissioned, the prompt "Please Set Up Device" appears on the display. Program the device as per the description → 32.
- When commissioning a device already configured or preset, measuring is immediately started as per the settings. The values of the display group currently set appear on the display. By pressing any key, you get to the navigator (quick start) and from there back to the Main menu (→ 32).

6.2.2 Extension cards

When the operating voltage is applied, the device automatically recognizes the installed and wired extension cards. You can now follow the prompt to configure the new connections or perform the configuration at a later date.

6.2.3 Remote display and operating unit

Once the supply voltage has been applied and after a short initialization period, the remote display/operating unit automatically starts communication to the connected basic unit. Using an autodetect function, the display detects the baudrate and device address configured at the basic unit.

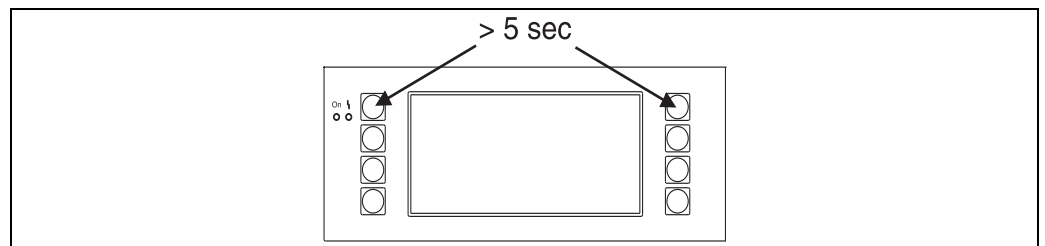

19: Start Setup menu

You can get to the Setup menu of the display/operating unit by pressing the left and right top key at the same time for 5 seconds. Here, the baudrate and the contrast and display viewing angle can be configured. Press ESC to exit the Setup menu of the display/operating unit and to get to the display window and the Main menu to configure the device.



The Setup menu for configuring the basic settings of the display/operating unit is only available in English.

Error messages

After switching on or configuring the device, the message **"Communication Problem"** appears briefly on the remote display/operating unit until a stable connection has been established.

If this error message is displayed during ongoing operation, please check the wiring.

6.3 Device configuration

This section describes all the configurable device parameters with the associated value ranges and factory settings (default values).

Please note that the parameters available for selection, e.g. the number of terminals, depend on the device version (→ 31 Extension cards).

Function matrix

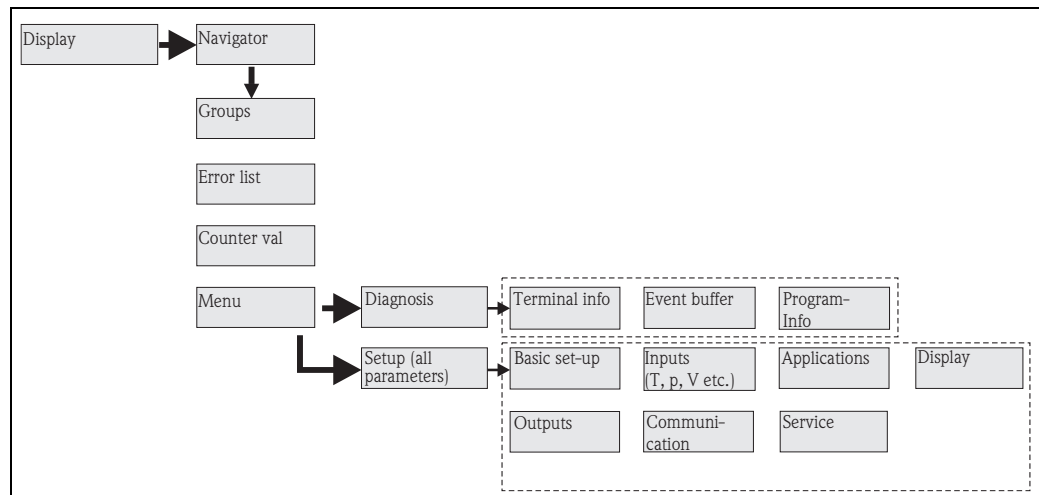

20: Function matrix (extract) for onsite Energy Manager configuration. A detailed function matrix can be found in the Appendix.

6.3.1 Navigator (quick start)

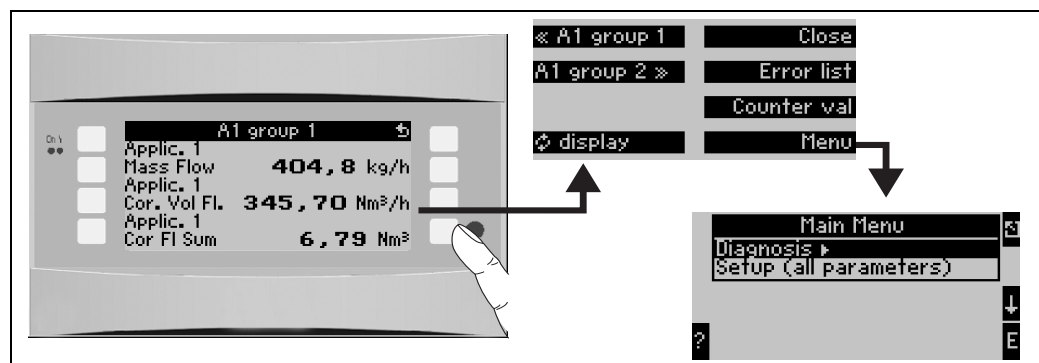

21: Quick start to configuration via the Navigator menu of the Energy Manager.

In the operating mode of the Energy Manager (measured value displayed), the operating window **"Navigator"** opens up by pressing any key: the Navigator menu offers quick access to important information and parameters. Pressing one of the keys available takes you directly to the following items:

Function (menu item)	Description
Group	For selecting individual groups with display values.
↻ Display	For displaying the groups alternately, setting in the Setup menu "Display" .
Error list	For quickly localizing current device errors.
Counter Val	For reading off and, if necessary, resetting all the totalizers.
Menu	Main menu for configuring the device.

The contents of the groups with display values can only be defined in the **Setup → Display** menu. A group comprises a maximum of eight process variables which are displayed in a window in the display. When commissioning the device, 2 groups with the most important display parameters are automatically created when an application is selected. Automatically created groups are also marked with a value in brackets (A1..3) which refers to the application, e.g. Group 1 (A1) means Group 1 with display values for Application 1. The settings for the display functionalities, e.g. contrast, scrolling display, special groups with display values etc. are also made in the menu Setup → Display.



When commissioning, the prompt **"Please Set Up Device"** is displayed. Confirming this message takes you to the Navigator menu. Select **'Menu'** here to get to the Main menu.

A device already configured is in the display mode as standard. The device changes to the Navigator menu as soon as one of the eight operating keys is pressed. From here, you get to the Main menu by selecting **'Menu'**.



If you continue navigating through the Main menu, the message **"If You Change the Application, the Respective Counters Will Be Reset"** is displayed. Confirming this message takes you to the Main menu.

6.3.2 Main menu - Diagnosis

The Diagnosis menu is used to analyze the device functionality, such as locating device malfunctions.

Function (menu item)	Parameter setting	Description
Terminal Info	A10	Lists all the terminals of the device and the connected sensors. Display the signal values present (in mA, Hz, Ohm) by pressing the key i .
Event Buffer		Log of all the events, e.g. error messages, parameter changes, etc. in chronological order. (ring buffer with approx. 100 values, cannot be deleted!)
Program Info		Displays the device data such as program, name, software version, date and time.

6.3.3 Main menu - Setup

⚠ CAUTION

Malfunction of the measuring point in the case of incorrect parameterization

- ▶ If you change configuration parameters, check whether this has an affect on other parameters and your overall measuring system.

The Setup menu is used for configuring the Energy Manager. The following subsections and tables list and describe all the configuration parameters of the Energy Manager.

Procedure when configuring the Energy Manager

1. Select system units (device settings).
2. Configure inputs (flow, pressure, temperature), i.e. assign terminals to the sensors and scale the input signals, if necessary configure default values for pressure and temperature.
3. Select application (e.g. steam mass/heat).
4. Configure application, i.e. assign the configured inputs (sensors) .
5. Configure outputs (analog, pulse or relay/limit values).
6. Check display settings (values are preset automatically).
7. Make optional device settings (e.g. communication settings).

Setup → Basic Setup



Factory settings are indicated in bold.

The basis data of the device are defined in this submenu.

Function (menu item)	Parameter setting	Description
Date-Time		
Date	DD.MM.YY MM.DD.YY	For configuring the current date (country-specific). Important for summertime/wintertime changeover
Time	SS:MM	Current time for the real time clock of the device.
Summertime/Normal Time Changeover		
▪ Changeover	Off - Manual - Auto.	Kind of time changeover.
▪ Region	Europe - USA	Displays the changeover date from normal time (NT) to summertime (ST) and vice versa. This function depends on the region selected.
▪ NT→ST ST→NT - Date - Time	<ul style="list-style-type: none"> ▪ 31.03 (Europe) 07.04 (USA) ▪ 27.10 (Europe) 27.10 (USA) ▪ 02:00 	<p>Takes into consideration the summertime/normal time changeover in Europe and USA at different times. This can only be selected if summertime/normal time changeover is not set to 'Off'.</p> <p>Time of changeover. This can only be selected if summertime/normal time changeover is not set to 'Off'.</p>
System Eng. Units		
System Eng. Units	Metric Factory Setting American Factory Setting Free Configuration	Sets the unitary system. "Free Configuration" means that a picklist with different unitary systems, incl. time basis and format, appears in the individual operating items. Selecting the metric or American factory setting sets the number of digits and the units of the inputs to preset values, e.g. m/h, °C, etc.
Code		
▪ User	0000 - 9999	Device operation is only enabled once the previously defined code has been entered.
▪ Alarm Lim.	0000 - 9999	Only the alarm limits are enabled for configuration. All other parameters remain locked.

Function (menu item)	Parameter setting	Description
Alarm Response		
Fault Category	Factory Setting - Free Configuration	Alarm response when process errors occur. As per the factory setting, all process errors are signaled by a warning message. Due to the free configuration option, additional operating items appear in the inputs and the application to assign a different fault category (fault message) to the individual process errors (see Section 5.3 'Error message display').
Text Input		
	Standard Palm	Selects the way of entering text: <ul style="list-style-type: none"> ■ Standard: Per parameter item, runs up or down the row of characters until the desired character appears. ■ Palm: The desired character can be selected from the visual key field with the cursors.
General Info		
Unit ID		Assigns a device name (max. 12 characters long).
TAG Number		Assigns a TAG number, as in wiring diagrams for example (max. 12 characters long).
Prog. Name		Name which is saved in the PC operating software along with all the settings.
SW Version		Software version of your device.
SW Option		Information as to which extension cards are installed.
CPU No.:		The CPU number of the device is used as an identifier. It is saved with all the parameters.
Series No.:		This is the serial number of the device.
Run Time 1. Unit 2. LCD		<ol style="list-style-type: none"> 1. Information on how long the device has been in operation (protected by service code.) 2. Information on the operating time of the device display (protected by service code.)

Setup → Inputs

Depending on the version, 4 to 10 current, PFM, pulse and RTD inputs are available in the energy computer to record the flow, temperature and pressure signals.

Flow inputs

The Energy Manager processes all common flow measurement methods (volume, mass, differential pressure). You can connect up to three flow transmitters at the same time. There is also the option of using just one flow transmitter in various applications, see 'Terminals' menu item).

Special flow meters

Item for very exact flow based on differential pressure method with compensation calculation as per ISO 5167 as well as splitting range function for extending the measuring range, e.g. for orifice measurement (up to three DP transmitters) and possibility of computing the mean value from several DPTs.

Pressure inputs

A maximum of three pressure sensors can be connected. One sensor can also be used for two or all three applications, see the 'Terminal' item in the related table.

Temperature inputs

For connecting between two and six (max.) temperature sensors (RTD). A sensor can be used in several applications here, see the 'Terminal' item in the related table.

Flow Inputs

Function (menu item)	Parameter setting	Description
Flow Inputs	Flow 1, 2, 3	Configuration of individual flow transmitters.
Identifier		Name of the flow transmitter (max. 12 characters).
Flow Measurement Device	Volumetric Mass Process Value	Setting of the measuring principle of your flow transmitter or as to whether the flow signal is in proportion to the volume, (e.g. vortex, EFM, turbine) or mass (e.g. Coriolis). By selecting "Process Value", the calculated mass flow of another application can be assigned to the input (for details, see Section 11.2 'Flow measurement configuration'). The mass input always has to be assigned to an application.
Signal	Select 4-20 mA 0-20 mA PFM Pulse Default	Selects the signal of the flow transmitter.
Terminals	None A-10; A-110; B-112; B-113; C-112; C-113; D-112; D-113	Defines the terminal to which the flow transmitter in question is connected. It is possible to use a transmitter (flow signal) for several applications. For this, in the application in question, select the terminal where the transmitter is located (multiple selection possible).
Curve	Linear Sqr. Root	Select the curve of the flow transmitter used.
Unit	l/...; hl/...; dm ³ /...; m³ /...; bbl/...; gal/...; igal/...; ft ³ /...; acf/... kg, t, lb, ton (US)	Flow unit in format: <i>selected unit by X</i> Only visible if the "Free Configuration" system unit has been selected. Can only be selected for Flow Transmitter/Mass

Function (menu item)	Parameter setting	Description
Time Base	.../s; .../min; .../h; .../d	Time basis for the flow unit in the format: <i>X per time unit selected</i> . Only visible if the "Free Configuration" system unit has been selected.
gal/bbl	31.5 (US), 42.0 (US), 55.0 (US), 36.0 (Imp), 42.0 (Imp), User def. 31.0	Definition of technical unit Barrel (bbl), given in gallons per barrel. US: US gallons Imp: Imperial gallons User def.: free to set the conversion factor.
Format	9; 9.9 ; 9.99; 9.999	Number of places after the decimal point Only visible if the "Free Configuration" system unit has been selected.
Meter Coeff.	Pulse Value K-Factor	Select the reference variable for the pulse value. Pulse Value (unit/pulse) K-Factor (pulse/unit)
Pulse Value	0.001 to 99999	Setting as to what volume flow (in dm ³ or liter) a pulse of the flow transmitter corresponds to. Only available for Pulse signal.
K Fact. Unit	Pulse/dm ³ Pulse/ft ³	
K-Factor	0.001 to 9999.9	Enter the pulse value of the vortex sensor. You can find this value on your flow sensor. This can only be selected for the PFM signal. For vortex sensors with pulse signal, the reciprocal value of the K-factor (in pulse/dm ³) is entered as a pulse value.
Threshold	0,0000 to 9999999.9 9999999.9	Only for Device type = process value
Start Value	0.0000 to 999999	Start value for the volume flow (differential pressure) with 0 or 4 mA. This can only be selected for the 0/4 to 20 mA signal.
End Value	0.0000 to 999999	End value for the volume flow (differential pressure) with 20 mA. This can only be selected for the 0/4 to 20 mA signal.
Flow Cut Off	0.0 to 99.9% 4.0 %	Below the set value, the flow is no longer recorded or 0 is set. Depending on the type of flow transmitter, the flow cutoff can be set in % of the full scale value of the flow measuring range or as a fixed flow value (e.g. in m ³ /h).
Correction	Yes No	Possibilities for correcting the flow measurement by offset, signal damping, flow cut off, sensor expansion coefficient and correction table for curve description.
Signal Damp	0 to 99 s	Time constant of the first order low pass for the input signal. This function is used to reduce display fluctuations in the event of severely fluctuating signals. This can only be selected for the 0/4 to 20 mA signal.
Offset	-9999.99 to 9999.99	Shifts the zero point of the response curve. This function is used to adjust sensors. This can only be selected for the 0/4 to 20 mA signal.
Correction	Yes No	Possibility for correcting the flow measurement. If "YES" is selected, the sensor curve can be defined in the correction table and there is the possibility of compensating the temperature effect on the flow transmitter (see "Exp. Coeff.")
Expan. Coeff.	0 to 9.9999e-XX	Correction factor for compensating the temperature effect on the flow transmitter. This factor is often indicated on the nameplate for vortex flowmeters, for example. If no value is known for the expansion coefficient or if this has already been compensated by the device itself, please set 0 here. Default: 4.88e-05 Note! Only active if correction setting is active.

Function (menu item)	Parameter setting	Description
Table	Use Not Used	If the flow curve of your transmitter deviates from the ideal pattern (linear or square root), this can be compensated by entering a correction table. For details, see the 'Correction tables' in Section 11.2.1.
No. of Rows	01 - 15	Number of points in the table.
Corr. Tab. Pulse	Point (Used/Delete) Current/Flow Frequency/K-Factor	If the flow curve of your transmitter deviates from the ideal pattern (linear or square root), this can be compensated by entering a correction table. The parameters in the table depend on the flow transmitter selected. <ul style="list-style-type: none"> ▪ Analog signal, linear curve Up to 15 value pairs (current/flow) ▪ Pulse signal, linear curve Up to 15 value pairs (frequency/k-factor or frequency/pulse value). For details, see the 'Correction tables' in Section 11.2.1.
Sums	Unit Format Total Signal Reset Terminals	Possibility of configuring or resetting the totalizers for the volume flow. Signal reset, i.e. resetting the totalizer by an input signal (e.g. remote read-out of totalizers with subsequent reset). (Terminal for this input signal only active if "Signal Reset = YES")
Alarm Response		
Lower Range Violation Upper Range Violation Lower Cable Open Circuit Upper Cable Open Circuit	Alarm Type Color Change Fault Text	For this input, individually specify the signal range limits and how alarms should be displayed when faults occur. Only active if the option 'Random' was selected in the 'Alarm Response' menu item in Setup → Basic Setup.
Alarm Type	Fault Notice	Configurable fault message, deficit counter, color change (red), alarm text display, stop counter (yes/no).
Color Change	Yes No	Select whether the alarm should be signaled by a color change from blue to red. Only active if the 'Notice' alarm type has been selected.
Fault Text	Display+Acknowledge Do Not Display	Select whether an alarm message should appear to describe the fault when an alarm occurs. This is cleared (acknowledged) by pressing a key.

Special Flow Meters

Function (menu item)	Parameter setting	Description
Special Flow Meters	Differential Pressure 1, 2, 3 Mean Flow	Configuration of individual or several differential pressure transmitters (DPT). A DP transmitter always has to be used in an application since this measurement method is based on the process temperature and the process pressure, where applicable. Only use if your DP transmitter outputs a pressure-scaled signal (mbar, inH ₂ O etc.)
Identifier		Name of the flow transmitter (max. 12 characters).
Meas. Point	Select DPT Splitting Range	Select whether one DP transmitter or several DPTs are used for extending the measuring range (Splitting Range). (See Section 11.2.1 for details of the 'Splitting Range')
Differential Pressure Transmitter		
Differential Pressure Transmitter	Pitot Orifice Corner Tap Orifice D2 Orifice Flange Tap ISA 1932 Nozzle Long Rad. Nozzle Venturi Nozzle Venturi Tube (Cast) Venturi Tube (Mach.) Venturi Tube (Steel) V-Cone	Type of differential pressure transmitter The data in brackets refer to the type of Venturi tube.
Medium	Water Steam	Select the medium for which the flow should be measured.
Signal	Select 4-20 mA 0-20 mA PFM Pulse Default	See Setup 'Flow Inputs'
Terminals	None A-10; A-110; B-112; B-113; C-112; C-113; D-112; D-113	See Setup 'Flow Inputs'
Curve	Linear Sqr. Root	Curve of the DP transmitter used. Please observe information in Section 11.2.1!
Time Base	.../s; .../min; .../h; .../d	See Setup 'Flow Inputs'
Unit	l/...; hl/...; dm ³ /...; m³/... ; bbl/...; gal/...; ical/...; ft ³ /...; acf/... kg, t, lb, ton (US)	See Setup 'Flow Inputs' Only visible if the "Free Configuration" system unit has been selected. Can only be selected for flow transmitter/mass
gal/bbl	31.5 (US), 42.0 (US), 55.0 (US), 36.0 (Imp), 42.0 (Imp), User def. 31.0	See Setup 'Flow Inputs'
Format	9; 9.9 ; 9.99; 9.999	See Setup 'Flow Inputs' Only visible if the "Free Configuration" system unit has been selected.
Rng. Units	mbar in/H ₂ O	Unit of differential pressure
Range Start	mbar in/H ₂ O	Start value for the differential pressure with 0 or 4 mA.
Range End	mbar in/H ₂ O	End value for the differential pressure with 20 mA.

Function (menu item)	Parameter setting	Description
Factor		K-factor for describing the resistance coefficient of Pitot tubes (see relevant data sheet).
Correction	Yes No	Possibilities for correcting the flow measurement by offset, signal damping, flow cut off, expansion coefficient of the device (e.g. orifice plate) and correction table for curve description.
Flow Cut Off	0.0 to 99.9% 4.0 %	Below the set value, the flow is no longer recorded or 0 is set. Depending on the type of flow transmitter, the flow cutoff can be set in % of the full scale value of the flow measuring range or as a fixed flow value (e.g. in m ³ /h).
Signal Damp	0 to 99 s	Time constant of the first order low pass for the input signal. This function is used to reduce display fluctuations in the event of severely fluctuating signals. This can only be selected for the 0/4 to 20 mA signal.
Offset	-9999.99 to 9999.99	Shifts the zero point of the response curve. This function is used to adjust sensors. This can only be selected for the 0/4 to 20 mA signal.
Table	Use Not Used	If the flow curve of your transmitter deviates from the ideal pattern (linear or square root), this can be compensated by entering a correction table. For details, see Setup 'Flow Inputs'.
Pipe Data	Inner Dia. Geom. Ratio	Enter the internal diameter of the pipe. Enter the diameter ratio ($d/D = \beta$) of the differential pressure transmitter, data in the data sheet of the DP transmitter. In dynamic pressure measurements, the K-factor must be given to describe the resistance coefficient of the probe (see Section 11.2.1 for details).
Coefficient	Fixed Value Table	Flow coefficient c for calculating the flow. Only if using a V-cone flow transmitter.
Coeff. (c)	0.0001 to 99999	Enter the flow coefficient c.
Num. Coeff.	01 - 15	Number of points in the table.
Coeff. Tab.	Points (Used/Delete) Reynolds No./ Coefficient	Table for describing the flow coefficient depending on the Reynolds number. For details on the V-cone calculation method, see Section 11.2.1
Sums	Unit Format Actual Total Signal Reset Terminals	See Setup 'Flow Inputs'
Splitting Range		
Splitting Range		Splitting range or automatic measuring range switching for differential pressure measuring devices. See Section 11.2.1 for details of the 'Splitting Range'.
Rng.1 Term.	A-10; A-110; B-112; B-113; C-112; C-113; D-112; D-113	Terminal for connecting the differential pressure transmitter with the smallest measuring range
Rng.2 Term.	A-10; A-110; B-112; B-113; C-112; C-113; D-112; D-113	Terminal for connecting the differential pressure transmitter with the second largest measuring range
Rng.3 Term.	A-10; A-110; B-112; B-113; C-112; C-113; D-112; D-113	Terminal for connecting the differential pressure transmitter with the largest measuring range
Range 1 (2, 3) Start	0.0000 to 999999	Start value for the differential pressure at 0 or 4 mA, defined for the pressure transmitter in range 1 (2, 3) Only active after a terminal has been assigned.

Function (menu item)	Parameter setting	Description
Range 1 (2, 3) End	0.0000 to 999999	End value for the differential pressure at 20 mA, defined for the pressure transmitter in range 1 (2, 3) Only active after a terminal has been assigned.
Correction	Yes No	Possibilities for correcting the flow measurement by offset, signal damping, flow cut off, sensor expansion coefficient and correction table for curve description. See Setup 'Differential Pressure Transmitter'
Pipe Data	Units (mm/inch) Inner Dia. Geom. Ratio K-Factor	See Setup 'Differential Pressure Transmitter'.
Sums	Unit Format Actual Total Signal Reset Terminals	See Setup 'Flow Inputs'.
Alarm Response		See Setup 'Flow Inputs'.
Mean Flow		
Identifier	Mean flow	Name for computing the mean value from several flow signals (max. 12 characters).
Mean flow	Unused 2 Sensors 3 Sensors	Mean value computed from several flow signals (See Section 11.2.1 for details of the 'Mean value computation')
Sums	Unit Format Actual Total Signal Reset Terminals	See Setup 'Flow Inputs'.

Pressure inputs

Function (menu item)	Parameter setting	Description
Identifier	Pressure 1-3	Name of pressure sensor, e.g. 'pressure in' (max. 12 characters).
Signal	Select 4-20 mA 0-20 mA Default	Selects the signal of the pressure sensor. If 'Default' is set, the device works with a fixed default pressure.
Terminals	None A-10; A-110; B-112; B-113; C-112; C-113; D-112; D-113	Defines the terminal for connecting the pressure sensor. It is possible to use a sensor signal for several applications. For this, in the application in question, select the terminal where the sensor is located. (Multiple selection possible)
Unit	bar ; kPa; kg/cm ² ; psi; bar (g); kPa (g); psi (g)	Physical unit of the measured pressure. <ul style="list-style-type: none"> ▪ (a) = appears on the display if 'Absolute' was selected as the type. Refers to the absolute pressure. ▪ (g) = gauge, appears on the display if 'Relative' was selected as the type. Refers to the relative pressure. (a) or (g) appears automatically on the display depending on the type selected. Only visible if the "Free Configuration" system unit is selected.
Type	Absolute Relative	Indicates whether the measured pressure is absolute or relative (gauge) pressure. With relative pressure measurement, the atmospheric pressure has to be entered afterwards.
Format	9; 9.9 ; 9.99; 9.999	Number of places after the decimal point Only visible if the "Free Configuration" system unit is selected.
Start Value	0.0000 to 999999	Start value for the pressure with 0 or 4 mA. This can only be selected for the 0/4 to 20 mA signal.
End Value	0.0000 to 999999	End value for the pressure with 20 mA. This can only be selected for the 0/4 to 20 mA signal.
Signal Damp	0 to 99 s	Time constant of the first order low pass for the input signal. This function is used to reduce display fluctuations in the event of severely fluctuating signals. This can only be selected for the 0/4 to 20 mA signal.
Offset	-9999.99 to 9999.99	Shifts the zero point of the response curve. This function is used to adjust sensors. This can only be selected for the 0/4 to 20 mA signal.
Atm. Press.	0.0000 to 10000.0 1.013	Configuration of the ambient pressure (in bar) present at the device installation location. Item is only active if 'Relative' is selected as the type.
Default	-19999 to 19999	Sets the default pressure which is worked with if the sensor signal fails and the 'Default' signal is set.
Alarm Response		See Setup 'Flow Inputs'.
Mean Value	Unused 2 Sensors 3 Sensors	Mean value computed from several pressure signals (See Section 11.2.1 for details of the 'Mean value computation')

Temperature Inputs

Function (menu item)	Parameter setting	Description
Identifier	Temperature 1-6	Name of temperature sensor, e.g. 'Temp 1' (max. 12 characters).
Signal	Select 4-20 mA 0-20 mA Pt100 Pt500 Pt1000 Default	Selects the signal of the temperature sensor. If 'Default' is set, the device works with a fixed default temperature.
Sensor Type	3-wire 4-wire	Configures the sensor connection in 3-wire or 4-wire technology. Can only be selected for the Pt100/Pt500/Pt1000 signal.
Terminals	None A-10; A-110; B-112; B-113; C-112; C-113; D- 112; D-113; B-117; B- 121; C-117; C-121; D- 117; D-121; E-1-6; E-3-8	Defines the terminal for connecting the temperature sensor. It is possible to use a sensor signal for several applications. For this, in the application in question, select the terminals where the sensor is located (multiple selection possible). The term in brackets X-1X (e.g. A-11) describes a current input, the term X-2X (e.g. E-21) a pure temperature input. The type of input depends on the extension cards.
Unit	°C; K; °F	Physical unit of the measured temperature. Only visible if the "Free Configuration" system unit is selected.
Format	9; 9.9 ; 9.99; 9.999	Number of places after the decimal point Only visible if the "Free Configuration" system unit is selected.
Signal Damp	0 to 99 s 0 s	Time constant of the first order low pass for the input signal. This function is used to reduce display fluctuations in the event of severely fluctuating signals. This can only be selected for the 0/4 to 20 mA signal.
Start Value	-9999.99 to 999999	Start value for the temperature with 0 or 4 mA. This can only be selected for the 0/4 to 20 mA signal.
End Value	-9999.99 to 999999	End value for the temperature with 20 mA. This can only be selected for the 0/4 to 20 mA signal.
Offset	-9999.99 to 9999.99 0.0	Shifts the zero point of the response curve. This function is used to adjust sensors. This can only be selected for the 0/4 to 20 mA signal.
Default	-9999.99 to 9999.99 20 °C or 70 °F	Sets the temperature which is worked with if the sensor signal fails and the 'Default' signal is set.
Alarm Response		See Setup 'Flow Inputs'.
Temperature Mean Value	Unused 2 Sensors 3 to 6 Sensors	Mean value computed from several temperature signals (See Section 11.2.1 for details of the 'Mean value computation')

Setup → Applications

Energy Manager applications:

- Steam:
 - Mass - Heat Quantity - Net Heat Quantity - Heat Difference
- Water:
 - Heat Quantity - Heat Difference

Up to three different applications can be calculated simultaneously. The configuration of an application is possible without restricting the applications available up to now in the operating status. Please note that when you have successfully configured a new application or changed the settings of an already existing application, the data are not accepted until the user enables the application at the end (question before exiting the setup).

Function (menu item)	Parameter setting	Description
Identifier	Application 1-3	Name of the configured application, e.g. 'boiler room 1'.
Application	Select Steam Mass/Heat Net Steam S-Heat Diff Water Heat Quantity Water-Heat Diff	Select the desired application (depending on the type of media). If an application in operation should be switched off, choose 'Select' here.
Flow	Select Flow 1-3	Assign a flow sensor to your application. Only the sensors that were configured previously (see 'Setup: Inputs - Flow Inputs') can be selected here.
Pressure	Select Pressure 1-3	Assign the pressure sensor. Only the sensors that were configured previously (see 'Setup: Inputs - Pressure Inputs') can be selected here.
Temperature	Select Temperature 1-6	Assign the temperature sensor. Only the sensors that were configured previously (see 'Setup: Inputs - Temperature Inputs') can be selected here. Not for differential applications.
Steam Type	Superheated Steam Saturated Steam	Sets the type of steam. Only for steam applications.
Input Param.	Q + T Q + P	Input parameters for saturated steam applications. Q + T: flow and temperature Q + P: flow and pressure Only two input variables are required to measure saturated steam. The missing variable is determined by the computer with the saturated steam curve stored (only for 'Saturated Steam' steam type). The input parameters flow, pressure and temperature are required for measuring superheated steam. Only for saturated steam applications.
Op. Mode	Heating Cooling Bidirectional Heating Steam Generation	Setting as to whether your application absorbs energy (cooling) or gives off energy (heating). Bidirectional operation describes a circuit which is used for heating and for cooling. This can only be selected for the "Water Heat Difference" or "Liquid Heat Difference" application. Setting as to whether steam is used for heating purposes or whether steam is generated from water. This can only be selected for the "Steam-Heat Difference" application.
Flow Direct.	Constant Changing	Information on the direction of flow in the circuit with bidirectional operation. Only for the Bidirectional operating mode.
Dir. Signal	Terminals	Terminal for connecting the direction signal output of the flow transmitter. Only for the Bidirectional, Changing flow direction operating mode.

Function (menu item)	Parameter setting	Description
Flow	Select Flow 1-3	Assign a flow sensor to your application. Only the sensors that were configured previously (see 'Setup: Inputs - Flow Inputs') can be selected here.
Inst. Point	Warm Cold	Set the 'thermal' installation point at which the flow sensor is located in your application (only active for water/heat difference or liquid heat difference). The installation point is specified as follows for steam/heat difference: Heating: warm (i.e. steam flow) Steam generation: cold (i.e. water flow) In the event of bidirectional operation, make the settings as per the heating operating mode.
Mean Pres.	10.0 bar	Indicates the average process pressure (absolute) in the heating circuit. Only for water applications.
Temperature Cold	Select Temperature 1-6	Assign the sensor which records the lower temperature in your application. Only the sensors that were configured previously (see 'Setup: Inputs - Temperature Inputs') can be selected here. Only for heat diff. applications.
Temperature Warm	Unused Temperature 1-6	Assign the sensor which records the higher temperature in your application. Only the sensors that were configured previously (see 'Setup: Inputs - Temperature Inputs') can be selected here. Only for heat diff. applications.
Min. T-Diff.	0.0 to 99.9	Sets the minimum temperature difference. If the measured temperature difference undershoots the set value, the heat quantity is no longer calculated. Only for water heat diff. applications.

Units

Configuration of the units for the totalizers and process variables.



The units are automatically preset depending on the system unit selected (Setup: **Basic Setup** → **System Eng. Units**).

Important system units are defined in Section 11 of these Operating Instructions. To achieve the specified level of accuracy, the temperature sensors for measuring a temperature differential must be connected to the terminals of a device slot: (e.g. temperature sensor 1 to E 2/6/5/1, temp. sensor 2 to E 3/7/8/4).

Function (menu item)	Parameter setting	Description
Time Base	.../s; .../min; .../h; .../d	Time basis for the flow unit in the format: <i>X per time unit selected</i> .
Heat Flow	kW, MW, kcal/time, Mcal/time, Gcal/time, kJ/h , MJ/time, GJ/time, KBtu/time, Mbtu/time, Gbtu/time, ton (refrigeration)	Defines the heat quantity per the time unit set previously or the thermal performance.
Heat Sum	kW * time, MW * time, kcal, Gcal, GJ, KBtu, Mbtu, Gbtu, ton * time (*10, *100, *1000) MJ , kJ, therm, decatherm	Unit for the totalized heat quantity or the thermal energy.

Function (menu item)	Parameter setting	Description
Mass Flow	g/time, t/time, lb/time, ton(US)/time, ton(long)/time kg/time	Unit of mass flow per time unit defined previously.
Mass Sum	g, t, lb, ton(US) [*10, *100, *1000], ton(long) kg	Unit of calculated mass sum.
Density	kg/dm ³ , lb/gal ³ , lb/ft ³ kg/m³	Unit of density.
Temp. Diff.	K, °F °C	Unit of temperature difference.
Enthalpy	kWh/kg, kcal/kg, Btu/ lbs, kJ/kg MJ/kg	Unit of specific enthalpy (measurement for the heat contents of the medium.)
Format	9 9.9 9.99 9.999	Number of places after the decimal point with which the values above are shown in the display.
gal/bbl	31.5 (US), 42.0 (US), 55.0 (US), 36.0 (Imp), 42.0 (Imp), User def. 31.0	Definition of technical unit Barrel (bbl), given in gallons per barrel. US: US gallons Imp: Imperial gallons User def.: free to set the conversion factor.

Sums (totalizers)

Two resettable and two non-resettable totalizers (grand totalizers) are available for mass, heat or corrected volume flow. The grand totalizer is marked by "Σ" in the display element picklist. (Menu item: **Setup (all parameters) → Display → Group 1... → Value 1... → Σ Heat Sum ...**

Sum overflows are recorded in the event buffer (menu item: **Display/Event Buffer**). The totalizers can also be displayed as an exponential value to avoid overflow (Setup: **Display → No. of Sums**).

The totalizers are configured in the submenu **Setup (all parameters) → Applications → Applications ... → Sums**. The totalizers can also be reset to zero by signal. For this purpose, a signal is used that supplies a current between $I = 12$ to 20 mA for approx. 0.5 to 1.5 seconds.

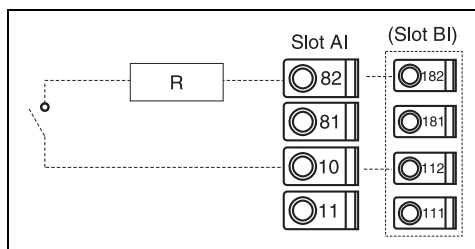

Terminal assignment with counter reset via signal (e.g.: $R = 1500 \Omega \Rightarrow I = 16 \text{ mA}$).



In the Setup "**Navigator → Counter Val**", all the totalizers are listed and can be read out and, if necessary, reset to zero individually or all together.

Function (menu item)	Parameter setting	Description
Heat Heat (-) *	0 to 99999999.9	Heat totalizer of the application selected. Can be configured and reset.
Mass Mass (-) *	0 to 99999999.9	Mass totalizer of the application selected. Can be configured and reset.

Function (menu item)	Parameter setting	Description
Flow-	0 to 99999999.9	Flow totalizer (volume flow) of the application selected. Can be configured and reset.
Signal Reset	Yes - No	Select whether to reset the totalizer by input signal.
Terminals	A10, A82 / A110, A83	Input terminals for signal reset.
Identifier		Identifier with which the heat or mass totalizer is shown on the display.
Counter Stop	Yes - No	Yes: When a fault message occurs, the "normal" counter stops. Deficits are totalized on the disturbance quantity counter. No: The "normal" counter continues to count. Deficits are additionally recorded on the disturbance quantity counter.

* In the bidirectional mode of operation (water-heat difference) there are two additional totalizers plus two grand totalizers. The additional totalizers are marked with (-). Example: A boiler load process is recorded by the 'heat' totalizer and the unload process by the '-heat' totalizer.

Alarm response



Item only active if 'Random' is selected in the 'Alarm Response' menu item in "**Setup** → **Basic Setup**".

Function (menu item)	Parameter setting	Description
Wet Steam Alarm Phase Transition		Only active if 'Water/Steam' was selected in the Media menu item. Wet Steam: Risk that steam partially condenses! The alarm is triggered 2 C above the saturated steam temperature (=condensate temperature). Phase Transition: Condensate temperature (=saturated steam temperature) reached, i.e. state of aggregation can no longer be defined. Wet steam is present!
Alarm Type	Fault Notice	Fault: totalizer stop (configurable), color change (red); display an alarm message in plain text can be configured; outputs react in accordance with the set failsafe mode. Notice: totalizers and outputs unaffected, color change and message display can be configured.
Color Change	Yes No	Select whether the alarm should be signaled by a color change from blue to red. Only active if the 'Notice' alarm type has been selected.
Fault Text	Display+Acknowledge Do Not Display	Select whether an alarm message should appear to describe the fault when a fault occurs. This is cleared (acknowledged) by pressing a key.

Setup → Display

The device display can be freely configured. Up to six groups, each with 1 to 8 freely definable process values, can be displayed individually or alternately. For each application, the most important values are automatically shown in two windows (groups) in the display: this does not apply if the display groups have already been defined. The way the process values are displayed depend on the number of values in a group.

Group 1	
Applic. 1	
Mass Flow	84,9 kg/h
Applic. 1	
Temp. 1.1	30,5 °C
Applic. 1	
Heat Flow	401,35 kW

If displaying one to three values in a group, all values with the name of the application and identifier (e.g. heat totalizer) and the related physical unit are displayed.

As of four values, only the values and the physical unit are displayed.



In Setup "**Display**", the display functionality is configured. In "**Navigator**", then select which group(s) appear(s) with process values on the display.

Function (menu item)	Parameter setting	Description
Group 1 to 6 Identifier		A name (max. 12 characters) can be given to the groups for a better overview.
Display Mask	1 Value to 8 Values Select	Here, set the number of process values which should be displayed beside one another in a window (as a group). The way the value is displayed depends on the number of selected values. The more values in a group, the smaller the display.
Value Type	Inputs, Process Values, Counter, Totalizer, Miscellaneous	The display values can be selected from 4 categories (types).
Value 1 to 8	Select	Selects which process values should be displayed.
Scrolling Display		Alternating display of individual groups on the display.
Swit. Time	0 to 99 0	Seconds until the next group is displayed.
Group X	Yes No	Select the groups that should be displayed alternately. The alternating display is activated in the "Navigator" / "Display" (see 6.3.1).
Display		
OIML	Yes No	Selects whether the counter readings should be displayed as per the OIML standard.
No. of Sums	Counter Mode Exponential	Sum display Counter mode: sums are displayed with max. 10 positions up to overflow. Exponential: exponential display is used for large values.
Contrast	2 to 63 46	For configuring the display contrast. This setting has an immediate affect. The contrast value is not saved until the setup is exited.

Setup → Outputs

Analog outputs



Please note that these outputs can be used as both analog and pulse outputs; the desired signal type can be selected for each setting. Depending on the version (extension cards), 2 to 8 outputs are available.

Function (menu item)	Parameter setting	Description
Identifier	Anal. Outp. 1 to 8	An identifier can be given to the analog output in question for a better overview (max. 12 characters).
Terminals	B-131, B-133 C-131, C-133 D-131, D-133 E-131, E-133 None	Defines the terminal at which the analog signal should be output.
Sig. Source	Density 1 Enthalpy 1 Flow 1 Mass Flow 1 Pressure 1 Temperature 1 Heat Flow 1 Select	Setting as to which calculated or measured variable should be output at the analog output. The number of signal sources depends on the number of configured applications and inputs.
Curr. Range	4 to 20 mA , 0 to 20 mA	Specifies the mode of operation of the analog output.
Start Value	-999999 to 999999 0.0	Smallest output value of the analog output.
End Value	-999999 to 999999 100	Largest output value of the analog output.
Time Const. (signal damping)	0 to 99 s 0 s	Time constant of the first order low pass for the input signal. This is used to prevent large fluctuations in the output signal (can only be selected for the signal type 0/4 and 20 mA).
Fault Cond. Action	Minimum Maximum Value Last Value	Defines the behavior of the output in the event of a fault, e.g. if a sensor in the measurement fails.
Value	-999999 to 999999 0.0	Fixed value which should be output at the analog output in the event of a fault. Only for the Fault Cond. Action setting; value can be selected.
Simulation	0 - 3.6 - 4 - 10 - 12 - 20 - 21 Off	The function of the current output is simulated. Simulation is active if the setting is not 'off'. Simulation ends as soon as you leave this item.

Pulse outputs

The pulse output function can be configured with active, passive output or relay. Depending on the version, 2 to 8 pulse outputs are available.

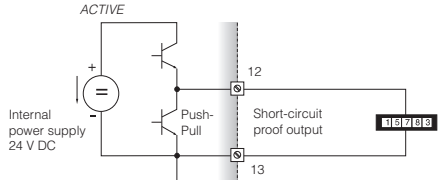
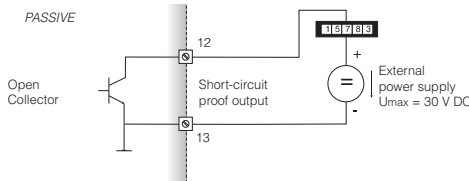
Function (menu item)	Parameter setting	Description
Identifier	Pulse 1 to 8	An identifier can be assigned to the pulse output in question for a better overview (max. 12 characters).

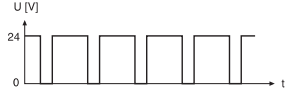
Function (menu item)	Parameter setting	Description
Signal	Active Passive Relay Select	Assign the pulse output. Active: Active voltage pulses are output. Power is supplied from the device. Passive: Passive open collectors are available in this operating mode. Power must be supplied externally. Relay: The pulses are output on a relay. (The frequency is max. 5Hz) "Passive" can only be selected when extension cards are used.
Terminals	B-131, B-133, C-131, C-133, D-131, D-133, E-131, E-133 B-135, B-137, C-135, C-137, D-135, D-137 A-52, B-142, B-152, C-142, C-152, D-142, D-152 None	Defines the terminal at which pulses should be output.
Sig. Source	Heat Sum 1, Heat Sum 2, Flow Sum 1, Flow Sum 2, etc. Select	Setting as to which variable should be output at the pulse output.
Pulse		
Type	Negative Positive	<p>Makes it possible to output pulses in a positive or negative direction (e.g. for external electronic totalizers):</p> <ul style="list-style-type: none"> ■ ACTIVE: the device-internal power supply is used (+24 V) ■ PASSIVE: external power supply necessary ■ POSITIVE: quiescent level at 0 V ("active-high") ■ NEGATIVE: quiescent level at 24 V ("active-low") or external power supply  <p>For continuous currents up to 15 mA</p>  <p>For continuous currents up to 25 mA</p> <p>POSITIVE pulses</p>  <p>NEGATIVE pulses</p>  <p>PASSIVE-NEGATIVE PASSIVE-POSITIVE ACTIVE-NEGATIVE ACTIVE-POSITIVE</p>

Function (menu item)	Parameter setting	Description
Unit	g, kg, t for mass sum signal source kWh, MWh, MJ for heat sum signal source dm³ for flow signal source	Unit of the output pulse. Pulse unit depends on the signal source selected.
Unit Value	0.001 to 10000.0 1.0	Setting as to which value a pulse corresponds to (unit/pulse). $\text{Pulse value} > \frac{\text{Estimated max. flow (end value)}}{\text{Desired max. output frequency}}$
Width	Yes No	The pulse width limits the max. possible output frequency of the pulse output. Standard = pulse width fixed, i.e. always 100 ms. User defined = pulse width can be freely configured.
Value	0.04 to 1000 ms	Configuration of the pulse width suiting the external totalizer. The maximum permitted pulse width can be calculated as follows: $\text{Pulse width} < \frac{1}{2 \times \text{max. output frequency [Hz]}}$
Simulation	0.0 Hz - 0.1 Hz - 1.0 Hz - 5.0 Hz - 10 Hz - 50 Hz - 100 Hz - 200 Hz - 500 Hz - 1000 Hz - 2000 Hz Off	The function of the pulse output is simulated with this setting. Simulation is active if the setting is not "off". Simulation ends if you leave this item.

Relay/Set Point

Relays or passive digital outputs (open collector) are available in the relay for limit functions. Depending on the version, 1 to 13 limit values (set points) are available.

Function (menu item)	Parameter setting	Description
Identifier	Set Point 1 to 13	An identifier can be assigned to the set point in question for a better overview (max. 12 characters).
Transmit By	Display Relay Digital Select	Assigns where the set point is output (passive digital output only available with extension card).
Terminals	A-52, B-142, B-152, C-142, C-152, D-142, D-152 B-135, B-137, C-135, C-137, D-135, D-137 None	Defines the terminal of the set point selected. Relay: terminals X-14X, X-15X Digital: terminals X-13X

Function (menu item)	Parameter setting	Description
Op. Mode	Max+Alarm, Grad.+Alarm, Alarm, Min, Max, Gradient, Wet Steam Alarm, Unit Failure Min+Alarm	Definition of the event which should activate the set point. <ul style="list-style-type: none"> ▪ Min+Alarm Minimum safety, event report when set point is undershot with simultaneous signal source monitoring to NAMUR NE43. ▪ Max+Alarm Maximum safety, event report when set point is overshoot with simultaneous signal source monitoring to NAMUR NE43. ▪ Grad.+Alarm Gradient analysis, event report when set signal change is overshoot per time unit of the signal source with simultaneous signal source monitoring to NAMUR NE43. ▪ Alarm Signal source monitoring to NAMUR NE43, no set point function. ▪ Min Event report when set point is undershot without taking NAMUR NE43 into consideration. ▪ Max Event report when set point is overshoot without taking NAMUR NE43 into consideration. ▪ Gradient Gradient analysis, event report when set signal change is overshoot per time unit of the signal source without taking NAMUR NE43 into account. ▪ Wet steam alarm Relay (output) switches in the event of a wet steam alarm (2 C above saturated steam temperature). ▪ Unit failure Relay (output) switches when a device fault is present (collective alarm for all faults).
Sig. Source	Flow 1, Heat Flow 1, Mass Sum 1, Flow 2, etc. Select	Signal sources for the selected set point. The number of signal sources depends on the number of configured applications and inputs.
Swit. Point	-99999 to 99999 0.0	Smallest output value of the analog output.
Hysteresis	-99999 to 99999 0.0	Specify set point switch-back threshold to suppress set point bounce.
Time Delay	0 to 99 s 0 s	Time span of limit value violation before it is displayed. Suppresses peaks in the sensor signal.
Gradient - Δx	-19999 to 99999 0.0	Value of signal change for gradient analysis (inclination function).
Gradient - Δt	0 to 100 s 0 s	Time interval for the signal change of the gradient analysis.
Gradient -reset value	-19999 to 99999 0	Switch-back threshold for gradient analysis.
Limit On		You can write a message for when the limit value (set point) is overshoot. Depending on the setting, this appears in the event buffer and the display (see 'Lim. Display')
Limit Off		You can write a message for when the limit value (set point) is undershot. Depending on the setting, this appears in the event buffer and the display (see 'Lim. Display')
Limit Dis.	Disp.+Ackn. Not Display	Definition of the way of reporting the limit value. Not Display: Limit value violation or violated limit value undershooting is recorded in the event buffer. Disp.+Ackn.: Entered in the event buffer and shown on the display. The message does not disappear until it is acknowledged with a key.

Setup → Communication

An RS232 interface at the front and an RS485-interface at terminals 101/102 can be selected as standard. In addition, all process values can be read out via the PROFIBUS DP protocol.

Function (menu item)	Parameter setting	Description
Unit Adr.	0 to 99 00	Device address for communicating via the interface.
RS232		
Baudrate	9600, 19200, 38400 57600	Baudrate for the RS232 interface
RS485		
Baudrate	9600, 19200, 38400 57600	Baudrate for the RS485 interface
PROFIBUS-DP/ModBus/M-Bus (optional)		
Number	0 to 48 0	Number of values which should be read out via the PROFIBUS-DP protocol (max. 49 values).
Adr. 0...4	e.g. density x	Assigns the values to be read out to the addresses.
Adr. 5...9 to Adr. 235...239	e.g. temp. diff. x	49 values can be read out via an address. Addresses in bytes (0...4, ... 235...239) in numerical order.



A detailed description of how to integrate the device into a PROFIBUS, ModBus or M-Bus system can be found in the additional descriptions:

- HMS AnyBus Communicator for PROFIBUS (BA00154R/09/en)
- M-Bus interface (BA00216R/09/en)
- ModBus interface (BA00231R/09/en)

Setup → Service

Service menu. **Setup (all parameters) → Service.**

Function (menu item)	Parameter setting	Description
Preset		Resets the device to the delivery status with the factory default settings (protected by service code). This resets all the parameters you configured.
Display mode	Auto Lowres Highres	Setting for the display resolution. 'Lowres' is used to operate a remote display with a low resolution (older model).
Total sums	Sums Appl. 1 Sums Appl. 2 Sums Appl. 3	Cumulative totalizer display Info for service: cannot be edited or reset!

6.4 User-specific applications

6.4.1 Example of application: Steam mass

The amount of superheated steam in the feed pipe of a plant (20 t/h rating, approx. 25 bar (362.6 psi)) is to be determined. This is never allowed to go below 15 t/h steam flow. This is to be safeguarded by a relay (with alarm) in the Energy Manager.

The display of the Energy Manager is to alternate between one screen containing the mass flow, pressure and temperature and another with the totalized mass flow.

The following sensors are used for measuring:

- Volume flow: vortex sensor
Nameplate specifications: K-factor = 8.9; signal type = PFM, alpha-factor = 4.88×10^{-5}
- Pressure: pressure sensor (4 to 20 mA, 0.005 to 40 bar)
- Temperature: Pt100 temperature sensor

1. **Flow transmitter (Setup Inputs - Flow Inputs) Flow 1**
Signal: PFM
K-factor: 8.9
Thermal exp. coeff: 4.88×10^{-5}
 (see example on left-hand side)

2. Pressure sensor (Setup/ Pressure):
 Pressure 1
 Signal: 4 to 20 mA,
 Start value 0.005 bar,
 End value 40 bar,
 Default 25 bar (pressure the energy computer keeps working with if the sensor fails)

3. Temperature sensor (Setup/ Temperature):
 Temp. 1.1,
 Signal: Pt100.
 Default (enter average operating temperature expected).

4. Configure application (Setup/ Applications):
 Application 1
 Steam mass
 Superheated steam
 Flow 1
 Pressure 1
 Temp. 1.1
 Engineering units: Mass flow t/h, Mass sum t

5. Configure display (Setup/ Display):
 Group 1: 3 values (mass flow, pressure, temperature)
 Group 2: 1 value (mass sum) scrolled: 10 seconds,

 Group 1: Yes,
 Group 2 : Yes

6. Set up alarm set point:
 Relay,
 operating mode Min+Alarm,
 signal source mass flow,
 switch point 15 t/h,
 hysteresis 0.5 t/h (this means relay reset at 15.5 t/h)

Exit setup by pressing ESC several times and confirming **(it)** the changes.

Display

When you press any key, you can select a group with display values or display all groups with automatic alternating display (22). If a fault occurs, the display changes color (blue/red). See Section 5.3 'Error message display' for information on how to eliminate the error.

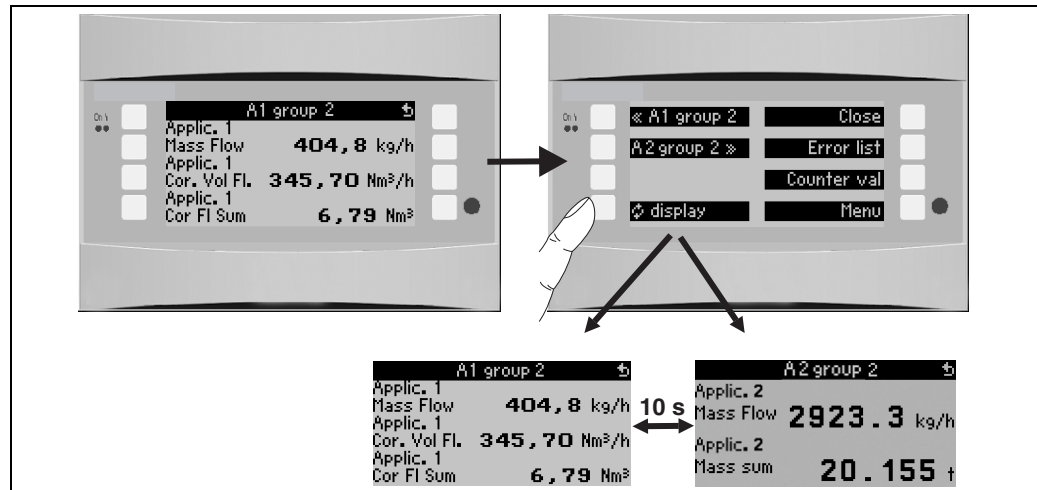

22: Automatic changing of different display groups

7 Maintenance

No special maintenance work is required for the device.

8 Accessories

When ordering accessories, please specify the serial number of the device!

Identifier	Order code
Temperature extension card	RMS621A-TA
Universal extension card	RMS621A-UA
Cable set RS232 with + 9-pin-SubD. plug for connection PC or Modem	RXU10-A1
Remote display for panel mounting 144 x 72 mm	RMS621A-AA
Field housing	52010132
Set, 10 x housing fix slide	RMA421X-HC
Profibus DP slave module	RMS621A-P1

9 Trouble-shooting

9.1 Troubleshooting instructions

Always begin troubleshooting using the following checklists if faults occur after commissioning or during operation. Different questions will guide you to the cause of the error and will suggest appropriate remedial action.

9.2 System error messages

Display	Cause	Remedy
Counter data error	<ul style="list-style-type: none"> ▪ Data acquisition error in the counter ▪ Data in the counter faulty 	<ul style="list-style-type: none"> ▪ Reset counter (→ Section 6.3.3 Main menu - Setup) ▪ Contact Service if fault cannot be eliminated.
Calibration data error slot "xx"	Calibration data set at the factory faulty/ cannot be read.	Remove card and insert it again (→ Section 3.2.1 Installing extension cards). Contact Service if error message appears again.
Card not recognized, slot "xx"	<ul style="list-style-type: none"> ▪ Plug-in card defect ▪ Plug-in card not inserted correctly 	Remove card and insert it again (→ Section 3.2.1 Installing extension cards). Contact Service if error message appears again.
Device software error: <ul style="list-style-type: none"> ▪ Error on reading the actual read address ▪ Error on reading the actual write read address ▪ Error on reading the actual oldest value ▪ adr "Address" ▪ DRV_INVALID_FUNCTION ▪ DRV_INVALID_CHANNEL ▪ DRV_INVALID_PARAMETER ▪ I2C bus error ▪ Checksum error <ul style="list-style-type: none"> – Pressure outside steam range! – No computation! – Temp. outside steam range! – Max. saturated steam temperature overshoot! 	Error in the program	Contact your local Service organization.
"Communication Problem"	No communication between the remote display/operating unit and the basic unit	Check wiring; the same baudrate and device address must be set in the basic device and the remote display/operating unit.
"Assertion: xx"	Error in the program	Contact your local Service organization.

9.3 Process error messages

Display	Cause	Remedy
Config error: <ul style="list-style-type: none"> ▪ Pressure ▪ Analog temperature ▪ Temperature RTD sensor ▪ Analog flow! ▪ PFM pulse flow! ▪ Applications! ▪ Limit values! ▪ Analog outputs! ▪ Pulse outputs! ▪ Pressure mean value ▪ Temperature mean value ▪ Flow mean value ▪ Flow differential pressure (DP) ▪ Flow splitting range ▪ Flow DP: no computation 	<ul style="list-style-type: none"> ▪ Incorrect or incomplete programming or loss of calibration data ▪ Contradictory terminal assignment ▪ Error in computation ▪ Pipe data or process variables outside permitted limits in accordance with ISO 5167 ▪ No computation takes place due to the incorrect configuration 	<ul style="list-style-type: none"> ▪ Check whether all necessary items have been defined with plausible values. (→ Section 6.3.3 Main menu - Setup) ▪ Check whether there is contradictory input assignment (e.g. flow 1 assigned to two different temperatures). (→ Section 6.3.3 Main menu - Setup) ▪ Check the pipe data ▪ Assign a DP input to an application
Wet steam alarm	The steam status calculated from the temperature and pressure is near (2 °C / 3.6 °F) the saturated steam curve	<ul style="list-style-type: none"> ▪ Check the application, devices and connected sensors. ▪ Change the limit function if you do not need the "WET STEAM ALARM". (→ Set point settings, Section 6.3.3)
Temp. outside steam range!	Measured temperature outside the permitted steam value range. (0 to 800 °C (32 to 1472 °F))	Check settings and connected sensors. (→ Input settings, Section 6.3.3)
Pressure outside steam range!	Measured pressure outside the permitted steam value range. (0 to 1000 bar (0 to 14504 psi))	Check settings and connected sensors. (→ Input settings, Section 6.3.3)
Temperature exceeds sat. steam range!	Measured or calculated temperature outside the saturated steam range (T>350 °C (662 °F))	<ul style="list-style-type: none"> ▪ Check settings and connected sensors. ▪ Set "Superheated" steam and carry out measurement task with three input variables (Q, P, T). (→ Application settings, Section 6.3.3)
Steam: condensate temperature	Phase transition! Measured or calculated temperature corresponds to condensate temperature of the saturated steam.	<ul style="list-style-type: none"> ▪ Check application, devices and connected sensors. ▪ Measures for process control: increase temperature, reduce pressure. ▪ Possibly imprecise temperature or pressure measurement; purely computed transition from steam to water which does not really occur. Compensate inaccuracies by setting an offset for temperature (approx. 1-3 °C (1.8-5.4 °F)).
Water: boiling temperature	Measured temperature corresponds to the boiling temperature of the water (water evaporates!)	<ul style="list-style-type: none"> ▪ Check application, devices and connected sensors. ▪ Measures for process control: reduce temperature, increase pressure.
Signal range error "channel name" "signal name"	Current output signal below 3.6 mA or above 21 mA.	<ul style="list-style-type: none"> ▪ Check whether the current output is scaled correctly. ▪ Change the start and/or end value of the scaling

Display	Cause	Remedy
Cable open circuit: "channel name" "signal name"	Input current outside the signal range (e.g. smaller than 3.6 mA or larger than 21 mA). <ul style="list-style-type: none"> Incorrect wiring Sensor not set to 4–20 mA range. Sensor malfunction Incorrectly configured end value for flow 	<ul style="list-style-type: none"> Check sensor configuration. Check function of the sensor. Check end value of the connected flow meter. Check wiring. Change limits for cable open circuit (alarm response)
Range error	Factory setting: $3.6 \text{ mA} < x < 3.8 \text{ mA}$ (with setting 4 to 20 mA) or $20.5 \text{ mA} < x < 21 \text{ mA}$ <ul style="list-style-type: none"> Incorrect wiring Sensor not set to 4–20 mA range. Sensor malfunction Incorrectly configured end value for flow transmitter 	<ul style="list-style-type: none"> Check sensor configuration. Check function of the sensor. Check measuring range/scaling of the connected flow meter. Check wiring. Change values for range violation (alarm response)
Cable open circuit: "channel name" "signal name"	Resistance too high at PT100 input, e.g. due to short-circuit or cable break <ul style="list-style-type: none"> Incorrect wiring PT100 sensor defect 	<ul style="list-style-type: none"> Check wiring. Check function of the PT100 sensor.
Temp. difference range undercut	Range of the set differential temperature overshoot	Check current temperature values and set minimum temperature differential.
Limit value over/under cut Limit value 'number' ok (blue) <ul style="list-style-type: none"> "Limit Value Identifier" < "Threshold Value" "Unit" "Limit Value Identifier" > "Threshold Value" "Unit" "Limit Value Identifier" > "Gradient" "Unit" "Limit Value Identifier" < "Gradient" "Unit" "User Defined Message" 	Limit value undershot or overshoot (→ Set point configuration, Section 6.3.3)	<ul style="list-style-type: none"> Acknowledge alarm if the function "Set Point/Lim. Display/Disp.+Ackn." was configured (→ Set point configuration, Section 6.3.3). Check application if necessary. Adjust set point if necessary.
<ul style="list-style-type: none"> Temp. difference range undercut (red) Temp. difference ok (blue) 	Range of set differential temperature overshoot.	Check current temperature values and set minimum temperature differential.
W-heat diff: error: neg. temp. diff.	The temperature assigned to the temperature sensor on the cold side is larger than the temperature on the warm side.	<ul style="list-style-type: none"> Check whether the temperature sensors are correctly wired. Adjust process temperatures.
W-heat diff: error flow direction	In bidirectional water-heat-diff. operation; If flow direction is configured as changing and the direction of flow does not suit the temperature values.	<ul style="list-style-type: none"> Change flow direction signal at the direction terminal. Check the wiring of the temperature sensors.
<ul style="list-style-type: none"> Pulse width must be between 0.04 and 1000 ms! Pulse width must be between 100 and 1000 ms! 	Active/passive pulse output: configured pulse width not within valid range.	Change the pulse width to the value range given.
Entry must lie between 1 and 15!	Incorrect number of points.	Correct value to a value in this value range.
Pulse buffer overflow	Too many pulses accumulated so the pulse counter overflows: pulses lost.	Increase pulse factor
Other messages/events (only appear in the event buffer)		
<ul style="list-style-type: none"> Low flow: undershot! 	Low flow cut off configured is undershot, i.e. flow valued at zero.	Reduce low flow cut off if necessary. (See Section 6.3.3)
<ul style="list-style-type: none"> Minimum temp. difference 	Minimum temperature differential configured is undershot, i.e. temperature differential valued at zero.	Reduce low flow cut off if necessary. (see Section 6.3.3)

9.4 Spare parts

When ordering spare parts, please specify the serial number of the device! Installation Instructions are provided with the spare part!

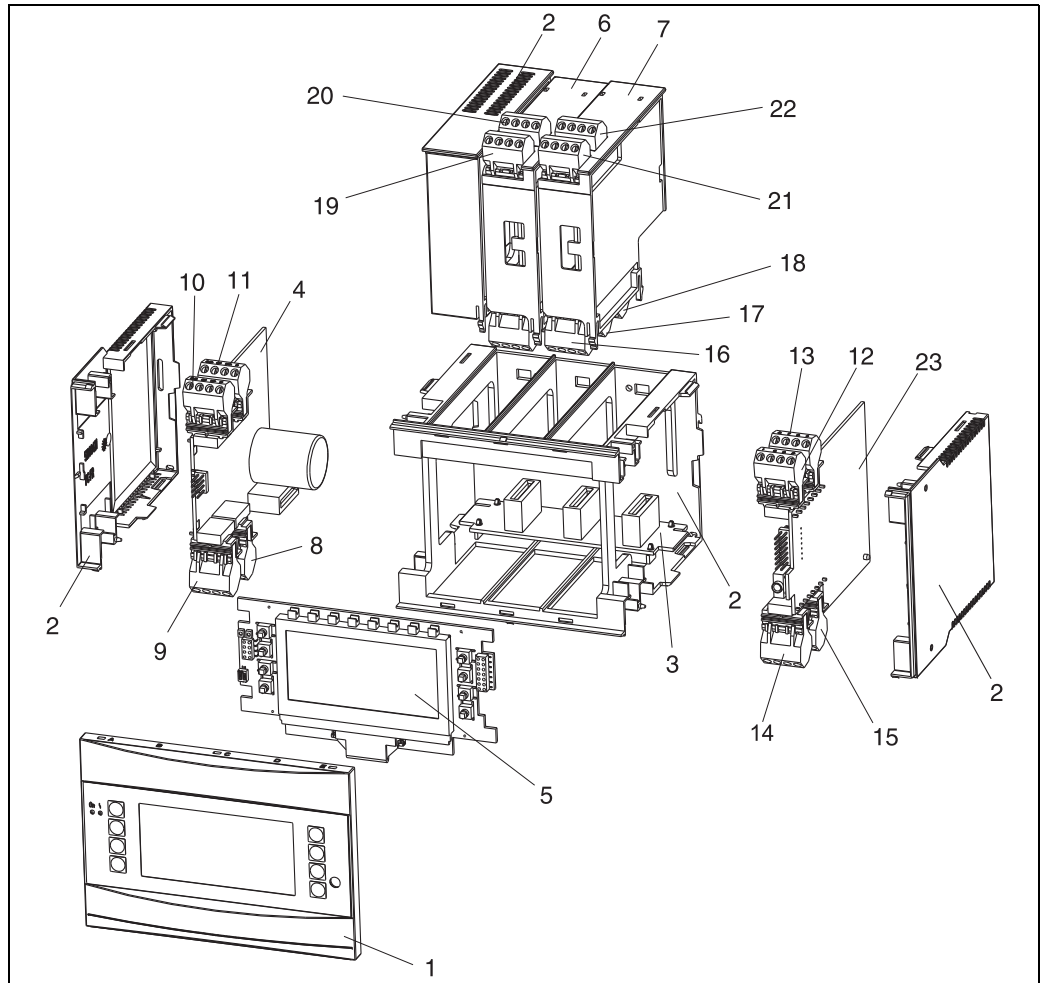

23: Energy Manager spare parts

Item no..	Order number	Spare part
1	RMS621X-HA	Front cover, version without display
1	RMS621X-HB	Front cover, version with display
2	RMS621X-HC	Complete housing without front incl. three blanking inserts and three PCB carriers
3	RMS621X-BA	Bus board
4	RMS621X-NA RMS621X-NB	Power unit 90 to 250 V AC Power unit 20 to 36 V DC // 20 to 28 V AC
5	RMS621X-DA RMS621X-DB RMS621X-DC RMS621X-DD RMS621X-DE RMS621X-DF RMS621X-DG RMS621X-DH	Display Front board for version without display Display + front cover Display + front cover, neutral Display for devices with software (SW) FCS00xA Front board, version without display, SW FCS00xA Display + front cover SW FCS00xA Display + front cover neutral SW FCS00xA
6	RMS621A-TA	Temperature extension card (Pt100/Pt500/Pt1000) complete, incl. terminals and securing frames

Item no..	Order number	Spare part
7	RMS621A-UA	Universal extension card (PFM/pulse/analog/transmitter power supply unit) complete, incl. terminals and securing frames
8	51000780	Mains terminal
9	51004062	Relay terminal/transmitter power supply unit
10	51004063	Analog terminal 1 (PFM/pulse/analog/transmitter power supply unit)
11	51004064	Analog terminal 2 (PFM/pulse/analog/transmitter power supply unit)
12	51004067	Temperature terminal 1 (Pt100/Pt500/Pt1000)
13	51004068	Temperature terminal 2 (Pt100/Pt500/Pt1000)
14	51004065	RS485 terminal
15	51004066	Output terminal (analog/pulse)
16	51004912	Relay terminal (extension card)
17	51004066	Extension card: output terminal (4 to 20 mA/pulse)
18	51004911	Extension card: open collector output terminal
19	51004907	Extension card: input 1 terminal (Pt100/Pt500/Pt1000)
20	51004908	Extension card: input 2 terminal (Pt100/Pt500/Pt1000)
21	51004910	Extension card: input 1 terminal (4 to 20 mA/PFM/pulse/transmitter power supply)
22	51004909	Extension card: input 2 terminal (4 to 20 mA/PFM/pulse/transmitter power supply)
23	RMS621C-	CPU for energy computer (configuration, see below)

Controller/CPU	
	Operating language A German B English E Spanish F French I Italian K Czech L American M Polish N Dutch Communication A Standard (RS232 and RS485) B 2nd RS485 for communication with remote panel display C 1 x RS232/1 x M-Bus + 1 x RS485 D 1 x RS232 + 1 x RS485 + 1 x ModBus Model A Standard K Standard North American Region
RMS621C-	← Order code

9.5 Return

For a return, e.g. in case of repair, the device must be sent in protective packaging. The original packaging offers the best protection. Repairs must only be carried out by your supplier's service organization. An overview of the service network can be found on the address page of these Operating Instructions.

When sending for repair, please enclose a note with a description of the error and the application.

9.6 Disposal

The device contains electronic components and must, therefore, be disposed of as electronic waste in the event of disposal. Please also observe local regulations governing disposal.

10 Technical data

10.0.1 Input

Measured variable

Current, PFM, pulse, temperature

Input signal

Flow, differential pressure, pressure, temperature

Measuring range

Measured variable	Input												
Current	<ul style="list-style-type: none"> ▪ 0/4 to 20 mA +10% overreach ▪ Max. input current 150 mA ▪ Input impedance < 10 Ω ▪ Accuracy 0.1% of full scale value ▪ Temperature drift 0.04% / 1 K (1.8 °F) ambient temperature change ▪ Signal attenuation low-pass filter 1st order, filter constants 0 to 99 s configurable ▪ Resolution 13 Bit ▪ Fault recognition 3.6 mA or 21 mA limit as per NAMUR NE 43* 												
PFM	<ul style="list-style-type: none"> ▪ Frequency range when using an input on the mainboard (Slot A): 0.25 Hz to 12.5 kHz ▪ Frequency range when using an input on an extension board (Slot B, C, D): 0.01 Hz to 12.5 kHz ▪ Signal level 2 to 7 mA low; 13 to 19 mA high ▪ Measurement method: period length/frequency measurement ▪ Accuracy 0.01% of measured value ▪ Temperature drift 0.1% / 10 K (18 °F) ambient temperature change 												
Pulse	<ul style="list-style-type: none"> ▪ Frequency range when using an input on the mainboard (Slot A): 0.25 Hz to 12.5 kHz ▪ Frequency range when using an input on an extension board (Slot B, C, D): 0.01 Hz to 12.5 kHz ▪ Signal level 2 to 7 mA low; 13 to 19 mA high with approx. 1.3 kΩ dropping resistor at max. 24 V voltage level 												
Temperature	Resistance thermometer (RTD) according to IEC 751 ($\alpha = 0.00385$):												
	<table border="1" style="width: 100%; border-collapse: collapse;"> <thead> <tr> <th style="width: 25%;">Designation</th> <th style="width: 50%;">Measuring range</th> <th style="width: 25%;">Accuracy (4-wire connection)</th> </tr> </thead> <tbody> <tr> <td>Pt100</td> <td>-200 to 800 °C (-328 to 1472 °F)</td> <td>0.03% of full-scale value</td> </tr> <tr> <td>Pt500</td> <td>-200 to 250 °C (-328 to 482 °F)</td> <td>0.1% of full-scale value</td> </tr> <tr> <td>Pt1000</td> <td>-200 to 250 °C (-328 to 482 °F)</td> <td>0.08% of full-scale value</td> </tr> </tbody> </table>	Designation	Measuring range	Accuracy (4-wire connection)	Pt100	-200 to 800 °C (-328 to 1472 °F)	0.03% of full-scale value	Pt500	-200 to 250 °C (-328 to 482 °F)	0.1% of full-scale value	Pt1000	-200 to 250 °C (-328 to 482 °F)	0.08% of full-scale value
	Designation	Measuring range	Accuracy (4-wire connection)										
	Pt100	-200 to 800 °C (-328 to 1472 °F)	0.03% of full-scale value										
	Pt500	-200 to 250 °C (-328 to 482 °F)	0.1% of full-scale value										
Pt1000	-200 to 250 °C (-328 to 482 °F)	0.08% of full-scale value											
<ul style="list-style-type: none"> ▪ Type of connection: 3- or 4-wire system ▪ Measuring current 500 μA ▪ Resolution 16 Bit ▪ Temperature drift 0.01% / 10 K (18 °F) ambient temperature change 													

Breakdown information to NAMUR NE43

Breakdown information is created when the measuring information is invalid or not present anymore and gives a complete listing of all errors occurring in the measuring system.

		Signal (mA)
Under ranging	Standard	3.8
Over ranging	Standard	20.5
Sensor break; sensor short circuit low	To NAMUR NE 43	≤ 3.6

Sensor break; sensor short circuit high	To NAMUR NE 43	≥ 21.0
---	----------------	--------

Number:

- 2 x 0/4 to 20 mA/PFM/Pulse
- 2 x Pt100/500/1000 (in basic device)

Maximum number:

- 10 (depends on number and kind of plug-in cards)

Galvanic isolation

The inputs are galvanically isolated between the individual expansion cards and the basic device (see also 'galvanic isolation' in section "Output").

Inputs in the same slot are not galvanically isolated.

10.0.2 Output

Output signal

Current, pulse, transmitter power supply and switching output

Galvanic isolation

Basic device:

Connection, terminals	Power supply (L/N)	Input 1/2 0/4 to 20 mA/PFM/pulse (10/11) or (110/11)	Input 1/2 TPS (82/81) or (83/81)	Input 1/2 temperature (1/5/6/2) or (3/7/8/4)	Output 1/2 0 to 20 mA/pulse (132/131) or (134/133)	Interface RS232/485 housing front or (102/101)	TPS external (92/91)
Power supply		2.3 kV	2.3 kV	2.3 kV	2.3 kV	2.3 kV	2.3 kV
Input 1/2 0/4 to 20 mA/PFM/pulse	2.3 kV			500 V	500 V	500 V	500 V
Input 1/2 TPS	2.3 kV			500 V	500 V	500 V	500 V
Input 1/2 temperature	2.3 kV	500 V	500 V		500 V	500 V	500 V
Output 1/2 0 to 20 mA/pulse	2.3 kV	500 V	500 V	500 V	500 V	500 V	500 V
Interface RS232/RS485	2.3 kV	500 V	500 V	500 V	500 V	500 V	500 V
TPS external	2.3 kV	500 V	500 V	500 V	500 V	500 V	



The specified insulation voltage is the AC testing voltage U_{eff} , which is applied between the connections.

Basis for assessment: IEC 61010-1, protection class II, overvoltage category II

Output variable current - pulse

Current

- 0/4 to 20 mA +10% overreach, invertible
- Max. loop current 22 mA (short-circuit current)
- Max. load 750 Ω at 20 mA

- Accuracy 0.1% of full-scale value
- Temperature drift: 0.1% / 10 K (18 °F) ambient temperature change
- Output ripple < 10 mV at 500 Ω for frequencies < 50 kHz
- Resolution 13 Bit
- Error signals 3.6 mA or 21 mA limit configurable as per NAMUR NE43 (see current inputs, page 4)

Pulse

Basic device:

- Frequency range to 12.5 kHz
- Voltage level 0 to 1 V low, 24 V high $\pm 15\%$
- Min. load 1 k Ω
- Max. pulse width 0.04 to 1000 ms

Expansion cards (digital passive, open collector):

- Frequency range to 12.5 kHz
- $I_{\max.} = 200$ mA
- $U_{\max.} = 24$ V $\pm 15\%$
- $U_{\text{low/max.}} = 1.3$ V at 200 mA
- Max. pulse width 0.04 to 1000 ms

Number

Number:

- 2 x 0/4 to 20 mA/Pulse (in basic device)

Maximum number:

- 8 x 0/4 to 20 mA/Pulse (depends on the number of plug-in cards)
- 6 x digital passive (depends on the number of plug-in cards)

Signal sources

All available multifunctional inputs (current, PFM or pulse inputs) and results can be freely allocated to the outputs.

Switching output

Function

Limit relay switches in these operating modes: minimum, maximum safety, gradient, alarm, saturated steam alarm, frequency/pulse, device error

Switch behavior

Binary, switches when the alarm value is reached (potential-free NO contact)

Relay switching capacity

Max. 250 V AC, 3 A / 30 V DC, 3 A



When using relays on expansion cards, a mixture of low voltage and extra-low voltage is not permitted.

Switching frequency

Max. 5 Hz

Threshold

Programmable (wet steam alarm is preset to 2 °C (3.6 °F) at the factory)

Hysteresis

0 to 99%

Sig. source

All available inputs and calculated variables can be allocated freely to the switching outputs.

Number

1 (in basic device)

Max. number: 7 (depends on number and kind of plug-in cards)

No of output states

100,000

Scan rate

500 ms

Transmitter power supply and external power supply

- Transmitter power supply (TPS), terminals 81/82 or 81/83 (optional universal expansion cards 181/182 or 181/183):
 - Supply voltage 24 V DC \pm 15%
 - Impedance $< 345 \Omega$
 - Maximum output current 22 mA (for $U_{out} > 16$ V)
 - Maximum current 30 mA, short-circuit proof
 - HART[®] communication is not accounted for
 - Number 2 (in basic device)
 - Maximum number: 5 (depends on number and kind of plug-in cards)
- Additional power supply (e.g. external display), Terminals 91/92:
 - Supply voltage 24 V DC \pm 5%
 - Maximum current 80 mA, short-circuit proof
 - Number 1
 - Source resistance $< 10 \Omega$

10.0.3 Power supply**Supply voltage**

- Low voltage power unit: 90 to 250 V AC 50/60 Hz
- Extra-low voltage power unit: 20 to 36 V DC or 20 to 28 V AC 50/60 Hz

Power consumption

8 to 26 VA (dependent on the expansion stage)

Connection data interface*RS232*

- Connection: 3.5 mm (0.14 in) jack plug on front panel
- Transmission protocol: ReadWin[®] 2000
- Transmission rate: max. 57,600 Baud

RS-485

- Connection: plug-in terminals 101/102 (in basic device)
- Transmission protocol: (serial: ReadWin® 2000; parallel: open standard)
- Transmission rate: max. 57,600 Baud

Optional: additional RS-485 interface

- Connection: plug-in terminals 103/104
- Transmission protocol and transmission rate same as standard RS-485 interface

10.0.4 Performance characteristics

Reference operating conditions

- Power supply 230 V AC ± 10%; 50 Hz ± 0.5 Hz
- Warm-up period > 30 min
- Ambient temperature 25 °C ± 5 K (77 °F ± 9 °F)
- Humidity 39% ± 10% relative humidity

Arithmetic unit

Medium	Variable	Range
Water	Temperature measuring range	0 to 374 °C (32 to 705.2 °F)
	Maximum Temperature differential range ΔT	0 to 374 °C (0 to 673.2 °F)
	Error limit for ΔT	3 to 20 K (5.4 to 36 °F) < 2.0% of measured value 20 to 250 K (36 to 450 °F) < 0.3% of measured value
	Arithmetic unit accuracy class	as per EN 1434-1 / OIML R75 (< 1.5%)
	Measurement and calculation interval	500 ms
Steam	Temperature measuring range	0 to 800 °C (32 to 1472 °F)
	Pressure measuring range	0 to 1000 bar (0 to 14,500 psi)
	Measurement and calculation interval	500 ms

10.0.5 Installation conditions

Installation instructions

Mounting location

In the cabinet on DIN rail IEC 60715 TH 35

NOTICE

Device overheating when using extension cards

- ▶ Aeration with an air flow of at least 0.5 m/s (1.6 fps) is required.

Orientation

no restrictions

10.0.6 Environment

Ambient temperature range

-20 to 60 °C (-4 to 140 °F)

Storage temperature

-30 to 70 °C (-22 to 158 °F)

Climate class

as per IEC 60 654-1 Class B2 / EN 1434 Class 'C'

Electr. safety

As per IEC 61010-1: Environment < 2000 m (6560 ft) above sea level

Degree of protection

- Basic device: NEMA 1 (IP 20)
- External display: NEMA 4X (IP 65)

Electromagnetic compatibility*Interference emission*

IEC 61326 (EN 61326 Class A)

Interference immunity

- Power failure: 20 ms, no influence
- Starting current limitation: $I_{max}/I_n \leq 50\%$ ($T50\% \leq 50$ ms)
- Electromagnetic fields: 10 V/m as per IEC 61000-4-3
- Conducted HF: 0.15 to 80 MHz, 10 V as per IEC 61000-4-3
- Electrostatic discharge: 6 kV contact, indirect as per IEC 61000-4-2
- Burst (power supply): 2 kV as per IEC 61000-4-4
- Burst (signal): 1 kV/2 kV as per IEC 61000-4-4
- Surge (AC power supply): 1 kV/2 kV as per IEC 61000-4-5
- Surge (DC power supply): 1 kV/2 kV as per IEC 61000-4-5
- Surge (signal): 500 V/1 kV as per IEC 61000-4-5

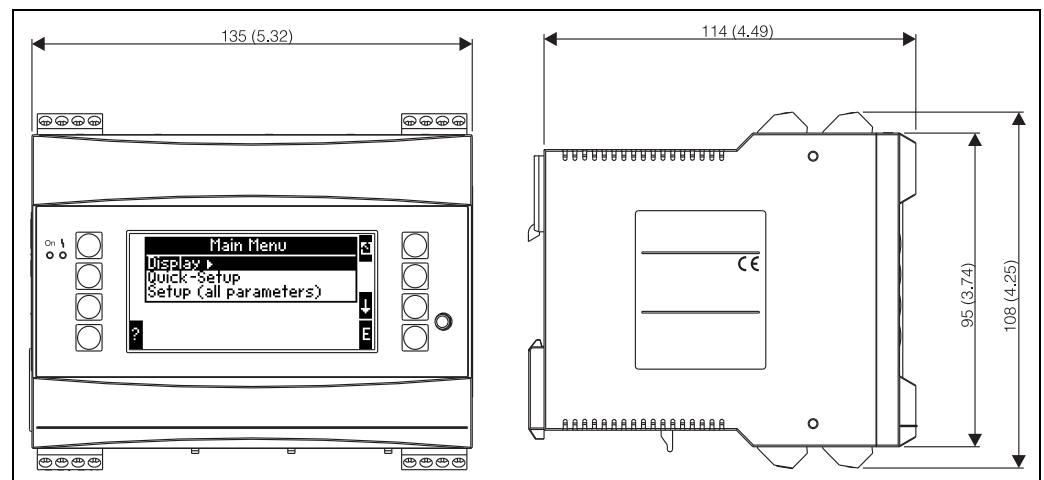
10.0.7 Mechanical construction**Design, dimensions**

24: Housing for top-hat rail to IEC 60715; dimensions in mm (inch)

Weight

- Basic device: 500 g (1.1 lb) in maximum configuration with expansion cards

- Remote control unit: 300 g (0.7 lb)

Material

Housing: polycarbonate plastic, UL 94V0

Terminals

Coded, pluggable screw terminals; Clamping area 1.5 mm² (16 AWG) solid, 1.0 mm² (maximum 18 AWG) flexible with wire end ferrule (applies to all connections).

10.0.8 Human interface

Display elements

- Display (optional):
160 x 80 Dot-matrix LCD with blue background lighting
Color changes to red in the event of an error (adjustable)
- LED status display:
Operation: 1 x green (2 mm; 0.079 in)
Fault message: 1 x red (2 mm; 0.079 in)
- External display and operating unit (optional or as accessory):
A display and operating unit can also be connected to the energy manager in the panel mounted housing, dimensions (WxHxT) 144 mm (5.7 in) x 72 mm (2.84 in) x 43 mm (1.7 in). The connection to the integrated RS485 interface is made using the connecting cable, l = 3 m (10 ft), which is included in the accessories set. Parallel operation of the external display unit with a device-internal display in the RMS621 is possible.

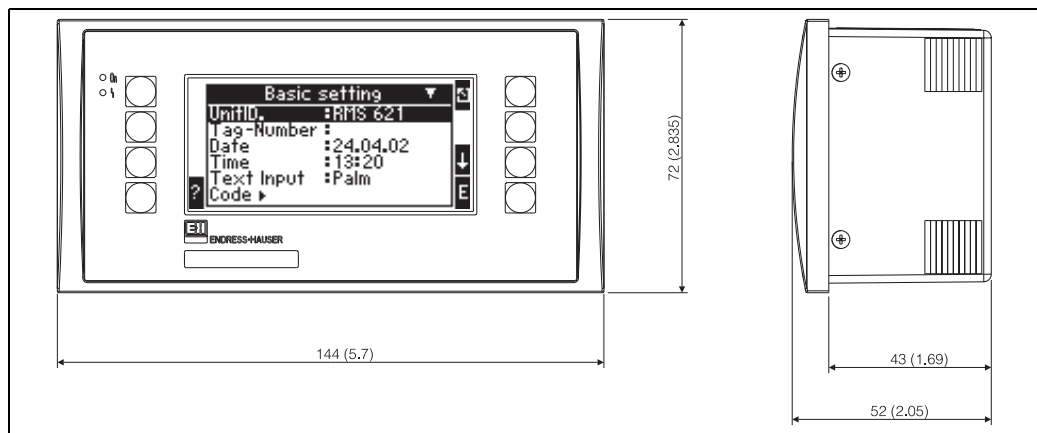

25: External display and operating unit for panel mounting (optional or available as accessory); dimensions in mm (inches)

Operating elements

Eight front-panel soft keys interact with the display (function of the keys is shown in the display).

Remote operation

RS232 interface (3.5 mm (0.14 in) jack plug on front panel): configuration via PC with ReadWin[®] 2000 PC operating software.

Real time clock

- Deviation: 2.6 min per year
- Power reserve: 14 days

Mathematical functions

Flow, differential pressure calculation: EN ISO 5167

Continuous calculation of mass, standard volume, density, enthalpy, quantity of heat using stored algorithms and tables.

Water / steam calculation according to IAWPS-IF97

10.0.9 Certificates and approvals

CE mark

The measuring system meets the legal requirements of the EC Directives. Endress+Hauser confirms successful testing of the device by affixing to it the CE mark.

UL instrument safety

Instrument safety as per UL 3111-1 ,

CSA GP

CSA General Purpose

Other standards and guidelines

- EN 60529:
Degrees of protection through housing (IP code)
- EN 61010:
Protection measures for electrical equipment for measurement, control, regulation and laboratory procedures
- EN 61326 (IEC 1326):
Electromagnetic compatibility (EMC requirements)
- NAMUR NE21, NE43
Association for Standards for Control and Regulation in the Chemical Industry
- IAWPS-IF 97
Internationally applicable and recognized calculation standard (since 1997) for steam and water. Issued by the International Association for the Properties of Water and Steam (IAPWS).
- OIML R75
International construction regulation and test specification for water Energy Managers of the Organisation Internationale de Métrologie Légale.
- EN 1434 1, 2, 5 and 6
- EN ISO 5167
Flow measurement of fluids with throttle devices

10.0.10 Documentation

- 'System components' brochure (FA016K/09/en)
- Technical Information for 'Vortex Flow Measuring System, PROline Prowirl 72' (TI062D/06/en)
- Technical Information for 'Energy Manager RMS621' (TI092R/09/en)

11 Appendix

11.1 Definition of important system units

Volume	
bbl	1 barrel, definition see 'Setup → Application'
gal	1 US gallon, corresponds to 3.7854 liters
igal	Imperial gallon, corresponds to 4.5609 liters
l	1 liter = 1 dm ³
hl	1 hectoliter = 100 liters
m ³	corresponds to 1000 liters
ft ³	corresponds to 28.37 liters
Temperature	
	Conversion: <ul style="list-style-type: none"> ▪ 0 °C = 273.15 K ▪ °C = (°F - 32)/1.8
Pressure	
	Conversion: <ul style="list-style-type: none"> 1 bar = 100 kPa = 100000 Pa = 0.001 mbar = 14.504 psi
Mass	
ton (US)	1 US ton, corresponds to 2000 lbs (= 907.2 kg)
ton (long)	1 long ton, corresponds to 2240 lbs (= 1016 kg)
Performance (heat flow)	
ton	1 ton (refrigeration) corresponds to 200 Btu/m
Btu/s	1 Btu/s corresponds to 1.055 kW
Energy (heat quantity)	
therm	1 therm, corresponds to 100000 Btu
tonh	1 tonh, corresponds to 1200 Btu
Btu	1 Btu corresponds to 1.055 kJ
kWh	1 kWh corresponds to 3600 kJ which corresponds to 3412.14 Btu

11.2 Flow measurement configuration

The Energy Manager processes output signals from a wide range of common flow transmitters.

- Volumetric:

Flow transmitter which outputs a signal in proportion to the operating volume (e.g. vortex, EFM, turbine).

- Mass

Flow transmitter which outputs a signal in proportion to the mass (e.g. Coriolis).



A mass input always has to be assigned to an application. If no temperature measurement and/or pressure measurement is performed, please configure a temperature and pressure input with a "default value" for process pressure and temperature and assign these inputs to an application together with the mass input.

When a mass flow transmitter is connected, the system automatically calculates back to the operating volume. Please note that the display values for the flow and the flow totalizer are always shown on the display with the volume unit m³. The mass flow and the mass flow totalizer, as well as the choice of the related units, are constantly assigned to the application! The following options must be selected to display a mass value on the display: Display/Group/Value Type: Process Values/Value: Mass Flow 1 or Value Type: Counter, Value: Mass Sum 1. If the mass flow is only to be displayed, totalized or output, the user-defined inputs can be used in the Energy Manager as an alternative.

- **Differential pressure:**

Flow transmitter (DPT) which outputs a signal in proportion to the differential pressure.

- **Process value:**

In addition to the measured flow rates, the mass flow calculated in an application can also be selected as the input variable (for example, to calculate the energy in a second application on the basis of this mass input). A threshold value, as of which a default value is used, can be defined for this mass input. When the threshold value is exceeded, the computed flows are totaled on a disturbance quantity counter. This is advantageous if invoicing is to be based on performance peaks.

11.2.1 Flow calculation based on the differential pressure method

The device has 2 ways of measuring differential pressure:

- Traditional differential pressure method
- Improved differential pressure method

Traditional differential pressure method	Improved differential pressure method
Only accurate in design parameter (pressure, temperature, flow)	Accurate in every operating point thanks to fully compensated flow calculation
Signal of the DP transmitter is square root, i.e. scaled to the operating volume or mass	Curve of the DP transmitter signal is linear, i.e. scaled to the differential pressure

Traditional differential pressure method:

All the coefficients of the flow calculation equation are calculated once in the design parameter and are combined to form a constant.

$$Q_m = C \cdot \underbrace{\sqrt{\frac{1}{1-\beta^4}} \cdot \varepsilon \cdot d^2 \cdot \frac{\pi}{4}}_{k} \cdot \sqrt{2 \cdot \Delta p \cdot \rho}$$

$$Q_m = k \cdot \sqrt{2 \cdot \Delta p \cdot \rho}$$

Improved differential pressure method:

In contrast to the traditional method, the coefficients of the flow equation (flow coefficient, preacceleration factor, expansion number, density, etc.) are constantly recomputed as per ISO 5167. This has the advantage that the flow is determined exactly even under fluctuating process conditions, far beyond the design parameter (temperature and pressure in sizing parameter), thereby ensuring greater accuracy in flow measurement.

For this, the device just needs the following data:

- Internal diameter

- Diameter ratio β (K-factor for Pitot tubes)

$$Q_m = f \cdot c \cdot \sqrt{\frac{1}{1-\beta^4}} \cdot \varepsilon \cdot d^2 \frac{\pi}{4} \cdot \sqrt{2 \cdot \Delta p \cdot \rho}$$

f = correction factor (correction of measurement, e.g. to take pipe roughness into account)

Temperature effect on internal diameter and diameter ratio β

Please note: the pipe data often refer to the manufacturing temperature (approx. 20 C) or process temperature. The data are automatically converted to the operating temperature. For this purpose, just the expansion coefficient of the pipe material has to be entered. (Differential Pressure1 → Correction: Yes → Expansion Coefficient: ...)

Temperature compensation can be omitted in the event of minor deviation (± 50 C) from the calibration temperature.

Pitot tubes

When using Pitot tubes, a correction factor has to be entered instead of the diameter ratio. This factor (resistance coefficient) is specified by the probe manufacturer (K-factor). It is absolutely imperative that this correction factor be entered! (See following example).

The flow is calculated as follows:

$$Q_m = f \cdot d^2 \cdot \frac{\pi}{4} \cdot \sqrt{2 \cdot \Delta p \cdot \rho}$$

f = correction factor (K-factor or value from the correction table)

d = internal diameter

Δp = differential pressure

ρ = density in operating status

Example:

Flow measurement in a steam line with a Pitot tube

- Internal diameter: 350 mm
- k-factor (correction factor for the resistance coefficient of the probe): 0.634
- Working range Δp : 0 - 51, 0 mbar (Q: 0-15000 m³/h)

Notes on the configuration:

- Flow → Flow 1; Diff.pressure → Pitot; Signal → 4...20 mA; → Range start/range end (mbar);
Pipe data → Inner dia. 350 mm; → Factor 0.634.

Flow measurement with V cone transmitter

The following data are needed when using V-cone flow transmitters:

- Internal diameter
- Diameter ratio β
- Flow coefficient c

The flow coefficient can be entered as a fixed value or in the form of a table depending on the Reynolds number. Please refer to the data sheet of the manufacturer for data regarding this. The flow is calculated from the input signals differential pressure, temperature and static pressure as per ISO 5167 (see Improved method). The temperature effect on the V-cone (Fa value) is calculated automatically when the thermal expansion coefficient of the V-cone is entered (see "Temperature effect on internal diameter and diameter ratio β " above). If the data available are insufficient, scale the DP transmitter to volume and use the flow input in Energy Manager.

General notes on differential pressure measurement

If all the data on the differential pressure measuring point are available (internal pipe diameter, β or k-factor), we recommend you use the improved method (fully compensated flow calculation).

If the data required are not available, the output signal of the differential pressure transmitter is output scaled to volume or mass (see the following table). Please note that a signal scaled to mass can no longer be compensated. For this reason, scale the DP transmitter to operating volume if possible (mass: density in design parameter = operating volume). The mass flow is then calculated in the device based on the density in the operating status, depending on the temperature and pressure. This is partially compensated flow calculation, since the square root density is in the design parameter when measuring the operating volume.

An example of a measurement setup can be found in the Appendix 'Applications: steam mass/quantity of heat'.

How should the Energy Manager and the sensor be configured?

	Sensor type	Unit
1. Traditional method	No data available on the pipe diameter and diameter ratio β (k-factor for Pitot tube).	
a) (Default)	Square root curve e.g. 0...1000 m ³ (t)	Flow input (operating volume or mass) Linear curve e.g. 0...1000 m ³ (t)
b)	Linear curve e.g. 0...2500 mbar	Flow input (operating volume or mass) Curve square root, e.g. 0...1000 m ³ (t)
2. Improved method	Pipe diameter and diameter ratio β (k-factor for Pitot tube) known.	
a) (Default)	Linear curve e.g. 0...2500 mbar	Special flow (DP) e.g. orifice plate Linear curve e.g. 0...2500 mbar
b)	Square root curve e.g. 0...1000 m ³ (t)	Special flow (DP) e.g. orifice plate Curve square law 0...2500 mbar

Accuracy of air flow measurement with an orifice plate depending on the measurement method

Example:

- Orifice corner tap DPO 50: internal diameter 200 mm; $\beta = 0.7$
 - Flow operational range: 14.5 to 6785 m³/h (0 to 813.0 mbar)
 - Sizing parameter: 10 bar (145 psi); 200 °C (392 °F); 4.85 kg/m³; 4000 m³/h
 - Process temperature: 190 °C (374 °F)
 - Process pressure (true value): 11 bar (159.5 psi)
 - Differential pressure: 270 mbar (3.92 psi)
- a. Result when measuring based on the traditional differential pressure method:
Operating volume: 4000 m³/h Mass flow: 19.41 t/h (density: 4.85 kg/m³)
- b. Result with improved, fully compensated differential pressure method (real flow):
Operating volume: 3750 m³/h Mass flow: 20.75 Nm³/h (density: 5.53 kg/m³)

The measured error for traditional flow measurement is approx. 6.5%.

Splitting Range (measuring range extension)

The measuring range of a differential pressure transmitter is between 1:3 and 1:7. This function gives you the opportunity of extending the measuring range of the flow measurement to 1:20 and more by using up to three differential pressure transmitters per flow measuring point.

Notes on the configuration:

1. Select Flow/Splitting Range 1 (2, 3)

2. Define the signal and select the differential pressure transmitter (applies to all differential pressure transmitters!)
3. Select the terminals for the transmitters and define the measuring ranges.
Range 1: transmitter with the smallest measuring range
Range 2: transmitter with the next biggest measuring range etc.
4. Specify curve, units, format, sums, pipe data etc. (applies to all transmitters)



In the Splitting Range mode, it is compulsory to use differential pressure transmitters which output currents > 20 mA (< 4.0 mA) when the measuring range is overshoot. The system automatically switches between the measuring ranges (switchover points 20.1 and 19.5 mA).

If the input current of measuring range 1 reaches 20.1 mA, the system switches to measuring range 2. If the current value in range 2 drops below 19.5 mA, measuring range 1 is active again.

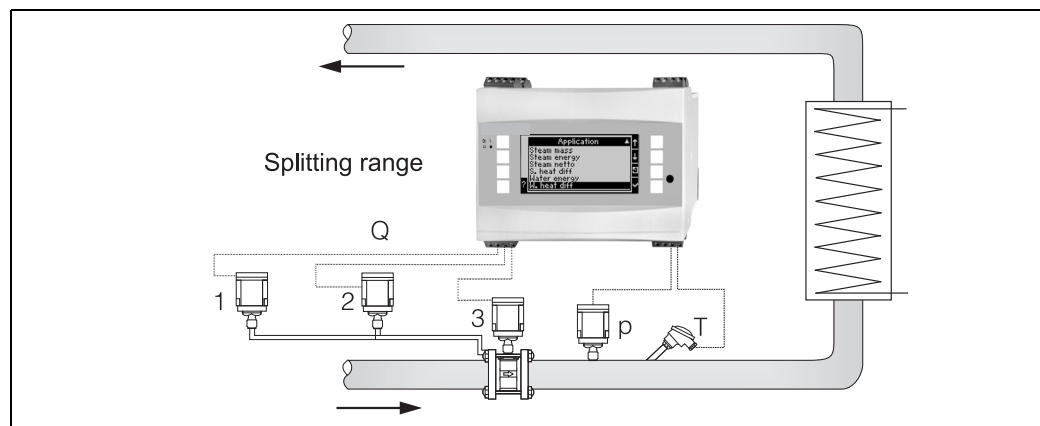

26: Splitting Range operation

Mean value computation

Mean value computation gives you the opportunity of measuring an input variable using several sensors at different points and then getting the mean value from them. This function helps if several measuring points are required in a system in order to determine the measured variable with sufficient accuracy. Example: use of several Pitot tubes to measure flow in pipes with insufficient inlet runs or a large cross section.

Mean value computation is available for the input variables pressure, temperature and special flow meters (differential pressure).

Correction tables

Flow transmitters return an output signal in proportion to the flow. The relationship between the output signal and the flow can be described in the curve. The flow cannot always be determined exactly by a curve in the entire measuring range of a transmitter, i.e. the flow transmitter shows a deviation from the ideal curve pattern. This deviation can be compensated for with the correction table.

The correction is different, depending on the type of flow transmitter:

- Analog signal (volumetric, mass)
Table with up to 15 current/flow value pairs
- Pulse signal (volumetric, mass)
Table with up to 15 value pairs (frequency/k-factor or frequency/pulse value, depending on the type of signal)
- Differential pressure square root/not square root
Table with up to 10 value pairs (flow/factor f)



The points are automatically sorted by the device, i.e. you can define the points in any order.

Make sure that the operating status is within the table limits since values outside the table range are determined by extrapolation. This can result in greater inaccuracies.

11.3 Application sheets

11.3.1 Water/quantity of heat

Applications

Calculation of the quantity of heat in a flow of water. For example, determining the residual heat in the return line of a heat exchanger, etc.

Measured variables

Measuring the operating volume flow and temperature in a water pipe

Display/formula for calculation

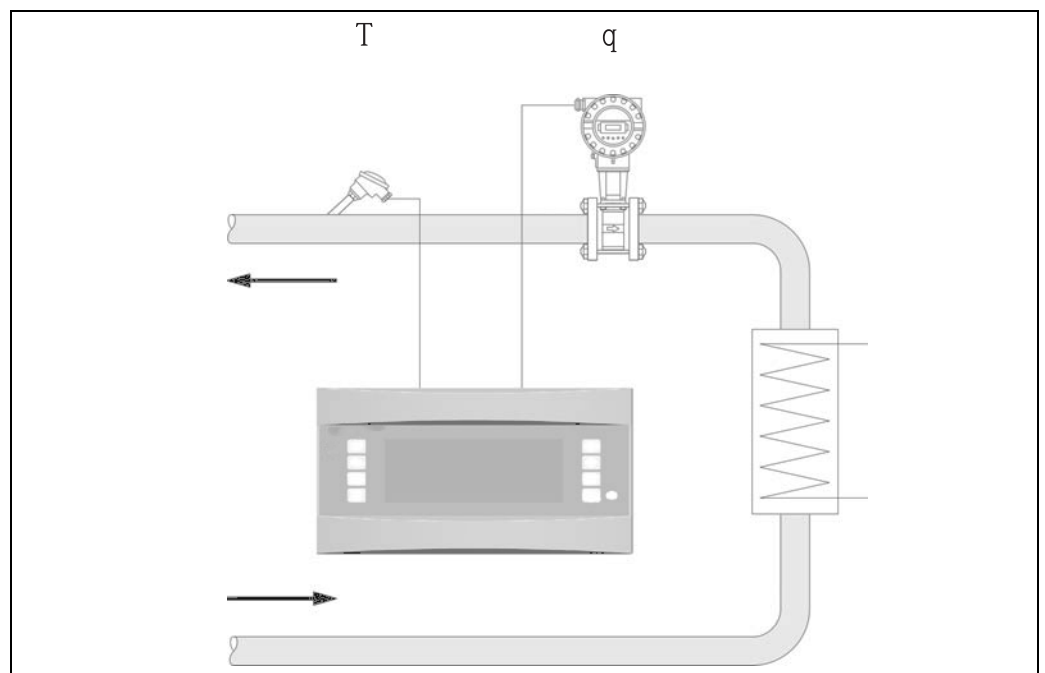

G09-RMS621xx-15-10-xx-xx-005

27: Water/quantity of heat application

$$E = q \cdot \rho(T, p) \cdot h(T)$$

E: Quantity of heat
q: Volumetric
ρ: Density

T: Operating temperature
p: Average operating pressure
h: Specific enthalpy of water (in relation to 0 °C (32 °F))

Input param.

- Flow (q)
- Temperature (T)



Another input variable is the operating pressure in the water pipe which is needed to accurately calculate the process variables and measuring range limits. The average operating pressure (p) is an input value (no input signal).

Optionally, a pressure transmitter can be connected to display the pressure in the pipe. This pressure measurement does not have a direct effect on the calculation, however.

Calculated variables

Mass flow, heat flow, specific enthalpy (unit for the heat contents of water, in relation to 0 °C (32 °F)), density

Calculation standard: IAPWS-IF97

Output variables/display at device

- Heat flow (performance), mass flow, flow (operating volume), temperature, specific enthalpy, density
- Totalizer: heat (energy), mass, volume, heat disturbance quantity, mass disturbance quantity.

Outputs

All the output variables can be output via analog and pulse outputs or the interfaces (e.g. bus). In addition, relay outputs for limit value violation are also available. The number of outputs depends on the version of the device.

Other functions

- Monitoring the state of aggregation. "Phase Transition" alarm when boiling temperature is reached
- Configurable alarm response, i.e. the function of the counters and outputs in the event of an error (e.g. cable open circuit, phase transition) can be individually defined.

11.3.2 Water/heat difference (heating/cooling/bidirectional)

Applications

Calculation of the quantity of heat which is given off, or taken in, by a flow of water in a heat exchanger. Typical application for measuring energy in heating and cooling circuits. Similarly, bidirectional flows of energy can be measured depending on the temperature differential or flow direction (example: charging/discharging heat accumulators, geothermal reservoirs, etc.).

Measured variables

Measuring the operating volume flow (where necessary, also the flow direction) and the water temperature directly upstream and downstream from a heat exchanger (in feed or return pipe).

Display/formula for calculation

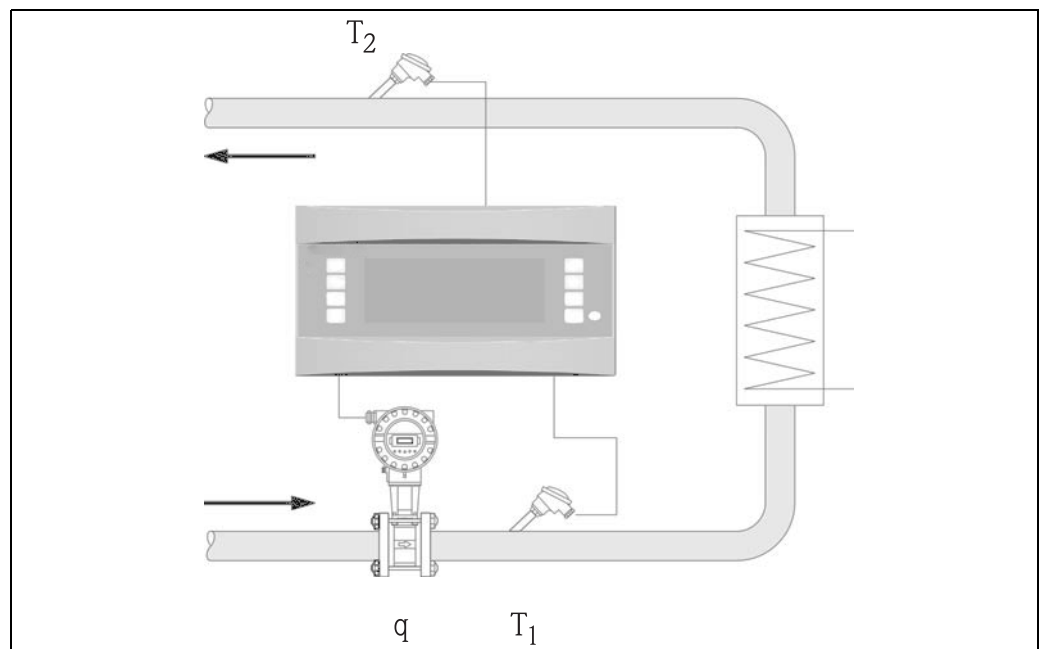

28: Application water/heat difference

G09-RMS621xx-15-10-xx-xx-006

Heat emission (heating)

$$E = q \cdot \rho(T_1) \cdot [h(T_1) - h(T_2)]$$

E: Quantity of heat
q: Volumetric
 ρ : Density
 T_1 : Temperature in feed line

Heat absorption (cooling)

$$E = q \cdot \rho(T_1) \cdot [h(T_2) - h(T_1)]$$

T_2 : Temperature in return line
p: Average operating pressure
 $h(T_1)$: Specific enthalpy of water at temperature 1
 $h(T_2)$: Specific enthalpy of water at temperature 2

Input param.

- Temperature (T_1) in feed line
- Temperature (T_2) in return line
- Flow (q), where necessary with direction signal in the feed or return line



Another input variable is the operating pressure in the water pipe which is needed to accurately calculate the process variables and measuring range limits. The average operating pressure (p) is a default value. (No input signal).

The mounting location of the flow transmitter (warm/cold side) can be defined by the user!

It is recommended to install the flow transmitter at the point in the heat circuit where the temperature is closer to the ambient temperature (room temperature).

In the case of bidirectional measurement with an alternating flow direction, the direction signal of the flow transmitter is feed in via an analog input. (See Section 4 "Wiring")

Calculated variables

Mass flow, heat flow, heat difference (difference in enthalpy), temperature differential, density

In Bidirectional operation, "positive" and "negative" energy flows are recorded on separate counters.

(Calculation standard: IAPWS-IF97)



In the Bidirectional operating mode, the direction of the flow of energy is determined using the sign for differential temperature measurement or on the basis of the flow signal.

Scaling the flow input, e.g. -100 up to $+100$ m³/h is another possibility for bidirectional measurement. The energy flows are then balanced on a counter. (Select the Heating or Cooling operating mode here.)

Output variables/display at device

- Heat flow (performance), mass flow, operating volume flow, temperature 1, temperature 2, temperature differential, difference in enthalpy, density.
- Totalizer: heat (energy), mass, volume, heat disturbance quantity, mass disturbance quantity. In the bidirectional mode, additional counters for recording "negative" mass and energy flow.

Outputs

All the output variables can be output via analog and pulse outputs or the interfaces (e.g. bus). In addition, relay outputs for limit value violation are also available. The number of outputs depends on the version of the device.

Other functions

- Monitoring the state of aggregation and the temperature differential
 - Phase transition alarm with boiling temperature
 - "Cut Off" function and alarm via relay when the minimum temperature differential is undershot
- Configurable alarm response, i.e. the function of the counters and outputs in the event of an error (e.g. cable open circuit, phase transition) can be individually defined.

For a programming example, see the "Brief Operating Instructions" section.

11.3.3 Steam mass/quantity of heat

Applications

Calculation of the mass flow and the quantity of heat it contains at the output of a steam generator or for individual consumers.

Measured variables

Measuring the operating volume flow, temperature and pressure in a steam pipe.

Display/formula for calculation

(Example: Steam flow measurement based on the differential pressure method (e.g. orifice plate))

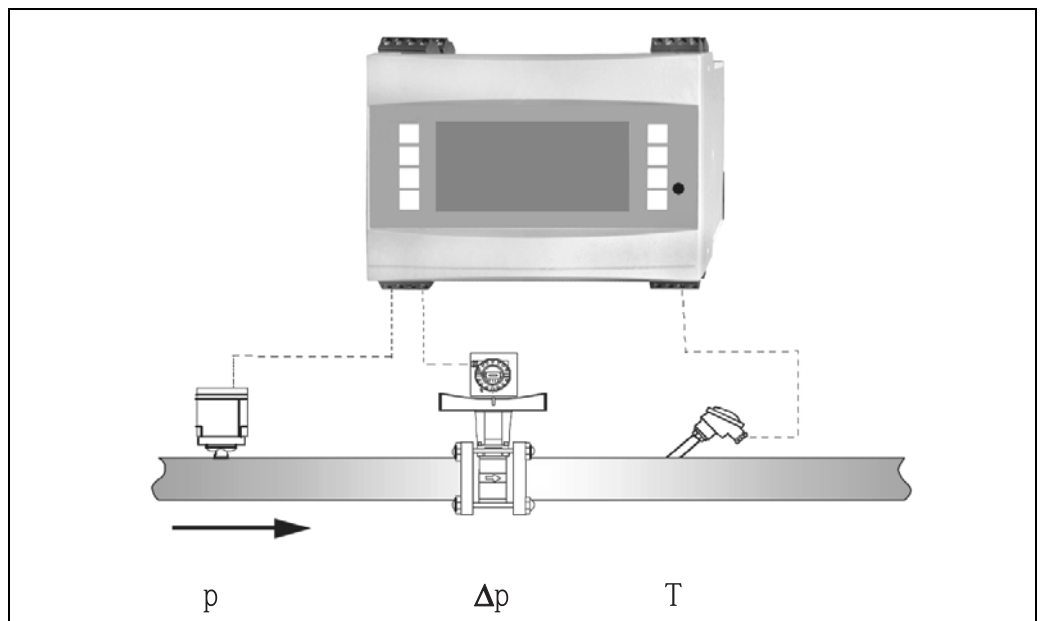

29: Application steam mass/quantity of heat

G09-RMS621xx-15-10-xx-xx-007

$$E = q(\Delta p, p, T) \cdot \rho(T, p) \cdot h_D(p, T)$$

E: Quantity of heat
 q: Volumetric
 ρ: Density

T: Temperature
 p: Pressure (steam)
 h_D: Specific enthalpy of steam

Input param.

- Superheated steam: flow (q), pressure (p), temperature (T)
- Saturated steam: flow (q), pressure (p) or temperature (T)

Calculated variables

Mass flow heat flow, density, specific enthalpy (heat contents of steam, in relation to water at 0 °C (32 °F))

(Calculation standard: IAPWS-IF97).



To achieve greater accuracy and plant safety, the steam status should also be determined using three input variables for saturated steam applications as this is the only way to determine and monitor the steam status accurately (e.g. wet steam alarm function, see outputs). For this reason, please select "Superheated Steam" even for saturated steam measurement. If "Saturated Steam" is selected - i.e. one less input variable - the missing input variable is determined using the saturated steam curve stored.

Output variables/display at device

- Heat flow (performance), mass flow, operating volume flow, temperature, pressure, density, specific enthalpy.
- Totalizer: quantity of heat (energy), mass, volume, heat disturbance quantity, mass disturbance quantity.

Outputs

- All the output variables can be output via analog and pulse outputs or the interfaces (e.g. bus). In addition, relay outputs for limit value violation are also available. The number of outputs depends on the version of the device.
- If a relay is configured for "Wet Steam Alarm" it switches as soon as superheated steam is within 2 °C (3.6 °F) of the saturated steam curve (condensate temperature). At the same time, an alarm message appears on the display.

Other functions

- Two-stage monitoring of steam status:
 - Wet steam alarm: 2 °C (3.6 °F) above saturated steam or condensate temperature.
 - Phase transition alarm: alarm at saturated steam or condensate temperature.
- Configurable alarm response, i.e. the function of the counters and outputs in the event of an error (e.g. cable open circuit, phase transition) can be individually defined.
- Fully compensated iterative flow calculation following the differential pressure method in accordance with ISO 5167, resulting in highly accurate calculation even outside the design parameters.



Fully compensated DP measurement is available for all applications. An example is mentioned here and illustrated in the measuring system setup. For programming examples, see "Brief Operating Instructions" and Section 6.4.1.

11.3.4 Steam/heat difference

(incl. net steam)

Applications

Calculation of the steam mass flow and quantity of heat given off when the steam condensates in a heat exchanger.

Alternatively also the calculation of the quantity of heat (energy) used for steam generation as well as the calculation of the steam mass flow and the quantity of heat it contains. The heat energy contained in the feed water is also taken into consideration here.

Measured variables

Measurement of the pressure and temperatures directly upstream and downstream from a heat exchanger (or steam generator). The flow can either be measured in the steam pipe or the water pipe (condensate or feed water).

Optionally, you can refrain from measuring the temperature in the condensate (known as net steam measurement).

Display/formula for calculation

(Example: steam heat differential measurement, "Heating" operating mode)

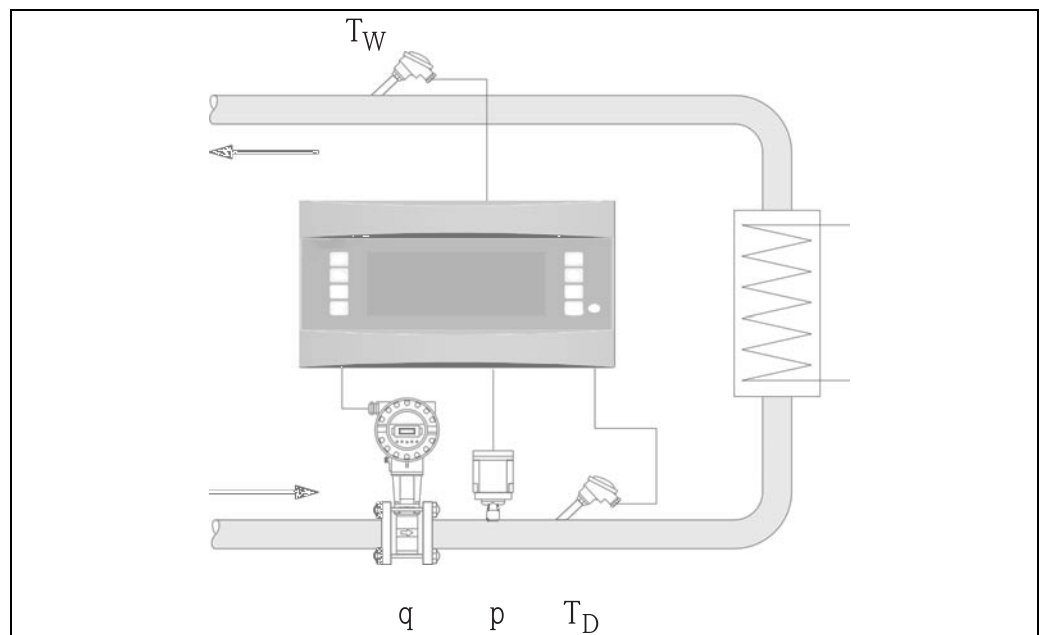

30: Application steam/heat difference

G09-RMS621xxx-15-10-xxx-xx-008

$$E = q \cdot \rho(p, T_D) \cdot [h_D(p, T_D) - h_W(T_W)]$$

E: Quantity of heat

q: Volumetric

ρ : Density

T_D : Temperature of steam

T_W : Temperature of water (condensate)

p: Pressure (steam)

h_D : Specific enthalpy of steam

h_W : Specific enthalpy of water

Input param.

- Steam line:
 - Superheated steam: pressure (p), temperature (T_D)
- Condensate pipe:
 - Temperature (T_W)
- Flow measurement (q) in the steam or condensate pipe



The mounting location of the sensor for measuring the flow is determined by the operating mode. The "Heating" operating mode means that the flow transmitter is installed on the steam side; "Steam Generation" is selected if the flow is measured in the feed water (or in the condensate pipe).

The application "Net Steam", i.e. refraining from using temperature measurement in the condensate pipe, is only recommended if the condensate is only marginally cooled below the boiling temperature.

The application "Net Steam", i.e. refraining from using temperature measurement in the condensate pipe, is only recommended if the condensate is only marginally cooled below the boiling temperature.

Calculated variables

Mass flow, heat difference (heat contents of steam minus heat contents of condensate), heat flow, density.

(Calculation standard: IAPWS-IF97).



To achieve greater accuracy and plant safety, the steam status should also be determined using three input variables for saturated steam applications as this is the only way to determine and monitor the steam status accurately (e.g. wet steam alarm function, see outputs). For this purpose, please select "Superheated Steam" even for saturated steam measurement.

If "Saturated Steam" is selected - i.e. one less input variable - the missing input variable is determined using the saturated steam curve stored.

A precondition for measuring the steam heat differential is that the system is a closed system (mass flow of condensate = mass flow of steam). If this is not the case, the flow in the condensate pipe and steam pipe should be measured separately (2 applications). The flows of energy can then be balance manually (or externally).

In the case of net steam applications, the energy contents of the condensate is calculated based on the steam pressure measured.

Output variables/display at device

- Heat flow (performance), mass flow, operating volume flow, temperature, pressure, density, enthalpy differential.
- Totalizer: heat (energy), mass, volume, heat disturbance quantity, mass disturbance quantity.

Outputs

- All the output variables can be output via analog and pulse outputs or the interfaces (e.g. bus). In addition, relay outputs for limit value violation are also available. The number of outputs depends on the version of the device.
- If a relay is configured for "Wet Steam Alarm" it switches as soon as superheated steam is within 2 °C (3.6 °F) of the saturated steam curve (condensate temperature). At the same time, an alarm message appears on the display.

Other functions

- Two-stage monitoring of steam status:
 - Wet steam alarm: 2 °C (3.6 °F) above saturated steam or condensate temperature.
 - Phase transition alarm: alarm at saturated steam or condensate temperature.
- Configurable alarm response, i.e. the function of the counters and outputs in the event of an error (e.g. cable open circuit, phase transition) can be individually defined.

11.4 Overview function matrix



Gray function blocks are set-up units with submenus. Dependent on the menu selection, some positions will be hidden.

Basic set-up

Date-Time	System eng. units	Code	Alarm response	Text input	General info
Date	System eng. units	User	Fault category	Text input	Unit ID
Time		Alarm lim.			Tag-number
Summertime / normal time					Prog.-name
					SW version
					SW option
					CPU-No.

Display

Group	Scrolling display	Display	Contrast
Group 1 to 6	Swit. time	OIML	Main unit
Identifier	Group 1 to 6 yes/no	No. of Sums	
Display mask			
Value type			
Value			

Inputs

Flow inputs		Special flow meters		Pressure inputs	Temperature inputs
Identifier		Differential pressure	> Mean flow	Signal	Signal
DPT		Identifier	Identifier	Terminal	Terminal
Signal		DPT / Splitting Range	Number	Unit	Unit
Terminal		Flow type	Sums	Relative / Absolute	3-wire / 4-wire
Curve		Signal	Sums external	Start value	Start value
Units		Time base		End value	End value
Pulse value / K fact. unit		Units		Signal damp	Signal damp
Start value		Start value (1,2,3)		Offset	Offset
End value		End value (1,2,3)		Default	Default
Flow cut off		Flow cut off		Mean value	Mean value
Correction		Correction		Identifier	Identifier
Signal damp		Signal damp		Number	Number
Offset		Offset		Alarm response	Alarm response
Correction table		Correction table			
Sums	> Signal Reset	Sums	> Signal Reset		
Alarm response		Alarm response			

Outputs

Analog outputs	Pulse outputs	Relay / set point
Identifier	Identifier	Transmit by
Terminal	Signal	Terminal
Sig. source	Terminal	Operation mode
Current range	Sig. source	Sig. source
Start value	Pulse	Switch point
End value	Type	Hysteresis
Signal damping	Pulse value	Time delay
Fault cond. action	Width	Gradient
Simulation	Simulation	Limit display

Application

Application	
Identifier	
Media (water/steam)	
Application	
Steam type	
Flow	
Install. point	
Mean pressure	
Temperature (1 & 2)	
Units	
Sums	Sums Signal reset
Alarm response	

Communication

RS485 (1)	RS232 / RS485 (2)	Profibus
Baudrate	Baudrate	Number (0...48)
		Addr. 0...4 ... Addr. 235...239

Service

PRESET	Total sums
--------	------------

Index

A

Active sensors	15
Alarm response	35, 38, 41–43, 47
Application	
Steam mass/quantity of heat	81
Steam/heat difference	83
Water/heat difference	79
Water/quantity of heat	77

B

Barrel	37, 46
Basic unit	31

C

Checklist for troubleshooting	58
Connecting E+H-specific devices	16
Connecting external sensors	15
Connection of outputs	18
Correction table	37–38, 40, 76
Curve	36, 39, 76

D

Default temperature	43
Dimensions	11
Display	24, 31, 55
Display values	33, 55

E

Electrical connection	
Post-connection check (checklist)	22
Entering text	25
Error list	29, 33
Error messages	32
Event buffer	29, 33
Example of application, steam mass	54
Extension cards	31

F

Flow transmitter	36–37, 55, 76
------------------------	---------------

I

Installing extension cards	12
Installing remote display/operating unit	21
Interfaces	18

K

Key icons	24
-----------------	----

L

Lock configuration	25
--------------------------	----

M

Main menu - Diagnosis	33
Main menu - Setup	34
Mean value computation	41–43, 76
Mounting location	11

N

Nameplate	10
-----------------	----

O

Operating example	26
Orientation	11

P

Passive sensors	16
Pitot tube	74
Power supply connection	15
Pressure sensors	36

R

Remote display/operating unit	20
Repairs	8, 63

S

Setup	
Applications	44
Basic Setup	34
Communication	53
Display	48
Inputs	36
Outputs	49
Pressure Inputs	42
Pulse Outputs	49
Service	54
Set Point	51
Temperature Inputs	43
Special flow meters	39
Splitting Range operation	75
Steam	
Saturated steam	44
Steam heat	44
Steam mass	44
Superheated steam	44

T

Temperature sensors	16
Terminal assignment	13
Terminal assignment of temperature extension card ..	20
Terminal assignment of Universal extension card	19
Totalizers	46

U

Units	45
-------------	----



Set-up table

Customer	
Order code	
Unit no.	
Operator	

Expansion cards	
Type	Slot
Universal	
Temperature	

Application	Measurement	Application type

Flow	Signal type	Start value	End value	Pulse value	Eng. Units

Pressure	Signal type	Start value	End value	Eng. Units

Temperature	Signal type	Start value	End value	Eng. Units

Outputs	Signal source	Signal type	Start value	End value	Pulse value	Eng. Units

For terminal connections see next page

Termination plan

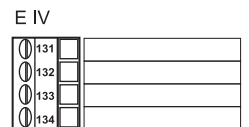
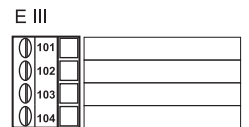
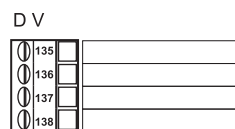
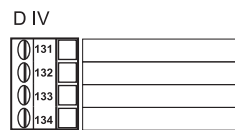
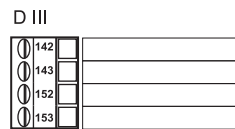
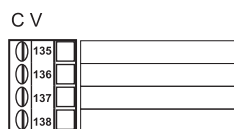
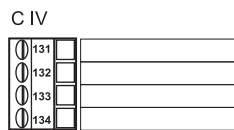
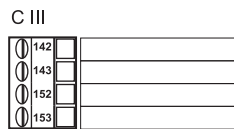
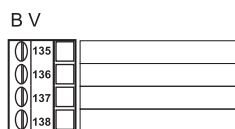
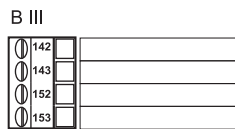
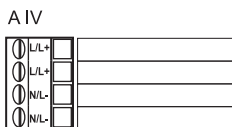
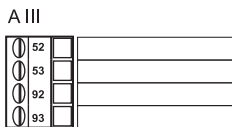
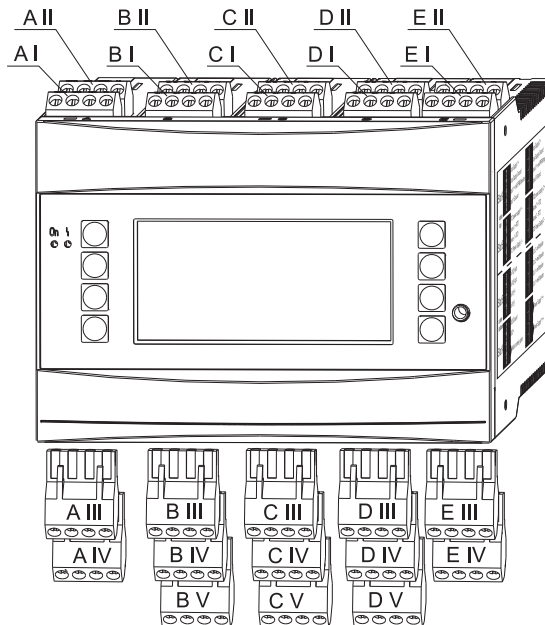
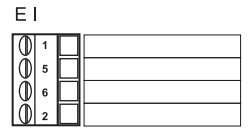
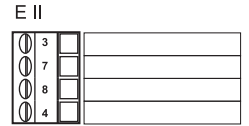
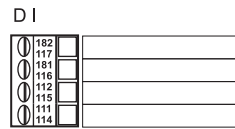
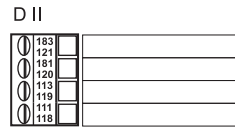
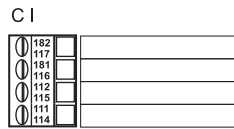
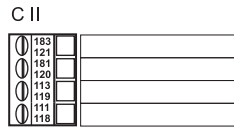
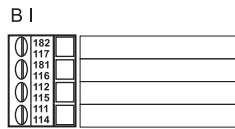
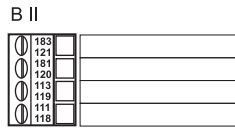
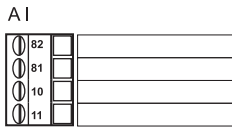
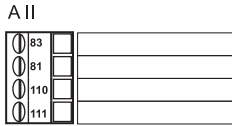

www.addresses.endress.com
