

Brief Operating Instructions

Proline Promag 55

Electromagnetic flowmeter

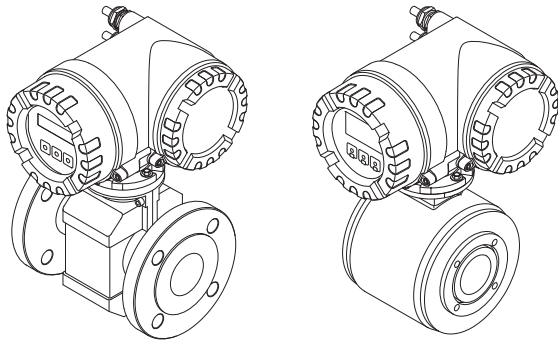

These Brief Operating Instructions are not intended to replace the Operating Instructions provided in the scope of supply. Detailed information about the measuring device is provided in the Operating Instructions and the additional documentation:

- On the CD-ROM supplied (not included in the delivery for all device versions).
- Available for all measuring device versions via:
 - Internet: www.endress.com/deviceviewer
 - Smart phone/tablet: Endress+Hauser Operations App

Table of contents

1	Safety instructions	4
1.1	Designated use	4
1.2	Installation, commissioning and operation	4
1.3	Operational safety	4
1.4	Safety conventions	6
2	Installation	6
2.1	Transporting to the measuring point	6
2.2	Installation conditions	7
2.3	Installing the Promag S sensor	13
2.4	Installing the Promag H sensor	20
2.5	Installing the transmitter housing	23
2.6	Post-installation check	26
3	Wiring	27
3.1	Connecting the various housing types	28
3.2	Connecting the remote version connecting cable	29
3.3	Potential equalization	32
3.4	Degree of protection	33
3.5	Post-connection check	33
4	Hardware settings	34
4.1	Device address	34
4.2	Terminating resistors	36
5	Commissioning	37
5.1	Switching on the measuring device	37
5.2	Operation	38
5.3	Navigating within the function matrix	39
5.4	Calling the Commissioning Quick Setup	40
5.5	Software settings	41
5.6	Troubleshooting	41

1 Safety instructions

1.1 Designated use



- The measuring device is to be used only for measuring the flow of conductive liquids in closed pipes. All liquids (incl. demineralized water) can be metered, provided they have a minimum conductivity of 5 $\mu\text{S}/\text{cm}$.
- Any use other than that described here compromises the safety of persons and the entire measuring system and is, therefore, not permitted.
- The manufacturer is not liable for damage caused by improper or non-designated use.

1.2 Installation, commissioning and operation

- The measuring device must only be installed, connected, commissioned and maintained by qualified and authorized specialists (e.g. electrical technicians) in full compliance with the instructions in these Brief Operating Instructions, the applicable norms, legal regulations and certificates (depending on the application).
- The specialists must have read and understood these Brief Operating Instructions and must follow the instructions they contain. If you are unclear on anything in these Brief Operating Instructions, you must read the Operating Instructions (on the CD-ROM). The Operating Instructions provide detailed information on the measuring device.
- The measuring device should only be installed in the pipe in a de-energized state free from outside loads or strain.
- The measuring device may only be modified if such work is expressly permitted in the Operating Instructions (on the CD-ROM).
- Repairs may only be performed if a genuine spare parts kit is available and this repair work is expressly permitted.
- If performing welding work on the piping, the welding unit may not be grounded by means of the measuring device.

1.3 Operational safety

- The measuring device is designed to meet state-of-the-art safety requirements, has been tested, and left the factory in a condition in which it is safe to operate. Relevant regulations and European standards have been observed.
- The information specified on the warning notices, nameplates and connection labels fitted on the measuring device must be observed. These contain important data, including information on the permitted operating conditions, the application of the measuring device and data on materials.
- If the measuring device is not operated at atmospheric temperatures, compliance with the relevant basic conditions specified in the device documentation provided (on the CD-ROM) is absolutely essential
- The measuring device must be wired in accordance with the wiring diagrams and connection labels. Interconnecting must be permitted.

- All parts of the measuring device must be integrated into the potential matching system of the plant.
- The cables, tested cable glands and tested dummy plugs must suit the prevailing operating conditions, e.g. the temperature range of the process. Housing openings that are not used need to be sealed with dummy plugs.
- The measuring device can only be used in conjunction with fluids to which all the wetted parts of the measuring device are adequately resistant. With regard to special fluids, including fluids used for cleaning, Endress+Hauser will be happy to assist in clarifying the corrosion-resistant properties of wetted materials. However, minor changes in temperature, concentration or in the degree of contamination in the process may result in variations in corrosion resistance. For this reason, Endress+Hauser does not accept any responsibility with regard to the corrosion resistance of wetted materials in a specific application. The user is responsible for the choice of suitable wetted materials in the process.
- Hazardous areas
Measuring devices for use in hazardous areas are labeled accordingly on the nameplate. Relevant national regulations must be observed when operating the device in hazardous areas. The Ex documentation on the CD-ROM is an integral part of the entire device documentation.
The installation regulations, connection data and safety instructions provided in the Ex documentation must be observed. The symbol and name on the front page provides information on the approval and certification (e.g.  Europe,  USA,  Canada). The nameplate also bears the documentation number of this Ex documentation (XA***D/./..).
- For measuring systems used in SIL 2 applications, the separate manual on functional safety (on the CD-ROM) must be observed.
- Hygienic applications
Measuring devices for hygienic applications have their own special labeling. Relevant national regulations must be observed when using these devices.
- Pressure instruments
Measuring devices for use in systems that need to be monitored are labeled accordingly on the nameplate. Relevant national regulations must be observed when using these devices. The documentation on the CD-ROM for pressure instruments in systems that need to be monitored is an integral part of the entire device documentation. The installation regulations, connection data and safety instructions provided in the Ex documentation must be observed.
- Endress+Hauser will be happy to assist in clarifying any questions on approvals, their application and implementation.

1.4 Safety conventions

Warning!

"Warning" indicates an action or procedure which, if not performed correctly, can result in injury or a safety hazard. Comply strictly with the instructions and proceed with care.

Caution!

"Caution" indicates an action or procedure which, if not performed correctly, can result in incorrect operation or destruction of the device. Comply strictly with the instructions.

Note!

"Note" indicates an action or procedure which, if not performed correctly, can have an indirect effect on operation or trigger an unexpected response on the part of the device.

2 Installation

2.1 Transporting to the measuring point

- Transport the measuring device to the measuring point in the original packaging.
- Do not remove the covers or caps until immediately before installation.

2.1.1 Transporting flanged devices DN ≤ 300 (12")

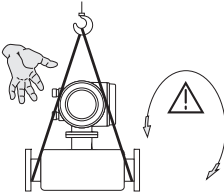

A0007408

To transport the unit, use slings slung around the process connections or use lugs (if available).

 **Warning!**
Risk of injury! The device can slip.
The center of gravity of the measuring device may be higher than the holding points of the slings. Always ensure that the device cannot slip or turn around its axis.

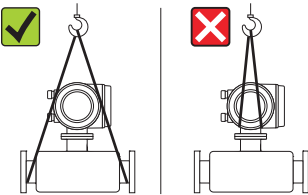

A0007409

Do not lift measuring devices by the transmitter housing or the connection housing in the case of the remote version. Do not use chains as they could damage the housing.

2.1.2 Transporting flanged devices DN > 300 (12")

Use only the metal eyes provided on the flanges to transport, lift or position the sensor in the piping.

 Caution!

Do not attempt to lift the sensor with the tines of a fork-lift truck beneath the metal casing! This would buckle the casing and damage the internal magnetic coils.

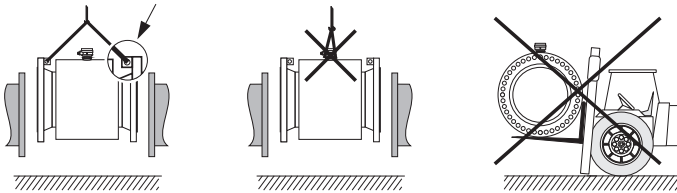

A0008153

2.2 Installation conditions

2.2.1 Dimensions

For the dimensions of the measuring device, see the associated Technical Information on the CD-ROM.

2.2.2 Mounting location

The accumulation of air or formation of gas bubbles in the measuring tube can result in an increase in measuring errors.

For this reason avoid the following mounting locations in the pipe:

- At the highest point of a pipeline. Risk of air accumulating!
- Directly upstream from a free pipe outlet in a down pipe.

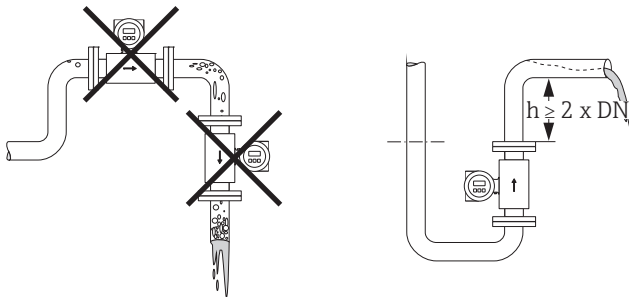

A0008154

Installation of pumps

Do not install the sensor on the intake side of a pump. This precaution is to avoid low pressure and the consequent risk of damage to the lining of the measuring tube. It might be necessary to use pulse dampers in systems incorporating piston pumps, piston diaphragm pumps or peristaltic pumps.

Information on the measuring system's pressure tightness and resistance to vibration and shock can be found in the Operating Instructions of the CD-ROM.

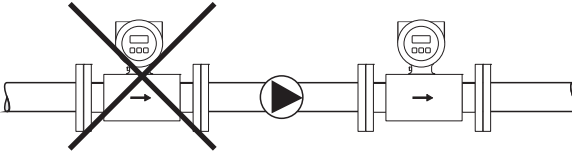

A0003203

Partially filled pipes

Partially filled pipes with gradients necessitate a drain-type configuration.

The empty pipe detection (EPD) function offers additional protection by detecting empty or partially filled pipes.

 **Caution!**

Risk of solids accumulating! Do not install the sensor at the lowest point in the drain. It is advisable to install a cleaning valve.

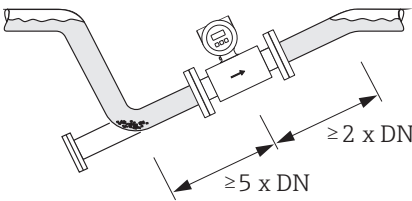

Installation in a partially filled pipe

A0008155

Down pipes

Install a siphon or a vent valve downstream of the sensor in down pipes longer than 5 meters (16 ft). This precaution is to avoid low pressure and the consequent risk of damage to the lining of the measuring tube. This measure also prevents the system losing prime, which could cause air pockets.

For information on the pressure tightness of the measuring tube lining, → see the Operating Instructions on the CD-ROM.

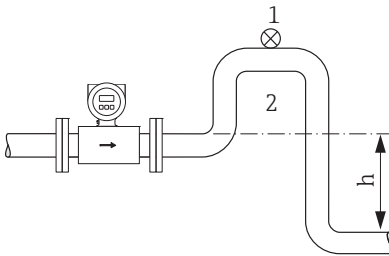

A0008157

Measures for installation in a down pipe ($h > 5 \text{ m}/16 \text{ ft}$)

1. Vent valve
2. Siphon

2.2.3 Orientation

An optimum orientation helps avoid gas and air accumulations and buildup in the measuring tube. The measuring device, nevertheless, supplies a range of functions and tools to measure problematic fluids correctly:

- Electrode cleaning circuitry (ECC) to prevent electrically conductive deposits in the measuring tube, e.g. for fluids causing buildup
- Empty pipe detection (EPD) for detecting partially filled measuring tubes, e.g. in the case of degassing fluids or varying process pressures

Vertical orientation

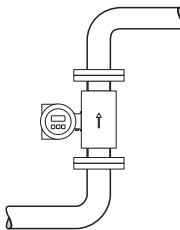

A0008158

This orientation is optimum for self-emptying piping systems and when using empty pipe detection (EPD) or open electrode detection (OED).

Horizontal orientation

The measuring electrode plane should be horizontal. This prevents brief insulation of the two electrodes by entrained air bubbles.

 Caution!

In the case of horizontal orientation, empty pipe detection only works correctly if the transmitter housing is facing upwards. Otherwise there is no guarantee that empty pipe detection will respond if the measuring tube is only partially filled or empty.

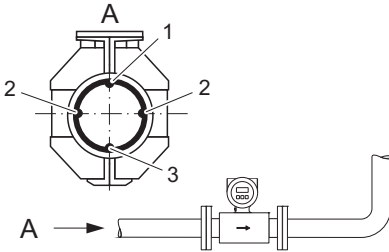

A0008159

1. EPD electrode for empty pipe detection (not for Promag H, DN 2 to 8, 1/12 to 5/16").
2. Measuring electrodes for signal detection
3. Reference electrode for potential equalization (not for Promag H)

Inlet and outlet runs

If possible, install the sensor upstream from fittings such as valves, T-pieces, elbows, etc.

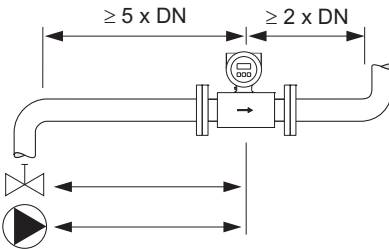

A0008160

The following inlet and outlet runs must be observed in order to meet accuracy specifications:

- Inlet run: $\geq 5 \times DN$
- Outlet run: $\geq 2 \times DN$

2.2.4 Vibrations

Secure and fix both the piping and the sensor if vibrations are severe.

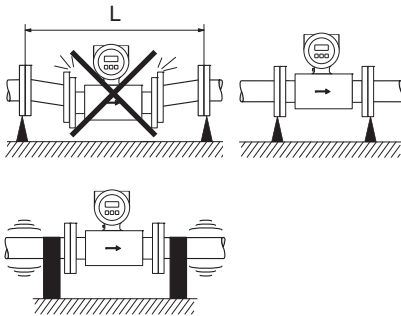

Measures to prevent device vibration
($L > 10 \text{ m}/33 \text{ ft}$)



Caution!

It is advisable to install the sensor and transmitter separately if vibration is excessively severe. For information on the permitted shock and vibration resistance, see the Operating Instructions on the CD-ROM.

A0008161

2.2.5 Foundations, supports

If the nominal diameter is $\text{DN} \geq 350$ (14"), mount the sensor on a foundation of adequate load-bearing strength.



Caution!

Risk of damage! Do not support the weight of the sensor on the metal casing. This would buckle the casing and damage the internal magnetic coils.

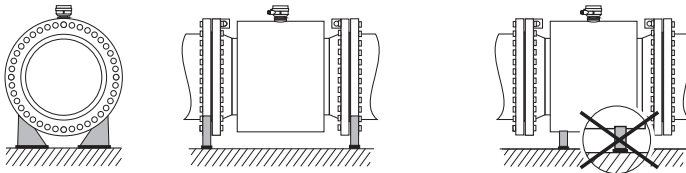

A0008163

2.2.6 Length of connecting cable

Comply with the following instructions in order to ensure correct measuring results:

- Secure the cable run or route the cable in an armored conduit. Movement of the cable can falsify the measuring signal, particularly if the fluid conductivity is low.
- Route the cable well clear of electrical machines and switching elements.
- Ensure potential equalization between the sensor and transmitter, if necessary.
- The permissible cable length L_{max} depends on the fluid conductivity.

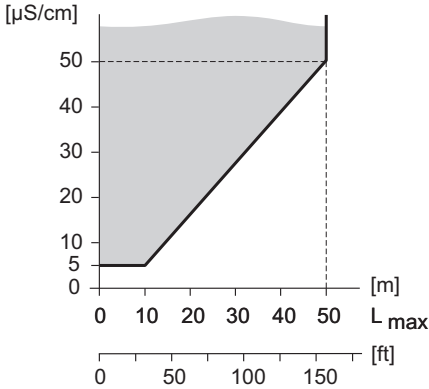
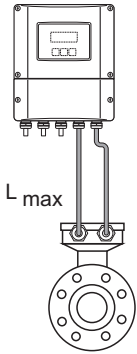

Gray shaded area = permissible range

L_{max} = length of connecting cable in [m]/[ft]

Fluid conductivity in $\mu\text{S/cm}$

A0008233

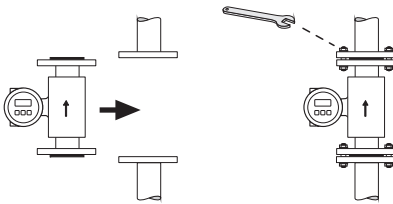

2.3 Installing the Promag S sensor



A0008165

 **Note!**
Screws, nuts, seals, etc. are not included in the scope of supply and must be supplied by the customer.

The sensor is installed between the two pipe flanges:

- The requisite torques must be observed →  14 ff.
- Information on the installation of additional ground disks →  13

2.3.1 Seals

Comply with the following instructions when installing seals:

- Natural rubber lining → **No** seals may be used.
- PFA, PTFE or polyurethane lining → No seals are required.
- Make sure that the mounted seals do not protrude into the piping cross-section.

 **Caution!**
Risk of short circuit!

Do not use electrically conductive sealing compounds such as graphite! An electrically conductive layer could form on the inside of the measuring tube and short-circuit the measuring signal.

2.3.2 Ground cable (DN 15 to 600, ½ to 24")

If necessary, special ground cables can be ordered as accessories for potential equalization.

2.3.3 Mounting ground disks (DN 15 to 600, ½ to 24")

- Grounding function for potential equalization:
Depending on the application conditions, e.g. in the case of lined or floating pipes, it may be necessary to also mount ground disks between the sensor and the pipe flange for potential equalization. Ground disks can be ordered from Endress+Hauser as a separate accessory.
- Protective function for the measuring tube lining:
When measuring extremely abrasive fluids, such as sludge containing sand or stones (ore slurry, cement etc.), liner protection plates should be installed, if necessary, to protect the measuring tube lining from excessive abrasion.

 **Caution!**

- When using ground disks (incl. seals), the face-to-face length is increased! For information on the dimensions, see the associated Technical Information on the CD-ROM.
- Natural rubber lining → No additional seals may be mounted between the disk and the sensor flange.
- PTFE, PFA and polyurethane lining → Additional seals must be mounted between the ground disk and pipe flange.

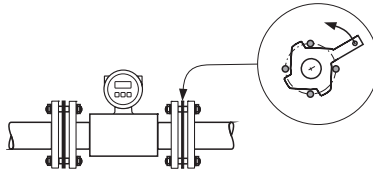

A0008167

1. Place the ground disk and the additional seals between the measuring device flange and pipe flange (see graphic).
2. Insert the screws through the flange bores. Tighten the nuts so that they are still loose.
3. Now rotate the ground disk as shown in the graphic until the handle strikes the screws. This correctly centers the ground disk automatically.
4. Tighten the screws to the required torque → 14
5. Wire the ground disks in accordance with the grounding concept of the plant.

2.3.4 Tightening torques for Promag S

- The tightening torques listed below are for lubricated threads only.
- Always tighten the screws uniformly and in diagonally opposite sequence.
- Overtightening the screws will deform the sealing faces or damage the seals.
- The values listed below apply only to pipes not subjected to tensile stress.

Promag S screw tightening torques for EN 1092-1 (DIN 2501), PN 10/16/25/40

Nominal diameter [mm]	EN (DIN) Pressure rating [bar]	Threaded fasteners	Flange thickness	Max. tightening torque [Nm]				
				Natural rubber	Polyurethane	PTFE	PFA	Hard rubber
15	PN 40	4 × M 12	16	-	-	11	-	-
25	PN 40	4 × M 12	18	-	15	26	20	-
32	PN 40	4 × M 16	18	-	24	41	35	-
40	PN 40	4 × M 16	18	-	31	52	47	-
50	PN 40	4 × M 16	20	-	40	65	59	48
65 *	PN 16	8 × M 16	18	11	27	43	40	32
65	PN 40	8 × M 16	22	-	27	43	40	32
80	PN 16	8 × M 16	20	13	34	53	48	40
80	PN 40	8 × M 16	24	-	34	53	48	40
100	PN 16	8 × M 16	20	14	36	57	51	43
100	PN 40	8 × M 20	24	-	50	78	70	59
125	PN 16	8 × M 16	22	19	48	75	67	56
125	PN 40	8 × M 24	26	-	71	111	99	83
150	PN 16	8 × M 20	22	27	63	99	85	74
150	PN 40	8 × M 24	28	-	88	136	120	104
200	PN 10	8 × M 20	24	35	91	141	101	106
200	PN 16	12 × M 20	24	28	61	94	67	70
200	PN 25	12 × M 24	30	-	92	138	105	104

Nominal diameter [mm]	EN (DIN) Pressure rating [bar]	Threaded fasteners	Flange thickness	Max. tightening torque [Nm]				
				Natural rubber	Polyuretha ne	PTFE	PFA	Hard rubber
250	PN 10	12 × M 20	26	27	71	110	-	82
250	PN 16	12 × M 24	26	48	85	131	-	98
250	PN 25	12 × M 27	32	-	134	200	-	150
300	PN 10	12 × M 20	26	34	81	125	-	94
300	PN 16	12 × M 24	28	67	118	179	-	134
300	PN 25	16 × M 27	34	-	138	204	-	153
350	PN 10	16 × M 20	26	47	118	188	-	112
350	PN 16	16 × M 24	30	68	165	254	-	152
350	PN 25	16 × M 30	-	-	252	380	-	227
400	PN 10	16 × M 24	26	65	167	260	-	151
400	PN 16	16 × M 27	32	95	215	330	-	193
400	PN 25	16 × M 33	-	-	326	488	-	289
450	PN 10	20 × M 24	28	59	133	235	-	153
450	PN 16	20 × M 27	40	96	196	300	-	198
450	PN 25	20 × M 33	-	-	253	385	-	256
500	PN 10	20 × M 24	28	66	171	265	-	155
500	PN 16	20 × M 30	34	132	300	448	-	275
500	PN 25	20 × M 33	-	-	360	533	-	317
600	PN 10	20 × M 27	28	93	219	345	-	206
600 *	PN 16	20 × M 33	36	202	443	658	-	415
600	PN 25	20 × M 36	-	-	516	731	-	431

* Designed acc. to EN 1092-1 (not to DIN 2501)

**Promag S screw tightening torques for EN 1092-1, PN 10/16/25, stainless-steel;
Calculated according to EN 1591-1:2014 for flange according to EN 1092-1:2013**

Nominal diameter [mm]	EN (DIN) Pressure rating [bar]	Threaded fasteners	Flange thickness	Nom. tightening torque [Nm]				
				Natural rubber	Polyuretha ne	PTFE	PFA	Hard rubber
350	PN 10	16 × M 20	26	80	80	60	-	70
350	PN 16	16 × M 24	30	135	135	115	-	125
350	PN 25	16 × M 30	-	-	235	220	-	230
400	PN 10	16 × M 24	26	110	120	90	-	100
400	PN 16	16 × M 27	32	180	190	155	-	175
400	PN 25	16 × M 33	-	-	325	290	-	315
450	PN 10	20 × M 24	28	105	110	90	-	100
450	PN 16	20 × M 27	34	175	190	155	-	175
450	PN 25	20 × M 33	-	-	310	290	-	300
500	PN 10	20 × M 24	28	120	120	100	-	110
500	PN 16	20 × M 30	36	235	235	205	-	225

Nominal diameter [mm]	EN (DIN) Pressure rating [bar]	Threaded fasteners	Flange thickness	Nom. tightening torque [Nm]				
				Natural rubber	Polyuretha ne	PTFE	PFA	Hard rubber
500	PN 25	20 × M 33	-	-	370	345	-	370
600	PN 10	20 × M 27	30	172	160	150	-	165
600 *	PN 16	20 × M 33	40	355	340	310	-	340
600	PN 25	20 × M 36	-	-	540	500	-	540

* Designed acc. to EN 1092-1 (not to DIN 2501)

Promag S screw tightening torques for JIS B2220, 10/20K

Nominal diameter [mm]	JIS Pressure rating [bar]	Threaded fasteners	Max. tightening torque [Nm]				
			Natural rubber	Polyurethane	PTFE	PFA	Hard rubber
15	10K	4 × M 12	-	-	16	-	-
15	20K	4 × M 12	-	-	16	-	-
25	10K	4 × M 16	-	19	32	-	-
25	20K	4 × M 16	-	19	32	-	-
32	10K	4 × M 16	-	22	38	-	-
32	20K	4 × M 16	-	22	38	-	-
40	10K	4 × M 16	-	24	41	-	-
40	20K	4 × M 16	-	24	41	-	-
50	10K	4 × M 16	-	33	54	-	40
50	20K	8 × M 16	-	17	27	-	20
65	10K	4 × M 16	-	45	74	-	55
65	20K	8 × M 16	-	23	37	-	28
80	10K	8 × M 16	-	23	38	-	29
80	20K	8 × M 20	-	35	57	-	42
100	10K	8 × M 16	-	29	47	-	35
100	20K	8 × M 20	-	48	75	-	56
125	10K	8 × M 20	-	51	80	-	60
125	20K	8 × M 22	-	79	121	-	91
150	10K	8 × M 20	-	63	99	-	75
150	20K	12 × M 22	-	72	108	-	81
200	10K	12 × M 20	-	52	82	-	61
200	20K	12 × M 22	-	80	121	-	91
250	10K	12 × M 22	-	87	133	-	100
250	20K	12 × M 24	-	144	212	-	159
300	10K	16 × M 22	-	63	99	-	74
300	20K	16 × M 24	-	124	183	-	138

Promag S screw tightening torques for JIS B2220, 10/20K

Nominal diameter [mm]	JIS Pressure rating	Threaded fasteners	Nom. tightening torque [Nm]				
			Natural rubber	Polyurethane	PTFE	PFA	Hard rubber
350	10K	16 × M 22	16 × M 22	109	109	16 × M 22	109
350	20K	16 × M 30×3	16 × M 30×3	217	217	16 × M 30×3	217
400	10K	16 × M 24	16 × M 24	163	163	16 × M 24	163
400	20K	16 × M 30×3	16 × M 30×3	258	258	16 × M 30×3	258
450	10K	16 × M 24	16 × M 24	155	155	16 × M 24	155
450	20K	16 × M 30×3	16 × M 30×3	272	272	16 × M 30×3	272
500	10K	16 × M 24	16 × M 24	183	183	16 × M 24	183
500	20K	16 × M 30×3	16 × M 30×3	315	315	16 × M 30×3	315
600	10K	16 × M 30	16 × M 30	235	235	16 × M 30	235
600	20K	16 × M 36×3	16 × M 36×3	381	381	16 × M 36×3	381

Promag S screw tightening torques for ASME B16.5, Class 150/300

Nominal diameter [inch]	ASME Pressure rating [lbs]	Threaded fasteners	Max. tightening torque [lbf · ft]				
			Promag S				
			Natural rubber	Polyurethane	PTFE	PFA	Hard rubber
½"	Class 150	4 × ½"	–	–	4.4	–	–
½"	Class 300	4 × ½"	–	–	4.4	–	–
1"	Class 150	4 × ½"	–	5.2	8.1	7.4	–
1"	Class 300	4 × 5/8"	–	5.9	10	8.9	–
1½"	Class 150	4 × ½"	–	7.4	18	15	–
1½"	Class 300	4 × ¾"	–	11	25	23	–
2"	Class 150	4 × 5/8"	–	16	35	32	26
2"	Class 300	8 × 5/8"	–	8	17	16	13
3"	Class 150	4 × 5/8"	15	32	58	49	44
3"	Class 300	8 × ¾"	–	19	35	31	28
4"	Class 150	8 × 5/8"	11	23	41	37	31
4"	Class 300	8 × ¾"	–	30	49	44	43
6"	Class 150	8 × ¾"	24	44	78	63	58
6"	Class 300	12 × ¾"	–	38	54	49	52
8"	Class 150	8 × ¾"	38	59	105	80	79
10"	Class 150	12 × 7/8"	42	55	100	–	75
12"	Class 150	12 × 7/8"	58	76	131	–	98

Nominal diameter [inch]	ASME Pressure rating [lbs]	Threaded fasteners	Max. tightening torque [lbf · ft]				
			Promag S				
			Natural rubber	Polyurethane	PTFE	PFA	Hard rubber
14"	Class 150	12 × 1"	77	117	192	-	100
16"	Class 150	16 × 1"	75	111	181	-	94
18"	Class 150	16 × 1 1/8"	108	173	274	-	150
20"	Class 150	20 × 1 1/8"	105	160	252	-	135
24"	Class 150	20 × 1 1/4"	161	226	352	-	198

Promag S screw tightening torques for AS 2129, Table E

Nominal diameter [mm]	AS 2129 Pressure rating	Threaded fasteners	Max. tightening torque [Nm]	
			PTFE	Hard rubber
25	Table E	4 × M 12	21	-
50	Table E	4 × M 16	42	32
80	Table E	4 × M 16	-	16
100	Table E	8 × M 16	-	13
150	Table E	8 × M 20	-	22
200	Table E	8 × M 20	-	36
250	Table E	12 × M 20	-	37
300	Table E	12 × M 24	-	57
350	Table E	12 × M 24	-	85
400	Table E	12 × M 24	-	99
450	Table E	16 × M 24	-	96
500	Table E	16 × M 24	-	115
600	Table E	16 × M 30	-	199

Promag S screw tightening torques for AS 4087, PN16

Nominal diameter [mm]	AS 4087 Pressure rating	Threaded fasteners	Max. tightening torque [Nm]	
			PTFE	Hard rubber
50	PN 16	4 × M 16	42	32
80	PN 16	4 × M 16	-	16
100	PN 16	4 × M 16	-	13
150	PN 16	8 × M 16	-	20
200	PN 16	8 × M 16	-	33
250	PN 16	8 × M 20	-	64
300	PN 16	12 × M 20	-	55
350	PN 16	12 × M 24	-	91
400	PN 16	12 × M 24	-	113

Nominal diameter [mm]	AS 4087 Pressure rating	Threaded fasteners	Max. tightening torque [Nm]	
			PTFE	Hard rubber
450	PN 16	12 × M 24	-	144
500	PN 16	16 × M 24	-	131
600	PN 16	16 × M 27	-	204

2.4 Installing the Promag H sensor

The Promag H sensor is supplied to order, with or without pre-installed process connections. Pre-installed process connections are secured to the sensor with hex-head threaded fasteners.

Caution!

The sensor might require support or additional attachments, depending on the application and the length of the piping run. When plastic process connections are used, the sensor must be additionally supported mechanically. A wall-mounting kit can be ordered separately from Endress+Hauser as an accessory.

2.4.1 Seals

When mounting the process connections, make sure that the seals in question are free from dirt and centered correctly.

Caution!

- The screws must be securely tightened in the case of metal process connections. Together with the sensor, the process connection forms a metal connection that ensures defined seal compression.
- With regard to process connections made of plastic material, comply with the max. torques for lubricated threads (7 Nm / 5.2 lbf ft). A seal must always be used between the connection and counterflange for plastic flanges.
- The seals should be replaced periodically depending on the application, particularly if molded seals are used (aseptic version)! The intervals between seal replacement depend on the frequency of the cleaning cycles and the fluid and cleaning temperatures. Replacement seals can be ordered as an accessory.

2.4.2 Using and mounting grounding rings (DN 2 to 25, 1/2 to 1")

In the case of process connections made of plastic (e.g. flange connections or adhesive couplings), potential equalization between the sensor and fluid must be ensured via additional grounding rings.

If grounding rings are missing, this can affect accuracy or result in the destruction of the sensor due to electrochemical electrode reduction.

Caution!

- Depending on the order option, appropriate plastic disks are used instead of grounding rings for the process connections. These plastic disks only act as a kind of "place holder" and do not have any potential equalization function whatsoever. In addition, they also assume an important sealing function at the sensor/connection interface. Thus, these plastic disks/seals should never be removed and should always be mounted for process connections without metal grounding rings!
- Grounding rings can be ordered separately from Endress+Hauser as an accessory. When ordering, make sure that the grounding rings are compatible with the electrode material. Otherwise there is the risk that electrodes can be damaged by electrochemical corrosion! For information on materials, see the Operating Instructions on the CD-ROM.
- Grounding rings, incl. seals, are mounted inside the process connections. The face-to-face length is not affected.

Installing the grounding rings

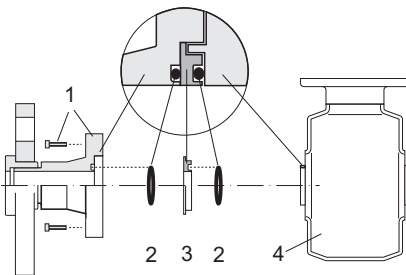

- 1 = Process connection hexagonal-headed bolts
- 2 = O-ring seals
- 4 = Sensor
- 3 = Grounding ring or plastic disk (place holder)

A0008168

- a. Release the four hexagonal-headed bolts (1) and remove the process connection from the sensor (4).
- b. Remove the plastic disk (3) including the two O-ring seals (2) from the process connection.
- c. Insert one of the O-ring seals (2) back into the groove of the process connection.
- d. Place the metal grounding ring (3) into the process connection as illustrated.
- e. Now insert the second O-ring seal (2) into the groove of the grounding ring.
- f. Mount the process connection back onto the sensor. In doing so, make sure to observe the max. torques for lubricated threads (7 Nm / 5.2 lbf ft).

2.4.3 Welding the sensor into the pipe (weld nipples)



Caution!

Risk of destroying the electronics! Make sure that the welding system is not grounded via the sensor or transmitter.

- a. Secure the sensor with a few welding points in the pipe.
A welding jig suitable for this purpose can be ordered separately as an accessory.
- b. Release the screws on the process connection flange and remove the sensor, including the seal, from the pipe.
- c. Weld the process connection into the pipe.
- d. Mount the sensor back into the pipe.
In doing so, make sure the seals are clean and correctly positioned.



Note!

- When welding is performed correctly with thin-walled pipes carrying food, the seal is not damaged by the heat even when it is mounted. It is recommended, however, to disassemble the sensor and seal.
- For the disassembly work, it must be possible to open the pipe approx. 8 mm (0.31 in) in total.

2.5 Installing the transmitter housing

2.5.1 Turning the transmitter housing

Turning the aluminum field housing

Aluminum field housing for non-Ex area

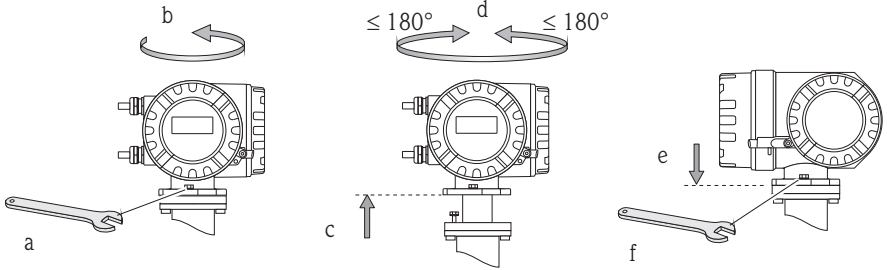

A0007540

2.5.2 Turning the onsite display

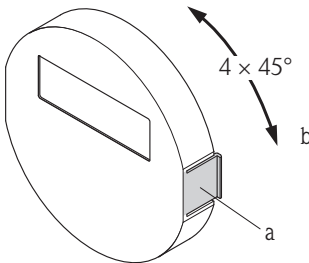

A0007541

- Press in the side latches on the display module and remove the module from the cover plate of the electronics compartment.
- Turn the display to the desired position (max. $4 \times 45^\circ$ in both directions) and reset it onto the cover plate of the electronics compartment.

2.5.3 Installing the wall-mount housing

 Caution!

- Make sure that the ambient temperature does not exceed the permitted range.
- Always install the wall-mount housing in such a way that the cable entries point downwards.

Mounted directly on the wall

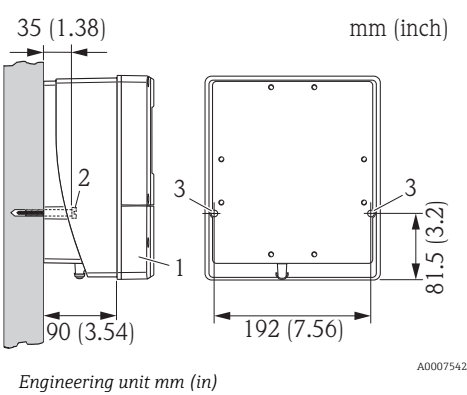

1. Connection compartment
2. Securing screws M6 (max. ø 6.5 mm (0.26")); screw head max. ø 10.5 mm (0.4")
3. Housing bores for securing screws

Pipe mounting

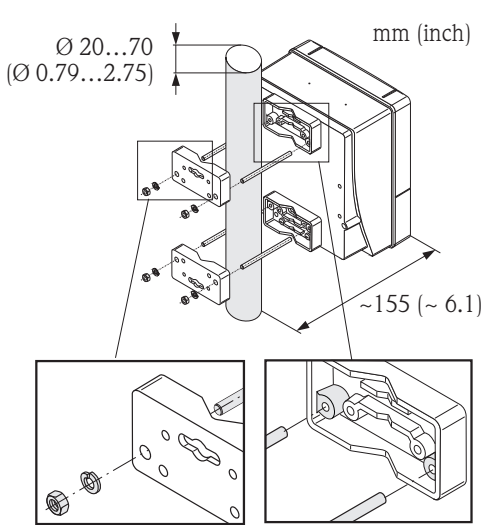

Caution!
 Danger of overheating! If the device is mounted on a warm pipe, make sure that the housing temperature does not exceed $+60\text{ }^{\circ}\text{C}$ ($+140\text{ }^{\circ}\text{F}$) which is the maximum temperature permitted.

Engineering unit mm (in)

A0007543

Panel mounting

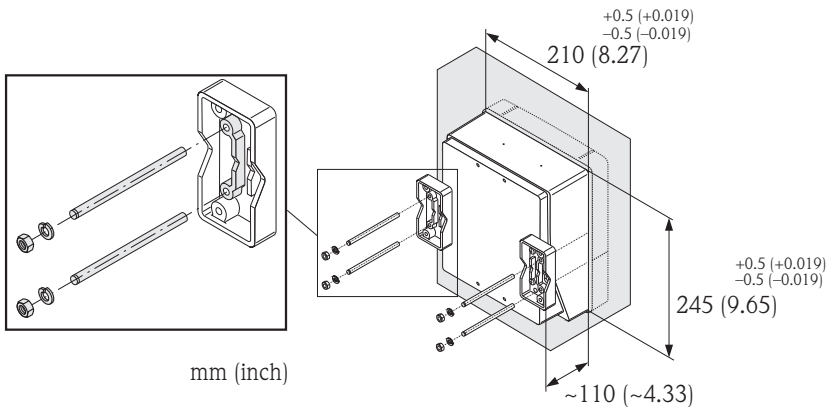

Engineering unit mm (in)

A0007544

2.6 Post-installation check

- Is the measuring device damaged (visual inspection)?
- Does the device correspond to specifications at the measuring point, including process temperature and pressure, ambient temperature, minimum fluid conductivity, measuring range, etc.?
- Is the serial number of sensor and the connected transmitter the same?
- Does the arrow on the sensor nameplate match the actual direction of flow through the pipe?
- Is the position of the measuring electrode plane correct?
- Is the position of the empty pipe detection electrode correct?
- Were all screws tightened to the specified torques when the sensor was installed?
- Were the correct seals used (type, material, installation)?
- Are the measuring point number and labeling correct (visual inspection)?
- Were the inlet and outlet runs respected?
 - Inlet run $\geq 5 \times \text{DN}$
 - Outlet run $\geq 2 \times \text{DN}$
- Is the measuring device protected against moisture and direct sunlight?
- Is the sensor adequately protected against vibration (attachment, support)?
Acceleration up to 2 g by analogy with IEC 600 68-2-8

3 Wiring

Warning!

Risk of electric shock! Components carry dangerous voltages.

- Never mount or wire the measuring device while it is connected to the power supply.
- Before connecting the power supply, check the safety equipment.
- Route the power supply and electrode cables so they are securely seated.
- Seal the cable entries and covers tight.

Caution!

Risk of damaging the electronic components!

- Connect the power supply in accordance with the connection data on the nameplate.
- Connect the electrode cable in accordance with the connection data in the Operating Instructions or the Ex documentation on the CD-ROM.

In addition, for the remote version:

Caution!

Risk of damaging the electronic components!

- Only connect sensors and transmitters with the same serial number.
- Observe the cable specifications of the connecting cable → Operating Instructions on the CD-ROM.

Note!

Install the connecting cable securely to prevent movement.

In addition, for measuring devices with fieldbus communication:

Caution!

Risk of damaging the electronic components!

- Observe the cable specification of the fieldbus cable → Operating Instructions on the CD-ROM.
- Keep the stripped and twisted lengths of cable shield as short as possible.
- Screen and ground the signal lines → Operating Instructions on the CD-ROM.
- When using in systems without potential equalization → Operating Instructions on the CD-ROM.

In addition, for Ex-certified measuring devices:

Warning!

When wiring Ex-certified measuring devices, all the safety instructions, wiring diagrams, technical information etc. of the related Ex documentation must be observed → Ex documentation on the CD-ROM.

3.1 Connecting the various housing types

Wire the unit using the terminal assignment diagram inside the cover.

3.1.1 Compact version

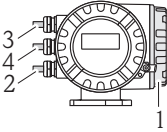

A0007545

Transmitter connection:

- 1 Connection diagram inside the connection compartment cover
- 2 Power supply cable
- 3 Electrode cable or fieldbus cable
- 4 Optional

3.1.2 Remote version (transmitter): non-Ex Zone, Ex Zone 2, Class I Div. 2

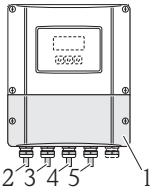

A0007546

Transmitter connection:

- 1 Connection diagram inside the connection compartment cover
- 2 Power supply cable
- 3 Electrode cable
- 4 Fieldbus cable

Connecting the connecting cable (→ 29 ff.):

- 5 Sensor/transmitter connecting cable

3.1.3 Remote version (sensor)

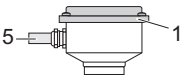

A0008037

Transmitter connection:

- 1 Connection diagram inside the connection compartment cover

Connecting cable connection:

- 5 Sensor/transmitter connecting cable

3.2 Connecting the remote version connecting cable

3.2.1 Connecting cable for Promag S

Connecting cable termination

Terminate the signal and coil current cables as shown in the figure below (Detail A). Fit the fine-wire cores with cable end ferrules (Detail B).

Electrode cable termination

Make sure that the cable end ferrules do not touch the wire shields on the sensor side! Minimum distance = 1 mm (0.04 in), exception "GND" = green cable.

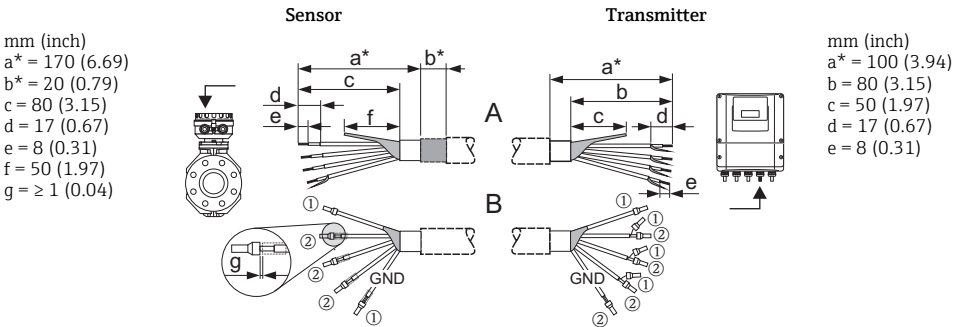

A0008171

Coil current cable termination

Insulate one core of the three-core cable at the level of the core reinforcement; you only require two cores for the connection.

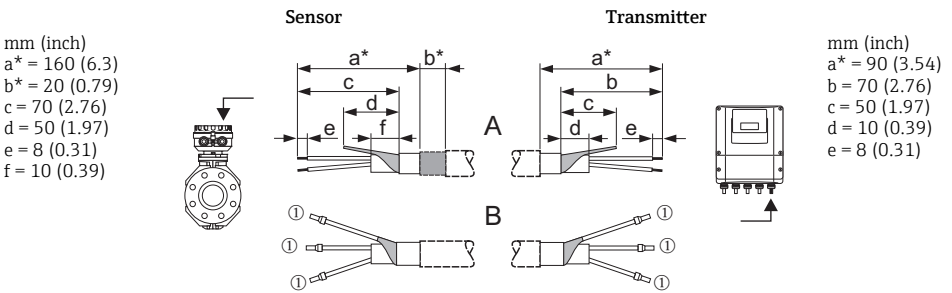

A0008171

3.2.2 Promag H connecting cable

Connecting cable termination

Terminate the signal and coil current cables as shown in the figure below (Detail A).
Fit the fine-wire cores with cable end ferrules (Detail B).

Electrode cable termination

Make sure that the cable end ferrules do not touch the wire shields on the sensor side! Minimum distance = 1 mm (0.04 in), exception "GND" = green cable.

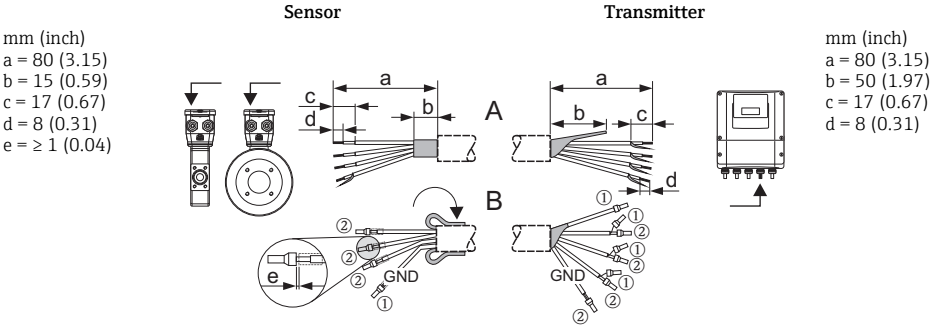

A0008173

Coil current cable termination

Insulate one core of the three-core cable at the level of the core reinforcement; you only require two cores for the connection.

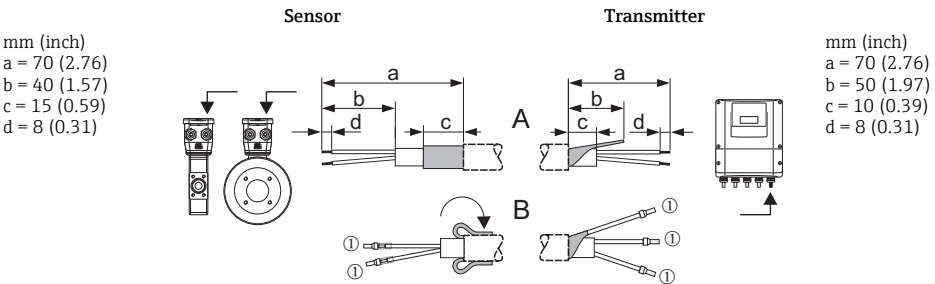

A0008175

3.2.3 Connecting cable connection

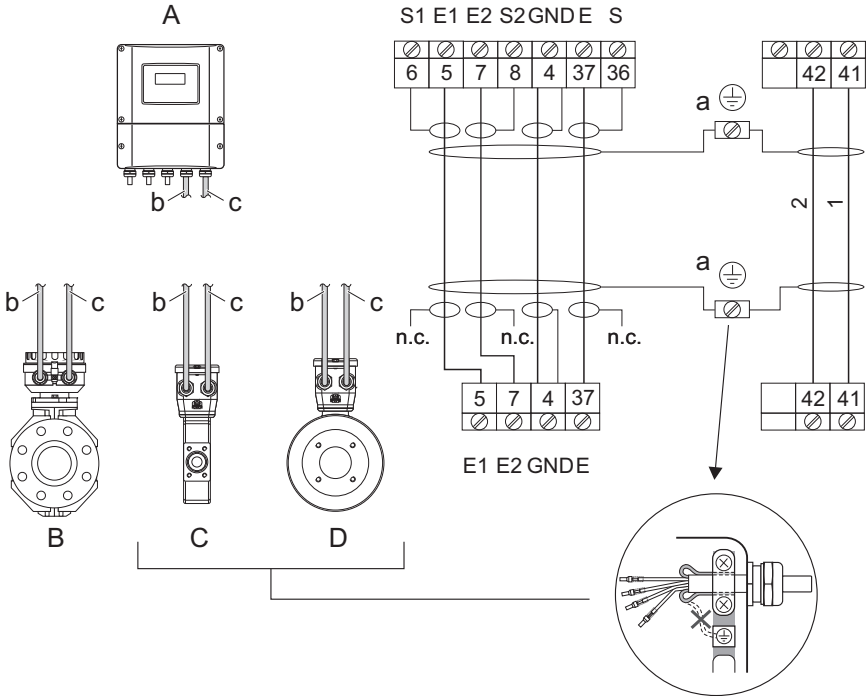

A0008232

- A Wall-mount housing on connection housing, remote version
- BC Sensor connection housing, remote version for Promag S
- D Sensor connection housing, remote version for Promag H, DN ≤ 25
- Sensor connection housing, remote version for Promag H, DN ≥ 40
- a Ground terminals (are provided for potential equalization connection)
- b Coil circuit connecting cable
- c Signal circuit connecting cable (electrodes)
- n.c. = not connected, isolated cable shields

Cable colors for terminal numbers:
 5/6 = brown
 7/8 = white
 4 = green
 36/37 = yellow

3.3 Potential equalization

Perfect measurement is only ensured when the medium and the sensor have the same electrical potential. Most sensors have a reference electrode installed as standard, which guarantees the required potential connection. This usually means that the use of ground disks or other measures are unnecessary.

- Promag S
 - Reference electrode as standard for electrode material: 1.4435 (AISI 316L), Alloy C-22 and tantalum
 - Reference electrode is optional for electrode material Pt/Rh
 - Reference electrode not present in measuring tubes with a lining made of natural rubber.
- Promag H
 - No reference electrode available. There is always an electrical connection to the fluid via the metal process connection.
 - In the case of plastic process connections, potential equalization must be ensured through the use of grounding rings.



Note!

When installing in metal pipes, it is advisable to connect the ground terminal of the transmitter housing to the piping. Pay particular attention to company-internal grounding concepts.

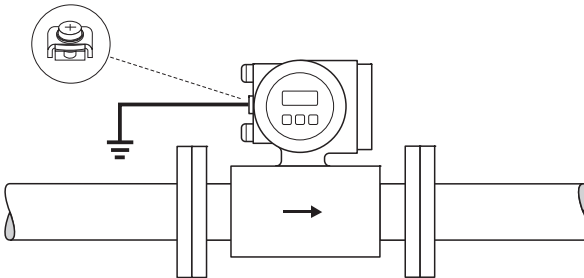

A0004375



Caution!

- For sensors without reference electrodes or without metal process connections, carry out potential equalization as per the instructions for special cases described in the Operating Instructions (see the CD). These special measures are particularly important when standard grounding practice cannot be ensured or extremely strong equalizing currents are expected.
- As sensors with a natural rubber lining do not have a reference electrode, ground disks may have to be mounted to ensure sufficient potential equalization to the fluid. This applies in particular to floating metal pipes.

3.4 Degree of protection

The devices fulfill all the requirements for IP 67 (NEMA 4X).

After mounting in the field or service work, the following points have to be observed to ensure that IP 67 (NEMA 4X) protection is retained:

- Install the measuring device in such a way that the cable entries do not point upwards.
- Do not remove the grommet from the cable entry.
- Remove all unused cable entries and insert blanking or certified plugs instead.
- Use cable entries and drain plugs with a long-term operating temperature range in accordance with the temperature specified on the nameplate.

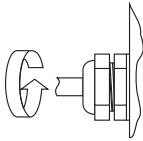

A0007549

Tighten the cable entries correctly.

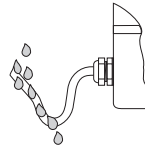

A0007550

The cables must loop down before they enter the cable entries ("water trap").

3.5 Post-connection check

- Are cables or the device damaged (visual inspection)?
- Does the supply voltage match the information on the nameplate?
- Do the cables used comply with the necessary specifications?
- Do the mounted cables have adequate strain relief and are they routed securely?
- Is the cable type route completely isolated? Without loops and crossovers?
- Are all screw terminals firmly tightened?
- Have all the measures for grounding and potential equalization been correctly implemented?
- Are all cable entries installed, firmly tightened and correctly sealed?
- Cable routed as a "water trap" in loops?
- Are all the housing covers installed and securely tightened?

In addition, for measuring devices with fieldbus communication:

- Are all the connecting components (T-boxes, junction boxes, connectors, etc.) connected with each other correctly?
- Has each fieldbus segment been terminated at both ends with a bus terminator?
- Has the max. length of the fieldbus cable been observed in accordance with the specifications?
- Has the max. length of the spurs been observed in accordance with the specifications?
- Is the fieldbus cable fully shielded and correctly grounded?

4 Hardware settings

This section only deals with the hardware settings needed for commissioning. All other settings (e.g. output configuration, write protection, etc.) are described in the associated Operating Instructions on the CD-ROM.



Note!

No hardware settings are needed for measuring devices with HART or FOUNDATION Fieldbus-type communication.

4.1 Device address

Has to be set for measuring devices with the following communication methods:

- PROFIBUS DP/PA

The device address can be configured via:

- Miniature switches → see description below
- Local operation → see **Software settings section** → 41

Addressing via miniature switches



Warning!

Risk of electric shock! Risk of damaging the electronic components!

- All the safety instructions for the measuring device must be observed and all the warnings heeded → 27.
- Use a workspace, working environment and tools purposely designed for electrostatically sensitive devices.



Warnung!

Switch off the power supply before opening the device.

- Loosen the cheese head screw of the securing clamp with an Allen key (3 mm / 0.12 in).
- Unscrew cover of the electronics compartment from the transmitter housing.
- Loosen the securing screws of the display module and remove the onsite display (if present).
- Set the position of the miniature switches on the I/O board using a sharp pointed object.

Installation is the reverse of the removal procedure.

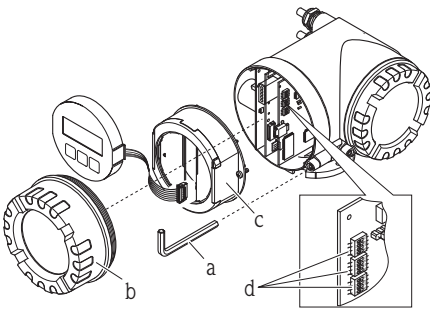

A0007551

PROFIBUS

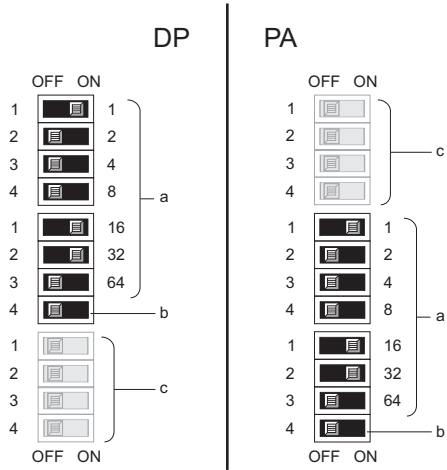

Device address range: 0 to 126
 Factory setting: 126

- a. Miniature switches for device address
 Example shown:
 $1 + 16 + 32 =$ device address 49
- b. Miniature switches for the address mode (method of addressing):
 - OFF (factory setting) = software addressing via local operation/operating program
 - ON = hardware addressing via miniature switches
- c. Miniature switches not assigned.

A0007552

4.2 Terminating resistors

 **Note!**

If the measuring device is used at the end of a bus segment, termination is required. This can be performed in the measuring device by setting the terminating resistors on the I/O board. Generally, however, it is recommended to use an external bus terminator and not perform termination at the measuring device itself.

Has to be set for measuring devices with the following communication methods:

- PROFIBUS DP
 - Baudrate ≤ 1.5 MBaud \rightarrow Termination can be performed at the measuring device, see graphic
 - Baudrate > 1.5 MBaud \rightarrow An external bus terminator must be used

 **Warning!**

Risk of electric shock! Risk of damaging the electronic components!

- All the safety instructions for the measuring device must be observed and all the warnings heeded \rightarrow  27.
- Use a workspace, working environment and tools purposely designed for electrostatically sensitive devices.

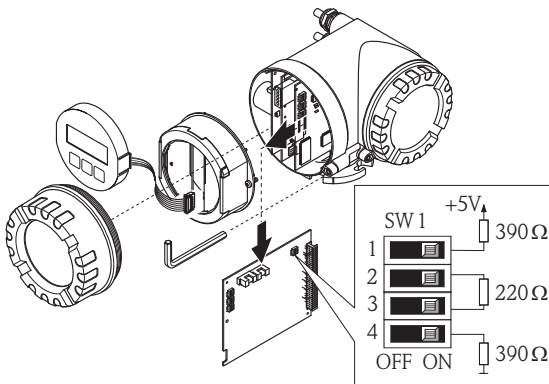

Setting the terminating switch SW1 on the I/O board:
ON - ON - ON - ON

A0007556

5 Commissioning

5.1 Switching on the measuring device

On completion of the installation (successful post-installation check), wiring (successful post-connection check) and after making the necessary hardware settings, where applicable, the permitted power supply (see nameplate) can be switched on for the measuring device.

When the power supply is switched on, the measuring device performs a number of power-up checks and device self-checks. As this procedure progresses the following messages can appear on the onsite display:

Display examples:

PROMAG 55 START-UP RUNNING	Start-up message
▼	
PROMAG 55 DEVICE SOFTWARE V XX.XX.XX	Displays the current software
▼	
CURRENT OUTPUT FREQUENCY OUTPUT RELAY STATUS INPUT	List of input/output modules available
▼	
SYSTEM OK → OPERATION	Beginning of operation

The measuring device starts operating as soon as the startup procedure is complete. Various measured values and/or status variables appear on the display.



Note!

If an error occurs during startup, this is indicated by an error message.

The error messages that occur most frequently when a measuring device is commissioned are described in the Troubleshooting section → 41.

5.2 Operation

5.2.1 Display elements

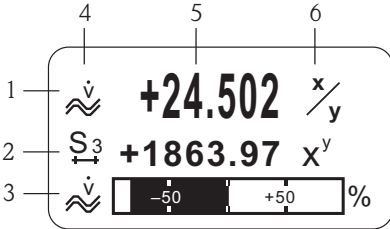

A0007663

Display lines/fields

1. Main line for primary measured values
2. Additional line for additional measured variables/status variables
3. Information line for bar graph display for example
4. Info icons, e.g. volume flow
5. Current measured values
6. Engineering units/time units

5.2.2 Operating elements

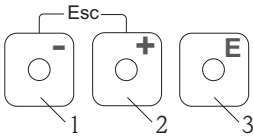

A0007559

Operating keys

1. (-) Minus key for entering, selecting
2. (+) Plus key for entering, selecting
3. Enter key for calling the function matrix, saving

When the +/- keys are pressed simultaneously (Esc):

- Exit the function matrix step-by-step:
- > 3 sec. = cancel data input and return to the measured value display

5.2.3 Displaying error messages

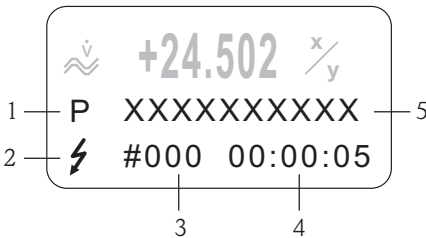

A0007664

1. Type of error:
P = Process error, S = System error
2. Error message type:
⚡ = Fault message, ! = Notice message
3. Error number
4. Duration of the last error that occurred:
Hours: Minutes: Seconds
5. Error designation
 - List of the most common error messages during commissioning → 41
 - List of all error messages, see associated Operating Instructions on the CD-ROM

5.3 Navigating within the function matrix

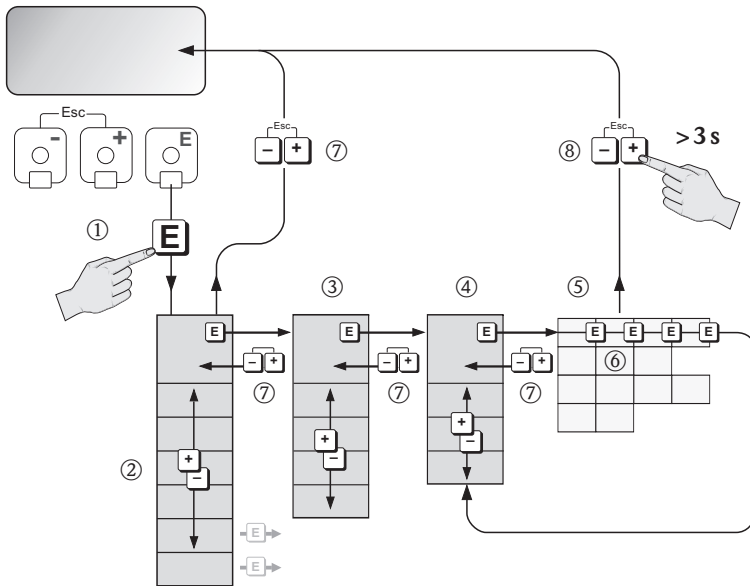

A0007665

1. **E** → Enter the function matrix (starting with measured value display)
2. **+/-** → Select the Block (e.g. USER INTERFACE)
E → Confirm selection
3. **+/-** → Select the group (e.g. CONTROL)
E → Confirm selection
4. **+/-** → Select the function group (e.g. BASIC CONFIGURATION)
E → Confirm selection
5. **E** → Select function (e.g. LANGUAGE)
6. **+/-** → Enter code **55** (only for the first time you access the function matrix)
E → Confirm entry
7. **+/-** → Change function/selection (e.g. ENGLISH)
E → Confirm selection
7. **+/-** → Return to measured value display step by step
8. **+/-** > 3 s → Return immediately to measured value display

5.4 Calling the Commissioning Quick Setup

All the functions needed for commissioning are called up automatically with the Quick Setup. The functions can be changed and adapted to the process in question.

1. \boxed{E} → Enter the function matrix (starting with measured value display)
2. P → Select the group QUICK SETUP
 \boxed{E} → Confirm selection
3. QUICK SETUP COMMISSIONING function appears.
4. Intermediate step if configuration is blocked:
 $\boxed{+}$ → Enter the code **55** (confirm with \boxed{E}) and thus enable configuration
5. $\boxed{+}$ → Go to Commissioning Quick Setup
6. $\boxed{+}$ → Select YES
 \boxed{E} → Confirm selection
7. \boxed{E} → Start Commissioning Quick Setup
8. Configure the individual functions/settings:
 - Via $\boxed{+}$ -key, select option or enter number
 - Via \boxed{E} -key, confirm entry and go to next function
 - Via $\boxed{+}$ -key, return to Setup Commissioning function (settings already made are retained)



Note!

Observe the following when performing the Quick Setup:

- Configuration selection: Select the ACTUAL SETTING option
- Unit selection: This is not offered again for selection after configuring a unit
- Output selection: This is not offered again for selection after configuring an output
- Automatic configuration of the display: select YES
 - Main line = Mass flow
 - Additional line = Totalizer 1
 - Information line = Operating/system conditions
- If asked whether additional Quick Setups should be executed: select NO

All the available functions of the measuring device and their configuration options as well as additional Quick Setups, if available, are described in detail in the "Description of Device Functions" Operating Instructions. The related Operating Instructions can be found on the CD-ROM.

The measuring device is ready for operation on completion of the Quick Setup.

5.5 Software settings

5.5.1 Device address

Has to be set for measuring devices with the following communication methods:

- PROFIBUS DP/PA → device address range 0 to 126, factory setting 126

The device address can be configured via:













- Miniature switches → see Hardware settings →  34
- Local operation → see description below



Note!

The COMMISSIONING SETUP must be executed before setting the device address.

Calling the Communication Quick Setup

1.  → Enter the function matrix (starting with measured value display)
2.  → Select the group QUICK SETUP
 → Confirm selection
3.  → Select the QUICK SETUP COMMUNICATION function
4. Intermediate step if configuration is blocked:  → Enter the code **55**
(confirm with ) and thus enable the configuration
5.  → Go to Communication Quick Setup
6.  → Select YES;  → confirm selection
7.  → Start Communication Quick Setup
8. Configure the individual functions/settings:
 - Via -key, select option or enter number
 - Via -key, confirm entry and go to next function
 - Via -key, return to Setup Commissioning function
(settings already made are retained)

All the available functions of the measuring device and their configuration options as well as additional Quick Setups, if available, are described in detail in the "Description of Device Functions" Operating Instructions. The related Operating Instructions can be found on the CD-ROM.

The measuring device is ready for operation on completion of the Quick Setup.

5.6 Troubleshooting

A complete description of all the error messages is provided in the Operating Instructions on the CD-ROM.



Note!

The output signals (e.g. pulse, frequency) of the measuring device must correspond to the higher-order controller.

www.addresses.endress.com
