

# Brief Operating Instructions

## Proline t-mass 65

Thermal mass flowmeter

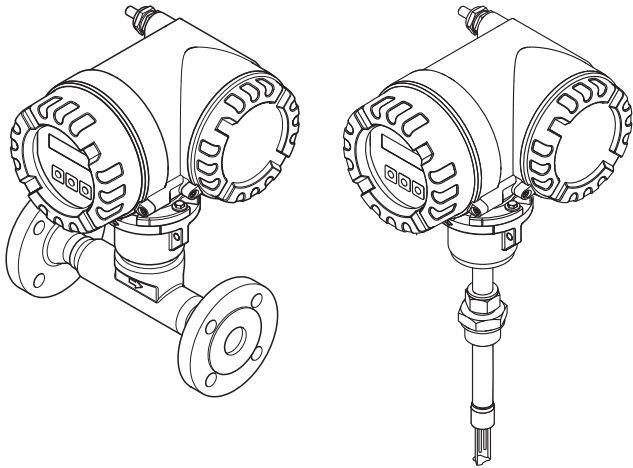

These Brief Operating Instructions are not intended to replace the Operating Instructions provided in the scope of supply. Detailed information about the measuring device is provided in the Operating Instructions and the additional documentation:

- On the CD-ROM supplied (is not included in the delivery for all device versions).
- Available for all measuring device versions via:
  - Internet: [www.endress.com/deviceviewer](http://www.endress.com/deviceviewer)
  - Smartphone/tablet: Endress+Hauser Operations App



# Table of contents

1	Document information	3
1.1	Document conventions	3
2	Basic safety instructions	5
2.1	Requirements for personnel	5
2.2	Designated use	5
2.3	Occupational safety	6
2.4	Operational safety	7
2.5	Product safety	7
3	Installation	8
3.1	Transporting to the measuring point	8
3.2	Installation conditions	8
3.3	Installation	15
3.4	Post-installation check	17
4	Wiring	18
4.1	Connecting the various housing types	19
4.2	Degree of protection	20
4.3	Post-connection check	20
5	Hardware settings	21
5.1	Device address	21
5.2	Terminating resistors	23
6	Commissioning	24
6.1	Switching on the measuring device	24
6.2	Operation	25
6.3	Navigating within the function matrix	26
6.4	Calling the Commission Quick Setup	27
6.5	Software settings	28
6.6	Troubleshooting	29





# 1 Document information

## 1.1 Document conventions









### 1.1.1 Safety symbols

Symbol	Device particularities and document content
 Caution!	<p>"Caution" indicates an action or procedure which, if not performed correctly, can result in incorrect operation or destruction of the device. Comply strictly with the instructions.</p>
 Warning!	<p>"Warning" indicates an action or procedure which, if not performed correctly, can result in injury or a safety hazard. Comply strictly with the instructions and proceed with care.</p>
Note!	<p>"Note" indicates an action or procedure which, if not performed correctly, can have an indirect effect on operation or trigger an unexpected response on the part of the device.</p>



### 1.1.2 Electrical symbols

Symbol	Meaning
 A0011197	<p>Direct current A terminal at which DC voltage is present or through which direct current flows.</p>
 A0011198	<p>Alternating current A terminal at which alternating voltage (sinusoidal) is present or through which alternating current flows.</p>
 A0011200	<p>Ground connection A grounded terminal which, as far as the operator is concerned, is grounded via a grounding system.</p>
 A0011199	<p>Protective ground connection A terminal which must be connected to ground prior to establishing any other connections.</p>
 A0011201	<p>Equipotential connection A connection that must be connected to the plant grounding system: This may be a potential equalization line or a star grounding system depending on national or company codes of practice.</p>

### 1.1.3 Symbols for types of information

Symbol	Meaning
 A0011182	Permitted Indicates procedures, processes or actions that are permitted.
 A0011183	Preferred Indicates procedures, processes or actions that are preferred.
 A0011200	Forbidden Indicates procedures, processes or actions that are forbidden.
 A0011193	Tip Indicates additional information.
 A0011194	Reference to documentation Refers to the corresponding device documentation.
 A0011195	Reference to page Refers to the corresponding page number.
1., 2., 3. etc.	Series of steps
	Result of a sequence of actions
 A0013562	Help in the event of a problem

### 1.1.4 Symbols for graphics

Symbol	Meaning
1, 2, 3 etc.	Item numbers
A, B, C etc.	Views
A-A, B-B, C-C etc.	Item numbers
 A0013441	Flow direction
 A0011187	Hazardous area Indicates the hazardous area.
 A0011187	Safe area (non-hazardous area) Indicates the non-hazardous area.

## 2 Basic safety instructions

### 2.1 Requirements for personnel

The personnel must fulfill the following requirements for its tasks:

- Trained, qualified specialists must have a relevant qualification for this specific function and task.
- Are authorized by the plant owner/operator.
- Are familiar with federal/national regulations.
- Before beginning work, the specialist staff must have read and understood the instructions in the Operating Instructions and supplementary documentation as well as in the certificates (depending on the application).
- Follow instructions and comply with conditions.

### 2.2 Designated use

#### Application and media

The measuring device described in this manual is solely intended for the flow measurement of gases.

To ensure that the measuring device remains in proper operating condition for its service life:

- Only use the measuring device in full compliance with the data on the nameplate and the general conditions listed in the Operating Instructions and supplementary documentation.
- Using the nameplate, check whether the ordered device is permitted for the intended use in the hazardous area (e.g. explosion protection, pressure vessel safety).
- Use the measuring device only for media to which the materials in contact with the process have adequate resistance.

#### Incorrect use

The manufacturer is not liable for damage caused by improper or non-designated use.

If the compression fitting is opened, the accuracy specifications of the measuring device no longer apply. In such situations, the measuring device must be removed and returned for recalibration and to the manufacturer.



Warning!

**Risk of injury if the process connection and compression fitting are opened under pressure.**

- The process connection and the compression fitting should only be opened in an unpressurized state.

Note!

**Penetration of dust and moisture when the transmitter housing is opened.**

- Only open the transmitter housing briefly, ensuring that no dust or moisture enters the housing.

Note!

**Corrosive or abrasive media can break the sensor!**

- Verify the compatibility of the process medium with the sensor.
- Ensure the resistance of all wetted materials in the process.
- Observe the specified maximum process pressure.

Clarification of borderline cases:

- With regard to special fluids and media used for cleaning, Endress+Hauser will be happy to assist in clarifying the corrosion-resistant properties of wetted materials but gives no guarantee or warranty as to the suitability of the materials.

**Residual risks**

Due to the power throughput in the electronic components, the outer housing surfaces can heat up by a maximum of 15 K. Hot process media passing through the measuring tube will further increase the surface temperature of the housing. In the case of the sensor, in particular, users should expect temperatures that can be close to the medium temperature.

Hot media can present a burn hazard!

- For elevated medium temperatures, ensure adequate protection against contact to prevent burns.

## 2.3 Occupational safety

When working on or with the device:

- Wear the required personal protective equipment according to federal/national regulations.

When performing welding work on the pipe:

- Do not ground the welding unit via the measuring device.

When handling batteries:

- The device is powered by lithium-thionyl chloride high-power batteries. This has implications for occupational safety and storage.

 Warning!

Lithium-thionyl chloride high-power batteries are categorized as Class 9:

"Miscellaneous Hazardous Materials". Comply strictly with the hazardous material regulations described in the safety data sheet.

You can request the safety data sheet from your Endress+Hauser Sales Center.

## 2.4 Operational safety

Risk of injury!

- Only operate the device if it is in a perfect technical condition free from errors and faults.
- The operator is responsible for the trouble-free operation of the device.

### Modifications to the device

Unauthorized modifications to the device are not permitted and can lead to unforeseeable dangers:

- If, despite this, modifications are required, consult with Endress+Hauser.

### Repair

To ensure continued operational safety and reliability:

- Only perform repair work on the device if this is expressly permitted.
- Comply strictly with national regulations concerning the repair of electrical equipment.
- Use genuine spare parts and accessories from Endress+Hauser only.

### Hazardous area

To rule out any danger to people or the plant when operating the device in a hazardous area:

- Using the information on the nameplate, check whether the ordered device is permitted for the intended use in the hazardous area.

## 2.5 Product safety

This measuring device is designed in accordance with good engineering practice to meet state-of-the-art safety requirements, has been tested, and left the factory in a condition in which it is safe to operate.

It meets general safety standards and legal requirements. It also complies with the EC directives listed in the device-specific EC Declaration of Conformity. Endress+Hauser confirms this by affixing the CE mark to the device.

## 3 Installation

### 3.1 Transporting to the measuring point

- Transport the measuring device to the measuring point in the original packaging.
- The covers or caps fitted on the process connections prevent mechanical damage to the sensors during transport and storage. For this reason, do not remove the covers or caps until immediately before installation.

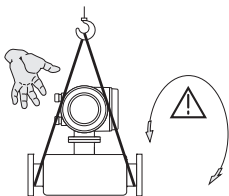

Use slings around the process connections.

**Warning!**  
Risk of injury! The device can slip.  
The center of gravity of the measuring device may be higher than the holding points of the slings.  
Always ensure that the measuring device cannot slip or turn around its axis.

A0007408

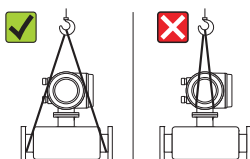

Do not lift measuring devices by the transmitter housing or the connection housing in the case of the remote version. Do not use chains as they could damage the housing.

A0007409

### 3.2 Installation conditions

- The thermal dispersion principle is sensitive to disturbed flow conditions. Therefore, the requirements and conditions for installation in this section are especially important.
- Take measures to reduce or avoid condensation (e.g. install a condensation trap, thermal insulation, etc.).

#### 3.2.1 Dimensions

For the dimensions of the measuring device → see associated Technical Information on the CD-ROM.



### 3.2.2 Pipework requirements

Good engineering practice should be followed at all times. Further information is provided in ISO Standard 14511.





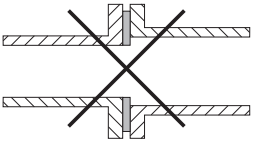
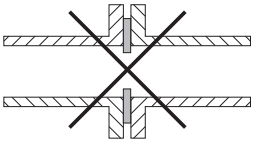
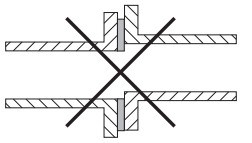





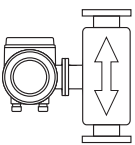
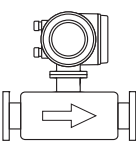
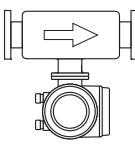



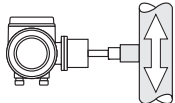
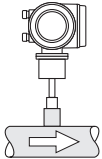
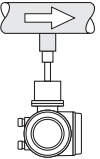

Note!

Measuring errors will result due to a mismatch of the pipes or gaskets.

Avoid					
					
A0007520		A0007521		A0007522	
Pipe diameter one is not equal to pipe diameter two		Incorrectly sized gaskets		Incorrectly aligned Flanges and gaskets	

### 3.2.3 Orientation

Make sure that the direction arrow on the sensor matches the direction of gas flow through the pipe.

Flanged version					
					
A0007512		A0007514		A0007515	
compact	remote	compact	remote	compact	remote
 ①	 ①			 ③	 ③
Insertion version					
					
A0007516		A0007517		A0007518	
compact	remote	compact	remote	compact	remote
 ① ②	 ①			 ③	 ③
<p>  = Recommended orientation</p> <p> = Orientation recommended in certain situations</p> <p>①...③ = See following description</p>					

- ① In the case of saturated or unclean gases, upward flow in a vertical pipe section is preferred to minimize condensation/contamination.
- ② Not recommended if the vibrations are too high or if the installation is unstable.
- ③ Only suitable for clean/dry gases. Do not select this orientation if the gas is very wet or saturated with water (e. g. biogas, undried compressed air). Use the orientation as illustrated below ( $\alpha = \text{approx. } 135^\circ \pm 10^\circ$ ).

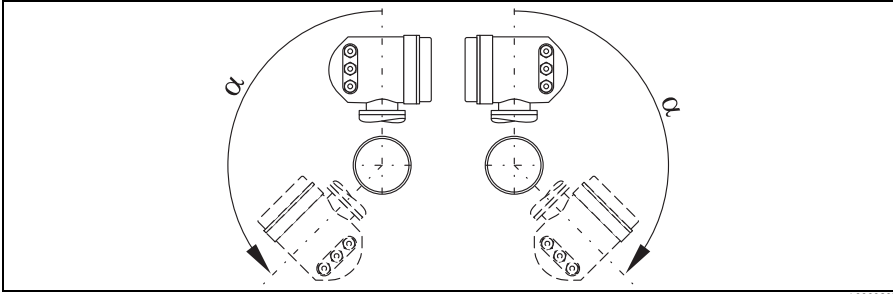

A0009897

### 3.2.4 Inlet/outlet runs

The thermal dispersion principle is sensitive to disturbed flow conditions.

As a general rule, the installed thermal flow sensor should always be installed as far away as possible from any flow disturbances. For further information → ISO Standard 14511.

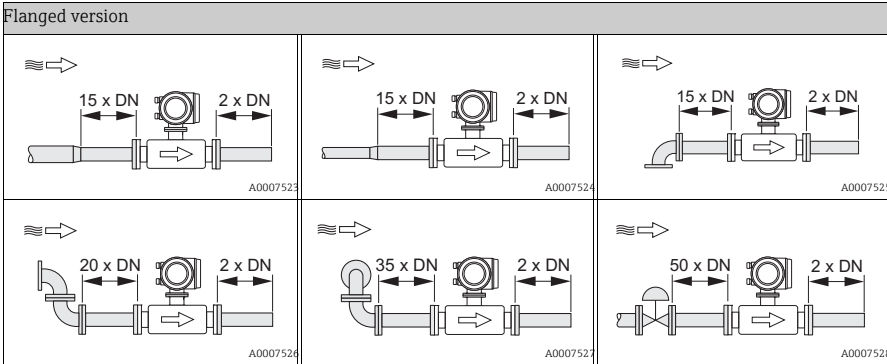

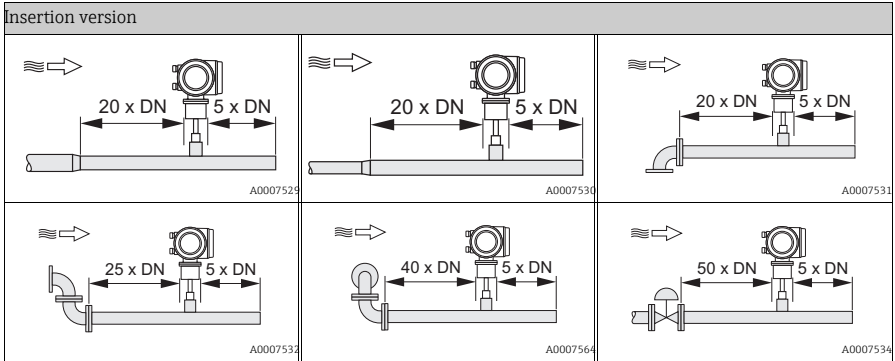

**Inlet run**

15 x DN for the flanged version and 20 x DN for the insertion version

**Outlet run**

2 x DN for the flanged version and 5 x DN for the insertion version

**Note!**

- Where two or more flow disturbances are located upstream of the meter, the longest indicated inlet length should prevail. For example if a control valve is additionally mounted upstream from the measuring device and an elbow on the inlet side, select the recommended inlet length for control valves:  
50 × DN
- For very light gases such as helium and hydrogen, double the recommended inlet length.
- A specially designed perforated plate flow conditioner can be installed if it is not possible to observe the inlet runs required.  
Please refer to the Operating Instructions on the CD-ROM for special details on the perforated plate flow conditioner.

**3.2.5 Mounting conditions for the insertion version**

**Mounting conditions for welding sockets**

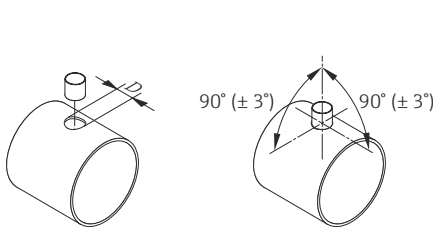

A0011843

**Caution!**  
When mounting the fitting to a thin wall duct, use a suitable support bracket for the sensor.

$D = \varnothing 31.0 \text{ mm} \pm 0.5 \text{ mm} (1.22 \pm 0.019")$

### Adjustment of the insertion version

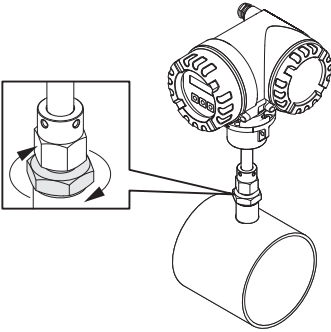

A0011888

Insert the sensor into the socket and tighten the lower nut of compression fitting first by hand and then tighten it 1¼ revolutions using a wrench (42 mm).



**Caution!**

- NPT thread: use a thread sealing tape or paste
- G1A thread: the sealing ring supplied must be installed

### Insertion depth calculation

Note!

- All the guidelines and information on the insertion depth refer to a standard welding nozzle provided by Endress+Hauser.
- For detailed remarks on calculation refer to Technical Information on the CD-ROM.

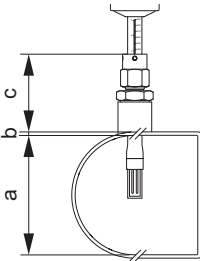

A0011844

- a. Internal diameter for round pipes.  
Duct height for a duct if the sensor is to be installed vertically or the duct width if it is to be installed horizontally.  
(a = min. 80 mm (3 in))
- b. Thickness of the pipe wall or duct wall
- c. Depth of the welding nozzle at the pipe or duct including the sensor pipe union and the hot tap or cold tap (if used).
- d. Calculated insertion depth:  
(0.3 × a) + b + c + 2 mm (0.08 in)

Insertion depth calculation with Quick Setup "Sensor".

The following data are needed for insertion depth calculation:

Round pipes	Duct
<ul style="list-style-type: none"> <li>■ Pipe standard (DIN, ANSI or others)</li> <li>■ Nominal diameter</li> <li>■ Outer diameter</li> <li>■ Thickness</li> <li>■ Internal diameter (min. 80 mm (3 in))</li> </ul>	<ul style="list-style-type: none"> <li>■ Duct height</li> <li>■ Duct width</li> <li>■ Thickness</li> <li>■ Mounting orientation (installed vertically or horizontally)</li> </ul>

## Aligning the calculated insertion depth

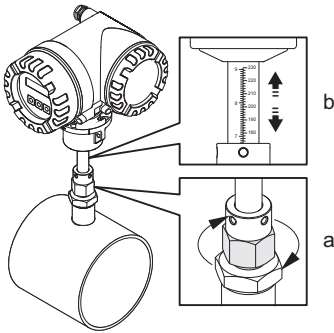

A0011848

- a. Tighten the upper nut of compression fitting such that the sensor can still be adjusted.
- b. Align the scale to the calculated insertion depth.

## Aligning the insertion version to flow direction

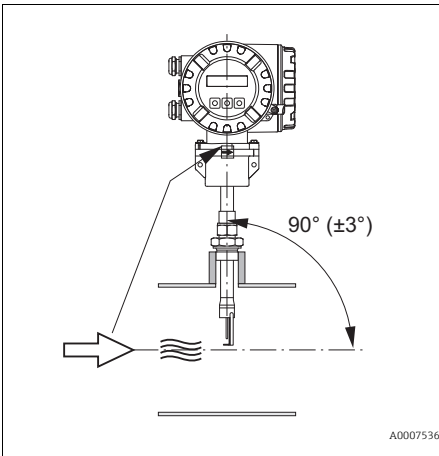

A0007536

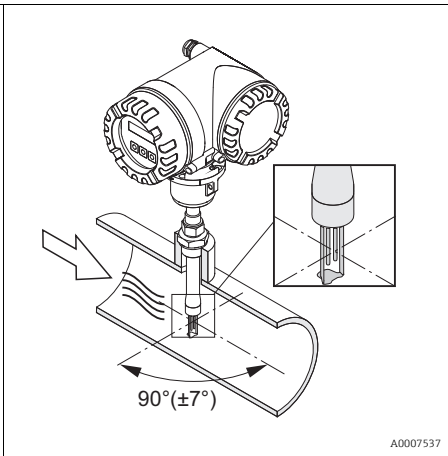

A0007537

- a. Check and ensure that the sensor is aligned at a  $90^\circ$  angle to the flow direction on the pipe/duct.
- b. Turn the sensor so that the arrow marking matches the direction of flow.

## To fix the insertion version

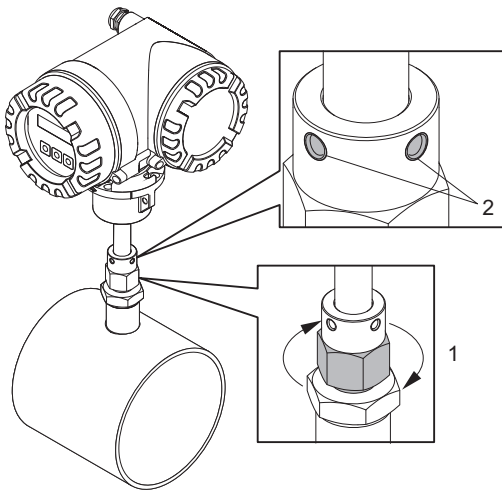

- a. Tighten the compression fitting (1) by hand to secure the position of the sensor. Then, using an open-ended wrench (36 mm), tighten another  $1\frac{1}{4}$  revolutions in a clockwise direction.
- b. Fix the two securing screws (2) (Allen screw 3 mm;  $1/8''$ ).

 **Warning!**  
Observe torque: 4 Nm (2.95 lbf ft)

- c. Check that the sensor and transmitter do not turn.
- d. Check the measuring point for leaks at the maximum operating pressure.

A0010114

### 3.2.6 Heating

For information on the heating, please see the Operating Instructions on the CD-ROM.

### 3.2.7 Thermal insulation

For information on the thermal insulation, please see the Operating Instructions on the CD-ROM.

### 3.2.8 Vibrations

 **Caution!**

Excessive vibration can result in mechanical damage to the measuring device and its mounting.

For further information on vibrations, please see the Operating Instructions on the CD-ROM.

### 3.3 Installation

#### 3.3.1 Turning the aluminum field housing

Aluminum field housing for non-Ex area

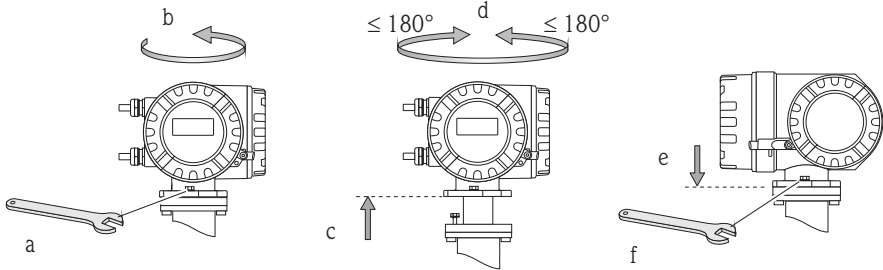

A0007540

Aluminum field housing for Zone 1 or Class I Div. 1

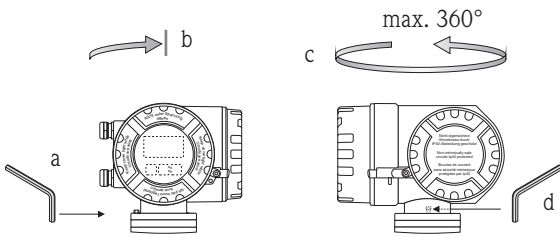

A0008036

- a. Release the setscrew.
- b. Turn the transmitter housing gently clockwise until the stop (end of the thread).
- c. Turn the transmitter counterclockwise (max. 360°) to the desired position.
- d. Retighten the setscrew.

#### 3.3.2 Turning the local display

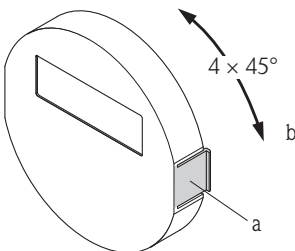

A0007541

- a. Press in the side latches on the display module and remove the module from the cover plate of the electronics compartment.
- b. Turn the display to the desired position (max. 4 x 45° in both directions) and reset it onto the cover plate of the electronics compartment.

### 3.3.3 Installing the wall-mount housing

 Caution!

- Make sure that the ambient temperature does not exceed the permitted range.
- Always install the wall-mount housing in such a way that the cable entries point downwards.

Mounted directly on the wall

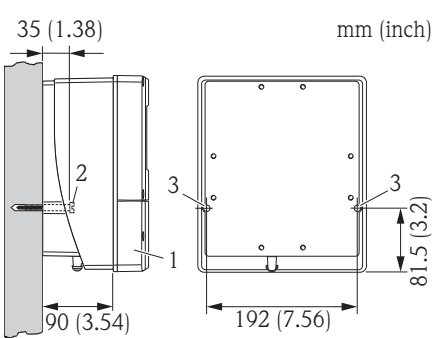

A0007542

Pipe mounting

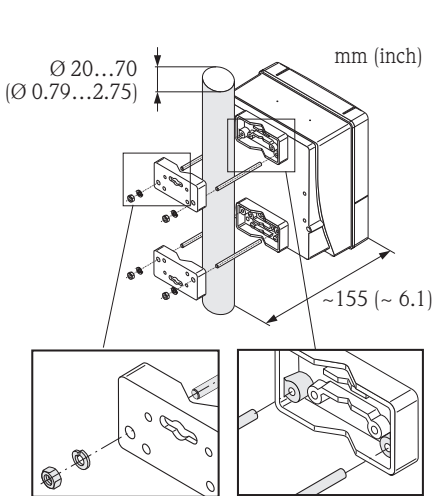

A0007543

 Caution!  
 Danger of overheating! If the device is mounted on a warm pipe, make sure that the housing temperature does not exceed +60 °C (+140 °F) which is the maximum temperature permitted.



## Panel mounting

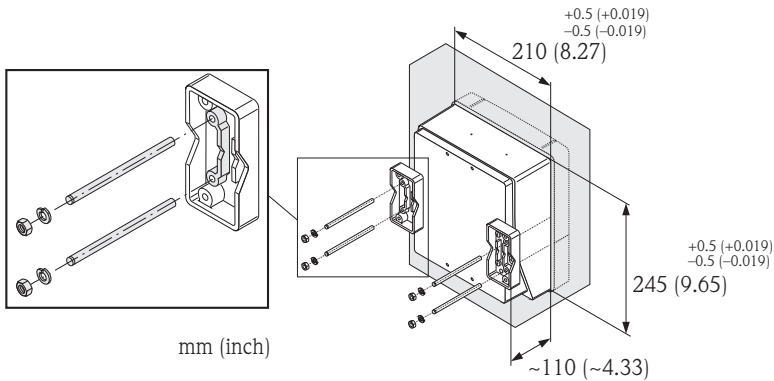

A0007544

### 3.4 Post-installation check

- Is the measuring device undamaged (visual inspection)?
- Does the device correspond to specifications at the measuring point?
- Is the serial number of sensor and the connected transmitter the same?
- Are the measuring point number and labeling correct (visual inspection)?
- Professional installation (correct pipe internal diameter, correctly sized gaskets)?
- Is the alignment of pipe/gasket/flowmeter body correct?
- Has the correct sensor orientation been selected in terms of type, fluid properties, fluid temperature?
- Does the arrow on the sensor point in the direction of the flow in the pipe?
- Are sufficient inlet and outlet runs available before and after the measuring point?
- Is flow conditioner correctly installed (if available)?
- Is the sensor immersion depth (only insertion version) correct?
- Is the measuring device protected against moisture and sunlight?
- Is the measuring device protected against overheating?
- Is the measuring device protected against excessive vibrations?
- Have the gas conditions been checked for purity, cleanliness and dryness?

## 4 Wiring

### Warning!

Risk of fatal injury from electric shock!

- Never mount or wire the measuring device while it is connected to the power supply.
- Prior to connecting the power supply, connect the protective ground to the ground terminal on the housing.

### Caution!

Risk of damaging the electronic components!

Connect the power supply in accordance with the specifications on the diagram inside the connection compartment cover.

### **Additionally for the remote version:**

#### Caution!

Risk of damaging the electronic components!

- Maximum cable length: 100 m (328 ft)
- Observe the cable specifications of the connecting cable → Operating Instructions on the CD-ROM.

Note!

Install the connecting cable securely to prevent movement.

### **Additionally for measuring devices with fieldbus communication:**

#### Caution!

Risk of damaging the electronic components!

- Observe the cable specification of the fieldbus cable → Operating Instructions on the CD-ROM.
- Keep the stripped and twisted lengths of cable shield as short as possible.
- Shield and ground the signal cables → Operating Instructions on the CD-ROM.
- When using in systems without potential matching → Operating Instructions on the CD-ROM.

### **Additionally for Ex-certified measuring devices:**

#### Warning!

When wiring Ex-certified measuring devices, all the safety instructions, wiring diagrams, technical information etc. of the related Ex documentation must be observed

→ Ex documentation on the CD-ROM.

## 4.1 Connecting the various housing types

Wire the unit using the terminal assignment diagram inside the cover.

### 4.1.1 Compact version (transmitter)

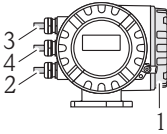

A0007545

Transmitter connection:

- 1 Connection diagram inside the connection compartment cover
- 2 Power supply cable
- 3 Signal cable or fieldbus cable
- 4 Optional

### 4.1.2 Remote version (transmitter)

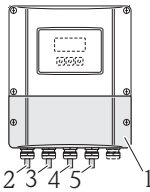

A0007546

Transmitter connection:

- 1 Connection diagram inside the connection compartment cover
- 2 Power supply cable
- 3 Signal cable
- 4 Fieldbus cable

Connecting cable connection:

- 5 Sensor/transmitter connecting cable

### 4.1.3 Remote version (transmitter)

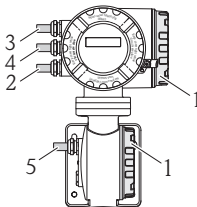

A0007547

Transmitter connection:

- 1 Connection diagram inside the connection compartment cover
- 2 Power supply cable
- 3/4 Signal cable or fieldbus cable

Connecting cable connection:

- 5 Sensor/transmitter connecting cable

### 4.1.4 Remote version (sensor)

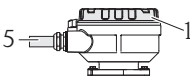

A0007548

Transmitter connection:

- 1 Connection diagram inside the connection compartment cover

Connecting cable connection:

- 5 Sensor/transmitter connecting cable

## 4.2 Degree of protection

The measuring devices fulfill all the requirements of IP67 (NEMA 4X).

After mounting in the field or after service work, the following points have to be observed to ensure that IP67 (NEMA 4X) protection is retained:

- Install the measuring device in such a way that the cable entries do not point upwards.
- Do not remove the grommet from the cable entry.
- Remove all unused cable entries and insert blanking or certified plugs instead.
- Use cable entries and drain plugs with a long-term operating temperature range in accordance with the temperature specified on the nameplate.

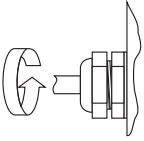

Tighten the cable entries correctly.

A0007549

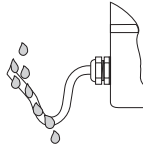

The cables must loop down before they enter the cable entries ("water trap").

A0007550

## 4.3 Post-connection check

- Is the measuring device or cable undamaged (visual inspection)?
- Does the supply voltage match the specifications on the nameplate?
- Are the power supply and signal cables correctly connected?
- Do the cables used comply with the necessary specifications?
- Do the mounted cables have adequate strain relief?
- Cables correctly segregated by type? Without loops and crossovers?
- Are all screw terminals firmly tightened?
- Are all the cable entries installed, correctly tightened and firmly sealed?
- Cables looped as "water traps"?
- Are all housing covers installed and correctly tightened?

Additionally for measuring devices with fieldbus communication:

- Are all the connecting components (T-boxes, junction boxes, connectors, etc.) connected with each other correctly?
- Has each fieldbus segment been terminated at both ends with a bus terminator?
- Has the max. length of the fieldbus cable and the spurs been observed in accordance with the specifications?
- Is the fieldbus cable fully shielded and correctly grounded?

## 5 Hardware settings

This section only deals with the hardware settings needed for commissioning. All other settings (e.g. output configuration, write protection, etc.) are described in the associated Operating Instructions on the CD-ROM.

Note!

No hardware settings are needed for commissioning on measuring devices with HART or FOUNDATION Fieldbus-type communication.

### 5.1 Device address

Has to be set for measuring devices with the following communication methods:

- PROFIBUS DP/PA
- Modbus RS485

The device address can be configured via:

- Miniature switches → see description below
- Local operation → see software settings section

#### Addressing via miniature switches

 Warning!

Risk of electric shock! Risk of damaging the electronic components!

- All the safety instructions for the measuring device must be observed and all the warnings heeded →  3.
- Use a workspace, working environment and tools purposely designed for electrostatically sensitive devices.

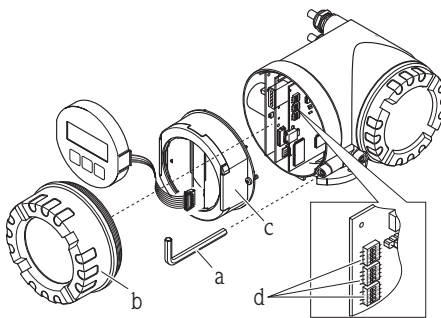

A0007551

 Warning!

Switch off the power supply before opening the measuring device.

- a. Loosen the cheese head screw of the securing clamp with an Allen key (3 mm)
- b. Unscrew cover of the electronics compartment from the transmitter housing.
- c. Loosen the securing screws of the display module and remove the onsite display (if present).
- d. Set the position of the miniature switches on the I/O board using a sharp pointed object.

Installation is the reverse of the removal procedure.

PROFIBUS DP/PA

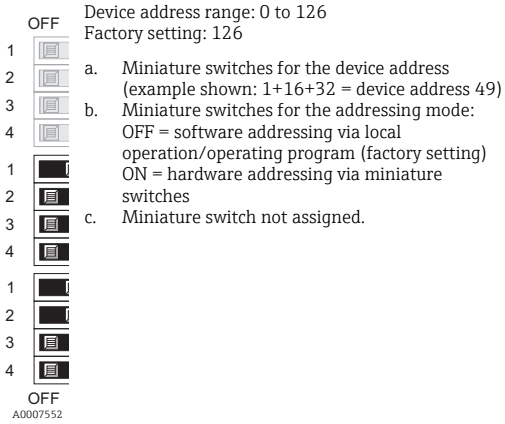
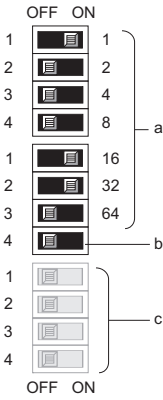

Modbus RS485

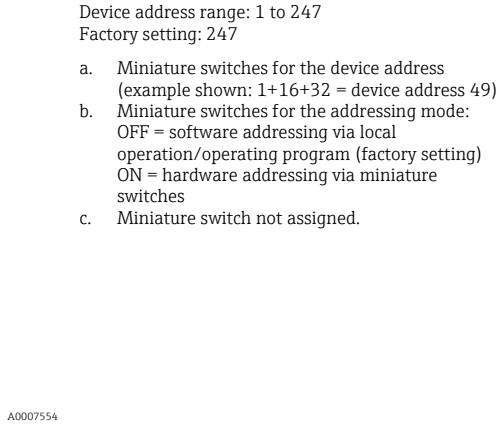
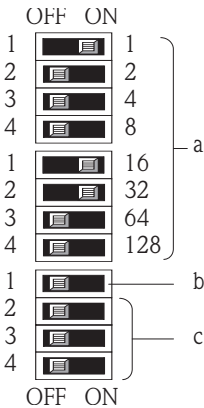

## 5.2 Terminating resistors

Note!

If the measuring device is used at the end of a bus segment, termination is required. This can be performed in the measuring device by setting the terminating resistors on the I/O board. Generally, however, it is recommended to use an external bus terminator and not perform termination at the measuring device itself.

Terminating resistors must be connected for measuring devices with the following types of communication:

- PROFIBUS DP
  - Baud rate  $\leq 1.5$  MBaud → Termination can be performed at the measuring device (see the following graphic)
  - Baud rate  $> 1.5$  MBaud → An external bus terminator must be used
- Modbus RS485 → Termination can be performed at the measuring device (see the following graphic)

 Warning!

Risk of electric shock! Risk of damaging the electronic components!

- All the safety instructions for the measuring device must be observed and all the warnings heeded →  3.
- Use a workspace, working environment and tools purposely designed for electrostatically sensitive devices.

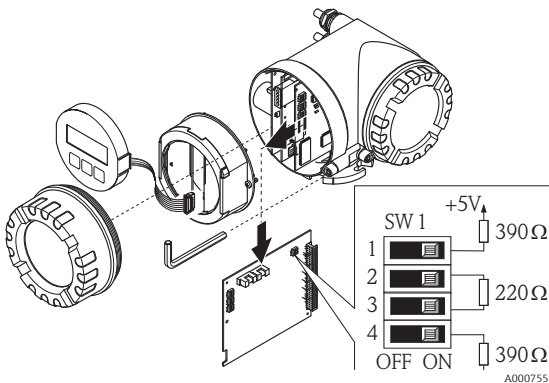

Setting the terminating switch  
SW1 on the I/O board:  
ON - ON - ON - ON

## 6 Commissioning

### 6.1 Switching on the measuring device

On completion of the installation (successful post-installation check), wiring (successful post-connection check) and after making the necessary hardware settings, where applicable, the permitted power supply (see nameplate) for the measuring device can be switched on.

When the power supply is switched on, the measuring device performs a number of power-up checks and device self-checks. As this procedure progresses the following messages can appear on the local display:

Display examples:

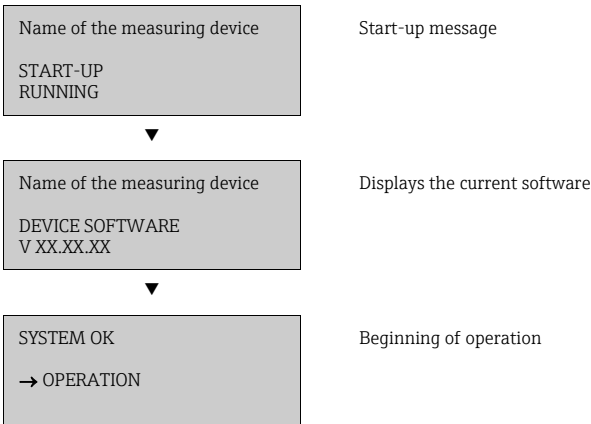

The measuring device starts operating as soon as the startup procedure is complete. Various measured values and/or status variables appear on the display.

#### Note!

If an error occurs during startup, this is displayed by an error message. The error messages that occur most frequently when a measuring device is commissioned are described in the Troubleshooting section →  29.



## 6.2 Operation

### 6.2.1 Display elements

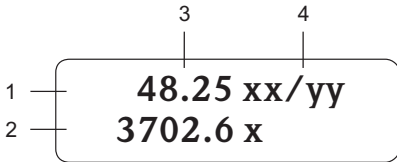

A0011838

Display lines/fields

1. Main line for primary measured values
2. Additional line for additional measured variables/status variables
3. Current measured values
4. Engineering units/time units

### 6.2.2 Operating elements

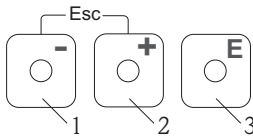

A0007559

Operating keys

1. (-) Minus key for entering, selecting
2. (+) Plus key for entering, selecting
3. Enter key for calling the function matrix, saving

When the +/- keys are pressed simultaneously (Esc):

- Exit the function matrix step-by-step:
- > 3 sec. = cancel data input and return to the measured value display

### 6.2.3 Displaying error messages

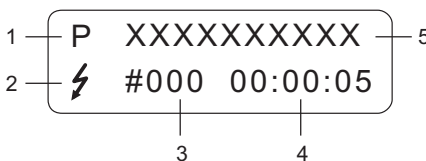

A0007561

1. Type of error:  
P = Process error, S = System error
2. Error message type:  
⚡ = Fault message, ! = Notice message
3. Error number
4. Duration of the last error that occurred:  
Hours: Minutes: Seconds
5. Error designation

- List of the most common error messages during commissioning → 29
- List of all error messages, see associated Operating Instructions on the CD-ROM

## 6.3 Navigating within the function matrix

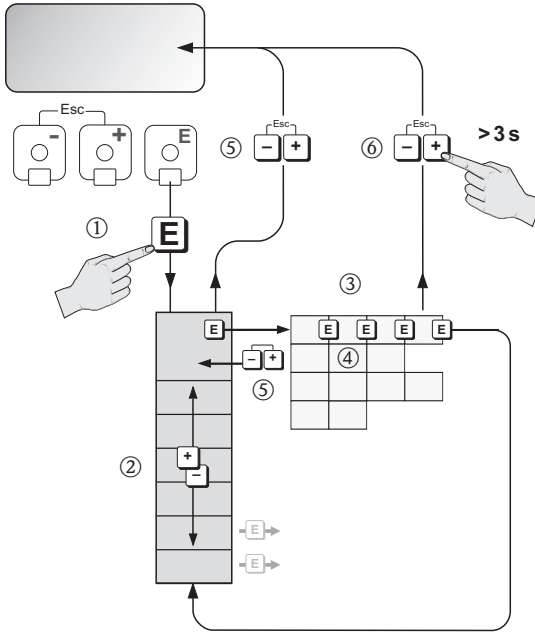

A0007562

1. → Enter the function matrix (starting with measured value display)
2. → Select the group (e.g. OPERATION)  
 → Confirm selection
3. → Select function (e.g. LANGUAGE)
4. → Enter code **65** (only for the first time you access the function matrix)  
 → Confirm entry
- Change function/selection (e.g. ENGLISH)  
 → Confirm selection
5. → Return to measured value display step by step
6. > 3 s → Return immediately to measured value display

## 6.4 Calling the Commission Quick Setup

All the functions needed for commissioning are called up automatically with the Quick Setup. The functions can be changed and adapted to the process in question.

1.  → Enter the function matrix (starting with measured value display)
2.  → Select the group QUICK SETUP  
 → Confirm selection
3. QUICK SETUP COMMISSION function appears.
4. Intermediate step if configuration is blocked:  
 → Enter the code **65** (confirm with  ) and thus enable configuration
5.  → Go to Commission Quick Setup
6.  → Select YES  
 → Confirm selection
7.  → Start Commission Quick Setup
8. Configure the individual functions/settings:
  - Via -key, select option or enter number
  - Via -key, confirm entry and go to next function
  - Via -key, return to Quick Setup Commission function (settings already made are retained)

Note!

Observe the following when performing the Quick Setup:

- Configuration selection: select the "Actual Settings" option
- Unit selection: This is not offered again for selection after configuring a unit
- Output selection: This is not offered again for selection after configuring an output
- Automatic configuration of the display: select "YES"
  - Main line = Mass flow
  - Additional line = Totalizer 1
- If asked whether additional Quick Setups should be executed: select "YES"

All the available functions of the measuring device and their configuration options as well as additional Quick Setups, if available, are described in detail in the "Description of Device Functions" Operating Instructions. The related Operating Instructions can be found on the CD-ROM.

The measuring device is ready for operation on completion of the following Quick Setups: Commission, Sensor (only t-mass 65I), Gas, Pressure, Heat Flow (if used)

## 6.5 Software settings

### 6.5.1 Device address

Has to be set for measuring devices with the following communication methods:

- PROFIBUS DP/PA  
Device address range 0 to 126, factory setting 126
- Modbus RS485  
Device address range 1 to 247, factory setting 247















The device address can be configured via:

- Miniature switches → see Hardware settings section
- Local operation → see "Calling the Communication Quick Setup"

Note!

The COMMISSIONING SETUP must be executed before setting the device address.

### Calling the Communication Quick Setup

1.  → Enter the function matrix (starting with measured value display)
2.  → Select the group QUICK SETUP  
 → Confirm selection
3.  → Select the QUICK SETUP COMMUNICATION function
4. Intermediate step if configuration is blocked:  
 → Enter the code **65** (confirm with  ) and thus enable configuration
5.  → Go to Quick Setup Communication
6.  → Select YES  
 → Confirm selection
7.  → Start Quick Setup Communication
8.  → Select YES  
 → Confirm selection
9. Configure the individual functions/settings:
  - Via -key, select option or enter number
  - Via -key, confirm entry and go to next function
  - Via -key, return to Quick Setup Commission function  
(settings already made are retained)

All the available functions of the measuring device and their configuration options as well as additional Quick Setups, if available, are described in detail in the "Description of Device Functions" Operating Instructions. The related Operating Instructions can be found on the CD-ROM.

The measuring device is ready for operation on completion of the Quick Setup Communication.

## 6.6 Troubleshooting

The error messages that can occur most frequently when a measuring device is commissioned are described here.

A complete description of all the error messages → Operating Instructions on the CD-ROM.

### HART

No.	Error message / Type	Cause/remedy
351 ... 352	S: RANGE CUR.OUTn !: # 351...352	Current output: The actual value for the flow lies outside the set limits. Change the lower range or upper range values entered or reduce flow.
359 ... 360	S: RANGE PULSEn !: # 359...360	Pulse output: Pulse output frequency is outside the set range.  Remedy: 1. Increase pulse value 2. When selecting the pulse width, choose a value that can still be processed by a connected counter. 3. Reduce flow.
422	P: FLOW LIMIT ⚡: # 422	The measured flow has exceeded the maximum limit.  Reduce the flow rate or replace the instrument with a suitable size for the application.  Note! Error can be configured as a fault or notice message.

### PROFIBUS DP/PA

No.	Device status message (local display)	PROFIBUS measured value status				Extended diagnostic message in the PROFIBUS master	Cause/remedy
		Quality code (hex) Measured value status	Quality status	Quality substatus	Limits		
422	P: FLOW LIMIT ⚡: # 422	0x13	BA D	Sensor failure	Constant	Meas. flow exceeded max limit	The measured flow has exceeded the maximum limit.  Reduce the flow rate or replace the instrument with a suitable size for the application.  Note! Error can be configured as a fault or notice message.

## FOUNDATION Fieldbus

No.	Error messages: FOUNDATION Fieldbus (FF)* (onsite display)	Analog Input function block Error messages	Cause/remedy
422	Device status message (FF): Measured flow exceeds max limit – Err. No. 422 Onsite display: P: FLOW LIMIT !: # 422	OUT. QUALITY = UNCERTAIN  OUT. SUBSTATUS = Non specific	See HART table

## Modbus RS485

Register 6859 Data type: Integer	Register 6821 Data type: String (18 byte)	No.	Error message / Type	Cause/remedy
59	FLOW LIMIT	422	P: FLOW LIMIT !: # 422	The measured flow has exceeded the maximum limit.  Reduce the flow rate or replace the instrument with a suitable size for the application.  Note! Error can be configured as a fault or notice message.



[www.addresses.endress.com](http://www.addresses.endress.com)

---