

# Operating Instructions

## Proline Promag 10

### HART

Electromagnetic flowmeter

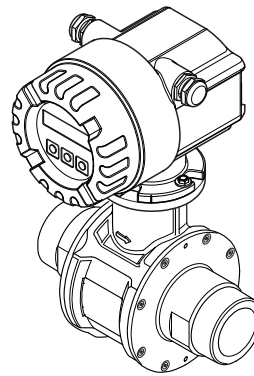
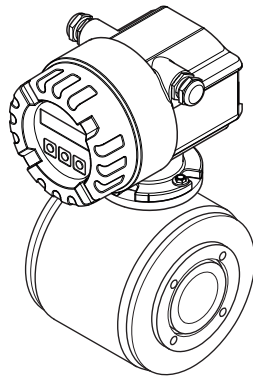
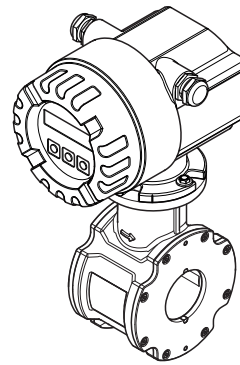
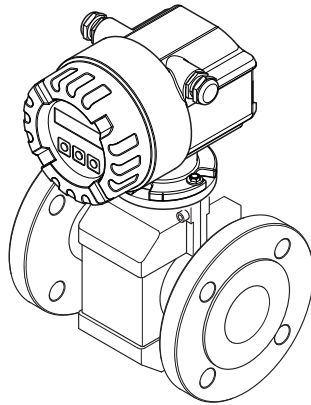



## Table of contents

<b>1</b>	<b>Safety instructions</b> . . . . .	<b>4</b>	<b>9</b>	<b>Troubleshooting</b> . . . . .	<b>73</b>
1.1	Designated use . . . . .	4	9.1	Troubleshooting instructions . . . . .	73
1.2	Installation, commissioning and operation . . . . .	4	9.2	System error messages . . . . .	74
1.3	Operational safety . . . . .	4	9.3	Process error messages . . . . .	75
1.4	Return . . . . .	5	9.4	Process errors without messages . . . . .	76
1.5	Notes on safety conventions and icons . . . . .	5	9.5	Response of outputs to errors . . . . .	77
<b>2</b>	<b>Identification</b> . . . . .	<b>6</b>	9.6	Spare parts . . . . .	78
2.1	Device designation . . . . .	6	9.7	Return . . . . .	82
2.2	Certificates and approvals . . . . .	8	9.8	Disposal . . . . .	82
2.3	Registered trademarks . . . . .	8	9.9	Software history . . . . .	82
<b>3</b>	<b>Installation</b> . . . . .	<b>9</b>	<b>10</b>	<b>Technical data</b> . . . . .	<b>83</b>
3.1	Incoming acceptance, transport and storage . . . . .	9	10.1	Application . . . . .	83
3.2	Mounting requirements . . . . .	11	10.2	Function and system design . . . . .	83
3.3	Installing the measuring device . . . . .	18	10.3	Input . . . . .	83
3.4	Post-installation check . . . . .	41	10.4	Output . . . . .	86
<b>4</b>	<b>Wiring</b> . . . . .	<b>42</b>	10.5	Power supply . . . . .	87
4.1	Connecting the remote version . . . . .	42	10.6	Performance characteristics . . . . .	88
4.2	Connecting the measuring unit . . . . .	48	10.7	Installation . . . . .	88
4.3	Potential equalization . . . . .	50	10.8	Environment . . . . .	88
4.4	Degree of protection . . . . .	53	10.9	Process . . . . .	89
4.5	Post-connection check . . . . .	54	10.10	Mechanical construction . . . . .	96
<b>5</b>	<b>Operation</b> . . . . .	<b>55</b>	10.11	Operability . . . . .	110
5.1	Display and operating elements . . . . .	55	10.12	Certificates and approvals . . . . .	110
5.2	Brief operating instructions on the function matrix . . . . .	56	10.13	Ordering information . . . . .	112
5.3	Displaying error messages . . . . .	58	10.14	Accessories . . . . .	112
5.4	Communication . . . . .	59	10.15	Documentation . . . . .	112
<b>6</b>	<b>Commissioning</b> . . . . .	<b>66</b>	<b>11</b>	<b>Appendix</b> . . . . .	<b>113</b>
6.1	Function check . . . . .	66	11.1	Illustration of the function matrix . . . . .	113
6.2	Switching on the measuring device . . . . .	66	11.2	Group SYSTEM UNITS . . . . .	114
6.3	Brief commissioning guide . . . . .	66	11.3	Group OPERATION . . . . .	116
6.4	Commissioning after installing a new electronics board . . . . .	67	11.4	USER INTERFACE . . . . .	117
6.5	Empty-pipe/full-pipe adjustment . . . . .	68	11.5	Group TOTALIZER . . . . .	118
<b>7</b>	<b>Maintenance</b> . . . . .	<b>69</b>	11.6	Group CURRENT OUTPUT . . . . .	119
7.1	Exterior cleaning . . . . .	69	11.7	Group PULSE/STATUS OUTPUT . . . . .	121
7.2	Seals . . . . .	69	11.8	Group COMMUNICATION . . . . .	126
<b>8</b>	<b>Accessories</b> . . . . .	<b>70</b>	11.9	Group PROCESS PARAMETER . . . . .	127
8.1	Device-specific accessories . . . . .	70	11.10	Group SYSTEM PARAMETER . . . . .	129
8.2	Communication-specific accessories . . . . .	71	11.11	Group SENSOR DATA . . . . .	132
8.3	Service-specific accessories . . . . .	71	11.12	Group SUPERVISION . . . . .	134
			11.13	Group SIMULATION SYSTEM . . . . .	136
			11.14	Group SENSOR VERSION . . . . .	136
			11.15	Group AMPLIFIER VERSION . . . . .	136
			11.16	Factory settings . . . . .	137
				<b>Index</b> . . . . .	<b>141</b>

# 1 Safety instructions

## 1.1 Designated use

The measuring device described in this Operating Manual is to be used only for measuring the flow rate of conductive fluids in closed pipes.

Most liquids can be measured as of a minimum conductivity of 50  $\mu\text{S}/\text{cm}$ .

Examples:

- Acids, alkalis
- Drinking water, wastewater, sewage sludge
- Milk, beer, wine, mineral water, etc.

Resulting from incorrect use or from use other than that designated the operational safety of the measuring devices can be suspended. The manufacturer accepts no liability for damages being produced from this.



## 1.2 Installation, commissioning and operation

Please note the following:

- Installation, connection to the electricity supply, commissioning and maintenance of the device must be carried out by trained, qualified specialists authorized to perform such work by the facility's owner-operator. The specialist must have read and understood this Operating Manual and must follow the instructions it contains.
- The device must be operated by persons authorized and trained by the facility's owner-operator. Strict compliance with the instructions in the Operating Manual is mandatory.
- With regard to special fluids, including fluids used for cleaning, Endress+Hauser will be happy to assist in clarifying the corrosion-resistant properties of wetted materials. However, minor changes in temperature, concentration or in the degree of contamination in the process may result in variations in corrosion resistance. For this reason, Endress+Hauser does not accept any responsibility with regard to the corrosion resistance of wetted materials in a specific application. The user is responsible for the choice of suitable wetted materials in the process.
- If welding work is performed on the piping system, do not ground the welding appliance through the Promag flowmeter.
- The installer must ensure that the measuring system is correctly wired in accordance with the wiring diagrams. The transmitter must be grounded apart from when special protective measures are taken (e.g. galvanically isolated SELV or PELV power supply)
- Invariably, local regulations governing the opening and repair of electrical devices apply.

## 1.3 Operational safety

Please note the following:

- Measuring systems for use in hazardous environments are accompanied by separate Ex documentation, which is an integral part of this Operating Manual. Strict compliance with the installation instructions and ratings as stated in this supplementary documentation is mandatory. The symbol on the front of this Ex documentation indicates the approval and the certification body (e.g.  Europe,  USA,  Canada).
- The measuring device complies with the general safety requirements in accordance with EN 61010-1, the EMC requirements of IEC/EN 61326 and NAMUR Recommendations NE 21 and NE 43.
- Depending on the application, the seals of the process connections of the Promag H sensor require periodic replacement.
- When hot fluid passes through the measuring tube, the surface temperature of the housing increases. In the case of the sensor, in particular, users should expect temperatures that can be close to the fluid temperature. If the temperature of the fluid is high, implement sufficient measures to prevent burning or scalding.

- The manufacturer reserves the right to modify technical data without prior notice. Your Endress+Hauser distributor will supply you with current information and updates to these Operating Instructions.

## 1.4 Return

The measuring device must be returned if repairs or a factory calibration are required, or if the wrong measuring device has been ordered or delivered. According to legal regulations, Endress+Hauser, as an ISO-certified company, is required to follow certain procedures when handling returned products that are in contact with medium.

To ensure swift, safe and professional device returns, please read the return procedures and conditions on the Endress+Hauser website at [www.services.endress.com/return-material](http://www.services.endress.com/return-material)

## 1.5 Notes on safety conventions and icons

The devices are designed to meet state-of-the-art safety requirements, have been tested, and left the factory in a condition in which they are safe to operate. The devices comply with the applicable standards and regulations in accordance with EN 61010-1 "Safety requirements for electrical equipment for measurement, control and laboratory use".

The devices can, however, be a source of danger if used incorrectly or for anything other than the designated use. Consequently, always pay particular attention to the safety instructions indicated in this Operating Manual by the following icons:



**Warning!**

"Warning" indicates an action or procedure which, if not performed correctly, can result in injury or a safety hazard. Comply strictly with the instructions and proceed with care.



**Caution!**

"Caution" indicates an action or procedure which, if not performed correctly, can result in incorrect operation or destruction of the device. Comply strictly with the instructions.



**Note!**

"Note" indicates an action or procedure which, if not performed correctly, can have an indirect effect on operation or trigger an unexpected response on the part of the device.

## 2 Identification

### 2.1 Device designation

The flow measuring system consists of the following components:

- Promag 10 transmitter
- Promag D/E/H/L/P/W sensor

In the *compact version*, the transmitter and sensor form a single mechanical unit; in the *remote version* they are installed separately.

#### 2.1.1 Nameplate of the transmitter

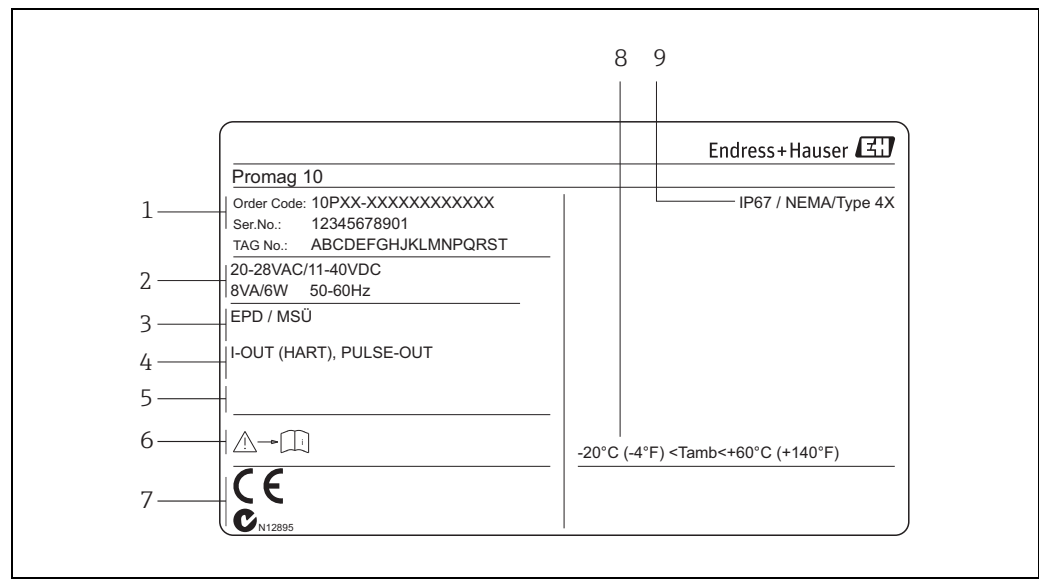

Fig. 1: Nameplate specifications for the "Promag 10" transmitter (example)

- 1 Ordering code/serial number: See the specifications on the order confirmation for the meanings of the individual letters and digits.
- 2 Power supply, frequency, power consumption
- 3 Additional information:  
EPD/MSÜ: with Empty Pipe Detection
- 4 Outputs available:  
I-OUT (HART): with current output (HART)  
PULSE-OUT: with pulse/status output
- 5 Reserved for information on special products
- 6 Observe device documentation
- 7 Reserved for additional information on device version (approvals, certificates)
- 8 Permitted ambient temperature range
- 9 Degree of protection

### 2.1.2 Nameplate of the sensor

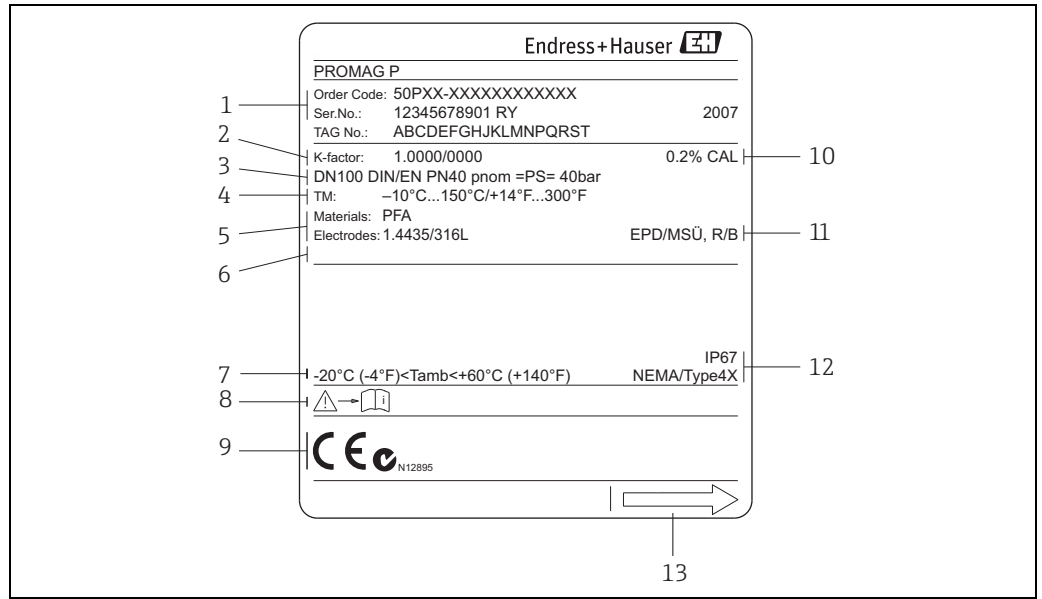

Fig. 2: Nameplate specifications for the "Promag" sensor (example)

- 1 Ordering code/serial number: See the specifications on the order confirmation for the meanings of the individual letters and digits.
- 2 Calibration factor with zero point
- 3 Nominal diameter/Pressure rating
- 4 Fluid temperature range
- 5 Materials: lining/measuring electrodes
- 6 Reserved for information on special products
- 7 Permitted ambient temperature range
- 8 Observe device documentation
- 9 Reserved for additional information on device version (approvals, certificates)
- 10 Calibration tolerance
- 11 Additional information (examples):
  - EPD/MSÜ: with Empty Pipe Detection electrode
  - R/B: with reference electrode
- 12 Degree of protection
- 13 Flow direction

### 2.1.3 Nameplate, connections

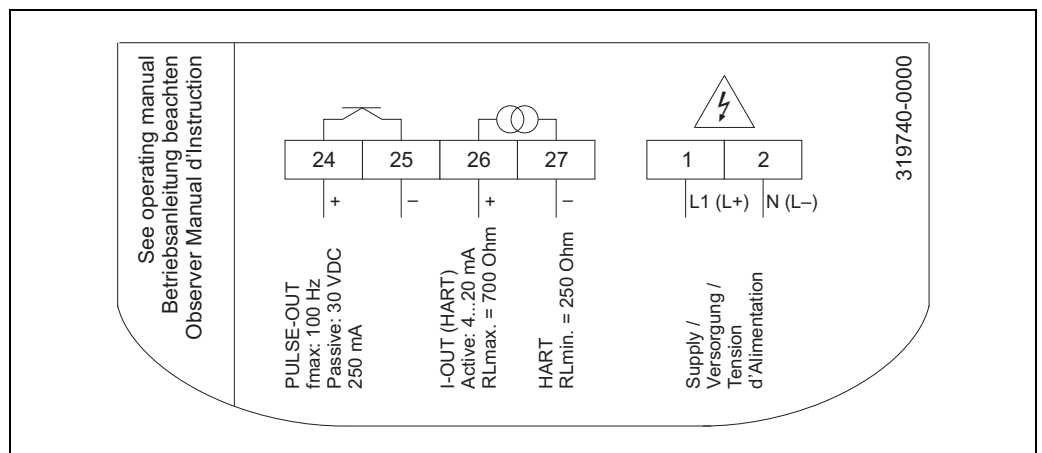

Fig. 3: Nameplate specifications for transmitter (example)

## 2.2 Certificates and approvals

The devices are designed to meet state-of-the-art safety requirements in accordance with sound engineering practice. They have been tested and left the factory in a condition in which they are safe to operate.

The devices comply with the applicable standards and regulations in accordance with EN 61010-1 "Safety requirements for electrical equipment for measurement, control and laboratory use" and with the EMC requirements of IEC/EN 61326.

The measuring system described in this Operating Manual is therefore in conformity with the statutory requirements of the EC Directives. Endress+Hauser confirms successful testing of the device by affixing to it the CE mark.

The measuring system meets the EMC requirements of the "Australian Communications and Media Authority (ACMA)".

## 2.3 Registered trademarks

KALREZ® and VITON®

Registered trademarks of E.I. Du Pont de Nemours & Co., Wilmington, USA

TRI-CLAMP®

Registered trademark of Ladish & Co., Inc., Kenosha, USA

HART®

Registered trademark of the HART Communication Foundation, Austin, USA

Applicator®, FieldCare®, Fieldcheck®

Registered or registration-pending trademarks of the Endress+Hauser Group



## 3 Installation

### 3.1 Incoming acceptance, transport and storage

#### 3.1.1 Incoming acceptance

On receipt of the goods, check the following:

- Check the packaging and the contents for damage.
- Check the shipment, make sure nothing is missing and that the scope of supply matches your order.

#### 3.1.2 Transport

The following instructions apply to unpacking and to transporting the device to its final location:

- Transport the devices in the containers in which they are delivered.
- Do not remove the protective plates or caps on the process connections until you are ready to install the device. This is particularly important in the case of sensors with PTFE linings.

#### Special notes on flanged devices



Caution!

- The wooden covers mounted on the flanges from the factory protect the linings on the flanges during storage and transportation. In case of Promag L they are additionally used to hold the lap joint flanges in place. Do not remove these covers until **immediately before** the device in the pipe.
- Do not lift flanged devices by the transmitter housing, or the connection housing in the case of the remote version.

*Transporting flanged devices  $DN \leq 300$  (12")*

Use webbing slings slung round the two process connections.  
Do not use chains, as they could damage the housing.



Warning!

Risk of injury if the measuring device slips. The center of gravity of the assembled measuring device might be higher than the points around which the slings are slung.  
At all times, therefore, make sure that the device does not unexpectedly turn around its axis or slip.

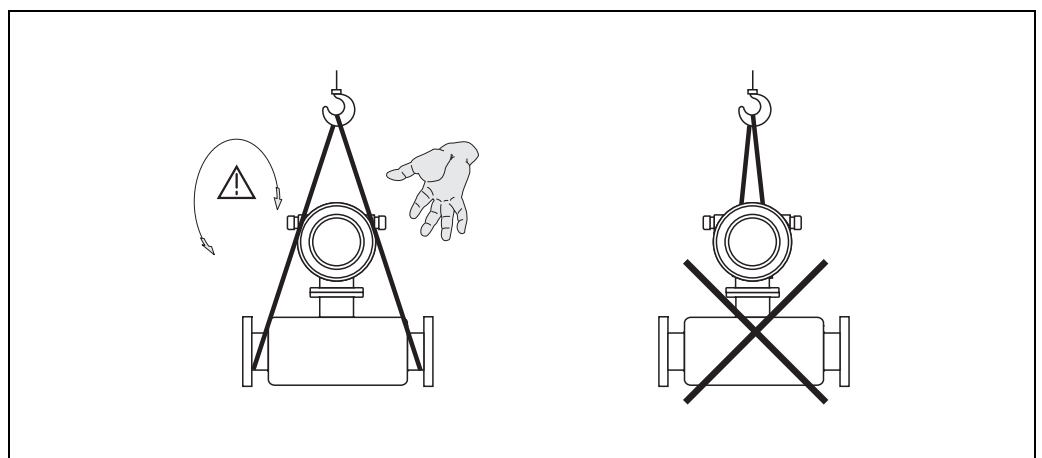

Fig. 4: Transporting sensors with  $DN \leq 300$  (12")

A0005575

### Transporting flanged devices $DN \geq 350$ (14")

Use only the metal eyes on the flanges for transporting the device, lifting it and positioning the sensor in the piping.



#### Caution!

Do not attempt to lift the sensor with the tines of a fork-lift truck beneath the metal casing. This would buckle the casing and damage the internal magnetic coils.

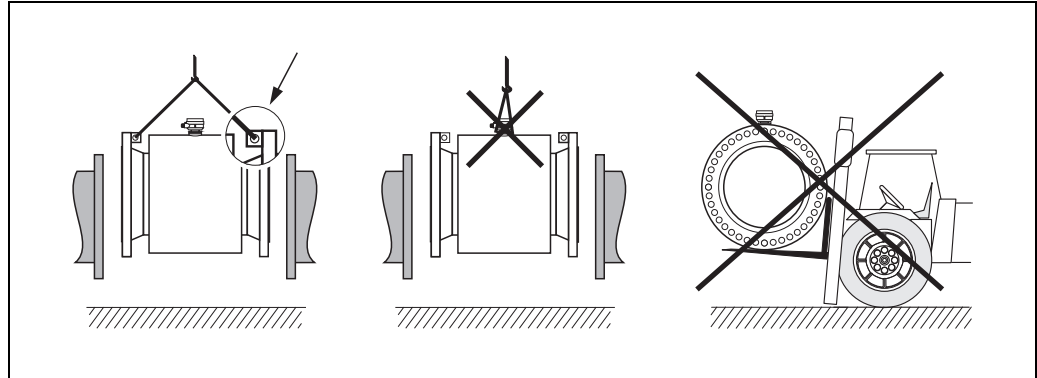

Fig. 5: Transporting sensors with  $DN \geq 350$  (14")

A0004295

### 3.1.3 Storage

Please note the following:

- Pack the measuring device in such a way as to protect it reliably against impact for storage (and transportation). The original packaging provides optimum protection.
- The storage temperature corresponds to the operating temperature range of the measuring transmitter and the appropriate measuring sensors → 88.
- Do not remove the protective plates or caps on the process connections until you are ready to install the device. This is particularly important in the case of sensors with PTFE linings.
- The measuring device must be protected against direct sunlight during storage in order to avoid unacceptably high surface temperatures.
- Choose a storage location where moisture does not collect in the measuring device. This will help prevent fungus and bacteria infestation which can damage the liner.

### 3.2 Mounting requirements

#### 3.2.1 Dimensions

The dimensions and installation lengths of the sensor and transmitter can be found in the "Technical Information" for the device in question. This document can be downloaded as a PDF file from [www.endress.com](http://www.endress.com). A list of the "Technical Information" documents available is provided in the "Documentation" section on → 112.

#### 3.2.2 Mounting location

Entrained air or gas bubble formation in the measuring tube can result in an increase in measuring errors.

**Avoid** the following locations:

- Highest point of a pipeline. Risk of air accumulating!
- Directly upstream from a free pipe outlet in a vertical pipeline.

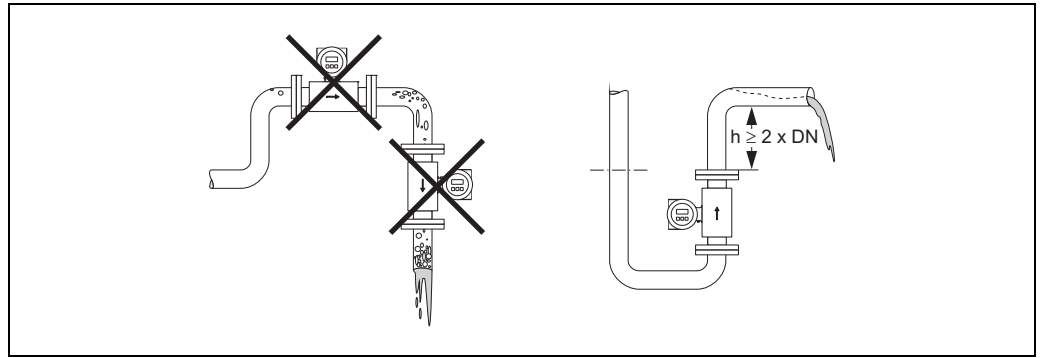

Fig. 6: Mounting location



Abb. 7: Installation of the sensor after a control valve is not recommended

1 Control valve

#### Installation of pumps

Do **not** install the sensor on the intake side of a pump. This precaution is to avoid low pressure and the consequent risk of damage to the lining of the measuring tube. Information on the lining's resistance to partial vacuum can be found on → 92.

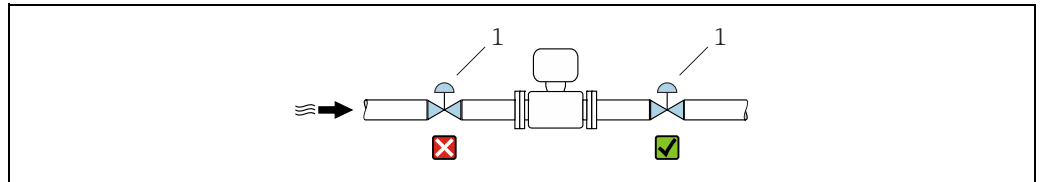
It might be necessary to install pulse dampers in systems incorporating reciprocating, diaphragm or peristaltic pumps. Information on the measuring system's resistance to vibration and shock can be found on → 89.

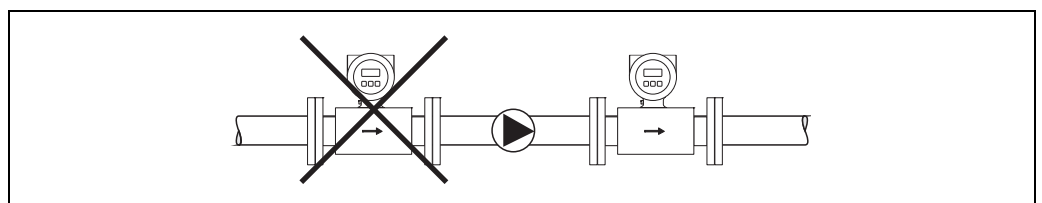

Fig. 8: Installation of pumps

### Partially filled pipes

Partially filled pipes with gradients necessitate a drain-type configuration.

The Empty Pipe Detection function (EPD → 68) offers additional protection by detecting empty or partially filled pipes.



Caution!

Risk of solids accumulating. Do not install the sensor at the lowest point in the drain. It is advisable to install a cleaning valve.

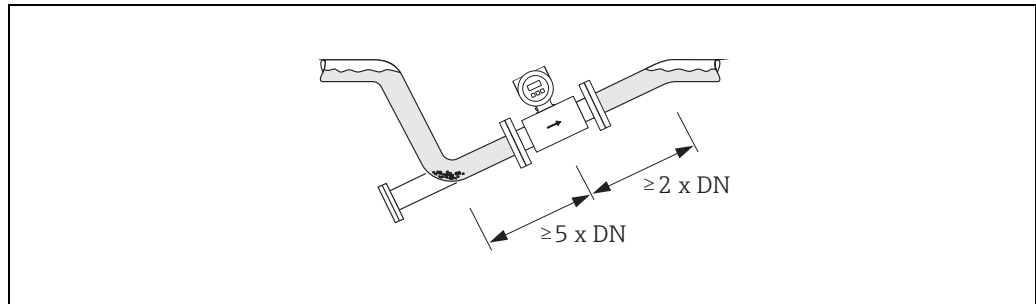

Fig. 9: Installation in a partially filled pipe

### Down pipes

Install a siphon or a vent valve downstream of the sensor in down pipes whose length  $h \geq 5 \text{ m}$  (16.4 ft). This precaution is to avoid low pressure and the consequent risk of damage to the lining of the measuring tube.

This measure also prevents the system losing prime, which could cause air pockets.

Information on the lining's resistance to partial vacuum can be found on → 92.

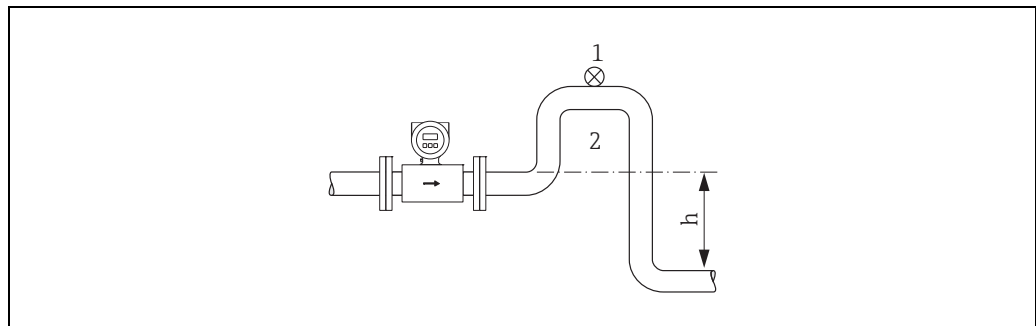

Fig. 10: Measures for installation in a down pipe

- 1 Vent valve
- 2 Pipe siphon
- h Length of down pipe

### 3.2.3 Orientation

An optimum orientation position helps avoid gas and air accumulations and deposits in the measuring tube. However, Promag offers the additional Empty Pipe Detection (EPD) function to ensure the detection of partially filled measuring tubes, e.g. in the case of degassing fluids or varying process pressure.

#### Vertical orientation

This is the ideal orientation for self-emptying piping systems and for use in conjunction with Empty Pipe Detection.

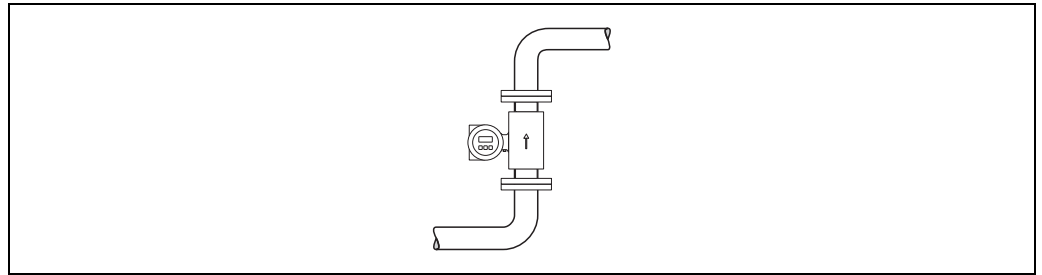

A0008158

Fig. 11: Vertical orientation

#### Horizontal orientation

The measuring electrode plane should be horizontal. This prevents brief insulation of the two measuring electrodes by entrained air bubbles.



Caution!

Empty Pipe Detection functions correctly only when the measuring device is installed horizontally and the transmitter housing is facing upward (→ Fig. 11). Otherwise there is no guarantee that Empty Pipe Detection will respond if the measuring tube is only partially filled or empty.

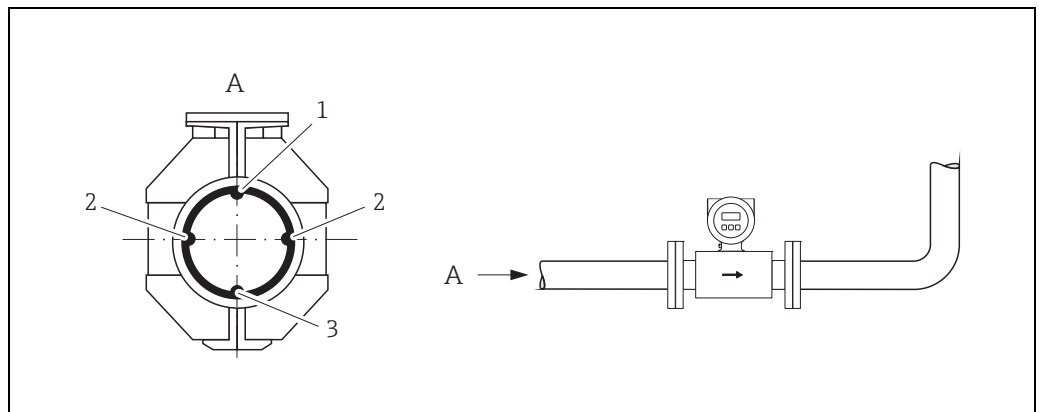

A0003207

Fig. 12: Horizontal orientation

- 1 EPD electrode for the detection of empty pipes (not with Promag D and Promag H (DN 2 to 8 / 1/2 to 3/8"))
- 2 Measuring electrodes for signal detection
- 3 Reference electrode for the potential equalization (not with Promag D and H)

**Inlet and outlet run**

If possible, install the sensor upstream from fittings such as valves, T-pieces, elbows, etc.

The following inlet and outlet runs must be observed in order to meet accuracy specifications:

- Inlet run:  $\geq 5 \times \text{DN}$
- Outlet run:  $\geq 2 \times \text{DN}$

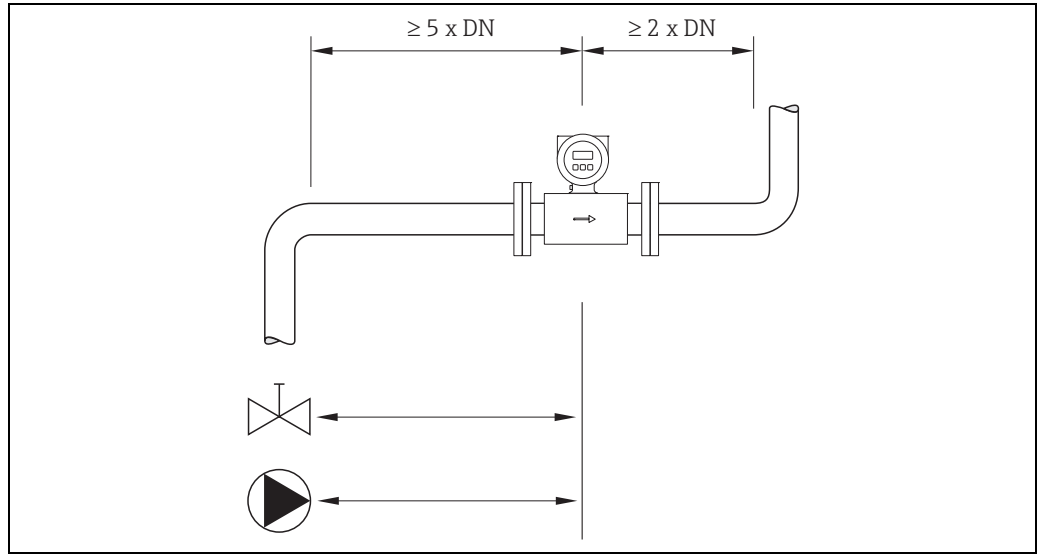

Fig. 13: Inlet and outlet run standard version



Abb. 14: Optional version: w/o inlet and outlet run

**3.2.4 Vibrations**

Secure the piping and the sensor if vibration is severe.

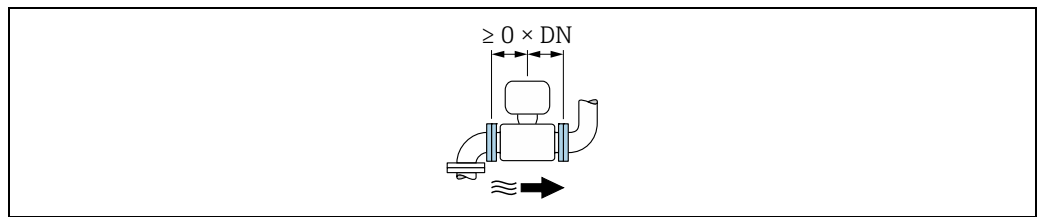

Caution!

If vibrations are too severe, we recommend the sensor and transmitter be mounted separately. Information on resistance to vibration and shock can be found on → 89.

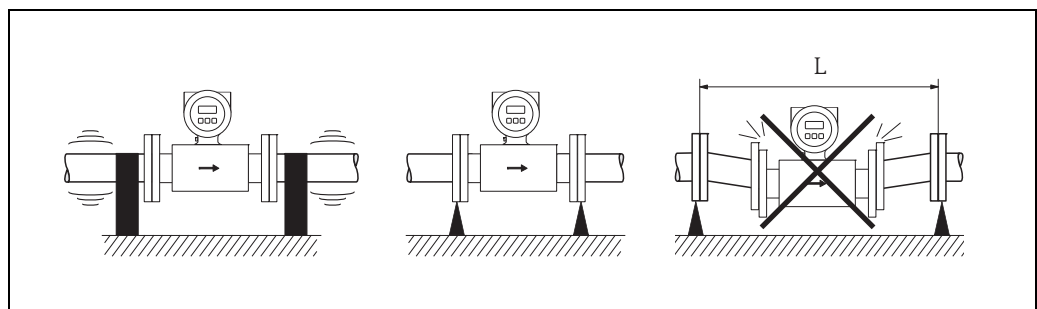

Fig. 15: Measures to prevent vibration of the device ( $L > 10 \text{ m (32.8 ft)}$ )

### 3.2.5 Foundations, supports

If the nominal diameter is  $DN \geq 350$  (14"), mount the sensor on a foundation of adequate load-bearing strength.



Caution!

Risk of damage.

Do not support the weight of the sensor on the metal casing: the casing would buckle and damage the internal magnetic coils.

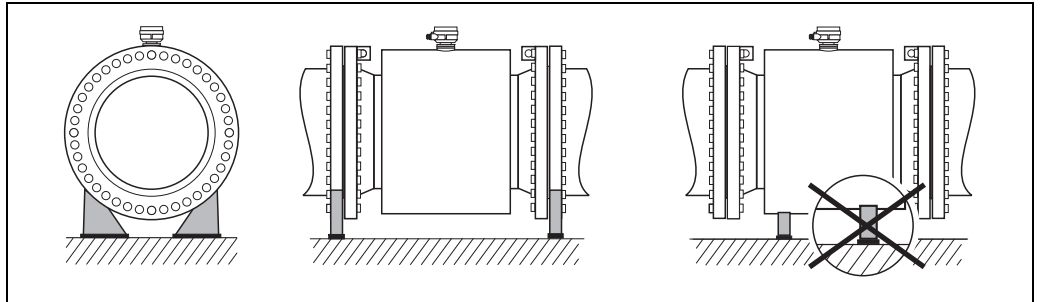

Fig. 16: Correct support for large nominal diameters ( $DN \geq 350 / 14''$ )

### 3.2.6 Adapters

Suitable adapters to DIN EN 545 (double-flange reducers) can be used to install the sensor in larger-diameter pipes.

The resultant increase in the rate of flow improves measuring accuracy with very slow-moving fluids. The nomogram shown here can be used to calculate the pressure loss caused by reducers and expanders.



Note!

- The nomogram only applies to liquids of viscosity similar to water.
- For Promag D with threaded connection adapters can not be used
- For Promag H the selection of a pipe with larger diameter for high viscosities of the fluid may be considered to reduce the pressure loss.

1. Calculate the ratio of the diameters  $d/D$ .
2. From the nomogram read off the pressure loss as a function of flow velocity (downstream from the reduction) and the  $d/D$  ratio.

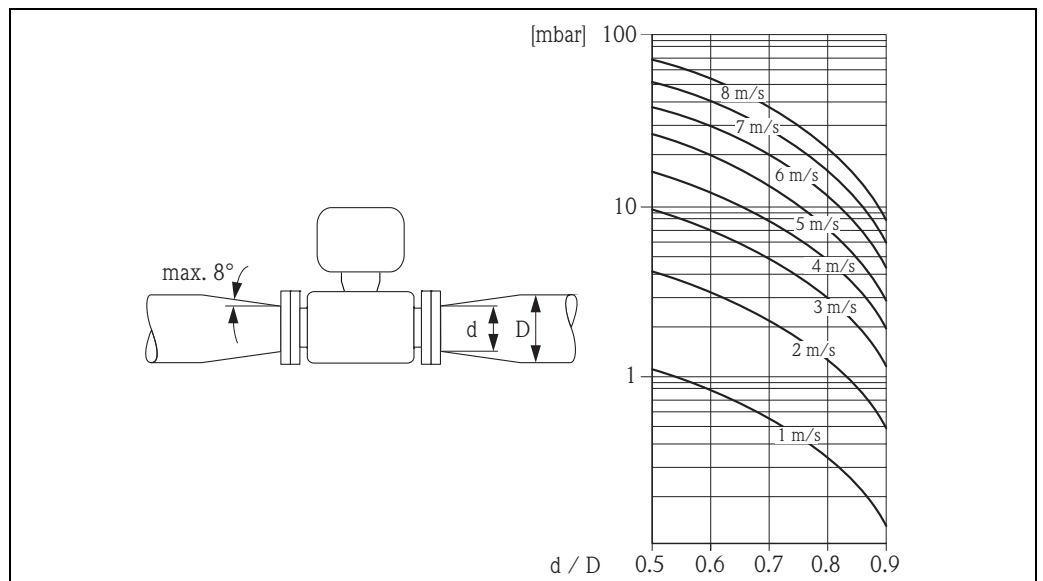

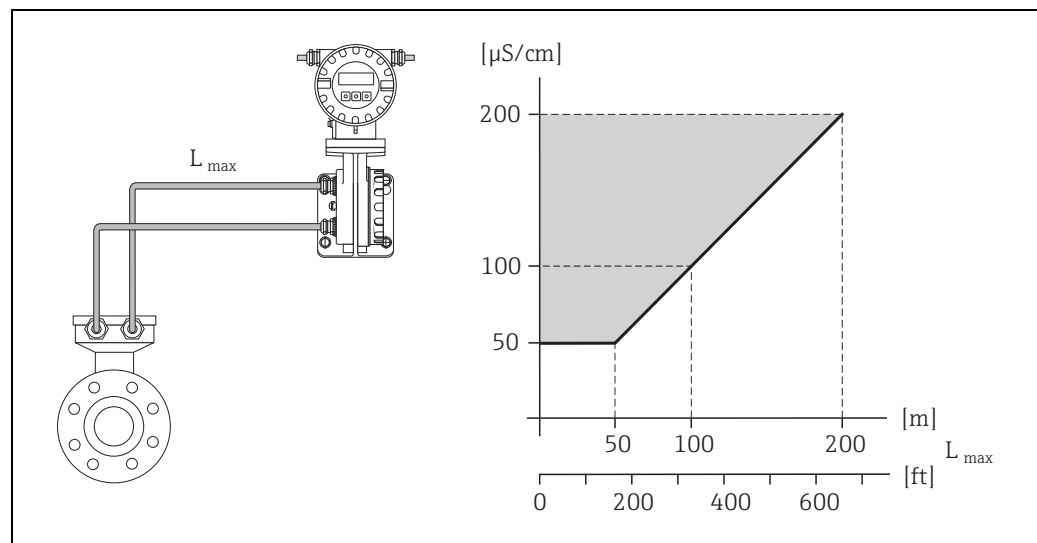

Fig. 17: Pressure loss due to adapters

### 3.2.7 Length of connecting cable

In order to ensure measuring accuracy, comply with the following instructions when installing the remote version:

- Fix cable run or lay in armored conduit. Cable movements can falsify the measuring signal especially in the case of low fluid conductivities.
- Route the cable well clear of electrical machines and switching elements.
- Ensure potential equalization between sensor and transmitter, if necessary.
- The permitted connecting cable length  $L_{max}$  is determined by the fluid conductivity ( $\rightarrow$   18). A minimum conductivity of  $50 \mu\text{S}/\text{cm}$  is needed for all fluids.
- The maximum connecting cable length is 10 m (33 ft) when empty pipe detection (EPD  $\rightarrow$   68) is switched on.



A0003214

Fig. 18: Permissible cable length for the remote version

Area shaded gray = permitted range  
 $L_{max}$  = connecting cable length in [m]  
 Fluid conductivity in [ $\mu\text{S}/\text{cm}$ ]



### 3.2.8 Special mounting instructions

#### Temporary use in water for sensor Promag L

A remote version in IP67, type 6 is optionally available for temporary use in water up to 168 hours at  $\leq 3$  m (10 ft) or, in exceptional cases, for use up to 48 hours at  $\leq 10$  m (30 ft).

Compared to the degree of protection of standard version IP67, type 4X enclosure, the version IP67, type 6 enclosure was designed to withstand short-term or temporary submergence (e.g. flooding).



Abb. 19: Temporary use in water. Engineering unit mm (ft)

A0017296

### 3.3 Installing the measuring device

#### 3.3.1 Installing the Promag D sensor as wafer version

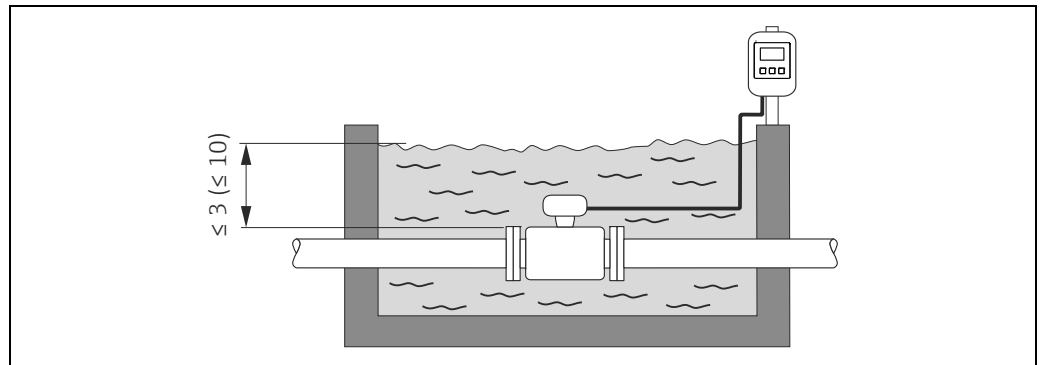
The sensor is installed between the pipe flanges with a mounting kit. The device is centered using recesses on the sensor (→ 19).



Note!

A mounting kit consisting of mounting bolts, seals, nuts and washers can be ordered separately (→ 70). Centering sleeves are provided with the device if they are required for the installation.



Caution!

When installing the transmitter in the pipe, observe the necessary torques (→ 20).

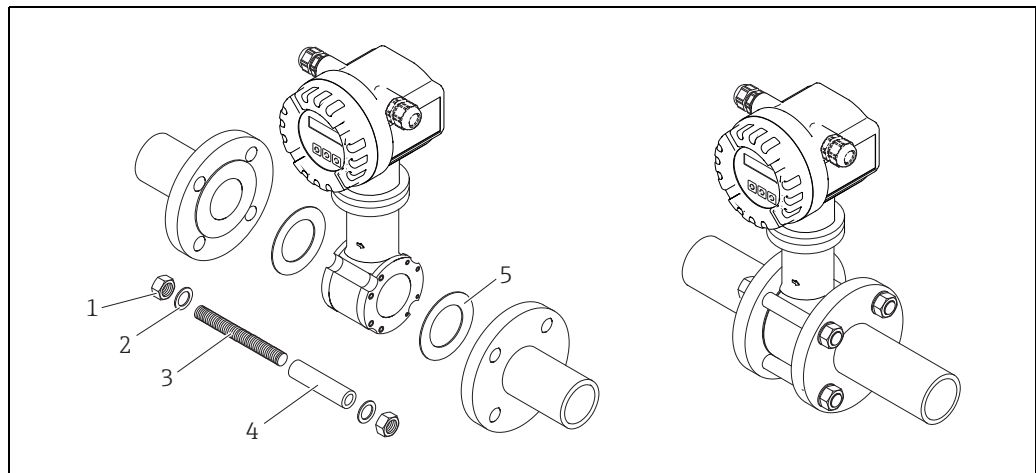

Fig. 20: Mounting the sensor Promag D as wafer version

- |   |                  |
|---|------------------|
| 1 | Nut              |
| 2 | Washer           |
| 3 | Mounting bolt    |
| 4 | Centering sleeve |
| 5 | Seal             |

#### Seals

When installing the sensor make sure that the seals used do not project into the pipe cross-section.



Caution!

Risk of short circuit! Do not use electrically conductive sealing compounds such as graphite! An electrically conductive layer could form on the inside of the measuring tube and short-circuit the measuring signal.



Note!

Use seals with a hardness rating of 70° Shore A.

**Arrangement of the mounting bolts and centering sleeves**

The device is centered using recesses on the sensor. The arrangement of the mounting bolts and the use of the centering sleeves supplied depend on the nominal diameter, the flange standard und the pitch circle diameter.

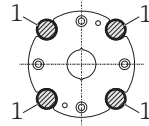
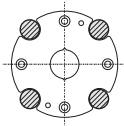
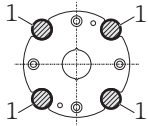
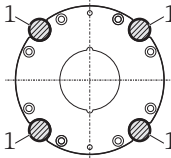
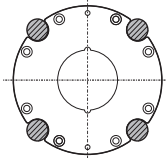
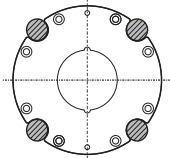
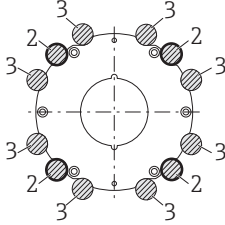
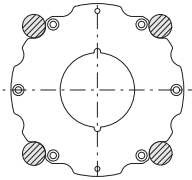
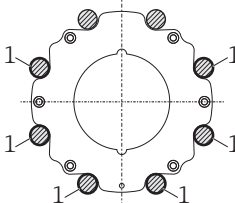
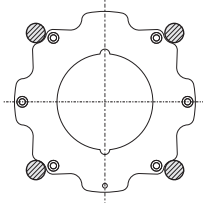
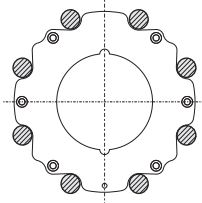
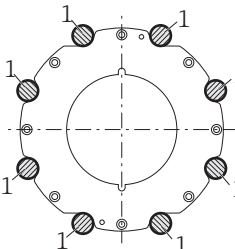
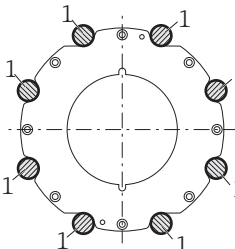
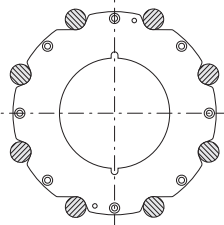
	Process connection		
	EN (DIN)	ASME	JIS
DN 25 to 40 (1 to 1 1/2")	 <p>A0010896</p>	 <p>A0010824</p>	 <p>A0010896</p>
DN 50 (2")	 <p>A0010897</p>	 <p>A0010825</p>	 <p>A0010825</p>
DN 65 (-)	 <p>A0012170</p>	<p>A0010825</p>	 <p>A0012171</p>
DN 80 (3")	 <p>A0010898</p>	 <p>A0010827</p>	 <p>A0010826</p>
DN 100 (4")	 <p>A0012168</p>	 <p>A0012168</p>	 <p>A0012169</p>
<p>1 = Mounting bolts with centering sleeves                  2 = EN (DIN) flanges: 4-hole → with centering sleeves                  3 = EN (DIN) flanges: 8-hole → without centering sleeves</p>			

**Screw tightening torques (Promag D as wafer version)**

Please note the following:

- The tightening torques listed below are for lubricated threads only.
- Always tighten the screws uniformly and in diagonally opposite sequence.
- Overtightening the screws will deform the sealing faces or damage the seals.
- The tightening torques listed below apply only to pipes not subjected to tensile stress.

The tightening torques apply to situations where an EPDM soft material flat seal (e.g. 70° Shore A) is used.

*Promag D as wafer version tightening torques, mounting bolts and centering sleeves for EN (DIN) PN 16*

Nominal diameter [mm]	Mounting bolts [mm]	Centering sleeve length [mm]	Tightening torque [Nm] with a process flange with a	
			smooth seal face	raised face
25	4 × M12 × 145	54	19	19
40	4 × M16 × 170	68	33	33
50	4 × M16 × 185	82	41	41
65 <sup>1</sup>	4 × M16 × 200	92	44	44
65 <sup>2</sup>	8 × M16 × 200	– <sup>≥</sup>	29	29
80	8 × M16 × 225	116	36	36
100	8 × M16 × 260	147	40	40

<sup>1</sup> EN (DIN) flanges: 4-hole → with centering sleeves  
<sup>2</sup> EN (DIN) flanges: 8-hole → without centering sleeves  
<sup>≥</sup> A centering sleeve is not required. The device is centered directly via the sensor housing.

*Promag D as wafer version tightening torques, mounting bolts and centering sleeves for JIS 10 K*

Nominal diameter [mm]	Mounting bolts [mm]	Centering sleeve length [mm]	Tightening torque [Nm] with a process flange with a	
			smooth seal face	raised face
25	4 × M16 × 170	54	24	24
40	4 × M16 × 170	68	32	25
50	4 × M16 × 185	– *	38	30
65	4 × M16 × 200	– *	42	42
80	8 × M16 × 225	– *	36	28
100	8 × M16 × 260	– *	39	37

\* A centering sleeve is not required. The device is centered directly via the sensor housing.

*Promag D as wafer version tightening torques, mounting bolts and centering sleeves for ASME Class 150*

Nominal diameter [inch]	Mounting bolts [inch]	Centering sleeve length [inch]	Tightening torque [lbf · ft] with a process flange with a	
			smooth seal face	raised face
1"	4 × UNC ½ " × 5.70"	– *	14	7
1 ½"	4 × UNC ½ " × 6.50"	– *	21	14
2"	4 × UNC 5/8" × 7.50"	– *	30	27
3"	4 × UNC 5/8" × 9.25"	– *	31	31
4"	8 × UNC 5/8" × 10.4"	5.79	28	28

\* A centering sleeve is not required. The device is centered directly via the sensor housing.

### 3.3.2 Installing the Promag D sensor with threaded connection

The sensor can be installed into the pipe with common threaded connections.



Caution!

When installing the transmitter in the pipe, observe the necessary torques (→ 20).



Abb. 21: Installing the Promag D sensor with threaded connection

#### Seals

The purchaser is responsible for the choice of the seals. Common seals can be used for the threaded connections.

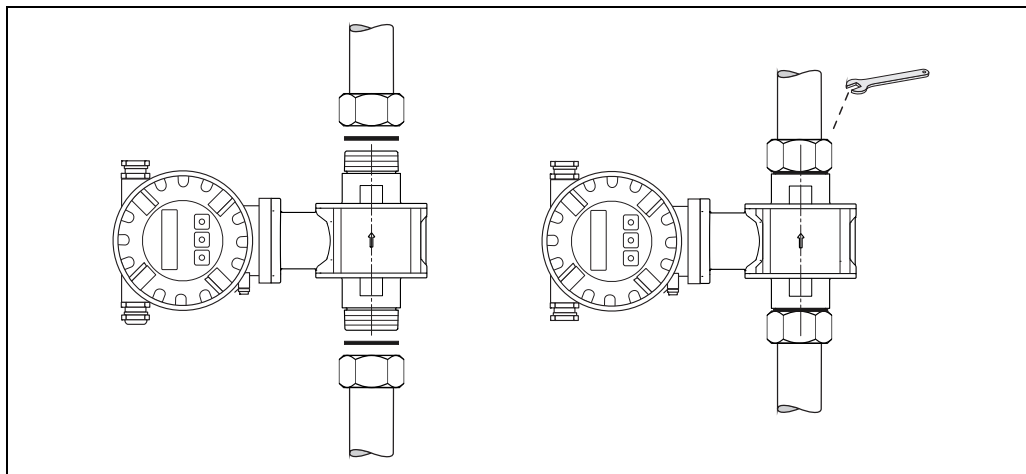

Caution!

Risk of short circuit! Do not use electrically conductive sealing compounds such as graphite! An electrically conductive layer could form on the inside of the measuring tube and short-circuit the measuring signal.

#### Screw tightening torques (Promag D with threaded connection)

The tightening torques listed below are for lubricated threads only.

##### Promag D with threaded connection tightening torques for EN (DIN) PN16

Nominal diameter [mm]	Threaded connection	Width across flat [mm/inch]	Max. tightening torque [Nm]
25	G 1"	28/1.1	20
40	G 1 1/2"	50/1.97	50
50	G 2"	60/2.36	90

The purchaser is responsible for the choice of the seals

##### Promag D with threaded connection tightening torques for ANSI Class 150

Nominal diameter [in]	Threaded connection	Width across flat [mm/inch]	Max. tightening torque [Nm]
1"	NPT 1"	28/1.1	20
1 1/2"	NPT 1 1/2"	50/1.97	50
2"	NPT 2"	60/2.36	90

The purchaser is responsible for the choice of the seals

### 3.3.3 Installing the Promag E sensor



#### Caution!

- The protective covers mounted on the two sensor flanges guard the PTFE, which is turned over the flanges. Consequently, do not remove these covers until **immediately before** the sensor is installed in the pipe.
- The covers must remain in place while the device is in storage.
- Make sure that the lining is not damaged or removed from the flanges.



#### Note!

Bolts, nuts, seals, etc. are not included in the scope of supply and must be supplied by the customer.

The sensor is designed for installation between the two piping flanges.

- Observe in any case the necessary screw tightening torques on → 23
- If grounding disks are used, follow the mounting instructions which will be enclosed with the shipment

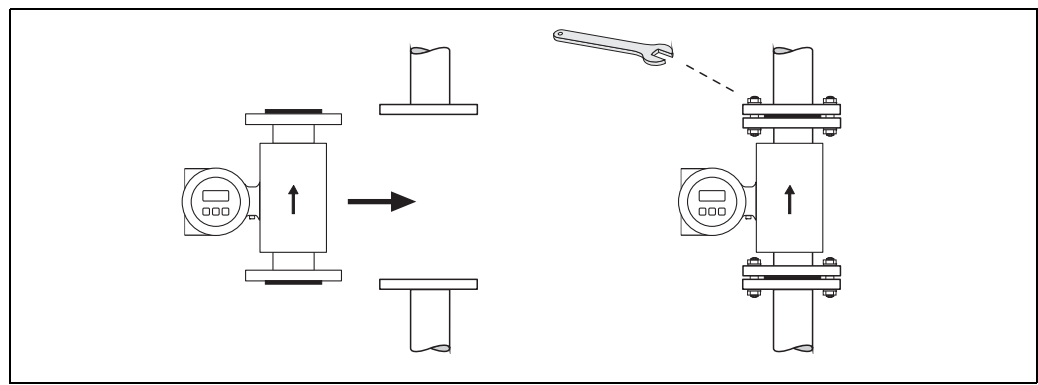

Fig. 22: Installing the Promag E sensor

#### Seals

Comply with the following instructions when installing seals:

- PTFE lining → **No** seals are required!
- For DIN flanges, use only seals according to EN 1514-1.
- Make sure that the seals do not protrude into the piping cross-section.



#### Caution!

Risk of short circuit! Do not use electrically conductive sealing compounds such as graphite! An electrically conductive layer could form on the inside of the measuring tube and short-circuit the measuring signal.

#### Ground cable



- If necessary, special ground cables for potential equalization can be ordered as an accessory (→ 70).
- Information on potential equalization and detailed mounting instructions for the use of ground cables can be found on → 50

### Tightening torques for threaded fasteners (Promag E)

Please note the following:

- The tightening torques listed below are for lubricated threads only.
- Always tighten the screws uniformly and in diagonally opposite sequence.
- Overtightening the screws will deform the sealing faces or damage the seals.
- The tightening torques listed below apply only to pipes not subjected to tensile stress.

Tightening torques for:

- EN (DIN) →  23
- ASME →  24
- JIS →  24

#### Promag E tightening torques for EN (DIN)

Nominal diameter [mm]	EN (DIN) Pressure rating [bar]	Threaded fasteners	Max. tightening torque [Nm]
15	PN 40	4 × M 12	11
25	PN 40	4 × M 12	26
32	PN 40	4 × M 16	41
40	PN 40	4 × M 16	52
50	PN 40	4 × M 16	65
65 <sup>1)</sup>	PN 16	8 × M 16	43
80	PN 16	8 × M 16	53
100	PN 16	8 × M 16	57
125	PN 16	8 × M 16	75
150	PN 16	8 × M 20	99
200	PN 10	8 × M 20	141
200	PN 16	12 × M 20	94
250	PN 10	12 × M 20	110
250	PN 16	12 × M 24	131
300	PN 10	12 × M 20	125
300	PN 16	12 × M 24	179
350	PN 6	12 × M 20	200
350	PN 10	16 × M 20	188
350	PN 16	16 × M 24	254
400	PN 6	16 × M 20	166
400	PN 10	16 × M 24	260
400	PN 16	16 × M 27	330
450	PN 6	16 × M 20	202
450	PN 10	20 × M 24	235
450	PN 16	20 × M 27	300
500	PN 6	20 × M 20	176
500	PN 10	20 × M 24	265
500	PN 16	20 × M 30	448
600	PN 6	20 × M 24	242
600	PN 10	20 × M 27	345
600 <sup>1)</sup>	PN 16	20 × M 33	658

<sup>1)</sup> Designed acc. to EN 1092-1 (not to DIN 2501)

*Promag E tightening torques for ASME*

Nominal diameter		ASME Pressure rating [lbs]	Threaded fasteners	Max. tightening torque PTFE	
[mm]	[inch]			[Nm]	[lbf · ft]
15	½"	Class 150	4 × ½"	6	4
25	1"	Class 150	4 × ½"	11	8
40	1 ½"	Class 150	4 × ½"	24	18
50	2"	Class 150	4 × 5/8"	47	35
80	3"	Class 150	4 × 5/8"	79	58
100	4"	Class 150	8 × 5/8"	56	41
150	6"	Class 150	8 × ¾"	106	78
200	8"	Class 150	8 × ¾"	143	105
250	10"	Class 150	12 × 7/8"	135	100
300	12"	Class 150	12 × 7/8"	178	131
350	14"	Class 150	12 × 1"	260	192
400	16"	Class 150	16 × 1"	246	181
450	18"	Class 150	16 × 1 1/8"	371	274
500	20"	Class 150	20 × 1 1/8"	341	252
600	24"	Class 150	20 × 1 ¼"	477	352

*Promag E tightening torques for JIS*

Nominal diameter [mm]	JIS Pressure rating	Threaded fasteners	Max. tightening torque [Nm] PTFE
15	20K	4 × M 12	16
25	20K	4 × M 16	32
32	20K	4 × M 16	38
40	20K	4 × M 16	41
50	10K	4 × M 16	54
65	10K	4 × M 16	74
80	10K	8 × M 16	38
100	10K	8 × M 16	47
125	10K	8 × M 20	80
150	10K	8 × M 20	99
200	10K	12 × M 20	82
250	10K	12 × M 22	133
300	10K	16 × M 22	99



### 3.3.4 Installing the Promag H sensor

The sensor is supplied to order, with or without pre-installed process connections. Pre-installed process connections are secured to the sensor with 4 or 6 hex-head threaded fasteners.



**Caution!**

The sensor might require support or additional attachments, depending on the application and the length of the piping run. When plastic process connections are used, the sensor must be additionally supported mechanically. A wall-mounting kit can be ordered separately from Endress+Hauser as an accessory (→ 70).

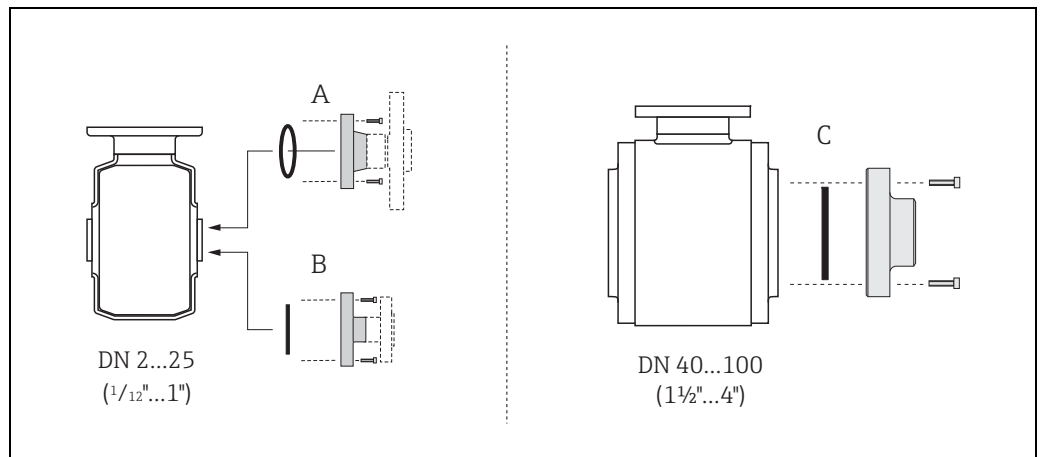

Fig. 23: Promag H process connections (DN 2 to 25 /  $\frac{1}{12}$  to 1", DN 40 to 100 /  $1\frac{1}{2}$  to 4")

**A = DN 2 to 25 / process connections with O-ring**

- Flanges (EN (DIN), ASME, JIS),
- External thread

**B = DN 2 to 25 / process connections with aseptic gasket seal**

- Weld nipples (EN 10357 (DIN 11850), ODT/SMS)
- Tri-Clamp L14AM7
- Coupling (DIN 11851, DIN 11864-1, SMS 1145 (only DN 25))
- Flange DIN 11864-2

**C = DN 40 to 100 / process connections with aseptic gasket seal**

- Weld nipples (EN 10357 (DIN 11850), ODT/SMS)
- Tri-Clamp L14AM7
- Coupling (DIN 11851, DIN 11864-1, SMS 1145)
- Flange DIN 11864-2

#### Seals

When installing the process connections, make sure that the seals are clean and correctly centered.



**Caution!**

- With metal process connections, you must fully tighten the screws. The process connection forms a metallic connection with the sensor, which ensures a defined compression of the seal.
- With plastic process connections, note the max. torques for lubricated threads (7 Nm / 5.2 lbf ft). With plastic flanges, always use seals between connection and counter flange.
- The seals must be replaced periodically, depending on the application, particularly in the case of gasket seals (aseptic version)!

The period between changes depends on the frequency of cleaning cycles, the cleaning temperature and the fluid temperature. Replacement seals can be ordered as accessories → 70.

### Welding the transmitter into the piping (weld nipples)



#### Caution!

Risk of destroying the measuring electronics. Make sure that the welding machine is *not* grounded via the sensor or the transmitter.

1. Tack-weld the sensor into the pipe. A suitable welding jig can be ordered separately as an accessory (→  70).
2. Loosen the screws on the process connection flange and remove the sensor, complete with the seal, from the pipe.
3. Weld the process connection to the pipe.
4. Reinstall the sensor in the pipe. Make sure that everything is clean and that the seal is correctly seated.



#### Note!

- If thin-walled foodstuffs pipes are not welded correctly, the heat could damage the installed seal. It is therefore advisable to remove the sensor and the seal prior to welding.
- The pipe has to be spread approximately 8 mm to permit disassembly.

### Cleaning with pigs

If pigs are used for cleaning, it is essential to take the inside diameters of the measuring tube and process connection into account. All the dimensions and lengths of the sensor and transmitter are provided in the separate documentation "Technical Documentation".

### 3.3.5 Installing the Promag L sensor



#### Caution!

- The protective covers mounted on the two sensor flanges (DN 25 to 300 / 1 to 12") are used to hold the lap joint flanges in place and to protect the PTFE liner during transportation. Consequently, do not remove these covers until immediately before the sensor is installed in the pipe.
- The covers must remain in place while the device is in storage.
- Make sure that the lining is not damaged or removed from the flanges.



#### Note!

Bolts, nuts, seals, etc. are not included in the scope of supply and must be supplied by the customer.

The sensor is designed for installation between the two piping flanges.

- Observe in any case the necessary screw tightening torques on → 28
- If grounding disks are used, follow the mounting instructions which will be enclosed with the shipment
- To comply with the device specification, a concentric installation in the measuring section is required

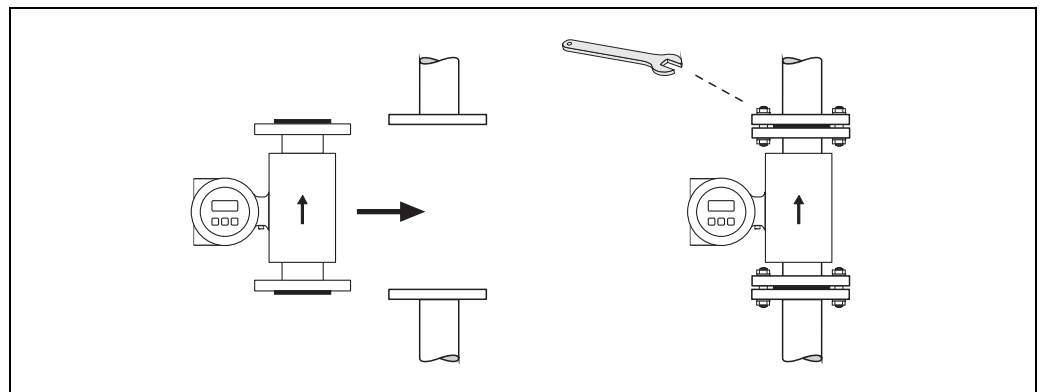

Fig. 24: Installing the Promag L sensor

#### Seals

Comply with the following instructions when installing seals:

- Hard rubber lining → additional seals are **always** necessary.
- Polyurethane lining → **no** seals are required.
- PTFE lining → **no** seals are required.
- For DIN flanges, use only seals according to EN 1514-1.
- Make sure that the seals do not protrude into the piping cross-section.



#### Caution!

Risk of short circuit!

Do not use electrically conductive sealing compounds such as graphite! An electrically conductive layer could form on the inside of the measuring tube and short-circuit the measuring signal.

#### Ground cable

- If necessary, special ground cables for potential equalization can be ordered as an accessory (→ 70).
- Information on potential equalization and detailed mounting instructions for the use of ground cables can be found on → 50.

### Screw tightening torques (Promag L)

Please note the following:

- The tightening torques listed below are for lubricated threads only.
- Always tighten the screws uniformly and in diagonally opposite sequence.
- Overtightening the screws will deform the sealing faces or damage the seals.
- The tightening torques listed below apply only to pipes not subjected to tensile stress.

*Promag L tightening torques for EN (DIN)*

Nominal diameter [mm]	EN (DIN) Pressure rating [bar]	Threaded fasteners	Max. tightening torque		
			Hard rubber [Nm]	Polyurethane [Nm]	PTFE [Nm]
25	PN 10/16	4 × M 12	-	6	11
32	PN 10/16	4 × M 16	-	16	27
40	PN 10/16	4 × M 16	-	16	29
50	PN 10/16	4 × M 16	-	15	40
65*	PN 10/16	8 × M 16	-	10	22
80	PN 10/16	8 × M 16	-	15	30
100	PN 10/16	8 × M 16	-	20	42
125	PN 10/16	8 × M 16	-	30	55
150	PN 10/16	8 × M 20	-	50	90
200	PN 16	12 × M 20	-	65	87
250	PN 16	12 × M 24	-	126	151
300	PN 16	12 × M 24	-	139	177
350	PN 6	12 × M 20	111	120	-
350	PN 10	16 × M 20	112	118	-
400	PN 6	16 × M 20	90	98	-
400	PN 10	16 × M 24	151	167	-
450	PN 6	16 × M 20	112	126	-
450	PN 10	20 × M 24	153	133	-
500	PN 6	20 × M 20	119	123	-
500	PN 10	20 × M 24	155	171	-
600	PN 6	20 × M 24	139	147	-
600	PN 10	20 × M 27	206	219	-
700	PN 6	24 × M 24	148	139	-
700	PN 10	24 × M 27	246	246	-
800	PN 6	24 × M 27	206	182	-
800	PN 10	24 × M 30	331	316	-
900	PN 6	24 × M 27	230	637	-
900	PN 10	28 × M 30	316	307	-
1000	PN 6	28 × M 27	218	208	-
1000	PN 10	28 × M 33	402	405	-
1200	PN 6	32 × M 30	319	299	-
1200	PN 10	32 × M 36	564	568	-

\* Designed acc. to EN 1092-1 (not to DIN 2501)

*Promag L tightening torques for ASME*

Nominal diameter		ASME Pressure rating [lbs]	Threaded fasteners	Max. tightening torque					
[mm]	[inch]			Hard rubber		Polyurethane		PTFE	
				[Nm]	[lbf · ft]	[Nm]	[lbf · ft]	[Nm]	[lbf · ft]
25	1"	Class 150	4 × 5/8"	-	-	5	4	14	13
40	1 1/2"	Class 150	8 × 5/8"	-	-	10	17	21	15
50	2"	Class 150	4 × 5/8"	-	-	15	11	40	29
80	3"	Class 150	4 × 5/8"	-	-	25	18	65	48
100	4"	Class 150	8 × 5/8"	-	-	20	15	44	32
150	6"	Class 150	8 × 3/4"	-	-	45	33	90	66
200	8"	Class 150	8 × 3/4"	-	-	65	48	87	64
250	10"	Class 150	12 × 7/8"	-	-	126	93	151	112
300	12"	Class 150	12 × 7/8"	-	-	146	108	177	131
350	14"	Class 150	12 × 1"	135	100	158	117	-	-
400	16"	Class 150	16 × 1"	128	94	150	111	-	-
450	18"	Class 150	16 × 1 1/8"	204	150	234	173	-	-
500	20"	Class 150	20 × 1 1/8"	183	135	217	160	-	-
600	24"	Class 150	20 × 1 1/4"	268	198	307	226	-	-

*Promag L tightening torques for AWWA*

Nominal diameter		AWWA Pressure rating	Threaded fasteners	Max. tightening torque					
[mm]	[inch]			Hart rubber		Polyurethane		PTFE	
				[Nm]	[lbf · ft]	[Nm]	[lbf · ft]	[Nm]	[lbf · ft]
700	28"	Class D	28 × 1 1/4"	247	182	292	215	-	-
750	30"	Class D	28 × 1 1/4"	287	212	302	223	-	-
800	32"	Class D	28 × 1 1/2"	394	291	422	311	-	-
900	36"	Class D	32 × 1 1/2"	419	309	430	317	-	-
1000	40"	Class D	36 × 1 1/2"	420	310	477	352	-	-
1050	42"	Class D	36 × 1 1/2"	528	389	518	382	-	-
1200	48"	Class D	44 × 1 1/2"	552	407	531	392	-	-

*Promag L tightening torques for AS 2129*

Nominal diameter		AS 2129 Pressure rating	Threaded fasteners	Max. tightening torque		
[mm]				Hard rubber [Nm]	Polyurethane [Nm]	PTFE [Nm]
350		Table E	12 × M 24	203	-	-
400		Table E	12 × M 24	226	-	-
450		Table E	16 × M 24	226	-	-
500		Table E	16 × M 24	271	-	-
600		Table E	16 × M 30	439	-	-
700		Table E	20 × M 30	355	-	-
750		Table E	20 × M 30	559	-	-
800		Table E	20 × M 30	631	-	-
900		Table E	24 × M 30	627	-	-
1000		Table E	24 × M 30	634	-	-
1200		Table E	32 × M 30	727	-	-

*Promag L tightening torques for AS 4087*

Nominal diameter [mm]	AS 4087 Pressure rating	Threaded fasteners	Max. tightening torque		
			Hard rubber [Nm]	Polyurethane [Nm]	PTFE [Nm]
350	PN 16	12 × M 24	203	-	-
375	PN 16	12 × M 24	137	-	-
400	PN 16	12 × M 24	226	-	-
450	PN 16	12 × M 24	301	-	-
500	PN 16	16 × M 24	271	-	-
600	PN 16	16 × M 27	393	-	-
700	PN 16	20 × M 27	330	-	-
750	PN 16	20 × M 30	529	-	-
800	PN 16	20 × M 33	631	-	-
900	PN 16	24 × M 33	627	-	-
1000	PN 16	24 × M 33	595	-	-
1200	PN 16	32 × M 33	703	-	-

### 3.3.6 Installing the Promag P sensor



#### Caution!

- The protective covers mounted on the two sensor flanges guard the PTFE, which is turned over the flanges. Consequently, do not remove these covers until **immediately before** the sensor is installed in the pipe.
- The covers must remain in place while the device is in storage.
- Make sure that the lining is not damaged or removed from the flanges.



#### Note!

Bolts, nuts, seals, etc. are not included in the scope of supply and must be supplied by the customer.

The sensor is designed for installation between the two piping flanges.

- Observe in any case the necessary screw tightening torques on → 31
- If grounding disks are used, follow the mounting instructions which will be enclosed with the shipment

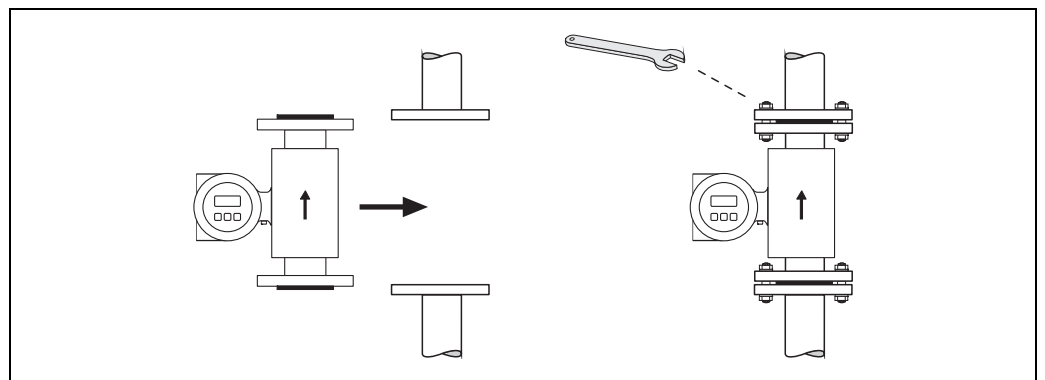

Fig. 25: Installing the Promag P sensor

#### Seals

Comply with the following instructions when installing seals:

- PTFE lining → **No** seals are required!
- For DIN flanges, use only seals according to EN 1514-1.
- Make sure that the seals do not protrude into the piping cross-section.



#### Caution!

Risk of short circuit! Do not use electrically conductive sealing compounds such as graphite! An electrically conductive layer could form on the inside of the measuring tube and short-circuit the measuring signal.

#### Ground cable

- If necessary, special ground cables for potential equalization can be ordered as an accessory (→ 70).
- Information on potential equalization and detailed mounting instructions for the use of ground cables can be found on → 50

#### Tightening torques for threaded fasteners (Promag P)

Please note the following:

- The tightening torques listed below are for lubricated threads only.
- Always tighten the screws uniformly and in diagonally opposite sequence.
- Overtightening the screws will deform the sealing faces or damage the seals.
- The tightening torques listed below apply only to pipes not subjected to tensile stress.

Tightening torques for:

- EN (DIN) → 32
- ASME → 32
- JIS → 33
- AS 2129 → 33
- AS 4087 → 33

*Promag P tightening torques for EN (DIN)*

Nominal diameter [mm]	EN (DIN) Pressure rating [bar]	Threaded fasteners	Max. tightening torque [Nm]
25	PN 40	4 × M 12	26
32	PN 40	4 × M 16	41
40	PN 40	4 × M 16	52
50	PN 40	4 × M 16	65
65 *	PN 16	8 × M 16	43
65	PN 40	8 × M 16	43
80	PN 16	8 × M 16	53
80	PN 40	8 × M 16	53
100	PN 16	8 × M 16	57
100	PN 40	8 × M 20	78
125	PN 16	8 × M 16	75
125	PN 40	8 × M 24	111
150	PN 16	8 × M 20	99
150	PN 40	8 × M 24	136
200	PN 10	8 × M 20	141
200	PN 16	12 × M 20	94
200	PN 25	12 × M 24	138
250	PN 10	12 × M 20	110
250	PN 16	12 × M 24	131
250	PN 25	12 × M 27	200
300	PN 10	12 × M 20	125
300	PN 16	12 × M 24	179
300	PN 25	16 × M 27	204
350	PN 10	16 × M 20	188
350	PN 16	16 × M 24	254
350	PN 25	16 × M 30	380
400	PN 10	16 × M 24	260
400	PN 16	16 × M 27	330
400	PN 25	16 × M 33	488
450	PN 10	20 × M 24	235
450	PN 16	20 × M 27	300
450	PN 25	20 × M 33	385
500	PN 10	20 × M 24	265
500	PN 16	20 × M 30	448
500	PN 25	20 × M 33	533
600	PN 10	20 × M 27	345
600 *	PN 16	20 × M 33	658
600	PN 25	20 × M 36	731

\* Designed acc. to EN 1092-1 (not to DIN 2501)

*Promag P tightening torques for ASME*

Nominal diameter		ASME Pressure rating [lbs]	Threaded fasteners	Max. tightening torque PTFE	
[mm]	[inch]			[Nm]	[lbf · ft]
25	1"	Class 150	4 × ½"	11	8
25	1"	Class 300	4 × 5/8"	14	10
40	1 ½"	Class 150	4 × ½"	24	18
40	1 ½"	Class 300	4 × ¾"	34	25
50	2"	Class 150	4 × 5/8"	47	35



Nominal diameter		ASME Pressure rating [lbs]	Threaded fasteners	Max. tightening torque PTFE	
[mm]	[inch]			[Nm]	[lbf · ft]
50	2"	Class 300	8 × 5/8"	23	17
80	3"	Class 150	4 × 5/8"	79	58
80	3"	Class 300	8 × 3/4"	47	35
100	4"	Class 150	8 × 5/8"	56	41
100	4"	Class 300	8 × 3/4"	67	49
150	6"	Class 150	8 × 3/4"	106	78
150	6"	Class 300	12 × 3/4"	73	54
200	8"	Class 150	8 × 3/4"	143	105
250	10"	Class 150	12 × 7/8"	135	100
300	12"	Class 150	12 × 7/8"	178	131
350	14"	Class 150	12 × 1"	260	192
400	16"	Class 150	16 × 1"	246	181
450	18"	Class 150	16 × 1 1/8"	371	274
500	20"	Class 150	20 × 1 1/8"	341	252
600	24"	Class 150	20 × 1 1/4"	477	352

*Promag P tightening torques for JIS*

Nominal diameter [mm]	JIS Pressure rating	Threaded fasteners	Max. tightening torque [Nm]	
			PTFE	
25	10K	4 × M 16	32	
25	20K	4 × M 16	32	
32	10K	4 × M 16	38	
32	20K	4 × M 16	38	
40	10K	4 × M 16	41	
40	20K	4 × M 16	41	
50	10K	4 × M 16	54	
50	20K	8 × M 16	27	
65	10K	4 × M 16	74	
65	20K	8 × M 16	37	
80	10K	8 × M 16	38	
80	20K	8 × M 20	57	
100	10K	8 × M 16	47	
100	20K	8 × M 20	75	
125	10K	8 × M 20	80	
125	20K	8 × M 22	121	
150	10K	8 × M 20	99	
150	20K	12 × M 22	108	
200	10K	12 × M 20	82	
200	20K	12 × M 22	121	
250	10K	12 × M 22	133	
250	20K	12 × M 24	212	
300	10K	16 × M 22	99	
300	20K	16 × M 24	183	

*Promag P tightening torques for AS 2129*

Nominal diameter [mm]	AS 2129 Pressure rating	Threaded fasteners	Max. tightening torque [Nm]	
			PTFE	
25	Table E	4 × M 12	21	
50	Table E	4 × M 16	42	

*Promag P tightening torques for AS 4087*

Nominal diameter [mm]	AS 4087 Pressure rating	Threaded fasteners	Max. tightening torque [Nm]	
			PTFE	
50	PN 16	4 × M 16	42	

### 3.3.7 Installing the Promag W sensor



Note!

Bolts, nuts, seals, etc. are not included in the scope of supply and must be supplied by the customer.

The sensor is designed for installation between the two piping flanges.

- Observe in any case the necessary screw tightening torques on → 34
- If grounding disks are used, follow the mounting instructions which will be enclosed with the shipment

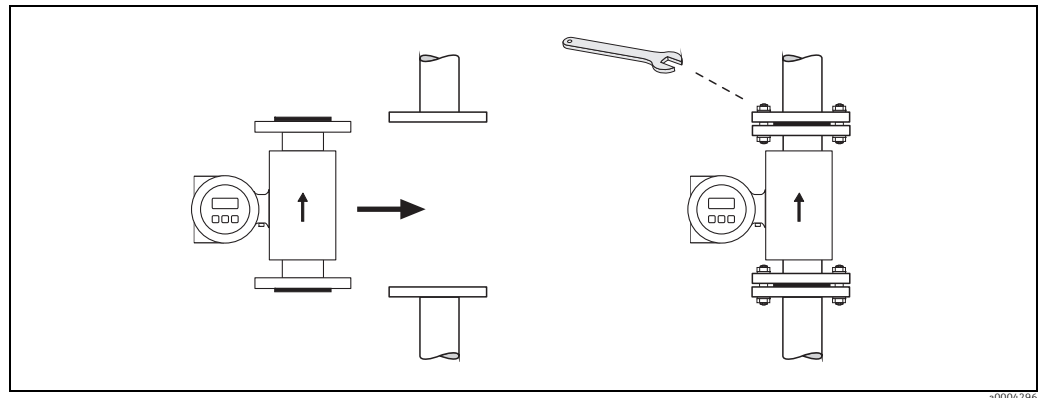

Fig. 26: Installing the Promag W sensor

#### Seals

Comply with the following instructions when installing seals:

- Hard rubber lining → additional seals are **always** necessary.
- Polyurethane lining → **no** seals are required.
- For DIN flanges, use only seals according to EN 1514-1.
- Make sure that the seals do not protrude into the piping cross-section.



Caution!

Risk of short circuit!

Do not use electrically conductive sealing compounds such as graphite! An electrically conductive layer could form on the inside of the measuring tube and short-circuit the measuring signal.

#### Ground cable

- If necessary, special ground cables for potential equalization can be ordered as an accessory (→ 70).
- Information on potential equalization and detailed mounting instructions for the use of ground cables can be found on → 50

#### Screw tightening torques (Promag W)

Please note the following:

- The tightening torques listed below are for lubricated threads only.
- Always tighten the screws uniformly and in diagonally opposite sequence.
- Overtightening the screws will deform the sealing faces or damage the seals.
- The tightening torques listed below apply only to pipes not subjected to tensile stress.

Tightening torques for:

- EN (DIN) → 35
- JIS → 37
- ASME → 36
- AWWA → 37
- AS 2129 → 38
- AS 4087 → 38

*Promag W tightening torques for EN (DIN)*

Nominal diameter [mm]	EN (DIN) Pressure rating [bar]	Threaded fasteners	Max. tightening torque [Nm]	
			Hard rubber	Polyurethane
25	PN 40	4 × M 12	-	15
32	PN 40	4 × M 16	-	24
40	PN 40	4 × M 16	-	31
50	PN 40	4 × M 16	48	40
65*	PN 16	8 × M 16	32	27
65	PN 40	8 × M 16	32	27
80	PN 16	8 × M 16	40	34
80	PN 40	8 × M 16	40	34
100	PN 16	8 × M 16	43	36
100	PN 40	8 × M 20	59	50
125	PN 16	8 × M 16	56	48
125	PN 40	8 × M 24	83	71
150	PN 16	8 × M 20	74	63
150	PN 40	8 × M 24	104	88
200	PN 10	8 × M 20	106	91
200	PN 16	12 × M 20	70	61
200	PN 25	12 × M 24	104	92
250	PN 10	12 × M 20	82	71
250	PN 16	12 × M 24	98	85
250	PN 25	12 × M 27	150	134
300	PN 10	12 × M 20	94	81
300	PN 16	12 × M 24	134	118
300	PN 25	16 × M 27	153	138
350	PN 6	12 × M 20	111	120
350	PN 10	16 × M 20	112	118
350	PN 16	16 × M 24	152	165
350	PN 25	16 × M 30	227	252
400	PN 6	16 × M 20	90	98
400	PN 10	16 × M 24	151	167
400	PN 16	16 × M 27	193	215
400	PN 25	16 × M 33	289	326
450	PN 6	16 × M 20	112	126
450	PN 10	20 × M 24	153	133
450	PN 16	20 × M 27	198	196
450	PN 25	20 × M 33	256	253
500	PN 6	20 × M 20	119	123
500	PN 10	20 × M 24	155	171
500	PN 16	20 × M 30	275	300
500	PN 25	20 × M 33	317	360
600	PN 6	20 × M 24	139	147
600	PN 10	20 × M 27	206	219
600*	PN 16	20 × M 33	415	443
600	PN 25	20 × M 36	431	516
700	PN 6	24 × M 24	148	139
700	PN 10	24 × M 27	246	246
700	PN 16	24 × M 33	278	318

Nominal diameter [mm]	EN (DIN) Pressure rating [bar]	Threaded fasteners	Max. tightening torque [Nm]	
			Hard rubber	Polyurethane
700	PN 25	24 × M 39	449	507
800	PN 6	24 × M 27	206	182
800	PN 10	24 × M 30	331	316
800	PN 16	24 × M 36	369	385
800	PN 25	24 × M 45	664	721
900	PN 6	24 × M 27	230	637
900	PN 10	28 × M 30	316	307
900	PN 16	28 × M 36	353	398
900	PN 25	28 × M 45	690	716
1000	PN 6	28 × M 27	218	208
1000	PN 10	28 × M 33	402	405
1000	PN 16	28 × M 39	502	518
1000	PN 25	28 × M 52	970	971
1200	PN 6	32 × M 30	319	299
1200	PN 10	32 × M 36	564	568
1200	PN 16	32 × M 45	701	753
1400	PN 6	36 × M 33	430	398
1400	PN 10	36 × M 39	654	618
1400	PN 16	36 × M 45	729	762
1600	PN 6	40 × M 33	440	417
1600	PN 10	40 × M 45	946	893
1600	PN 16	40 × M 52	1007	1100
1800	PN 6	44 × M 36	547	521
1800	PN 10	44 × M 45	961	895
1800	PN 16	44 × M 52	1108	1003
2000	PN 6	48 × M 39	629	605
2000	PN 10	48 × M 45	1047	1092
2000	PN 16	48 × M 56	1324	1261

\* Designed acc. to EN 1092-1 (not to DIN 2501)

*Promag W tightening torques for ASME*

Nominal diameter		ASME Pressure rating [lbs]	Threaded fasteners	Max. tightening torque			
[mm]	[inch]			Hard rubber [Nm]	[lbf · ft]	Polyurethane [Nm]	[lbf · ft]
25	1"	Class 150	4 × ½"	-	-	7	5
25	1"	Class 300	4 × 5/8"	-	-	8	6
40	1 ½"	Class 150	4 × ½"	-	-	10	7
40	1 ½"	Class 300	4 × ¾"	-	-	15	11
50	2"	Class 150	4 × 5/8"	35	26	22	16
50	2"	Class 300	8 × 5/8"	18	13	11	8
80	3"	Class 150	4 × 5/8"	60	44	43	32
80	3"	Class 300	8 × ¾"	38	28	26	19
100	4"	Class 150	8 × 5/8"	42	31	31	23
100	4"	Class 300	8 × ¾"	58	43	40	30
150	6"	Class 150	8 × ¾"	79	58	59	44
150	6"	Class 300	12 × ¾"	70	52	51	38
200	8"	Class 150	8 × ¾"	107	79	80	59
250	10"	Class 150	12 × 7/8"	101	74	75	55
300	12"	Class 150	12 × 7/8"	133	98	103	76
350	14"	Class 150	12 × 1"	135	100	158	117
400	16"	Class 150	16 × 1"	128	94	150	111
450	18"	Class 150	16 × 1 ⅛"	204	150	234	173
500	20"	Class 150	20 × 1 ⅛"	183	135	217	160
600	24"	Class 150	20 × 1 ¼"	268	198	307	226

*Promag W tightening torques for JIS*

Nominal diameter [mm]	JIS Pressure rating	Threaded fasteners	Max. tightening torque [Nm]	
			Hard rubber	Polyurethane
25	10K	4 × M 16	-	19
25	20K	4 × M 16	-	19
32	10K	4 × M 16	-	22
32	20K	4 × M 16	-	22
40	10K	4 × M 16	-	24
40	20K	4 × M 16	-	24
50	10K	4 × M 16	40	33
50	20K	8 × M 16	20	17
65	10K	4 × M 16	55	45
65	20K	8 × M 16	28	23
80	10K	8 × M 16	29	23
80	20K	8 × M 20	42	35
100	10K	8 × M 16	35	29
100	20K	8 × M 20	56	48
125	10K	8 × M 20	60	51
125	20K	8 × M 22	91	79
150	10K	8 × M 20	75	63
150	20K	12 × M 22	81	72
200	10K	12 × M 20	61	52
200	20K	12 × M 22	91	80
250	10K	12 × M 22	100	87
250	20K	12 × M 24	159	144
300	10K	16 × M 22	74	63
300	20K	16 × M 24	138	124

*Promag W tightening torques for AWWA*

Nominal diameter		AWWA Pressure rating	Threaded fasteners	Max. tightening torque			
[mm]	[inch]			Hard rubber		Polyurethane	
				[Nm]	[lbf · ft]	[Nm]	[lbf · ft]
700	28"	Class D	28 × 1 ¼"	247	182	292	215
750	30"	Class D	28 × 1 ¼"	287	212	302	223
800	32"	Class D	28 × 1 ½"	394	291	422	311
900	36"	Class D	32 × 1 ½"	419	309	430	317
1000	40"	Class D	36 × 1 ½"	420	310	477	352
1050	42"	Class D	36 × 1 ½"	528	389	518	382
1200	48"	Class D	44 × 1 ½"	552	407	531	392
1350	54"	Class D	44 × 1 ¾"	730	538	633	467
1500	60"	Class D	52 × 1 ¾"	758	559	832	614
1650	66"	Class D	52 × 1 ¾"	946	698	955	704
1800	72"	Class D	60 × 1 ¾"	975	719	1087	802
2000	78"	Class D	64 × 2"	853	629	786	580

*Promag W tightening torques for AS 2129*

Nominal diameter [mm]	AS 2129 Pressure rating	Threaded fasteners	Max. tightening torque [Nm] Hard rubber
50	Table E	4 × M 16	32
80	Table E	4 × M 16	49
100	Table E	8 × M 16	38
150	Table E	8 × M 20	64
200	Table E	8 × M 20	96
250	Table E	12 × M 20	98
300	Table E	12 × M 24	123
350	Table E	12 × M 24	203
400	Table E	12 × M 24	226
450	Table E	16 × M 24	226
500	Table E	16 × M 24	271
600	Table E	16 × M 30	439
700	Table E	20 × M 30	355
750	Table E	20 × M 30	559
800	Table E	20 × M 30	631
900	Table E	24 × M 30	627
1000	Table E	24 × M 30	634
1200	Table E	32 × M 30	727

*Promag W tightening torques for AS 4087*

Nominal diameter [mm]	AS 4087 Pressure rating	Threaded fasteners	Max. tightening torque [Nm] Hard rubber
50	Table E	4 × M 16	32
80	PN 16	4 × M 16	49
100	PN 16	4 × M 16	76
150	PN 16	8 × M 20	52
200	PN 16	8 × M 20	77
250	PN 16	8 × M 20	147
300	PN 16	12 × M 24	103
350	PN 16	12 × M 24	203
375	PN 16	12 × M 24	137
400	PN 16	12 × M 24	226
450	PN 16	12 × M 24	301
500	PN 16	16 × M 24	271
600	PN 16	16 × M 27	393
700	PN 16	20 × M 27	330
750	PN 16	20 × M 30	529
800	PN 16	20 × M 33	631
900	PN 16	24 × M 33	627
1000	PN 16	24 × M 33	595
1200	PN 16	32 × M 33	703

### 3.3.8 Turning the transmitter housing

1. Loosen the two securing screws.
2. Turn the bayonet lock as far as it will go.
3. Carefully lift the transmitter housing:
  - Promag D: approx. 10 mm (0.39 in) above the securing screws
  - Promag E/H/L/P/W: to the stop
4. Turn the transmitter housing to the desired position:
  - Promag D: max. 180° clockwise or max. 180° counterclockwise
  - Promag E/H/L/P/W: max. 280° clockwise or max. 20° counterclockwise
5. Lower the housing into position and re-engage the bayonet catch.
6. Retighten the two securing screws.

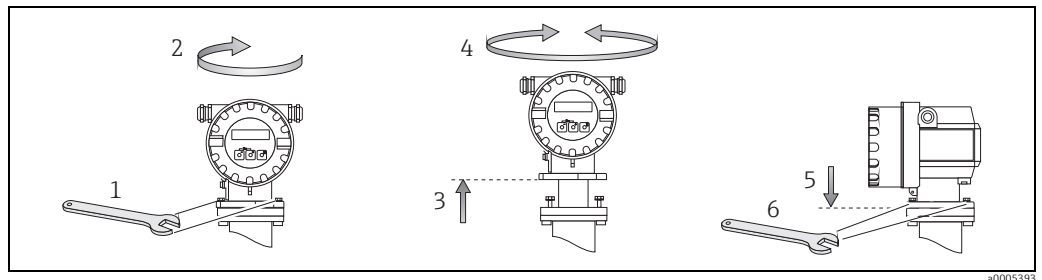

Fig. 27: Turning the transmitter housing

### 3.3.9 Turning the onsite display

1. Unscrew cover of the electronics compartment from the transmitter housing.
2. Remove the display module from the transmitter retaining rails.
3. Turn the display to the desired position (max.  $4 \times 45^\circ$  in each direction).
4. Fit the display back onto the retaining rails.
5. Screw the cover of the electronics compartment firmly back onto the transmitter housing.

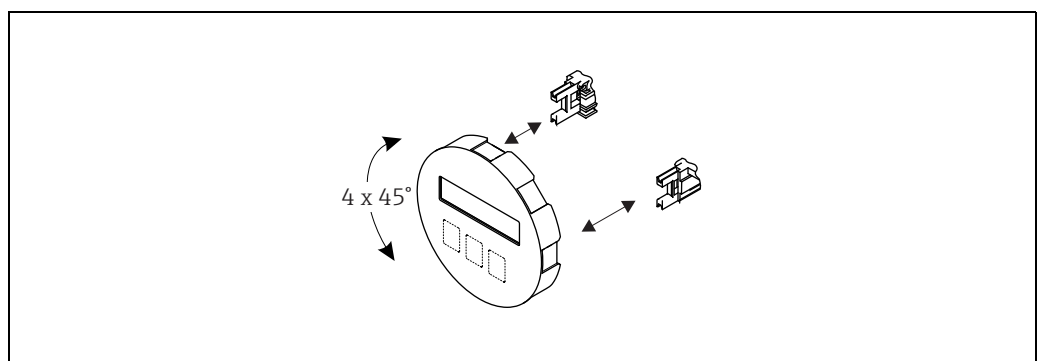

Fig. 28: Turning the local display

### 3.3.10 Mounting the transmitter (remote version)

The transmitter can be mounted in the following ways:

- Wall mounting
- Pipe mounting (with separate mounting kit, accessories → 70)

The transmitter and the sensor must be mounted separate in the following circumstances:

- Poor accessibility
- Lack of space
- Extreme fluid/ambient temperatures (temperature ranges → 88)
- Severe vibration ( $> 2 \text{ g}/2 \text{ h}$  per day; 10 to 100 Hz)



Caution!

- The ambient temperature range  $-20$  to  $+60 \text{ °C}$  ( $-4$  to  $+140 \text{ °F}$ ) may not be exceeded at the mounting location. Avoid direct sunlight.
- If the device is mounted to a warm pipe, make sure that the housing temperature does not exceed  $+60 \text{ °C}$  ( $+140 \text{ °F}$ ), which is the maximum permissible temperature.

Mount the transmitter as illustrated in → 29.

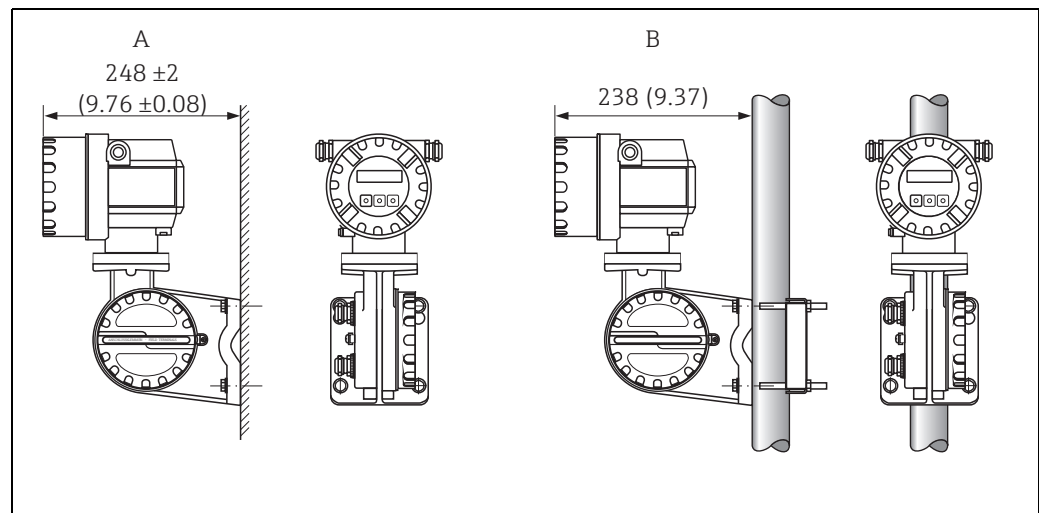















Fig. 29: Mounting the transmitter (remote version). Engineering unit mm (in)

- A Direct wall mounting  
B Pipe mounting



### 3.4 Post-installation check

Perform the following checks after installing the measuring device in the pipe:

Device condition and specifications	Notes
Is the device damaged (visual inspection)?	–
Does the device correspond to specifications at the measuring point, including process temperature and pressure, ambient temperature, minimum fluid conductivity, measuring range, etc.?	→  89
Installation	Notes
Does the arrow on the sensor nameplate match the actual direction of flow through the pipe?	–
Is the position of the measuring electrode plane correct?	→  13
Is the position of the empty pipe detection electrode correct?	→  13
Were all screws tightened to the specified torques when the sensor was installed?	Promag D →  20 Promag E →  23 Promag L →  28 Promag P →  31 Promag W →  34
Were the correct seals used (type, material, installation)?	Promag D →  18 Promag E →  22 Promag H →  25 Promag L →  27 Promag P →  31 Promag W →  34
Are the measuring point number and labeling correct (visual inspection)?	–
Process environment / process conditions	Notes
Were the inlet and outlet runs respected?	Inlet run $\geq 5 \times \text{DN}$ Outlet run $\geq 2 \times \text{DN}$
Is the measuring device protected against moisture and direct sunlight?	–
Is the sensor adequately protected against vibration (attachment, support)?	Acceleration up to 2 g by analogy with IEC 600 68-2-8

## 4 Wiring



### Warning!

When using remote versions, only sensors and transmitters with the same serial number can be connected up. Measuring errors can occur if the devices are not connected in this way.



### Note!

The device does not have an internal circuit breaker. For this reason, assign the device a switch or power-breaker switch capable of disconnecting the power supply line from the mains.

### 4.1 Connecting the remote version

#### 4.1.1 Connecting Promag D/E/H/L/P/W



### Warning!

- Risk of electric shock! Switch off the power supply before opening the device. Do **not** install or wire the device while it is connected to the power supply. Failure to comply with this precaution can result in irreparable damage to the electronics.

- Risk of electric shock! Connect the protective conductor to the ground terminal on the housing before the power supply is applied.



### Caution!

- Only sensors and transmitters with the same serial number can be connected to one another. Communication problems can occur if the devices are not connected in this way.
- Risk of damaging the coil driver. Always switch off the power supply before connecting or disconnecting the coil cable.

### Procedure

1. Transmitter: Loosen the securing clamp and remove the cover from the connection compartment (a).
2. Sensor: Remove the cover from the connection housing (b).
3. Feed the signal cable (c) and the coil cable (d) through the appropriate cable entries.



### Caution!

Route the connecting cables securely (see "Length of connecting cable" → 16).

4. Terminate the signal and coil current cable as indicated in the table:  
Promag D/E/L/P/W → Refer to the table → 45  
Promag H → Refer to the "Cable termination" table → 46
5. Establish the wiring between the sensor and the transmitter.  
The electrical wiring diagram that applies to your device can be found:
  - In the corresponding graphic:
    - 30 (Promag D); → 31 (Promag E/L/P/W); → 32 (Promag H)
  - In the cover of the sensor and transmitter



### Note!

The cable shields of the Promag H sensor are grounded by means of the strain relief terminals (see also the "Cable termination" table → 46)



### Caution!

Insulate the shields of cables that are not connected to eliminate the risk of short-circuits with neighboring cable shields inside the connection housing.

6. Transmitter: Secure the cover to the connection compartment (a) and tighten the socket head cap screw of the securing clamp.
7. Sensor: Secure the cover on the connection housing (b).

**Promag D**

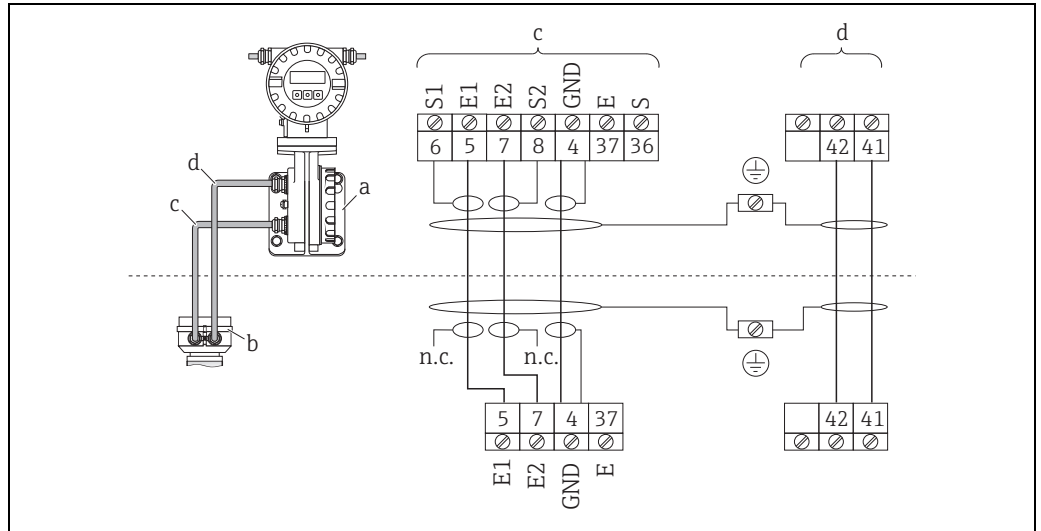

a0010695

Fig. 30: Connecting the remote version of Promag D

- a Wall-mount housing connection compartment
- b Cover of the sensor connection housing
- c Signal cable
- d Coil current cable
- n.c. Not connected, insulated cable shields

Wire colors/Terminal No.:  
 5/6 = braun, 7/8 = white, 4 = green, 37/36 = yellow

**Promag E/L/P/W**

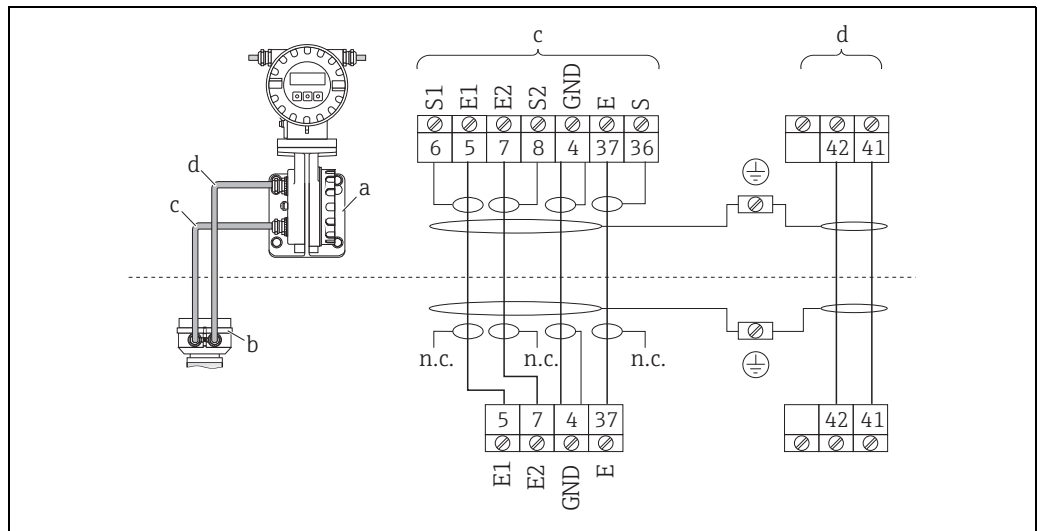

A0012461

Fig. 31: Connecting the remote version of Promag E/L/P/W

- a Wall-mount housing connection compartment
- b Cover of the sensor connection housing
- c Signal cable
- d Coil current cable
- n.c. Not connected, insulated cable shields

Wire colors/Terminal No.:  
 5/6 = braun, 7/8 = white, 4 = green, 37/36 = yellow

Promag H

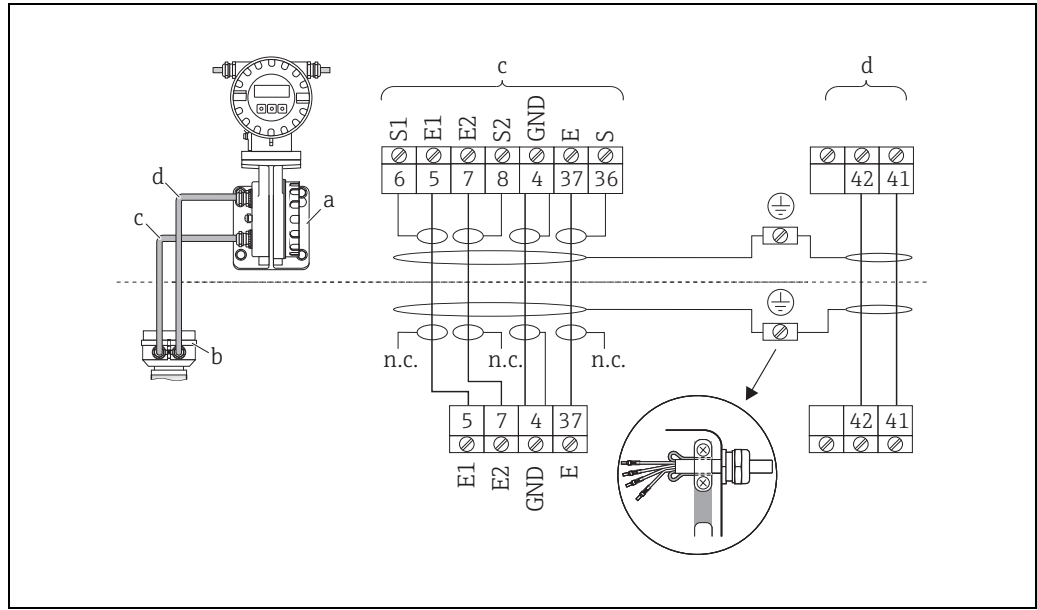

A0012477

Fig. 32: Connecting the remote version of Promag H

- a Wall-mount housing connection compartment
- b Cover of the sensor connection housing
- c Signal cable
- d Coil current cable
- n.c. Not connected, insulated cable shields

Wire colors/Terminal No.:  
 5/6 = braun, 7/8 = white, 4 = green, 37/36 = yellow

**Cable termination for the remote version  
Promag D/E/L/P/W**

Terminate the signal and coil current cables as shown in the figure below (Detail A).  
Ferrules must be provided on the fine-wire cores (Detail B: 1 = red ferrules,  $\varnothing$  1.0 mm; 2 = white ferrules,  $\varnothing$  0.5 mm).

☞ **Caution!**

When fitting the connectors, pay attention to the following points:

- *Signal cable* → Make sure that the ferrules do not touch the wire shield on the sensor side.  
Minimum distance = 1 mm (exception "GND" = green cable)
- *Coil current cable* → Insulate one core of the three-core wire at the level of the core reinforcement; you only require two cores for the connection.

**TRANSMITTER**

Signal cable

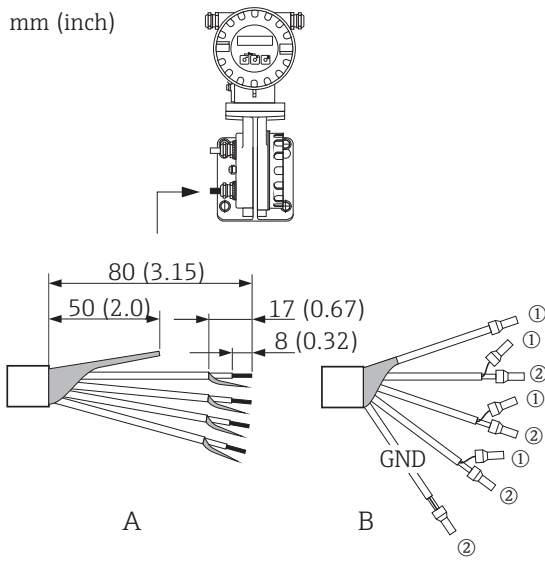

a0005391

Coil current cable

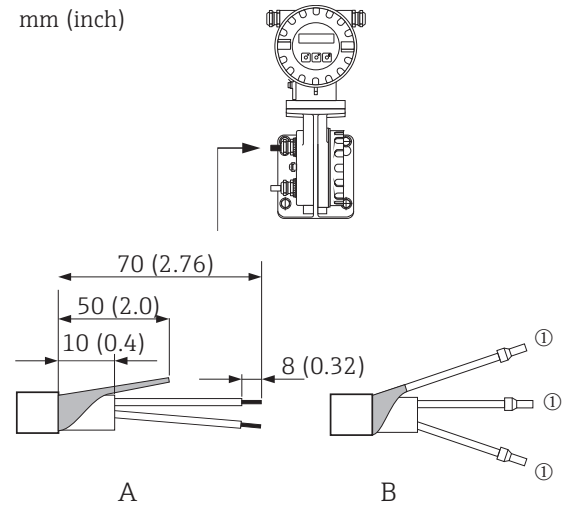

a0005390

**SENSOR**

Signal cable

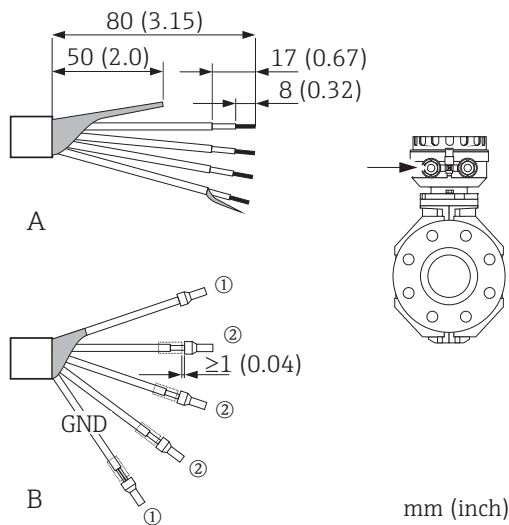

A0003241

Coil current cable

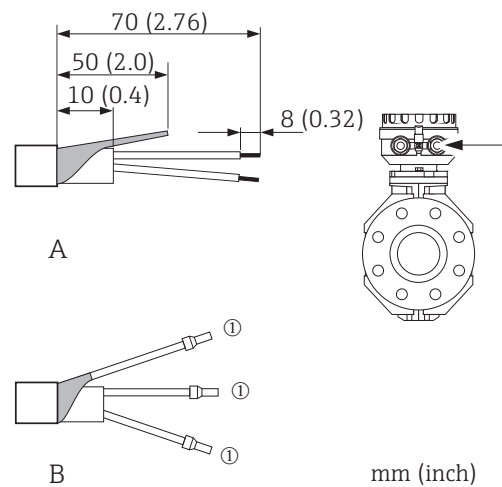

A0003240

**Cable termination for the remote version  
Promag H**

Terminate the signal and coil current cables as shown in the figure below (Detail A).  
Ferrules must be provided on the fine-wire cores (Detail B: 1 = red ferrules,  $\varnothing$  1.0 mm; 2 = white ferrules,  $\varnothing$  0.5 mm).

**Caution!**

When fitting the connectors, pay attention to the following points:

- *Signal cable* → Make sure that the ferrules do not touch the wire shield on the sensor side.  
Minimum distance = 1 mm (exception "GND" = green cable).
- *Coil current cable* → Insulate one core of the three-core wire at the level of the core reinforcement; you only require two cores for the connection.
- On the sensor side, reverse both cable shields approx. 15 mm over the outer jacket. The strain relief ensures an electrical connection with the connection housing.

**TRANSMITTER**

Signal cable

Coil current cable

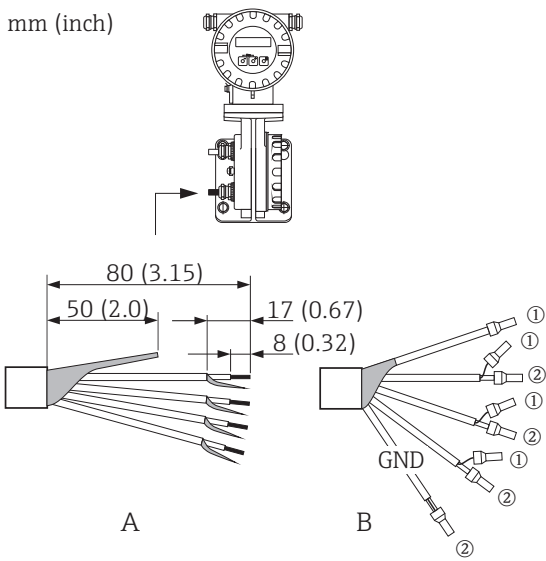

a0005391

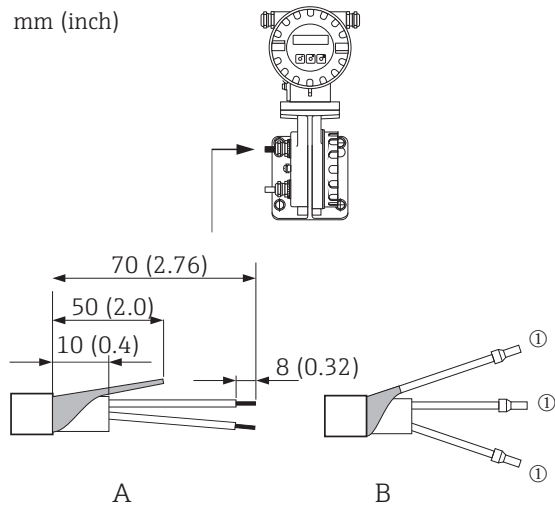

a0005390

**SENSOR**

Signal cable

Coil current cable

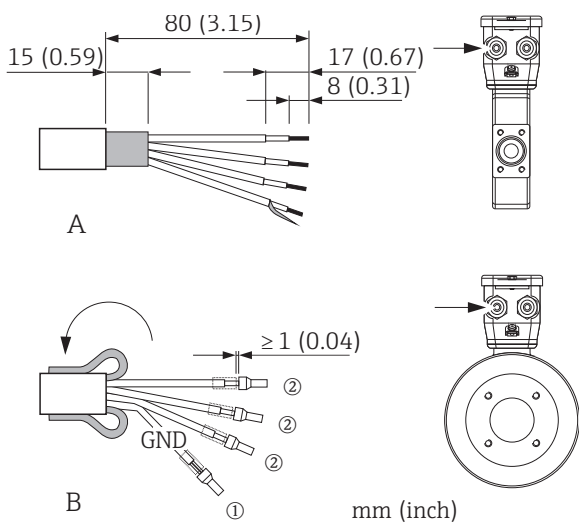

A0002647

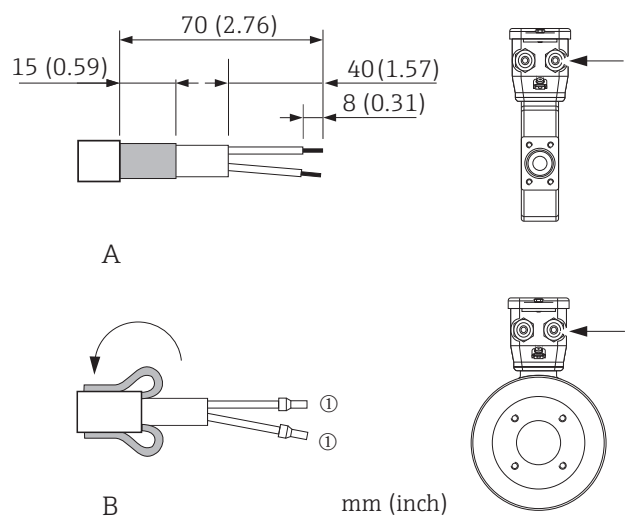

A0002648

### 4.1.2 Cable specifications

#### Electrode cable

- $3 \times 0.38 \text{ mm}^2$  PVC cable with common, braided copper shield ( $\varnothing \sim 9.5 \text{ mm} / 0.37''$ ) and individually shielded cores
- With Empty Pipe Detection (EPD):  $4 \times 0.38 \text{ mm}^2$  PVC cable with common, braided copper shield ( $\varnothing \sim 9.5 \text{ mm} / 0.37''$ ) and individually shielded cores
- Conductor resistance:  $\leq 50 \text{ } \Omega/\text{km}$
- Capacitance: core/shield:  $\leq 420 \text{ pF/m}$
- Permanent operating temperature:  $-20$  to  $+80 \text{ } ^\circ\text{C}$
- Cable cross-section: max.  $2.5 \text{ mm}^2$

#### Coil current cable

- $3 \times 0.75 \text{ mm}^2$  PVC cable with common, braided copper shield ( $\varnothing \sim 9 \text{ mm} / 0.35''$ )
- Conductor resistance:  $\leq 37 \text{ } \Omega/\text{km}$
- Capacitance: core/core, shield grounded:  $\leq 120 \text{ pF/m}$
- Operating temperature:  $-20$  to  $+80 \text{ } ^\circ\text{C}$
- Cable cross-section: max.  $2.5 \text{ mm}^2$
- Test voltage for cable insulation:  $\geq 1433 \text{ V AC r.m.s. } 50/60 \text{ Hz}$  or  $\geq 2026 \text{ V DC}$

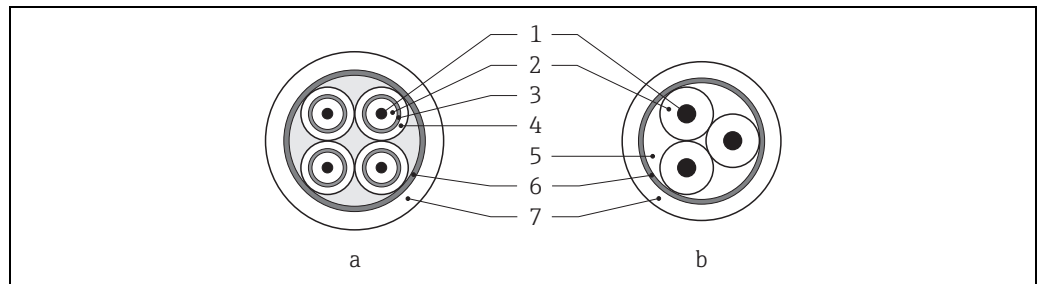

Fig. 33: Cable cross-section

- |   |                    |
|---|--------------------|
| a | Signal cable       |
| b | Coil current cable |
| 1 | Core               |
| 2 | Core insulation    |
| 3 | Core shield        |
| 4 | Core jacket        |
| 5 | Core reinforcement |
| 6 | Cable shield       |
| 7 | Outer jacket       |

#### Operation in zones of severe electrical interference:

The measuring device complies with the general safety requirements in accordance with EN 61010 and the EMC requirements of IEC/EN 61326.



#### Caution!

Grounding is by means of the ground terminals provided for the purpose inside the connection housing. Ensure that the stripped and twisted lengths of cable shield to the ground terminal are as short as possible.

## 4.2 Connecting the measuring unit

### 4.2.1 Transmitter



#### Warning!

- Risk of electric shock!  
Switch off the power supply before opening the device. **Do not** install or wire the device while it is connected to the power supply. Failure to comply with this precaution can result in irreparable damage to the electronics.
- Risk of electric shock!  
Connect the protective conductor to the ground terminal on the housing before the power supply is applied.
- Compare the specifications on the nameplate with the local supply voltage and frequency. The national regulations governing the installation of electrical equipment also apply.
- The transmitter must be included in the building fuse system.

1. Unscrew cover of the electronics compartment from the transmitter housing.
2. Press the side latches and flip down the cover of the connection compartment.
3. Feed the cable for the power supply and the signal cable through the appropriate cable entries.
4. Remove the terminal connectors from the transmitter housing and connect the cable for the power supply and the signal cable:
  - Wiring diagram → 34
  - Terminal assignment → 49
5. Plug the terminal connectors back into the transmitter housing.



#### Note!

The connectors are coded so you cannot mix them up.

6. Secure the ground cable to the ground terminal.
7. Flip up the cover of the connection compartment.
8. Screw the cover of the electronics compartment firmly onto the transmitter housing.

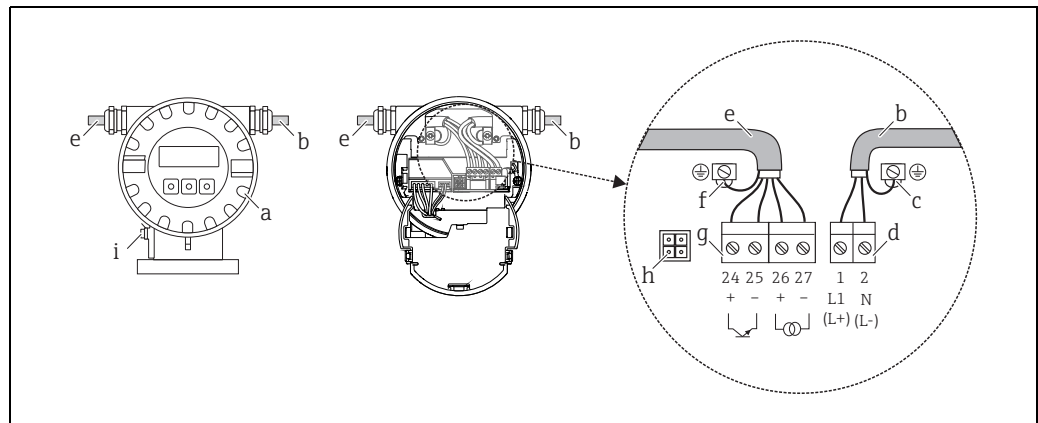

Fig. 34: Connecting the transmitter (aluminum field housing).  
Cable cross-section: max. 2.5 mm<sup>2</sup>

- a Electronics compartment cover
- b Cable for power supply: 85 to 250 V AC, 11 to 40 V DC, 20 to 28 V AC
- c Ground terminal for power supply cable
- d Terminal connector for power supply: **No. 1–2** → 49 (terminal assignment)
- e Signal cable
- f Ground terminal for signal cable
- g Terminal connector for signal cable: **No. 24–27** → 49 (terminal assignment)
- h Service connector
- i Ground terminal for potential equalization



### 4.2.2 Terminal assignment

Order characteristic for "inputs/outputs"	Terminal No. (outputs/power supply)		
	24 (+) / 25 (-)	26 (+) / 27 (-)	1 (L1/L+) / 2 (N/L-)
A	Pulse output	Current output HART	Power supply



Note!

Functional values of the outputs and power supply → 86

### 4.2.3 HART connection

Users have the following connection options at their disposal:

- Direct connection to transmitter by means of terminals 26(+) and 27 (-)
- Connection by means of the 4 to 20 mA circuit.
- The measuring loop's minimum load must be at least 250 Ω.
- After commissioning, make the following settings:
  - CURRENT SPAN function → "4–20 mA HART"
  - Switch HART write protection on or off → 60

#### Connection of the HART handheld communicator

See also the documentation issued by the HART Communication Foundation, and in particular HCF LIT 20: "HART, a technical summary".

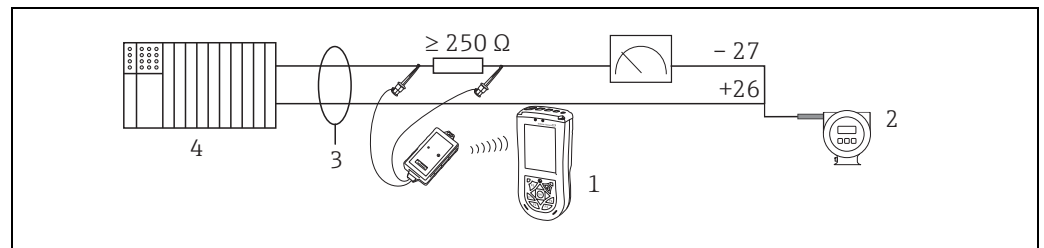

Fig. 35: Electrical connection of HART handheld Field Xpert SFX100

- 1 HART handheld Field Xpert SFX100
- 2 Auxiliary energy
- 3 Shielding
- 4 Other devices or PLC with passive input

#### Connection of a PC with an operating software

In order to connect a PC with an operating software (e.g. "FieldCare"), a HART modem (e.g. Commubox FXA 195) is needed.

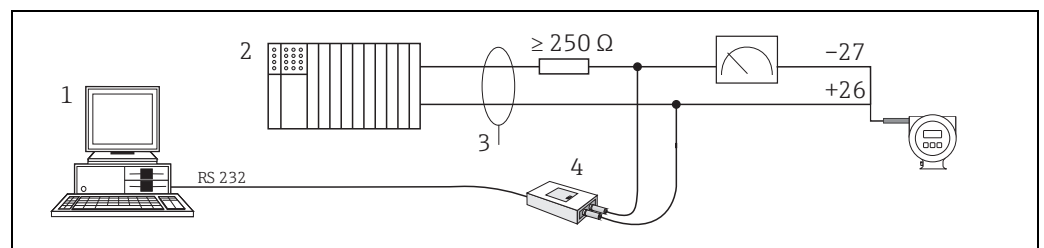

Fig. 36: Electrical connection of a PC with an operating software

- 1 PC with an operating software
- 2 Other evaluation devices or PLC with passive input
- 3 Shield
- 4 HART modem, e.g. Commubox FXA 195

### 4.3 Potential equalization



Warning!

The measuring system must be included in the potential equalization.

Perfect measurement is only ensured when the fluid and the sensor have the same electrical potential. This is ensured by the reference electrode integrated in the sensor as standard.

The following should also be taken into consideration for potential equalization:

- Internal grounding concepts in the company
- Operating conditions, such as the material/grounding of the pipes (see Table)

#### 4.3.1 Potential equalization for Promag D

- No reference electrode is integrated!  
For the two ground disks of the sensor an electrical connection to the fluid is always ensured.
- Exampels for connections → 50

#### 4.3.2 Potential equalization for Promag E/L/P/W

- Reference electrode integrated in the sensor as standard
- Exampels for connections → 51

#### 4.3.3 Potential equalization for Promag H

No reference electrode is integrated!

For the metal process connections of the sensor an electrical connection to the fluid is always ensured.



Caution!

If using process connections made of a synthetic material, ground rings have to be used to ensure that potential is equalized (→ 25). The necessary ground rings can be ordered separately from Endress+Hauser as accessories (→ 70).

#### 4.3.4 Exampels for potential equalization connections for Promag D

##### Standard case

Operating conditions	Potential equalization
<p>When using the measuring device in a:</p> <ul style="list-style-type: none"> <li>■ Metal, grounded pipe</li> <li>■ Plastic pipe</li> <li>■ Pipe with insulating lining</li> </ul> <p>Potential equalization takes place via the ground terminal of the transmitter (standard situation).</p> <p> <b>Note!</b> When installing in metal pipes, we recommend you connect the ground terminal of the transmitter housing with the piping.</p>	<p style="text-align: right; font-size: small;">a0010702</p> <p><i>Fig. 37: Via the ground terminal of the transmitter</i></p>

**Special cases for Promag D as wafer version**

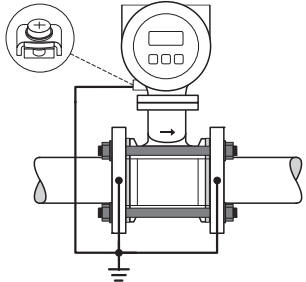
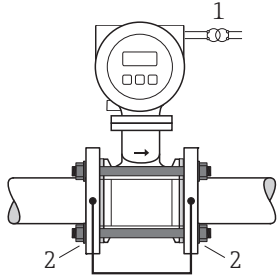
Operating conditions	Potential equalization
<p>When using the measuring device in a:</p> <ul style="list-style-type: none"> <li>▪ Metal pipe that is not grounded</li> </ul> <p>This connection method also applies in situations where:</p> <ul style="list-style-type: none"> <li>▪ Customary potential equalization cannot be ensured</li> <li>▪ Excessively high equalizing currents can be expected</li> </ul> <p>Potential equalization takes place via the ground terminal of the transmitter and the two pipe flanges.</p> <p>Here, the ground cable (copper wire, 6 mm<sup>2</sup> / 0.0093 in<sup>2</sup>) is mounted directly on the conductive flange coating with flange screws.</p>	 <p style="text-align: right;">a0010703</p> <p>Fig. 38: Via the ground terminal of the transmitter and the flanges of the pipe</p>
<p>When using the measuring device in a:</p> <ul style="list-style-type: none"> <li>▪ Pipe with a cathodic protection unit</li> </ul> <p>The device is installed potential-free in the pipe.</p> <p>Only the two flanges of the pipe are connected with a ground cable (copper wire, 6 mm<sup>2</sup> / 0.0093 in<sup>2</sup>). Here, the ground cable is mounted directly on the conductive flange coating with flange screws.</p> <p>Note the following when installing:</p> <ul style="list-style-type: none"> <li>▪ The applicable regulations regarding potential-free installation must be observed.</li> <li>▪ There should be <b>no</b> electrically conductive connection between the pipe and the device.</li> <li>▪ The mounting material must withstand the applicable torques.</li> </ul>	 <p style="text-align: right;">a0010704</p> <p>Fig. 39: Potential equalization and cathodic protection</p> <p>1 Power supply isolation transformer 2 Electrically isolated</p>

**4.3.5 Exampels for potential equalization connections for Promag E/L/P/W**

**Standard case**

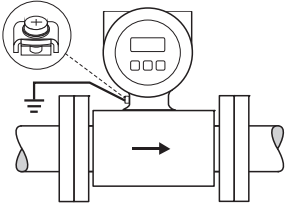
Operating conditions	Potential equalization
<p>When using the measuring device in a:</p> <ul style="list-style-type: none"> <li>▪ Metal, grounded pipe</li> </ul> <p>Potential equalization takes place via the ground terminal of the transmitter (standard situation).</p> <p> <b>Note!</b> When installing in metal pipes, we recommend you connect the ground terminal of the transmitter housing with the piping.</p>	 <p style="text-align: right;">a0010702</p> <p>Fig. 40: Via the ground terminal of the transmitter</p>

Special cases

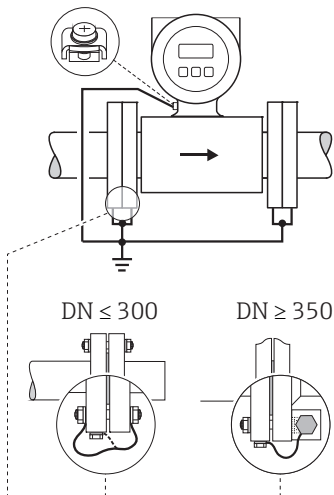
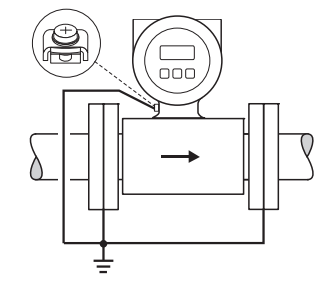
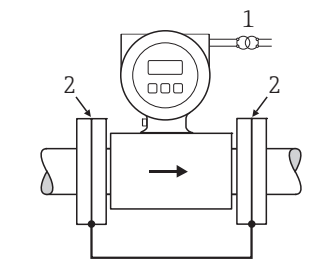
Operating conditions	Potential equalization
<p>When using the measuring device in a:</p> <ul style="list-style-type: none"> <li>▪ Metal pipe that is not grounded</li> </ul> <p>This connection method also applies in situations where:</p> <ul style="list-style-type: none"> <li>▪ Customary potential equalization cannot be ensured</li> <li>▪ Excessively high equalizing currents can be expected</li> </ul> <p>Both sensor flanges are connected to the pipe flange by means of a ground cable (copper wire, 6 mm<sup>2</sup> / 0.0093 in<sup>2</sup>) and grounded. Connect the transmitter or sensor connection housing, as applicable, to ground potential by means of the ground terminal provided for the purpose.</p> <p>Ground cable installation depends on the nominal diameter:</p> <ul style="list-style-type: none"> <li>▪ DN ≤ 300: The ground cable is mounted directly on the conductive flange coating with the flange screws.</li> <li>▪ DN ≥ 350: The ground cable is mounted directly on the metal transport bracket.</li> </ul> <p> <b>Note!</b> The ground cable for flange-to-flange connections can be ordered separately as an accessory from Endress+Hauser.</p>	 <p style="text-align: right;">a0010703</p> <p><i>Fig. 41: Via the ground terminal of the transmitter and the flanges of the pipe</i></p>
<p>When using the measuring device in a:</p> <ul style="list-style-type: none"> <li>▪ Plastic pipe</li> <li>▪ Pipe with insulating lining</li> </ul> <p>This connection method also applies in situations where:</p> <ul style="list-style-type: none"> <li>▪ Customary potential equalization cannot be ensured</li> <li>▪ Excessively high equalizing currents can be expected</li> </ul> <p>Potential equalization takes place using additional ground disks, which are connected to the ground terminal via a ground cable (copper wire, min. 6 mm<sup>2</sup> / 0.0093 in<sup>2</sup>). When installing the ground disks, please comply with the enclosed Installation Instructions.</p>	 <p style="text-align: right;">a0010702</p> <p><i>Fig. 42: Via the ground terminal of the transmitter</i></p>
<p>When using the measuring device in a:</p> <ul style="list-style-type: none"> <li>▪ Pipe with a cathodic protection unit</li> </ul> <p>The device is installed potential-free in the pipe. Only the two flanges of the pipe are connected with a ground cable (copper wire, 6 mm<sup>2</sup> / 0.0093 in<sup>2</sup>). Here, the ground cable is mounted directly on the conductive flange coating with flange screws.</p> <p>Note the following when installing:</p> <ul style="list-style-type: none"> <li>▪ The applicable regulations regarding potential-free installation must be observed.</li> <li>▪ There should be <b>no</b> electrically conductive connection between the pipe and the device.</li> <li>▪ The mounting material must withstand the applicable torques.</li> </ul>	 <p style="text-align: right;">a0010704</p> <p><i>Fig. 43: Potential equalization and cathodic protection</i></p> <p>1 Power supply isolation transformer 2 Electrically isolated</p>

## 4.4 Degree of protection

The devices meet all the requirements of IP 67 degree of protection.

Compliance with the following points is mandatory following installation in the field or servicing in order to ensure that IP 67 protection is maintained:

- The housing seals must be clean and undamaged when inserted into their grooves. The seals must be dried, cleaned or replaced if necessary.
- All threaded fasteners and screw covers must be firmly tightened.
- The cables used for connection must be of the specified outside diameter → 47.
- Firmly tighten the cable entries.
- The cables must loop down before they enter the cable entries ("water trap"). This arrangement prevents moisture penetrating the entry. Always install the measuring device in such a way that the cable entries do not point up.
- Remove all unused cable entries and insert plugs instead.
- Do not remove the grommet from the cable entry.

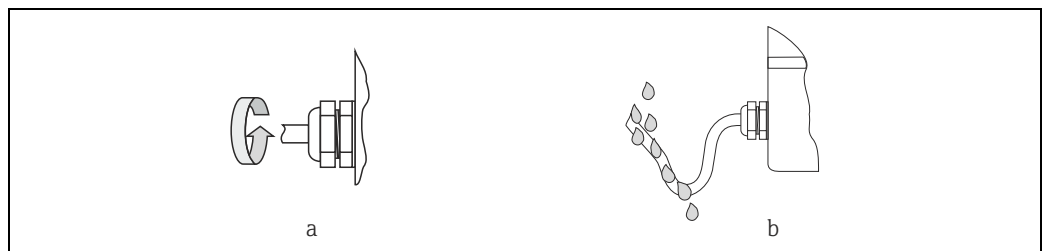

Fig. 44: Installation instructions, cable entries



### Caution!

Do not loosen the threaded fasteners of the sensor housing, as otherwise the degree of protection guaranteed by Endress+Hauser no longer applies.







### Note!

- The Promag E/L/P/W sensors can be supplied with IP 68 rating (permanent immersion in water to a depth of 3 meters (10 ft)). In this case the transmitter must be installed remote from the sensor.
- The Promag L sensors with IP 68 rating are only available with stainless steel flanges.
- The remote version in IP67, type 6 of Promag L sensors is available for temporary use in water.

## 4.5 Post-connection check

Perform the following checks after completing electrical installation of the measuring device:

Device condition and specifications	Notes
Are cables or the device damaged (visual inspection)?	–
Electrical connection	Notes
Does the supply voltage match the specifications on the nameplate?	<ul style="list-style-type: none"> <li>■ 85 to 250 V AC (50 to 60 Hz)</li> <li>■ 20 to 28 V AC (50 to 60 Hz), 11 to 40 V DC</li> </ul>
Do the cables used comply with the necessary specifications?	→  47
Do the cables have adequate strain relief?	–
Is the cable type route completely isolated? Without loops and crossovers?	–
Are the power-supply and signal cables correctly connected?	See the wiring diagram inside the cover of the terminal compartment
Only remote version: Is the flow sensor connected to the matching transmitter electronics?	Check serial number on nameplates of sensor and connected transmitter.
Only remote version: Is the connecting cable between sensor and transmitter connected correctly?	→  42
Are all screw terminals firmly tightened?	–
Have the measures for grounding/potential equalization been correctly implemented?	→  50
Are all cable entries installed, firmly tightened and correctly sealed? Cables looped as "water traps"?	→  53
Are all housing covers installed and firmly tightened?	–

## 5 Operation

### 5.1 Display and operating elements

The local display enables you to read all important parameters directly at the measuring point and configure the device.

The display area consists of two lines; this is where measured values are displayed, and/or status variables (partially filled pipe, etc.). The assignment of the display lines in operating mode is specified. The top line displays the volume flow and the bottom line displays the totalizer status.

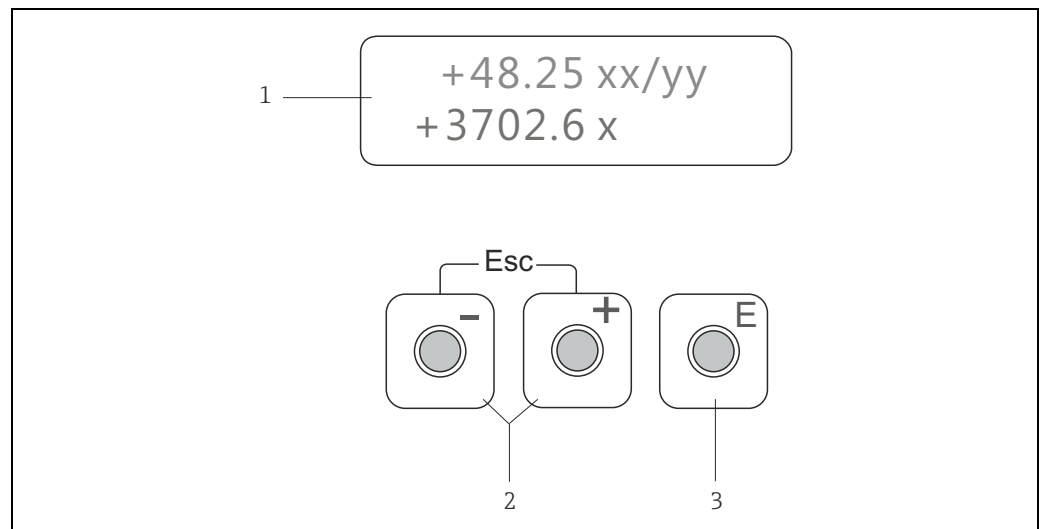

Fig. 45: Display and operating elements

- 1 **Liquid crystal display**  
The two-line liquid-crystal display shows measured values, dialog texts, error messages and information messages. The display as it appears when normal measuring is in progress is known as the HOME position (operating mode).
  - Upper display line: Shows primary measured values, e.g. volume flow [e.g. in ml/min]
  - Lower display line: Shows the totalizer status, [e.g. in m<sup>3</sup>]
- 2 **Plus/minus keys**
  - Enter numerical values, select parameters
  - Select different function groups within the function matrix
 Press the +/- keys simultaneously to trigger the following functions:
  - Exit the function matrix step by step → HOME position
  - Press and hold down +/- keys for longer than 3 seconds → Return directly to HOME position
  - Cancel data entry
- 3 **Enter key**
  - HOME position → Entry into the function matrix
  - Save the numerical values you input or settings you change

## 5.2 Brief operating instructions on the function matrix



Note!

- See the general notes on → 57.
- Function matrix overview → 113
- Detailed description of all functions → 114 ff.

The function matrix comprises two levels, namely the function groups and the functions of the function groups.

The groups are the highest-level grouping of the control options for the device. A number of functions is assigned to each group. You select a group in order to access the individual functions for operating and configuring the device.

1. HOME position → → Enter the function matrix
2. Select a function group (e.g. OPERATION)
3. Select a function (e.g. LANGUAGE)  
Change parameter/enter numerical values:  
 → select or enter enable code, parameters, numerical values  
 → save your entries
4. Exit the function matrix:  
 - Press and hold down Esc key ( → for longer than 3 seconds → HOME position  
 - Repeatedly press Esc key ( → return step by step to HOME position

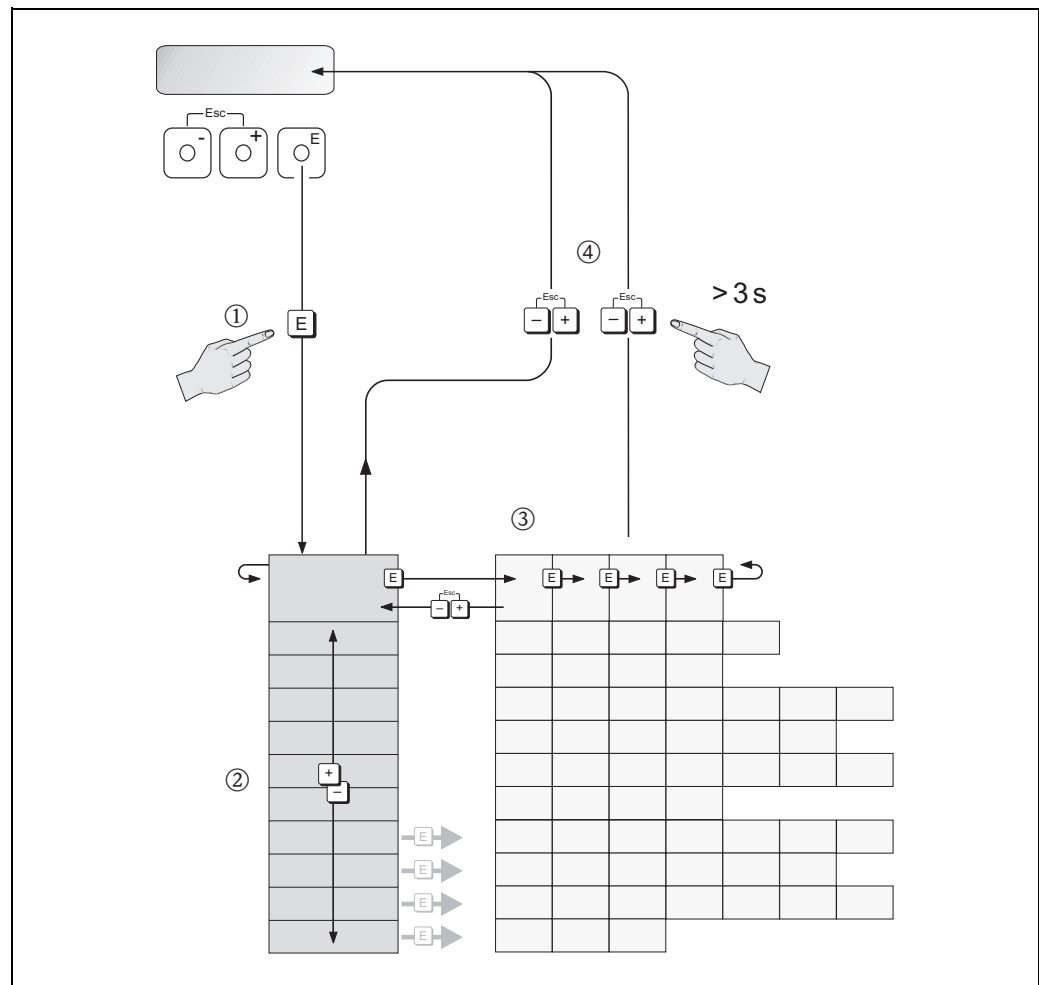



Fig. 46: Selecting functions and configuring parameters (function matrix)



A0001142



### 5.2.1 General notes

The brief commissioning guide (→  66) is adequate for commissioning in most instances. Complex measuring operations on the other hand necessitate additional functions that you can configure as necessary and customize to suit your process parameters. The function matrix, therefore, comprises a multiplicity of additional functions which, for the sake of clarity, are arranged in a number of function groups.

Comply with the following instructions when configuring functions:

- You select functions as described on →  56.
- You can switch off certain functions (OFF). If you do so, related functions in other function groups will no longer be displayed.
- Certain functions prompt you to confirm your data entries.  
Press P to select "SURE | YES |" and press  again to confirm. This saves your setting or starts a function, as applicable.
- Return to the HOME position is automatic if no key is pressed for 5 minutes.



Note!

- The transmitter continues to measure while data entry is in progress, i.e. the current measured values are output via the signal outputs in the normal way.
- If the power supply fails, all preset and configured values remain safely stored in the EEPROM.

### 5.2.2 Enabling the programming mode

The function matrix can be disabled. Disabling the function matrix rules out the possibility of inadvertent changes to device functions, numerical values or factory settings. A numerical code (factory setting = 10) has to be entered before settings can be changed.

If you use a code of your choice, you exclude the possibility of unauthorized persons accessing data, see ACCESS CODE function →  116.

Comply with the following instructions when entering codes:

- If programming is disabled and the  operating elements are pressed in any function, a prompt for the code automatically appears on the display.
- If "0" is specified as the customer's code, programming is always enabled.
- The Endress+Hauser service organization can be of assistance if you mislay your personal code.



Caution!

Changing certain parameters such as all sensor characteristics, for example, influences numerous functions of the entire measuring system, particularly measuring accuracy. Normally, such parameters may not be changed! Please contact Endress+Hauser if you have any questions.

### 5.2.3 Disabling the programming mode

Programming is disabled if you do not press the operating elements within 60 seconds following automatic return to the HOME position.

You can also disable programming in the "ACCESS CODE" function by entering any number (other than the customer's code).

## 5.3 Displaying error messages

### 5.3.1 Type of error

Errors which occur during commissioning or measuring operation are displayed immediately. If two or more system or process errors occur, the error with the highest priority is the one shown on the display.

The measuring system distinguishes between two types of error:

- **System errors** → ☰ 74:  
This group comprises all device errors, e.g. communication errors, hardware faults, etc.
- **Process errors** → ☰ 75:  
This group comprises all application errors, e.g. empty pipe, etc.

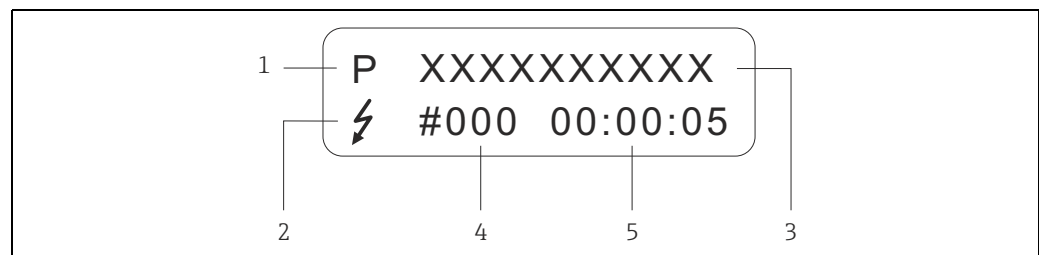

A0000991

Fig. 47: Error messages on the display (example)

- 1 Error type:  
– P = process error  
– S = system error
- 2 Error message type:  
– ⚡ = fault message  
– ! = notice message
- 3 Error designation: e.g. EMPTY PIPE = measuring tube is only partly filled or completely empty
- 4 Error number: e.g. #401
- 5 Duration of most recent error occurrence (in hours, minutes and seconds)

### 5.3.2 Error message types

#### Notice message (!)

- Displayed as → Exclamation mark (!), error type (S: system error, P: process error)
- The error in question has no effect on the outputs of the measuring device.

#### Fault message (⚡)

- Displayed as → Lightning flash (⚡), error type (S: system error, P: process error).
- The error in question has a direct effect on the outputs.  
The response of the individual outputs (failsafe mode) can be defined in the function matrix using the "FAILSAFE MODE" function → ☰ 134.



Note!

For security reasons, error messages should be output via the status output.

## 5.4 Communication

In addition to local operation, the measuring device can be configured and measured values can be obtained by means of the HART protocol. Digital communication takes place using the 4–20 mA current output HART →  49.

The HART protocol allows the transfer of measuring and device data between the HART master and the field devices for configuration and diagnostics purposes.

The HART master, e.g. a handheld terminal or PC-based operating programs (such as FieldCare), require device description (DD) files which are used to access all the information in a HART device. Information is exclusively transferred using so-called "commands". There are three different command classes:

- **Universal commands:**

All HART device support and use universal commands.

The following functionalities are linked to them:

- Identify HART devices
- Reading digital measured values (volume flow, totalizer, etc.)

- **Common practice commands:**

Common practice commands offer functions which are supported and can be executed by most but not all field devices.

- **Device-specific commands:**

These commands allow access to device-specific functions which are not HART standard. Such commands access individual field device information, amongst other things, such as empty/full pipe calibration values, low flow cutoff settings, etc.



Note!

The device has access to all three command classes. A list of all the "Universal commands" and "Common practice commands" is provided on →  61.

### 5.4.1 Operating options

For the complete operation of the measuring device, including device-specific commands, there are DD files available to the user to provide the following operating aids and programs:

#### Field Xpert HART Communicator

Selecting device functions with a HART Communicator is a process involving a number of menu levels and a special HART function matrix.

The HART manual in the carrying case of the HART Communicator contains more detailed information on the device.

#### Operating program "FieldCare"

FieldCare is Endress+Hauser's FDT-based plant Asset Management Tool and allows the configuration and diagnosis of intelligent field devices. By using status information, you also have a simple but effective tool for monitoring devices. The Proline flow measuring devices are accessed via a service interface or via the service interface FXA193.

#### Operating program "AMS" (Emerson Process Management)

AMS (Asset Management Solutions): program for operating and configuring devices.

### 5.4.2 Current device description files

The following table illustrates the suitable device description file for the operating tool in question and then indicates where these can be obtained.

HART protocol:

<b>Valid for device software:</b>	1.04.XX	→ Function DEVICE SOFTWARE
-----------------------------------	---------	----------------------------

<b>Device data HART</b>		
Manufacturer ID:	11 <sub>hex</sub> (ENDRESS+HAUSER)	→ Function MANUFACTURER ID
Device ID:	56 <sub>hex</sub>	→ Function DEVICE ID
<b>HART version data:</b>	Device Revision 5/ DD Revision 1	
<b>Software release:</b>	01.2012	
<b>Operating program:</b>	<b>Sources for obtaining device descriptions:</b>	
Handheld Field Xpert SFX100	Use update function of handheld terminal	
FieldCare / DTM	<ul style="list-style-type: none"> <li>▪ www.endress.com → Download</li> <li>▪ CD-ROM (Endress+Hauser order number 56004088)</li> <li>▪ DVD (Endress+Hauser order number 70100690)</li> </ul>	
AMS	www.endress.com → Download	
SIMATIC PDM	www.endress.com → Download	

<b>Tester/simulator:</b>	<b>Sources for obtaining device descriptions:</b>
Fieldcheck	Update by means of FieldCare with the flow device FXA193/291 DTM in the Fieldflash module



Note!

The "Fieldcheck" tester/simulator is used for testing flowmeters in the field. When used in conjunction with the "FieldCare" software package, test results can be imported into a database, printed out and used for official certification. Contact your Endress+Hauser representative for more information.

### 5.4.3 Device variables

The following device variables are available using the HART protocol:

Code (decimal)	Device variable
0	OFF (not assigned)
1	Volume flow
250	Totalizer

At the factory, the process variables are assigned to the following device variables:

- Primary process variable (PV) → Volume flow
- Second process variable (SV) → Totalizer
- Third process variable (TV) → not assigned
- Fourth process variable (FV) → not assigned



### 5.4.4 Switching HART write protection on/off

The HART write protection can be switched on and off using the HART WRITE PROTECT device function → 126.

### 5.4.5 Universal and common practice HART commands



The following table contains all the universal commands supported by the device.

Command No. HART command / Access type		Command data (numeric data in decimal form)	Response data (numeric data in decimal form)
<b>Universal commands</b>			
0	Read unique device identifier Access type = read	none	<p>Device identification delivers information on the device and the manufacturer. It cannot be changed.</p> <p>The response consists of a 12 byte device ID:</p> <ul style="list-style-type: none"> <li>- Byte 0: fixed value 254</li> <li>- Byte 1: Manufacturer ID, 17 = E+H</li> <li>- Byte 2: Device type ID, 69 = Promag 10</li> <li>- Byte 3: Number of preambles</li> <li>- Byte 4: Universal commands rev. no.</li> <li>- Byte 5: Device-specific commands rev. no.</li> <li>- Byte 6: Software revision</li> <li>- Byte 7: Hardware revision</li> <li>- Byte 8: Additional device information</li> <li>- Bytes 9-11: Device identification</li> </ul>
1	Read primary process variable Access type = read	none	<ul style="list-style-type: none"> <li>- Byte 0: HART unit code of the primary process variable</li> <li>- Bytes 1-4: Primary process variable</li> </ul> <p>Factory setting: Primary process variable = Volume flow</p> <p> Note! Manufacturer-specific units are represented using the HART unit code "240".</p>
2	Read the primary process variable as current in mA and percentage of the set measuring range Access type = read	none	<ul style="list-style-type: none"> <li>- Bytes 0-3: actual current of the primary process variable in mA</li> <li>- Bytes 4-7: % value of the set measuring range</li> </ul> <p>Factory setting: Primary process variable = Volume flow</p>
3	Read the primary process variable as current in mA and four dynamic process variables Access type = read	none	<p>24 bytes are sent as a response:</p> <ul style="list-style-type: none"> <li>- Bytes 0-3: primary process variable current in mA</li> <li>- Byte 4: HART unit code of the primary process variable</li> <li>- Bytes 5-8: Primary process variable</li> <li>- Byte 9: HART unit code of the second process variable</li> <li>- Bytes 10-13: Second process variable</li> <li>- Byte 14: HART unit code of the third process variable</li> <li>- Bytes 15-18: Third process variable</li> <li>- Byte 19: HART unit code of the fourth process variable</li> <li>- Bytes 20-23: Fourth process variable</li> </ul> <p><i>Factory setting:</i></p> <ul style="list-style-type: none"> <li>■ Primary process variable = Volume flow</li> <li>■ Second process variable = Totalizer</li> <li>■ Third process variable = OFF (not assigned)</li> <li>■ Fourth process variable = OFF (not assigned)</li> </ul> <p>The assignment of the process variables is fixed and cannot be changed.</p> <p> Note! Manufacturer-specific units are represented using the HART unit code "240".</p>
6	Set HART shortform address Access type = write	<p>Byte 0: desired address (0 to 15) Factory setting: 0</p> <p> Note! With an address &gt;0 (multidrop mode), the current output of the primary process variable is set to 4 mA.</p>	Byte 0: active address

Command No. HART command / Access type		Command data (numeric data in decimal form)	Response data (numeric data in decimal form)
11	Read unique device identification using the TAG (measuring point designation) Access type = read	Bytes 0-5: TAG	Device identification delivers information on the device and the manufacturer. It cannot be changed.  The response consists of a 12 byte device ID if the given TAG agrees with the one saved in the device: <ul style="list-style-type: none"> <li>- Byte 0: fixed value 254</li> <li>- Byte 1: Manufacturer ID, 17 = E+H</li> <li>- Byte 2: Device type ID, 69 = Promag 10</li> <li>- Byte 3: Number of preambles</li> <li>- Byte 4: Universal commands rev. no.</li> <li>- Byte 5: Device-specific commands rev. no.</li> <li>- Byte 6: Software revision</li> <li>- Byte 7: Hardware revision</li> <li>- Byte 8: Additional device information</li> <li>- Bytes 9-11: Device identification</li> </ul>
12	Read user message Access type = read	none	Bytes 0-24: User message  Note! You can write the user message using Command 17.
13	Read TAG, descriptor and date Access type = read	none	<ul style="list-style-type: none"> <li>- Bytes 0-5: TAG</li> <li>- Bytes 6-17: descriptor</li> <li>- Bytes 18-20: Date</li> </ul>  Note! You can write the TAG, descriptor and date using Command 18.
14	Read sensor information on primary process variable	none	<ul style="list-style-type: none"> <li>- Bytes 0-2: Sensor serial number</li> <li>- Byte 3: HART unit code of sensor limits and measuring range of the primary process variable</li> <li>- Bytes 4-7: Upper sensor limit</li> <li>- Bytes 8-11: Lower sensor limit</li> <li>- Bytes 12-15: Minimum span</li> </ul>  Note! <ul style="list-style-type: none"> <li>■ The data relate to the primary process variable (= volume flow).</li> <li>■ Manufacturer-specific units are represented using the HART unit code "240".</li> </ul>
15	Read output information of primary process variable Access type = read	none	<ul style="list-style-type: none"> <li>- Byte 0: Alarm selection ID</li> <li>- Byte 1: Transfer function ID</li> <li>- Byte 2: HART unit code for the set measuring range of the primary process variable</li> <li>- Bytes 3-6: upper range, value for 20 mA</li> <li>- Bytes 7-10: lower range, value for 4 mA</li> <li>- Bytes 11-14: Damping constant in [s]</li> <li>- Byte 15: Write protection ID</li> <li>- Byte 16: OEM dealer ID, 17 = E+H</li> </ul> Factory setting: Primary process variable = Volume flow  Note! Manufacturer-specific units are represented using the HART unit code "240".
16	Read the device production number Access type = read	none	Bytes 0-2: Production number
17	Write user message Access = write	Save any 32-character text in the device. Bytes 0-23: Desired user message	Displays the current user message in the device: Bytes 0-23: Current user message in the device
18	Write TAG, descriptor and date Access = write	With this parameter, you can store an 8 character TAG, a 16 character descriptor and a date: <ul style="list-style-type: none"> <li>- Bytes 0-5: TAG</li> <li>- Bytes 6-17: descriptor</li> <li>- Bytes 18-20: Date</li> </ul>	Displays the current information in the device: <ul style="list-style-type: none"> <li>- Bytes 0-5: TAG</li> <li>- Bytes 6-17: descriptor</li> <li>- Bytes 18-20: Date</li> </ul>
19	Write the device production number Access = write	Bytes 0-2: Production number	Bytes 0-2: Production number

The following table contains all the common practice commands supported by the device:

Command No. HART command / Access type	Command data (numeric data in decimal form)	Response data (numeric data in decimal form)
<b>Common practice commands</b>		
34	Write damping value for primary process variable Access = write  <i>Factory setting:</i> Primary process variable = Current output damping	Bytes 0-3: Damping value of the primary process variable "volume flow" in seconds  <i>Factory setting:</i> Primary process variable = Current output damping
35	Write measuring range of primary process variable Access = write  <i>Factory setting:</i> Primary process variable = Volume flow  Note! <ul style="list-style-type: none"> <li>▪ The start of the measuring range (4 mA) must correspond to the zero flow.</li> <li>▪ If the HART unit code is not the correct one for the process variable, the device will continue with the last valid unit.</li> </ul>	Displays the current damping value in the device: Bytes 0-3: Damping value in seconds  The currently set measuring range is displayed as a response: <ul style="list-style-type: none"> <li>- Byte 0: HART unit code of the primary process variable</li> <li>- Bytes 1-4: upper range, value for 20 mA</li> <li>- Bytes 5-8: lower range, value for 4 mA</li> </ul>  Note! Manufacturer-specific units are represented using the HART unit code "240".
38	Device status reset (configuration changed) Access = write	none   Note! It is also possible to execute this HART command when write protection is activated (= ON)!
40	Simulate input current of primary process variable Access = write	Simulation of the desired output current of the primary process variable. An entry value of 0 exits the simulation mode: Bytes 0-3: Output current in mA  <i>Factory setting:</i> Primary process variable = Volume flow   Note! You can set the assignment of device variables to process variables using Command 51.
42	Perform master reset Access = write	none
44	Write unit of primary process variable Access = write	Set unit of primary process variable. Only units which are suitable for the process variable are transferred to the device: Byte 0: HART unit code  <i>Factory setting:</i> Primary process variable = Volume flow   Note! <ul style="list-style-type: none"> <li>▪ If the written HART unit code is not the correct one for the process variable, the device will continue with the last valid unit.</li> <li>▪ If you change the unit of the primary process variable, this has a direct impact on the system units.</li> </ul>
48	Read additional device status Access = read	none
		The device status is displayed in extended form as the response: Coding: see table →  65.

Command No. HART command / Access type		Command data (numeric data in decimal form)	Response data (numeric data in decimal form)
50	Read assignment of the device variables to the four process variables Access = read	none	<p>Display of the current variable assignment of the process variables:</p> <ul style="list-style-type: none"> <li>- Byte 0: Device variable code to the primary process variable</li> <li>- Byte 1: Device variable code to the second process variable</li> <li>- Byte 2: Device variable code to the third process variable</li> <li>- Byte 3: Device variable code to the fourth process variable</li> </ul> <p><i>Factory setting:</i></p> <ul style="list-style-type: none"> <li>■ Primary process variable: Code 1 for volume flow</li> <li>■ Second process variable: Code 250 for totalizer</li> <li>■ Third process variable: Code 0 for OFF (not assigned)</li> <li>■ Fourth process variable: Code 0 for OFF (not assigned)</li> </ul>
53	Write device variable unit Access = write	<p>This command sets the unit of the given device variables. Only those units which suit the device variable are transferred:</p> <ul style="list-style-type: none"> <li>- Byte 0: Device variable code</li> <li>- Byte 1: HART unit code</li> </ul> <p><i>Code of the supported device variables:</i> See information → 60</p> <p> Note!</p> <ul style="list-style-type: none"> <li>■ If the written unit is not the correct one for the device variable, the device will continue with the last valid unit.</li> <li>■ If you change the unit of the device variable, this has a direct impact on the system units.</li> </ul>	<p>The current unit of the device variables is displayed in the device as a response:</p> <ul style="list-style-type: none"> <li>- Byte 0: Device variable code</li> <li>- Byte 1: HART unit code</li> </ul> <p> Note! Manufacturer-specific units are represented using the HART unit code "240".</p>
59	Write number of preambles in response message Access = write	<p>This parameter sets the number of preambles which are inserted in the response messages:</p> <p>Byte 0: Number of preambles (4 to 20)</p>	<p>As a response, the current number of the preambles is displayed in the response message:</p> <p>Byte 0: Number of preambles</p>



### 5.4.6 Device status and error messages

You can read the extended device status, in this case, current error messages, via Command "48". The command delivers information which is partly coded in bits (see table below).



Note!

- You can find a detailed explanation of the device status and error messages and their elimination on → 65
- Bits and bytes not listed are not assigned.

Byte	Bit	Error No.	Short error description
0	0	001	Serious device error
	1	011	Measuring amplifier has faulty EEPROM
	2	012	Error when accessing data of the measuring amplifier EEPROM
3	3	111	Totalizer checksum error
5	0	321	Coil current of the sensor is outside the tolerance.
7	3	351	Current output: Flow is out of range
8	3	359	Pulse output: The pulse output frequency is out of range
10	7	401	Measuring tube partially filled or empty
11	2	461	EPD calibration not possible because the fluid's conductivity is either too low or too high
	4	463	The EPD calibration values for empty pipe and full pipe are identical, and therefore incorrect.
12	7	501	Amplifier software version is loaded. Currently no other commands are possible.
14	3	601	Positive zero return active
18	3	691	Simulation of response to error (outputs) active
	4	692	Simulation of volume flow active

## 6 Commissioning

### 6.1 Function check

Make sure that all final checks have been completed before you start up your measuring point:

- Checklist for "Post-installation check" →  41
- Checklist for "Post-connection check" →  54

### 6.2 Switching on the measuring device

Once the connection checks have been successfully completed, it is time to switch on the power supply. The device is now operational. The measuring device performs a number of post switch-on self-tests. As this procedure progresses the following sequence of messages appears on the local display:

<b>PROMAG 10</b> <b>V 1.XX.XX</b>	Start-up message
--------------------------------------	------------------

















Normal measuring mode commences as soon as start-up completes. Various measured-value and/or status variables (HOME position) appear on the display.



Note!

If start-up fails, an error message indicating the cause is displayed.

### 6.3 Brief commissioning guide

HOME position →  → 	
<b>Configure display</b>	
UI language	→  116
Display contrast	→  117
Number of decimal places	→  117
<b>Select engineering units</b>	
Volume flow	→  114
Totalizer	→  118
<b>Configure outputs</b>	
<i>Current output</i>	<i>Pulse/status output</i>
Current range	Operating mode →  121
Full scale value	Pulse value →  121
	Pulse width →  121
	or
	Assign status output →  122
	Switch-on point →  122
<b>Complex applications</b>	
The quickest way to find information on configuring additional functions is via the following pages:	
Operating matrix	→  113
Index	→  141
<b>For optimum measurement results</b>	
Low flow cut off	→  127
Empty pipe detection	→  127

## 6.4 Commissioning after installing a new electronics board

After startup, the device checks whether a serial number is available. If this is not the case, the following setup is started. Installing a new electronics board → 79.

### 6.4.1 "Commissioning" setup



Note!

- The setup can no longer be called up once a serial number has been entered and stored. If a parameter is entered incorrectly during the setup, this must be corrected in the relevant function via the function matrix.
- The appropriate information is documented on the nameplate of the sensor and on the inside of the housing cover, → 2 → 7.

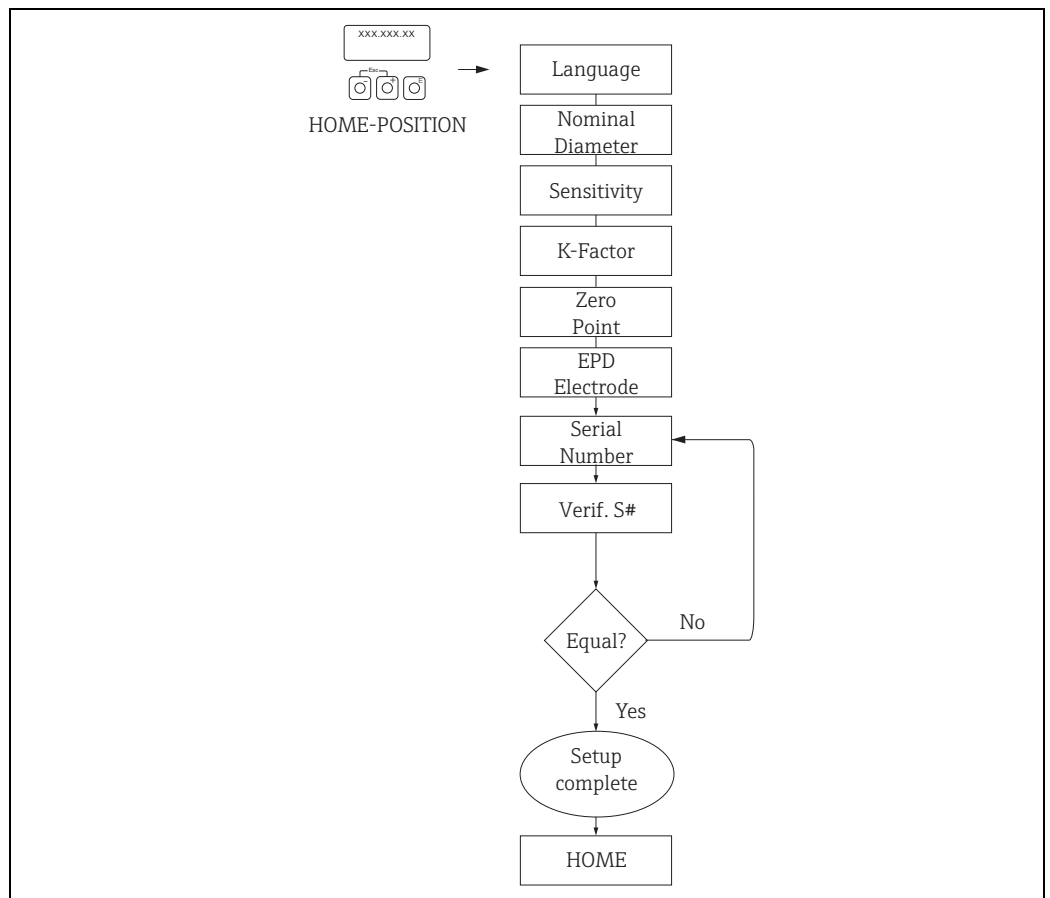

Fig. 48: The "Commissioning" setup starts after installation of a new electronics board if no serial number is present.

## 6.5 Empty-pipe/full-pipe adjustment

Flow cannot be measured correctly unless the measuring tube is completely full. This status can be permanently monitored using the Empty Pipe Detection: EPD = Empty Pipe Detection (with the help of an EPD electrode)



Caution!

More detailed information on empty-pipe and full-pipe adjustment can be found in the description of the functions:

- EPD ADJUSTMENT (carrying out the adjustment) → 128.
- EPD (switching empty pipe detection on and off) → 127



Note!

- The EPD function is not available unless the sensor is fitted with an EPD electrode.
- The devices are already calibrated at the factory with water (approx. 500  $\mu\text{S}/\text{cm}$ ). If the fluid conductivity differs from this reference, empty-pipe/full-pipe adjustment has to be performed again on site.
- The default setting for EPD when the devices are delivered is OFF; the function has to be activated if required.
- The EPD process error can be output by means of the configurable status output.

### 6.5.1 Performing empty-pipe and full-pipe adjustment (EPD)

1. Select the appropriate function in the function matrix:  
HOME → → → PROCESS PARAMETER → → → EPD ADJUSTMENT
2. Empty the piping. The wall of the measuring tube should still be wet with fluid during EPD empty pipe adjustment
3. Start empty-pipe adjustment: Select "EMPTY PIPE ADJUST" and press to confirm.
4. After empty-pipe adjustment, fill the piping with fluid.
5. Start full-pipe adjustment: Select "FULL PIPE ADJUST" and press to confirm.
6. Having completed the adjustment, select the setting "OFF" and exit the function by pressing .
7. Now switch on empty pipe detection in the EPD function by selecting the option "ON".



Caution!

The adjustment coefficients must be valid before you can activate the EPD function. If adjustment is incorrect the following messages might appear on the display:

– FULL = EMPTY

The adjustment values for empty pipe and full pipe are identical. In cases of this nature you must repeat empty-pipe or full-pipe adjustment!

– ADJUSTMENT NOT OK

Adjustment is not possible because the fluid's conductivity is out of range.

## 7 Maintenance

No special maintenance work is required.

### 7.1 Exterior cleaning

When cleaning the exterior of measuring devices, always use cleaning agents that do not attack the surface of the housing and the seals.

### 7.2 Seals

The seals of the Promag H sensor must be replaced periodically, particularly in the case of gasket seals (aseptic version).

The period between changes depends on the frequency of cleaning cycles, the cleaning temperature and the fluid temperature.

Replacement seals (accessories) →  70.

## 8 Accessories

Various accessories, which can be ordered separately from Endress+Hauser, are available for the transmitter and the sensor. Your Endress+Hauser service organization can provide detailed information on the specific order codes on request.

### 8.1 Device-specific accessories

#### 8.1.1 For the transmitter

Accessory	Description
Proline Promag 10 transmitter	Transmitter for replacement or storage. Use the order code to define the following specifications: <ul style="list-style-type: none"> <li>▪ Approvals</li> <li>▪ Degree of protection/version</li> <li>▪ Cable for remote version</li> <li>▪ Cable entry</li> <li>▪ Display/power supply/operation</li> <li>▪ Software</li> <li>▪ Outputs/inputs</li> </ul>
Mounting set for Promag 10 transmitter	Mounting set for aluminum field housing (remote version). Suitable for Pipe mounting
Cable for remote version	Coil and signal cables, various lengths.
Process display RIA45	Multifunctional 1-channel display unit: <ul style="list-style-type: none"> <li>▪ Universal input</li> <li>▪ Transmitter power supply</li> <li>▪ Limit relay</li> <li>▪ Analog output</li> </ul>
Process display RIA251	Digital display device for looping into the 4 to 20 mA current loop.
Field display unit RIA16	Digital field display device for looping into the 4 to 20 mA current loop.
Application Manager RMM621	Electronic recording, display, balancing, control, saving and event and alarm monitoring of analog and digital input signals. Values and conditions determined are output by means of analog and digital output signals. Remote transmission of alarms, input values and calculated values using a PSTN or GSM modem.

#### 8.1.2 For the sensor

Accessory	Description
Wall-mounting kit for Promag H	Wall-mounting kit for the Promag H sensor.
Mounting kit for Promag D as wafer version	<ul style="list-style-type: none"> <li>▪ Mounting bolts</li> <li>▪ Nuts incl. washers</li> <li>▪ Flange seals</li> <li>▪ Centering sleeves (if required for the flange)</li> </ul>
Set of seals for Promag D as wafer version	Set of seals consisting of two flange seals.
Mounting kit for Promag H	<ul style="list-style-type: none"> <li>▪ 2 process connections</li> <li>▪ Threaded fasteners</li> <li>▪ Seals</li> </ul>
Set of seals for Promag H	For regular replacement of the seals of the Promag H sensor.
Welding jig for Promag H	Weld nipple as process connection: welding jig for installation in pipe.
Adapter connection for Promag A/H	Adapter connections for installing a Promag H instead of a Promag 30/33A or Promag 30/33H DN 25.

Accessory	Description
Ground cable for Promag E/L/P/W	Ground cable for potential equalization.
Ground disk for Promag E/L/P/W	Ground disk for potential equalization.

## 8.2 Communication-specific accessories

Accessory	Description
HART Communicator Field Xpert SFX 100	Handheld terminal for remote configuration and for obtaining measured values via the HART current output (4 to 20 mA). Contact your Endress+Hauser representative for more information.
Fieldgate FXA320	Gateway for remote interrogation of HART sensors and actuators via Web browser: <ul style="list-style-type: none"> <li>▪ 2-channel analog input (4 to 20 mA)</li> <li>▪ 4 binary inputs with event counter function and frequency measurement</li> <li>▪ Communication via modem, Ethernet or GSM</li> <li>▪ Visualization via Internet/Intranet in Web browser and/or WAP cellular phone</li> <li>▪ Limit value monitoring with alarm by e-mail or SMS</li> <li>▪ Synchronized time stamping of all measured values.</li> </ul>
Fieldgate FXA520	Gateway for remote interrogation of HART sensors and actuators via Web browser: <ul style="list-style-type: none"> <li>▪ Web server for remote monitoring of up to 30 measuring points</li> <li>▪ Intrinsically safe version [EEx ia]IIC for applications in hazardous areas</li> <li>▪ Communication via modem, Ethernet or GSM</li> <li>▪ Visualization via Internet/Intranet in Web browser and/or WAP cellular phone</li> <li>▪ Limit value monitoring with alarm by e-mail or SMS</li> <li>▪ Synchronized time stamping of all measured values</li> <li>▪ Remote diagnosis and remote configuration of connected HART devices</li> </ul>
FXA195	The Commubox FXA195 connects intrinsically safe Smart transmitters with HART protocol to the USB port of a personal computer. This makes the remote operation of the transmitters possible with the aid of configuration programs (e.g. FieldCare). Power is supplied to the Commubox by means of the USB port

## 8.3 Service-specific accessories

Accessory	Description
Applicator	Software for selecting and planning flowmeters. The Applicator software can be downloaded from the Internet or ordered on CD-ROM for installation on a local PC. Contact your Endress+Hauser representative for more information.
Fieldcheck	Tester/simulator for testing flowmeters in the field. When used in conjunction with the "FieldCare" software package, test results can be imported into a database, printed out and used for official certification. Contact your Endress+Hauser representative for more information.
FieldCare	FieldCare is Endress+Hauser's FDT-based asset management tool. It can configure all intelligent field units in your system and helps you manage them. By using status information, it is also a simple but effective way of checking their status and condition.













Accessory	Description
Memograph M graphic display recorder	<p>The Memograph M graphic display recorder provides information on all the relevant process variables. Measured values are recorded correctly, limit values are monitored and measuring points analyzed. The data are stored in the 256 MB internal memory and also on a DSD card or USB stick.</p> <p>Memograph M boasts a modular design, intuitive operation and a comprehensive security concept. The ReadWin® 2000 PC software is part of the standard package and is used for configuring, visualizing and archiving the data captured.</p> <p>The mathematics channels which are optionally available enable continuous monitoring of specific power consumption, boiler efficiency and other parameters which are important for efficient energy management.</p>
FXA193	Service interface from the device to the PC for operation via FieldCare.



## 9 Troubleshooting

### 9.1 Troubleshooting instructions

Always start troubleshooting with the checklist below if faults occur after start-up or during operation. The routine takes you directly to the cause of the problem and the appropriate remedial measures.

Check the display	
No display visible and no output signals present.	<ol style="list-style-type: none"> <li>1. Check the supply voltage → terminals 1, 2</li> <li>2. Check the power line fuse →  81 85 to 250 V AC: TR5 1 A slow-blow / 250 V 11 to 40 V DC / 20 to 28 V AC: TR5 1.6A slow-blow / 250 V</li> <li>3. Measuring electronics defective → order spare parts →  78</li> </ol>
No display visible, but output signals are present.	<ol style="list-style-type: none"> <li>1. Check whether the ribbon-cable connector of the display module is correctly plugged into the amplifier board →  79</li> <li>2. Display module defective → order spare parts →  78</li> <li>3. Measuring electronics defective → order spare parts →  78</li> </ol>
Display texts are in a foreign language.	Switch off power supply. Press and hold down both the OS buttons and switch on the measuring device. The display text will appear in English (default) and is displayed at maximum contrast.
Measured value indicated, but no signal at the current or pulse output.	Electronics board defective → order spare parts →  78
↓	
Error messages on display	
<p>Errors which occur during commissioning or measuring operation are displayed immediately. Error messages consist of a variety of icons: the meanings of these icons are as follows (example):</p> <ul style="list-style-type: none"> <li>- Error type: <b>S</b> = system error, <b>P</b> = process error</li> <li>- Error message type:  = fault message, <b>!</b> = notice message</li> <li>- <b>EMPTY PIPE</b> = Type of error, e.g. measuring tube is only partly filled or completely empty</li> <li>- <b>03:00:05</b> = duration of error occurrence (in hours, minutes and seconds)</li> <li>- <b>#401</b> = error number</li> </ul> <p> <b>Caution!</b></p> <ul style="list-style-type: none"> <li>■ See the information on →  58!</li> <li>■ The measuring system interprets simulations and positive zero return as system errors, but displays them as notice message only.</li> </ul>	
Error number: No. 001 – 399 No. 501 – 699	System error (device error) has occurred →  74
Error number: No. 401 - 499	Process error (application error) has occurred →  75
↓	
Other error (without error message)	
Some other error has occurred.	Diagnosis and rectification →  76

## 9.2 System error messages

Serious system errors are **always** recognized by the device as "Fault message", and are shown as a lightning flash (⚡) on the display. Fault messages immediately affect the outputs. Simulations and positive zero return, on the other hand, are only classed and displayed as notice messages.



Caution!

In the event of a serious fault, a flowmeter might have to be returned to the manufacturer for repair. Necessary procedures must be carried out before you return the measuring device to Endress+Hauser → 5.

Always enclose a duly completed "Declaration of Contamination" form. You will find a master copy of this form at the back of this manual.



Note!

- The error types listed in the following correspond to the factory settings.
- Also observe the information on → 58

Type	Error message / No.	Cause	Remedy (Replace electronics board →  79)
S = System error ⚡ = Fault message (with an effect on the outputs) ! = Notice message (without an effect on the outputs)			
<b>No. # 0xx → Hardware error</b>			
S ⚡	CRITICAL FAIL. # 001	Serious device error	Replace electronics board.
S ⚡	AMP HW EEPROM # 011	Electronics board: Defective EEPROM	Replace electronics board.
S ⚡	AMP SW EEPROM # 012	Amplifier: Error accessing EEPROM data.	The EEPROM data blocks in which an error has occurred are displayed in the TROUBLESHOOTING function. Press Enter to acknowledge the errors in question; default values are automatically inserted instead of the errored parameter values.  Note! The measuring device has to be restarted if an error has occurred in a totalizer block (see error No. 111 / CHECKSUM TOTAL).
<b>No. # 1xx → Software error</b>			
S ⚡	GAIN ERROR AMP # 101	Impermissible gain deviation compared to reference.	Replace electronics board.
S ⚡	CHECKSUM TOTAL. # 111	Totalizer checksum error	1. Restart the measuring device 2. Replace electronics board if necessary.
<b>No. # 3xx → System limits exceeded</b>			
S ⚡	TOL. COIL CURR. # 321	Sensor: Coil current is out of tolerance.	Warning! Switch off power supply before manipulating the coil current cable, coil current cable connector or measuring electronics boards!  Remote version: 1. Check wiring of terminals 4½/2 →  42 2. Check coil current cable connector.  Compact and remote version: Replace measuring electronics boards if necessary
S !	CURRENT RANGE # 351	Current output: flow is out of range.	- Change the upper or lower limit setting, as applicable. - Increase or reduce flow, as applicable.

Type	Error message / No.	Cause	Remedy (Replace electronics board → 79)
S! S!	RANGE PULSE # 359	Pulse output: the pulse output frequency is out of range.	<ol style="list-style-type: none"> <li>Increase the setting for pulse weighting</li> <li>When selecting the pulse width, choose a value that can still be processed by a connected counter (e.g. mechanical counter, PLC etc.). <i>Determine the pulse width:</i> <ul style="list-style-type: none"> <li>Variant 1: Enter the minimum duration that a pulse must be present at the connected counter to ensure its registration.</li> <li>Variant 2: Enter the maximum (pulse) frequency as the half "reciprocal value" that a pulse must be present at the connected counter to ensure its registration.</li> </ul> </li> </ol> <p>Example: The maximum input frequency of the connected counter is 10 Hz. The pulse width to be entered is: <math>1 / (2 \cdot 10 \text{ Hz}) = 50 \text{ ms}</math></p> <ol style="list-style-type: none"> <li>Reduce flow.</li> </ol>
<b>No. # 5xx → Application error</b>			
S! S!	SW.-UPDATE ACT. # 501	Electronics board: New software version being loaded, no other commands are possible at present.	Wait until process is completed and restart device.
S! S!	UP-/DOWNL. ACT. # 502	Data are being uploaded or downloaded via FieldCare.  Note! Measuring device configuration is locked during the upload/download.	Wait until uploading/downloading process is finished.
<b>No. # 6xx → Simulation mode active</b>			
S! S!	POS. ZERO-RET. # 601	Positive zero return active	Switch off positive zero return.
S ⚡	SIM. FAILSAFE # 691	Simulation of response to error (outputs) active.	Switch off simulation.
S! S!	SIM. VOL. FLOW # 692	Simulation of volume flow active.	Switch off simulation.

### 9.3 Process error messages

Process errors are permanently defined as fault messages or notice messages.

Type	Error message / No.	Cause	Remedy / spare part
P = Process error ⚡ = Fault message (with an effect on the outputs) ! = Notice message (without an effect on the outputs)			
P! P!	EMPTY PIPE # 401	Measuring tube partially filled or empty	<ol style="list-style-type: none"> <li>Check the process conditions of the plant</li> <li>Fill the measuring tube</li> </ol>
P! P!	ADJ. NOT OK # 461	EPD calibration not possible because the fluid's conductivity is either too low or too high.	The EPD function cannot be used with fluids of this nature.
P ⚡	FULL = EMPTY # 463	The EPD calibration values for empty pipe and full pipe are identical, therefore incorrect.	Repeat calibration, making sure procedure is correct → 68.

## 9.4 Process errors without messages

Symptoms	Rectification
Remark: You may have to change or correct certain settings in functions in the function matrix in order to rectify the fault.	
Flow values are negative, even though the fluid is flowing forwards through the pipe.	<ol style="list-style-type: none"> <li>Remote version:                             <ul style="list-style-type: none"> <li>Switch off the power supply and check the wiring → 42</li> <li>If necessary, reverse the connections at terminals 41 and 42</li> </ul> </li> <li>Change the setting in the "INSTALLATION DIRECTION SENSOR" function accordingly</li> </ol>
Measured-value reading fluctuates even though flow is steady.	<ol style="list-style-type: none"> <li>Check grounding and potential equalization → 50</li> <li>Check the fluid for presence of gas bubbles.</li> <li>In the "SYSTEM DAMPING" function → increase the value</li> </ol>
Measured-value reading shown on display, even though the fluid is at a standstill and the measuring tube is full.	<ol style="list-style-type: none"> <li>Check grounding and potential equalization → 50</li> <li>Check the fluid for presence of gas bubbles.</li> <li>Activate the "LOW FLOW CUTOFF" function, i.e. enter or increase the value for the switching point.</li> </ol>
Measured-value reading on display, even though measuring tube is empty.	<ol style="list-style-type: none"> <li>Perform empty-pipe/full-pipe adjustment and then switch on Empty Pipe detection → 68</li> <li>Remote version: Check the terminals of the EPD cable → 42</li> <li>Fill the measuring tube.</li> </ol>
The current output signal is always 4 mA, irrespective of the flow signal at any given time.	<ol style="list-style-type: none"> <li>Select the "BUS ADDRESS" function and change the setting to "0".</li> <li>Value for creepage too high. Reduce the value in the "LOW FLOW CUTOFF" function.</li> </ol>
<p>The fault cannot be rectified or some other fault not described above has arisen.</p> <p>In these instances, please contact your Endress+Hauser service organization.</p>	<p>The following options are available for tackling problems of this nature:</p> <p><b>Request the services of an Endress+Hauser service technician</b>                      If you contact our service organization to have a service technician sent out, please be ready to quote the following information:</p> <ul style="list-style-type: none"> <li>Brief description of the fault</li> <li>Nameplate specifications (→ 6): order code, serial number</li> </ul> <p><b>Returning devices to Endress+Hauser</b>                      The necessary procedures on → 5 must be carried out before you return a flowmeter requiring repair or calibration to Endress+Hauser.                      Always enclose a duly completed "Declaration of Conformity" form with the flowmeter. You will find a master copy of this form at the back of this manual.</p> <p><b>Replace transmitter electronics</b>                      Components in the measuring electronics defective → order spare parts → 78</p>

## 9.5 Response of outputs to errors



Note!

The response of the totalizer, current output, pulse output and status output is defined in the FAILSAFE MODE function (→ 134).

You can use positive zero return to set the signals of the current, pulse and status outputs to their fallback value, for example when measuring has to be interrupted while a pipe is being cleaned. This function takes priority over all other device functions: simulations, for example, are suppressed.

Failsafe mode of outputs and totalizers		
	Process/system error is current	Positive zero return is activated
<p> <b>Caution!</b> System or process errors defined as "Notice messages" have no effect whatsoever on the inputs and outputs. See the information on → 58</p>		
Current output	<p><b>MINIMUM VALUE</b>                      4-20 mA (25 mA) → 2 mA                      4-20 mA NAMUR → 3.5 mA                      4-20 mA US → 3.75 mA                      4-20 mA (25 mA) HART → 2 mA                      4-20 mA HART NAMUR → 3.5 mA                      4-20 mA HART US → 3.75 mA</p> <p><b>MAXIMUM VALUE</b>                      4-20 mA (25 mA) → 25 mA                      4-20 mA NAMUR → 22.6 mA                      4-20 mA US → 22.6 mA                      4-20 mA (25 mA) HART → 25 mA                      4-20 mA HART NAMUR → 22.6 mA                      4-20 mA HART US → 22.6 mA</p> <p><b>HOLD VALUE</b>                      Last valid value (preceding occurrence of the fault) is output.</p> <p><b>ACTUAL VALUE</b>                      Measured value display on the basis of the current flow measurement. The fault is ignored.</p>	Output signal corresponds to "zero flow"
Pulse output	<p><b>MIN/MAX VALUE → FALLBACK VALUE</b>                      Signal output → no pulses</p> <p><b>HOLD VALUE</b>                      Last valid value (preceding occurrence of the fault) is output.</p> <p><b>ACTUAL VALUE</b>                      Fault is ignored, i.e. normal measured-value output on the basis of ongoing flow measurement.</p>	Output signal corresponds to "zero flow"
Totalizer	<p><b>MINIMUM/MAXIMUM VALUE → STOP</b>                      The totalizers are paused until the error is rectified.</p> <p><b>ACTUAL VALUE</b>                      The fault is ignored. The totalizer continues to count in accordance with the current flow value.</p>	Totalizer stops
Status output	In the event of a fault or power supply failure: Status output → non-conductive	No effect on status output

## 9.6 Spare parts

Detailed troubleshooting instructions are provided in the previous sections → 73  
 The measuring device, moreover, provides additional support in the form of continuous self-diagnosis and error messages.

Fault rectification can entail replacing defective components with tested spare parts. The illustration below shows the available scope of spare parts.



Note!

You can order spare parts directly from your Endress+Hauser service organization by providing the serial number printed on the transmitter's nameplate → 6.

Spare parts are shipped as sets comprising the following parts:

- Spare part
- Additional parts, small items (threaded fasteners, etc.)
- Mounting instructions
- Packaging

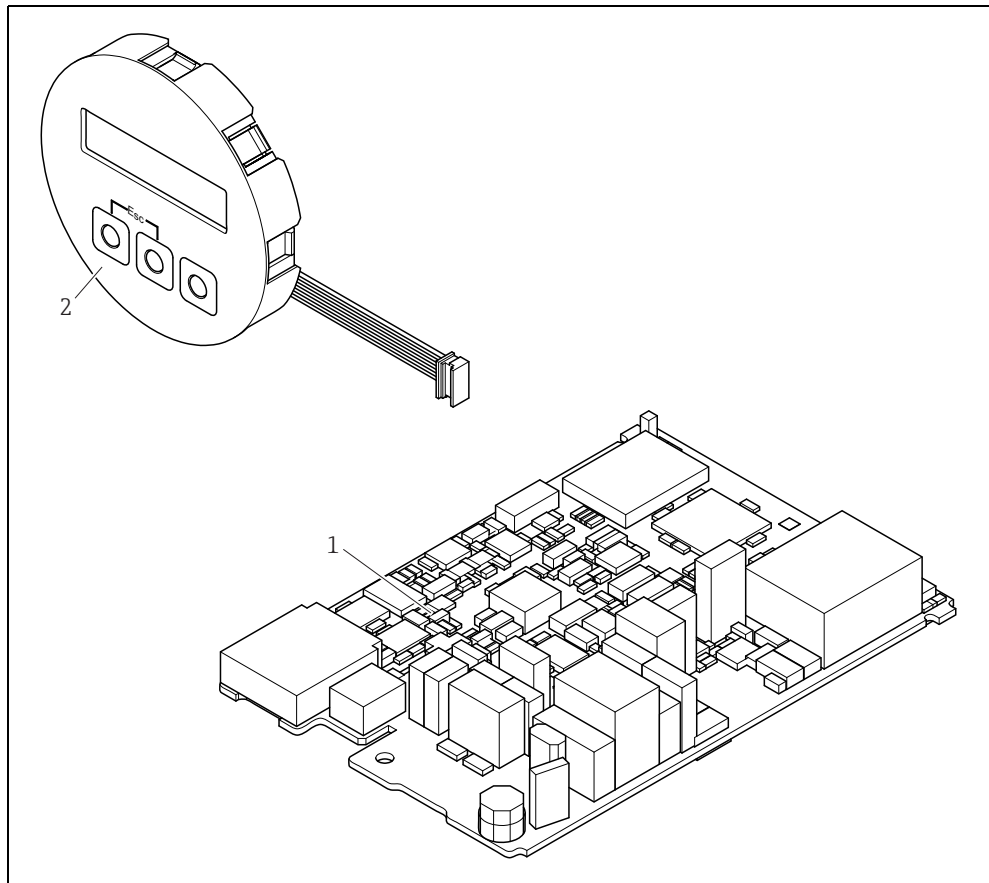

Fig. 49: Spare parts for Promag 10 transmitter

- 1 Electronics board
- 2 Display module

## 9.6.1 Removing and installing printed circuit boards

### Field housing: removing and installing electronics boards → 50



#### Warning!

- Risk of electric shock!  
Exposed components carry dangerous voltages. Make sure that the power supply is switched off before you remove the cover of the electronics compartment.
- Risk of damaging electronic components (ESD protection). Static electricity can damage electronic components or impair their operability. Use a workplace with a grounded working surface purpose-built for electrostatically sensitive devices!
- If you cannot guarantee that the dielectric strength of the device is maintained in the following steps, then an appropriate inspection must be carried out in accordance with the manufacturer's specifications.



#### Caution!

Use only original Endress+Hauser parts.



#### Note!

Commissioning a new electronics board: →  67

1. Switch off power supply.
2. Unscrew cover of the electronics compartment from the transmitter housing.
3. Remove the local display (a) from the connection compartment cover.
4. Press the side latches (b) and flip down the cover of the connection compartment.
5. Disconnect the connector of the electrode signal cable (c) and the coil current cable (d).
6. Disconnect the connector for the power supply (e) and the outputs (f).
7. Disconnect the connector of the local display (g).
8. Remove the cover from the connection compartment (h) by loosening the screws.
9. Plug out the ground cable (i) of the electronics board.
10. Pull entire module (plastic retainer and electronics board) out of the housing.
11. Press the side latches (j) slightly outwards and partly push out the electronics board towards the rear from the front.
12. Remove the electronics board from the plastic retainer from the rear.
13. Installation is the reverse of the removal procedure.

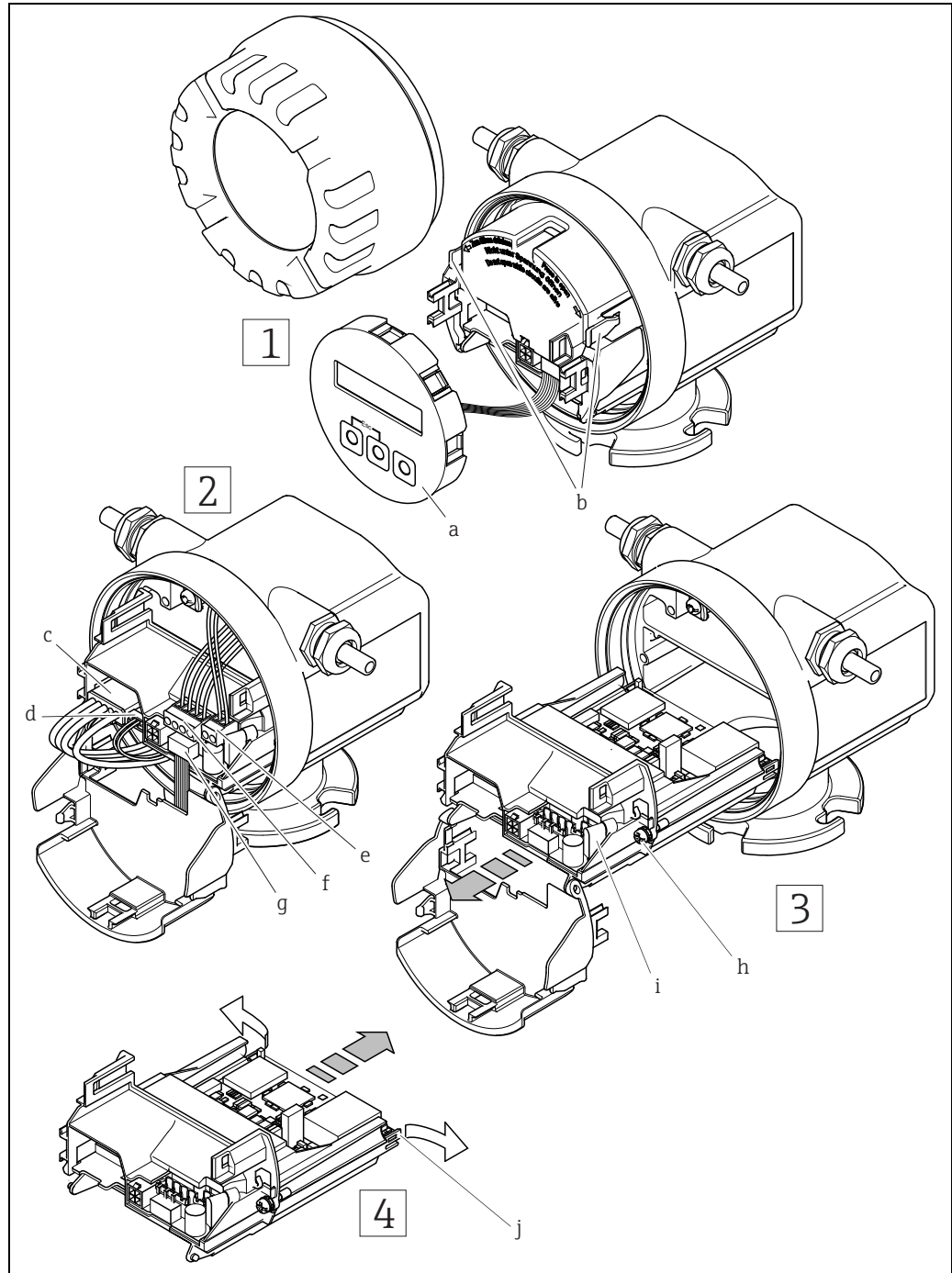

a0005388

Fig. 50: Field housing: removing and installing printed circuit boards

- a Local display
- b Latches
- c Connector of the electrode signal cable
- d Connector of the coil current cable
- e Connector for the power supply
- f Connector for current output and pulse/status output
- g Connector of local display
- h Screws of electronics compartment cover
- i Connector of the ground cable
- j Latches for the electronics board



## 9.6.2 Replacing the device fuse



**Warning!**

Risk of electric shock!

Exposed components carry dangerous voltages. Make sure that the power supply is switched off before you remove the cover of the electronics compartment.

The main fuse is located on the electronics board (→  51).

The procedure for replacing the fuse is as follows:

1. Switch off power supply.
2. Unscrew cover of the electronics compartment from the transmitter housing.
3. Press the side latches and flip down the cover of the connection compartment.
4. Remove the connector for the power supply (a).
5. Replace device fuse (b). Only use the following fuse type:  
Use only fuses of the following type:
  - Power supply 11 to 40 V DC / 20 to 28 V AC → 1.6 A slow-blow / 250 V TR5
  - Power supply 85 to 250 V DC → 1 A slow-blow / 250 V TR5
6. Installation is the reverse of the removal procedure.



**Caution!**

Use only original Endress+Hauser parts.

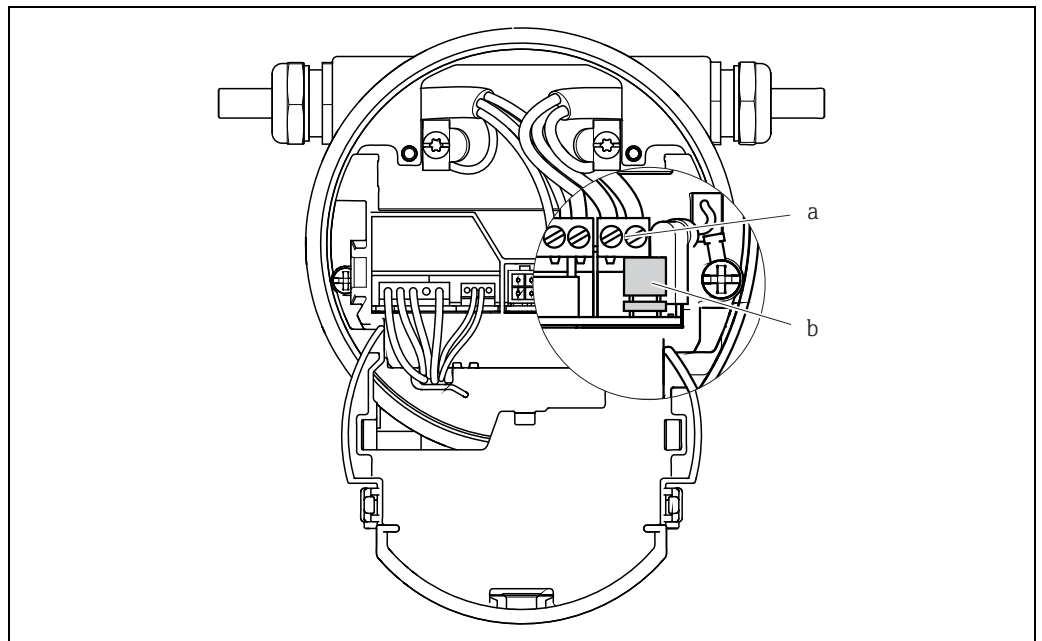

Fig. 51: Replacing the device fuse on the electronics board

- a Connector for power supply  
b Device fuse

A0005389

## 9.7 Return



### Caution!

Do not return a measuring device if you are not absolutely certain that all traces of hazardous substances have been removed, e.g. substances which have penetrated crevices or diffused through plastic.

Costs incurred for waste disposal and injury (burns, etc.) due to inadequate cleaning will be charged to the owner-operator.

The following steps must be taken before returning a flow measuring device to Endress+Hauser, e.g. for repair or calibration:

- Always enclose a duly completed "Declaration of contamination" form. Only then can Endress+Hauser transport, examine and repair a returned device.
- Enclose special handling instructions if necessary, for example a safety data sheet as per EC REACH Regulation No. 1907/2006.
- Remove all residues. Pay special attention to the grooves for seals and crevices which could contain residues. This is particularly important if the substance is hazardous to health, e.g. flammable, toxic, caustic, carcinogenic, etc.



### Note!

You will find a preprinted "Declaration of contamination" form at the back of these Operating Instructions.

## 9.8 Disposal

Observe the regulations applicable in your country!

## 9.9 Software history

Date	Software version	Changes to software	Operating Instructions
03.2016	V 1.04.00	Introduction of a new sensor Promag D with threaded connection	71315813/17.16
01.2012	V 1.04.00	Introduction of new nominal diameters; faster coil current control; calf-values to 2.5	71249469/15.14
11.2009	V 1.03.00	Introduction of Calf history	71106179/12.09 71105338/11.09
06.2009	V 1.02.00	Introduction of Promag L	71095705/06.09
03.2009	V 1.02.00	Introduction of Promag D; introduction of new nominal diameter.	71088674/03.09
10.2004	V 1.02.00	Software modification/extension Function: SELF CHECKING	50104787/05.05
09.2004	V 1.01.01	Software modification; extension of nominal diameter range	50104787/04.03
06.2004	V 1.01.00	Software extension; preparation for uploading/downloading via ToF Tool - Fieldtool Package	50104787/04.03
08.2003	V 1.00.02	Production-related software modification	50104787/04.03
01.2003	V 1.00.00	Original software. Compatible with: ToF Tool - Fieldtool Package, HART Communicator DXR 275 (from OS 4.6) with Rev. 1, DD 1.	50104787/04.03



### Note!

Uploads or downloads between the individual software versions are only possible with a special service software.

## 10 Technical data

### 10.1 Application

→  4

### 10.2 Function and system design

**Measuring principle** Electromagnetic flow measurement on the basis of Faraday's Law.

**Measuring system** →  6

### 10.3 Input

**Measured variable** Flow velocity (proportional to induced voltage)

**Measuring range** Typically  $v = 0.01$  to  $10$  m/s ( $0.033$  to  $33$  ft/s) with the specified accuracy

#### Standard version

Flow characteristic values (SI units)					
Diameter		Recommended flow Min./max. full scale value ( $v \sim 0.3$ or $10$ m/s)	Factory settings		
[mm]	[inch]		Full scale value Current output ( $v \sim 2.5$ m/s)	Pulse value ( $\sim 2$ pulses/s)	Low flow ( $v \sim 0.04$ m/s)
25	1"	9 to 300 dm <sup>3</sup> /min	75 dm <sup>3</sup> /min	0.50 dm <sup>3</sup>	1 dm <sup>3</sup> /min
32	-	15 to 500 dm <sup>3</sup> /min	125 dm <sup>3</sup> /min	1.00 dm <sup>3</sup>	2 dm <sup>3</sup> /min
40	1½"	25 to 700 dm <sup>3</sup> /min	200 dm <sup>3</sup> /min	1.50 dm <sup>3</sup>	3 dm <sup>3</sup> /min
50	2"	35 to 1100 dm <sup>3</sup> /min	300 dm <sup>3</sup> /min	2.50 dm <sup>3</sup>	5 dm <sup>3</sup> /min
65	-	60 to 2000 dm <sup>3</sup> /min	500 dm <sup>3</sup> /min	5.00 dm <sup>3</sup>	8 dm <sup>3</sup> /min
80	3"	90 to 3000 dm <sup>3</sup> /min	750 dm <sup>3</sup> /min	5.00 dm <sup>3</sup>	12 dm <sup>3</sup> /min
100	4"	145 to 4700 dm <sup>3</sup> /min	1200 dm <sup>3</sup> /min	10.00 dm <sup>3</sup>	20 dm <sup>3</sup> /min
125	-	220 to 7500 dm <sup>3</sup> /min	1850 dm <sup>3</sup> /min	15.00 dm <sup>3</sup>	30 dm <sup>3</sup> /min
150	6"	20 to 600 m <sup>3</sup> /h	150 m <sup>3</sup> /h	0.025 m <sup>3</sup>	2.5 m <sup>3</sup> /h
200	8"	35 to 1100 m <sup>3</sup> /h	300 m <sup>3</sup> /h	0.05 m <sup>3</sup>	5.0 m <sup>3</sup> /h
250	10"	55 to 1700 m <sup>3</sup> /h	500 m <sup>3</sup> /h	0.05 m <sup>3</sup>	7.5 m <sup>3</sup> /h
300	12"	80 to 2400 m <sup>3</sup> /h	750 m <sup>3</sup> /h	0.10 m <sup>3</sup>	10 m <sup>3</sup> /h
350	14"	110 to 3300 m <sup>3</sup> /h	1000 m <sup>3</sup> /h	0.10 m <sup>3</sup>	15 m <sup>3</sup> /h
375	15"	140 to 4200 m <sup>3</sup> /h	1200 m <sup>3</sup> /h	0.15 m <sup>3</sup>	20 m <sup>3</sup> /h
400	16"	140 to 4200 m <sup>3</sup> /h	1200 m <sup>3</sup> /h	0.15 m <sup>3</sup>	20 m <sup>3</sup> /h
450	18"	180 to 5400 m <sup>3</sup> /h	1500 m <sup>3</sup> /h	0.25 m <sup>3</sup>	25 m <sup>3</sup> /h
500	20"	220 to 6600 m <sup>3</sup> /h	2000 m <sup>3</sup> /h	0.25 m <sup>3</sup>	30 m <sup>3</sup> /h
600	24"	310 to 9600 m <sup>3</sup> /h	2500 m <sup>3</sup> /h	0.30 m <sup>3</sup>	40 m <sup>3</sup> /h
700	28"	420 to 13500 m <sup>3</sup> /h	3500 m <sup>3</sup> /h	0.50 m <sup>3</sup>	50 m <sup>3</sup> /h
-	30"	480 to 15000 m <sup>3</sup> /h	4000 m <sup>3</sup> /h	0.50 m <sup>3</sup>	60 m <sup>3</sup> /h

Flow characteristic values (SI units)					
Diameter		Recommended flow Min./max. full scale value (v ~ 0.3 or 10 m/s)	Factory settings		
[mm]	[inch]		Full scale value Current output (v ~ 2.5 m/s)	Pulse value (~ 2 pulses/s)	Low flow (v ~ 0.04 m/s)
800	32"	550 to 18000 m <sup>3</sup> /h	4500 m <sup>3</sup> /h	0.75 m <sup>3</sup>	75 m <sup>3</sup> /h
900	36"	690 to 22500 m <sup>3</sup> /h	6000 m <sup>3</sup> /h	0.75 m <sup>3</sup>	100 m <sup>3</sup> /h
1000	40"	850 to 28000 m <sup>3</sup> /h	7000 m <sup>3</sup> /h	1.00 m <sup>3</sup>	125 m <sup>3</sup> /h
-	42"	950 to 30000 m <sup>3</sup> /h	8000 m <sup>3</sup> /h	1.00 m <sup>3</sup>	125 m <sup>3</sup> /h
1200	48"	1250 to 40000 m <sup>3</sup> /h	10000 m <sup>3</sup> /h	1.50 m <sup>3</sup>	150 m <sup>3</sup> /h
-	54"	1550 to 50000 m <sup>3</sup> /h	13000 m <sup>3</sup> /h	1.50 m <sup>3</sup>	200 m <sup>3</sup> /h
1400	-	1700 to 55000 m <sup>3</sup> /h	14000 m <sup>3</sup> /h	2.00 m <sup>3</sup>	225 m <sup>3</sup> /h
-	60"	1950 to 60000 m <sup>3</sup> /h	16000 m <sup>3</sup> /h	2.00 m <sup>3</sup>	250 m <sup>3</sup> /h
1600	-	2200 to 70000 m <sup>3</sup> /h	18000 m <sup>3</sup> /h	2.50 m <sup>3</sup>	300 m <sup>3</sup> /h
-	66"	2500 to 80000 m <sup>3</sup> /h	20500 m <sup>3</sup> /h	2.50 m <sup>3</sup>	325 m <sup>3</sup> /h
1800	72"	2800 to 90000 m <sup>3</sup> /h	23000 m <sup>3</sup> /h	3.00 m <sup>3</sup>	350 m <sup>3</sup> /h
-	78"	3300 to 100000 m <sup>3</sup> /h	28500 m <sup>3</sup> /h	3.50 m <sup>3</sup>	450 m <sup>3</sup> /h
2000	-	3400 to 110000 m <sup>3</sup> /h	28500 m <sup>3</sup> /h	3.50 m <sup>3</sup>	450 m <sup>3</sup> /h

Flow characteristic values (US units)					
Diameter		Recommended flow rate Min./max. full scale value (v ~ 0.3 or 10 m/s)	Factory settings		
[inch]	[mm]		Full scale value Current output (v ~ 2.5 m/s)	Pulse value (~ 2 pulses/s)	Low flow (v ~ 0.04 m/s)
1"	25	2.5 to 80 gal/min	18 gal/min	0.20 gal	0.25 gal/min
-	32	4 to 130 gal/min	30 gal/min	0.20 gal	0.50 gal/min
1½"	40	7 to 190 gal/min	50 gal/min	0.50 gal	0.75 gal/min
2"	50	10 to 300 gal/min	75 gal/min	0.50 gal	1.25 gal/min
-	65	16 to 500 gal/min	130 gal/min	1 gal	2.0 gal/min
3"	80	24 to 800 gal/min	200 gal/min	2 gal	2.5 gal/min
4"	100	40 to 1250 gal/min	300 gal/min	2 gal	4.0 gal/min
-	125	60 to 1950 gal/min	450 gal/min	5 gal	7.0 gal/min
6"	150	90 to 2650 gal/min	600 gal/min	5 gal	12 gal/min
8"	200	155 to 4850 gal/min	1200 gal/min	10 gal	15 gal/min
10"	250	250 to 7500 gal/min	1500 gal/min	15 gal	30 gal/min
12"	300	350 to 10600 gal/min	2400 gal/min	25 gal	45 gal/min
14"	350	500 to 15000 gal/min	3600 gal/min	30 gal	60 gal/min
15"	375	600 to 19000 gal/min	4800 gal/min	50 gal	60 gal/min
16"	400	600 to 19000 gal/min	4800 gal/min	50 gal	60 gal/min
18"	450	800 to 24000 gal/min	6000 gal/min	50 gal	90 gal/min
20"	500	1000 to 30000 gal/min	7500 gal/min	75 gal	120 gal/min
24"	600	1400 to 44000 gal/min	10500 gal/min	100 gal	180 gal/min
28"	700	1900 to 60000 gal/min	13500 gal/min	125 gal	210 gal/min
30"	-	2150 to 67000 gal/min	16500 gal/min	150 gal	270 gal/min
32"	800	2450 to 80000 gal/min	19500 gal/min	200 gal	300 gal/min

Flow characteristic values (US units)					
Diameter		Recommended flow rate Min./max. full scale value (v ~ 0.3 or 10 m/s)	Factory settings		
[inch]	[mm]		Full scale value Current output (v ~ 2.5 m/s)	Pulse value (~ 2 pulses/s)	Low flow (v ~ 0.04 m/s)
36"	900	3100 to 100000 gal/min	24000 gal/min	225 gal	360 gal/min
40"	1000	3800 to 125000 gal/min	30000 gal/min	250 gal	480 gal/min
42"	-	4200 to 135000 gal/min	33000 gal/min	250 gal	600 gal/min
48"	1200	5500 to 175000 gal/min	42000 gal/min	400 gal	600 gal/min
54"	-	9 to 300 Mgal/min	75 Mgal/min	0.0005 Mgal	1.3 Mgal/min
-	1400	10 to 340 Mgal/min	85 Mgal/min	0.0005 Mgal	1.3 Mgal/min
60"	-	12 to 380 Mgal/min	95 Mgal/min	0.0005 Mgal	1.3 Mgal/min
-	1600	13 to 450 Mgal/min	110 Mgal/min	0.0008 Mgal	1.7 Mgal/min
66"	-	14 to 500 Mgal/min	120 Mgal/min	0.0008 Mgal	2.2 Mgal/min
72"	1800	16 to 570 Mgal/min	140 Mgal/min	0.0008 Mgal	2.6 Mgal/min
78"	-	18 to 650 Mgal/min	175 Mgal/min	0.001 Mgal	3.0 Mgal/min
-	2000	20 to 700 Mgal/min	175 Mgal/min	0.001 Mgal	3.0 Mgal/min

### Optional version w/o inlet and outlet runs

Flow characteristic values (SI units)					
Diameter		Recommended flow Min./max. full scale value (v ~ 0.12/5 m/s)	Factory settings		
[mm]	[inch]		Full scale value current output (v ~ 2.5 m/s)	Pulse value (~ 4 pulses/s)	Low flow (v ~ 0.02 m/s)
50	2"	15 to 600 dm <sup>3</sup> /min	300 dm <sup>3</sup> /min	1.25 dm <sup>3</sup>	2.25 dm <sup>3</sup> /min
65	-	25 to 1000 dm <sup>3</sup> /min	500 dm <sup>3</sup> /min	2 dm <sup>3</sup>	4 dm <sup>3</sup> /min
80	3"	35 to 1500 dm <sup>3</sup> /min	750 dm <sup>3</sup> /min	3 dm <sup>3</sup>	6 dm <sup>3</sup> /min
100	4"	60 to 2400 dm <sup>3</sup> /min	1200 dm <sup>3</sup> /min	5 dm <sup>3</sup>	9.5 dm <sup>3</sup> /min
125	-	90 to 3700 dm <sup>3</sup> /min	1850 dm <sup>3</sup> /min	8 dm <sup>3</sup>	15 dm <sup>3</sup> /min
150	6"	145 to 5400 dm <sup>3</sup> /min	2500 dm <sup>3</sup> /min	10 dm <sup>3</sup>	20 dm <sup>3</sup> /min
200	8"	220 to 9400 dm <sup>3</sup> /min	5000 dm <sup>3</sup> /min	20 dm <sup>3</sup>	35 dm <sup>3</sup> /min
250	10"	20 to 850 m <sup>3</sup> /h	500 m <sup>3</sup> /h	0.03 m <sup>3</sup>	3.5 m <sup>3</sup> /h
300	12"	35 to 1300 m <sup>3</sup> /h	750 m <sup>3</sup> /h	0.05 m <sup>3</sup>	5 m <sup>3</sup> /h

Flow characteristic values (US units)					
Diameter		Recommended flow Min./max. full scale value (v ~ 0.12/5 m/s)	Factory settings		
[inch]	[mm]		Full scale value current output (v ~ 2.5 m/s)	Pulse value (~ 4 pulses/s)	Low flow (v ~ 0.02 m/s)
2"	50	4 to 160 gal/min	75 gal/min	0.3 gal	0.7 gal/min
-	65	7 to 260 gal/min	130 gal/min	0.5 gal	1.1 gal/min
3"	80	10 to 400 gal/min	200 gal/min	0.8 gal	1.6 gal/min
4"	100	16 to 650 gal/min	300 gal/min	1.2 gal	2.5 gal/min
-	125	24 to 1000 gal/min	450 gal/min	1.8 gal	4 gal/min
6"	150	40 to 1400 gal/min	600 gal/min	2.5 gal	6 gal/min

Flow characteristic values (US units)					
Diameter		Recommended flow Min./max. full scale value (v ~ 0.12/5 m/s)	Factory settings		
[inch ]	[mm]		Full scale value current output (v ~ 2.5 m/s)	Pulse value (~ 4 pulses/s)	Low flow (v ~ 0.02 m/s)
8"	200	60 to 2500 gal/min	1200 gal/min	5 gal	10 gal/min
10"	250	90 to 3700 gal/min	1500 gal/min	6 gal	16 gal/min
12"	300	155 to 5700 gal/min	2400 gal/min	9 gal	23 gal/min

**Operable flow range** Over 1000 : 1

## 10.4 Output

### Output signal

#### Current output

- Galvanically isolated
- Active: 4 to 20 mA,  $R_L < 700 \Omega$  (for HART:  $R_L \geq 250 \Omega$ )
- Full scale value adjustable
- Temperature coefficient: typ. 2  $\mu A/^\circ C$ , resolution: 1.5  $\mu A$

#### Pulse/status output:

- Galvanically isolated
- Passive: 30 V DC / 250 mA
- Open collector
- Can be configured as:
  - Pulse output  
Pulse value and pulse polarity can be selected, max. pulse width adjustable (5 to 2000 ms), pulse frequency max. 100 Hz
  - Status output  
For example, can be configured for error messages, empty pipe detection, flow recognition, limit value

### Signal on alarm

#### Current output

Failsafe mode can be selected (e.g. in accordance with NAMUR Recommendation NE 43) →  134

#### Pulse output

Failsafe mode can be selected →  134

#### Status output

"Not conductive" in the event of fault or power supply failure

### Load

See "Output signal"





### Low flow cut off

Low flow cut off, switch-on point can be selected as required

### Galvanic isolation

All circuits for inputs, outputs, and power supply are galvanically isolated from each other.

## 10.5 Power supply

<b>Terminal assignment</b>	→  49
<b>Supply voltage</b>	<ul style="list-style-type: none"> <li>■ 20 to 28 V AC, 45 to 65 Hz</li> <li>■ 85 to 250 V AC, 45 to 65 Hz</li> <li>■ 11 to 40 V DC</li> </ul>
<b>Power consumption</b>	<p><b>Power consumption</b></p> <ul style="list-style-type: none"> <li>■ 20 to 28 V AC: &lt;8 VA (incl. sensor)</li> <li>■ 85 to 250 V AC: &lt;12 VA (incl. sensor)</li> <li>■ 11 to 40 V DC: &lt;6 W (incl. sensor)</li> </ul> <p><b>Switch-on current:</b></p> <ul style="list-style-type: none"> <li>■ Max. 3.3 A (&lt;5 ms) for 24 V DC</li> <li>■ Max. 5.5 A (&lt;5 ms) for 28 V DC</li> <li>■ Max. 16 A (&lt;5 ms) for 250 V DC</li> </ul>
<b>Power supply failure</b>	Lasting min. ½ cycle frequency: EEPROM saves measuring system data
<b>Electrical connections</b>	→  42
<b>Potential equalization</b>	→  50
<b>Cable entry</b>	<p><b>Power supply and signal cables (inputs/outputs):</b></p> <ul style="list-style-type: none"> <li>■ Cable entry M20 × 1.5 (8 to 12 mm/0.31 to 0.47 inch)</li> <li>■ Threads for cable entries ½" NPT, G ½"</li> </ul> <p><b>Connecting cable for remote version:</b></p> <ul style="list-style-type: none"> <li>■ Cable entry M20 × 1.5 (8 to 12 mm/0.31 to 0.47 inch)</li> <li>■ Threads for cable entries ½" NPT, G ½"</li> </ul>
<b>Cable specifications</b>	→  47

## 10.6 Performance characteristics

### Reference operating conditions

- Error limits following DIN EN 29104, future ISO 20456
- Water, typically +4 to +35°C (+39 to +95 °F); 2 to 6 bar (29 to 87 psi)
- Specification as per calibration protocol  $\pm 5^\circ\text{C}$  ( $\pm 41^\circ\text{F}$ ) and  $\pm 2$  bar ( $\pm 29$  psi)
- Data on the measured error based on accredited calibration rigs traced back to ISO 17025

### Maximum measured error

- Current output: plus typically  $\pm 5 \mu\text{A}$
- Pulse output:  $\pm 0.5\%$  o.r.  $\pm 2$  mm/s (o.r. = of reading)

Fluctuations in the supply voltage do not have any effect within the specified range.

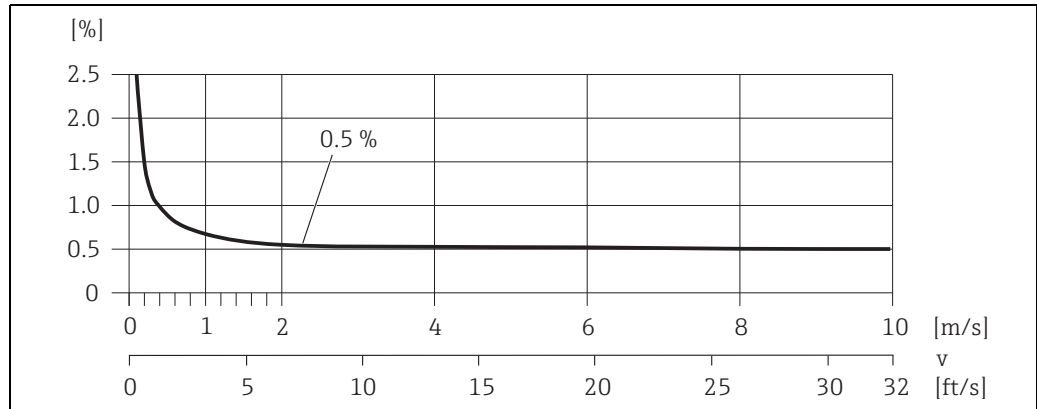

Fig. 52: Max. measured error in % of reading

### Repeatability

Max.  $\pm 0.2\%$  o.r.  $\pm 2$  mm/s (o.r. = of reading)

## 10.7 Installation

"Mounting requirements" ( $\rightarrow$  11)

## 10.8 Environment

### Ambient temperature range

- Transmitter:  $-20$  to  $+60^\circ\text{C}$  ( $-4$  to  $+140^\circ\text{F}$ )

Note!

At ambient temperatures below  $-20$  ( $-4^\circ\text{F}$ ) the readability of the display may be impaired.



- Sensor (flange material carbon steel):  $-10$  to  $+60^\circ\text{C}$  ( $+14$  to  $+140^\circ\text{F}$ )



Caution!

- The permitted temperature range of the measuring tube lining may not be undershot or overshoot ( $\rightarrow$  "Operating conditions: Process"  $\rightarrow$  "Medium temperature range").
- Install the device in a shady location. Avoid direct sunlight, particularly in warm climatic regions.
- The transmitter must be mounted separate from the sensor if both the ambient and fluid temperatures are high.



<b>Storage temperature</b>	The storage temperature corresponds to the operating temperature range of the measuring transmitter and the appropriate measuring sensors.
	<p>Caution!</p> <ul style="list-style-type: none"> <li>■ The measuring device must be protected against direct sunlight during storage in order to avoid unacceptably high surface temperatures.</li> <li>■ A storage location must be selected where moisture does not collect in the measuring device. This will help prevent fungus and bacteria infestation which can damage the liner.</li> </ul>
<b>Degree of protection</b>	<ul style="list-style-type: none"> <li>■ Standard: IP 67 (NEMA 4X) for transmitter and sensor.</li> <li>■ Optional: IP 68 (NEMA 6P) for sensor Promag E/L/P/W in remote version. Promag L is only available with stainless steel flanges.</li> </ul>
<b>Shock and vibration resistance</b>	Acceleration up to 2 g following IEC 600 68-2-6
<b>CIP cleaning</b>	<p> Caution! The maximum fluid temperature permitted for the device may not be exceeded.</p> <p><i>CIP cleaning is possible:</i> Promag E (100 °C / 212 °F), Promag H/P</p> <p><i>CIP cleaning is not possible:</i> Promag D/L/W</p>
<b>SIP cleaning</b>	<p> Caution! The maximum fluid temperature permitted for the device may not be exceeded.</p> <p><i>SIP cleaning is possible:</i> Promag H</p> <p><i>SIP cleaning is not possible:</i> Promag D/E/L/P/W</p>
<b>Electromagnetic compatibility (EMC)</b>	<ul style="list-style-type: none"> <li>■ As per IEC/EN 61326 and NAMUR Recommendation NE 21</li> <li>■ Emission: to limit value for industry EN 55011</li> </ul>

## 10.9 Process

<b>Medium temperature range</b>	The permissible temperature depends on the lining of the measuring tube
	<p><b>Promag D</b></p> <p>0 to +60 °C (+32 to +140 °F) for polyamide</p>
	<p><b>Promag E</b></p> <p>-10 to +110 °C (+14 to +230 °F) for PTFE, Restrictions → see the following diagram</p>

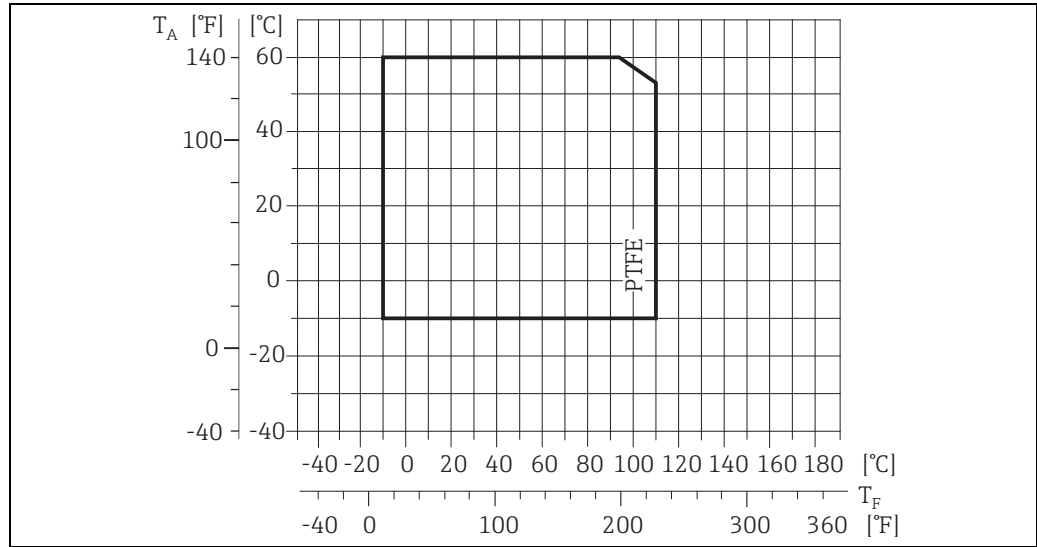

Fig. 53: Compact and remote version Promag E ( $T_A$  = ambient temperature;  $T_F$  = fluid temperature)

**Promag H**

Sensor:

- DN 2 to 25 (1/12 to 1"): -20 to +150 °C (-4 to +302 °F)
- DN 40 to 100 (1 1/2 to 4"): -20 to +150 °C (-4 to +302 °F)

Seals:

- EPDM/Viton (FKM)/Kalrez: -20 to +150 °C (-4 to +302 °F)

**Promag L**

- 0 to +80 °C (+32 to +176 °F) for hard rubber (DN 350 to 2400 / 14 to 90")
- -20 to +50 °C (-4 to +122 °F) for polyurethane (DN 25 to 1200 / 1 to 48")
- -20 to +90 °C (-4 to +194 °F) for PTFE (DN 25 to 300 / 1 to 12")

**Promag P**

-40 to +130 °C (-40 to +266 °F) for PTFE (DN 25 to 600 / 1 to 24"),  
Restrictions → see the following diagram

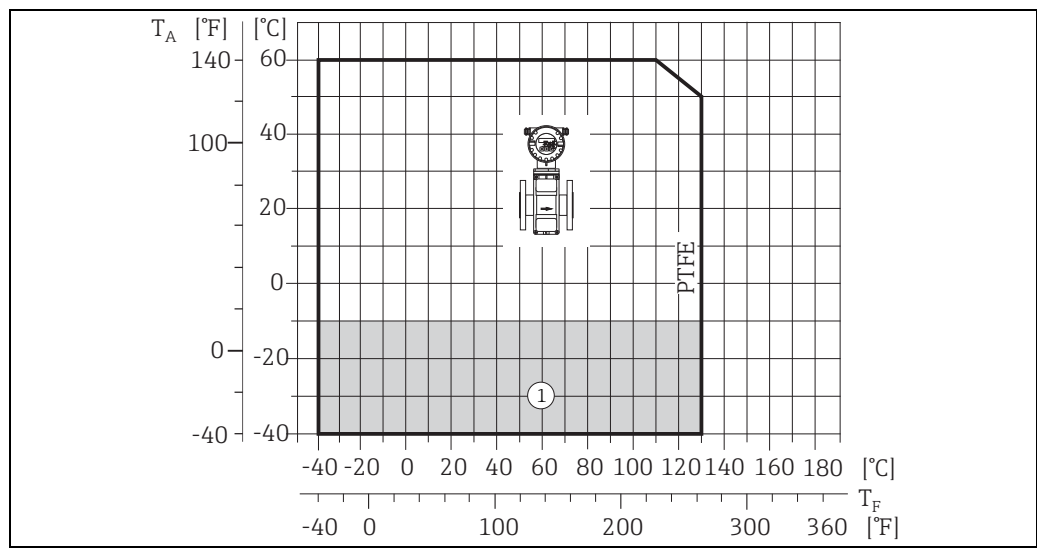

Fig. 54: Compact version Promag P with PTFE-lining

$T_A$  = ambient temperature;  $T_F$  = fluid temperature  
A = light gray area → temperature range from -10 to -40 °C (-14 to -40 °F) valid for stainless steel version only

**Promag W**

- 0 to +80 °C (+32 to +176 °F) for hard rubber (DN 65 to 2000 / 2 ½ to 78")
- -20 to +50 °C (-4 to +122 °F) for polyurethane (DN 25 to 1000 / 1 to 48")

**Conductivity**

The minimum conductivity is  $\geq 50 \mu\text{S}/\text{cm}$

Note!

Note that in the case of the remote version, the requisite minimum conductivity is also influenced by the length of the connecting cable → 16

**Pressure-temperature ratings**

An overview of the pressure-temperature ratings for the process connections are to be found in the "Technical Information" documents of the device in question.

**Medium pressure range (nominal pressure)****Promag D**

- EN 1092-1 (DIN 2501)
  - PN 16
- ASME B 16.5
  - Class 150
- JIS B2220
  - 10 K
- DIN ISO 228 (G" external thread)
  - PN 16
- ANSI/ASME B1.20 (NPT" external thread)
  - Class 150

**Promag E**

- EN 1092-1 (DIN 2501)
  - PN 10 (DN 200 to 600 / 8 to 24")
  - PN 16 (DN 65 to 600 / 3 to 24")
  - PN 40 (DN 15 to 150 / ½ to 2")
- ASME B 16.5
  - Class 150 (½ to 24")
- JIS B2220
  - 10 K (DN 50 to 300 / 2 to 12")
  - 20 K (DN 15 to 40 / ½ to 1½")

**Promag H**

The permissible nominal pressure depends on the process connection and the seal:

- PN 40, Class 150, 20 K → Couplings, flanges (with O-ring seal)
- PN 16 → Welding nipple, couplings, clamp, flange (with aseptic gasket seal)

**Promag L**

- EN 1092-1 (DIN 2501)
  - PN 6 (DN 350 to 2400 / 14 to 90")
  - PN 10 (DN 200 to 2400 / 8 to 90")
  - PN 16 (DN 25 to 300 / 1 to 12")
- EN 1092-1, lap joint flange, stampel plate
  - PN 10 (DN 25 to 300 / 1 to 12")
- ASME B16.5
  - Class 150 (1 to 24")
- AWWA
  - Class D (28 to 90")
- AS2129
  - Table E (350 to 1200 / 14 to 48")
- AS4087
  - PN 16 (350 to 1200 / 14 to 48")

**Promag P**

- EN 1092-1 (DIN 2501)
  - PN 10 (DN 200 to 600 / 8 to 24")
  - PN 16 (DN 65 to 600 / 3 to 24")
  - PN 25 (DN 200 to 600 / 8 to 24")
  - PN 40 (DN 25 to 150 / 1 to 6")
- ASME B 16.5
  - Class 150 (1 to 24")
  - Class 300 (1 to 6")
- JIS B2220
  - 10 K (DN 50 to 300 / 2 to 12")
  - 20 K (DN 25 to 300 / 1 to 12")
- AS 2129
  - Table E (DN 25 / 1"), 50 / 2")
- AS 4087
  - PN 16 (DN 50 / 2")

**Promag W**

- EN 1092-1 (DIN 2501)
  - PN 6 (DN 350 to 2000 / 14 to 84")
  - PN 10 (DN 200 to 2000 / 8 to 84")
  - PN 16 (DN 65 to 2000 / 3 to 84")
  - PN 25 (DN 200 to 1000 / 8 to 40")
  - PN 40 (DN 25 to 150 / 1 to 6")
- ASME B 16.5
  - Class 150 (1 to 24")
  - Class 300 (1 to 6")
- AWWA
  - Class D (28 to 78")
- JIS B2220
  - 10 K (DN 50 to 300 / 2 to 12")
  - 20 K (DN 25 to 300 / 1 to 12")
- AS 2129
  - Table E (DN 80 / 3", 100 / 4", 150 to 1200 / 6 to 48")
- AS 4087
  - PN 16 (DN 80 / 3", 100 / 4", 150 to 1200 / 6 to 48")

**Pressure tightness**

**Promag D**

Measuring tube: 0 mbar abs (0 psi abs) with a fluid temperature of ≤60 °C (140 °F)

**Promag E (Measuring tube lining: PTFE)**

Nominal diameter		Resistance of measuring tube lining to partial vacuum Limit values for abs. pressure [mbar] ([psi]) at various fluid temperatures							
		25 °C 77 °F		80 °C 176 °F		100 °C 212 °F		110 °C 230 °F	
[mm]	[inch]	[mbar]	[psi]			[mbar]	[psi]	[mbar]	[psi]
15	½"	0	0	0	0	0	0	100	1.45
25	1"	0	0	0	0	0	0	100	1.45
32	-	0	0	0	0	0	0	100	1.45
40	1 ½"	0	0	0	0	0	0	100	1.45
50	2"	0	0	0	0	0	0	100	1.45
65	-	0	0	*	*	40	0.58	130	1.89
80	3"	0	0	*	*	40	0.58	130	1.89
100	4"	0	0	*	*	135	1.96	170	2.47

Nominal diameter		Resistance of measuring tube lining to partial vacuum Limit values for abs. pressure [mbar] ([psi]) at various fluid temperatures							
[mm]	[inch]	25 °C		80 °C		100 °C		110 °C	
		77 °F		176 °F		212 °F		230 °F	
		[mbar]	[psi]			[mbar]	[psi]	[mbar]	[psi]
125	–	135	1.96	*	*	240	3.48	385	5.58
150	6"	135	1.96	*	*	240	3.48	385	5.58
200	8"	200	2.90	*	*	290	4.21	410	5.95
250	10"	330	4.79	*	*	400	5.80	530	7.69
300	12"	400	5.80	*	*	500	7.25	630	9.14
350	14"	470	6.82	*	*	600	8.70	730	10.59
400	16"	540	7.83	*	*	670	9.72	800	11.60
450	18"	Partial vacuum is impermissible!							
500	20"								
600	24"								
* No value can be quoted.									

### Promag H (Measuring tube lining: PFA)

Nominal diameter		Resistance of measuring tube lining to partial vacuum Limit values for abs. pressure [mbar] ([psi]) at various fluid temperatures					
[mm]	[inch]	25 °C	80 °C	100 °C	130 °C	150 °C	180 °C
		77 °F	176 °F	212 °F	266 °F	302 °F	356 °F
2 to 100	1/12 to 4"	0	0	0	0	0	0

### Promag L (Measuring tube lining: Polyurethane, Hard rubber)

Nominal diameter		Measuring tube lining	Resistance of measuring tube lining to partial vacuum Limit values for abs. pressure [mbar] ([psi]) at various fluid temperatures		
[mm]	[inch]		25 °C	50 °C	80 °C
			77 °F	122 °F	176 °F
25 to 1200	1 to 48"	25 to 1200	1 to 48"	0	–
350 to 2400	14 to 90"	Hard rubber	0	0	0

### Promag L (Measuring tube lining: PTFE)

Nominal diameter		Resistance of measuring tube lining to partial vacuum Limit values for abs. pressure [mbar] ([psi]) at various fluid temperatures			
[mm]	[inch]	25 °C		90 °C	
		77 °F		194 °F	
		[mbar]	[psi]	[mbar]	[psi]
25	1"	0	0	0	0
32	–	0	0	0	0
40	1 1/2"	0	0	0	0
50	2"	0	0	0	0
65	–	0	0	40	0.58
80	3"	0	0	40	0.58
100	4"	0	0	135	1.96
125	–	135	1.96	240	3.48
150	6"	135	1.96	240	3.48
200	8"	200	2.90	290	4.21
250	10"	330	4.79	400	5.80

Nominal diameter		Resistance of measuring tube lining to partial vacuum Limit values for abs. pressure [mbar] ([psi]) at various fluid temperatures			
[mm]	[inch]	25 °C		90 °C	
		77 °F		194 °F	
		[mbar]	[psi]	[mbar]	[psi]
300	12"	400	5.80	500	7.25

**Promag P (Measuring tube lining: PTFE)**

Nominal diameter		Resistance of measuring tube lining to partial vacuum Limit values for abs. pressure [mbar] ([psi]) at various fluid temperatures									
[mm]	[inch]	25 °C		80 °C		100 °C		130 °C		150 °C	180 °C
		77 °F		176 °F		212 °F		266 °F		302 °F	356 °F
		[mbar]	[psi]			[mbar]	[psi]	[mbar]	[psi]		
25	1"	0	0	0	0	0	0	100	1.45	-	-
32	-	0	0	0	0	0	0	100	1.45	-	-
40	1 ½"	0	0	0	0	0	0	100	1.45	-	-
50	2"	0	0	0	0	0	0	100	1.45	-	-
65	-	0	0	*	*	40	0.58	130	1.89	-	-
80	3"	0	0	*	*	40	0.58	130	1.89	-	-
100	4"	0	0	*	*	135	1.96	170	2.47	-	-
125	-	135	1.96	*	*	240	3.48	385	5.58	-	-
150	6"	135	1.96	*	*	240	3.48	385	5.58	-	-
200	8"	200	2.90	*	*	290	4.21	410	5.95	-	-
250	10"	330	4.79	*	*	400	5.80	530	7.69	-	-
300	12"	400	5.80	*	*	500	7.25	630	9.14	-	-
350	14"	470	6.82	*	*	600	8.70	730	10.59	-	-
400	16"	540	7.83	*	*	670	9.72	800	11.60	-	-
450	18"	Partial vacuum is impermissible!									
500	20"										
600	24"										

\* No value can be quoted.

**Promag W**

Nominal diameter		Measuring tube lining	Resistance of measuring tube lining to partial vacuum Limit values for abs. pressure [mbar] ([psi]) at various fluid temperatures						
[mm]	[inch]		25 °C	50 °C	80 °C	100 °C	130 °C	150 °C	180 °C
			77 °F	122 °F	176 °F	212 °F	266 °F	302 °F	356 °F
25 to 1200	1 to 40"	Polyurethane	0	0	-	-	-	-	-
50 to 2000	2 to 78"	Hard rubber	0	0	0	-	-	-	-

**Limiting flow**

The diameter of the pipe and the flow rate determine the nominal diameter of the sensor. The optimum flow velocity is between 2 to 3 m/s (6.5 to 9.8 ft/s).

The velocity of flow (v), moreover, has to be matched to the physical properties of the fluid:

- v < 2 m/s (6.5 ft/s): for abrasive fluids
- v > 2 m/s (6.5 ft/s): for fluids producing buildup



Note!

- Flow velocity can be increased, if necessary, by reducing the nominal diameter of the sensor (→ 15).
- For Promag H the selection of a pipe with nominal diameter > DN 8 (3/8") for fluids with high levels of solids may be considered, to improve the stability of the signal and cleanability due to larger electrodes.

Pressure loss

- No pressure loss if the sensor is installed in a pipe with the same nominal diameter.
- Pressure losses for configurations incorporating adapters according to DIN EN 545 (see "Adapters" → 15)



Abb. 55: Pressure loss DN 50 to 80 (2 to 3") for optional version w/o inlet and outlet runs (Promag 10W)



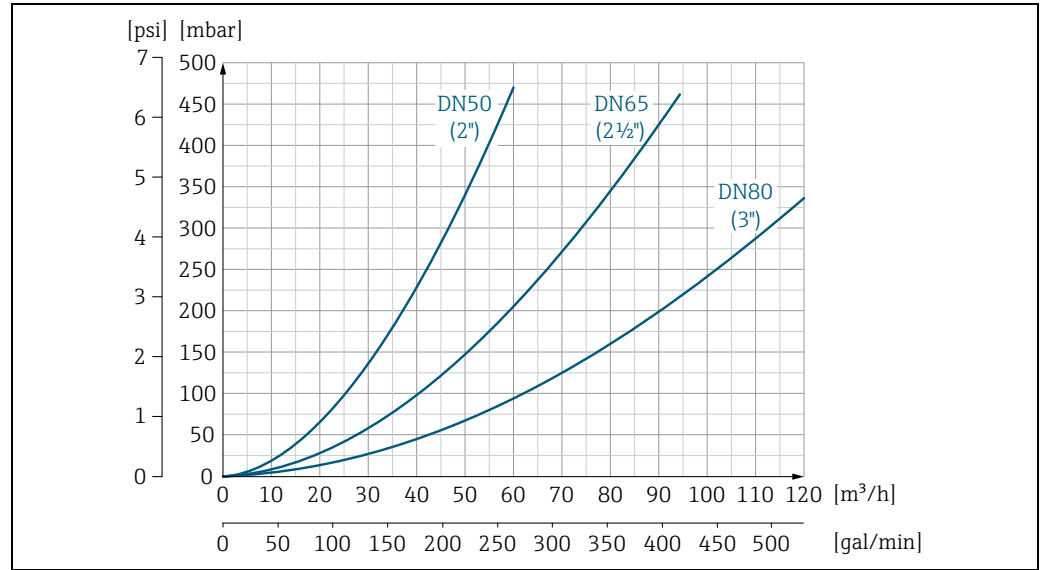

Abb. 56: Pressure loss DN 100 to 300 (4 to 12") for optional version w/o inlet and outlet runs (Promag 10W)

Vibrations

→ 14

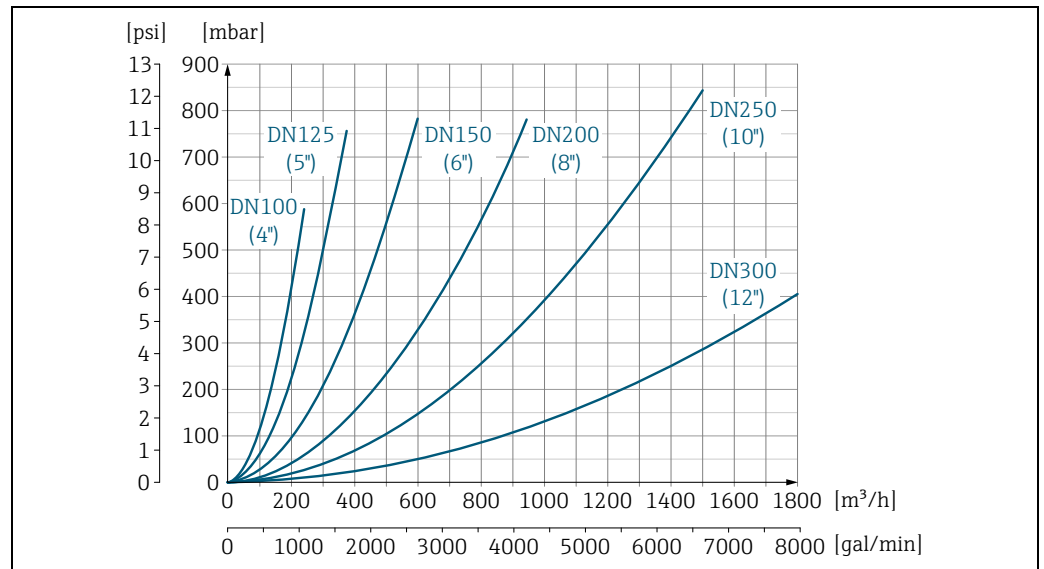
## 10.10 Mechanical construction

### Design, dimensions

The dimensions and installation lengths of the sensor and transmitter can be found in the "Technical Information" for the device in question. This document can be downloaded as a PDF file from [www.endress.com](http://www.endress.com). A list of the "Technical Information" documents available is provided in the "Documentation" section on →  112.

### Weight (SI units)

#### Promag D

Weight data in kg				
Nominal diameter		Compact version	Remote version (without cable)	
[mm]	[inch]		Sensor	Transmitter
25	1"	2.9	2.5	3.1
40	1 ½"	3.5	3.1	3.1
50	2"	4.3	3.9	3.1
65	2 ½"	5.1	4.7	3.1
80	3"	6.1	5.7	3.1
100	4"	8.8	8.4	3.1

Transmitter Promag (compact version): 1.8 kg (Weight data valid without packaging material)

#### Promag E

Weight data in kg							
Nominal diameter		Compact version					
[mm]	[inch]	EN (DIN)				ASME	JIS
		PN 6	PN 10	PN 16	PN 40	Class 150	10K
15	½"	-	-	-	6.5	6.5	6.5
25	1"	-	-	-	7.3	7.3	7.3
32	-	-	-	-	8.0	-	7.3
40	1½"	-	-	-	9.4	9.4	8.3
50	2"	-	-	-	10.6	10.6	9.3
65	-	-	-	12.0	-	-	11.1
80	3"	-	-	14.0	-	14.0	12.5
100	4"	-	-	16.0	-	16.0	14.7
125	-	-	-	21.5	-	-	21.0
150	6"	-	-	25.5	-	25.5	24.5
200	8"	-	45.0	46.0	-	45.0	41.9
250	10"	-	65.0	70.0	-	75.0	69.4
300	12"	-	70.0	81.0	-	110.0	72.3
350	14"	77.4	88.4	99.4	-	137.4	-
400	16"	89.4	104.4	120.4	-	168.4	-
450	18"	99.4	112.4	133.4	-	191.4	-
500	20"	114.4	132.4	182.4	-	228.4	-
600	24"	155.4	162.4	260.4	-	302.4	-

- Transmitter (compact version): 1.8 kg
- Weight data without packaging material



Weight data in kg								
Nominal diameter		Remote version (without cable)						Transmitter
		Sensor						
		EN (DIN)				ASME	JIS	
[mm]	[inch]	PN 6	PN 10	PN 16	PN 40	Class 150	10K	Wall-mount housing
15	½"	-	-	-	4.5	4.5	4.5	6.0
25	1"	-	-	-	5.3	5.3	5.3	
32	-	-	-	-	6.0	-	5.3	
40	1½"	-	-	-	7.4	7.4	6.3	
50	2"	-	-	-	8.6	8.6	7.3	
65	-	-	-	10.0	-	-	9.1	
80	3"	-	-	12.0	-	12.0	10.5	
100	4"	-	-	14.0	-	14.0	12.7	
125	-	-	-	19.5	-	-	19.0	
150	6"	-	-	23.5	-	23.5	22.5	
200	8"	-	43.0	44.0	-	43.0	39.9	
250	10"	-	63.0	68.0	-	73.0	67.4	
300	12"	-	68.0	79.0	-	108.0	70.3	
350	14"	73.1	84.1	95.1	-	133.1		
400	16"	85.1	100.1	116.1	-	164.1		
450	18"	95.1	108.1	129.1	-	187.1		
500	20"	110.1	128.1	178.1	-	224.1		
600	24"	158.1	158.1	256.1	-	298.1		

- Transmitter (remote version): 3.1 kg
- Weight data without packaging material

## Promag H

Weight data in kg				
Nominal diameter		Compact version	Remote version (without cable)	
			Sensor	Transmitter
[mm]	[inch]	DIN		
2	¼"	3.6	2	3.1
4	½"	3.6	2	3.1
8	¾"	3.6	2	3.1
15	1"	3.7	1.9	3.1
25	1½"	3.9	2.8	3.1
40	2"	4.9	4.5	3.1
50	2½"	7.4	7.0	3.1
65	3"	7.9	7.5	3.1
80	3½"	17.4	17.0	3.1
100	4"	16.9	16.5	3.1

Transmitter Promag (compact version): 1.8  
 (Weight data valid for standard pressure ratings and without packaging material)

Promag L

Weight data in kg													
Nominal diameter		Compact version (including transmitter) <sup>1)</sup>											
[mm]	[inch]	EN (DIN)					ASME/AWWA		AS				
25	1"		-		-		7.3		7.9		-		-
32	1 ¼"		-		-		8.0		-		-		-
40	1 ½"		-		-		9.0		7.5		-		-
50	2"		-		-		9.4		7.6		-		-
65	2 ½"		-		-		10.4		-		-		-
80	3"		-		-		12.4		12.8		-		-
100	4"		-		-		14.4		16.1		-		-
125	5"		-		-		15.9		-		-		-
150	6"		-		-		23.9		24.4		-		-
200	8"		-		43.4		44.9		49.6		-		-
250	10"		-		63.4		70.7		75.1		-		-
300	12"		-		68.4		85.8		100		-		-
350	14"		77.4		88.4		103		137		99.4		99.4
375	15"		-		-		-		-		105		-
400	16"		89.4		104		124		168		120		120
450	18"		99.4		112		139		191		133		143
500	20"		114		132		174		228		182		182
600	24"		155		162		303		302		260		260
700	28"		190		240		288		266		367		346
750	30"		-		-		-		318		445		433
800	32"		240		315		364		383		503		493
900	36"		308		393		456		470		702		690
1000	40"		359		468		579		587		759		761
1050	42"		-		-		-		670		-		-
1200	48"		529		717		866		901		-		1237
-	54"		-		-		-		1273		-		-
1400	-		784		1114		1274		-		-		-
-	60"		-		-		-		1594		-		-
1600	-		1058		1624		1872		-		-		-
1650	66"		-		-		-		2131		-		-
1800	72"		1418		2107		2409		2568		-		-
2000	78"		1877		2630		2997		3113		-		-
-	84"		-		-		-		3755		-		-
2200	-		2512		3422		-		-		-		-
-	90"		-		-		-		4797		-		-
2400	-	PN 6	2996	PN 10	4094	PN 16	-		-	PN 16	-	Tabelle E	-

Transmitter Promag (compact version): 3.1 kg  
(Weight data valid without packaging material)

1) Lap joint flanges / welded flanges DN > 300 (12")

Weight data in kg													
Nominal diameter		Remote version (sensor plus sensor housing without cable) <sup>1)</sup>											
[mm]	[inch]	EN (DIN)						ASME/AWWA		AS			
25	1"		-		-		5.3		5.9		-		-
32	1 ¼"		-		-		6.0		-		-		-
40	1 ½"		-		-		7.0		5.5		-		-
50	2"		-		-		7.4		5.6		-		-
65	2 ½"		-		-		8.4		-		-		-
80	3"		-		-		10.4		10.8		-		-
100	4"		-		-		12.4		14.1		-		-
125	5"		-		-		13.9		-		-		-
150	6"		-		-		21.9		22.4		-		-
200	8"		-		41.4		42.9		47.6		-		-
250	10"		-		61.4		68.7		73.1		-		-
300	12"		-		66.4		83.8		98		-		-
350	14"		75.4		86.4		103		135		97.4		97.4
375	15"		-		102		-		-		103		-
400	16"		87.4		102		124		166		118		118
450	18"		97.4		110		139		189		131		141
500	20"		112		130		174		226		180		180
600	24"		153		160		303		300		258		258
700	28"		188		238		288		264		365		344
750	30"		-		-		-		316		443		431
800	32"		238		313		364		381		501		491
900	36"		306		391		456		468		700		688
1000	40"		357		466		579		585		757		759
1050	42"		-		-		-		668		-		-
1200	48"		527		715		866		899		-		1235
-	54"		-		-		-		1271		-		-
1400	-		782		1112		1274		-		-		-
-	60"		-		-		-		1592		-		-
1600	-		1056		1622		1872		-		-		-
1650	66"		-		-		-		2129		-		-
1800	72"		1416		2105		2409		2566		-		-
2000	78"		1875		2628		2997		3111		-		-
-	84"		-		-		-		3753		-		-
2200	-		2510		3420		-		-		-		-
-	90"		-		-		-		4795		-		-
2400	-	PN 6	2994	PN 10	4092	PN 16	-		-	PN 16	-	Tabelle E	-
Transmitter Promag (remote version): 3.4 kg (Weight data valid without packaging material)													

1) Lap joint flanges / welded flanges DN > 300 (12")

Weight data in kg		Nominal diameter		Compact version <sup>1)</sup>		Remote version (without cable) <sup>1)</sup>		
[mm]	[inch]	EN (DIN)		Sensor EN (DIN)		Transmitter		
25	1"	PN 10	5.8	PN 10	3.8	4.2		
32	1 ¼"		5.4		3.4	4.2		
40	1 ½"		6.3		4.7	4.2		
50	2"		5.4		3.4	4.2		
65	2 ½"		6.2		4.2	4.2		
80	3"		7.2		5.2	4.2		
100	4"		9.7		7.7	4.2		
125	5"		13.2		11.2	4.2		
150	6"		17.2		15.2	4.2		
200	8"		35.7		33.7	4.2		
250	10"		54.2		52.2	4.2		
300	12"		55.2		53.2	4.2		

Transmitter Promag (compact version): 1.8 kg  
(Weight data valid for standard pressure ratings and without packaging material)

1) Lap joint flanges, stamped plate

**Promag P**

Weight data in kg		Nominal diameter		Compact version				Remote version (without cable)						
[mm]	[inch]	EN (DIN) / AS*		JIS		ASME / AWWA		Sensor EN (DIN) / AS*		Sensor		Transmitter		
									JIS	ASME / AWWA				
25	1"	PN 40	5.7	10K	5.7	Class 150	5.7	PN 40	5.3	10K	5.3	Class 150	3.1	
32	1 ¼"		6.4		5.7		-		6.0		5.3		-	3.1
40	1 ½"		7.8		6.7		7.8		7.4		6.3		7.4	3.1
50	2"		9.0		7.7		9.0		8.6		7.3		8.6	3.1
65	2 ½"	PN 16	10.4	10K	9.5	Class 150	-	PN 16	10.0	10K	9.1	Class 150	3.1	
80	3"		12.4		10.9		12.4		12.0		10.5		12.0	3.1
100	4"		14.4		13.1		14.4		14.0		12.7		14.0	3.1
125	5"		19.9		19.4		-		19.5		19.0		-	3.1
150	6"	PN 10	23.9	10K	22.9	Class 150	23.9	PN 10	23.5	10K	22.5	Class 150	3.1	
200	8"		43.4		40.3		43.4		43		39.9		43	3.1
250	10"		63.4		67.8		73.4		63		67.4		73	3.1
300	12"		68.4		70.7		108.4		68		70.3		108	3.1
350	14"	PN 10	113.4	10K	-	Class 150	172.4	PN 10	113	10K	-	Class 150	3.1	
400	16"		133.4		-		203.4		133		-		203	3.1
450	18"		173.4		-		253.4		173		-		253	3.1
500	20"		173.4		-		283.4		173		-		283	3.1
600	24"	233.4	-	403.4	233	-	403	3.1						

Transmitter Promag (compact version): 1.8 kg  
(Weight data valid for standard pressure ratings and without packaging material)  
\* Flanges according to AS are only available for DN 25 and 50.

**Promag W**

*Standard version*

Weight data in kg												
Diameter		Compact version				Remote version (without cable)				Transmitter Wall housing		
[mm]	[inch]	EN (DIN) / AS <sup>1)</sup>	JIS	ANSI / AWWA	EN (DIN) / AS <sup>1)</sup>	Sensor		ANSI / AWWA				
						JIS						
25	1"	PN 40	5.7	5.7	5.7	PN 40	5.3	5.3	5.3	3.1		
32	-		6.4	5.7	-		6.0	5.3	-			
40	1½"		7.8	6.7	7.8		7.4	6.3	7.4			
50	2"		9.0	7.7	9.0		8.6	7.3	8.6			
65	-	PN 16	10.4	9.5	-	PN 16	10.0	9.1	-			
80	3"		12.4	10.9	12.4		12.0	10.5	12.0			
100	4"		14.4	13.1	14.4		14.0	12.7	14.0			
125	-		19.9	19.4	-		19.5	19.0	-			
150	6"	PN 10	23.9	22.9	Class 150	PN 10	23.5	22.5	Class 150			
200	8"		43.4	40.3			43.3	43			39.9	43
250	10"		63.4	67.8			73.4	63			67.4	73
300	12"		68.4	70.7			108.4	68			70.3	108
350	14"	PN 10	105	-	Class 150	PN 10	103	-	Class 150			
375	15"		120	-			118	-				
400	16"		120	205			118	203				
450	18"		161	255			159	253				
500	20"	PN 6	156	285	Class 150	PN 6	154	283	Class 150			
600	24"		208	405			206	403				
700	28"		304	400			302	398				
-	30"		-	460			-	458				
800	32"	PN 6	357	550	Class D	PN 6	355	548	Class D			
900	36"		485	800			483	798				
1000	40"		589	900			587	898				
-	42"		-	1100			-	1098				
1200	48"	PN 6	850	1400	Class D	PN 6	848	1398	Class D			
-	54"		-	2200			-	2198				
1400	-		1300	-			1298	-				
-	60"		-	2700			-	2698				
1600	-	PN 6	1700	-	Class D	PN 6	1698	-	Class D			
-	66"		-	3700			-	3698				
1800	72"		2200	4100			2198	4098				
-	78"		-	4600			-	4598				
2000	-	PN 6	2800	-	2798	-	-	-	-			

<sup>1)</sup> For flanges to AS, only DN 80, 100, 150 to 400, 500 and 600 are available.

- Transmitter (compact version): 1.8 kg
- Weight data valid for standard pressure ratings and without packaging material

Optional version w/o inlet and outlet runs

Weight data in kg											
Diameter		Compact version					Remote version (without cable)				
[mm]	[inch]	EN (DIN) / AS <sup>1)</sup>		JIS	ANSI / AWWA	EN (DIN) / AS <sup>1)</sup>		Sensor		ANSI / AWWA	Transmitter Wall housing
50	2"	PN 40	9.6	8.3	9.6	PN 40	9.2	7.9	9.2	6.8	
65	-		11.4				10.5				-
80	3"	PN 16	13.8	12.3	Class 150	13.8	13.4	11.9	13.4		
100	4"		15.4			14.9	16.5	15.0	14.5		16.1
125	-	PN 16	23.9	23.8	Class 150	-	23.5	23.4	-		
150	6"		29.2			29.9	30.9	28.8	29.5		30.5
200	8"	PN 10	51.7	49.5	Class 150	51.3	49.1	52.6	52.6		
250	10"		80.5			82.7	90.6	80.1	82.3		90.2
300	12"	PN 10	94.1	88.9	Class 150	129.8	93.7	88.5	129.4		

<sup>1)</sup> For flanges to AS, only DN 80, 100, 150 to 400, 500 and 600 are available.

- Transmitter (compact version): 1.8 kg
- Weight data valid for standard pressure ratings and without packaging material

## Weight (US units)

## Promag D

Weight data in lbs				
Nominal diameter		Compact version	Remote version (without cable)	
[mm]	[inch]		Sensor	Transformer
25	1"	6	6	7
40	1 ½"	8	7	7
50	2"	9	9	7
80	3"	13	13	7
100	4"	19	19	7

Transmitter Promag (compact version): 3.9 lbs (Weight data valid without packaging material)

## Promag E

Weight data in lbs				
Nominal diameter		Compact version ASME Class 150	Remote version (without cable)	
[mm]	[inch]		Sensor ASME Class 150	Transmitter Wall-mount housing
15	½"	14.3	9.92	13.2
25	1"	16.1	11.7	
40	1½"	20.7	16.3	
50	2"	23.4	19.0	
80	3"	30.9	26.5	
100	4"	35.3	30.9	
150	6"	56.2	51.8	
200	8"	99.2	94.8	
250	10"	165.4	161.0	
300	12"	242.6	238.1	
350	14"	303.0	293.5	
400	16"	371.3	361.8	
450	18"	422.0	412.6	
500	20"	503.6	494.1	
600	24"	666.8	657.3	

- Transmitter: 4.0 lbs (compact version); 6.8 lbs (remote version)
- Weight data without packaging material

## Promag H

Weight data in lbs				
Nominal diameter		Compact version	Remote version (without cable)	
[mm]	[inch]		Sensor	Transformer
2	¼"	8	4	7
4	⅜"	8	4	7
8	⅝"	8	4	7
15	½"	8	4	7
25	1"	9	6	7
40	1 ½"	11	10	7
50	2"	16	15	7
65	2 ½"	17	17	7
80	3"	38	37	7
100	4"	37	36	7

Transmitter Promag (compact version): 3.9 lbs  
(Weight data valid for standard pressure ratings and without packaging material)

**Promag L (ASME/AWWA)**

Weight data in lbs		Compact version <sup>1)</sup>		Remote version <sup>1)</sup>	
Nominal diameter		ASME/AWWA		ASME/AWWA	
[mm]	[inch]				
25	1"	ASME / Class 150	17.4	ASME / Class 150	13
32	1 ¼"		-		-
40	1 ½"		16.5		12.1
50	2"		16.8		12.3
65	2 ½"		-		-
80	3"		28.2		23.8
100	4"		35.5		31.1
125	5"		-		-
150	6"		53.8		49.4
200	8"		109		105
250	10"		166		161
300	12"		221		216
350	14"		302		298
375	15"		-		-
400	16"		370		366
450	18"		421		417
500	20"		503		498
600	24"	666	662		
700	28"	AWWA / Class D	587	AWWA / Class D	582
750	30"		701		697
800	32"		845		840
900	36"		1036		1032
1000	40"		1294		1290
1050	42"		1477		1473
1200	48"		1987		1982
-	54"		2807		2803
1400	-		-		-
-	60"		3515		3510
1600	-		-		-
1650	66"		4699		4694
1800	72"		5662		5658
2000	78"		6864		6860
-	84"		8280		8275
2200	-		-		-
-	90"		10577		10573
2400	-	-	-		

Transmitter Promag (compact version): 4.0 lbs  
 Transmitter Promag (remote version): 6.8 lbs  
 (Weight data valid without packaging material)

1) Lap joint flanges / welded flanges DN > 300 (12")



## Promag P (ASME/AWWA)

Weight data in lbs						
Nominal diameter		Compact version	Remote version (without cable)			
[mm]	[inch]		Sensor	Transformer		
25	1"	Class 150	13	Class 150	12	7
40	1 ½"		17		16	7
50	2"		20		19	7
80	3"		27		26	7
100	4"		32		31	7
150	6"		53		52	7
200	8"		96		95	7
250	10"		162		161	7
300	12"		239		238	7
350	14"		380		381	7
400	16"		448		448	7
450	18"		559		558	7
500	20"		625		624	7
600	24"		889		889	7

Transmitter Promag (compact version): 3.9 lbs  
 (Weight data valid for standard pressure ratings and without packaging material)

**Promag W (ASME/AWWA)**

*Standard version*

Weight data in lbs		Compact version		Remote version (without cable)	
Diameter		ANSI /AWWA		Sensor	Transmitter
[mm]	[inch]			ANSI / AWWA	Wall housing
25	1"	Class 150	12.6	Class 150	11.7
40	1½"		17.2		16.3
50	2"		19.9		19.0
80	3"		27.3		26.5
100	4"		31.8		30.9
150	6"		52.7		51.8
200	8"		95.5		94.8
250	10"		162.1		161.0
300	12"		239.0		238.1
350	14"		380.1		381.5
400	16"		448.5		447.6
450	18"		558.8		557.9
500	20"		624.9		624.0
600	24"		889.5		888.6
700	28"		Class D		878.5
-	30"	1010.8		1009.9	
800	32"	1209.2		1208.3	
900	36"	1760.5		1759.6	
1000	40"	1981.0		1980.1	
-	42"	2422.0		2421.1	
1200	48"	3083.5		3082.6	
-	54"	4847.5		4846.6	
-	60"	5950.0		5949.1	
-	66"	8155.0		8154.1	
1800	72"	9037.0	9036.1		
-	78"	10139.0	10139.0		

6.8

- Transmitter (compact version): 4.0 lbs
- Weight data valid for standard pressure ratings and without packaging material

*Optional version w/o inlet and outlet runs*

Weight data in lbs		Compact version		Remote version (without cable)	
Diameter		ANSI /AWWA		Sensor	Transmitter
[mm]	[inch]			ANSI / AWWA	Wall housing
50	2"	Class 150	21.2	Class 150	20.3
80	3"		30.4		29.6
100	4"		36.4		35.5
150	6"		68.1		67.2
200	8"		116.7		116.0
250	10"		200.0		198.9
300	12"	286.2	285.3		

6.8

- Transmitter (compact version): 4.0 lbs
- Weight data valid for standard pressure ratings and without packaging material

**Material****Promag D**

- Transmitter housing: powder-coated die-cast aluminum
- Sensor housing: powder-coated die-cast aluminum
- Measuring tube: polyamide, O-rings EPDM  
(Drinking water approvals: WRAS BS 6920, ACS, NSF 61, KTW/W270)
- Electrodes: 1.4435 (316L)
- Ground disks Promag D as wafer version: 1.4301 (304)
- Ground disks Promag D with threaded connection: 1.4301 (304)

**Promag E**

- Transmitter housing: powder-coated die-cast aluminum
- Sensor housing
  - DN 15 to 300 (½ to 12"): powder-coated die-cast aluminum
  - DN 350 to 600 (14 to 24"): with protective lacquering
- Measuring tube
  - DN ≤ 300 (12"): stainless steel 1.4301 (304) or 1.4306 (304L) (with Al/Zn protective coating)
  - DN ≥ 350 (14"): stainless steel 1.4301 (304) or 1.4306 (304L) (with protective lacquering)
- Electrodes: 1.4435 (316L), Alloy C22
- Flanges (with protective lacquering)
  - EN 1092-1 (DIN2501): RSt37-2 (S235JRG2); Alloy C22; Fe 410W B
  - ASME: A105
  - JIS: RSt37-2 (S235JRG2); HII
- Seals: to DIN EN 1514-1
- Ground disks: 1.4435 (316L) or Alloy C22

**Promag H**

- Transmitter housing: powder-coated die-cast aluminum
- Window material: glass or polycarbonate
- Sensor housing: stainless steel 1.4301 (304)
- Wall mounting kit: stainless steel 1.4301 (304)
- Measuring tube: stainless steel 1.4301 (304)
- Liner: PFA (USP Class VI, FDA 21 CFR 177.1550, 3A)
- Electrodes: 11.4435 (316L) (optional: Alloy C22)
- Flanges: connections generally made of 1.4404 (316L)
- Seals
  - DN 2 to 25: O-ring (EPDM, Viton, Kalrez), gasket seal (EPDM\*, Viton, Silicone\*)
  - DN 40 to 100: gasket seal (EPDM\*, Silicone\*)
  - \* = USP Class VI, FDA 21 CFR 177.2600, 3A
- Ground rings: 1.4435 (316L) (optional: Alloy C22)

**Promag L**

- Transmitter housing:
  - Compact housing: powder-coated die-cast aluminum
  - Wall-mounted housing: powder-coated die-cast aluminum
- Sensor housing
  - DN 25 to 300 (1 to 12"): powder-coated die-cast aluminum
  - DN 350 to 1200 (14 to 48"): with protective lacquering
- Measuring tube:
  - DN £ 300 (12"); stainless steel 1.4301 (304) or 1.4306 (304L)
  - DN <sup>3</sup> 350 (14"); stainless steel 202 or 304
- Electrodes: 1.4435 (316L), Alloy C22
- Flange
  - EN 1092-1 (DIN 2501): DN ≤ 300: 1.4306 (304L); 1.4307; 1.4301 (304); 1.0038 (S235JRG2)
  - EN 1092-1 (DIN 2501): DN ≥ 350: A105; 1.0038 (S235JRG2)
  - AWWA: A181/A105; 1.0425 (316L) (P265GH); 1.0044 (S275JR)
  - AS 2129: A105; 1.0345 (P235GH); 1.0425 (316L) (P265GH); 1.0038 (S235JRG2); FE 410 WB
  - AS 4087: A105; 1.0425 (316L) (P265GH); 1.0044 (S275JR)
- Seals: to DIN EN 1514-1
- Ground disks: 1.4435 (316L) or Alloy C22

**Promag P/W**

- Transmitter housing: powder-coated die-cast aluminum
- Sensor housing
  - DN 25 to 300: powder-coated die-cast aluminum
  - DN 350 to 2000: with protective lacquering
- Measuring tube
  - DN ≤ 300: stainless steel 1.4301 (304) or 1.4306 (304L)  
(Flange material: carbon steel with Al/Zn protective coating)
  - DN ≥ 350: stainless steel 1.4301 (304) or 1.4306 (304L)  
(Flange material: carbon steel with protective lacquering)
- Electrodes: 1.4435 (316L), Alloy C22
- Flange
  - EN 1092-1 (DIN2501): RSt37-2 (S235JRG2); Alloy C22; FE 410 WB  
(DN ≤ 300: with Al/Zn protective coating; DN ≥ 350 with protective lacquering)
  - ASME: A105  
(DN ≤ 300 with Al/Zn protective coating; DN ≥ 350 with protective lacquering)
  - AWWA (only Promag W): 1.0425 (with protective lacquering)
  - JIS: RSt37-2 (S235JRG2); HII; 1.0425  
(DN ≤ 300 with Al/Zn protective coating; DN ≥ 350 with protective lacquering)
  - AS 2129
    - (DN 25, 80, 100, 150 to 1200) A105 or RSt37-2 (S235JRG2)
    - (DN 50, 80, 350, 400, 500) A105 or St44-2 (S275JR)  
(DN ≤ 300 with Al/Zn protective coating; DN ≥ 350 with protective lacquering)
  - AS 4087: A105 or St44-2 (S275JR)  
(DN ≤ 300 with Al/Zn protective coating; DN ≥ 350 with protective lacquering)
- Seals: to DIN EN 1514-1
- Ground disks: 1.4435 (316L) or Alloy C22

**Fitted electrodes****Promag D**

- 2 measuring electrodes for signal detection

**Promag E/L/P/W**

- 2 measuring electrodes for signal detection
- 1 EPD electrode for empty pipe detection
- 1 reference electrode for potential equalization

**Promag H**

- 2 measuring electrodes for signal detection
- 1 EPD electrode for empty pipe detection, not for DN 2 to 8 ( $\frac{1}{12}$  to  $\frac{1}{2}$ " )

**Process connections****Promag D as wafer version**

The wafer version is compatible with the following process connections:

- EN 1092-1 (DIN 2501)
- ASME B16.5
- JIS B2220

**Promag D with threaded connection**

- DIN ISO 228, G" external thread
- ANSI/ASME B1.20, NPT" external thread

**Promag E**

Flange connection:

- EN 1092-1 (DIN 2501), DN  $\leq$  300 (12") form A, DN  $\geq$  350 (14") form B  
(Dimensions to DIN 2501, DN 65 PN 16 and DN 600 (24") PN 16 exclusively to EN 1092-1)
- ASME B16.5
- JIS B2220

**Promag H**

With O-ring:

- Flange EN (DIN), ASME, JIS
- External thread

With gasket seal:

- Weld nipple EN 10357 (DIN 11850), ODT/SMS
- TriClamp L14 AM7
- Threaded joint DIN 11851, DIN 11864-1, SMS 1145
- Flange DIN 11864-2

**Promag L**

Flange connection:

- EN 1092-1 (DIN 2501)
  - DN  $\leq$  300 (12") = form A
  - DN  $\geq$  350 (14") = form B
- ASME B16.5
- AWWA C207
- AS

**Promag P/W**

Flange connections:

- EN 1092-1 (DIN 2501)
  - DN ≤ 300 = form A
  - DN ≥ 350 = flat face
  - DN 65 PN 16 and DN 600 PN 16 only as per EN 1092-1
- ASME
- AWWA (only Promag W)
- JIS
- AS

**Surface roughness**

All data relate to parts in contact with fluid.

- Electrodes stainless steel 1.4435 (316L), Alloy C22, 2.4602 (UNS N06022): 0.3 to 0.5 μm (11.8 to 19.7 μin)
- Liner with PFA: ≤ 0.4 μm (15.7 μin)
- Process connection made of stainless-steel (Promag H):
  - with O-ring seal: ≤ 1.6 μm (63 μin)
  - with aseptic gasket seal: ≤ 0.8 μm (31.5 μin)
  - optional: ≤ 0.38 μm (15 μin)

## 10.11 Operability

**Local display**

**Display elements**

- Liquid crystal display: unilluminated, two-line, 16 characters per line
- Display (operating mode) preconfigured: volume flow and totalizer status
- 1 totalizer



Note!

At ambient temperatures below -20 (-4 °F) the readability of the display may be impaired.

**Operating elements**

Local operation with three keys (◻ ⊕ ◻)

**Remote operation**

Operation via HART protocol and FieldCare

## 10.12 Certificates and approvals

**CE mark**

The measuring system is in conformity with the statutory requirements of the EC Directives. Endress+Hauser confirms successful testing of the device by affixing to it the CE mark.

**C-tick mark**

The measuring system meets the EMC requirements of the Australian Communications and Media Authority (ACMA)

**Ex approval**

Information about currently available Ex versions (ATEX, FM, CSA, IECEx, NEPSI etc.) can be supplied by your Endress+Hauser Sales Center on request. All explosion protection data are given in a separate documentation which is available upon request.

<b>Sanitary compatibility</b>	<b>Promag D/E/L/P/W</b>
	No applicable approvals or certification
	<b>Promag H</b>
	<ul style="list-style-type: none"> <li>■ 3A authorization and EHEDG-certified</li> <li>■ Seals: in conformity with FDA (except Kalrez seals)</li> </ul>
<b>Drinking water approval</b>	<b>Promag D/L/W</b>
	<ul style="list-style-type: none"> <li>■ WRAS BS 6920</li> <li>■ ACS</li> <li>■ NSF 61</li> <li>■ KTW/W270</li> </ul>
	<b>Promag E/H/P</b>
	No drinking water approval
<b>Pressure Equipment Directive</b>	<b>Promag D/L</b>
	No pressure measuring device approval
	<b>Promag E/H/P/W</b>
	The devices can be ordered with or without a PED approval. If a device with a PED approval is required, this must be explicitly stated in the order. For devices with nominal diameters less than or equal to DN 25 (1"), this is neither possible nor necessary.
	<ul style="list-style-type: none"> <li>■ With the PED/G1/x (x = category) marking on the sensor nameplate, Endress+Hauser confirms compliance with the "Essential Safety Requirements" specified in Annex I of the Pressure Equipment Directive 97/23/EC.</li> <li>■ Devices bearing this marking (PED) are suitable for the following types of medium: Media in Group 1 and 2 with a vapor pressure greater than, or smaller and equal to 0.5 bar (7.3 psi)</li> <li>■ Devices not bearing this marking (PED) are designed and manufactured according to good engineering practice. They meet the requirements of Art.3 Section 3 of the Pressure Equipment Directive 97/23/EC. The range of application is indicated in tables 6 to 9 in Annex II of the Pressure Equipment Directive.</li> </ul>
<b>Other standards and guidelines</b>	<ul style="list-style-type: none"> <li>■ EN 60529: Degrees of protection by housing (IP code).</li> <li>■ EN 61010-1 Safety requirements for electrical equipment for measurement, control and laboratory use</li> <li>■ IEC/EN 61326 Electromagnetic compatibility (EMC requirements)</li> <li>■ ASME/ISA-S82.01 Safety Standard for Electrical and Electronic Test, Measuring, Controlling and related Equipment - General Requirements. Pollution degree 2, Installation Category II.</li> <li>■ CAN/CSA-C22.2 (No. 1010.1-92) Safety requirements for Electrical Equipment for Measurement and Control and Laboratory Use. Pollution degree 2, Installation Category I.</li> </ul>

## 10.13 Ordering information

Detailed ordering information is available from the following sources:

- In the Product Configurator on the Endress+Hauser website: [www.endress.com](http://www.endress.com) → Select country → Instruments → Select device → Product page function: Configure this product
- From your Endress+Hauser Sales Center: [www.endress.com/worldwide](http://www.endress.com/worldwide)



Note!

### **Product Configurator - the tool for individual product configuration**

- Up-to-the-minute configuration data
- Depending on the device: Direct input of measuring point-specific information such as measuring range or operating language
- Automatic verification of exclusion criteria
- Automatic creation of the order code and its breakdown in PDF or Excel output format
- Ability to order directly in the Endress+Hauser Online Shop

## 10.14 Accessories

Various accessories, which can be ordered separately from Endress+Hauser, are available for the transmitter and the sensor →  70.

Your Endress+Hauser service organization can provide detailed information on the specific order codes on request.

## 10.15 Documentation

- Flow measuring technology (FA00005D/06)
- Technical Information Promag 10D (TI00081D/06)
- Technical Information Promag 10E (TI01160D/06)
- Technical Information Promag 10H (TI00095D/06)
- Technical Information Promag 10L (TI00100D/06)
- Technical Information Promag 10P (TI00094D/06)
- Technical Information Promag 10W (TI00093D/06)



# 11 Appendix

## 11.1 Illustration of the function matrix





Function groups	Functions			
SYSTEM UNITS (→ 114)	UNIT. VOL. FLOW (→ 114)	UNIT VOLUME (→ 114)	FORMAT DATE/TIME (→ 115)	
OPERATION (→ 116)	LANGUAGE (→ 116)	ACCESS CODE (→ 116)	DEFINE PRIVATE CODE (→ 116)	
USER INTERFACE (→ 117)	FORMAT (→ 117)	CONTRAST LCD (→ 117)	TEST DISPLAY (→ 117)	
TOTALIZER (→ 118)	SUM (→ 118)	OVERFLOW (→ 118)	RESET TOTALIZ. (→ 118)	
CURRENT OUTPUT (→ 119)	CURRENT RANGE (→ 119)	VALUE 20 mA (→ 120)	TIME CONSTANT (→ 120)	
PULSE/STATUS OUTP. (→ 121)	OPERATING MODE (→ 121)	PULSE VALUE (→ 121)	PULSE WIDTH (→ 121)	OUTPUT SIGNAL (→ 122)
	ASSIGN STATUS (→ 122)	SWITCH-ON POINT (→ 122)	SWITCH-OFF POINT (→ 123)	
COMMUNICATION (→ 126)	TAG NAME (→ 126)	TAG DESCR. (→ 126)	BUS ADDRESS (→ 126)	HART WRITE PROT. (→ 126) MANUFACTURER ID (→ 126) DEVICE ID (→ 126)
PROCESS PARAM. (→ 127)	LOW FLOW CUT OFF (→ 127)	EPD (→ 127)	EPD ADJ. (→ 128)	
SYSTEM PARAM. (→ 129)	INSTALLATION DIRECTION (→ 129)	MEASURING MODE (→ 129)	POS. ZERO-RET. (→ 130)	SYSTEM DAMP. (→ 131)
SENSOR DATA (→ 132)	CALIBRATION DATE (→ 132)	SENSITIVITY (→ 132)	K-FACTOR (→ 132)	ZERO POINT (→ 132) MEASURING PERIOD(→ 133) EPD ELECTRODE (→ 133)
SUPERVISION (→ 134)	FAILSAFE MODE (→ 134)	ALARM DELAY (→ 135)	SYSTEM RESET (→ 135)	SELF CHECKING (→ 135)
SIMULAT. SYSTEM (→ 136)	SIM. FAILSAFE (→ 135)	SIM. MEASURAND (→ 135)	VALUE SIM. MEASUR. (→ 136)	
SENSOR VERSION (→ 136)	SERIAL NUMBER (→ 136)	SENSOR TYPE (→ 136)		
AMPLIFIER VERS. (→ 136)	SW REV. (→ 136)			

## 11.2 Group SYSTEM UNITS

Functional description SYSTEM UNITS	
<b>Use this function group to select the unit required and displayed for the measured variable.</b>	
<b>UNIT VOLUME FLOW</b>	<p>Use this function to select the unit required and displayed for the volume flow.</p> <p>The unit you select here is also valid for:</p> <ul style="list-style-type: none"> <li>■ Volume flow display</li> <li>■ Current output</li> <li>■ Switch points (limit value for volume flow, flow direction)</li> <li>■ Low flow cut off</li> </ul> <p><b>Options:</b></p> <p><i>Metric:</i>  Cubic centimeter → cm<sup>3</sup>/s; cm<sup>3</sup>/min; cm<sup>3</sup>/h; cm<sup>3</sup>/day  Cubic decimeter → dm<sup>3</sup>/s; dm<sup>3</sup>/min; dm<sup>3</sup>/h; dm<sup>3</sup>/day  Cubic meter → m<sup>3</sup>/s; m<sup>3</sup>/min; m<sup>3</sup>/h; m<sup>3</sup>/day  Milliliter → ml/s; ml/min; ml/h; ml/day  Liter → l/s; l/min; l/h; l/day  Hectoliter → hl/s; hl/min; hl/h; hl/day  Megalith → Ml/s; Ml/min; Ml/h; Ml/day</p> <p><i>US:</i>  Cubic centimeter → cc/s; cc/min; cc/h; cc/day  Acre foot → af/s; af/min; af/h; af/day  Cubic foot → ft<sup>3</sup>/s; ft<sup>3</sup>/min; ft<sup>3</sup>/h; ft<sup>3</sup>/day  Fluid ounce → oz f/s; oz f/min; oz f/h; oz f/day  Gallon → gal/s; gal/min; gal/h; gal/day  Kilo gallons → kgal/s; kgal/min; kgal/h; kgal/day  Million gallons → Mgal/s; Mgal/min; Mgal/h; Mgal/day  Barrel (normal fluids: 31.5 gal/bbl) → bbl/s; bbl/min; bbl/h; bbl/day  Barrel (beer: 31.0 gal/bbl) → bbl/s; bbl/min; bbl/h; bbl/day  Barrel (petrochemicals: 42.0 gal/bbl) → bbl/s; bbl/min; bbl/h; bbl/day  Barrel (filling tanks: 55.0 gal/bbl) → bbl/s; bbl/min; bbl/h; bbl/day</p> <p><i>Imperial:</i>  Gallon → gal/s; gal/min; gal/h; gal/day  Mega gallon → Mgal/s; Mgal/min; Mgal/h; Mgal/day  Barrel (beer: 36.0 gal/bbl) → bbl/s; bbl/min; bbl/h; bbl/day  Barrel (petrochemicals: 34.97 gal/bbl) → bbl/s; bbl/min; bbl/h; bbl/day</p> <p><b>Factory setting:</b>  Depends on nominal diameter and country  (dm<sup>3</sup>/min to m<sup>3</sup>/h or US-gal/min),  corresponding to the full scale value unit factory setting → 137</p>
<b>UNIT VOLUME</b>	<p>Use this function to select the unit required and displayed for the volume.</p> <p>The unit you select here is also valid for:</p> <ul style="list-style-type: none"> <li>■ Totalizer status display</li> <li>■ Totalizer unit</li> <li>■ Pulse value (e.g. m<sup>3</sup>/p)</li> </ul> <p><b>Options:</b></p> <p><i>Metric</i> → cm<sup>3</sup>; dm<sup>3</sup>; m<sup>3</sup>; ml; l; hl; Ml  <i>US</i> → cc; af; ft<sup>3</sup>; oz f; gal; Mgal; bbl (normal fluids); bbl (beer); bbl (petrochemicals);  bbl (filling tanks)  <i>Imperial</i> → gal; Mgal; bbl (beer); bbl (petrochemicals)</p> <p><b>Factory setting:</b>  Depends on nominal diameter and country (dm<sup>3</sup> to m<sup>3</sup> or US-gal  corresponding to the totalizer unit factory setting. → 137</p>

<b>Functional description SYSTEM UNITS</b>	
<b>FORMAT DATE/TIME</b>	<p>Use this function to select the format for the date and the time.</p> <p>The unit you select here is also valid for displaying the current calibration date (function CALIBRATION DATE on →  132)</p> <p><b>Options:</b> DD.MM.YY 24H MM/DD/YY 12H A/P DD.MM.YY 12H A/P MM/DD/YY 24H</p> <p><b>Factory setting:</b> DD.MM.YY 24H (SI units) MM/DD/YY 12H A/P (US units)</p>





## 11.3 Group OPERATION

Functional description OPERATION	
<b>LANGUAGE</b>	<p>Use this function to select the language for all texts, parameters and messages shown on the local display.</p> <p><b>Options:</b>            ENGLISH            DEUTSCH            FRANCAIS            ESPANOL            ITALIANO</p> <p><b>Factory setting:</b>            Depends on country, see factory setting → 137</p> <p> <b>Note!</b>            If you press the  keys simultaneously at startup, the language defaults to "ENGLISH".</p>
<b>ACCESS CODE</b>	<p>All data of the measuring system are protected against inadvertent change. Programming is disabled and the settings cannot be changed until a code is entered in this function. If you press the  keys in any function, the measuring system automatically goes to this function and the prompt to enter the code appears on the display (when programming is disabled).</p> <p>You can activate programming by entering your private code (<b>factory setting = 10</b>, see also the subsequent DEFINE PRIVATE CODE function)</p> <p><b>User input:</b>            Max. 4-digit number: 0 to 9999</p> <p> <b>Note!</b></p> <ul style="list-style-type: none"> <li>▪ The programming levels are disabled if you do not press the operating elements within 60 seconds following automatic return to the HOME position.</li> <li>▪ You can also disable programming in this function by entering any number (other than the defined private code).</li> <li>▪ The Endress+Hauser service organization can be of assistance if you mislay your personal code.</li> </ul>
<b>DEFINE PRIVATE CODE</b>	<p>Use this function to enter a personal code to enable programming.</p> <p><b>User input:</b>            0 to 9999 (max. 4-digit number)</p> <p><b>Factory setting:</b>            10</p> <p> <b>Note!</b></p> <ul style="list-style-type: none"> <li>▪ This function only appears if the private code was entered in the ACCESS CODE function.</li> <li>▪ Programming is always enabled with the code "0".</li> <li>▪ Programming has to be enabled before this code can be changed.              When programming is disabled this function is not available, thus preventing others from accessing your personal code.</li> </ul>

## 11.4 USER INTERFACE

Functional description USER INTERFACE	
<b>FORMAT</b>	<p>Use this function to define the maximum number of places after the decimal point displayed for the reading in the main line.</p> <p><b>Options:</b> XXXXX. XXXX.X XXX.XX XX.XXX X.XXXX</p> <p><b>Factory setting:</b> X.XXXX</p> <p> <b>Note!</b></p> <ul style="list-style-type: none"> <li>▪ Note that this setting only affects the reading as it appears on the display, it has no influence on the accuracy of the system's calculations.</li> <li>▪ The places after the decimal point as computed by the measuring device cannot always be displayed, depending on this setting and the engineering unit. In such instances an arrow appears on the display between the measuring value and the engineering unit (e.g. 1.2 → l/h), indicating that the measuring system is computing with more decimal places than can be shown on the display.</li> </ul>
<b>CONTRAST LCD</b>	<p>Use this function to optimize display contrast to suit local operating conditions.</p> <p><b>User input:</b> 10 to 100%</p> <p><b>Factory setting:</b> 50%</p>
<b>TEST DISPLAY</b>	<p>Use this function to test the operability of the local display and its pixels.</p> <p><b>Options:</b> OFF ON</p> <p><b>Factory setting:</b> OFF</p> <p><b>Test sequence:</b></p> <ol style="list-style-type: none"> <li>1. Start the test by selecting ON.</li> <li>2. All pixels of the main line and additional line are darkened for minimum 0.75 seconds.</li> <li>3. The main line and additional line show an "8" in each field for minimum 0.75 seconds.</li> <li>4. The main line and additional line show a "0" in each field for minimum 0.75 seconds.</li> <li>5. The main line and additional line show nothing (blank display) for minimum 0.75 seconds.</li> </ol> <p>When the test completes the local display returns to its initial state and the setting changes to "OFF".</p>





## 11.5 Group TOTALIZER

Functional description TOTALIZER	
<b>SUM</b>	<p>The total for the totalizer's measured variable aggregated since measuring commenced appears on the display.</p> <p>This value can be positive or negative, depending on:</p> <ul style="list-style-type: none"> <li>■ Flow direction and/or</li> <li>■ Setting in the MEASURING MODE function →  129</li> </ul> <p><b>Display:</b> Max. 6-digit floating-point number, incl. sign and unit (e.g. 15467.4 m<sup>3</sup>)</p> <p> <b>Note!</b></p> <ul style="list-style-type: none"> <li>■ The totalizer's response to faults is defined in the central "FAILSAFE MODE" function →  134.</li> <li>■ The unit of the totalizer is defined in the UNIT VOLUME function →  114.</li> </ul>
<b>OVERFLOW</b>	<p>The total for the totalizer's overflow aggregated since measuring commenced appears on the display.</p> <p>Total flow quantity is represented by a floating-point number consisting of max. 7 digits. You can use this function to view higher numerical values (&gt;9,999,999) as overflows. The effective quantity is thus the total of the OVERFLOW function plus the value displayed in the SUM function.</p> <p><b>Example:</b> Reading for 2 overflows: 2 E7 dm<sup>3</sup> (= 20,000,000 dm<sup>3</sup>) The value displayed in the function "SUM" = 196,845 dm<sup>3</sup> Effective total quantity = 20,196,845 dm<sup>3</sup></p> <p><b>Display:</b> Integer with exponent, including sign and unit, e.g. 2 E7 dm<sup>3</sup></p>
<b>RESET TOTALIZER</b>	<p>Use this function to reset the sum and the overflow of the totalizer to "zero" (= RESET).</p> <p><b>Options:</b> NO YES</p> <p><b>Factory setting:</b> NO</p>

## 11.6 Group CURRENT OUTPUT





Functional description CURRENT OUTPUT																																	
<p> <b>Note!</b> The functions of the CURRENT OUTPUT group are only available if the "0" value was entered in the BUS ADDRESS function →  126.</p>																																	
<b>CURRENT RANGE</b>	<p>Use this function to specify the current range. You can configure the current output either in accordance with the NAMUR recommendation (max. 20.5 mA) or for a maximum drive of 25 mA.</p> <p><b>Options:</b>                      OFF                      4-20 mA (25 mA)                      4-20 mA (25 mA) HART                      4-20 mA NAMUR                      4-20 mA HART NAMUR                      4-20 mA US                      4-20 mA HART US</p> <p><b>Factory setting:</b>                      4-20 mA HART NAMUR</p> <p><b>Current range, work range and signal on alarm level</b></p> <div style="text-align: center;"> </div> <table border="1" style="margin: 10px auto; border-collapse: collapse; text-align: center;"> <thead> <tr> <th style="border: none;">A</th> <th style="border: none;">①</th> <th style="border: none;">②</th> <th style="border: none;">③</th> </tr> </thead> <tbody> <tr> <td style="border: none;">OFF</td> <td style="border: none;">4 mA</td> <td style="border: none;">-</td> <td style="border: none;">-</td> </tr> <tr> <td style="border: none;">4-20 mA (25 mA)</td> <td style="border: none;">4 - 24 mA</td> <td style="border: none;">2</td> <td style="border: none;">25</td> </tr> <tr> <td style="border: none;">4-20 mA (25 mA) HART</td> <td style="border: none;">4 - 24 mA</td> <td style="border: none;">2</td> <td style="border: none;">25</td> </tr> <tr> <td style="border: none;">4-20 mA NAMUR</td> <td style="border: none;">3,8 - 20,5 mA</td> <td style="border: none;">3,5</td> <td style="border: none;">22,6</td> </tr> <tr> <td style="border: none;">4-20 mA HART NAMUR</td> <td style="border: none;">3,8 - 20,5 mA</td> <td style="border: none;">3,5</td> <td style="border: none;">22,6</td> </tr> <tr> <td style="border: none;">4-20 mA US</td> <td style="border: none;">3,9 - 20,8 mA</td> <td style="border: none;">3,75</td> <td style="border: none;">22,6</td> </tr> <tr> <td style="border: none;">4-20 mA HART US</td> <td style="border: none;">3,9 - 20,8 mA</td> <td style="border: none;">3,75</td> <td style="border: none;">22,6</td> </tr> </tbody> </table> <p style="font-size: small; margin-top: 5px;">                     A = Work range                      1 = Work range                      2 = Lower signal on alarm level                      3 = Upper signal on alarm level                      4 = Scaled full scale value                      Q = Flow                 </p> <p> <b>Note!</b></p> <ul style="list-style-type: none"> <li>■ If the measured value is outside the measuring range (defined in the VALUE 20 mA function →  120), a notice message is generated.</li> <li>■ The current output's response to faults is defined in the central FAILSAFE MODE function →  134.</li> </ul>	A	①	②	③	OFF	4 mA	-	-	4-20 mA (25 mA)	4 - 24 mA	2	25	4-20 mA (25 mA) HART	4 - 24 mA	2	25	4-20 mA NAMUR	3,8 - 20,5 mA	3,5	22,6	4-20 mA HART NAMUR	3,8 - 20,5 mA	3,5	22,6	4-20 mA US	3,9 - 20,8 mA	3,75	22,6	4-20 mA HART US	3,9 - 20,8 mA	3,75	22,6
A	①	②	③																														
OFF	4 mA	-	-																														
4-20 mA (25 mA)	4 - 24 mA	2	25																														
4-20 mA (25 mA) HART	4 - 24 mA	2	25																														
4-20 mA NAMUR	3,8 - 20,5 mA	3,5	22,6																														
4-20 mA HART NAMUR	3,8 - 20,5 mA	3,5	22,6																														
4-20 mA US	3,9 - 20,8 mA	3,75	22,6																														
4-20 mA HART US	3,9 - 20,8 mA	3,75	22,6																														





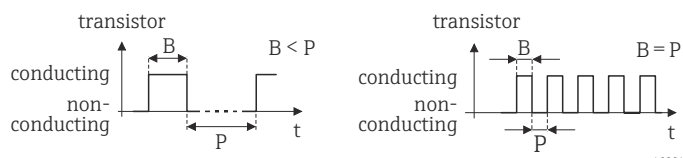

A0005392



Functional description CURRENT OUTPUT	
<b>VALUE 20 mA</b>	<p>Use this function to assign the 20 mA current a full scale value. Positive and negative values are permitted. The required measuring range is defined by defining the VALUE 20 mA .</p> <p>In the SYMMETRY measuring mode →  129, the value assigned applies to both flow directions; in the STANDARD measuring mode it applies only to the flow direction selected.</p> <p><b>User input:</b> 5-digit floating-point number, with sign</p> <p><b>Factory setting:</b> Depends on nominal diameter and country, [value] / [dm<sup>3</sup> to m<sup>3</sup> or US-gal to US-Mgal] Corresponds to the factory setting for the full scale value →  137</p> <p> Note!</p> <ul style="list-style-type: none"> <li>▪ The appropriate unit is taken from the SYSTEM UNITS group →  114.</li> <li>▪ The value for 4 mA always corresponds to the zero flow (0 [unit]). This value is fixed and cannot be edited.</li> </ul>
<b>TIME CONSTANT</b>	<p>Use this function to enter a time constant defining how the current output signal reacts to severely fluctuating measured variables, either very quickly (enter a low time constant) or with damping (enter a high time constant).</p> <p><b>User input:</b> Fixed-point number 0.01 to 100.00 s</p> <p><b>Factory setting:</b> 1.00 s</p>



## 11.7 Group PULSE/STATUS OUTPUT

Functional description PULSE/STATUS OUTPUT	
<b>OPERATING MODE</b>	<p>Configuration of the output as a pulse or status output. The functions available in this function group vary, depending on which option you select here.</p> <p><b>Options:</b> OFF PULSE STATUS</p> <p><b>Factory setting:</b> PULSE</p>
<b>PULSE VALUE</b>	<p> <b>Note!</b> This function is not available unless the PULSE setting was selected in the OPERATING MODE function.</p> <p>Use this function to define the flow at which a pulse is triggered. These pulses can be totaled by an external totalizer, and the total flow quantity since measuring started can be registered in this way. In the SYMMETRY measuring mode → 129, the value assigned applies to both flow directions; in the STANDARD measuring mode it applies only to the positive flow direction.</p> <p><b>User input:</b> 5-digit floating-point number, [unit]</p> <p><b>Factory setting:</b> Depends on nominal diameter and country, [value] [dm<sup>3</sup> to m<sup>3</sup> or US-gal] / pulse; Corresponds to the factory setting for the pulse value → 137</p> <p> <b>Note!</b> The appropriate unit is taken from the SYSTEM UNITS group.</p>
<b>PULSE WIDTH</b>	<p> <b>Note!</b> This function is not available unless the PULSE setting was selected in the OPERATING MODE function.</p> <p>Use this function to enter the maximum pulse width of the output pulses.</p> <p><b>User input:</b> 5 to 2000 ms</p> <p><b>Factory setting:</b> 100 ms</p> <p>Pulse output is always with the pulse width (B) entered in this function. The pauses (P) between the individual pulses are automatically configured. However, they must at least correspond to the pulse width (B = P).</p> <div style="text-align: center;">  </div> <p><i>P = Intervals between the individual pulses B = Pulse width entered (the illustration applies to positive pulses)</i></p> <p> <b>Caution!</b> Buffering (pulse memory) takes place if the number of pulses is too large to output the pulses with the selected pulse width (see PULSE VALUE function on → 121). The system error message RANGE PULSE is displayed if more pulses are in the pulse memory than can be output in 4 seconds.</p> <p> <b>Note!</b></p> <ul style="list-style-type: none"> <li>▪ When selecting the pulse width, choose a value that can still be processed by a connected counter (e.g. mechanical counter, PLC etc.).</li> <li>▪ The pulse output's response to faults is defined in the central FAILSAFE MODE function → 134.</li> </ul>

<b>Functional description PULSE/STATUS OUTPUT</b>	
<b>OUTPUT SIGNAL</b>	<p> <b>Note!</b> This function is not available unless the PULSE setting was selected in the OPERATING MODE function.</p> <p>Use this function to configure the output in such a way that it matches an external counter, for example. Depending on the application, you can select the direction of the pulses here.</p> <p><b>Options:</b> PASSIVE - POSITIVE PASSIVE - NEGATIVE</p> <p><b>Factory setting:</b> PASSIVE - NEGATIVE</p>
<b>ASSIGN STATUS OUTPUT</b>	<p> <b>Note!</b> This function is not available unless the STATUS setting was selected in the OPERATING MODE function.</p> <p>Configuration of the status output.</p> <p><b>Options:</b> ON (operation) FAULT MESSAGE NOTICE MESSAGE FAULT MESSAGE or NOTICE MESSAGE EPD (empty pipe detection, only if active) FLOW DIRECTION VOLUME FLOW LIMIT VALUE</p> <p><b>Factory setting:</b> FAULT MESSAGE</p> <p> <b>Note!</b></p> <ul style="list-style-type: none"> <li>▪ The behavior of the status output is a normally closed behavior, in other words the output is closed (trASMEstor conductive) when normal, error-free measuring is in progress.</li> <li>▪ It is very important to read and comply with the information on the switching characteristics of the status output →  125.</li> </ul>
<b>SWITCH-ON POINT</b>	<p> <b>Note!</b> This function is not available unless LIMIT VALUE or FLOW DIRECTION was selected in the ASSIGN STATUS OUTPUT function.</p> <p>Use this function to assign a value to the switch-on point (status output pulls up). The value can be equal to, greater than or less than the switch-off point. Positive and negative values are permitted.</p> <p><b>User input:</b> 5-digit floating-point number, [unit]</p> <p><b>Factory setting:</b> 0 [unit]</p> <p> <b>Note!</b></p> <ul style="list-style-type: none"> <li>▪ The appropriate unit is taken from the SYSTEM UNITS group.</li> <li>▪ Only the switch-on point is available for flow direction output (no switch-off point). If you enter a value not equal to the zero flow (e.g. 5), the difference between the zero flow and the value entered corresponds to half the switchover hysteresis.</li> </ul>

<b>Functional description PULSE/STATUS OUTPUT</b>	
<b>SWITCH-OFF POINT</b>	<p> <b>Note!</b> This function is not available unless LIMIT VALUE was selected in the ASSIGN STATUS OUTPUT function.</p> <p>Use this function to assign a value to the switch-off point (status output drops off). The value can be equal to, greater than or less than the switch-on point. Positive and negative values are permitted.</p> <p><b>User input:</b> 5-digit floating-point number, [unit]</p> <p><b>Factory setting:</b> 0 [unit]</p> <p> <b>Note!</b></p> <ul style="list-style-type: none"> <li>▪ The appropriate unit is taken from the SYSTEM UNITS group.</li> <li>▪ If SYMMETRY is selected in the MEASURING MODE function and values with different signs are entered for the switch-on and switch-off points, the notice message "INPUT RANGE EXCEEDED" appears.</li> </ul>

## 11.7.1 Information on the response of the status output

### General

If you have configured the status output for "LIMIT VALUE" or "FLOW DIRECTION", you can configure the requisite switch points in the SWITCH-ON POINT and SWITCH-OFF POINT functions. When the measured variable in question reaches these predefined values, the status output switches as shown in the illustrations below.

### Status output configured for flow direction

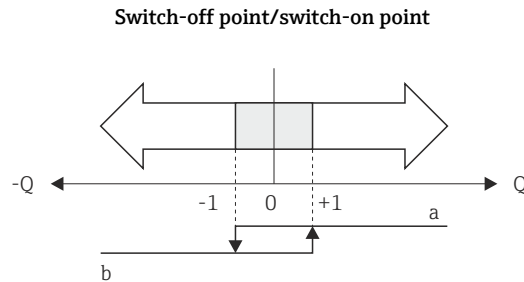

a = Status output conductive  
b = Status output not conductive

The value you entered in the function SWITCH-ON POINT defines the switch point for the positive and negative directions of flow. If, for example, the switch point entered is  $1 \text{ m}^3/\text{h}$ , the status output switches off at  $-1 \text{ m}^3/\text{h}$  (not conductive) and switches on again at  $+1 \text{ m}^3/\text{h}$  (conductive). Set the switch point to 0 if your process calls for direct switchover (no switching hysteresis). If low flow cut off is used, it is advisable to set hysteresis to a value greater than or equal to the low flow cut off rate.

### Status output configured for limit value





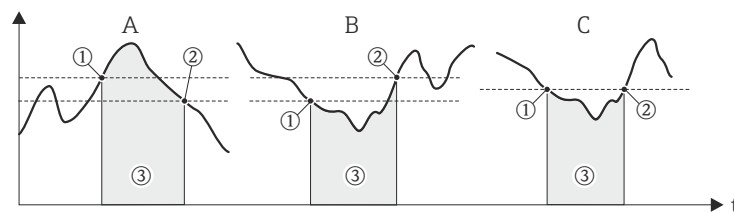





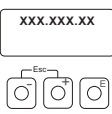



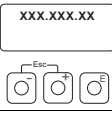



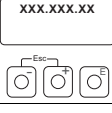



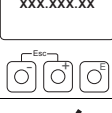





The status output switches as soon as the measured variable undershoots or overshoots a defined switch point.

Application: monitoring flow or process-related boundary conditions.



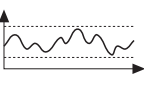

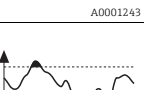
- A = Maximum safety:  
1 SWITCH-OFF POINT > 2 SWITCH-ON POINT
- B = Minimum safety:  
1 SWITCH-OFF POINT < 2 SWITCH-ON POINT
- C = Minimum safety:  
1 SWITCH-OFF POINT = 2 SWITCH-ON POINT (this configuration should be avoided)
- 3 = Relay de-energized



### 11.7.2 Switching behavior of the status output



Function	State		Open collector behavior (TrASMEstor)	
ON (operation)	System in measuring mode		conductive	 A0001237
	System not in measuring mode (power supply failed)		not conductive	 A0001239
Fault message	System OK		conductive	 A0001237
	(System error or process error) fault → Response to error, outputs/inputs and totalizers		not conductive	 A0001239
Notice message	System OK		conductive	 A0001237
	(System error or process error) Notice → Continuation of measuring		not conductive	 A0001239
Fault message or notice message	System OK		conductive	 A0001237
	(System error or process error) Fault → Response to error or Notice → Continuation of measuring		not conductive	 A0001239
Empty pipe detection (EPD)	Measuring tube full		conductive	 A0001237
	Measuring tube partially filled / empty measuring tube		not conductive	 A0001239
Flow direction	Forwards	 A0001241	conductive	 A0001237
	Backwards	 A0001242	not conductive	 A0001239
Volume flow limit value	Limit value not overshoot or undershot	 A0001243	conductive	 A0001237
	Limit value overshoot or undershot	 A0001244	not conductive	 A0001239

## 11.8 Group COMMUNICATION

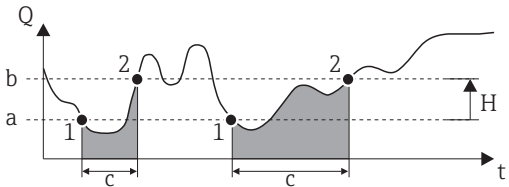
Functional description COMMUNICATION	
 <b>Note!</b> The communication group is only visible if the HART option was selected in the CURRENT RANGE function.	
<b>TAG NAME</b>	Use this function to enter a tag name for the measuring device. You can edit and read this tag name at the local display or via the HART protocol.  <b>User input:</b> Max. 8-character text, permitted characters are: A-Z, 0-9, +, -, underscore, space, period  <b>Factory setting:</b> " _ _ _ _ _ _ _ _ " (no text)
<b>TAG DESCRIPTION</b>	Use this function to enter a tag description for the measuring device. You can edit and read this tag description at the local display or via the HART protocol.  <b>User input:</b> Max. 16-character text, permitted characters are: A-Z, 0-9, +, -, underscore, space, period  <b>Factory setting:</b> " _ _ _ _ _ _ _ _ _ _ _ _ _ _ _ _ " (no text)
<b>BUS ADDRESS</b>	Use this function to define the address for the exchange of data with the HART protocol.  <b>User input:</b> 0 to 15  <b>Factory setting:</b> 0   <b>Note!</b> Addresses 1 to 15: a constant 4 mA current is applied.
<b>HART WRITE PROTECTION</b>	Use this function to activate HART write protection.  <b>Options:</b> OFF = function can be edited/read via the HART protocol ON = HART protocol write-protected (only readable)  <b>Factory setting:</b> OFF
<b>MANUFACTURER ID</b>	Use this function to view the manufacturer ID in decimal numerical format.  <b>Display:</b> - Endress+Hauser - 17 (≅ 11 hex) for Endress+Hauser
<b>DEVICE ID</b>	Use this function to view the device ID in hexadecimal numerical format.  <b>Display:</b> 45 hex (≅ 69 dec) for Promag 10



## 11.9 Group PROCESS PARAMETER

Functional description PROCESS PARAMETER	
<p><b>SWITCH-ON POINT LOW FLOW CUT OFF</b></p>	<p>Use this function to enter the switch-on point for low flow cut off. Low flow cut off is active if the value entered is not equal to 0. The sign of the flow value is highlighted on the display to indicate that low flow cut off is active.</p> <p><b>User input:</b> 5-digit floating-point number, [unit]</p> <p><b>Factory setting:</b> Depends on nominal diameter and country, [value] / [dm<sup>3</sup> to m<sup>3</sup> or US-gal] Corresponds to the factory setting for the low flow cut off → 137</p> <p> <b>Note!</b> The appropriate unit is taken from the SYSTEM UNITS group.</p> <p>The switch-off point is specified as a positive hysteresis from the switch-on point with 50%.</p> <div style="text-align: center;">  </div> <p style="text-align: right; font-size: small;">A0001245</p> <p><i>Q</i> Flow [volume/time]  <i>t</i> Time  <i>H</i> Hysteresis  <i>a</i> SWITCH-ON POINT LOW FLOW CUT OFF = 200 dm<sup>3</sup>/h  <i>b</i> Low flow cut off switch-off point = 50%  <i>c</i> Low flow cut off active  <i>1</i> Low flow cut off is switched on at 200 dm<sup>3</sup>/h  <i>2</i> Low flow cut off is switched off at 300 dm<sup>3</sup>/h</p>
<p><b>EPD</b></p>	<p>Activating empty pipe detection (EPD).</p> <p><b>Options:</b> OFF ON (empty pipe detection)</p> <p><b>Factory setting:</b> OFF</p> <p> <b>Note!</b></p> <ul style="list-style-type: none"> <li>▪ The ON option is not available unless the sensor is fitted with an EPD electrode.</li> <li>▪ The default setting for the EPD function when the device is delivered is OFF. The function must be activated as required.</li> <li>▪ When delivered, the measuring device is calibrated with water (500 µS/cm). If the fluid differs from this conductivity, empty-pipe and full-pipe adjustment has to be performed on site.</li> <li>▪ To activate the function (ON option), valid adjustment coefficients have to be available.</li> <li>▪ The following error messages are displayed if the empty-pipe and full-pipe adjustment is incorrect:             <ul style="list-style-type: none"> <li>▪ ADJUSTMENT FULL = EMPTY: the adjustment values for empty pipe and full pipe are identical.</li> <li>▪ ADJUSTMENT NOT OK: adjustment is not possible as the fluid conductivity values are outside the permitted range.</li> </ul> </li> <li>▪ In cases of this nature you must repeat empty-pipe or full-pipe adjustment.</li> </ul>

<b>Functional description PROCESS PARAMETER</b>	
<b>EPD-MODE (continued)</b>	<p><b>Notes on empty pipe detection (EPD)</b></p> <ul style="list-style-type: none"> <li>▪ Flow cannot be measured correctly unless the measuring tube is completely full. This status can be monitored at all times by means of the EPD.</li> <li>▪ An empty or partially filled pipe is a process error. A default factory setting defines that a notice message is issued and that this process error does not have any effect on the outputs.</li> <li>▪ The EPD process error can be output via the configurable status output.</li> </ul> <p><b>Response to partially filled pipe</b></p> <p>If the EPD is switched on and responds to a partially filled or empty pipe, the notice message "EMPTY PIPE" appears on the display and zero flow is indicated. If the pipe is partially empty and the EPD is not switched on, the response can vary in identically configured systems:</p> <ul style="list-style-type: none"> <li>▪ Flow reading fluctuates</li> <li>▪ Zero flow</li> <li>▪ Excessively high flow values</li> </ul>
<b>EPD ADJUSTMENT</b>	<p>Use this function to activate adjustment for an empty or full measuring tube.</p> <p><b>Options:</b> OFF EPD EMPTY PIPE ADJ. EPD FULL PIPE ADJUST</p> <p><b>Factory setting:</b> OFF</p> <p> <b>Note!</b> An exact description of the procedure for an EPD empty-pipe/full-pipe adjustment is provided on →  68.</p>

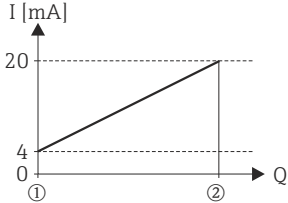
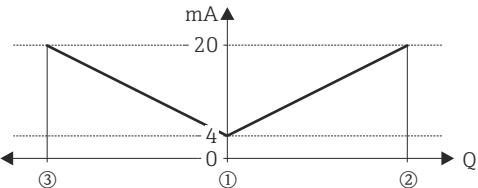

## 11.10 Group SYSTEM PARAMETER

Functional description SYSTEM PARAMETER	
<p><b>INSTALLATION DIRECTION SENSOR</b></p>	<p>Use this function to reverse the sign of the flow quantity, if necessary.</p> <p><b>Options:</b> FORWARDS (flow as indicated by the arrow) BACKWARDS (flow opposite to direction indicated by the arrow)</p> <p><b>Factory setting:</b> FORWARDS</p> <p> <b>Note!</b> Ascertain the actual direction of fluid flow with reference to the direction indicated by the arrow on the sensor (nameplate).</p>
<p><b>MEASURING MODE</b></p>	<p>Use this function to select the measuring mode for all outputs and for the internal totalizer.</p> <p><b>Options:</b> STANDARD SYMMETRY</p> <p><b>Factory setting:</b> STANDARD</p> <p>The responses of the individual outputs and the internal totalizer in each of the measuring modes are described in detail on the following pages:</p> <p><b>Current output STANDARD</b> Only the flow components for the selected flow direction are output, (positive or negative full scale value (2) = flow direction). Flow components in the opposite direction are not taken into account (suppression).</p> <p>Example for current output:</p>  <p style="text-align: right; font-size: small;">A0001248</p> <p><b>SYMMETRY</b> The output signals of the current output are independent of the direction of flow (absolute amount of the measured variable). The "VALUE20mA" (3) (e.g. backflow) corresponds to the mirrored VALUE20mA (2) (e.g. flow). Positive and negative flow components are taken into account.</p> <p>Example for current output:</p>  <p style="text-align: right; font-size: small;">A0001249</p> <p> <b>Note!</b> The direction of flow can be output via the configurable status output.</p>

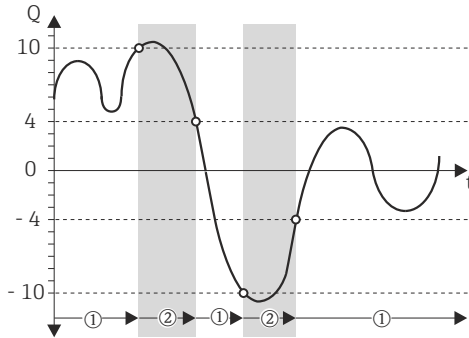
Functional description SYSTEM PARAMETER	
<p><b>MEASURING MODE (Contd)</b></p>	<p><b>Pulse output</b></p> <p><b>STANDARD</b> Only flow components of the positive flow direction are output. Components in the opposite direction are not taken into account.</p> <p><b>SYMMETRY</b> The absolute value of the positive and negative flow components is taken into account.</p> <p><b>Status output</b></p> <p> <b>Note!</b> The information is only applicable if LIMIT VALUE was selected in the function ASSIGN STATUS OUTPUT.</p> <p><b>STANDARD</b> The status output signal switches at the defined switch points.</p> <p><b>SYMMETRY</b> The status output signal switches at the defined switch points, irrespective of the sign. In other words, if you define a switch point with a positive sign, the status output signal switches as soon as the value is reached in the negative direction (negative sign), (see illustration).</p> <p>Example for the SYMMETRY measuring mode: Switch-on point: Q = 4 Switch-off point: Q = 10 1 = Status output switched on (conductive) 2 = Status output switched off (nonconductive)</p>  <p style="text-align: right; font-size: small;">A0001247</p> <p><b>Totalizer</b></p> <p><b>STANDARD</b> Only positive flow components are output. Negative components are not taken into account.</p> <p><b>SYMMETRY</b> The positive and negative flow components are balanced. In other words, net flow in the flow direction is registered.</p>
<p><b>POSITIVE ZERO RETURN</b></p>	<p>Use this function to interrupt evaluation of measured variables. This is necessary when a piping system is being cleaned, for example. This setting acts on all function and outputs of the measuring device.</p> <p><b>Options:</b> OFF ON → Signal output is set to the "ZERO FLOW" value.</p> <p><b>Factory setting:</b> OFF</p>

Functional description SYSTEM PARAMETER	
<b>SYSTEM DAMPING</b>	<p>Use this function to set the filter depth of the digital filter. This reduces the sensitivity of the measuring signal to interference peaks (e.g. high solids content, gas bubbles in the fluid, etc.). The system reaction time increases with the filter setting.</p> <p><b>User input:</b> 0 to 4</p> <p><b>Factory setting:</b> 3</p> <p> <b>Note!</b></p> <ul style="list-style-type: none"><li>▪ The system damping acts on all functions and outputs of the measuring device.</li><li>▪ The higher the value set, the stronger the damping (higher response time).</li></ul>

## 11.11 Group SENSOR DATA

All sensor data (calibration factors, zero point and nominal diameter etc.) are set at the factory.





Caution!

Under normal circumstances you should not change the following parameter settings, because changes affect numerous functions of the entire measuring facility in general and the accuracy of the measuring system in particular. Therefore, the functions described below are provided with an additional prompt (with the code 10) once you enter your private code.

Functional description SENSOR DATA	
<b>CALIBRATION DATE</b>	<p>Use this function to view the current calibration date and time for the sensor.</p> <p><b>User input:</b> Calibration date and time.</p> <p><b>Factory setting:</b> Calibration date and time of the current calibration.</p> <p> Note! The calibration date and time format is defined in the FORMAT DATE/TIME function, → 115</p> <p>Selectable formats: DD.MM.YY 24H MM/DD/YY 12H A/P DD.MM.YY 12H A/P MM/DD/YY 24H</p>
<b>SENSITIVITY</b>	<p>Use this function to set the nominal sensitivity of the sensor.</p> <p><b>Factory setting:</b> Calibration date and time of the current calibration.</p> <p><b>Limits:</b> 1 to 100000</p> <p> Note! This value is indicated on the name plate of the sensor.</p>
<b>K-FACTOR</b>	<p>Use this function to display the current calibration factor (positive and negative flow direction) for the sensor. The calibration factor is determined and set at the factory.</p> <p><b>User input:</b> 5-digit fixed-point number: 0.5000 to 2.0000</p> <p><b>Factory setting:</b> Depends on nominal diameter and calibration</p> <p> Note! This value is also provided on the sensor nameplate.</p>
<b>ZERO POINT</b>	<p>This function shows the current zero-point correction value for the sensor. Zero-point correction is determined and set at the factory.</p> <p><b>User input:</b> Max. 4-digit number: -1000 to +1000</p> <p><b>Factory setting:</b> Depends on nominal diameter and calibration</p> <p> Note! This value is also provided on the sensor nameplate.</p>





<b>Functional description SENSOR DATA</b>	
<b>NOMINAL DIAMETER</b>	<p>This function shows the nominal diameter for the sensor. The nominal diameter depends on the size of the sensor and is set at the factory.</p> <p><b>Options:</b> 2 to 2000 mm ½ to 78"</p> <p><b>Factory setting:</b> Depends on the size of the sensor</p> <p> <b>Note!</b> This value is also provided on the sensor nameplate.</p>
<b>MEASURING PERIOD</b>	<p>Use this function to set the time for a full measuring period. The duration of the measuring period is calculated from the rise time of the magnetic field, the brief recovery time, the (automatically tracked) integration time and the empty pipe detection time.</p> <p><b>User input:</b> 10 to 1000 ms</p> <p><b>Factory setting:</b> Depends on nominal diameter</p>
<b>EPD ELECTRODE</b>	<p>Indicates whether the sensor is equipped with an EPD electrode.</p> <p><b>Display:</b> YES NO</p> <p><b>Factory setting:</b> YES → Electrode fitted as standard</p>

## 11.12 Group SUPERVISION

Functional description SUPERVISION	
<b>FAILSAFE MODE</b>	<p>The dictates of safety render it advisable to ensure that the device signal processing assumes a predefined state in the event of a fault. The setting you select here is valid for:</p> <ul style="list-style-type: none"> <li>■ Current output</li> <li>■ Pulse output</li> <li>■ Totalizer</li> </ul> <p> <b>Note!</b> This has no effect on the display.</p> <p><b>Options:</b> MINIMUM VALUE MAXIMUM VALUE ACTUAL VALUE</p> <p><b>Factory setting:</b> MINIMUM VALUE The response of the individual outputs and the totalizer is listed below.</p> <p><b>Current output:</b> MINIMUM VALUE The current output adopts the value of the lower signal on alarm level (as defined in the CURRENT RANGE function →  119).</p> <p>MAXIMUM VALUE The current output is set to the upper value of the signal on alarm level. (The values in question can be found in the CURRENT RANGE function on →  119).</p> <p>ACTUAL VALUE Measured value output is based on the current flow measurement. The fault is ignored.</p> <p><b>Pulse output:</b> MINIMUM or MAXIMUM VALUE Output is zero pulse</p> <p>ACTUAL VALUE Measured value output is based on the current flow measurement (fault is ignored).</p> <p><b>Totalizer:</b> MINIMUM or MAXIMUM VALUE The totalizer is paused until the fault is rectified.</p> <p>ACTUAL VALUE The totalizer continues to count on the basis of the current flow value. The fault is ignored.</p>

<b>Functional description SUPERVISION</b>	
<b>ALARM DELAY</b>	<p>Use this function to define a time span in which the criteria for an error have to be satisfied without interruption before an error or notice message is generated.</p> <p>Depending on the setting and the type of error, this suppression acts on:</p> <ul style="list-style-type: none"> <li>▪ Display</li> <li>▪ Current output</li> <li>▪ Pulse/status output</li> </ul> <p><b>User input:</b> 0 to 100 s (in increments of one second)</p> <p><b>Factory setting:</b> 0 s</p> <p> <b>Caution!</b> If this function is activated error and notice messages are delayed by the time corresponding to the setting before being forwarded to the higher-order controller (process controller, etc.). It is therefore imperative to check in advance in order to make sure whether a delay of this nature could affect the safety requirements of the process. If error and notice messages cannot be suppressed, a value of 0 seconds must be entered here.</p>
<b>SYSTEM RESET</b>	<p>Use this function to perform a reset of the measuring system.</p> <p><b>Options:</b> NO</p> <p>RESTART SYSTEM (Restart without disconnecting main power)</p> <p>RESET DELIVERY (Restart without disconnecting main power, the saved settings of the delivery status (factory settings) are applied).</p> <p><b>Factory setting:</b> NO</p>
<b>SELF CHECKING</b>	<p>Use this function to switch on and off the self-checking function of the electrode amplifier.</p> <p>When the function is switched on, the electrode signal circuit is checked against a reference voltage at 60-second intervals. If there is an impermissible deviation from the value, system error message #101 is output and displayed on the local display.</p> <p><b>Options:</b> ON OFF</p> <p><b>Factory setting:</b> OFF</p>

## 11.13 Group SIMULATION SYSTEM

Functional description SIMULATION SYSTEM	
<b>SIMULATION FAILSAFE MODE</b>	<p>Use this function to set all outputs and the totalizer to their defined failsafe modes, in order to check whether they respond correctly. During this time, the words "SIMULATION FAILSAFE MODE" appear on the display.</p> <p><b>Options:</b> ON OFF</p> <p><b>Factory setting:</b> OFF</p>
<b>SIMULATION MEASURAND</b>	<p>Use this function to set all outputs and the totalizer to their defined flow-response modes, in order to check whether they respond correctly. During this time, the words "SIMULATION MEASURAND" appear on the display.</p> <p><b>Options:</b> OFF VOLUME FLOW</p> <p><b>Factory setting:</b> OFF</p> <p> <b>Note!</b>  <ul style="list-style-type: none"> <li>▪ The measuring device cannot be used for measuring while this simulation is in progress.</li> <li>▪ The setting is not saved if the power supply fails.</li> </ul> </p>
<b>VALUE SIMULATION MEASURAND</b>	<p> <b>Note!</b> This function is not available unless the SIMULATION MEASURAND function is active (= VOLUME FLOW).</p> <p>In this function, a freely selectable value (e.g. 12 m<sup>3</sup>/s) is specified. This value is used to test downstream devices and the flowmeter itself.</p> <p><b>User input:</b> 5-digit floating-point number [unit], with sign</p> <p><b>Factory setting:</b> 0 [unit]</p> <p> <b>Caution!</b> The setting is not saved if the power supply fails.</p> <p> <b>Note!</b> The appropriate unit is taken from the SYSTEM UNITS group.</p>

## 11.14 Group SENSOR VERSION

Functional description SENSOR VERSION	
<b>SERIAL NUMBER</b>	Use this function to view the serial number of the sensor.
<b>SENSOR TYPE</b>	Use this function to view the sensor type.

## 11.15 Group AMPLIFIER VERSION

Functional description AMPLIFIER VERSION	
<b>SOFTWARE REVISION NUMBER</b>	Use this function to view the software revision number of the electronics board.



## 11.16 Factory settings

### 11.16.1 SI units (not for USA and Canada)

Low flow cut off, full scale value, pulse value, totalizer

Standard version

Nominal diameter		Low flow cut off		Full scale value current output		Pulse value		Totalizer
[mm]	[inch]	(approx. $v = 0.04$ m/s)		(approx. $v = 2.5$ m/s)		(approx. 2 pulses/s at $v = 2.5$ m/s)		
2	1/12"	0.01	dm <sup>3</sup> /min	0.5	dm <sup>3</sup> /min	0.005	dm <sup>3</sup>	dm <sup>3</sup>
4	1/8"	0.05	dm <sup>3</sup> /min	2	dm <sup>3</sup> /min	0.025	dm <sup>3</sup>	dm <sup>3</sup>
8	3/8"	0.1	dm <sup>3</sup> /min	8	dm <sup>3</sup> /min	0.10	dm <sup>3</sup>	dm <sup>3</sup>
15	1/2"	0.5	dm <sup>3</sup> /min	25	dm <sup>3</sup> /min	0.20	dm <sup>3</sup>	dm <sup>3</sup>
25	1"	1	dm <sup>3</sup> /min	75	dm <sup>3</sup> /min	0.50	dm <sup>3</sup>	dm <sup>3</sup>
32	1 1/4"	2	dm <sup>3</sup> /min	125	dm <sup>3</sup> /min	1.00	dm <sup>3</sup>	dm <sup>3</sup>
40	1 1/2"	3	dm <sup>3</sup> /min	200	dm <sup>3</sup> /min	1.50	dm <sup>3</sup>	dm <sup>3</sup>
50	2"	5	dm <sup>3</sup> /min	300	dm <sup>3</sup> /min	2.50	dm <sup>3</sup>	dm <sup>3</sup>
65	2 1/2"	8	dm <sup>3</sup> /min	500	dm <sup>3</sup> /min	5.00	dm <sup>3</sup>	dm <sup>3</sup>
80	3"	12	dm <sup>3</sup> /min	750	dm <sup>3</sup> /min	5.00	dm <sup>3</sup>	dm <sup>3</sup>
100	4"	20	dm <sup>3</sup> /min	1200	dm <sup>3</sup> /min	10.00	dm <sup>3</sup>	dm <sup>3</sup>
125	5"	30	dm <sup>3</sup> /min	1850	dm <sup>3</sup> /min	15.00	dm <sup>3</sup>	dm <sup>3</sup>
150	6"	2.5	m <sup>3</sup> /h	150	m <sup>3</sup> /h	0.025	m <sup>3</sup>	m <sup>3</sup>
200	8"	5.0	m <sup>3</sup> /h	300	m <sup>3</sup> /h	0.05	m <sup>3</sup>	m <sup>3</sup>
250	10"	7.5	m <sup>3</sup> /h	500	m <sup>3</sup> /h	0.05	m <sup>3</sup>	m <sup>3</sup>
300	12"	10	m <sup>3</sup> /h	750	m <sup>3</sup> /h	0.10	m <sup>3</sup>	m <sup>3</sup>
350	14"	15	m <sup>3</sup> /h	1000	m <sup>3</sup> /h	0.10	m <sup>3</sup>	m <sup>3</sup>
375	15"	20	m <sup>3</sup> /h	1200	m <sup>3</sup> /h	0.15	m <sup>3</sup>	m <sup>3</sup>
400	16"	20	m <sup>3</sup> /h	1200	m <sup>3</sup> /h	0.15	m <sup>3</sup>	m <sup>3</sup>
450	18"	25	m <sup>3</sup> /h	1500	m <sup>3</sup> /h	0.25	m <sup>3</sup>	m <sup>3</sup>
500	20"	30	m <sup>3</sup> /h	2000	m <sup>3</sup> /h	0.25	m <sup>3</sup>	m <sup>3</sup>
600	24"	40	m <sup>3</sup> /h	2500	m <sup>3</sup> /h	0.30	m <sup>3</sup>	m <sup>3</sup>
700	28"	50	m <sup>3</sup> /h	3500	m <sup>3</sup> /h	0.50	m <sup>3</sup>	m <sup>3</sup>
-	30"	60	m <sup>3</sup> /h	4000	m <sup>3</sup> /h	0.50	m <sup>3</sup>	m <sup>3</sup>
800	32"	75	m <sup>3</sup> /h	4500	m <sup>3</sup> /h	0.75	m <sup>3</sup>	m <sup>3</sup>
900	36"	100	m <sup>3</sup> /h	6000	m <sup>3</sup> /h	0.75	m <sup>3</sup>	m <sup>3</sup>
1000	40"	125	m <sup>3</sup> /h	7000	m <sup>3</sup> /h	1.00	m <sup>3</sup>	m <sup>3</sup>
-	42"	125	m <sup>3</sup> /h	8000	m <sup>3</sup> /h	1.00	m <sup>3</sup>	m <sup>3</sup>
1200	48"	150	m <sup>3</sup> /h	10000	m <sup>3</sup> /h	1.50	m <sup>3</sup>	m <sup>3</sup>
-	54"	200	m <sup>3</sup> /h	13000	m <sup>3</sup> /h	1.50	m <sup>3</sup>	m <sup>3</sup>
1400	-	225	m <sup>3</sup> /h	14000	m <sup>3</sup> /h	2.00	m <sup>3</sup>	m <sup>3</sup>
-	60"	250	m <sup>3</sup> /h	16000	m <sup>3</sup> /h	2.00	m <sup>3</sup>	m <sup>3</sup>
1600	-	300	m <sup>3</sup> /h	18000	m <sup>3</sup> /h	2.50	m <sup>3</sup>	m <sup>3</sup>
-	66"	325	m <sup>3</sup> /h	20500	m <sup>3</sup> /h	2.50	m <sup>3</sup>	m <sup>3</sup>
1800	72"	350	m <sup>3</sup> /h	23000	m <sup>3</sup> /h	3.00	m <sup>3</sup>	m <sup>3</sup>
-	78"	450	m <sup>3</sup> /h	28500	m <sup>3</sup> /h	3.50	m <sup>3</sup>	m <sup>3</sup>
2000	-	450	m <sup>3</sup> /h	28500	m <sup>3</sup> /h	3.50	m <sup>3</sup>	m <sup>3</sup>

## Optional version w/o inlet and outlet runs (Promag 10W)

Nominal diameter		Low flow cut off	Full scale value current output	Pulse value	Totalizer
[mm]	[inch]	(v ~ 0,02 m/s)	(v ~ 2,5 m/s)	(~ 4 Pulse/s bei v = 2,5 m/s)	
50	2"	2.25 dm <sup>3</sup> /min	300 dm <sup>3</sup> /min	1.25 dm <sup>3</sup>	dm <sup>3</sup>
65	2 ½"	4 dm <sup>3</sup> /min	500 dm <sup>3</sup> /min	2 dm <sup>3</sup>	dm <sup>3</sup>
80	3"	6 dm <sup>3</sup> /min	750 dm <sup>3</sup> /min	3 dm <sup>3</sup>	dm <sup>3</sup>
100	4"	9.5 dm <sup>3</sup> /min	1200 dm <sup>3</sup> /min	5 dm <sup>3</sup>	dm <sup>3</sup>
125	5"	15 dm <sup>3</sup> /min	1850 dm <sup>3</sup> /min	8 dm <sup>3</sup>	dm <sup>3</sup>
150	6"	20 dm <sup>3</sup> /min	2500 dm <sup>3</sup> /min	10 dm <sup>3</sup>	m <sup>3</sup>
200	8"	35 dm <sup>3</sup> /min	5000 dm <sup>3</sup> /min	20 dm <sup>3</sup>	m <sup>3</sup>
250	10"	3.5 m <sup>3</sup> /h	500 m <sup>3</sup> /h	0.03 m <sup>3</sup>	m <sup>3</sup>
300	12"	5 m <sup>3</sup> /h	750 m <sup>3</sup> /h	0.05 m <sup>3</sup>	m <sup>3</sup>

## Language

Country	Language
Austria	Deutsch
Belgium	English
Denmark	English
England	English
Finland	English
France	Francais
Germany	Deutsch
Holland	English
Hong Kong	English
International Instruments	English
Italy	Italiano
Japan	English
Malaysia	English
Norway	English
Singapore	English
South Africa	English
Spain	Espanol
Sweden	English
Switzerland	Deutsch
Thailand	English

### 11.16.2 US units (only for USA and Canada)

#### Low flow cut off, full scale value, pulse value, totalizer

Standard version

Nominal diameter		Low flow cut off		Full scale value current output		Pulse value		Totalizer
[inch]	[mm]	(approx. v = 0.04 m/s)		(approx. v = 2.5 m/s)		(approx. 2 pulses/s at v = 2.5 m/s)		
1/12"	2	0.002	gal/min	0.1	gal/min	0.001	gal	gal
1/8"	4	0.008	gal/min	0.5	gal/min	0.005	gal	gal
3/8"	8	0.025	gal/min	2	gal/min	0.02	gal	gal
1/2"	15	0.10	gal/min	6	gal/min	0.05	gal	gal
1"	25	0.25	gal/min	18	gal/min	0.20	gal	gal
1 1/4"	32	0.50	gal/min	30	gal/min	0.20	gal	gal
1 1/2"	40	0.75	gal/min	50	gal/min	0.50	gal	gal
2"	50	1.25	gal/min	75	gal/min	0.50	gal	gal
2 1/2"	65	2.0	gal/min	130	gal/min	1	gal	gal
3"	80	2.5	gal/min	200	gal/min	2	gal	gal
4"	100	4.0	gal/min	300	gal/min	2	gal	gal
5"	125	7.0	gal/min	450	gal/min	5	gal	gal
6"	150	12	gal/min	600	gal/min	5	gal	gal
8"	200	15	gal/min	1200	gal/min	10	gal	gal
10"	250	30	gal/min	1500	gal/min	15	gal	gal
12"	300	45	gal/min	2400	gal/min	25	gal	gal
14"	350	60	gal/min	3600	gal/min	30	gal	gal
15"	375	60	gal/min	4800	gal/min	50	gal	gal
16"	400	60	gal/min	4800	gal/min	50	gal	gal
18"	450	90	gal/min	6000	gal/min	50	gal	gal
20"	500	120	gal/min	7500	gal/min	75	gal	gal
24"	600	180	gal/min	10500	gal/min	100	gal	gal
28"	700	210	gal/min	13500	gal/min	125	gal	gal
30"	–	270	gal/min	16500	gal/min	150	gal	gal
32"	800	300	gal/min	19500	gal/min	200	gal	gal
36"	900	360	gal/min	24000	gal/min	225	gal	gal
40"	1000	480	gal/min	30000	gal/min	250	gal	gal
42"	–	600	gal/min	33000	gal/min	250	gal	gal
48"	1200	600	gal/min	42000	gal/min	400	gal	gal
54"	–	1.3	Mgal/d	75	Mgal/d	0.0005	Mgal	Mgal
–	1400	1.3	Mgal/d	85	Mgal/d	0.0005	Mgal	Mgal
60"	–	1.3	Mgal/d	95	Mgal/d	0.0005	Mgal	Mgal
–	1600	1.7	Mgal/d	110	Mgal/d	0.0008	Mgal	Mgal
66"	–	2.2	Mgal/d	120	Mgal/d	0.0008	Mgal	Mgal
72"	1800	2.6	Mgal/d	140	Mgal/d	0.0008	Mgal	Mgal
78"	–	3.0	Mgal/d	175	Mgal/d	0.001	Mgal	Mgal
–	2000	3.0	Mgal/d	175	Mgal/d	0.001	Mgal	Mgal

## Optional version w/o inlet and outlet runs (Promag 10W)

Nominal diameter		Low flow cut off (v ~ 0,02 m/s)	Full scale value current output (v ~ 2,5 m/s)	Pulse value (~ 4 Pulse/s bei v = 2,5 m/s)	Totalizer
[mm]	[inch]				
50	2"	0.7 gal/min	75 gal/min	0.3 gal	dm <sup>3</sup>
65	2 ½"	1.1 gal/min	130 gal/min	0.5 gal	dm <sup>3</sup>
80	3"	1.6 gal/min	200 gal/min	0.8 gal	dm <sup>3</sup>
100	4"	2.5 gal/min	300 gal/min	1.2 gal	dm <sup>3</sup>
125	5"	4 gal/min	450 gal/min	1.8 gal	dm <sup>3</sup>
150	6"	6 gal/min	600 gal/min	2.5 gal	m <sup>3</sup>
200	8"	10 gal/min	1200 gal/min	5 gal	m <sup>3</sup>
250	10"	16 gal/min	1500 gal/min	6 gal	m <sup>3</sup>
300	12"	23 gal/min	2400 gal/min	9 gal	m <sup>3</sup>

## Language

Country	Language
USA	English
Canada	English

# Index

## A

ACCESS CODE .....	116
Accessories .....	70
Adapters .....	15
ALARM DELAY .....	135
Ambient temperature range .....	88
Anziehdrehmomente	
Promag D .....	21
Applicator (selection and configuration software) .....	71
Approvals .....	8, 110
ASSIGN STATUS OUTPUT .....	122

## B

Brief commissioning guide .....	66
BUS ADDRESS .....	126

## C

Cable entry .....	87
Cable specifications .....	47
CALIBRATION DATE .....	132
Calibration factor .....	7
CE mark .....	110
CE mark (Declaration of Conformity) .....	8
Centering sleeve	
Promag D .....	19
Certificates .....	8, 110
CIP cleaning .....	89
Cleaning (exterior cleaning) .....	69
Code entry (function matrix) .....	57
Commissioning	
Brief operating instructions .....	66
General .....	66
Setup .....	67
With a new electronics board .....	67
Commissioning setup .....	67
Communication .....	59
Conductivity of fluid .....	91
Connecting cable .....	16
Connection	
HART .....	49
Remote version .....	42
Terminal assignment .....	49
Transmitter .....	48
CONTRAST LCD .....	117
C-tick mark .....	110
CURRENT RANGE .....	119

## D

Declaration of Conformity (CE mark) .....	8
DEFINE PRIVATE CODE .....	116
Degree of protection .....	53, 89
Design .....	96
Device description files .....	59
DEVICE ID .....	126
Device variable via HART protocol .....	60
Display	
Elements .....	55, 110

Turning .....	39
Documentation .....	112
Drinking water approval .....	111

## E

Electrical connections .....	87
Electrodes	
EPD electrode .....	13
EMC (electromagnetic compatibility) .....	47, 89
Empty-pipe/full-pipe adjustment .....	68
Environment .....	88
EPD .....	127
EPD ADJUSTMENT .....	128
EPD ELECTRODE .....	133
Error message types .....	58
Ex approval .....	110
Exterior cleaning .....	69

## F

Factory setting	
SI units .....	137
US units .....	139
FAILSAFE MODE .....	134
Field Xpert SFX100 .....	49
FieldCare .....	59, 71
Fieldcheck (tester and simulator) .....	71
Fitted electrodes .....	108
FORMAT .....	117
FORMAT DATE/TIME .....	115
Function matrix	
Brief operating instructions .....	56
Illustration .....	113
FXA 193 service interface .....	72
FXA193 .....	72

## G

Galvanic isolation .....	86
Ground cable	
Promag E .....	22
Promag L .....	27
Promag P .....	31
Promag W .....	34
Group	
AMPLIFIER VERSION .....	136
COMMUNICATION .....	126
CURRENT OUTPUT .....	119
DISPLAY .....	117
OPERATION .....	116
PROCESS PARAMETER .....	127
PULSE/STATUS OUTPUT .....	121
SENSOR DATA .....	132
SENSOR VERSION .....	136
SIMULATION SYSTEM .....	136
SUPERVISION .....	134
SYSTEM PARAMETER .....	129
SYSTEM UNITS .....	114
TOTALIZER .....	118

**H**

HART	
Command classes	59
Commands	61
Communicator DXR 375	59
Device description files	59
Device status / Error messages	65
Write protection	60
HART WRITE PROTECTION	126
Hazardous substances	82
HOME position (operating mode)	55

**I**

Incoming acceptance	9
Inlet/outlet run	14
Installation	
Promag D	18, 21
Promag E	22
Promag H	25
Promag L	27
Promag P	31
Promag W	34
Remote version	40
See Installation instructions	
Installation conditions	
Adapters	15
Dimensions	11
Down pipe	12
EPD electrode	13
Foundations, supports	15
Inlet/outlet run	14
Installation of pumps	11
Mounting location	11
Orientation	13
Partially filled pipes	12
Vibrations	14
INSTALLATION DIRECTION SENSOR	129

**K**

K-FACTOR	132
----------	-----

**L**

LANGUAGE	116
Load	86
Local display	
See Display	
Low flow cut off	86

**M**

Maintenance	69
MANUFACTURER ID	126
Material	107
Material load diagram	91
Maximum measured error	88
Measured variable	83
MEASURING MODE	129–130
MEASURING PERIOD	133
Measuring principle	83
Measuring range	83
Measuring system	83

Mechanical construction	96
Medium pressure range	91
Medium temperature range	89
Mounting bolts	
Promag D	19

**N**

Nameplate specifications	
Connections	7
Sensor	7
Transmitter	6
NOMINAL DIAMETER	133

**O**

Operable flow range	86
Operating conditions	
Process	89
Operating elements	55, 110
OPERATING MODE	121
Operation	55
Device description files	59
FieldCare	59
Operating programs	59
Operational safety	4
Order code	
Accessories	70
Sensor	7
Transmitter	6
Output	86
OUTPUT SIGNAL	122
Output signal	86
OVERFLOW	118

**P**

Performance characteristics	88
Pig (cleaning)	26
POSITIVE ZERO RETURN	130
Post-connection	
Check	54
Post-installation	
Check	41
Potential equalization	50
Power consumption	87
Power supply	87
Power supply failure	87
Pressure Equipment Directive	111
Pressure loss	
Adapters (reducers, expanders)	15
Pressure tightness	92
Process connections	109
Process error messages	75
Process errors (definition)	58
Programming mode	
Disable	57
Enable	57
Promag D	
Centering sleeve	19
Installation	18, 21
Mounting bolts	19
Seals	18, 21

Tightening torques .....	20–21	SERIAL NUMBER .....	136
Promag D mounting kit .....	18, 21	Serial number	
Promag E		Sensor .....	7
Ground cable .....	22	Transmitter .....	6
Installation .....	22	Shock resistance .....	89
Seals .....	22	Signal on alarm .....	86
Tightening torques .....	23	SIMULATION FAILSAFE MODE .....	136
Promag H		SIMULATION MEASURAND .....	136
Cleaning with pigs .....	26	SIP cleaning .....	89
Installation .....	25	Spare parts .....	78
Seals .....	25	Standards, guidelines .....	111
Weld nipple .....	26	Storage temperature .....	89
Promag H cleaning with pigs .....	26	SUM .....	118
Promag H with weld nipples .....	26	Supply voltage .....	87
Promag L		Surface roughness .....	110
Ground cable .....	27	SW REV. NUMBER .....	136
Installation .....	27	Switching behavior of the status output .....	125
Seals .....	27	Switching on (measuring device) .....	66
Tightening torques .....	28	SWITCH-OFF POINT .....	123
Promag P		SWITCH-ON POINT .....	122
Ground cable .....	31	SWITCH-ON POINT LOW FLOW CUT OFF .....	127
Installation .....	31	SYSTEM DAMPING .....	131
Seals .....	31	System error messages .....	74
Tightening torques .....	31	System errors (definition) .....	58
Promag W		SYSTEM RESET .....	135
Ground cable .....	34		
Installation .....	34	<b>T</b>	
Seals .....	34	TAG DESCRIPTION .....	126
Tightening torques .....	34	TAG NAME .....	126
PULSE VALUE .....	121	Technical data .....	83
PULSE WIDTH .....	121	Temperature	
<b>R</b>		Ambient .....	88
Reference operating conditions .....	88	Medium .....	89
Registered trademarks .....	8	Storage .....	89
Remote operation .....	110	TEST DISPLAY .....	117
Remote version		Tightening torques	
Connection .....	42	Promag D .....	20–21
Installation .....	40	Promag E .....	23
Repair .....	82	Promag L .....	28
Repeatability .....	88	Promag P .....	31
RESET TOTALIZER .....	118	Promag W .....	34
Response of the status output .....	124	TIME CONSTANT .....	120
Response to errors .....	77	Troubleshooting .....	73
Returning devices .....	82	Types of error (system and process errors) .....	58
<b>S</b>			
Safety icons .....	5	<b>U</b>	
Safety instructions .....	4	UNIT VOLUME .....	114
Sanitary compatibility .....	111	UNIT VOLUME FLOW .....	114
Seals .....	69	<b>V</b>	
Promag D .....	18, 21	VALUE 20 mA .....	120
Promag E .....	22	VALUE SIMULATION MEASURAND .....	136
Promag H .....	25	Verbindungskabel .....	17
Promag L .....	27	Vibration resistance .....	89
Promag P .....	31	Vibrations .....	14
Promag W .....	34		
SELF CHECKING .....	135	<b>W</b>	
SENSOR TYPE .....	136	Weight .....	96, 103
		Wiring .....	42

<b>Z</b>	
ZERO POINT .....	132





[www.addresses.endress.com](http://www.addresses.endress.com)

---