



Level



Pressure



Flow



Temperature



Liquid
Analysis



Registration



Systems
Components



Services



Solutions

Operating Instructions

Proline Prowirl 72

HART

Vortex flow measuring system

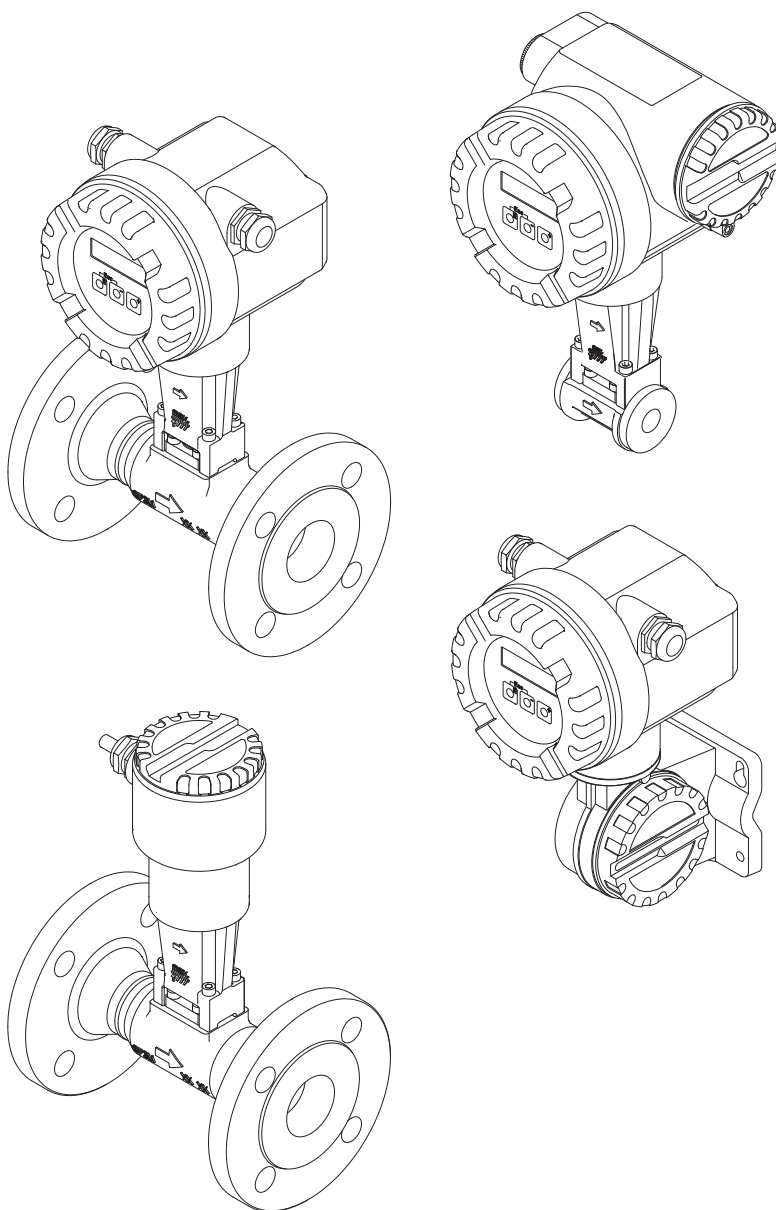

BA00084D/06/EN/14.11
71154511

Valid as of version
V 1.05.XX (device software)

QUICK SETUP for rapid commissioning



Note!

More detailed information on running Quick Setup menus can be found in the "Commissioning" section (→ 39).

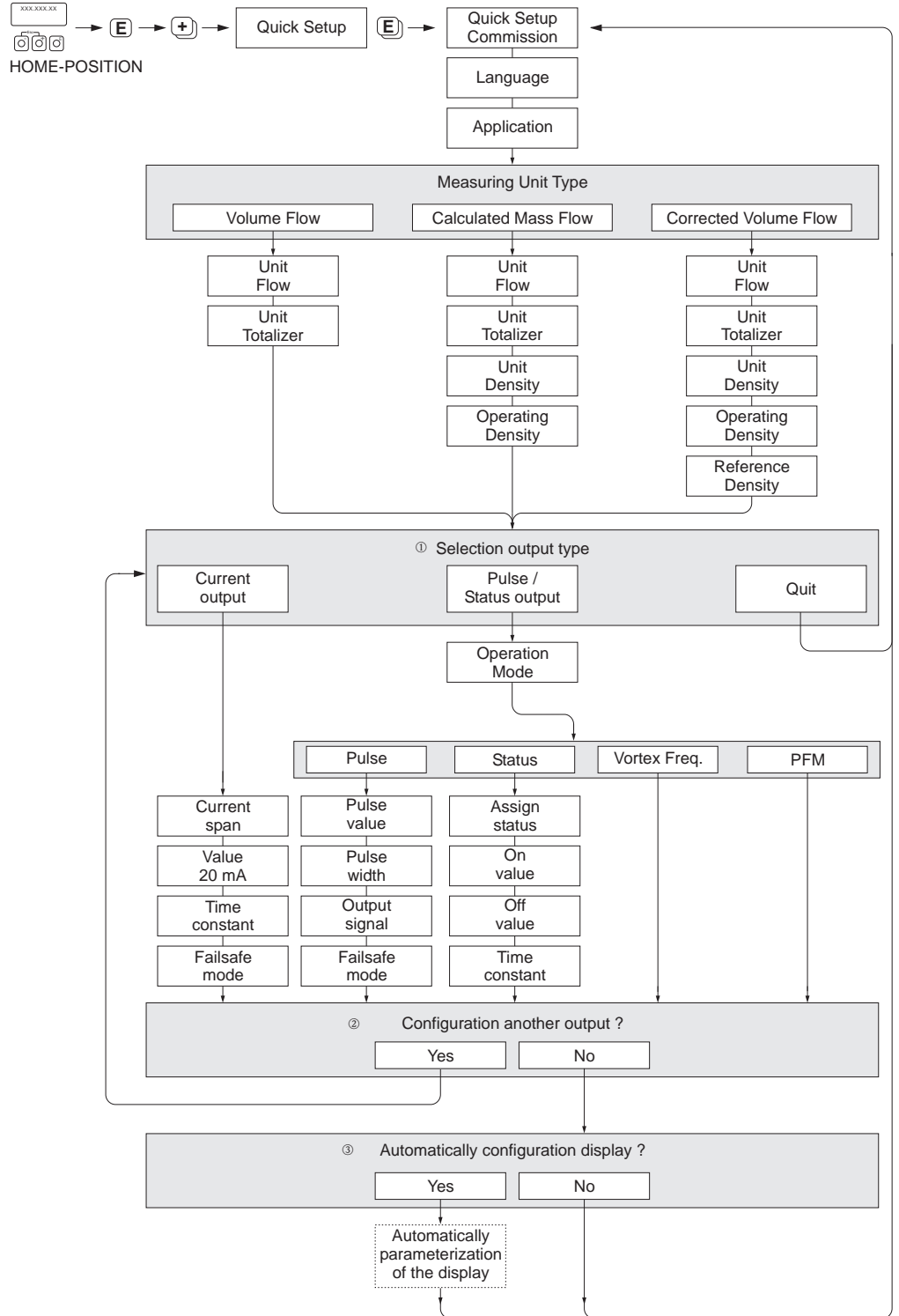

A0003394-en

**Note!**

- The individual functions are described in the "Description of Device Functions" section (→ [75](#)).
 - The display returns to the QUICK SETUP COMMISSIONING cell (→ [82](#)) if you press the  key combination (Esc) during parameter interrogation.
-
- ① Only the output (current output or pulse/status output) not yet configured in the current Quick Setup is offered for selection after the first cycle.
 - ② The "YES" option appears as long as a free output is available. "NO" is displayed when no further outputs are available.
 - ③ When "YES" is selected, the flow is assigned to line 1 of the local display and the totalizer to line 2.

Table of contents

1	Safety instructions	7		
1.1	Designated use	7		
1.2	Installation, commissioning and operation	7		
1.3	Operational safety	7		
1.4	Return	8		
1.5	Notes on safety conventions and icons	8		
2	Identification	9		
2.1	Device designation	9		
2.1.1	Nameplate of the transmitter and sensor	9		
2.1.2	Sensor nameplate (remote)	10		
2.1.3	Service nameplate	10		
2.2	Certificates and approvals	11		
2.3	Registered trademarks	11		
3	Installation	12		
3.1	Incoming acceptance, transport, storage	12		
3.1.1	Incoming acceptance	12		
3.1.2	Transport	12		
3.1.3	Storage	12		
3.2	Installation conditions	13		
3.2.1	Dimensions	13		
3.2.2	Installation location	13		
3.2.3	Orientation	14		
3.2.4	Heat insulation	15		
3.2.5	Inlet and outlet run	16		
3.2.6	Vibrations	17		
3.2.7	Limiting flow	17		
3.3	Installation	18		
3.3.1	Mounting the sensor	18		
3.3.2	Rotating the transmitter housing	19		
3.3.3	Rotating the local display	19		
3.3.4	Mounting the transmitter (remote)	20		
3.4	Post-installation check	20		
4	Wiring	21		
4.1	Connecting the remote version	21		
4.1.1	Connecting the sensor	21		
4.1.2	Cable specification, standard connecting cable	22		
4.1.3	Cable specification, armored connecting cable	22		
4.2	Connecting the measuring unit	22		
4.2.1	Connecting the transmitter	22		
4.2.2	Terminal assignment	24		
4.2.3	Connecting HART	25		
4.3	Degree of protection	26		
4.4	Post-connection check	26		
5	Operation	27		
5.1	Display and operating elements	27		
5.2	The function matrix: layout and use	28		
5.2.1	General notes	29		
5.2.2	Enabling the programming mode	29		
5.2.3	Disabling the programming mode	29		
5.3	Error messages	30		
5.3.1	Type of error	30		
5.3.2	Types of error message	30		
5.4	Communication	31		
5.4.1	Operating options	31		
5.4.2	Current device description files	32		
5.4.3	Device variables and process variables	32		
5.4.4	Universal/common practice HART commands	33		
5.4.5	Device status / error messages	37		
5.4.6	Switching HART write protection on/off	38		
6	Commissioning	39		
6.1	Function check	39		
6.2	Switching on the measuring device	39		
6.3	Commissioning after installing a new electronics board	40		
6.3.1	"Commissioning" setup	40		
6.4	"Commissioning" Quick Setup	41		
7	Maintenance	43		
7.1	Exterior cleaning	43		
7.2	Pipe cleaning	43		
7.3	Replacing seals	43		
7.3.1	Replacing sensor seals	43		
7.3.2	Replacing housing seals	43		
8	Accessories	44		
8.1	Device-specific accessories	44		
8.2	Measuring principle-specific accessories	44		
8.3	Communication-specific accessories	46		
8.4	Service-specific accessories	46		
9	Troubleshooting	47		
9.1	Troubleshooting instructions	47		
9.2	System error messages	48		
9.3	Process error messages	50		
9.4	Process errors without messages	50		
9.5	Response of outputs to errors	52		
9.6	Spare parts	53		
9.6.1	Installing and removing electronics boards	54		
9.7	Return	58		
9.8	Disposal	58		
9.9	Software history	58		
10	Technical data	59		
10.1	Technical data at a glance	59		
10.1.1	Application	59		
10.1.2	Function and system design	59		
10.1.3	Input	59		
10.1.4	Output	60		

10.1.5	Power supply	62
10.1.6	Performance characteristics	62
10.1.7	Operating conditions: installation	63
10.1.8	Operating conditions: environment	63
10.1.9	Operating conditions: process	64
10.1.10	Frequency ranges for air and water	67
10.1.11	Mechanical construction	69
10.1.12	Human interface	70
10.1.13	Certificates and approvals	71
10.1.14	Ordering information	72
10.1.15	Accessories	72
10.1.16	Documentation	72
10.2	Dimensions of flow conditioner	73
11	Description of device functions	75
11.1	Illustration of the function matrix	75
11.2	MEASURED VALUES	77
11.3	SYSTEM UNITS	78
11.4	QUICK SETUP	82
11.5	OPERATION	83
11.6	USER INTERFACE	85
11.7	TOTALIZER	87
11.8	CURRENT OUTPUT	89
11.9	PULSE/STATUS OUTPUT	91
11.10	Information on the response of the status output	99
11.11	COMMUNICATION	101
11.12	PROCESS PARAMETER	102
11.13	SYSTEM PARAMETER	106
11.14	SENSOR DATA	107
11.15	SUPERVISION	109
11.16	SIMULATION SYSTEM	111
11.17	SENSOR VERSION	112
11.18	AMPLIFIER VERSION	112
12	Factory settings	113
12.1	SI units (not for USA and Canada)	113
12.1.1	Units of length and temperature	113
12.1.2	Language	113
12.1.3	100% value line 1 and line 2	113
12.1.4	Unit totalizer	114
12.1.5	Switch-on point and switch-off point for Prowirl W	114
12.1.6	Switch-on point and switch-off point for Prowirl F	114
12.2	US units (only for USA and Canada)	115
12.2.1	Units of length and temperature	115
12.2.2	Language	115
12.2.3	100% value line 1 and line 2	115
12.2.4	Unit totalizer	115
12.2.5	Switch-on point and switch-off point for Prowirl W	116
12.2.6	Switch-on point and switch-off point for Prowirl F	116
Index		117

1 Safety instructions

1.1 Designated use

The measuring system is used to measure the volume flow of saturated steam, superheated steam, gases and liquids. If the process pressure and process temperature are constant, the measuring device can also output the flow as a calculated mass flow or corrected volume flow.

In the event of incorrect use or use other than that designated, the operational safety of the measuring devices can be suspended. The manufacturer accepts no liability for damage arising as a result.

1.2 Installation, commissioning and operation

Note the following points:

- Assembly, electrical installation, commissioning and maintenance of the device must be carried out by trained, qualified specialists authorized to perform such work by the facility's owner-operator. The specialist must have read and understood these Operating Instructions and must follow the instructions they contain.
- The device must be operated by persons authorized and trained by the facility's owner-operator. Strict compliance with the instructions in these Operating Instructions is mandatory.
- In the case of special fluids (incl. fluids for cleaning), Endress+Hauser will be happy to assist in clarifying the corrosion resistance properties of wetted materials. However, small changes in temperature, concentration or the degree of contamination in the process can result in changes to the corrosion resistance properties. Unsuitable material can lead to leakage of corrosive process media and injure personnel and/or cause damage in the plant. Therefore, Endress+Hauser cannot guarantee or accept liability for the corrosion resistance properties of wetted materials in a specific application. The user is responsible for choosing suitable wetted materials in the process.
- If carrying out welding work on the piping, the welding unit may not be grounded by means of the measuring device.
- The installer must ensure that the measuring system is correctly wired in accordance with the wiring diagrams.
- Always observe the regulations applicable in your country governing the operation, maintenance and repair of electrical devices. Special instructions relating to the device can be found in the relevant sections of this documentation.

1.3 Operational safety

Note the following points:

- Measuring systems for use in hazardous environments are accompanied by separate "Ex documentation", which is an integral part of these Operating Instructions. Strict compliance with the installation instructions and ratings as stated in this supplementary documentation is mandatory.
The symbol on the front of the Ex documentation indicates the approval and the certification center (Ⓔ Europe, Ⓕ USA, Ⓖ Canada).
- The measuring system complies with the general safety requirements in accordance with EN 61010-1 and the EMC requirements of IEC/EN 61326 and NAMUR Recommendations NE 21, NE 43 and NE 53.
- For measuring systems used in SIL 2 applications, the separate manual on functional safety must be observed.
- The manufacturer reserves the right to modify technical data without prior notice. Your Endress+Hauser distributor will supply you with current information and updates to these Operating Instructions.

1.4 Return

The following procedures must be carried out before a flowmeter requiring repair or calibration, for example, is returned to Endress+Hauser:

- Always enclose a fully completed "Declaration of Contamination" form with the device. Only then can Endress+Hauser transport, examine and repair a returned device.
- Enclose special handling instructions if necessary, for example a safety data sheet as per Regulation (EC) No 1907/2006 REACH.
- Remove all fluid residues. Pay special attention to the grooves for seals and crevices which could contain residues.
This is particularly important if the fluid is hazardous to health, e.g. flammable, toxic, caustic, carcinogenic.



Note!

You will find a *master copy* of the "Declaration of Contamination" form at the back of this manual.



Warning!

- Do not return a measuring device if you are not absolutely certain that all traces of hazardous substances have been removed, e.g. substances which have penetrated crevices or diffused through plastic.
- Costs incurred for waste disposal and injury (caustic burns, etc.) due to inadequate cleaning will be charged to the owner-operator.

1.5 Notes on safety conventions and icons

The devices are designed to meet state-of-the-art safety requirements, have been tested, and left the factory in a condition in which they are safe to operate. The devices comply with the applicable standards and regulations in accordance with EN 61010-1 "Safety requirements for electrical equipment for measurement, control and laboratory use". The devices can, however, be a source of danger if used incorrectly or for anything other than their designated use.

Consequently, always pay particular attention to the safety instructions indicated in these Operating Instructions by the following symbols:



Warning!

"Warning" indicates an action or procedure which, if not performed correctly, can result in injury or a safety hazard. Comply strictly with the instructions and proceed with care.



Caution!

"Caution" indicates an action or procedure which, if not performed correctly, can result in the incorrect operation or destruction of the device. Comply strictly with the instructions.



Note!

"Note" indicates an action or procedure which, if not performed correctly, can have an indirect effect on operation or trigger an unexpected response on the part of the device.

2 Identification

2.1 Device designation

The "Proline Prowirl 72" flow measuring system consists of the following components:

- Proline Prowirl 72 transmitter
- Prowirl F or Prowirl W sensor

Two versions are available:

- *Compact version*: transmitter and sensor form a single mechanical unit.
- *Remote version*: sensor is mounted separate from the transmitter.

2.1.1 Nameplate of the transmitter and sensor

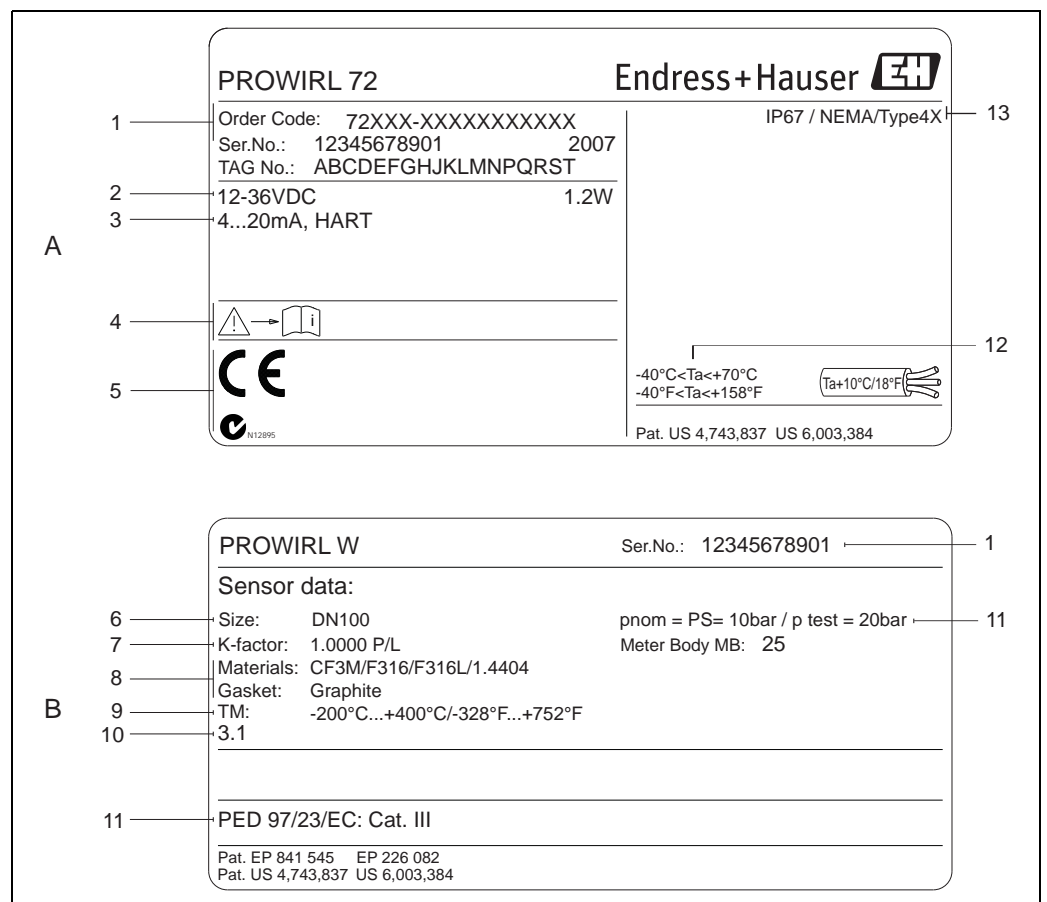

Fig. 1: Nameplate specifications for transmitter and sensor (example)
 A = nameplate on transmitter, B = nameplate on sensor (only compact version)

- 1 Order code/serial number: see the specifications on the order confirmation for the meanings of the individual letters and digits
- 2 Power supply: 12 to 36 V DC, power consumption: 1.2 W
- 3 Available outputs: Current output 4 to 20 mA
- 4 Observe device documentation
- 5 Reserved for certificates, approvals and additional information on the device version
- 6 Nominal diameter
- 7 Calibration factor
- 8 Material of measuring tube and seal
- 9 Fluid temperature range
- 10 Reserved for information on special products
- 11 Data regarding Pressure Equipment Directive (optional)
- 12 Permitted ambient temperature range
- 13 Degree of protection

2.1.2 Sensor nameplate (remote)

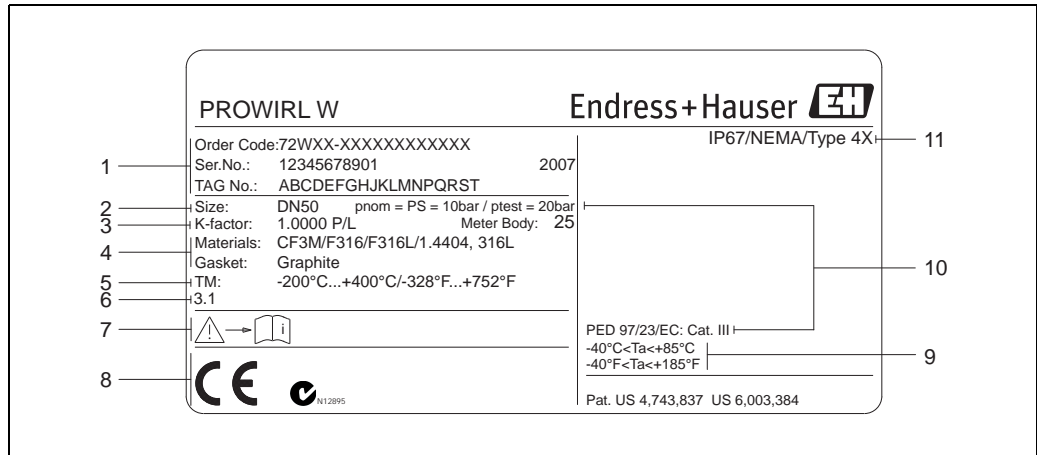

Fig. 2: Nameplate specifications for remote sensor version (example)

- 1 Order code/serial number: see the specifications on the order confirmation for the meanings of the individual letters and digits.
- 2 Nominal diameter
- 3 Calibration factor
- 4 Material of measuring tube and seal
- 5 Fluid temperature range
- 6 Reserved for information on special products
- 7 Observe device documentation
- 8 Reserved for certificates, approvals and additional information on the device version
- 9 Permitted ambient temperature range
- 10 Data regarding Pressure Equipment Directive (optional)
- 11 Degree of protection

2.1.3 Service nameplate

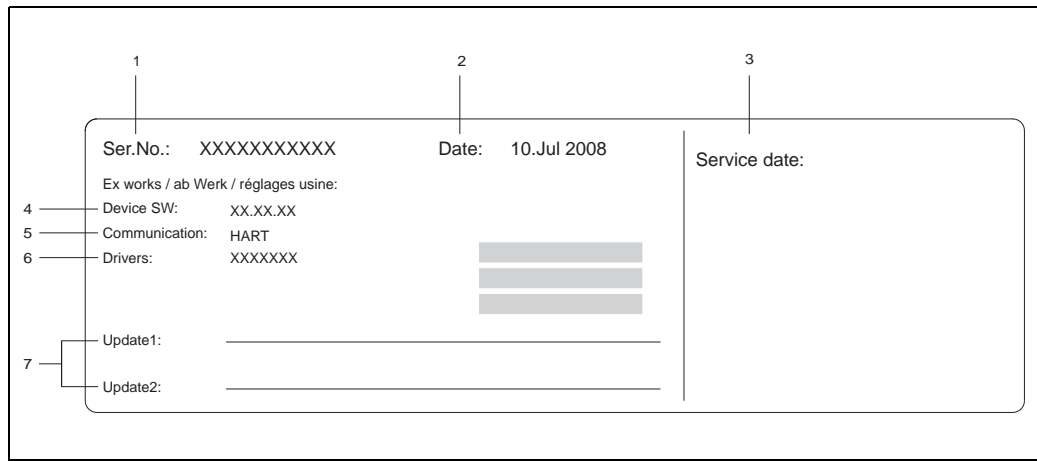

Fig. 3: Service nameplate specifications for transmitter (example)

- 1 Serial number
- 2 Date of manufacturing
- 3 Service date
- 4 Device software
- 5 Type of device communication (e.g. HART)
- 6 Version of device software currently installed
- 7 Space for update entries

2.2 Certificates and approvals

The devices are designed in accordance with good engineering practice to meet state-of-the-art safety requirements, have been tested, and left the factory in a condition in which they are safe to operate. The devices comply with the applicable standards and regulations in accordance with EN 61010-1 "Safety requirements for electrical equipment for measurement, control and laboratory use" and the EMC requirements as per IEC/EN 61326.

The measuring system described in these Operating Instructions thus complies with the statutory requirements of the EC Directives. Endress+Hauser confirms successful testing of the device by affixing to it the CE mark and issuing the CE Declaration of Conformity.

The measuring system meets the EMC requirements of the "Australian Communications and Media Authority (ACMA)".

2.3 Registered trademarks

GYLON®

Registered trademark of Garlock Sealing Technologies, Palmyra, NY, USA

HART®

Registered trademark of the HART Communication Foundation, Austin, USA

INCONEL®

Registered trademark of Inco Alloys International Inc., Huntington, USA

KALREZ® and VITON®

Registered trademarks of E.I. Du Pont de Nemours & Co., Wilmington, USA

Applicator®, FieldCare®, Fieldcheck®, Field Xpert™

Registered or registration-pending trademarks of Endress+Hauser Flowtec AG, Reinach, CH

3 Installation

3.1 Incoming acceptance, transport, storage

3.1.1 Incoming acceptance

On receipt of the goods, check the following points:

- Check the packaging and the contents for damage.
- Check the shipment, make sure nothing is missing and that the scope of supply matches your order.

3.1.2 Transport

Please note the following when unpacking or transporting to the measuring point:

- The devices must be transported in the container supplied.
- Devices with nominal diameters DN 40 to 300 (1½ to 12") may not be lifted at the transmitter housing or at the connection housing of the remote version when transporting (→  4). Use carrier slings when transporting and put the slings around both process connections. Avoid chains as these could damage the housing.



Warning!

Risk of injury if the measuring device slips.

The center of gravity of the entire measuring device might be higher than the points around which the slings are slung.

Therefore, when transporting, make sure that the device does not unintentionally turn or slip.

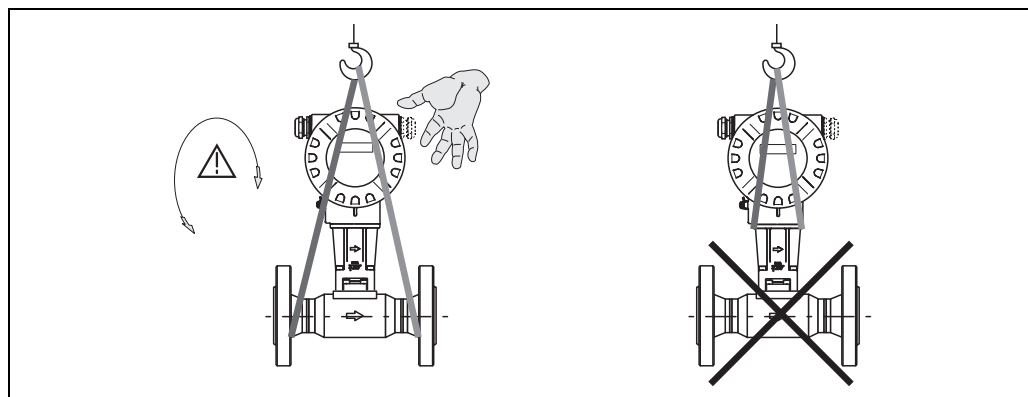

Fig. 4: Instructions for transporting sensors with DN 40 to 300 (1½ to 12")

3.1.3 Storage

Note the following points:

- Pack the measuring device in such a way as to protect it reliably against impact for storage (and transportation). The original packaging provides optimum protection.
- The permissible storage temperature is:
 - Standard: –40 to +80 °C (–40 to +176 °F)
 - ATEX II 1/2 GD version/dust ignition-proof: –20 to +55 °C (–4 to +131 °F)
- Protect the measuring device against direct sunlight during storage in order to avoid unacceptably high surface temperatures.

3.2 Installation conditions

Note the following points:

- The measuring device requires a fully developed flow profile as a prerequisite for correct volume flow measurement. The inlet and outlet runs therefore have to be taken into account (→ § 16).
- The maximum permitted ambient temperatures (→ § 63) and fluid temperatures (→ § 64) must be observed.
- Pay particular attention to the notes on orientation and piping insulation (→ § 14).
- Verify that the correct nominal diameter and pipe standard (DIN/JIS/ANSI) were taken into account when ordering since the calibration of the device and the achievable accuracy depend on these factors. If the mating pipe and the device have different nominal diameters/pipe standards, an inlet correction can be made via the device software by entering the actual pipe diameter (→ § 104, MATING PIPE DIAMETER function).
- The correct operation of the measuring system is not influenced by plant vibrations up to 1 g, 10 to 500 Hz.
- For mechanical reasons, and in order to protect the piping, it is advisable to support heavy sensors.

3.2.1 Dimensions

All the dimensions and lengths of the sensor and transmitter are provided in the separate "Technical Information" document.

3.2.2 Installation location

We recommend you observe the following dimensions to guarantee problem-free access to the device for service purposes:

- Minimum spacing (A) in all directions = 100 mm (3.94 in)
- Necessary cable length (L): $L + 150 \text{ mm}$ (5.91 in)

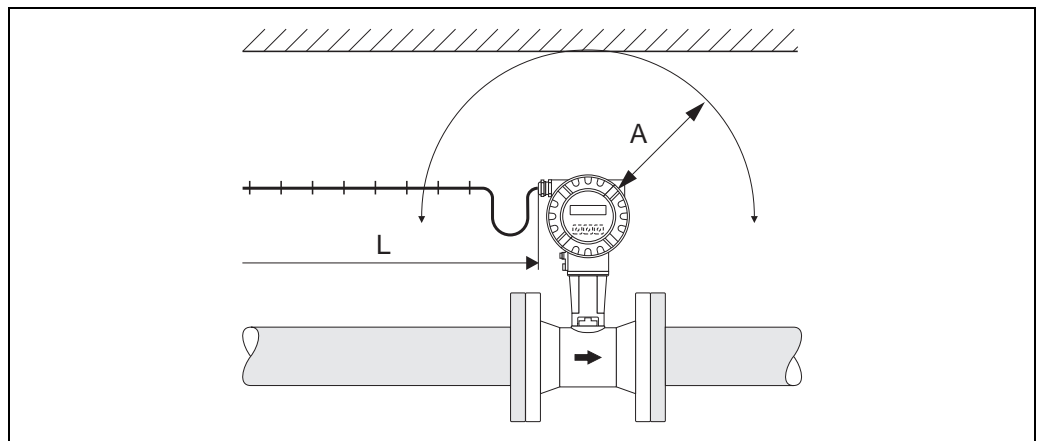

Fig. 5: Minimum spacing

- A Minimum spacing in all directions
L Cable length

3.2.3 Orientation

Make sure that the direction of the arrow on the nameplate of the sensor matches the direction of flow (direction in which the fluid flows through the pipe).

The device can basically be installed in any orientation. However, note the following points:

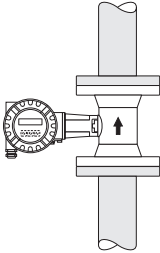
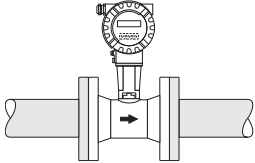
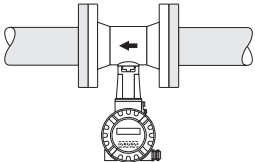
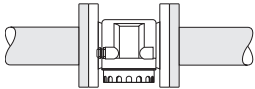
Orientation		High fluid temperature (TM) ≥ 200 °C (392 °F)	Low fluid temperature (TM)
<p>Fig. A: Vertical orientation</p>		<p>Recommended (①)</p>	<p>Recommended (①)</p>
<p>Fig. B: Horizontal orientation Transmitter head up</p>		<p>Not permitted for Prowirl 72W DN 100 (4") / DN 150 (6") (②)</p>	<p>Recommended (③)</p>
<p>Fig. C: Horizontal orientation Transmitter head down</p>		<p>Recommended (④)</p>	
<p>Fig. D: Horizontal orientation Transmitter head at front with display pointing downwards</p>		<p>Recommended (④)</p>	<p>Recommended (③)</p>

- ① In the case of liquids, there should be upward flow in vertical pipes to avoid partial pipe filling (Fig. A).
 ☞ **Caution!**
 Disruption in flow measurement!
 In case of vertical orientation and downward flowing liquid, the piping has always to be completely filled.

- ② ☞ **Caution!**
 Danger of electronics overheating!
 If fluid temperature is $\geq 200\text{ °C}$ (392 °F), orientation B is not permitted for the wafer version (Prowirl 72W) with nominal diameters DN 100 (4") and DN 150 (6").

In order to make sure that the maximum ambient temperature (\rightarrow 63) is not exceeded, we recommend the following orientations:

- ③ In the case of hot fluids (e.g. steam or fluid temperature (TM) $\geq 200\text{ °C}$ (392 °F)): orientation C or D
 ④ In the case of very cold fluids (e.g. liquid nitrogen): orientation B or D

3.2.4 Heat insulation

Some fluids require suitable measures to avoid heat transfer at the sensor. A wide range of materials can be used to provide the required insulation.

When insulating, please ensure that a sufficiently large area of the housing support is exposed. The uncovered part serves as a radiator and protects the electronics from overheating (or undercooling). The maximum insulation height permitted is illustrated in the diagrams. These apply equally to both the compact version and the sensor in the remote version.

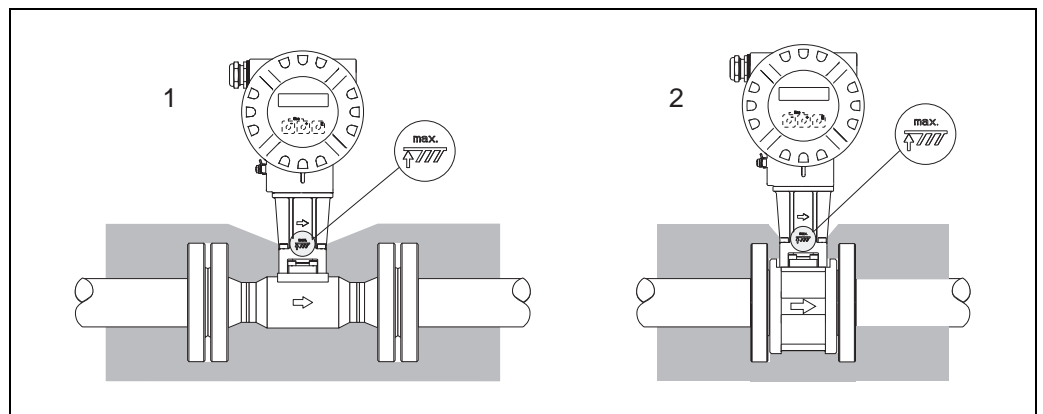

Fig. 6: 1 = Flanged version, 2 = Wafer version



Caution!

Danger of electronics overheating!

- Always keep the adapter between the sensor/transmitter and the connection housing of the remote version free of insulating material.
- Note that a certain orientation might be required, depending on the fluid temperature (\rightarrow 14).
- Observe information on the permissible temperature ranges (\rightarrow 63).

3.2.5 Inlet and outlet run

As a minimum, the inlet and outlet runs shown below must be observed to achieve the specified accuracy of the device. The longest inlet run shown must be observed if two or more flow disturbances are present.

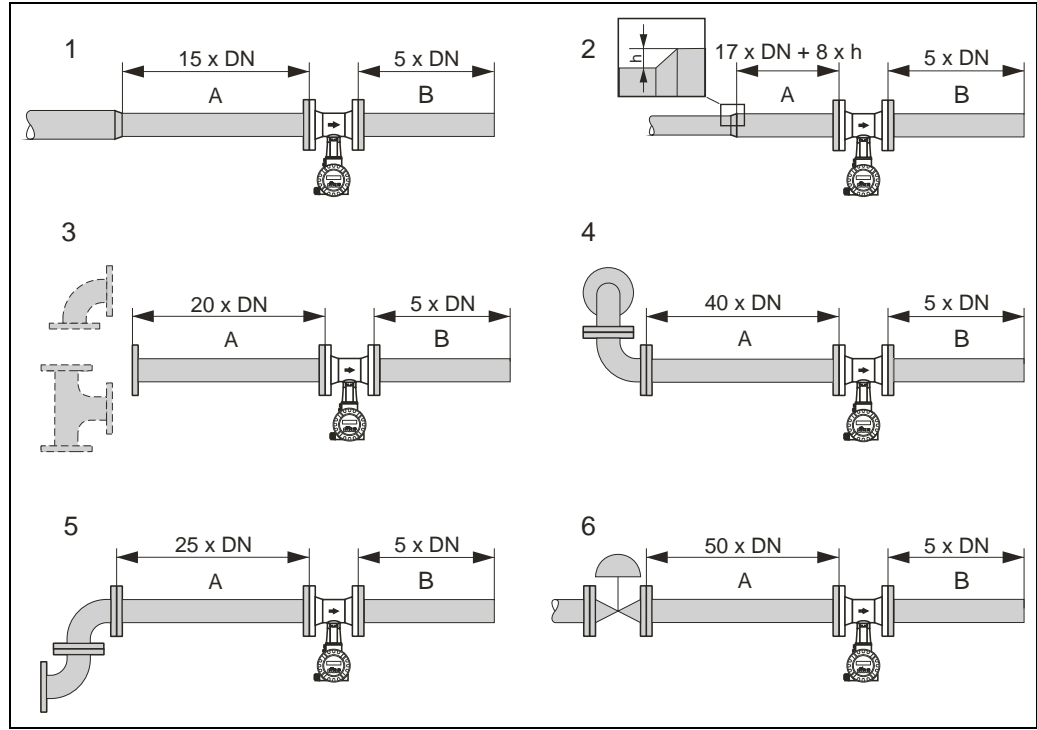

Fig. 7: Minimum inlet and outlet runs with various flow obstructions

- A Inlet run
- B Outlet run
- h Difference in expansion
- 1 Reduction
- 2 Extension
- 3 90° elbow or T-section
- 4 2 x 90° elbow 3-dimensional
- 5 2 x 90° elbow
- 6 Control valve



Note!

A specially designed perforated plate flow conditioner can be installed if it is not possible to observe the inlet runs required (→ 17).

Outlet runs with pressure and temperature measuring points

If pressure and temperature measuring points are installed after the device, please ensure there is a large enough distance between the device and the measuring point so there are no negative effects on vortex formation in the sensor.

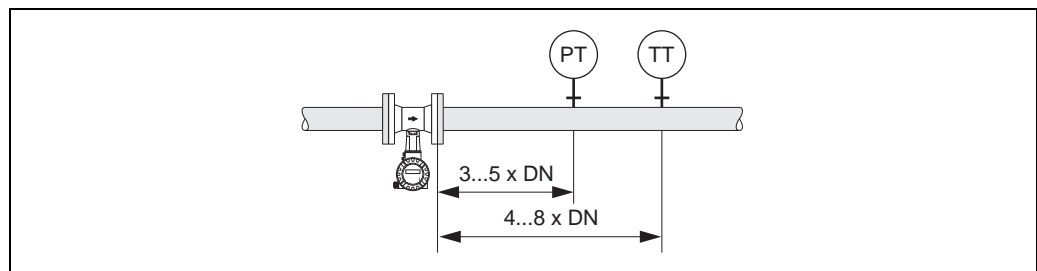

Fig. 8: Installation of pressure measuring point (PT) and temperature measuring point (TT)

Perforated plate flow conditioner

A specially designed perforated plate flow conditioner, available from Endress+Hauser, can be installed if it is not possible to observe the inlet runs required. The flow conditioner is fitted between two piping flanges and centered with mounting bolts. Generally, this reduces the inlet run required to $10 \times \text{DN}$ with complete accuracy.

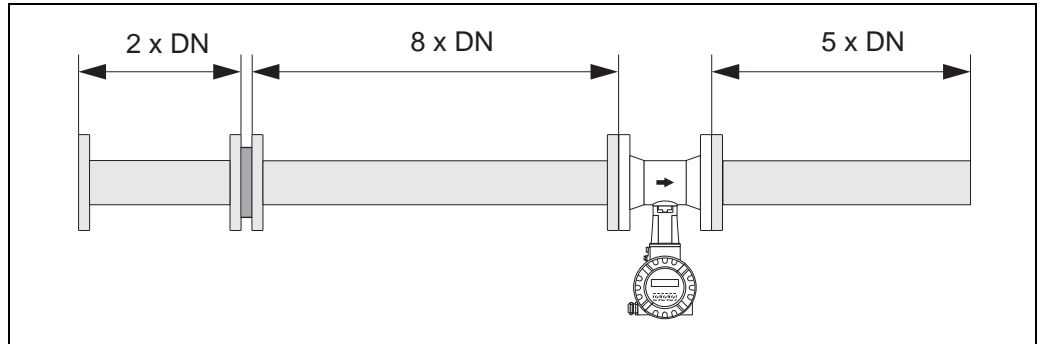

Fig. 9: Perforated plate flow conditioner

Calculation examples (SI units) for the pressure loss of flow conditioners:

The pressure loss for flow conditioners is calculated as follows:

$$\Delta p [\text{mbar}] = 0.0085 \cdot \rho [\text{kg/m}^3] \cdot v^2 [\text{m/s}]$$

■ Example with steam

$$\begin{aligned} p &= 10 \text{ bar abs} \\ t &= 240 \text{ }^\circ\text{C} \rightarrow \rho = 4.39 \text{ kg/m}^3 \\ v &= 40 \text{ m/s} \\ \Delta p &= 0.0085 \cdot 4.39 \cdot 40^2 = 59.7 \text{ mbar} \end{aligned}$$

■ Example with H₂O condensate (80 °C)

$$\begin{aligned} \rho &= 965 \text{ kg/m}^3 \\ v &= 2.5 \text{ m/s} \\ \Delta p &= 0.0085 \cdot 965 \cdot 2.5^2 = 51.3 \text{ mbar} \end{aligned}$$

ρ : density of the process medium

v : average flow velocity

3.2.6 Vibrations

The correct operation of the measuring system is not influenced by plant vibrations up to 1 g, 10 to 500 Hz. Consequently, the sensors require no special measures for attachment.

3.2.7 Limiting flow

Information on limiting flow is provided under the "Measuring range" (→ 59) and "Limiting flow" (→ 66) sections in the Technical Data chapter.

3.3 Installation

3.3.1 Mounting the sensor



Caution!

Please note the following prior to mounting:

- Prior to installing the measuring device in the piping, remove all traces of transport packaging and any protective covers from the sensor.
- Make sure that the internal diameters of seals are the same as, or greater than, those of the measuring pipe and piping. Seals projecting into the flow current have a negative effect on the vortex formation after the bluff body and cause inaccurate measurement. The seals provided by Endress+Hauser for the wafer version have therefore an inner diameter with a bigger inner diameter than the piping.
- Ensure that the arrow on the measuring pipe matches the direction of flow in the piping.
- Lengths:
 - Prowirl W (wafer version): 65 mm (2.56 in)
 - Prowirl F (flanged version) → See Technical Information TI00070D/06/EN.

Mounting Prowirl W

The centering rings supplied are used to mount and center the wafer-style devices.

A mounting kit consisting of tie rods, seals, nuts and washers can be ordered separately.

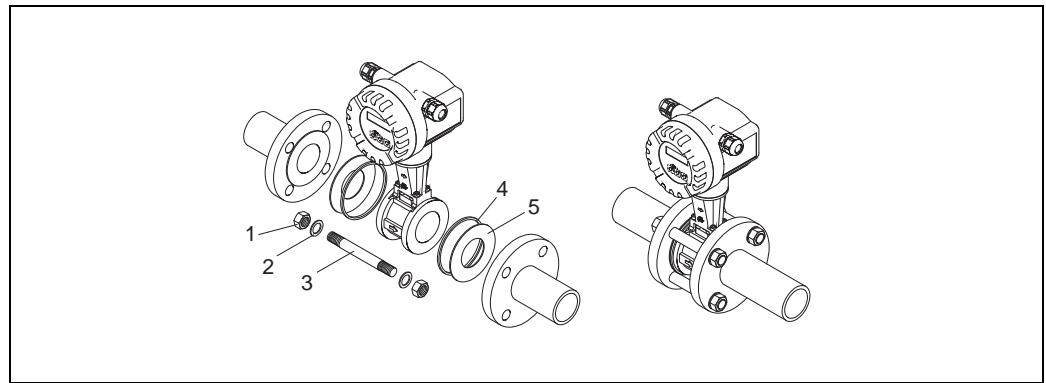

Fig. 10: Mounting the wafer version

- 1 Nut
- 2 Washer
- 3 Tie rod
- 4 Centering ring (is supplied with the device)
- 5 Seal

3.3.2 Rotating the transmitter housing

The electronics housing can be rotated continuously 360° on the housing support.

1. Release the lock screw.
2. Turn the transmitter housing to the desired position (max. 180° in each direction to the stop).



Note!

There are recesses in the rotating groove at 90° stages (only compact version). These help you align the transmitter easier.

3. Tighten the safety screw.

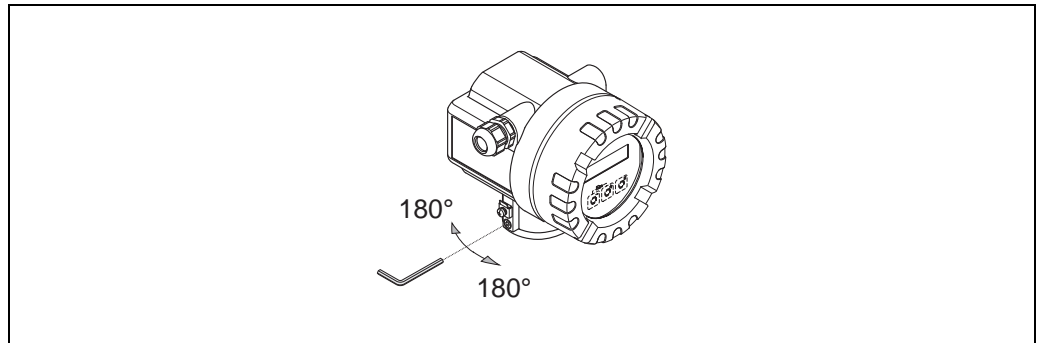

Fig. 11: Rotating the transmitter housing

3.3.3 Rotating the local display

1. Unscrew the cover of the electronics compartment from the transmitter housing.
2. Remove the display module from the transmitter retainer rails.
3. Turn the display to the desired position (max. $4 \times 45^\circ$ in each direction) and reset it onto the retaining rails.
4. Screw the cover of the electronics compartment firmly back onto the transmitter housing.

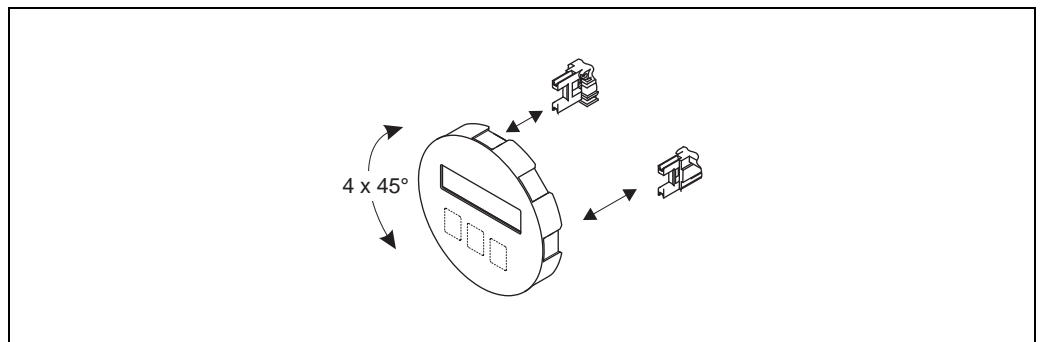

Fig. 12: Rotating the local display

3.3.4 Mounting the transmitter (remote)

The transmitter can be mounted in the following ways:

- Wall mounting
- Pipe mounting (with separate mounting kit, accessories → 44)

The transmitter and the sensor must be mounted separate in the following circumstances:

- Poor accessibility,
- lack of space,
- extreme ambient temperatures.



Caution!

Danger of electronics overheating!

If the device is mounted to warm piping, make certain that the housing temperature does not exceed the max. permissible temperature value.

- Standard: -40 to +80 °C (-40 to +176 °F)
- EEx-d version: -40 to +60 °C (-40 to +140 °F)
- ATEX II 1/2 GD version/dust ignition-proof: -20 to +55 °C (-4 to +131 °F)

Mount the transmitter as illustrated in the diagram.

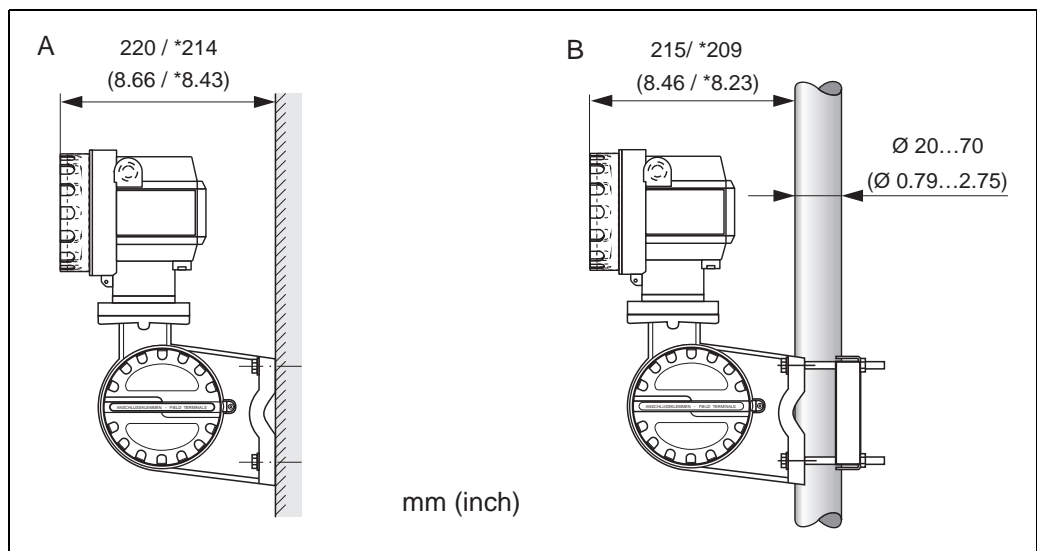

Fig. 13: Mounting the transmitter (remote version)

A Direct wall mounting

B Pipe mounting

* Dimensions for version without local operation

3.4 Post-installation check

Perform the following checks after installing the measuring device in the piping:

Device condition and specifications	Notes
Is the device damaged (visual inspection)?	–
Do the process temperature/pressure, ambient temperature, measuring range etc. correspond to the specifications of the device?	→ 59
Installation	Notes
Does the arrow on the pipe or on the sensor match the direction of flow through the pipe?	–
Are the measuring point number and labeling correct (visual inspection)?	–
Is the orientation chosen for the sensor correct, in other words suitable for sensor type, fluid properties (outgassing, with entrained solids) and fluid temperature?	→ 13
Process environment / process conditions	Notes
Is the measuring device protected against moisture and direct sunlight?	–

4 Wiring



Warning!

When connecting Ex-certified devices, please refer to the notes and diagrams in the Ex-specific supplement to these Operating Instructions.

Please do not hesitate to contact your Endress+Hauser representative if you have any questions.

4.1 Connecting the remote version

4.1.1 Connecting the sensor



Caution!

Risk of damaging the electronic components!

- Ground the remote version. In doing so, connect the sensor and transmitter to the same potential matching.
- When using the remote version, only connect the sensor to the transmitter with the same serial number.

1. Remove the cover of the connection compartment of the transmitter (a).
2. Remove the cover of the connection compartment of the sensor (b).
3. Feed the connecting cable (c) through the appropriate cable entries.
4. Wire the connecting cable between the sensor and transmitter in accordance with the electrical connection diagram →  14, wiring diagram in screw cap.
5. Tighten the glands of the cable entries on the sensor housing and transmitter housing.
6. Screw the cover of the connection compartment (a/b) back onto the sensor housing or transmitter housing.

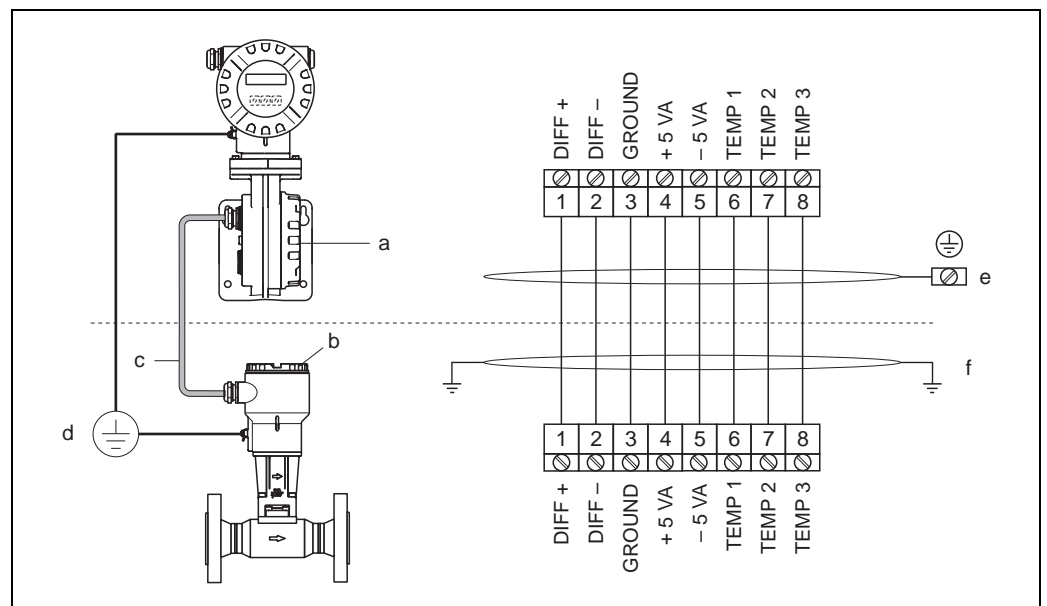

Fig. 14: Connecting the remote version

- a Connection compartment cover (transmitter)
- b Connection compartment cover (sensor)
- c Connecting cable (signal cable)
- d Identical potential matching for sensor and transmitter
- e Connect shielding to ground terminal in transmitter housing and keep as short as possible
- f Connect shielding to cable strain relief clamp in connection housing

Wire colors (color code in accordance with DIN 47100):

Terminal No.: 1 = white; 2 = brown; 3 = green; 4 = yellow; 5 = gray; 6 = pink; 7 = blue; 8 = red

4.1.2 Cable specification, standard connecting cable

The specifications of the cable connecting the transmitter and the sensor of the remote version are as follows:

- $4 \times 2 \times 0.5 \text{ mm}^2$ (AWG 20) PVC cable with common screen (4 pairs)
- Conductor resistance according to DIN VDE 0295 class 5 or IEC 60228 class 5: $39 \text{ } \Omega/\text{km}$
- Capacity core/screen: $< 400 \text{ pF/m}$ (122 pF/ft)
- Cable length: max. 30 m (98 ft)
- Operating temperature: -40 to $+105 \text{ } ^\circ\text{C}$ (-40 to $+221 \text{ } ^\circ\text{F}$)

4.1.3 Cable specification, armored connecting cable

The optionally available armored connecting cable between transmitter and sensor possesses the following specifications:

- $4 \times 2 \times 0.5 \text{ mm}^2$ (AWG 20) PVC cable with common screen (4 pairs)
- Conductor resistance according to DIN VDE 0295 class 5 or IEC 60228 class 5: $39 \text{ } \Omega/\text{km}$
- Extensively resistant against acids, bases and specific oils
- A galvanized braided steel wire forms the total shield
- Outer sheath: smooth, uniform, round
- Cable length: max. 30 m (98 ft)
- Operating temperature: -30 to $+70 \text{ } ^\circ\text{C}$ (-22 to $+158 \text{ } ^\circ\text{F}$)

4.2 Connecting the measuring unit

4.2.1 Connecting the transmitter



Warning!



- When connecting Ex-certified devices, please refer to the notes and diagrams in the Ex-specific supplement to these Operating Instructions.
- Ground the remote version. In doing so, connect the sensor and transmitter to the same potential matching.



Note!

- Observe national regulations governing the installation of electrical equipment.

Connecting the transmitter, non-Ex, Ex-i and Ex-n version (→ 15)

1. Unscrew the cover (a) of the electronics compartment from the transmitter housing.
2. Remove the display module (b) from the retaining rails (c) and refit onto the right retaining rail with the left side. This secures the display module.
3. Loosen the screws of the cover of the connection compartment (d) and fold down the cover.
4. Push the cable for the power supply/current output through the cable gland (e).
Optional: push the cable for the pulse output through the cable gland (f).
5. Tighten the cable glands (e / f) (→  26).
6. Pull the terminal connector (g) out of the transmitter housing and connect the cable for the power supply/current output (→  17).
Optional: pull the terminal connector (h) out of the transmitter housing and connect the cable for the pulse output (→  17).



Note!

The terminal connectors (g / h) are pluggable, i.e. they can be plugged out of the transmitter housing to connect the cables.

7. Plug the terminal connectors (g / h) into the transmitter housing.



Note!

The connectors are coded so you cannot mix them up.

8. Fold up the cover of the connection compartment and tighten the screws (d).

9. Remove the display module (b) and fit onto the retaining rails (c).
10. Screw the cover of the electronics compartment (a) onto the transmitter housing.
11. Only remote version: Secure the ground cable to the ground terminal (see →  17, C).

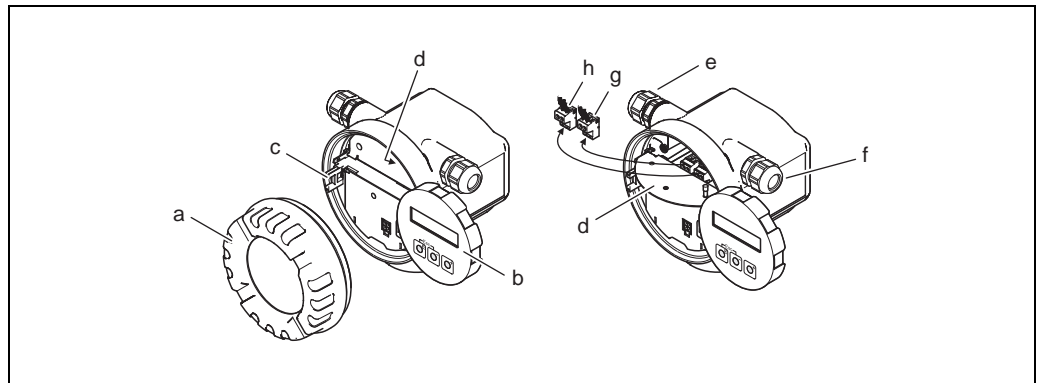

Fig. 15: Procedure for connecting the transmitter Non-Ex, Ex-i and Ex-n version

- a Cover of electronics compartment
- b Display module
- c Retaining rail for display module
- d Cover of connection compartment
- e Cable gland for power supply/current output cable
- f Cable gland for pulse output cable (optional)
- g Terminal connector for power supply/current output
- h Terminal connector for pulse output (optional)

Procedure for connecting the transmitter, Ex-d version (→ 16)





Warning!

When connecting Ex-certified devices, please refer to the notes and diagrams in the Ex-specific supplement to these Operating Instructions.

1. Open the clamp (a) securing the cover of the connection compartment.
2. Unscrew the cover (b) of the connection compartment from the transmitter housing.
3. Push the cable for the power supply/current output through the cable gland (c).
Optional: push the cable for the pulse output through the cable gland (d).

Note!

Devices with a TIIS approval are equipped in general with one cable gland only.

4. Tighten the cable glands (c / d) (→  26).
5. Pull the terminal connector (e) out of the transmitter housing and connect the cable for the power supply/current output (→  17).
Optional: pull the terminal connector (f) out of the transmitter housing and connect the cable for the pulse output (→  17).

Note!

The terminal connectors (e / f) are pluggable, i.e. they can be plugged out of the transmitter housing to connect the cables.

6. Plug the terminal connectors (e / f) into the transmitter housing.

Note!

The connectors are coded so you cannot mix them up.

7. Screw the cover (b) of the connection compartment onto the transmitter housing.
8. Tighten the clamp (a) securing the cover of the connection compartment.
9. Only remote version: secure the ground cable to the ground terminal (→  17, C).

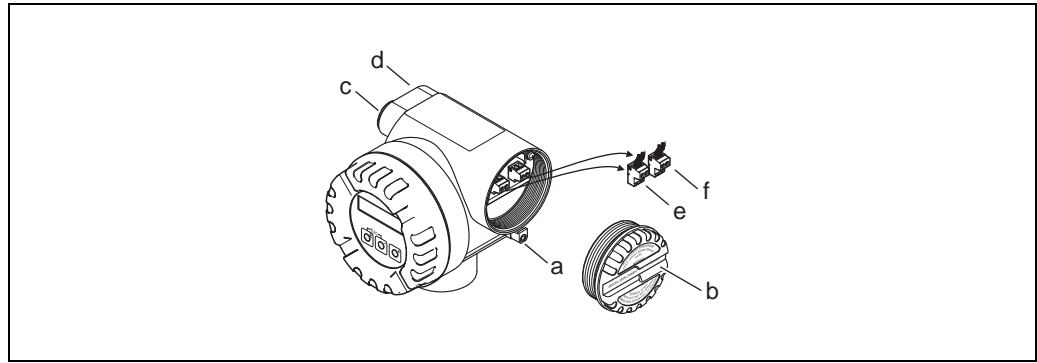

A0001896

Fig. 16: Procedure for connecting the transmitter Ex-d version

- a Clamp securing cover of connection compartment
- b Cover of connection compartment
- c Cable gland for power supply/current output cable
- d Cable gland for pulse output cable (optional)
- e Terminal connector for power supply/current output
- f Terminal connector for pulse output (optional)

Wiring diagram

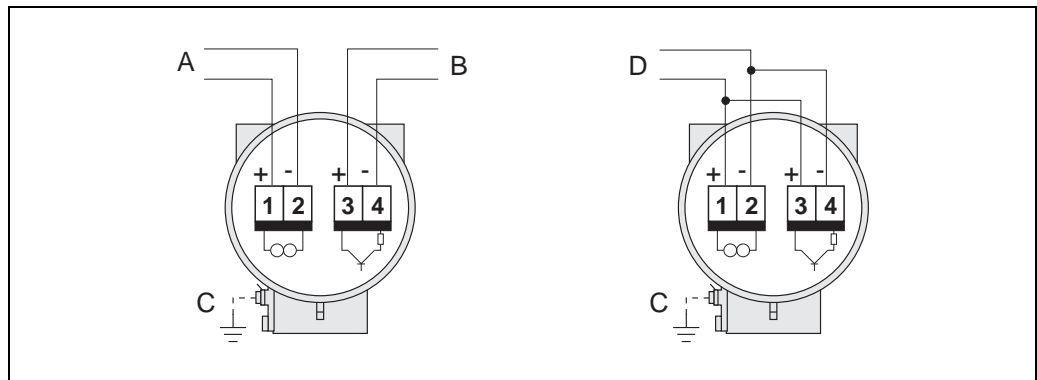

A0003392

Fig. 17: Assignment of terminals

- A Power supply/current output
- B Optional pulse/status output
- C Ground terminal (only relevant for remote version)
- D PFM wiring (pulse/frequency modulation)

4.2.2 Terminal assignment

Order variant	Terminal No. (inputs/outputs)	
	1-2	3-4
72***_*****W	HART current output	-
72***_*****A	HART current output	Pulse/status output
HART current output Galvanically isolated, 4 to 20 mA with HART Pulse/status output Open collector, passive, galvanically isolated, $U_{max} = 30\text{ V}$, with 15 mA current limiting, $R_i = 500\ \Omega$, can be configured as pulse or status output		

4.2.3 Connecting HART

Users have the following connection options at their disposal:

- Direct connection to transmitter by means of terminals 1 (+) / 2 (-)
- Connection across the 4 to 20 mA circuit.



Note!

- The measuring circuit's minimum load must be at least 250 Ω .
- For the connection, also refer to the documentation issued by the HART Communication Foundation, and in particular HCF LIT 20: "HART, a technical summary".

1. After commissioning: Switch HART write protection on or off (→ 38).

Connecting the HART handheld terminal

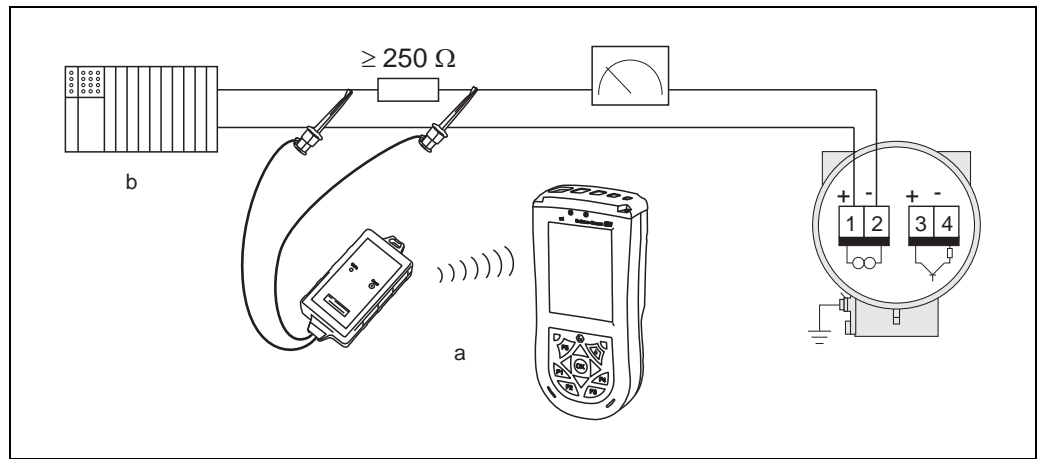

Fig. 18: Electrical connection of the HART handheld terminal Field Xpert SFX100

- a HART handheld terminal Field Xpert SFX100
- b Additional switching units or PLC with transmitter power supply

Connecting the PC with the operating software

A HART modem (e.g. "Commubox FXA195") is required for connecting a PC with operating software (e.g. "FieldCare").

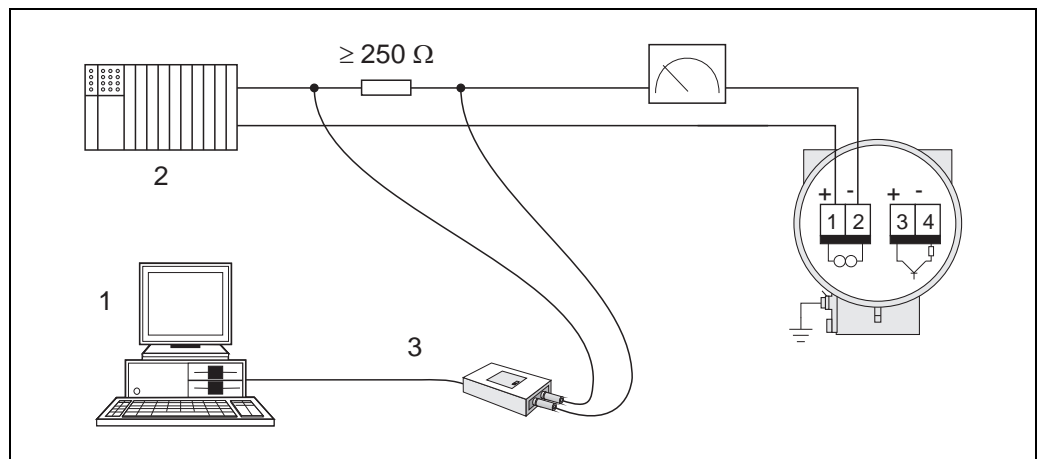

Fig. 19: Electrical connection of a PC with operating software

- 1 PC with operating software
- 2 Additional switching units or PLC with passive input
- 3 HART modem, e.g. Commubox FXA195

4.3 Degree of protection

The devices fulfill all the requirements for IP 67 (NEMA 4X) degree of protection.

Compliance with the following points is mandatory following installation in the field or servicing in order to ensure that IP 67 (NEMA 4X) protection is maintained:

- The housing seals must be clean and undamaged when inserted into their grooves. Dry, clean or replace the seals if necessary. If the device is used in a dust atmosphere, only use the associated Endress+Hauser housing seals.
- All housing screws and screw caps must be firmly tightened.
- The cables used for connection must be of the specified outside diameter (→ 62, cable entries).
- Tighten the cable glands to ensure they are leak-tight (Point **a** → 20).
- To prevent moisture from penetrating the entry (Point **b** → 20), the cables must form a loop hanging downwards ("water trap") upstream from the cable entry.
- Install the measuring device in such a way that the cable entries do not point upwards.
- Remove all unused cable entries and insert plugs instead.
- Do not remove the grommet from the cable entry.

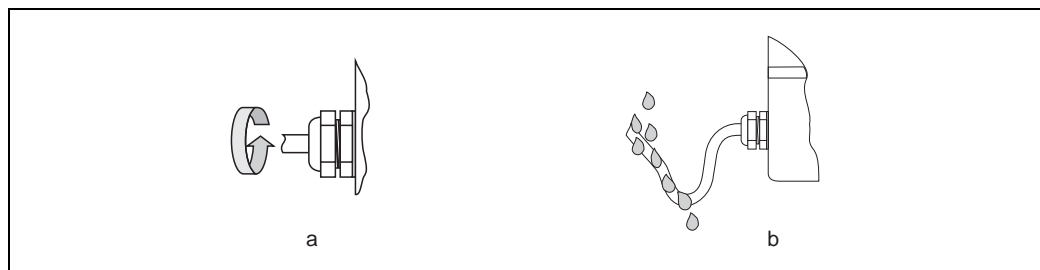

Fig. 20: Installation instructions for cable entries

4.4 Post-connection check

Perform the following checks after completing electrical installation of the measuring device:

Device condition and specifications	Notes
Are cables or the device damaged (visual inspection)?	–
Electrical connection	Notes
Does the supply voltage match the specifications on the nameplate? Non-Ex: 12 to 36 V DC (with HART: 18 to 36 V DC) Ex-i and Ex-n: 12 to 30 V DC (with HART 18 to 30 V DC) Ex-d: 15 to 36 V DC (with HART 21 to 36 V DC)	–
Do the cables used comply with the specifications?	→ 22, → 62
Do the cables have adequate strain relief?	–
Are the cables for power supply/current output, frequency output (optional) and grounding connected correctly?	→ 22
Only remote version: is the connecting cable between sensor and transmitter connected correctly?	→ 21
Are all terminals firmly tightened?	–
Are all the cable entries installed, tightened and sealed? Cable run with "water trap"?	→ 26
Are all the housing covers installed and tightened?	–

5 Operation

5.1 Display and operating elements

The local display enables you to read all important parameters directly at the measuring point and configure the device using the "Quick Setup" or the function matrix.

The display consists of two lines; this is where measured values and/or status variables (e.g. bar graph) are displayed. You can change the assignment of the display lines to different variables to suit your needs and preferences (→ [85](#), USER INTERFACE function group).

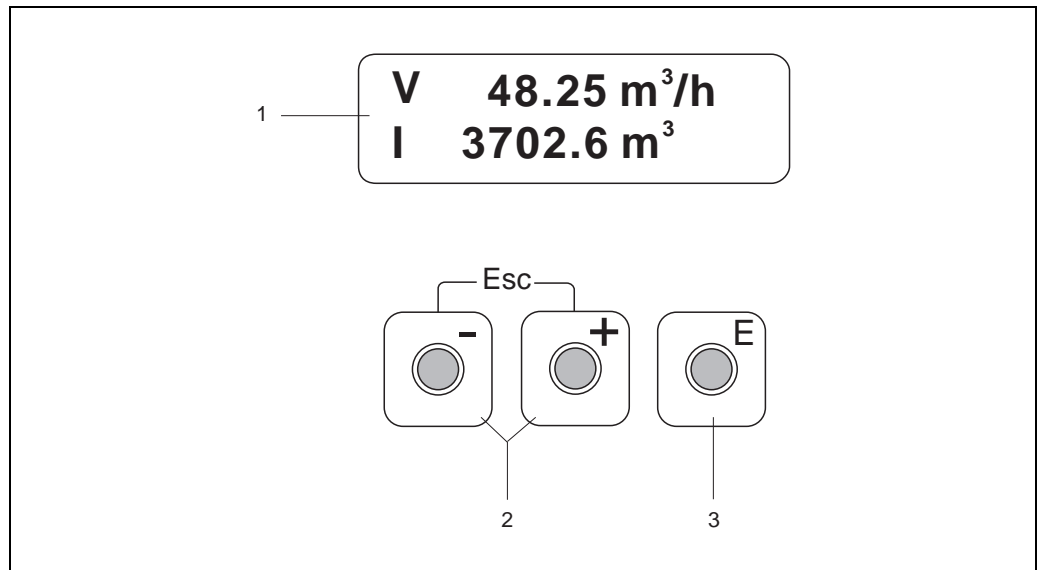

Fig. 21: Display and operating elements

- 1 **Liquid crystal display**
 - Two-line display of measured values, dialog texts and fault and notice messages. The display as it appears during standard measuring mode is known as the HOME position (operating mode).
 - Top line: shows main measured values, e.g. volume flow.
 - Bottom line: shows additional measured variables and status variables, e.g. totalizer reading, bar graph, tag name.
- 2 **Plus/minus keys**
 - Enter numerical values, select parameters
 - Select different function groups within the function matrix
 - Press the \pm keys simultaneously to trigger the following functions:
 - Exit the function matrix step by step → HOME position
 - Press \pm keys (Esc) longer than 3 seconds → return directly to the HOME position
 - Cancel data entry
- 3 **Enter key**
 - HOME position → Entry into the function matrix
 - Save the numerical values you input or settings you changed

5.2 The function matrix: layout and use



Note!

Note the following points:

- General notes and instructions → 29
- The function matrix → 75
- The detailed description of all the functions → 75

The function matrix consists of two levels:

- Function groups

The function groups are the highest-level grouping of the control options for the measuring device. A number of functions is assigned to each function group.

- Functions

You select a function group in order to access the individual functions for operating and configuring the measuring device.

Operate the function matrix as follows:

1. HOME position: press the **E** key → enter the function matrix
2. Select a function group (e.g. CURRENT OUTPUT).
3. Select a function (e.g. TIME CONSTANT)
Change parameter/enter numerical values:
 - ▢ / ▢ keys → select or enter enable code, parameters, numerical values
 - E** key → save your entries
4. Exit the function matrix:
 - Press the **Esc** keys (Esc) longer than 3 seconds → HOME position
 - Repeatedly press the **Esc** keys (Esc) → return step by step to the HOME position

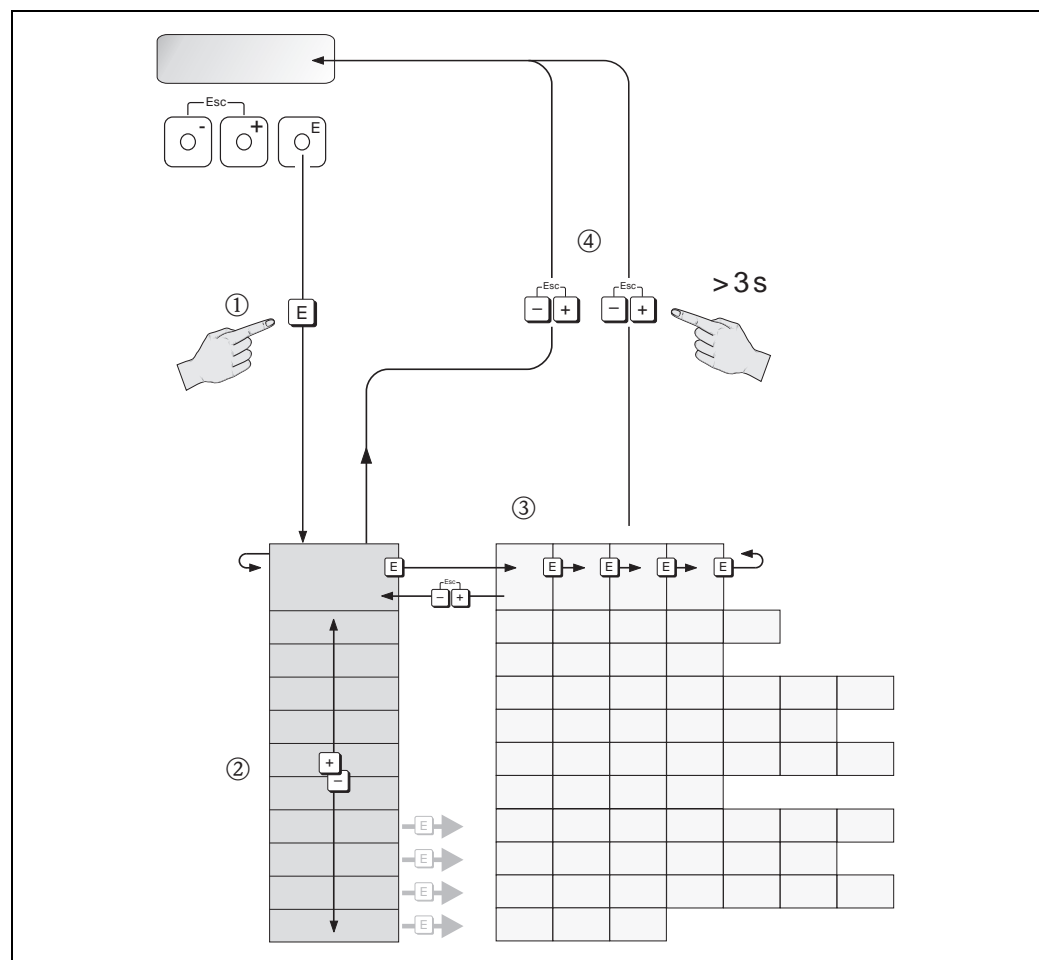







Fig. 22: Selecting and configuring functions (function matrix)

A0001142

5.2.1 General notes

The Quick Setup menu (→  41 and →  82) is adequate for commissioning with the necessary standard settings. Complex measuring operations on the other hand necessitate additional functions that you can configure as necessary and customize to suit your process parameters. The function matrix, therefore, comprises a multiplicity of additional functions which, for the sake of clarity, are arranged in a number of function groups.

Comply with the following instructions when configuring functions:

- You select functions as described (→  28).
- You can switch off certain functions (OFF). If you do so, related functions in other function groups will no longer be displayed.
- Certain functions prompt you to confirm your data entries. Press   to select "SURE [YES]" and press the  key to confirm. This saves your setting or starts a function, as applicable.
- Return to the HOME position is automatic if no key is pressed for 5 minutes.
- Programming mode is automatically disabled if you do not press a key within 60 seconds following return to the HOME position.



Note!

- All functions are described in detail, as is the function matrix itself on →  75
- The transmitter continues to measure while data entry is in progress, i.e. the current measured values are output via the signal outputs in the normal way.
- If the power supply fails, all preset and configured values remain safely stored in the EEPROM.

5.2.2 Enabling the programming mode

The function matrix can be disabled. Disabling the function matrix rules out the possibility of inadvertent changes to device functions, numerical values or factory settings.

A numerical code (factory setting = 72) has to be entered before settings can be changed. If you use a code number of your choice, you exclude the possibility of unauthorized persons accessing data. Function ACCESS CODE →  83

Comply with the following instructions when entering codes:

- If programming is disabled and the  key combination is pressed in any function, a prompt for the code automatically appears on the display.
- If "0" is entered as the private code, programming is always enabled.
- Your Endress+Hauser service organization can be of assistance if you mislay your private code.

5.2.3 Disabling the programming mode

Programming is disabled if you do not press a key within 60 seconds following automatic return to the HOME position.

You can also disable programming by entering any number (other than the private code) in the ACCESS CODE function.

5.3 Error messages

5.3.1 Type of error

Errors which occur during commissioning or measuring operation are displayed immediately. If two or more system or process errors are present, the error with the highest priority is the one shown on the display.

The measuring system distinguishes between two types of error:

- *System error*: this group includes all device errors, for example communication errors, hardware errors, etc. (→ 48).
- *Process error*: this group includes all application errors, for example, e.g. "DSC SENS LIMIT" (→ 50).

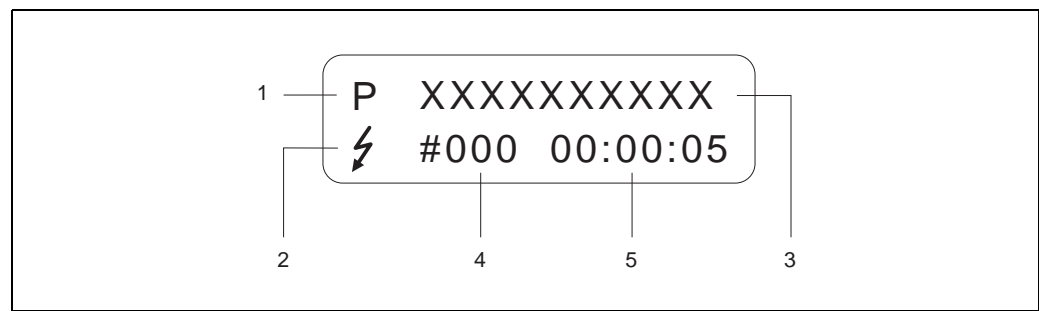

Fig. 23: Error messages on the display (example)

- 1 Error type: P = process error, S = system error
- 2 Error message type: ⚡ = fault message, ! = notice message (definition: see below)
- 3 Error designation: e.g. DSC SENS LIMIT = device being operated near application limits
- 4 Error number: e.g. #395
- 5 Duration of last error to occur (in hours : minutes : seconds), display format, OPERATION HOURS function
→ 110

5.3.2 Types of error message

Users have the option of weighting system and process errors differently, by defining them as **Fault messages** or **Notice messages**. This is specified by means of the function matrix (→ 109, SUPERVISION function group).

Serious system errors, e.g. electronic module defects, are always identified and classed as "fault messages" by the measuring device.

Notice message (!)

- The error in question has no effect on the outputs of the measuring device.
- Displayed as → exclamation mark (!), type of error (S: system error, P: process error)

Fault message (⚡)

- The error in question has a direct effect on the outputs. The response of the outputs (failsafe mode) can be defined by means of functions in the function matrix (→ 52).
- Displayed as → lightning flash (⚡), type of error (S: system error, P: process error)



Note!

Error messages can be output via the current output in accordance with NAMUR NE 43.

5.4 Communication

In addition to via local operation, the measuring device can also be configured and measured values obtained by means of the HART protocol. Digital communication takes place using the 4 to 20 mA HART current output (→  25).

The HART protocol allows the transfer of measuring and device data between the HART master and the field devices for configuration and diagnostics purposes. HART masters, such as a handheld terminal or PC-based operating programs (such as FieldCare), require device description (DD) files. They are used to access all the information in a HART device. Such information is transferred solely via "commands".

There are three different command classes:

- *Universal commands*

All HART devices support and use universal commands. These are associated with the following functionalities for example:

- Recognizing HART devices
- Reading off digital measured values (flow, totalizer, etc.)

- *Common practice commands:*

Common practice commands offer functions which are supported and can be executed by many but not all field devices.

- *Device-specific commands:*

These commands allow access to device-specific functions which are not HART standard. Such commands access individual field device information, (among other things), such as low flow cut off settings etc.



Note!

The measuring device has access to all three command classes.



List of all "Universal Commands" and "Common Practice Commands" →  33

5.4.1 Operating options

For the complete operation of the measuring device, including device-specific commands, device description (DD) files are available to the user to provide the following operating aids and programs:



Note!

If the transmitter is configured via HART, you have to disconnect a circuit for the HART input and achieve the connection according to →  18 or →  19.

Field Xpert HART Communicator

Selecting device functions with a HART Communicator is a process involving a number of menu levels and a special HART function matrix.

The HART operating instructions in the carrying case of the HART handheld terminal contain more detailed information on the device.

"FieldCare" operating program

FieldCare is Endress+Hauser's FDT-based plant asset management tool and allows the configuration and diagnosis of intelligent field devices. By using status information, you also have a simple but effective tool for monitoring devices. The Proline flowmeters are accessed via a service interface or via the service interface FXA193.

"SIMATIC PDM" operating program (Siemens)

SIMATIC PDM is a standardized, manufacturer-independent tool for the operation, configuration, maintenance and diagnosis of intelligent field devices.

"AMS" operating program (Emerson Process Management)

AMS (Asset Management Solutions): program for operating and configuring devices.

5.4.2 Current device description files

The following table illustrates the suitable device description file for the operating tool in question and then indicates where these can be obtained.

HART protocol:

Valid for device software:	1.05.XX	→ DEVICE SOFTWARE function
HART device data		
Manufacturer ID:	11 _{hex} (ENDRESS+HAUSER)	→ MANUFACTURER ID function
Device ID:	56 _{hex}	→ DEVICE ID function
HART version data:	Device Revision 6/ DD Revision 1	
Software release	06.2010	
Operating program	Sources for obtaining device descriptions	
Handheld terminal Field Xpert	Use update function of handheld terminal	
FieldCare / DTM	<ul style="list-style-type: none"> ■ www.endress.com → Download ■ CD-ROM (Endress+Hauser order number 56004088) ■ DVD (Endress+Hauser order number 70100690) 	
AMS	www.endress.com → Download	
SIMATIC PDM	www.endress.com → Download	

Tester/simulator:	Sources for obtaining device descriptions
Fieldcheck	Update via FieldCare with the flow device FXA193/291 DTM in the Fieldflash module



Note!

The "Fieldcheck" tester/simulator is used for testing flowmeters in the field. When used in conjunction with the "FieldCare" software package, test results can be imported into a database, printed out and used for official certification. Contact your Endress+Hauser representative for more information.

5.4.3 Device variables and process variables

Device variables:

The following device variables are available via the HART protocol:

ID (decimal)	Device variable
0	OFF (not assigned)
1	Flow
250	Totalizer



Process variables:





At the factory, the process variables are assigned to the following device variables:







- Primary process variable (PV) → flow
- Secondary process variable (SV) → totalizer
- Third process variable (TV) → not assigned
- Fourth process variable (FV) → not assigned



5.4.4 Universal/common practice HART commands

The following table contains all the universal and common practice commands supported by the measuring device.

Command no. HART command / access type	Command data (numeric data in decimal form)	Response data (numeric data in decimal form)
Universal commands		
0	Read the unique device identifier Access type = Read	None
		The device identifier provides information on the device and manufacturer; it cannot be altered. The response consists of a 12-byte device ID: – Byte 0: fixed value 254 – Byte 1: manufacturer ID, 17 = Endress+Hauser – Byte 2: device type ID, 56 = Prowirl 72 – Byte 3: number of preambles – Byte 4: rev. no. universal commands – Byte 5: rev. no. device-spec. commands – Byte 6: software revision – Byte 7: hardware revision – Byte 8: additional device information – Byte 9-11: device identification
1	Read the primary process variable Access type = Read	None
		– Byte 0: HART unit ID of the primary process variable – Byte 1-4: primary process variable (= flow)  Note! Manufacturer-specific units are represented using the HART unit ID "240".
2	Read the primary process variable as current in mA and percentage of the set measuring range Access type = Read	None
		– Byte 0-3: current current of the primary process variable in mA – Byte 4-7: percentage of the set measuring range Primary process variable = flow
3	Read the primary process variable as current in mA and four (preset using command 51) dynamic process variables Access type = Read	None
		24 bytes are sent as a response: – Byte 0-3: current of the primary process variable in mA – Byte 4: HART unit ID of the primary process variable – Byte 5-8: primary process variable – Byte 9: HART unit ID of the secondary process variable – Byte 10-13: secondary process variable – Byte 14: HART unit ID of the third process variable – Byte 15-18: third process variable – Byte 19: HART unit ID of the fourth process variable – Byte 20-23: fourth process variable <i>Factory setting:</i> ■ Primary process variable = flow ■ Secondary process variable = totalizer ■ Third process variable = not assigned ■ Fourth process variable = not assigned  Note! Manufacturer-specific units are represented using the HART unit ID "240".
6	Set HART short-form address Access type = Write	Byte 0: desired address (0 to 15) <i>Factory setting:</i> 0  Note! With an address > 0 (multidrop mode), the current output of the primary process variable is fixed to 4 mA.
		Byte 0: active address

Command no. HART command / access type		Command data (numeric data in decimal form)	Response data (numeric data in decimal form)
11	Read unique device identification using the TAG (measuring point designation) Access type = Read	Byte 0-5: TAG	The device identifier provides information on the device and manufacturer; it cannot be altered. The response consists of a 12-byte device ID if the given TAG matches the one saved in the device: <ul style="list-style-type: none"> - Byte 0: fixed value 254 - Byte 1: manufacturer ID, 17 = Endress+Hauser - Byte 2: device type ID, 56 = Prowirl 72 - Byte 3: number of preambles - Byte 4: rev. no. universal commands - Byte 5: rev. no. device-spec. commands - Byte 6: software revision - Byte 7: hardware revision - Byte 8: additional device information - Byte 9-11: device identification
12	Read user message Access type = Read	None	Byte 0-24: user message  Note! You can write the user message using command 17.
13	Read TAG, TAG description and date Access type = Read	None	- Byte 0-5: TAG - Byte 6-17: TAG description - Byte 18-20: date  Note! You can write the TAG, descriptor and date using Command 18.
14	Read sensor information on the primary process variable Access type = Read	None	- Byte 0-2: serial number of the sensor - Byte 3: HART unit ID of the sensor limits and measuring range of the primary process variable - Byte 4-7: upper sensor limit - Byte 8-11: lower sensor limit - Byte 12-15: minimum span  Note! <ul style="list-style-type: none"> ■ The data relate to the primary process variable (= flow). ■ Manufacturer-specific units are represented using the HART unit ID "240".
15	Read output information of the primary process variable Access type = Read	None	- Byte 0: Alarm selection ID - Byte 1: ID for transfer function - Byte 2: HART unit ID for the set measuring range of the primary process variable - Byte 3-6: end of measuring range, value for 20 mA - Byte 7-10: start of measuring range, value for 4 mA - Byte 11-14: attenuation constant in [s] - Byte 15: ID for write protection - Byte 16: ID for OEM dealer, 17 = Endress+Hauser Primary process variable = flow  Note! Manufacturer-specific units are represented using the HART unit ID "240".
16	Read the device production number Access type = Read	None	Byte 0-2: production number
17	Write user message Access = Write	You can save any 32-character text in the device with this parameter. Byte 0-23: desired user message	Displays the current user message in the device: Byte 0-23: current user message in the device
18	Write TAG, TAG description and date Access = Write	You can save an 8-character TAG, a 16-character TAG description and a date with this parameter: <ul style="list-style-type: none"> - Byte 0-5: TAG - Byte 6-17: TAG description - Byte 18-20: date 	Displays the current information in the device: <ul style="list-style-type: none"> - Byte 0-5: TAG - Byte 6-17: TAG description - Byte 18-20: date

Command no. HART command / access type	Command data (numeric data in decimal form)	Response data (numeric data in decimal form)	
Common practice commands			
34	Write attenuation constant for primary process variable Access = Write <i>Factory setting:</i> Primary process variable = flow	Byte 0-3: attenuation constant of the primary process variable in seconds <i>Factory setting:</i> Primary process variable = flow	Displays the current attenuation constant in the device: Byte 0-3: attenuation constant in seconds
35	Write measuring range of the primary process variable Access = Write <i>Factory setting:</i> Primary process variable (vol. flow)  Note! If the HART unit ID does not suit the process variable, the device will continue with the last valid unit.	Write the desired measuring range: – Byte 0: HART unit ID for the primary process variable – Byte 1-4: end of measuring range, value for 20 mA – Byte 5-8: start of measuring range, value for 4 mA <i>Factory setting:</i> Primary process variable (vol. flow)  Note! If the HART unit ID does not suit the process variable, the device will continue with the last valid unit.	The measuring range currently set is shown as the response: – Byte 0: HART unit ID for the set measuring range of the primary process variable – Byte 1-4: end of measuring range, value for 20 mA – Byte 5-8: start of measuring range, value for 4 mA (is always at "0")  Note! Manufacturer-specific units are represented using the HART unit ID "240".
38	Device status reset "configuration changed" Access = Write	None	None
40	Simulate output current of the primary process variable Access = Write <i>Factory setting:</i> Primary process variable = flow	Simulation of the desired output current of the primary process variable. An entry value of 0 exits the simulation mode: Byte 0-3: output current in mA <i>Factory setting:</i> Primary process variable = flow	The current output current of the primary process variable is displayed as a response: Byte 0-3: output current in mA
42	Perform device setting Access = Write	None	None
44	Write unit of the primary process variable Access = Write <i>Factory setting:</i> Primary process variable = flow  Note! ■ If the HART unit ID written does not suit the process variable, the device will continue with the last valid unit. ■ If you change the unit of the primary process variable, this has an impact on the 4 to 20 mA output.	Specify the unit of the primary process variable. Only units which are suitable for the process variable are accepted by the device: Byte 0: HART unit ID <i>Factory setting:</i> Primary process variable = flow  Note! ■ If the HART unit ID written does not suit the process variable, the device will continue with the last valid unit. ■ If you change the unit of the primary process variable, this has an impact on the 4 to 20 mA output.	The current unit code of the primary process variable is displayed as a response: Byte 0: HART unit ID  Note! Manufacturer-specific units are represented using the HART unit ID "240".
48	Read extended device status Access = Read	None	The current device status is displayed in extended form as the response: Coding: table →  37
50	Read assignment of the device variables to the four process variables Access = Read	None	Display of the current variable assignment of the process variables: – Byte 0: device variable ID to the primary process variable – Byte 1: device variable ID to the secondary process variable – Byte 2: device variable ID to the third process variable – Byte 3: device variable ID to the fourth process variable <i>Factory setting:</i> ■ Primary process variable: ID 1 for flow ■ Secondary process variable: ID 250 for totalizer ■ Third process variable: ID 0 for OFF (not assigned) ■ Fourth process variable: ID 0 for OFF (not assigned)

Command no.	HART command / access type	Command data (numeric data in decimal form)	Response data (numeric data in decimal form)
53	Write device variable unit Access = Write	This command sets the unit of the given device variables. Only those units which suit the device variable are transferred: – Byte 0: device variable ID – Byte 1: HART unit ID <i>ID of the supported device variables:</i> See data → 32  Note! If the written unit does not suit the device variable, the device will continue with the last valid unit.	The current unit of the device variables is displayed in the device as a response: – Byte 0: device variable ID – Byte 1: HART unit ID  Note! Manufacturer-specific units are represented using the HART unit ID "240".
59	Specify number of preambles in message responses Access = Write	This parameter specifies the number of preambles which are inserted in the message responses: Byte 0: number of preambles (2 to 20)	As a response, the current number of the preambles is displayed in the response message: Byte 0: number of preambles
109	Burst mode control Access = Write	This parameter switches the burst mode on and off. Byte 0: ■ 0 = burst mode off ■ 1 = burst mode on	The value set in byte 0 is shown as the response.

5.4.5 Device status / error messages

You can read the extended device status, in this case, current error messages, via Command "48". The command delivers bit-encoded information (see table below).



Note!

Detailed information on the device status messages and error messages, and how they are rectified, can be found on → [48](#)

Byte Bit	Error no.	Short error description → 48
0-0	001	Serious device error
0-1	011	Measuring amplifier has faulty EEPROM
0-2	012	Error when accessing data of the measuring amplifier EEPROM
0-3	021	COM module: faulty EEPROM
0-4	022	COM module: error when accessing data of the EEPROM
0-5	111	Totalizer checksum error
0-6	351	Current output: the current flow is outside the set range.
0-7	Not assigned	–
1-0	359	Pulse output: the pulse output frequency is outside the set range.
1-1	Not assigned	–
1-2	379	Device being operated in the resonance frequency.
1-3	Not assigned	–
1-4	Not assigned	–
1-5	394	DSC sensor defective, no measurement
1-6	395	DSC sensor being operated near application limits, device failure probable soon.
1-7	396	Device finds signal outside the set filter range.
2-0	Not assigned	–
2-1	Not assigned	–
2-2	399	Pre-amplifier disconnected
2-3	Not assigned	–
2-4	Not assigned	–
2-5	Not assigned	–
2-6	501	New amplifier software version or data being loaded into device. No other commands possible at this point.
2-7	502	Uploading the device data. No other commands possible at this point.
3-0	601	Positive zero return active
3-1	611	Current output simulation active
3-2	Not assigned	–
3-3	631	Simulation pulse output active
3-4	641	Simulation status output active
3-5	691	Simulation of response to error (outputs) active
3-6	692	Simulation measurand
3-7	Not assigned	–
4-0	Not assigned	–
4-1	Not assigned	–
4-2	699	Current adjustment active
4-3	698	Device test active
4-4	029	Checksum ROM

Byte Bit	Error no.	Short error description →  48
4-5	421	Flow range exceeded
4-6	Not assigned	–
4-7	Not assigned	–

5.4.6 Switching HART write protection on/off

A DIP switch on the amplifier board provides the means of activating or deactivating the HART write protection. If HART write protection is enabled, it is not possible to change parameters via the HART protocol.



Warning!

Risk of electric shock.

Exposed components carry dangerous voltages.

Make sure that the power supply is switched off before you remove the cover of the electronics compartment.

1. Switch off power supply.
2. Unscrew the cover of the electronics compartment from the transmitter housing.
3. Remove the display module (a) from the retaining rails (b) and refit onto the right retaining rail with the left side. This secures the display module.
4. Fold up the plastic cover (c).
5. Set the DIP switch to the desired position.
Position A (DIP switch at front) → HART write protection disabled
Position B (DIP switch at rear) → HART write protection enabled



Note!

The current status of the HART write protection is displayed in the WRITE PROTECTION function. →  101

6. Installation is the reverse of the removal procedure.

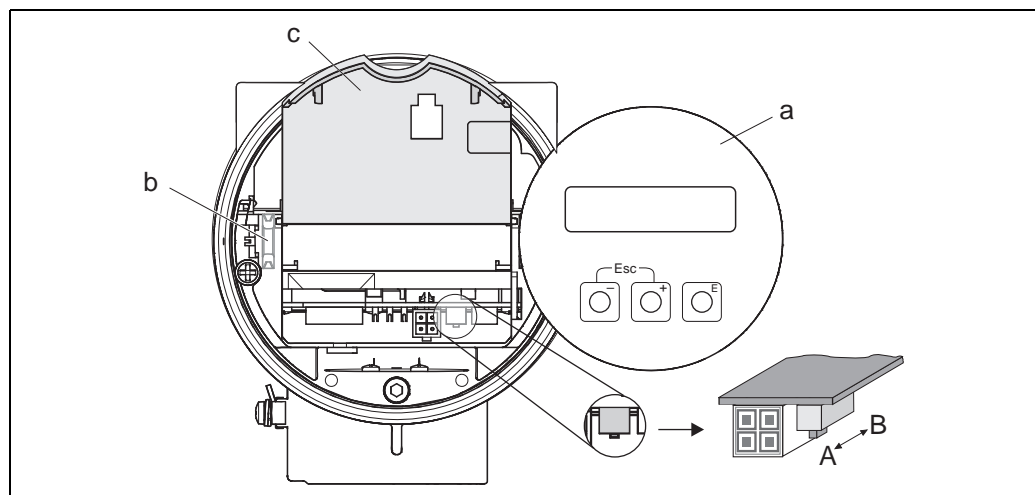

Fig. 24: DIP switch for switching HART write protection on and off

- a Local display module
- b Retaining rails of local display module
- c Plastic cover
- A Write protection disabled (DIP switch at front)
- B Write protection enabled (DIP switch at rear)

6 Commissioning

6.1 Function check

Make sure that all final checks have been completed before you commission your measuring point:

- Checklist for "post-installation check" → [20](#)
- Checklist for "post-connection check" → [26](#)

6.2 Switching on the measuring device

Having completed the function check, switch on the supply voltage.

After approx. 5 seconds, the device is ready for operation! The device then performs internal test functions and the following sequence of messages is shown on the local display:

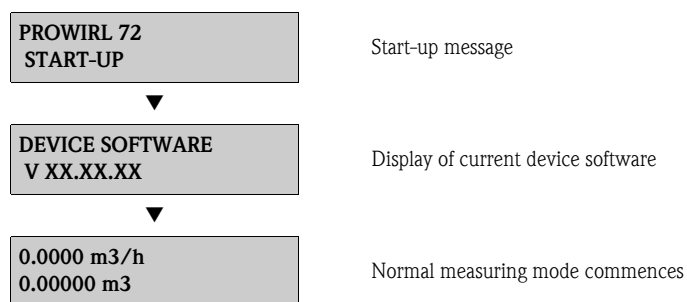

The measuring device starts operating once the startup process is completed. Various measured values and/or status variables appear on the display (HOME position).



Note!

If startup fails, an appropriate error message is displayed, depending on the cause. The error messages that occur most frequently during commissioning are described in the "Troubleshooting" section (→ [47](#)).

6.3 Commissioning after installing a new electronics board

After startup the device checks whether a serial number is present. If this is not the case, the following setup is started. For information on how to install a new electronics board, please refer to → 54

6.3.1 "Commissioning" setup



Note!

- As soon as a serial number has been entered and saved this setup is no longer available. If wrong information for a parameter is entered during the setup, it can be corrected in the appropriate function via the function matrix.
- The required information (apart from language) is indicated on the device's name plate and the inner side of the display cover (→ 9). Additionally, the meter body MB index and the calibration factor are indicated on the device's meter body.

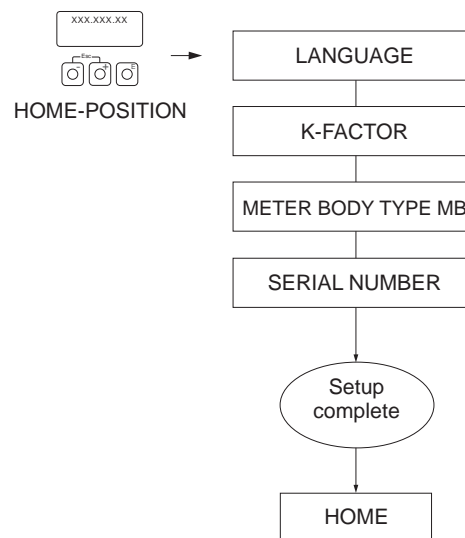

A0006765-en

Fig. 25: The setup starts once a new electronics board is installed if no serial number is available.

6.4 "Commissioning" Quick Setup

The "Commissioning" Quick Setup menu guides you systematically through all the important functions of the measuring device that have to be configured for standard measuring operation.

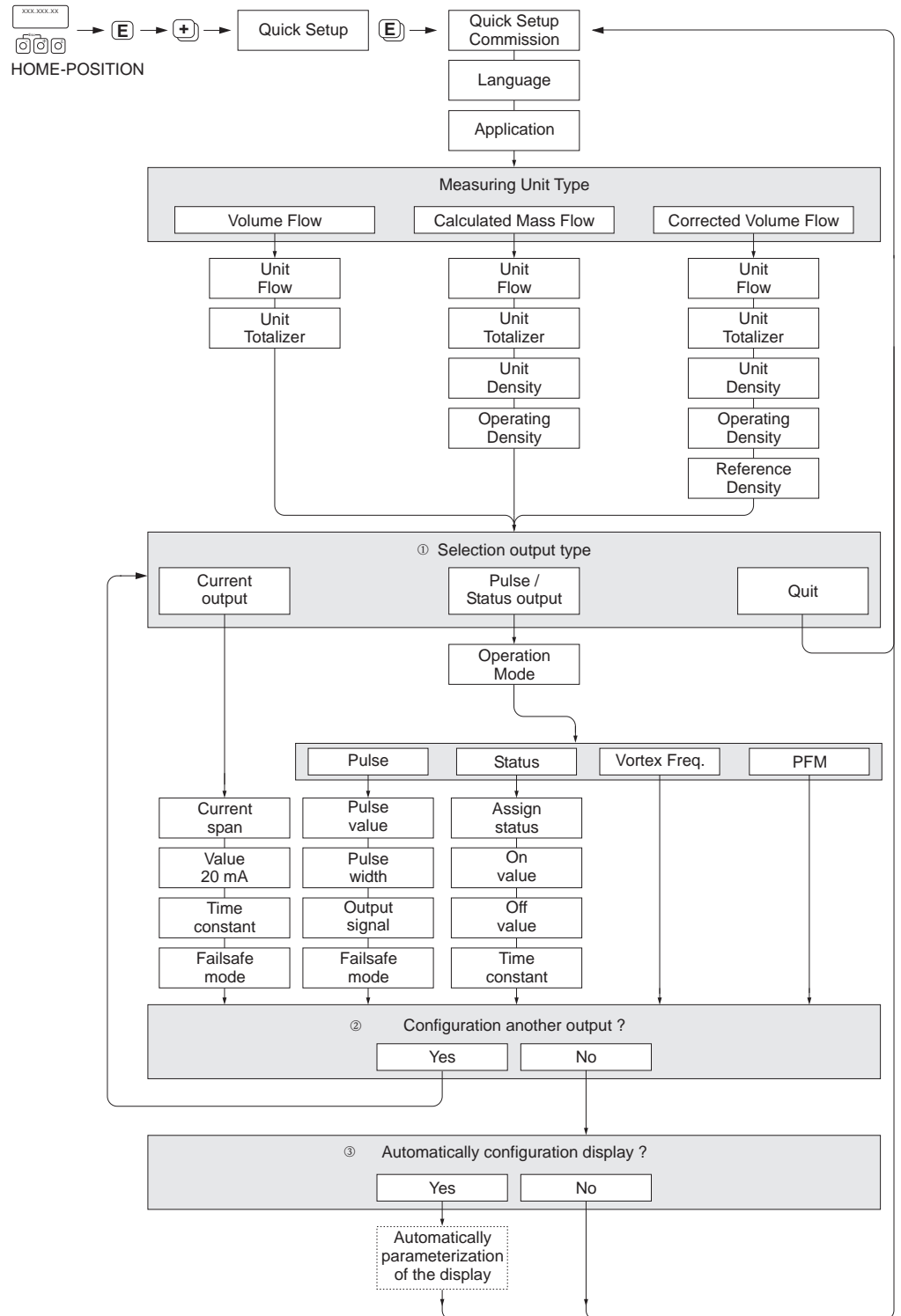

A0003394-en

**Note!**

- The individual functions are described in the "Description of Device Functions" section (→ 75).
- The display returns to the QUICK SETUP COMMISSIONING cell (→ 82) if you press the Esc key combination (Esc) during parameter interrogation.

- ① Only the output (current output or pulse/status output) not yet configured in the current Quick Setup is offered for selection after the first cycle.
- ② The "YES" option appears as long as a free output is available. "NO" is displayed when no further outputs are available.
- ③ When "YES" is selected, the flow is assigned to line 1 of the local display and the totalizer to line 2.

Example of configuration No. 1 (volume unit)

You want to measure the flow of water.

The flow should be displayed in the volume flow unit m^3/h .

The following settings must be made in the "Commissioning" Quick Setup:

- APPLICATION: LIQUID
- MEASURING UNIT TYPE: VOLUME FLOW
- UNIT FLOW: m^3/h
- UNIT TOTALIZER: m^3
- Output configuration

Example of configuration No. 2 (mass unit)

You want to measure superheated steam with a constant temperature of $200\text{ }^\circ\text{C}$ and a constant pressure of 12 bar. According to IAPWS-IF97, the density at operating conditions is $5.91\text{ kg}/\text{m}^3$. (IAPWS = International Association of Process Water and Steam).

The flow should be displayed in the mass flow unit kg/h .

The following settings must be made in the "Commissioning" Quick Setup:

- APPLICATION: GAS/STEAM
- MEASURING UNIT TYPE: CALCULATED MASS FLOW
- UNIT FLOW: kg/h
- UNIT TOTALIZER: t
- UNIT DENSITY: kg/m^3
- OPERATING DENSITY: 5.91
- Output configuration

Example of configuration No. 3 (corrected volume unit)

You want to measure compressed air with a constant temperature of $60\text{ }^\circ\text{C}$ and a constant pressure of 3 bar. The density at operating conditions is $3.14\text{ kg}/\text{m}^3$, the density of air at reference operating conditions ($0\text{ }^\circ\text{C}$, 1013 mbar) $1.2936\text{ kg}/\text{m}^3$.

The flow should be displayed in the corrected volume flow unit Nm^3/h .

The following settings must be made in the "Commissioning" Quick Setup:

- APPLICATION: GAS/STEAM
- MEASURING UNIT TYPE: CORRECTED VOLUME FLOW
- UNIT FLOW: Nm^3/h
- UNIT TOTALIZER: Nm^3
- UNIT DENSITY: kg/m^3
- OPERATING DENSITY: 3.14
- REFERENCE DENSITY: 1.2936
- Output configuration

7 Maintenance

The flow measuring system requires no special maintenance.

7.1 Exterior cleaning

When cleaning the exterior of measuring devices, always use cleaning agents that do not attack the surface of the housing and the seals.

7.2 Pipe cleaning

Do not use a pipe cleaning pig.

7.3 Replacing seals

7.3.1 Replacing sensor seals

Under normal circumstances, wetted seals need not be replaced. Replacement is necessary only in special circumstances, for example if aggressive or corrosive fluids are incompatible with the seal material.



Note!

- The time span between the individual replacement procedures depends on the fluid properties.
- Replacement seals (accessory) (→  44).
Only Endress+Hauser sensor seals may be used.

7.3.2 Replacing housing seals

The housing seals must be clean and undamaged when inserted into their grooves. The seals must be dried, cleaned or replaced if necessary.



Note!

If the device is used in a dust atmosphere, only use the associated Endress+Hauser housing seals.

8 Accessories

Various accessories, which can be ordered separately from Endress+Hauser, are available for the transmitter and the sensor. Your Endress+Hauser service organization can provide detailed information on the order codes in question.

8.1 Device-specific accessories

Accessory	Description	Order code
Proline Prowirl 72 transmitter	Transmitter for replacement or for stock. Use the order code to define the following specifications: <ul style="list-style-type: none"> ■ Approvals ■ Degree of protection / version ■ Cable entries ■ Display / operation ■ Software ■ Outputs / inputs 	72XXX - XXXXX *****

8.2 Measuring principle-specific accessories

Accessory	Description	Order code
Mounting kit for Prowirl 72W	Mounting kit for wafer comprising: <ul style="list-style-type: none"> ■ Threaded studs ■ Nuts incl. washers ■ Flange seals 	DKW** - ***
Mounting kit for transmitter	Mounting kit for remote version, suitable for pipe and wall mounting.	DK6WM -B
Memograph M graphic display recorder	The Memograph M graphic display recorder provides information on all the relevant process variables. Measured values are recorded correctly, limit values are monitored and measuring points analyzed. The data are stored in the 256 MB internal memory and also on a DSD card or USB stick. Memograph M boasts a modular design, intuitive operation and a comprehensive security concept. The ReadWin® 2000 PC software is part of the standard package and is used for configuring, visualizing and archiving the data captured. The mathematics channels which are optionally available enable continuous monitoring of specific power consumption, boiler efficiency and other parameters which are important for efficient energy management.	RSG40 - *****
Conversion kits	Several conversion kits are available, e.g.: <ul style="list-style-type: none"> ■ Conversion of Prowirl 77 to Prowirl 72 or 73 ■ Conversion of a compact version to a remote version 	DK7UP - **
Flow conditioner	To reduce the inlet run downstream of flow disturbances.	DK7ST - ***
Pressure transmitter Cerabar T	Cerabar T is used to measure the absolute and gauge pressure of gases, steams and liquids (compensation with RMC621 for example).	PMC131 - **** PMP131 - ****
Pressure transmitter Cerabar M	Cerabar M is used to measure the absolute and gauge pressure of gases, steams and liquids. <ul style="list-style-type: none"> ■ Can also be used for reading external pressure values into Prowirl 73 via the burst mode. ■ Can also be ordered with ready-activated burst mode. ■ Can also be used for reading external pressure values into Prowirl 73 via PROFIBUS PA (only absolute pressure). 	PMC41 - ***** PMP41 - ***** PM*4* - *****H/J9**
Pressure transmitter Cerabar S	Cerabar S is used to measure the absolute and gauge pressure of gases, steams and liquids. <ul style="list-style-type: none"> ■ Can also be used for reading external pressure values into Prowirl 73 via the burst mode. ■ Can also be ordered with ready-activated burst mode. ■ Can also be used for reading external pressure values into Prowirl 73 via PROFIBUS PA or FOUNDATION Fieldbus (only absolute pressure). 	PMC71 - ***** PMP71 - ***** PM*7* - *A/B/C*****9

Accessory	Description	Order code
RTD temperature Omnigrad TR10	Multipurpose temperature sensor. Mineral-insulated insert with thermowell, terminal head and extension neck.	TR10 - *****R/T****
Active barrier RN221N	Active barrier with power supply for safe separation of 4 to 20 mA standard signal circuits: <ul style="list-style-type: none"> ■ Galvanic isolation of 4 to 20 mA circuits ■ Elimination of ground loops ■ Power supply of two-wire transmitters ■ Can be used in Ex area (ATEX, FM, CSA, TIIS) ■ Optional: relay output 	RN221N - **
Process display RIA250	Multifunctional 1-channel display unit with universal input, transmitter power supply, limit relay and analog output.	RIA250 - *****
Process display RIA251	Digital display unit for looping into 4 to 20 mA current loop; can be used in Ex area (ATEX, FM, CSA).	RIA251 - **
Field display RIA261	Digital field display unit for looping into 4 to 20 mA current loop; can be used in Ex area (ATEX, FM, CSA).	RIA261 - ***
Process transmitter RMA422	Multifunctional 1-2 channel top-hat rail device with intrinsically safe current inputs and transmitter power supply, limit value monitoring, mathematic functions (e.g. difference ascertain) and 1-2 analog outputs. Optional: intrinsically safe inputs, can be used in Ex area (ATEX). Possible applications: e.g. <ul style="list-style-type: none"> ■ Leak detection ■ delta heat (between two Prowirl measuring points) ■ Totalizing (of flows in two pipes) 	RMA422 - *****
Overvoltage protection HWA562Z	Overvoltage protection for restricting overvoltage in signal lines and components.	51003575
Overvoltage protection HWA569	Overvoltage protection for restricting overvoltage in Prowirl 72 and other sensors for direct mounting on the device.	HAW569 - **1A
Energy Manager RMC621	Universal Energy Manager for gas, liquids, steam and water. Calculation of volumetric flow and mass flow, corrected volume, heat flow and energy.	RMC621 - *****
Heat computer RMS621	Steam and heat computer for industrial energy balancing of steam and water. Calculation of the following applications: <ul style="list-style-type: none"> ■ Steam mass ■ Steam heat quantity ■ Net steam heat quantity ■ Steam heat differential ■ Water heat quantity ■ Water heat differential Simultaneous calculation of up to three applications per device.	RMS621-*****

8.3 Communication-specific accessories

Accessory	Description	Order code
HART Communicator Field Xpert handheld terminal	Handheld terminal for remote configuration and for obtaining measured values via the current output HART (4 to 20 mA) and FOUNDATION Fieldbus (FF). Contact your Endress+Hauser representative for more information.	SFX100 - *****
Fieldgate FXA320	Gateway for remote interrogation of HART sensors and actuators via Web browser: <ul style="list-style-type: none"> ■ 2-channel analog input (4 to 20 mA) ■ 4 binary inputs with event counter function and frequency measurement ■ Communication via modem, Ethernet or GSM ■ Visualization via Internet/Intranet in the web browser and/or WAP cellular phone ■ Limit value monitoring with alarm by e-mail or SMS ■ Synchronized time stamping of all measured values 	FXA320 - *****
Fieldgate FXA520	Gateway for remote interrogation of HART sensors and actuators via Web browser: <ul style="list-style-type: none"> ■ Web server for remote monitoring of up to 30 measuring points ■ Intrinsically safe version [EEx ia]IIC for applications in hazardous areas ■ Communication via modem, Ethernet or GSM ■ Visualization via Internet/Intranet in the web browser and/or WAP cellular phone ■ Limit value monitoring with alarm signaling via e-mail or SMS ■ Synchronized time stamping of all measured values ■ Remote diagnosis and remote configuration of connected HART devices 	FXA520 - ****
FXA195	The Commubox FXA195 connects intrinsically safe Smart transmitters with HART protocol to the USB port of a personal computer. This makes the remote operation of the transmitters possible with the aid of configuration programs (e.g. FieldCare). Power is supplied to the Commubox by means of the USB port.	FXA195 - *



8.4 Service-specific accessories

Accessory	Description	Order code
Applicator	Software for selecting and planning flowmeters. The Applicator can be downloaded from the Internet or ordered on CD-ROM for installation on a local PC. Contact your Endress+Hauser representative for more information.	DXA80 - *
Fieldcheck	Tester/simulator for testing flowmeters in the field. When used in conjunction with the "FieldCare" software package, test results can be imported into a database, printed out and used for official certification. Contact your Endress+Hauser representative for more information.	50098801
FieldCare	FieldCare is Endress+Hauser's FDT-based plant asset management tool. It can configure all intelligent field units in your system and helps you manage them. By using the status information, it is also a simple but effective way of checking their status and condition.	See the product page on the Endress+Hauser Web site: www.endress.com
FXA193	Service interface from the measuring device to the PC for operation via FieldCare.	FXA193 - *

9 Troubleshooting

9.1 Troubleshooting instructions

Always start troubleshooting with the following checklist if faults occur after commissioning or during operation. This takes you directly (via various queries) to the cause of the problem and the appropriate remedial measures.

Check the display	
No display visible and no output signals present	<ol style="list-style-type: none"> 1. Check the supply voltage → Terminals 1, 2 2. Measuring electronics defective → order spare parts → 53
No display visible but output signals are present	<ol style="list-style-type: none"> 1. Check whether the ribbon-cable connector of the display module is correctly plugged into the amplifier board → 54 2. Display module defective → order spare parts → 53 3. Measuring electronics defective → order spare parts → 53
Display texts are in a foreign language.	<ol style="list-style-type: none"> 1. Switch off power supply. 2. Press the  keys simultaneously and switch on the measuring device again. The display text will appear in English and is displayed at 50% contrast.
Measured value indicated, but no signal output at the current or pulse output	Measuring electronics defective → order spare parts → 53
▼	
Error messages on display	
<p>Errors which occur during commissioning or operation are displayed immediately or once the set delay time has elapsed (→ 109, ALARM DELAY function). Error messages consist of a variety of icons. The meanings of these icons are as follows (example):</p> <ul style="list-style-type: none"> – Type of error: S = System error, P = Process error – Error message type: f = Fault message, ! = Notice message – DSC SENS LIMIT = Error designation (device being operated near application limits) – 03:00:05 = Duration of error to occur (in hours, minutes and seconds), display format, OPERATION HOURS function → Page 110 – #395 = Error number <p> Note!</p> <ul style="list-style-type: none"> ■ See the information on → 30 ■ The measuring system interprets simulations and positive zero return as system errors, but displays them as notice messages only. 	
Error message on display	System error (device error) → 48 Process error (application error) → 50
▼	
Other errors (without error message)	
Some other error has occurred.	Diagnosis and remedial measures → 50

9.2 System error messages

Serious system errors are **always** recognized by the device as "fault messages" and are indicated with a lightning flash (⚡) on the display! Fault messages have a direct effect on the outputs. Simulations and positive zero return, on the other hand, are only classed and displayed as "notice messages".



Caution!

In the event of a serious fault, a flowmeter might have to be returned to the manufacturer for repair. Important procedures must be carried out before you return a measuring device to Endress+Hauser (→ 8).

Always enclose a fully completed "Declaration of Contamination" form with the device. A copy of the form can be found at the end of these Operating Instructions.



Note!

Also observe the information on → 30 and → 52.

Type	Error message / No.	Cause	Remedy / spare part (→ 53)
S = System error ⚡ = Fault message (with an effect on the outputs) ! = Notice message (without an effect on the outputs)			
No. # 0xx → Hardware error			
S ⚡	CRITICAL FAIL. # 001	Serious device error	Replace the amplifier board.
S ⚡	AMP HW EEPROM # 011	Amplifier: faulty EEPROM	Replace the amplifier board.
S ⚡	AMP SW EEPROM # 012	Amplifier: error when accessing data of the EEPROM.	Contact your Endress+Hauser service organization.
S ⚡	COM HW EEPROM # 021	COM module: faulty EEPROM	Replace COM module.
S ⚡	COM SW EEPROM # 022	COM module: error when accessing data of the EEPROM	Contact your Endress+Hauser service organization.
S ⚡	CHECKSUM TOT. # 111	Totalizer checksum error	Contact your Endress+Hauser service organization.
S !	RANGE CUR.OUT # 351	Current output: the current flow is outside the set range.	1. Change full scale value entered. 2. Reduce flow.
S !	RANGE PULSE # 359	Pulse output: the pulse output frequency is outside the set range.	1. Increase pulse value. 2. When entering the pulse width, select a value that can still be processed by a connected totalizer (e.g. mechanical totalizer, PLC, etc.). Determine pulse width: – Method 1: enter the minimum time for which a pulse has to be present at a connected totalizer in order to be recorded. – Method 2: enter the maximum (pulse) frequency as a half "reciprocal value" for which a pulse has to be present at a connected totalizer in order to be recorded. Example: The maximum input frequency of the connected counter is 10 Hz. The pulse width to be entered is: $1 / (2 \cdot 10 \text{ Hz}) = 50 \text{ ms}$. 3. Reduce flow.
S ⚡	RESONANCE DSC # 379	The device is being operated in the resonance frequency. Caution! If the device is operated in the resonance frequency, this can result in damage which can lead to complete device failure.	Reduce flow.
S ⚡	DSC SENS DEFCT # 394	The DSC sensor is defective, measurement no longer takes place.	Contact your Endress+Hauser service organization.

Type	Error message / No.	Cause	Remedy / spare part (→ 53)
S !	DSC SENS LIMIT # 395	The DSC sensor is being operated near application limits, device failure is probable soon.	If this message is permanently displayed, contact your Endress+Hauser service organization.
S ⚡	SIGNAL>LOW PASS # 396	The device finds the signal outside the set filter range. Possible causes: <ul style="list-style-type: none"> ■ The flow is outside the measuring range. ■ The signal is caused by a strong vibration which is intentionally not measured and is outside the measuring range. 	<ul style="list-style-type: none"> ■ Check whether the device was installed in the flow direction. ■ Check whether the right option was selected in the APPLICATION function (→ 102). ■ Check whether the operating conditions are within the specifications of the measuring device. Example: flow is above measuring range which means that the flow may have to be reduced. <p>If the checks do not solve the problem, please contact your Endress+Hauser service organization.</p>
S \$	PREAMP. DISCONN. # 399	Pre-amplifier disconnected.	Check the connection between the preamplifier and amplifier board and establish the connection if necessary.
S !	SW.-UPDATE ACT. # 501	New amplifier software version or data being loaded into device. No other commands possible at this point.	Wait until the procedure is complete. The device is automatically restarted.
S !	UP-/DOWNL. ACT # 502	Uploading the device data. No other commands possible at this point.	Wait until the procedure is complete.
S !	POS. ZERO-RET. # 601	Positive zero return active.  Caution! This message has the highest display priority.	Switch off positive zero return.
S !	SIM. CURR. OUT # 611	Current output simulation active.	Switch off simulation.
S !	SIM. PULSE # 631	Pulse output simulation active.	Switch off simulation.
S !	SIM. STAT. OUT # 641	Status output simulation active.	Switch off simulation.
S \$	SIM. FAILSAFE # 691	Simulation of failsafe mode (outputs) active.	Switch off simulation.
S !	SIM. MEASURAND # 692	Simulation of a measured variable active (e.g. mass flow).	Switch off simulation.
S !	DEV. TEST ACT. # 698	The measuring device is being checked on site via the "Fieldcheck" testing device and simulator.	-
S !	CURRENT ADJUST # 699	Current adjustment is active.	Quit current adjustment.

9.3 Process error messages

Process errors can be defined as either "Fault" or "Notice" messages and can thereby be weighted differently. This is determined via the function matrix (→ Page 109, ERROR CATEGORY function).



Note!

- The listed error message types below correspond to the factory setting.
- Also observe the information on → 30 and → 52.

Type	Error message / No.	Cause	Remedy / spare part
P = Process error ⚡ = Fault message (with an effect on the outputs) ! = Notice message (without an effect on the outputs)			
P !	FLOW RANGE # 421	The current flow velocity exceeds the limit value specified in the LIMIT VELOCITY function (→ 105).	Reduce the flow.

9.4 Process errors without messages

You may have to change or correct settings in certain functions of the function matrix in order to rectify faults. The functions outlined below (e.g. FLOW DAMPING) are described in detail in the "Description of device functions" section (→ 75).

Symptoms	Remedial measures
No flow signal	<ul style="list-style-type: none"> ■ In the case of liquids: check whether the piping is completely filled. The piping must always be completely filled for accurate and reliable flow measurement. ■ Check whether all the packaging material, including the meter body protective covers, was completely removed before mounting the device. ■ Check whether the desired electrical output signal was connected correctly.
Flow signal even though there is no flow	Check whether the device is exposed to particularly strong vibrations. If so, a flow can be displayed even if the fluid is at a standstill, depending on the frequency and direction of the vibration. Remedial measures at the device: <ul style="list-style-type: none"> ■ Turn the sensor 90°. Observe the installation conditions when doing so (→ 13). The measuring system is most sensitive to vibrations which follow in the direction of the sensor. Vibrations have less of an effect on the device in the other axes. ■ The amplification can be altered using the AMPLIFICATION function. → 108 Remedy through constructive measures during installation: <ul style="list-style-type: none"> ■ If the source of the vibration (e.g. pump or a valve) has been identified, the vibrations can be reduced by decoupling or supporting the source. ■ Support the pipe near the measuring device. If these measures do not solve the problem, your Endress+Hauser service organization can adjust the filters of the device to suit your special application.

Symptoms	Remedial measures
Incorrect or highly-fluctuating flow signal	<ul style="list-style-type: none"> ■ The fluid is not sufficiently single-phase or homogeneous. Prerequisite for precise and reliable flow measurement: <ul style="list-style-type: none"> – Single-phase and homogeneous fluid – Completely full pipe ■ In many instances, the following measures can be taken to improve the measurement result even under non-ideal conditions: <ul style="list-style-type: none"> – In the case of liquids with a low gas content in horizontal pipes, install the device with the head pointing downwards or to the side. This improves the measuring signal since the sensor is not in the area where gas accumulates when this type of installation is used. – In the case of liquids with a low solids content, avoid installing the device with the electronics housing pointing downwards. – In the case of steam or gases with a low liquid content, avoid installing the device with the electronics housing pointing downwards. ■ The inlet and outlet runs must be present as per the installation instructions (→ 16). ■ Suitable seals with an internal diameter not smaller than the pipe internal diameter must be installed and correctly centered. ■ The static pressure must be large enough to rule out cavitation in the area of the sensor. ■ Check whether the correct fluid was selected in the APPLICATION function (→ 102). The setting in this function determines the filter settings and can thus have an effect on the measuring range. ■ Check whether the data for the K-factor on the nameplate match the data in the K-FACTOR functions. → 107 ■ Check whether the device is correctly installed in the flow direction. ■ Check whether the nominal diameter of the mating pipe and the device match. → 104 ■ The flow must be in the measuring range of the device (→ 59). The start of measuring range depends on the density and the viscosity of the fluid. Density and viscosity depend on temperature. Density also depends on the process pressure in the case of gases. ■ Check whether the operating pressure is affected by pressure pulsations (e.g. from piston pumps). The pulsations can affect vortex shedding if they have a frequency similar to the vortex frequency. ■ Check whether the correct engineering unit was selected for the flow or totalizer. ■ Check whether the current output or pulse value was correctly set.
The fault cannot be rectified or some other fault not described above has occurred.	<p>The following options are available for tackling problems of this nature:</p> <ul style="list-style-type: none"> ■ Request the services of an Endress+Hauser service technician If you contact our service organization to have a service technician sent out, the following information is needed: <ul style="list-style-type: none"> – A brief description of the error with information on the application. – Nameplate specifications (→ 9): order code and serial number ■ Return devices to Endress+Hauser <ol style="list-style-type: none"> 1. The measured listed in the "Return" section (→ 8) must be carried out before you return a measuring device requiring repair or calibration to Endress+Hauser. 2. Enclose a fully completed "Declaration of Contamination" form with the flowmeter. A copy of the form can be found at the end of these Operating Instructions. ■ Replace the transmitter electronics Order spare parts for the meter electronics directly from your Endress+Hauser service organization (→ 53).

9.5 Response of outputs to errors



Note!

The failsafe mode of the totalizer, current output, pulse output and status output can be configured by means of various functions in the function matrix.

Positive zero return and error response:

You can use positive zero return to set the signals of the current, pulse and status outputs to their fallback value, for example when operation has to be interrupted while a pipe is being cleaned. This function has priority over all other device functions; simulations are suppressed, for example.

Response of outputs and totalizers to errors		
	Process/system error present	Positive zero return activated
Caution! System or process errors defined as "notice messages" have no effect whatsoever on the outputs. Refer also to the information on → 30.		
Current output	MIN. CURRENT Depends on the option selected in the CURRENT SPAN function. If the current span is: 4 to 20 mA HART NAMUR → output current = 3.6 mA 4 to 20 mA HART US → output current = 3.75 mA MAX. CURRENT 22.6 mA HOLD VALUE Measured value display on the basis of the last saved value preceding occurrence of the fault. ACTUAL VALUE Measured value output is based on the current flow measurement. The fault is ignored.	Output signal corresponds to zero flow.
Pulse output	FALLBACK VALUE Signal output → 0 pulse output HOLD VALUE Measured value display on the basis of the last valid flow value before the fault occurred. ACTUAL VALUE Measured value output is based on the current flow measurement. The fault is ignored.	Output signal corresponds to zero flow.
Status output	In the event of a fault or power supply failure: Status output → not conductive	No effect on the status output.
Totalizer	STOP The totalizer stops at the last value before the alarm condition occurred. HOLD VALUE The totalizer continues to count the flow on the basis of the last valid flow data (before the fault occurred). ACTUAL VALUE The totalizer continues to count the flow on the basis of the current flow data. The fault is ignored.	The totalizer stops.

9.6 Spare parts

Chap. 9.1 contains detailed troubleshooting instructions. The measuring device, moreover, provides additional support in the form of continuous self-diagnosis and error messages. Troubleshooting can entail replacing defective components with tested spare parts. The illustration below shows the available scope of spare parts.



Note!

You can order spare parts directly from your Endress+Hauser service organization by providing the serial number printed on the transmitter's nameplate. (→ 9).

Spare parts are shipped as sets comprising the following parts:

- Spare part
- Additional parts, small items (screws, etc.)
- Installation instructions
- Packaging

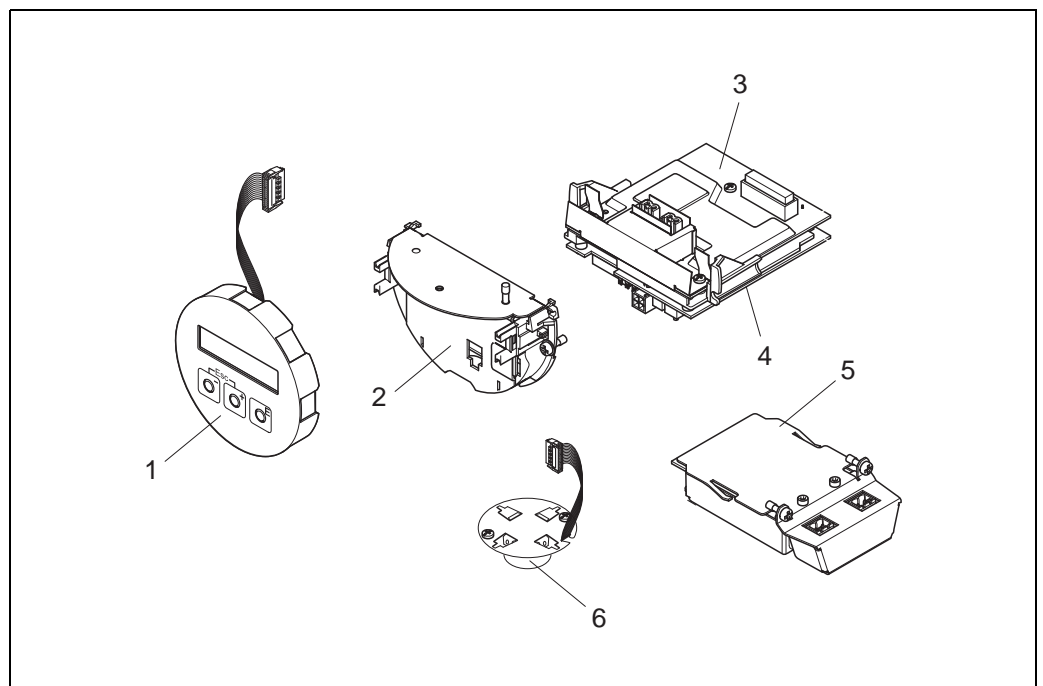

A0001918

Fig. 26: Spare parts for transmitter Proline Prowirl 72

- 1 Local display module
- 2 Board holder
- 3 I/O board (COM module), Non-Ex, Ex-i and Ex-n version
- 4 Amplifier board
- 5 I/O board (COM module), Ex-d version
- 6 Pre-amplifier

9.6.1 Installing and removing electronics boards

For information on the software settings after installing a new electronics board →  40

Non-Ex, Ex-i and Ex-n version



Warning!

When connecting Ex-certified devices, please refer to the notes and diagrams in the Ex-specific supplement to these Operating Instructions.

Please do not hesitate to contact your Endress+Hauser representative if you have any questions.



Caution!

Electrostatic charge!

Risk of damaging electronic components or impairing their function (ESD protection).

- Use a workplace with a grounded working surface, purpose-built for electrostatically sensitive devices!
- Use only genuine Endress+Hauser parts.

Procedure when installing/removing electronics boards (→  27)

1. Unscrew the cover (a) of the electronics compartment from the transmitter housing.
2. Remove the local display module (b) from the retaining rails (c).
3. Attach the local display module (b) to the right retaining rail (c) with the left side. This secures the local display module.
4. Loosen the fixing screws (d) of the cover of the connection compartment (e) and fold down the cover.
5. Pull terminal connector (f) out of the I/O board (COM module) (q).
6. Fold up the plastic cover (g).
7. Remove the signal cable connector (h) from the amplifier board (s) and release from the cable holder (i).
8. Remove the ribbon cable connector (j) from the amplifier board (s) and release from the cable holder (k).
9. Remove the local display module (b) from the right retaining rail (c).
10. Fold down the plastic cover (g) again.
11. Release both screws (l) of the board holder (m).
12. Pull the board holder (m) out completely.
13. Press the side latches (n) of the board holder and separate the board holder (m) from the board body (o).
14. Replace the I/O board (COM module) (q):
 - Loosen the three fixing screws (p) of the I/O board (COM module).
 - Remove the I/O board (COM module) (q) from the board body (o).
 - Set a new I/O board (COM module) on the board body.
15. Replace the amplifier board (s):
 - Loosen fixing screws (r) of the amplifier board.
 - Remove the amplifier board (s) from the board body (o).
 - Set a new amplifier board on the board body.
16. Installation is the reverse of the removal procedure.

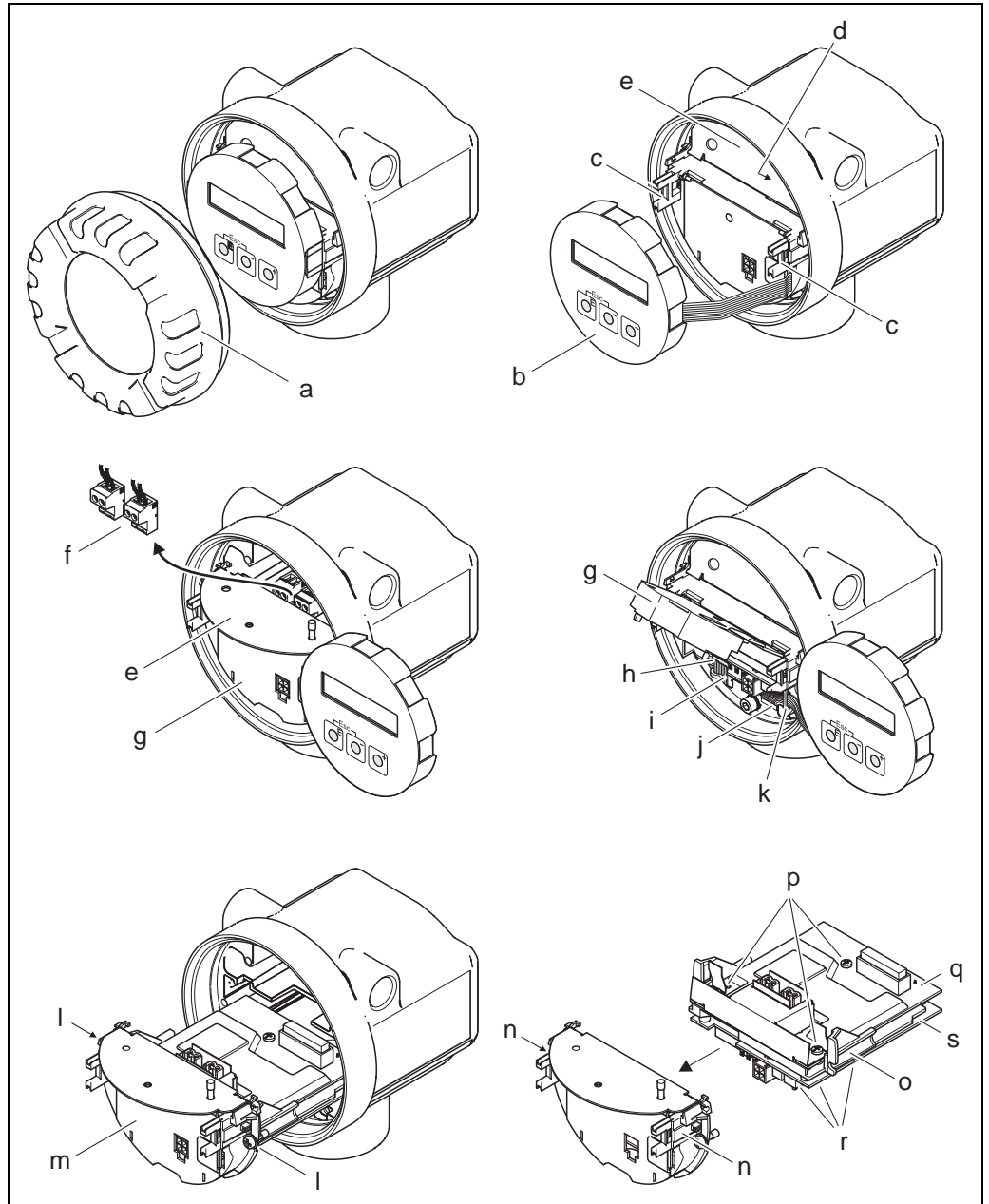

Fig. 27: Installing and removing electronics boards Non-Ex, Ex-i and Ex-n version

- a Cover of electronics compartment
- b Local display module
- c Retaining rails for local display module
- d Fixing screws for cover of connection compartment
- e Cover of connection compartment
- f Terminal connector
- g Plastic cover
- h Signal cable connector
- i Retainer for signal cable connector
- j Display module ribbon-cable connector
- k Retainer for ribbon-cable connector
- l Board holder threaded connection
- m Board holder
- n Board holder latches
- o Board body
- p I/O board (COM module) threaded connection
- q I/O board (COM module)
- r Amplifier board threaded connection
- s Amplifier board

Ex-d version**Warning!**

When connecting Ex-certified devices, please refer to the notes and diagrams in the Ex-specific supplement to these Operating Instructions.

Please do not hesitate to contact your Endress+Hauser representative if you have any questions.

**Caution!**

Electrostatic charge!

Risk of damaging electronic components or impairing their function (ESD protection).

- Use a workplace with a grounded working surface, purpose-built for electrostatically sensitive devices!
- Use only genuine Endress+Hauser parts.

Procedure when installing/removing electronics boards (→  28)

Installing/removing the I/O board (COM module)

1. Release securing clamp (a) of the connection compartment cover (b).
2. Unscrew the cover (b) of the connection compartment from the transmitter housing.
3. Disconnect terminal connector (c) from the I/O board (COM module) (e).
4. Release threaded connection (d) of the I/O board (COM module) (e) and pull out the board slightly.
5. Disconnect connection cable plug (f) from the I/O board (COM module) (e) and remove the board completely.
6. Installation is the reverse of the removal procedure.

Installing/removing the amplifier board:

1. Unscrew the cover (g) of the electronics compartment from the transmitter housing.
2. Remove the local display module (h) from the retaining rails (i).
3. Fold up the plastic cover (j).
4. Remove ribbon-cable connector of the local display module (h) from the amplifier board (t) and release from the cable holder.
5. Remove the signal cable connector (k) from the amplifier board (t) and release from the cable holder.
6. Release the fixing screw (l) and fold down the cover (m).
7. Release both screws (n) of the board holder (o).
8. Pull out the board holder (o) slightly and disconnect connecting cable plug (p) from the board body.
9. Pull the board holder (o) out completely.
10. Press the side latches (q) of the board holder and separate the board holder (o) from the board body (r).
11. Replace the amplifier board (t):
 - Loosen fixing screws (s) of the amplifier board.
 - Remove the amplifier board (t) from the board body (r).
 - Set a new amplifier board on the board body.
12. Installation is the reverse of the removal procedure.

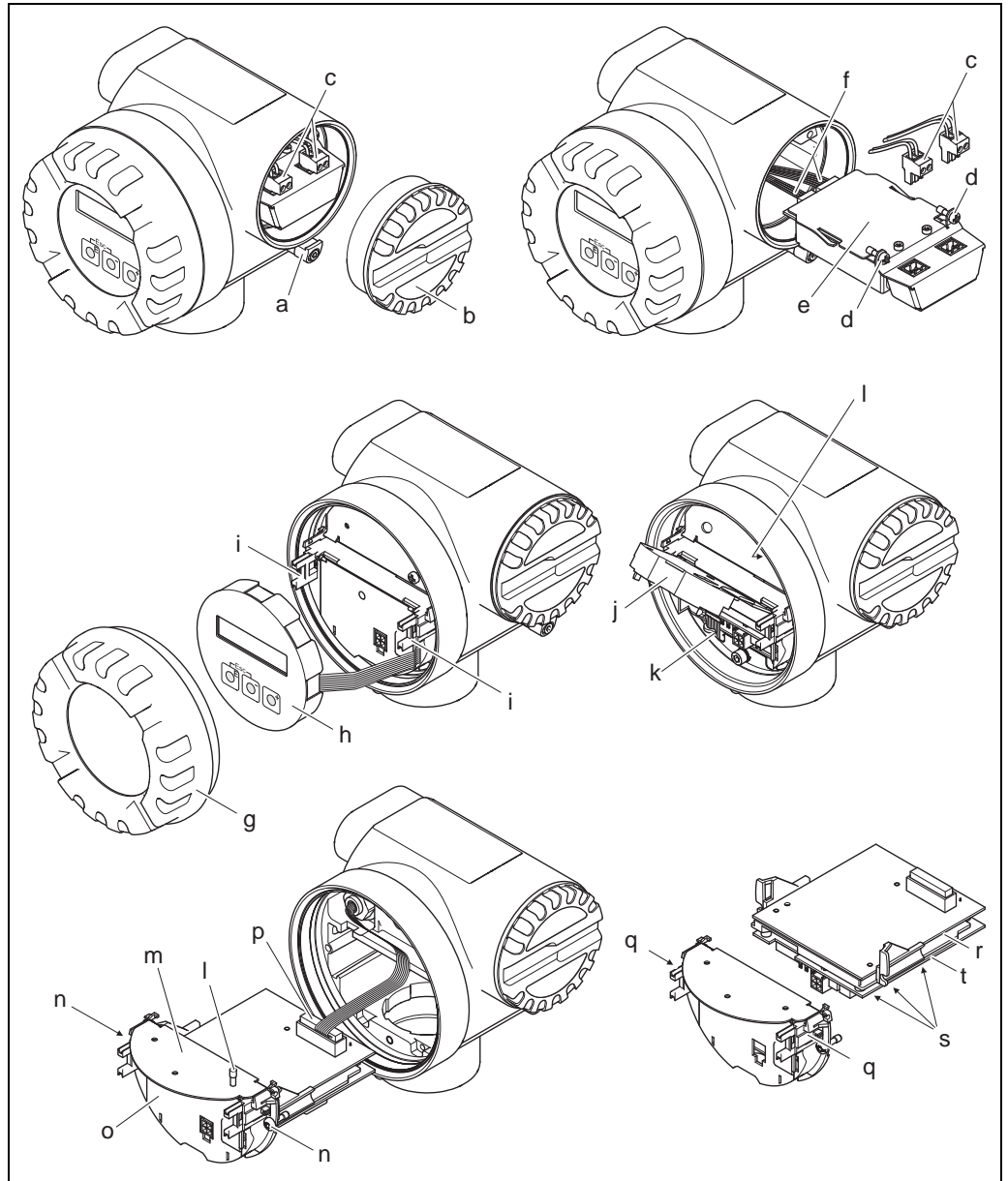

A0001920

Fig. 28: Installing and removing electronics boards Ex-d version

- a Clamp securing the cover of the connection compartment
- b Cover of connection compartment
- c Terminal connector
- d I/O board (COM module) threaded connection
- e I/O board (COM module)
- f Connecting cable plug I/O-module
- g Cover of electronics compartment
- h Local display module
- i Retaining rails for local display module
- j Plastic cover
- k Signal cable connector
- l Fixing screws for cover of connection compartment
- m Connection compartment cover
- n Board holder threaded connection
- o Board holder
- p Connecting cable plug
- q Board holder latches
- r Board body
- s Amplifier board threaded connection
- t Amplifier board

9.7 Return

→  8

9.8 Disposal

Observe the regulations applicable in your country!

9.9 Software history



Note!

Upload/download between different software versions is normally only possible with special service software.

Date	Software version	Software modification	Documentation
06.2010	V 1.05.XX	Software extension: <ul style="list-style-type: none"> ■ Implementation of a calibration history 	BA00084D/06/EN/01.11 71128081
12.2008	V 1.04.XX	Software extension: New functionalities: <ul style="list-style-type: none"> ■ New languages: Russian, Japanese, Chinese 	BA084D/06/en/11.08 71081840
01.2007	V 1.03.XX	Software extension: Flanged devices with reduced inner diameter (R Type, S Type) New functionalities: <ul style="list-style-type: none"> ■ Device software displayed (NAMUR Recommendation NE 53) ■ Supervision of maximum flow velocity in the device (incl. warning message) 	BA084D/06/en/01.07 71039102
11.2004	Amplifier: V 1.02.XX	Software extension: <ul style="list-style-type: none"> ■ SIL 2 conformity as of V: 1.02.01 (03.2005) ■ Correction of diameter mismatch for devices with weld-on flanges New functionalities: <ul style="list-style-type: none"> ■ Operation in Polish and Czech as of V 1.02.01 	BA084D/06/en/12.05 71008404
07.2003	Amplifier: V 1.01.XX	Upload/download via HART using ToF Tool - Fieldtool Package	BA084D/06/en/12.03 50103643
01.2003	Amplifier: V 1.00.00	Original software Compatible with: <ul style="list-style-type: none"> ■ ToF Tool - Fieldtool Package ■ HART communicator DXR275 (OS 4.6 or higher) and DRX 375 with rev. 1 or higher, DD rev. 1 	

10 Technical data

10.1 Technical data at a glance

10.1.1 Application

The measuring system is used to measure the volume flow of saturated steam, superheated steam, gases and liquids. If the process pressure and process temperature are constant, the measuring device can also output the flow as the calculated mass flow and corrected volume flow.

10.1.2 Function and system design

Measuring principle Vortex flow measurement on the principle of the Karman vortex street.

Measuring system The measuring system consists of a transmitter and a sensor:

- Transmitter Prowirl 72
- Prowirl F or W sensor

Two versions are available:

- Compact version: Transmitter and sensor form a single mechanical unit.
- Remote version: Sensor is mounted separate from the transmitter.

10.1.3 Input

Measured variable

- Volumetric flow (volume flow) → is proportional to the frequency of vortex shedding after the bluff body.
- The output variables are volume flow or, if the process conditions are non-varying, calculated mass flow or corrected volume flow.

Measuring range The measuring range depends on the fluid and the pipe diameter.

Start of measuring range:

See Technical Information TI00070D/06/EN

Full scale value:

Liquids: $v_{\max} = 9 \text{ m/s}$ (30 ft/s)

Gas/steam: see table

Nominal diameter	v_{\max}
Standard version: DN 15 (1/2") R Style: DN 25 (1") > DN 15 (1/2") S Style: DN 40 (1 1/2") >> DN 15 (1/2")	46 m/s (151 ft/s) or Mach 0.3 (depending on which value is smaller)
Standard version: DN 25 (1"), DN 40 (1 1/2") R Style: – DN 40 (1 1/2") > DN 25 (1") – DN 50 (2") > DN 40 (1 1/2") S Style: – DN 80 (3") >> DN 40 (1 1/2")	75 m/s (246 ft/s) or Mach 0.3 (depending on which value is smaller)
Standard version: DN 50 to 300 (2 to 12") R Style: – DN 80 (3") > DN 50 (2") – Nominal diameters larger than DN 80 (3") S Style: – DN 100 (4") >> DN 50 (2") – Nominal diameters larger than DN 100 (4")	120 m/s (394 ft/s) or Mach 0.3 (depending on which value is smaller) Calibrated range: up to 75 m/s (246 ft/s)



Note!

By using the selection and planning program "Applicator", you can determine the exact values for the fluid you use. You can obtain the Applicator from your Endress+Hauser sales center or on the Internet under www.applicator.com.

K-factor range:

The table is used for orientation purposes. The range in which the K-factor can be is indicated for individual nominal diameters and designs.

Nominal diameter		K-factor range [pul./dm ³]	
DIN	ANSI	72F	72W
DN 15	½"	390 to 450	245 to 280
DN 25	1"	70 to 85	48 to 55
DN 40	1½"	18 to 22	14 to 17
DN 50	2"	8 to 11	6 to 8
DN 80	3"	2.5 to 3.2	1.9 to 2.4
DN 100	4"	1.1 to 1.4	0.9 to 1.1
DN 150	6"	0.3 to 0.4	0.27 to 0.32
DN 200	8"	0.1266 to 0.1400	–
DN 250	10"	0.0677 to 0.0748	–
DN 300	12"	0.0364 to 0.0402	–

10.1.4 Output

Outputs, general

The following measured variables can generally be output via the outputs.

Measured variable	Current output	Pulse output	Status output
Volume flow	If configured	If configured	Limit value (flow or totalizer)
Mass flow	If configured	If configured	Limit value (flow or totalizer)
Corrected volume flow	If configured	If configured	Limit value (flow or totalizer)

Output signal

Current output:

- 4 to 20 mA with HART
- Full scale value and time constant (0 to 100 s) can be set

Pulse/status output:

Open collector, passive, galvanically isolated

- Non-Ex, Ex-d version: $U_{max} = 36\text{ V}$, with 15 mA current limiting, $R_i = 500\ \Omega$
- Ex-i and Ex-n version: $U_{max} = 30\text{ V}$, with 15 mA current limiting, $R_i = 500\ \Omega$

The pulse/status output can be configured as:

- Pulse output:
 - Pulse value and polarity can be selected (→ 91)
 - Pulse width adjustable (0.005 to 2 s)
 - Pulse frequency max. 100 Hz
- Status output:
 - Can be configured for error messages or flow limit values

- Vortex frequency:
 - Direct output of unscaled vortex pulses 0.5 to 2850 Hz (e.g. for connecting to a flow computer RMC621)
 - Pulse ratio 1:1
- PFM signal (pulse/frequency modulation):
 - For external connection with flow computer RMC or RMS621.

Signal on alarm

- Current output: failsafe mode can be selected (e.g. in accordance with NAMUR Recommendation NE 43)
- Pulse output: failsafe mode can be selected
- Status output: "not conductive" during fault

Load

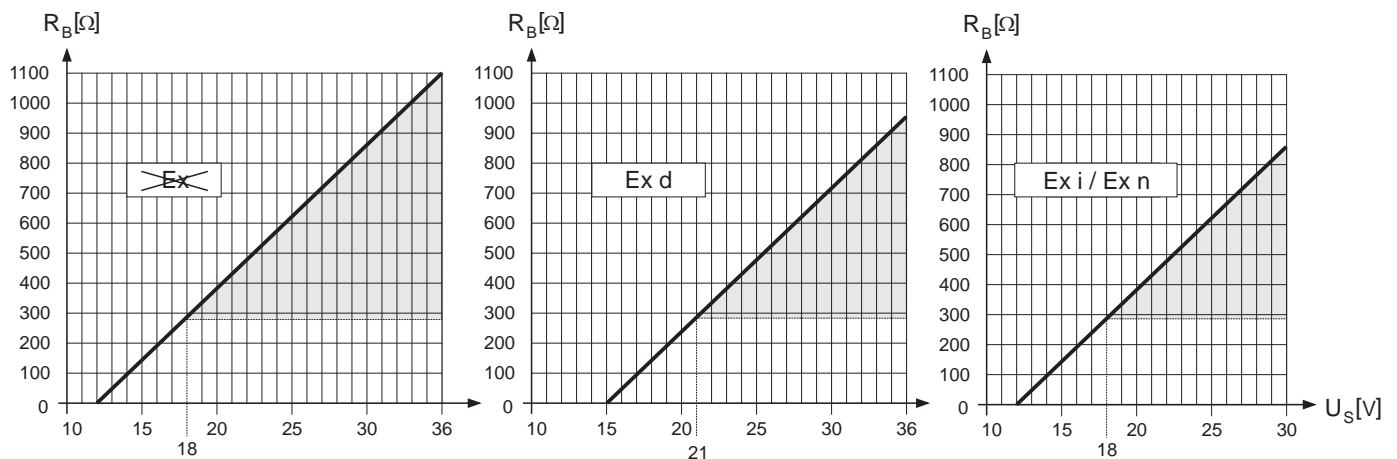

The area marked in gray indicates the permissible load (with HART: min. 250Ω)

A0001921

The load is calculated as follows:

$$R_B = \frac{(U_S - U_{Kl})}{(I_{max} - 10^{-3})} = \frac{(U_S - U_{Kl})}{0.022}$$

A0004059

- R_B Load, load resistance
- U_S Supply voltage:
 - Non-Ex = 12 to 36 V DC
 - Ex-d = 15 to 36 V DC
 - Ex-i and Ex-n = 12 to 30 V DC
- U_{Kl} Terminal voltage:
 - Non-Ex = min. 12 V DC
 - Ex-d = min. 15 V DC
 - Ex-i and Ex-n = min. 12 V DC
- I_{max} Output current (22.6 mA)



Low flow cut off

Switch points for low flow cutoff are selectable.

Galvanic isolation

All electrical connections are galvanically isolated themselves.

10.1.5 Power supply

Electrical connection	→  21
Supply voltage	Non-Ex: 12 to 36 V DC (with HART: 18 to 36 V DC) Ex-i and Ex-n: 12 to 30 V DC (with HART 18 to 30 V DC) Ex-d: 15 to 36 V DC (with HART: 21 to 36 V DC)
Cable entry	<i>Power supply and signal cables (outputs):</i> <ul style="list-style-type: none"> ■ Cable entry M20 × 1.5 (6 to 12 mm / 0.24 to 0.47") ■ Cable entry M20 × 1.5 for armored signal cable (9.5 to 16 mm / 0.37 to 0.63") ■ Thread for cable entry: ½" NPT, G ½", G ½" Shimada
Cable specification	<ul style="list-style-type: none"> ■ Permitted temperature range: <ul style="list-style-type: none"> – Standard cable: –40 °C (–40 °F) to max. permissible ambient temperature plus 10 °C (18 °F) – Armored cable: –30 to +70 °C (–22 to +158 °F) ■ Remote version →  22
Power supply failure	<ul style="list-style-type: none"> ■ Totalizer stops at the last value determined. ■ All settings are kept in the EEPROM. ■ Error messages (incl. value of operated hours counter) are stored.

10.1.6 Performance characteristics

Reference operating conditions	Error limits following ISO/DIN 11631: <ul style="list-style-type: none"> ■ +20 to +30 °C (+68 to +86 °F) ■ 2 to 4 bar (29 to 58 psi) ■ Calibration rig traced to national standards ■ Calibration with the process connection corresponding to the particular standard
Maximum measured error	<ul style="list-style-type: none"> ■ Volume flow (liquid): <ul style="list-style-type: none"> < 0.75% o.r. for Re > 20000 < 0.75% o.f.s for Re between 4000 and 20000 ■ Volume flow (gas/steam): <ul style="list-style-type: none"> < 1% o.r. for Re > 20000 and v < 75 m/s (246 ft/s) < 1% o.f.s for Re between 4000 and 20000 <p>o.r. = of reading, o.f.s = of full scale value, Re = Reynolds number</p> <p><i>Diameter mismatch correction</i></p> <p>In the Prowirl 72 shifts in the calibration factor which are caused by a diameter mismatch between the device and the mating pipe can be corrected (→  104). The diameter mismatch should only be corrected within the limit values listed below for which test measurements have also been performed.</p> <p>Flange connection:</p> <ul style="list-style-type: none"> ■ DN 15 (½"): ±20% of the internal diameter ■ DN 25 (1"): ±15% of the internal diameter ■ DN 40 (1½"): ±12% of the internal diameter ■ DN ≥50 (2"): ±10% of the internal diameter <p>Wafer:</p> <ul style="list-style-type: none"> ■ DN 15 (½"): ±15% of the internal diameter ■ DN 25 (1"): ±12% of the internal diameter ■ DN 40 (1½"): ±9% of the internal diameter ■ DN ≥50 (2"): ±8% of the internal diameter
Repeatability	±0.25% o.r. (of reading)

Reaction time/ step response time	<p>If all configurable functions are set to 0, you must reckon with a reaction time/step response time of 200 ms for vortex frequencies as of 10 Hz. Other settings require a reaction time/step response time of 100 ms to be added to the total filter reaction time for vortex frequencies as of 10 Hz.</p> <ul style="list-style-type: none"> ■ FLOW DAMPING → 106 ■ DISPLAY DAMPING → 86 ■ TIME CONSTANT (current output) → 89 ■ TIME CONSTANT (status output) → 97
--------------------------------------	--

Influence of ambient temperature	<p><i>Current output (additional error, in reference to the span of 16 mA)</i></p> <ul style="list-style-type: none"> ■ Zero point (4 mA): average T_k: 0.05%/10K, max. 0.6% over the entire temperature range of -40 to +80 °C (-40 to +176 °F) ■ Span (20 mA): average T_k: 0.05%/10K, max. 0.6% over the entire temperature range of -40 to +80 °C (-40 to +176 °F)
-------------------------------------	--

Digital outputs (pulse output, PFM, HART)

Due to the digital measuring signal (vortex pulse) and further digital processing, there is no interface-related error from changing ambient temperature.

10.1.7 Operating conditions: installation

Installation instructions	→ 13
---------------------------	------

Inlet and outlet run	→ 16
----------------------	------

10.1.8 Operating conditions: environment

Ambient temperature range	<p><i>Compact version</i></p> <ul style="list-style-type: none"> ■ Standard: -40 to +70 °C (-40 to +158 °F) ■ EEx-d version: -40 to +60 °C (-40 to +140 °F) ■ ATEX II 1/2 GD version/dust ignition-proof: -20 to +55 °C (-4 to +131 °F) ■ Display can be read between -20 to +70 °C (-4 to +158 °F)
---------------------------	---

Remote version sensor

- Standard: -40 to +85 °C (-40 to +185 °F)
- with armored cable: -30 to +70 °C (-22 to +158 °F)
- ATEX II 1/2 GD version/dust ignition-proof: -20 to +55 °C (-4 to +131 °F)

Remote version transmitter

- Standard: -40 to +80 °C (-40 to +176 °F)
- with armored cable: -30 to +70 °C (-22 to +158 °F)
- EEx-d version: -40 to +60 °C (-40 to +140 °F)
- ATEX II 1/2 GD version/dust ignition-proof: -20 to +55 °C (-4 to +131 °F)
- Display can be read between -20 to +70 °C (-4 to +158 °F)
- Version up to -50 °C (-58 °F) on request

To protect the measuring device from direct sunlight when installing the unit outdoors, a protective cover (order number 543199-0001) is recommended. This applies in particular to warmer climates with high ambient temperatures.

Storage temperature	Standard: -40 to +80 °C (-40 to +176 °F) ATEX II 1/2 GD version/dust ignition-proof: -20 to +55 °C (-4 to +131 °F) Version up to -52 °C (-62 °F) on request
Degree of protection	IP 67 (NEMA 4X) in accordance with EN 60529
Vibration resistance	Acceleration up to 1 g (at factory setting of the gain), 10 to 500 Hz, following IEC 60068-2-6
Electromagnetic compatibility (EMC)	To IEC/EN 61326 and NAMUR Recommendation NE 21

10.1.9 Operating conditions: process

Medium temperature

DSC sensor (differential switched capacitor; capacitive sensor)	
DSC standard sensor	-40 to +260 °C (-40 to +500 °F)
DSC high/low temperature sensor	-200 to +400 °C (-328 to +752 °F)
DSC sensor Inconel (PN 63 to 160, Class 600, JIS 40K)	-200 to +400 °C (-328 to +752 °F)
DSC sensor titanium Gr. 5 (PN 250, Class 900 to 1500 and butt-weld version)	-50 to +400 °C (-58 to +752 °F)
DSC sensor Alloy C-22	-200 to +400 °C (-328 to +752 °F)

Seals	
Graphite	-200 to +400 °C (-328 to +752 °F)
Viton	-15 to +175 °C (+5 to +347 °F)
Kalrez	-20 to +275 °C (-4 to +527 °F)
Gylon (PTFE)	-200 to +260 °C (-328 to +500 °F)

Sensor	
Stainless steel	-200 to +400 °C (-328 to +752 °F)
Alloy C-22	-40 to +260 °C (-40 to +500 °F)
Special version for high fluid temperatures (on request)	-200 to +450 °C (-328 to +842 °F) -200 to +440 °C (-328 to +824 °F), Ex version

Medium pressure

Pressure-temperature curve to EN (DIN), stainless steel

PN 10 to 40 → Prowirl 72W and 72F

PN 63 to 250 → Prowirl 72F

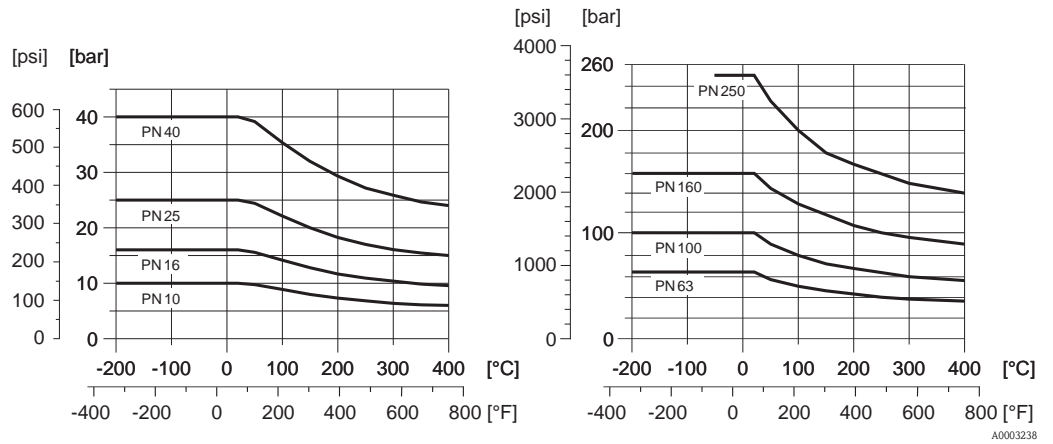

Pressure-temperature curve to ANSI B16.5, stainless steel

Class 150 to 300 → Prowirl 72W and 72F

Class 600 to 1500 → Prowirl 72F

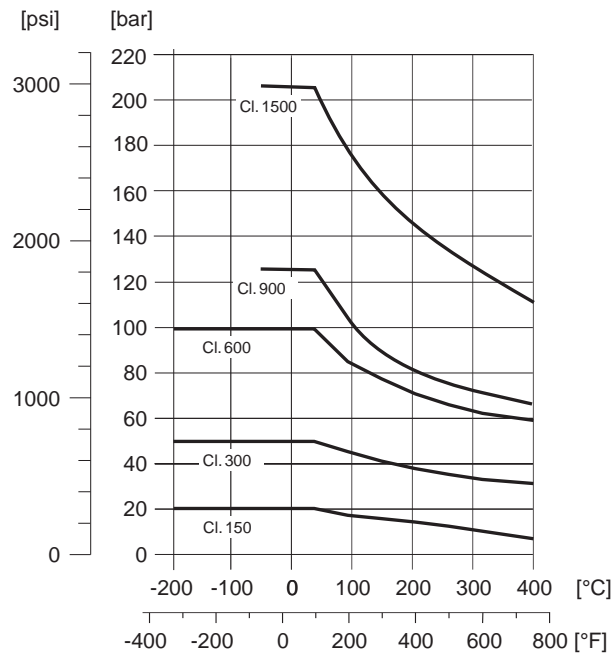

Pressure-temperature curve to JIS B2220, stainless steel

10 to 20K → Prowirl 72W and 72F

40K → Prowirl 72F

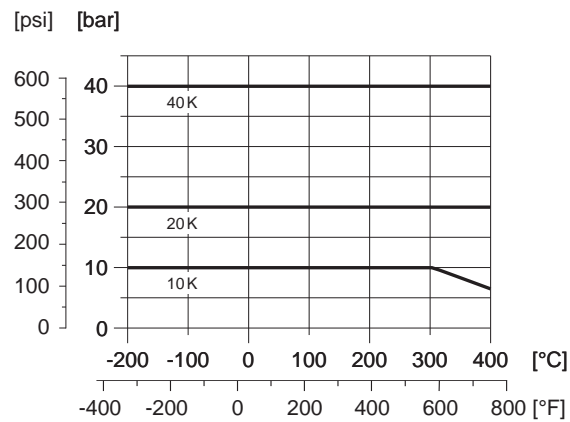

A0003404

Pressure-temperature curve to EN (DIN), ANSI B16.5 and JIS B2220, Alloy C-22

PN 16 to 40, Class 150 to 300, 10 to 20K → Prowirl 72F

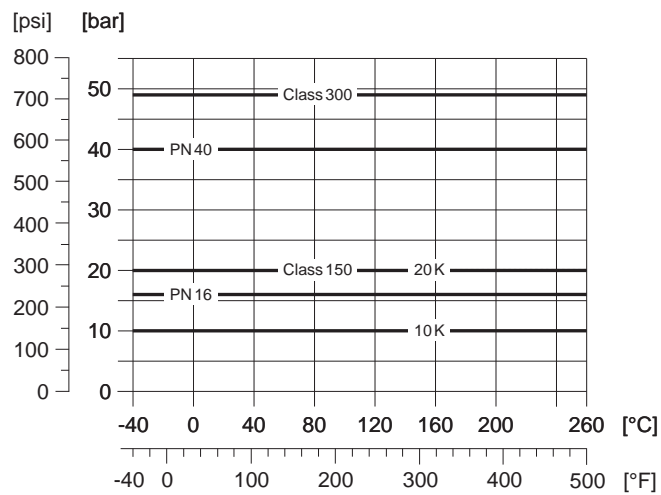

A0003395

Limiting flow See information on → 59 ("Measuring range")

Pressure loss The pressure loss can be determined with the aid of the Applicator. The Applicator is software for selecting and planning flowmeters. The software is available both via the Internet (www.applicator.com) and on a CD-ROM for local PC installation.

10.1.10 Frequency ranges for air and water

For further media, e.g. steam, you can find information in the Applicator.

Prowirl 72W (SI units)

DN (DIN)	Air (at 0 °C, 1.013 bar)			Water (at 20 °C)			K-factor
	Corrected volume flow (\dot{V}) in [m ³ /h]			Volume flow (\dot{V}) in [m ³ /h]			[Pulse/dm ³]
	\dot{V}_{\min}	\dot{V}_{\max}	Frequency range [Hz]	\dot{V}_{\min}	\dot{V}_{\max}	Frequency range [Hz]	Min. to max.
DN 15	4	35	330 to 2600	0.19	7	10.0 to 520	245 to 280
DN 25	11	160	180 to 2300	0.41	19	5.7 to 300	48 to 55
DN 40	31	375	140 to 1650	1.1	45	4.6 to 200	14 to 17
DN 50	50	610	100 to 1200	1.8	73	3.3 to 150	6 to 8
DN 80	112	1370	75 to 850	4.0	164	2.2 to 110	1.9 to 2.4
DN 100	191	2330	70 to 800	6.9	279	2.0 to 100	1.1 to 1.4
DN 150	428	5210	38 to 450	15.4	625	1.2 to 55	0.27 to 0.32

Prowirl 72W (US units)

DN (ANSI)	Air (at 32 °F, 14.7 psia)			Water (at 68 °F)			K-factor
	Corrected volume flow (\dot{V}) in [scfm]			Volume flow (\dot{V}) in [gpm]			[Pulse/dm ³]
	\dot{V}_{\min}	\dot{V}_{\max}	Frequency range [Hz]	\dot{V}_{\min}	\dot{V}_{\max}	Frequency range [Hz]	Min. to max.
½"	2.35	20.6	330 to 2600	0.84	30.8	10.0 to 520	245 to 280
1"	6.47	94.2	180 to 2300	1.81	83.7	5.7 to 300	48 to 55
1½"	18.2	221	140 to 1650	4.84	198	4.6 to 200	14 to 17
2"	29.4	359	100 to 1200	7.93	321	3.3 to 150	6 to 8
3"	65.9	806	75 to 850	17.6	722	2.2 to 110	1.9 to 2.4
4"	112	1371	70 to 800	30.4	1228	2.0 to 100	1.1 to 1.4
6"	252	3066	38 to 450	67.8	2752	1.2 to 55	0.27 to 0.32

Prowirl 72F (SI units)

DN (DIN)	Air (at 0 °C, 1.013 bar)			Water (at 20 °C)			K-factor
	Corrected volume flow (\dot{V}) in [m ³ /h]			Volume flow (\dot{V}) in [m ³ /h]			[Pulse/dm ³]
	\dot{V}_{min}	\dot{V}_{max}	Frequency range [Hz]	\dot{V}_{min}	\dot{V}_{max}	Frequency range [Hz]	Min. to max.
DN 15	3	25	330 to 2850	0.16	5	14.0 to 600	390 to 450
DN 25	9	125	200 to 2700	0.32	15	6.5 to 340	70 to 85
DN 40	25	310	150 to 1750	0.91	37	4.5 to 220	18 to 22
DN 50	42	510	120 to 1350	1.5	62	3.7 to 170	8 to 11
DN 80	95	1150	80 to 900	3.4	140	2.5 to 115	2.5 to 3.2
DN 100	164	2000	60 to 700	5.9	240	1.9 to 86	1.1 to 1.4
DN 150	373	4540	40 to 460	13.4	550	1.2 to 57	0.3 to 0.4
DN 200	715	8710	27 to 322	25.7	1050	1.0 to 39	0.1266 to 0.14
DN 250	1127	13740	23 to 272	40.6	1650	0.8 to 33	0.0677 to 0.0748
DN 300	1617	19700	18 to 209	58.2	2360	0.6 to 25	0.0364 to 0.0402

Prowirl 72F (US units)

DN (ANSI)	Air (at 32 °F, 14.7 psia)			Water (at 68 °F)			K-factor
	Corrected volume flow (\dot{V}) in [scfm]			Volume flow (\dot{V}) in [gpm]			[Pulse/dm ³]
	\dot{V}_{min}	\dot{V}_{max}	Frequency range [Hz]	\dot{V}_{min}	\dot{V}_{max}	Frequency range [Hz]	Min. to max.
½"	1.77	14.7	380 to 2850	0.70	22.0	14.0 to 600	390 to 450
1"	5.30	73.6	200 to 2700	1.41	66.0	6.5 to 340	70 to 85
1½"	14.7	182	150 to 1750	4.01	163	4.5 to 220	18 to 22
2"	24.7	300	120 to 1350	6.6	273	3.7 to 170	8 to 11
3"	55.9	677	80 to 900	15.0	616	2.5 to 115	2.5 to 3.2
4"	96.5	1177	60 to 700	26.0	1057	1.9 to 86	1.1 to 1.4
6"	220	2672	40 to 460	59.0	2422	1.2 to 57	0.3 to 0.4
8"	421	5126	27 to 322	113	4623	1.0 to 39	0.1266 to 0.14
10"	663	8087	23 to 272	179	7265	0.8 to 33	0.0677 to 0.0748
12"	952	11 595	18 to 209	256	10 391	0.6 to 25	0.0364 to 0.0402

10.1.11 Mechanical construction

Design, dimensions See Technical Information TI00070D/06/EN

Weight See Technical Information TI00070D/06/EN

Material

Transmitter housing

- Powder-coated die-cast aluminum AlSi10Mg
 - In accordance with EN 1706/EN AC-43400
(EEx d version: cast aluminum EN 1706/EN AC-43000)

Sensor

Flanged version

- Pressure ratings up to PN 40, Class 300, 20K:
 - Stainless steel, A351-CF3M (1.4408), in compliance with AD2000 (temperature range -10 to +400 °C/ +14 to +752 °F) as well as in compliance with NACE MR0175-2003 and MR0103-2003
 - Alloy C-22, 2.4602, (A494-CX2MW/N26022), in compliance with NACE MR0175-2003 and MR0103-2003
- Pressure ratings up to PN 160, Class 600, 40K:
 - Stainless steel, A351-CF3M (1.4408), in compliance with AD2000 (temperature range -10 to +400 °C/ +14 to +752 °F) as well as in compliance with NACE MR0175-2003 and MR0103-2003
- Pressure ratings PN 250, Class 900 to 1500 and butt-weld version:
 - Stainless steel, 316Ti/316L (1.4571), NACE available on request

Wafer version

- Pressure ratings up to PN 40, Class 300, 20K:
 - Stainless steel, A351-CF3M (1.4408), in compliance with AD2000 (temperature range -10 to +400 °C/ +14 to +752 °F) as well as in compliance with NACE MR0175-2003 and MR0103-2003

Flanges

- EN (DIN)
 - Stainless steel, A351-CF3M (1.4404), in compliance with NACE MR0175-2003 and MR0103-2003
 - DN 15 to 150 with pressure ratings to PN 40 and all devices with integrated diameter reduction (R Style, S Style): construction with weld-on flanges made of 1.4404 (AISI 316L). All nominal diameters PN 63 to 160 as well as nominal diameters DN 200 to 300 to PN 40: fully cast construction A351-CF3M (1.4408), in compliance with NACE MR0175-2003 and MR0103-2003
 - Pressure rating PN 250 1.4571 (316Ti, UNS S31635), in compliance with NACE MR0175-2003 and MR0103-2003 available on request
- ANSI and JIS
 - Stainless steel, A351-CF3M, in compliance with NACE MR0175-2003 and MR0103-2003
 - ½ to 6" with pressure ratings to Class 300 and DN 15 to 150 with pressure ratings to 20K and all devices with integrated diameter reduction (R Style, S Style): construction with weld-on flanges made of 316/316L, in compliance with NACE MR0175-2003 and MR0103-2003. All nominal diameters Class 600, 40K as well as nominal diameters DN 200 to 300 to Class 300, 20K: fully cast construction A351-CF3M, in compliance with NACE MR0175-2003 and MR0103-2003
 - Pressure ratings Class 900 to 1500: 316/316L, in compliance with NACE MR0175-2003 and MR0103-2003 available on request
- Alloy C-22 version (EN/DIN/ANSI/JIS)
 - Alloy C-22, 2.4602, (A494-CX2MW/N26022), in compliance with NACE MR0175-2003 and MR0103-2003

DSC sensor (differential switched capacitor)

- Wetted parts (marked as "wet" on the DSC sensor flange):
 - Standard for pressure ratings up to PN 40, Class 300, JIS 40K: Stainless steel 1.4435 (316/316L), in compliance with NACE MR0175-2003 and MR0103-2003
 - Pressure ratings PN 63 to 160, Class 600, 40K: Inconel 718 (2.4668/N07718, according to B637), in compliance with NACE MR0175-2003 and MR0103-2003
 - Pressure ratings PN 250, Class 900 to 1500 and butt-weld version: titanium Gr. 5 (B-348; UNS R50250; 3.7165)
 - Alloy C-22 sensor: Alloy C-22, 2.4602/N 06022; in compliance with NACE MR0175-2003 and MR0103-2003

Non-wetted parts

- Stainless steel 1.4301 (304)

Support

- Stainless steel, 1.4308 (CF8)
- Pressure ratings PN 250, Class 900 to 1500 and butt-weld version: 1.4305 (303)



Seals

- Graphite
 - Pressure rating PN 10 to 40, Class 150 to 300, JIS 10 to 20K: Sigraflex Folie Z (BAM-tested for oxygen applications)
 - Pressure rating PN 63 to 160, Class 600, JIS 40K: Sigraflex Hochdruck™ with stainless steel sheet reinforcement made of 316(L) (BAM-tested for oxygen applications, "high quality in terms of TA Luft (German Clean Air Act)")
 - Pressure rating PN 250, Class 900 to 1500: Grafoil with perforated stainless steel reinforcement made of 316
- Viton
- Kalrez 6375
- Gylon (PTFE) 3504 (BAM-tested for oxygen applications, "high quality in terms of TA Luft (German Clean Air Act)")

10.1.12 Human interface

Display elements	<ul style="list-style-type: none"> ■ Liquid crystal display, two-line, plain text display, 16 characters per line ■ Display can be configured individually, e.g. for measured variables and status variables, totalizers
Operating elements	<ul style="list-style-type: none"> ■ Local operation with three keys (⊕, ⊖, ⊞) ■ Quick Setup for quick commissioning ■ Operating elements accessible also in Ex zones
Remote operation	<p>Operation via:</p> <ul style="list-style-type: none"> ■ HART protocol ■ FieldCare (software package from Endress+Hauser for complete configuration, commissioning and diagnosis)

10.1.13 Certificates and approvals

CE approval	→  11
C-Tick mark	→  11
Ex approval	More information on the Ex approvals can be found in the separate Ex documentation.
Pressure measuring device approval	<p>The measuring devices can be ordered with or without PED (Pressure Equipment Directive). If a device with PED is required, this must be ordered explicitly. For devices with nominal diameters less than or equal to DN 25 (1"), this is neither possible nor necessary.</p> <ul style="list-style-type: none"> ■ With the identification PED/G1/III on the sensor nameplate, Endress+Hauser confirms conformity with the "Basic safety requirements" of Appendix I of the Pressure Equipment Directive 97/23/EC. ■ Devices with this identification (with PED) are suitable for the following types of fluid: <ul style="list-style-type: none"> – Fluids of Group 1 and 2 with a steam pressure of greater or less than 0.5 bar (7.3 psi) – Unstable gases ■ Devices without this identification (without PED) are designed and manufactured according to good engineering practice. They correspond to the requirements of Art. 3, Section 3 of the Pressure Equipment Directive 97/23/EC. Their application is illustrated in Diagrams 6 to 9 in Appendix II of the Pressure Equipment Directive 97/23/EC.
Functional safety	<p>SIL 2 in accordance with IEC 61508/IEC 61511-1</p> <p>Following the link http://www.endress.com/sil, you will find an overview of all Endress+Hauser devices for SIL applications including parameters like SFF, MTBF, PFD_{avg} etc.</p>
Other standards and guidelines	<ul style="list-style-type: none"> ■ EN 60529 Degrees of protection by housing (IP code) ■ EN 61010-1 Safety requirements for electrical equipment for measurement, control and laboratory use ■ IEC/EN 61326 Electromagnetic compatibility (EMC requirements) ■ NAMUR NE 21 Electromagnetic compatibility (EMC) of industrial process and laboratory control equipment ■ NAMUR NE 43 Standardization of the signal level for the breakdown information of digital transmitters with analog output signal. ■ NAMUR NE 53 Software of field devices and signal-processing devices with digital electronics ■ NACE standard MR0103-2003 Standard Material Requirements - Materials Resistant to Sulfide Stress Cracking in Corrosive Petroleum Refining Environments ■ NACE standard MR0175-2003 Standard Material Requirements - Sulfide Stress Cracking Resistant Metallic Materials for Oilfield Equipment ■ VDI 2643 Measurement of fluid flow by means of vortex flowmeters. ■ ANSI/ISA-S82.01 Safety Standard for Electrical and Electronic Test, Measuring, Controlling and Related Equipment - General Requirements. Pollution degree 2, Installation Category II

- CAN/CSA-C22.2 No. 1010.1-92
Safety Standard for Electrical Equipment for Measurement and Control and Laboratory Use.
Pollution degree 2, Installation Category II

10.1.14 Ordering information

Your Endress+Hauser service organization can provide detailed ordering information and information on the order codes on request.

10.1.15 Accessories

Various accessories, which can be ordered separately from Endress+Hauser, are available for the transmitter and the sensor (→  44). Your Endress+Hauser service organization can provide detailed information on the order codes of your choice.

10.1.16 Documentation

- Flow measurement (FA00005D/06/EN)
- Technical Information Proline Prowirl 72F, 72W, 73F, 73W (TI00070/06/EN)
- Associated Ex documentation: ATEX, FM, CSA etc.
- Related documentation for Pressure Equipment Directive
Proline Prowirl 72/73 (SD00072D/06/EN)
- Functional Safety Manual (Safety Integrity Level)

10.2 Dimensions of flow conditioner

Dimensions according to:

- EN 1092-1 (DIN 2501)
- ANSI B16.5
- JIS B2220

Material 1.4404 (316/316L), in compliance with NACE MR0175-2003 and MR0103-2003

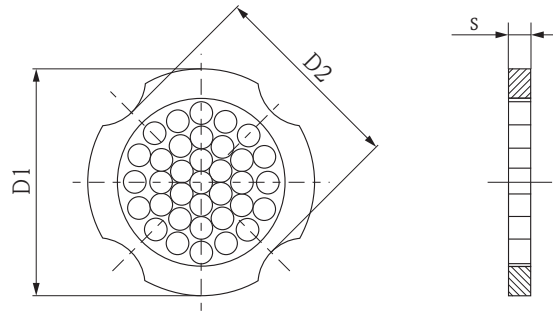

A0001941

D1: The flow conditioner is fitted at the outer diameter between the bolts.

D2: The flow conditioner is fitted at the indentations between the bolts.

Dimensions of flow conditioner according to EN (DIN)

DN	Pressure rating	Centering diameter [mm]	D1 / D2 *	s [mm]	Weight [kg]
15	PN 10 to 40	54.3	D2	2.0	0.04
	PN 63	64.3	D1		0.05
25	PN 10 to 40	74.3	D1	3.5	0.12
	PN 63	85.3	D1		0.15
40	PN 10 to 40	95.3	D1	5.3	0.3
	PN 63	106.3	D1		0.4
50	PN 10 to 40	110.0	D2	6.8	0.5
	PN 63	116.3	D1		0.6
80	PN 10 to 40	145.3	D2	10.1	1.4
	PN 63	151.3	D1		
100	PN 10/16	165.3	D2	13.3	2.4
	PN 25/40	171.3	D1		
	PN 63	176.5	D2		
150	PN 10/16	221.0	D2	20.0	6.3
	PN 25/40	227.0	D2		7.8
	PN 63	252.0	D1		7.8
200	PN 10	274.0	D1	26.3	11.5
	PN 16	274.0	D2		12.3
	PN 25	280.0	D1		12.3
	PN 40	294.0	D2		15.9
250	PN 10/16	330.0	D2	33.0	25.7
	PN 25	340.0	D1		25.7
	PN 40	355.0	D2		27.5
300	PN 10/16	380.0	D2	39.6	36.4
	PN 25	404.0	D1		36.4
	PN 40	420.0	D1		44.7

* D1 → The flow conditioner is fitted at the external diameter between the bolts.

D2 → The flow conditioner is fitted at the indentations between the bolts.

Dimensions of flow conditioner according to ANSI

DN		Pressure rating	Centering diameter mm (in)	D1 / D2 *	s mm (in)	Weight kg (lbs)
15	½"	Cl. 150	50.1 (1.97)	D1	2.0 (0.08)	0.03 (0.07)
		Cl. 300	56.5 (2.22)	D1		0.04 (0.09)
25	1"	Cl. 150	69.2 (2.72)	D2	3.5 (0.14)	0.12 (0.26)
		Cl. 300	74.3 (2.93)	D1		
40	1½"	Cl. 150	88.2 (3.47)	D2	5.3 (0.21)	0.3 (0.66)
		Cl. 300	97.7 (3.85)	D2		
50	2"	Cl. 150	106.6 (4.20)	D2	6.8 (0.27)	0.5 (1.1)
		Cl. 300	113.0 (4.45)	D1		
80	3"	Cl. 150	138.4 (5.45)	D1	10.1 (0.40)	1.2 (2.6)
		Cl. 300	151.3 (5.96)	D1		1.4 (3.1)
100	4"	Cl. 150	176.5 (6.95)	D2	13.3 (0.52)	2.7 (6.0)
		Cl. 300	182.6 (7.19)	D1		
150	6"	Cl. 150	223.9 (8.81)	D1	20.0 (0.79)	6.3 (14)
		Cl. 300	252.0 (9.92)	D1		7.8 (17)
200	8"	Cl. 150	274.0 (10.8)	D2	26.3 (1.04)	12.3 (27)
		Cl. 300	309.0 (12.2)	D1		15.8 (35)
250	10"	Cl. 150	340.0 (13.4)	D1	33.0 (1.30)	25.7 (57)
		Cl. 300	363.0 (14.3)	D1		27.5 (61)
300	12"	Cl. 150	404.0 (15.9)	D1	39.6 (1.56)	36.4 (80)
		Cl. 300	402.0 (16.5)	D1		44.6 (98)

* D1 → The flow conditioner is fitted at the external diameter between the bolts.
D2 → The flow conditioner is fitted at the indentations between the bolts.

Dimensions of flow conditioner according to JIS

DN	Pressure rating	Centering diameter [mm]	D1 / D2 *	s [mm]	Weight [kg]
15	10K	60.3	D2	2.0	0.06
	20K	60.3	D2	2.0	0.06
	40K	66.3	D1	2.0	0.06
25	10K	76.3	D2	3.5	0.14
	20K	76.3	D2	3.5	0.14
	40K	81.3	D1	3.5	0.14
40	10K	91.3	D2	5.3	0.31
	20K	91.3	D2	5.3	0.31
	40K	102.3	D1	5.3	0.31
50	10K	106.6	D2	6.8	0.47
	20K	106.6	D2	6.8	0.47
	40K	116.3	D1	6.8	0.5
80	10K	136.3	D2	10.1	1.1
	20K	142.3	D1	10.1	1.1
	40K	151.3	D1	10.1	1.3
100	10K	161.3	D2	13.3	1.8
	20K	167.3	D1	13.3	1.8
	40K	175.3	D1	13.3	2.1
150	10K	221.0	D2	20.0	4.5
	20K	240.0	D1	20.0	5.5
	40K	252.0	D1	20.0	6.2
200	10K	271.0	D2	26.3	9.2
	20K	284.0	D1	26.3	9.2
250	10K	330.0	D2	33.0	15.8
	20K	355.0	D2	33.0	19.1
300	10K	380.0	D2	39.6	26.5
	20K	404.0	D1	39.6	26.5

* D1 → The flow conditioner is fitted at the external diameter between the bolts.
D2 → The flow conditioner is fitted at the indentations between the bolts.

11 Description of device functions

11.1 Illustration of the function matrix



Groups/function groups	Functions																
MEASURED VALUES → 77	<table border="1"> <tr> <td>FLOW</td> <td>VORTEX FREQUENCY</td> <td>VELOCITY</td> </tr> </table>	FLOW	VORTEX FREQUENCY	VELOCITY													
FLOW	VORTEX FREQUENCY	VELOCITY															
↓																	
SYSTEM UNITS → 78	<table border="1"> <tr> <td>MEASURING UNIT TYPE</td> <td>UNIT FLOW</td> <td>UNIT DENSITY</td> <td>UNIT TEMPERATURE</td> </tr> <tr> <td>UNIT LENGTH</td> <td>TEXT ARBITRARY VOLUME UNIT</td> <td>FACTOR ARBITRARY VOLUME UNIT</td> <td>FORMAT DATE/TIME</td> </tr> </table>	MEASURING UNIT TYPE	UNIT FLOW	UNIT DENSITY	UNIT TEMPERATURE	UNIT LENGTH	TEXT ARBITRARY VOLUME UNIT	FACTOR ARBITRARY VOLUME UNIT	FORMAT DATE/TIME								
MEASURING UNIT TYPE	UNIT FLOW	UNIT DENSITY	UNIT TEMPERATURE														
UNIT LENGTH	TEXT ARBITRARY VOLUME UNIT	FACTOR ARBITRARY VOLUME UNIT	FORMAT DATE/TIME														
↓																	
QUICK SETUP → 82	<table border="1"> <tr> <td>QUICK SETUP COMMISSIONING</td> </tr> </table>	QUICK SETUP COMMISSIONING															
QUICK SETUP COMMISSIONING																	
↓																	
OPERATION → 83	<table border="1"> <tr> <td>LANGUAGE</td> <td>ACCESS CODE</td> <td>DEFINE PRIVATE CODE</td> <td>STATUS ACCESS</td> </tr> <tr> <td>ACCESS CODE COUNTER</td> <td></td> <td></td> <td></td> </tr> </table>	LANGUAGE	ACCESS CODE	DEFINE PRIVATE CODE	STATUS ACCESS	ACCESS CODE COUNTER											
LANGUAGE	ACCESS CODE	DEFINE PRIVATE CODE	STATUS ACCESS														
ACCESS CODE COUNTER																	
↓																	
USER INTERFACE → 85	<table border="1"> <tr> <td>ASSIGN LINE 1</td> <td>ASSIGN LINE 2</td> <td>100% VALUE</td> <td>FORMAT</td> </tr> <tr> <td>DISPLAY DAMPING</td> <td>CONTRAST LCD</td> <td>TEST DISPLAY</td> <td></td> </tr> </table>	ASSIGN LINE 1	ASSIGN LINE 2	100% VALUE	FORMAT	DISPLAY DAMPING	CONTRAST LCD	TEST DISPLAY									
ASSIGN LINE 1	ASSIGN LINE 2	100% VALUE	FORMAT														
DISPLAY DAMPING	CONTRAST LCD	TEST DISPLAY															
↓																	
TOTALIZER → 87	<table border="1"> <tr> <td>SUM</td> <td>OVERFLOW</td> <td>UNIT TOTALIZER</td> <td>RESET TOTALIZER</td> </tr> <tr> <td>FAILSAFE MODE</td> <td></td> <td></td> <td></td> </tr> </table>	SUM	OVERFLOW	UNIT TOTALIZER	RESET TOTALIZER	FAILSAFE MODE											
SUM	OVERFLOW	UNIT TOTALIZER	RESET TOTALIZER														
FAILSAFE MODE																	
↓																	
CURRENT OUTPUT → 89	<table border="1"> <tr> <td>CURRENT SPAN</td> <td>VALUE 20 mA</td> <td>TIME CONSTANT</td> <td>FAILSAFE MODE</td> </tr> <tr> <td>ACTUAL CURRENT</td> <td>SIMULATION CURRENT</td> <td>VALUE SIMULATION CURRENT</td> <td></td> </tr> </table>	CURRENT SPAN	VALUE 20 mA	TIME CONSTANT	FAILSAFE MODE	ACTUAL CURRENT	SIMULATION CURRENT	VALUE SIMULATION CURRENT									
CURRENT SPAN	VALUE 20 mA	TIME CONSTANT	FAILSAFE MODE														
ACTUAL CURRENT	SIMULATION CURRENT	VALUE SIMULATION CURRENT															
↓																	
PULSE/STATUS OUTPUT → 91	<table border="1"> <tr> <td>OPERATION MODE</td> <td>PULSE VALUE</td> <td>PULSE WIDTH</td> <td>OUTPUT SIGNAL</td> </tr> <tr> <td>FAILSAFE MODE</td> <td>ACTUAL PULSE</td> <td>SIMULATION PULSE</td> <td>VALUE SIMULATION PULSE</td> </tr> <tr> <td>ASSIGN STATUS</td> <td>ON-VALUE</td> <td>OFF-VALUE</td> <td>TIME CONSTANT</td> </tr> <tr> <td>ACTUAL STATUS OUTPUT</td> <td>SIMULATION SWITCH POINT</td> <td>VALUE SIMULATION SWITCH POINT</td> <td></td> </tr> </table>	OPERATION MODE	PULSE VALUE	PULSE WIDTH	OUTPUT SIGNAL	FAILSAFE MODE	ACTUAL PULSE	SIMULATION PULSE	VALUE SIMULATION PULSE	ASSIGN STATUS	ON-VALUE	OFF-VALUE	TIME CONSTANT	ACTUAL STATUS OUTPUT	SIMULATION SWITCH POINT	VALUE SIMULATION SWITCH POINT	
OPERATION MODE	PULSE VALUE	PULSE WIDTH	OUTPUT SIGNAL														
FAILSAFE MODE	ACTUAL PULSE	SIMULATION PULSE	VALUE SIMULATION PULSE														
ASSIGN STATUS	ON-VALUE	OFF-VALUE	TIME CONSTANT														
ACTUAL STATUS OUTPUT	SIMULATION SWITCH POINT	VALUE SIMULATION SWITCH POINT															
↓																	
COMMUNICATION → 101	<table border="1"> <tr> <td>TAG NAME</td> <td>TAG DESCRIPTION</td> <td>FIELD BUS ADDRESS</td> <td>WRITE PROTECTION</td> </tr> <tr> <td>BURST MODE</td> <td>MANUFACTURER ID</td> <td>DEVICE ID</td> <td></td> </tr> </table>	TAG NAME	TAG DESCRIPTION	FIELD BUS ADDRESS	WRITE PROTECTION	BURST MODE	MANUFACTURER ID	DEVICE ID									
TAG NAME	TAG DESCRIPTION	FIELD BUS ADDRESS	WRITE PROTECTION														
BURST MODE	MANUFACTURER ID	DEVICE ID															
↓																	
PROCESS PARAMETER → 102	<table border="1"> <tr> <td>APPLICATION</td> <td>OPERATION DENSITY</td> <td>REFERENCE DENSITY</td> <td>OPERATION TEMPERATURE</td> </tr> <tr> <td>MATING PIPE DIAMETER</td> <td>ON-VALUE LOW FLOW CUT OFF</td> <td>OFF-VALUE LOW FLOW CUT OFF</td> <td>VELOCITY WARNING</td> </tr> <tr> <td>LIMIT VELOCITY</td> <td></td> <td></td> <td></td> </tr> </table>	APPLICATION	OPERATION DENSITY	REFERENCE DENSITY	OPERATION TEMPERATURE	MATING PIPE DIAMETER	ON-VALUE LOW FLOW CUT OFF	OFF-VALUE LOW FLOW CUT OFF	VELOCITY WARNING	LIMIT VELOCITY							
APPLICATION	OPERATION DENSITY	REFERENCE DENSITY	OPERATION TEMPERATURE														
MATING PIPE DIAMETER	ON-VALUE LOW FLOW CUT OFF	OFF-VALUE LOW FLOW CUT OFF	VELOCITY WARNING														
LIMIT VELOCITY																	
↓																	
SYSTEM PARAMETER → 106	<table border="1"> <tr> <td>POSITIVE ZERO RETURN</td> <td>FLOW DAMPING</td> </tr> </table>	POSITIVE ZERO RETURN	FLOW DAMPING														
POSITIVE ZERO RETURN	FLOW DAMPING																
↓																	

Groups/function groups		Functions			
SENSOR DATA → 107	↓	CALIBRATION DATE	K-FACTOR	K-FACTOR COMPENSATED	NOMINAL DIAMETER
		METER BODY MB	TEMPERATURE COEFFICIENT SENSOR	AMPLIFICATION	
SUPERVISION → 109	↓	ACTUAL SYSTEM CONDITION	PREVIOUS SYSTEM CONDITIONS	ASSIGN SYSTEM ERROR	ERROR CATEGORY
		ALARM DELAY	SYSTEM RESET	OPERATION HOURS	
SIMULATION SYSTEM → 111	↓	SIMULATION FAILSAFE MODE	SIMULATION MEASURAND	VALUE SIMULATION MEASURAND	
SENSOR VERSION → 112	↓	SERIAL NUMBER	SENSOR TYPE	SERIAL NUMBER DSC SENSOR	
AMPLIFIER VERSION → 112	↓	DEVICE SOFTWARE	HARDWARE REVISION NUMBER AMPLIFIER	SOFTWARE REVISION NUMBER AMPLIFIER	HARDWARE REVISION NUMBER I/O MODULE

11.2 MEASURED VALUES

Function description, MEASURED VALUES group	
FLOW	<p>Description The flow currently measured appears on the display. The appropriate unit is taken from the UNIT FLOW function (→ 79).</p> <p>Display 5-digit floating-point number, including unit e.g. 5.545 dm³/min; 1.4359 kg/h; 731.63 gal/d</p>
VORTEX FREQUENCY	<p>Description The vortex frequency currently measured appears on the display. This function is only used for a plausibility check.</p> <p>Display 5-digit floating-point number, including unit Hz e.g. 120.23 Hz</p>
VELOCITY	<p>Description The flow velocity through the device appears on the display. This is calculated from the current flow through the device and the cross-sectional area flowed through. Unit on the display depends on UNIT LENGTH (→ 81)</p> <p>Display 5-digit floating point number, incl. unit: m/s; ft/s</p>

11.3 SYSTEM UNITS

Function description, SYSTEM UNITS group	
MEASURING UNIT TYPE	<p>Description</p> <p>Use this function to select the desired type of unit which the measuring device should use to output the flow.</p> <p>Unit types:</p> <ul style="list-style-type: none"> ■ Volumetric flow (volume flow) Is measured by the measuring device. No other calculation takes place. ■ Calculated mass flow Is calculated using the measured volume flow and the value entered in the OPERATION DENSITY function (→ 102). ■ Calculated corrected volume flow Is calculated using the measured volume flow and the ratio between the two values that were entered in the OPERATION DENSITY (→ 102) and REFERENCE DENSITY function (→ 102). <p> Note! The "calculated mass flow" and "calculated corrected volume flow" unit types are calculated with fixed values for OPERATING DENSITY and REFERENCE DENSITY.</p> <ul style="list-style-type: none"> ■ If the process conditions are known and do not change, select these two types of unit. ■ If the process conditions are not known or if the process conditions could change, we recommend you use a flow computer (e.g. Compart DXF351 or RMC621). Even when the process conditions change, these flow computers can calculate the flow correctly by means of pressure and temperature compensation. <p>Options</p> <p>VOLUME FLOW CALCULATED MASS FLOW CORRECTED VOLUME FLOW (calculated)</p> <p>Factory setting</p> <p>See the parameter printout provided. The parameter printout is an integral part of these Operating Instructions.</p> <p> Note! If the type of unit is changed, you are asked whether the totalizer should be reset to 0. This message has to be confirmed before the measuring device accepts the new type of unit; otherwise the measuring device continues to use the type of unit previously active.</p>

Function description, SYSTEM UNITS group	
UNIT FLOW	<p>Description</p> <p>For selecting the unit required and displayed for the flow. Depending on what is selected in the MEASURING UNIT TYPE function (→ 78), only the associated units (volume, mass or corrected volume) are displayed here.</p> <p>The unit you select here is also valid for:</p> <ul style="list-style-type: none"> ■ Flow display ■ Current output (value 20 mA) ■ Pulse/status output (pulse value; on-value/off-value) ■ On-value low flow cut off ■ Simulation measurand <p> Note!</p> <p>The unit for the totalizer is independent of the option selected here; it is selected in the UNIT TOTALIZER function (→ 87).</p> <p>The following time units can be selected: s = second, m = minute, h = hour, d = day</p> <p>Options (MEASURING UNIT TYPE function = VOLUME FLOW)</p> <p>Metric:</p> <ul style="list-style-type: none"> Cubic centimeter → cm³/time unit Cubic decimeter → dm³/time unit Cubic meter → m³/time unit Milliliter → ml/time unit Liter → l/time unit Hectoliter → hl/time unit Megaliter → Ml/time unit MEGA <p>US:</p> <ul style="list-style-type: none"> Cubic centimeter → cc/time unit Acre foot → af/time unit Cubic foot → ft³/time unit Fluid ounce → ozf/time unit Gallon → US gal/time unit Mega gallon → US Mgal/time unit Barrel (normal fluids: 31.5 gal/bbl) → US bbl/time unit NORM. Barrel (beer: 31.0 gal/bbl) → US bbl/time unit BEER Barrel (petrochemicals: 42.0 gal/bbl) → US bbl/time unit PETR. Barrel (filling tanks: 55.0 gal/bbl) → US bbl/time unit TANK <p>Imperial:</p> <ul style="list-style-type: none"> Gallon → imp. gal/time unit Mega gallon → imp. Mgal/time unit Barrel (beer: 36.0 gal/bbl) → imp. bbl/time unit BEER Barrel (petrochemicals: 34.97 gal/bbl) → imp. bbl/time unit PETR. <p>Arbitrary volume unit:</p> <p>This option does not appear unless a volume unit was defined via the TEXT ARBITRARY VOLUME UNIT function (→ 81).</p> <p>Factory setting</p> <p>See the parameter printout provided. The parameter printout is an integral part of these Operating Instructions.</p> <p>Options (MEASURING UNIT TYPE function = CALCULATED MASS FLOW)</p> <p>Metric:</p> <ul style="list-style-type: none"> Gram → g/time unit Kilogram → kg/time unit Metric ton → t/time unit <p>US:</p> <ul style="list-style-type: none"> Ounce → oz/time unit (US) Pound → lb/time unit Ton → ton/time unit <p>Factory setting</p> <p>See the parameter printout provided. The parameter printout is an integral part of these Operating Instructions.</p> <p>(Continued on next page)</p>





Function description, SYSTEM UNITS group	
UNIT FLOW (continued)	<p>Options (MEASURING UNIT TYPE function = CORRECTED VOLUME FLOW)</p> <p>Metric: Standard liter → NI/time unit Standard cubic meter → Nm³/time unit</p> <p>US: Standard cubic meter → Sm³/time unit Standard cubic feet → Scf/time unit</p> <p>Factory setting See the parameter printout provided. The parameter printout is an integral part of these Operating Instructions.</p>
UNIT DENSITY	<p>Prerequisite This function is only available if the CALCULATED MASS FLOW or CORRECTED VOLUME (calculated) values were selected in the MEASURING UNIT TYPE function (→ 78).</p> <p>Description For selecting the unit required and displayed for the density. The density is selected in the OPERATION DENSITY (→ 102) and REFERENCE DENSITY function (→ 102).</p> <p>Options</p> <p>Metric: g/cm³ g/cc kg/dm³ kg/l kg/m³ SD* 4 °C, SD 15 °C, SD 20 °C SG* 4 °C, SG 15 °C, SG 20 °C</p> <p>US: lb/ft³ lb/US gal lb/US bbl NORM (normal fluids) lb/US bbl BEER (beer) lb/US bbl PETR. (petrochemicals) lb/US bbl TANK (filling tanks)</p> <p>Imperial: lb/imp. gal lb/imp. bbl BEER (beer) lb/imp. bbl PETR. (petrochemicals)</p> <p>Factory setting See the parameter printout provided. The parameter printout is an integral part of these Operating Instructions.</p> <p>* SD = specific density, SG = specific gravity The specific density is the ratio of fluid density to water density (at water temperature = 4, 15, 20 °C).</p>
UNIT TEMPERATURE	<p>Description For selecting the unit required and displayed for the temperature. The temperature is entered in the OPERATION TEMPERATURE function (→ 103).</p> <p>Options °C (CELSIUS) K (KELVIN) °F (FAHRENHEIT) R (RANKINE)</p> <p>Factory setting Depends on country → 113</p>

Function description, SYSTEM UNITS group	
UNIT LENGTH	<p>Description For selecting the unit required and displayed for the length unit of the nominal diameter in the NOMINAL DIAMETER function (→ 107).</p> <p>Options MILLIMETER INCH</p> <p>Factory setting Depends on country → 113</p>
TEXT ARBITRARY VOLUME UNIT	<p>Prerequisite The function is only available if VOLUME FLOW was selected in the MEASURING UNIT TYPE function (→ 78).</p> <p>Description For entering a text for a volume flow unit of the user's choice. The related time unit is selected in the UNIT FLOW function (→ 79). The volume unit defined in this function is offered as a possible option (arbitrary volume unit) in the UNIT FLOW function (→ 79).</p> <p>User input xxxx (max. 4 characters) Valid characters are A-Z, 0-9, +, -, decimal point, white space or underscore</p> <p>Factory setting "----" (no text)</p> <p>Example See example of FACTOR ARBITRARY VOLUME UNIT function (→ 81)</p>
FACTOR ARBITRARY VOLUME UNIT	<p>Prerequisite The function is only available if a text was entered in the TEXT ARBITRARY VOLUME UNIT function (→ 81).</p> <p>Description For defining a quantity factor (without time) for the arbitrary volume flow unit. The volume unit on which this factor is based is one liter.</p> <p>User input 5-digit floating-point number</p> <p>Unit Text arbitrary volume unit / liter</p> <p>Factory setting 1</p> <p>Example You want to measure saturated steam at 180 °C constant and display the heat flow. Take the following values from a table document (e.g. IAPWS-IF97):</p> <ul style="list-style-type: none"> ■ Density: 5.158 kg/m³ ■ Enthalpy: 2777.22 kJ/kg <p>1 m³ steam thus has an enthalpy of 2777 kJ/kg · 5.158 kg/m³ = 14323 kJ/m³. 1 liter corresponds to 14.323 kJ.</p> <p>In the TEXT ARBITRARY VOLUME UNIT function, enter "KJ" as the name of the volume unit for example. The entry appears as an option in the UNIT FLOW function. In the FACTOR ARBITRARY VOLUME UNIT function, the value 14.323 would have to be entered.</p>
FORMAT DATE/TIME	<p>Description Selection of the format of date and time. This indicates or must be entered, if the calibration factor in function SENSOR DATA is changed (e.g. after a Re calibration).</p> <p>Options MM/DD/YY 24H DD.MM.YY 24H MM/DD/YY 12H A/P DD.MM.YY 12H A/P</p> <p>Factory setting DD.MM.YY 24H</p>

11.4 QUICK SETUP

Function description, QUICK SETUP group	
QUICK SETUP COMMISSIONING	<p>Description Starts the Quick Setup menu for commissioning. For an exact description of the Commissioning Quick Setup, see →  41</p> <p>Options NO YES</p> <p>Factory setting NO</p>

11.5 OPERATION

Function description, OPERATION group	
LANGUAGE	<p>Description For selecting the language in which all messages are shown on the local display. If you press the  keys simultaneously at startup, the language defaults to "ENGLISH".</p> <p>Options with standard display: ENGLISH DEUTSCH FRANCAIS ESPANOL ITALIANO NEDERLANDS NORSK SVENSKA SUOMI PORTUGUES POLSKI CESKY</p> <p>Available in addition with the graphical display option: CHINESE JAPANESE RUSSIAN</p> <p>Factory setting Depends on country →  113</p>
ACCESS CODE	<p>Description All data of the measuring system are protected against inadvertent change. Programming is disabled and the settings cannot be changed until a code is entered in this function. If the  keys are pressed in any function, the measuring system automatically goes to the function. If programming is locked, a prompt to enter a code appears on the display. You can enable programming by entering the private code (factory setting = 72, →  83, DEFINE PRIVATE CODE function).</p> <ul style="list-style-type: none"> ■ The programming levels are disabled if the operating elements are not pressed within 60 seconds following a return to the HOME position. ■ Programming can also be disabled by entering any number (other than the private code) in this function. ■ Your Endress+Hauser representative can be of assistance if you mislay your private code. <p>User input Max. 4-digit number: 0 to 9999</p>
DEFINE PRIVATE CODE	<p>Description Use this function to specify the private code for enabling programming.</p> <ul style="list-style-type: none"> ■ Programming is always enabled if the code defined = 0. ■ Programming has to be enabled before this code can be changed. When programming is disabled this function cannot be edited, thus preventing others from accessing your personal code. <p>User input Max. 4-digit number: 0 to 9999</p> <p>Factory setting 72</p>
STATUS ACCESS	<p>Description The access status for the function matrix appears on the display.</p> <p>Display ACCESS CUSTOMER (parameters can be modified) LOCKED (parameters cannot be modified)</p>

Function description, OPERATION group	
ACCESS CODE COUNTER	<p>Description The number of times the private and service code was entered to access the device appears on the display.</p> <p>Display Integer</p> <p>Factory setting 0</p>

11.6 USER INTERFACE

Function description, USER INTERFACE group	
ASSIGN LINE 1	<p>Description For assigning a display value to the main line (top line of the local display). This value is displayed during normal operation.</p> <p>Options OFF FLOW FLOW IN %</p> <p>Factory setting FLOW</p>
ASSIGN LINE 2	<p>Description For assigning a display value to the additional line (bottom line of the local display). This value is displayed during normal operation.</p> <p>Options OFF FLOW FLOW IN % TOTALIZER TAG NAME OPERATING/SYSTEM CONDITIONS FLOW BAR GRAPH IN %</p> <p>Factory setting TOTALIZER</p>
100% VALUE	<p>Prerequisite This function is only available if one of the following options was selected:</p> <ul style="list-style-type: none"> ■ The FLOW IN % option in the ASSIGN LINE 1 function ■ The FLOW IN % or FLOW BAR GRAPH IN % option in the ASSIGN LINE 2 function <p>Description Use this function to enter the flow value which should be shown on the display as the 100% value. If a value was specified for the VALUE 20 mA function (→ 89) when ordering, this value is also used here as the factory setting.</p> <p>User input 5-digit floating-point number</p> <p>Factory setting Depends on nominal diameter, fluid and country → 113</p>
FORMAT	<p>Description For selecting the number of decimal places for the display value in the main line.</p> <ul style="list-style-type: none"> ■ Note that this setting only affects the reading as it appears on the display, it has no influence on the accuracy of the system's calculations. ■ The places after the decimal point as computed by the measuring device cannot always be displayed, depending on this setting and the engineering unit. In these instances an arrow appears on the display between the measured value and the engineering unit (e.g. 1.2 →kg/h), indicating that the measuring system is computing with more decimal places than can be shown on the display. <p>Options XXXXX. - XXXX.X - XXX.XX - XX.XXX -X.XXXX</p> <p>Factory setting XX.XXX</p>

Function description, USER INTERFACE group	
DISPLAY DAMPING	<p>Description For entering a time constant defining how the display reacts to severely fluctuating flow variables, either very quickly (enter a low time constant) or with damping (enter a high time constant).</p> <ul style="list-style-type: none"> ■ The setting 0 seconds switches off damping. ■ The reaction time of the function depends on the time specified in the FLOW DAMPING function (→ 106). <p>User input 0 to 100 seconds</p> <p>Factory setting 5 seconds</p>
CONTRAST LCD	<p>Description For adjusting the display contrast to suit local operating conditions. If you press the  keys simultaneously at startup, the language defaults to "ENGLISH" and the contrast is reset to the factory setting.</p> <p>User input 10 to 100%</p> <p>Factory setting 50%</p>
TEST DISPLAY	<p>Description Use this function to test the operability of the local display and its pixels. Test sequence:</p> <ol style="list-style-type: none"> 1. Start the test by selecting ON. 2. All pixels of the main line and additional line are darkened for minimum 0.75 seconds. 3. The main line and additional line show an "8" in each field for minimum 0.75 seconds. 4. The main line and additional line show a "0" in each field for minimum 0.75 seconds. 5. The main line and additional line show nothing (blank display) for minimum 0.75 seconds. 6. When the test is completed, the local display returns to its initial state and displays the option OFF. <p>Options OFF ON</p> <p>Factory setting OFF</p>







11.7 TOTALIZER

Function description, TOTALIZER group	
SUM	<p>Description The total for the totalizer's measured variable aggregated since measuring commenced appears on the display. The totalizers' response to errors is defined in the FAILSAFE MODE function (→ 88).</p> <p>Display Max. 7-digit floating-point number, including unit (e.g. 15467.4 m³)</p>
OVERFLOW	<p>Description The total for the totalizer's overflow aggregated since measuring commenced appears on the display. Total flow is represented by a floating-point number consisting of max. 7 digits. You can use this function to view higher numerical values (>9999999) as overflows. The effective quantity is thus the total of the SUM function (→ 87) plus the value displayed in the OVERFLOW function (→ 87).</p> <p>Display Integer with exponent, including sign and unit, e.g. 2 E7 kg</p> <p>Example Reading after 2 overflows: 2 E7 kg (= 20000000 kg) The value displayed in the SUM function = 196 845.7 kg Effective total quantity = 20196845.7 kg</p>
UNIT TOTALIZER	<p>Description For selecting the unit for the measured variable assigned to the totalizer.</p> <p>Options (MEASURING UNIT TYPE assigned to VOLUME FLOW)</p> <p>Metric: Cubic centimeter → cm³ Cubic decimeter → dm³ Cubic meter → m³ Milliliter → ml Liter → l Hectoliter → hl Megaliter → Ml MEGA</p> <p>US: Cubic centimeter → cc Acre foot → af Cubic foot → ft³ Fluid ounce → oz f Gallon → US gal Mega gallon → US Mgal Barrel (normal fluids: 31.5 gal/bbl) → US bbl NORM.FL. Barrel (beer: 31.0 gal/bbl) → US bbl BEER Barrel (petrochemicals: 42.0 gal/bbl) → US bbl PETROCH. Barrel (filling tanks: 55.0 gal/bbl) → US bbl TANK</p> <p>Imperial: Gallon → imp. gal Mega gallon → imp. Mgal Barrel (beer: 36.0 gal/bbl) → imp. bbl BEER Barrel (petrochemicals: 34.97 gal/bbl) → imp. bbl PETROCH.</p> <p>Arbitrary volume unit: This option does not appear unless a volume unit was defined via the TEXT ARBITRARY VOLUME UNIT function (→ 81).</p> <p>Factory setting Depends on country → 113</p> <p>(Continued on next page)</p>

Function description, TOTALIZER group	
UNIT TOTALIZER (continued)	<p>Options (MEASURING UNIT TYPE assigned to CALCULATED MASS FLOW)</p> <p>Metric: Gram → g Kilogram → kg Metric ton → t</p> <p>US: Ounce → oz (US) Pound → lb Ton → ton</p> <p>Factory setting Depends on country → 113</p> <p>Options (MEASURING UNIT TYPE assigned to CORRECTED VOLUME FLOW)</p> <p>Metric: Norm liter → NI Norm cubic meter → Nm³</p> <p>US: Standard cubic meter → Sm³ Standard cubic feet → Scf</p> <p>Factory setting Depends on country → 113</p>
RESET TOTALIZER	<p>Description Resets the sum and overflow in the totalizer selected to 0 (=RESET).</p> <p>Options NO YES</p> <p>Factory setting NO</p>
FAILSAFE MODE	<p>Description For selecting the behavior of the totalizer in an alarm condition.</p> <p>Options</p> <p>STOP The totalizer does not continue to count the flow if a fault is present. The totalizer stops at the last value before the alarm condition occurred.</p> <p>HOLD VALUE The totalizer continues to count the flow on the basis of the last valid flow data (before the fault occurred).</p> <p>ACTUAL VALUE The totalizer continues to count on the basis of the current flow data. The fault is ignored.</p> <p>Factory setting STOP</p>

11.8 CURRENT OUTPUT



Function description, CURRENT OUTPUT group	
CURRENT SPAN	<p>Description Use this function to specify the current span. You can configure the current output either in accordance with the NAMUR recommendation or for the values common in the United States.</p> <p>Options 4-20 mA HART NAMUR 4-20 mA HART US</p> <p>Factory setting See the parameter printout provided. The parameter printout is an integral part of these Operating Instructions.</p>
VALUE 20 mA	<p>Description Assign a value to the 20 mA current. The appropriate unit is taken from the UNIT FLOW function (→ 79).</p> <p>User input 5-digit floating-point number</p> <p>Factory setting See the parameter printout provided. The parameter printout is an integral part of these Operating Instructions.</p>
TIME CONSTANT	<p>Description Use this function to select a time constant defining how the current output signal reacts to severely fluctuating measured variables, either very quickly (low time constant) or with damping (high time constant). The reaction time of the function also depends on the time specified in the FLOW DAMPING function (→ 106).</p> <p>User input Fixed-point number: 0 to 100 s</p> <p>Factory setting 5 s</p>
FAILSAFE MODE	<p>Description The dictates of safety render it advisable to ensure that the current output assumes a predefined state in the event of a fault. Use this function to define the response of the current output to fault. The setting you select here affects only the current output. It has no effect on other outputs or the display (e.g. totalizers).</p> <p>Options</p> <p>MIN. CURRENT Depends on the option selected in the CURRENT SPAN function (→ 89). If the current span is: 4 to 20 mA HART NAMUR → output current = 3.6 mA 4 to 20 mA HART US → output current = 3.75 mA</p> <p>MAX. CURRENT 22.6 mA</p> <p>HOLD VALUE Measured value output is based on the last measured value saved before the error occurred.</p> <p>ACTUAL VALUE Measured value output is based on the current flow measurement. The fault is ignored.</p> <p>Factory setting MAX. CURRENT</p>
ACTUAL CURRENT	<p>Description The current computed actual value of the output current appears on the display.</p> <p>Display: 3.60 to 22.60 mA</p>

Function description, CURRENT OUTPUT group	
SIMULATION CURRENT	<p>Description Activates simulation of the current output.</p> <ul style="list-style-type: none"> ■ The notice message #611 "SIMULATION CURRENT OUTPUT" (→  49) indicates that simulation is active. ■ The value which should be output at the current output is defined in the VALUE SIMULATION CURRENT function (→  90). ■ The measuring device continues to measure while simulation is in progress, i.e. the current measured values are output correctly via the other outputs and the display. <p> Note! The setting is not saved if the power supply fails.</p> <p>Options OFF ON</p> <p>Factory setting OFF</p>
VALUE SIMULATION CURRENT	<p>Prerequisite The function is only available if the ON option was selected in the SIMULATION CURRENT function (→  90).</p> <p>Description Use this function to define an arbitrary value (e.g. 12 mA) to be output at the current output. This value is used to test downstream devices and the measuring device itself.</p> <p>Simulation is started by confirming the simulation value with the  key. If the  key is pressed again afterwards, the prompt "End simulation" (NO/YES) appears.</p> <p>If you choose "NO", simulation remains active and the group selection is called up. The simulation can be switched off again via the SIMULATION CURRENT function.</p> <p>If you choose "YES", you end the simulation and the group selection is called up.</p> <p> Note! The setting is not saved if the power supply fails.</p> <p>User input Floating-point number: 3.60 to 22.60 mA</p> <p>Factory setting 3.60 mA</p>



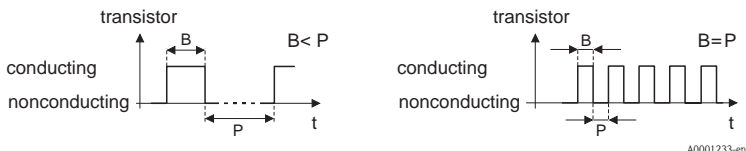

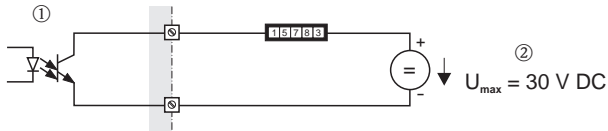

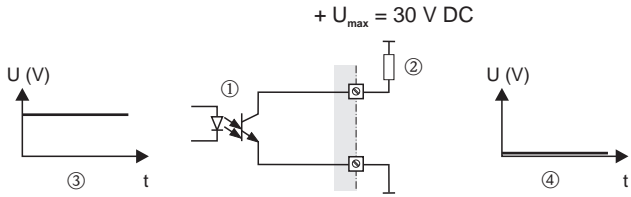
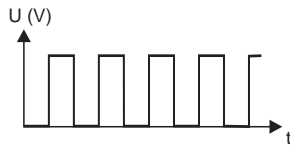

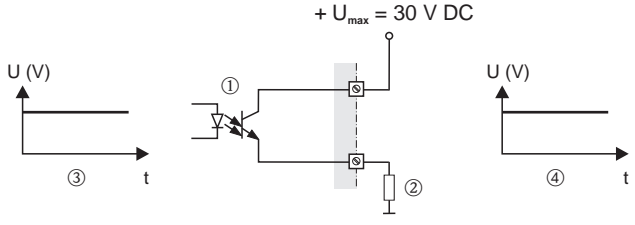
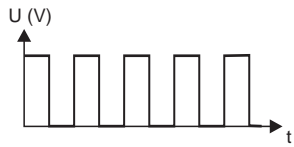
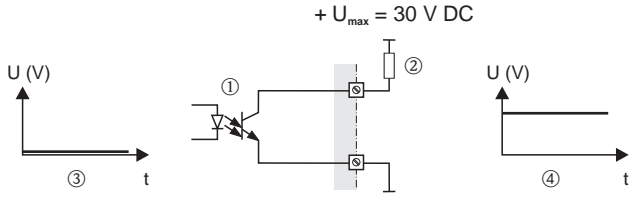
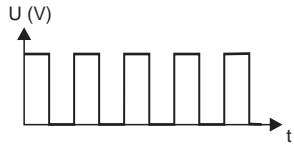

11.9 PULSE/STATUS OUTPUT

Function description, PULSE/STATUS OUTPUT group	
OPERATION MODE	<p>Description Use this function to specify whether the output functions as a pulse output or status output. The functions available will vary in this function group, depending on which option you select here.</p> <ul style="list-style-type: none"> ■ If PFM is selected, the CURRENT OUTPUT group (→ 89) is no longer available. Current simulation is automatically activated with a simulation value of 4 mA. If the transmitter was wired for pulse-frequency modulation (→ 24), the HART protocol is not available. ■ If VORTEX FREQUENCY and PFM are selected, the vortex pulses are passed on directly. The low flow cut off is taken into account. <p>Options PULSE STATUS VORTEX FREQUENCY (→ 60) PFM (→ 60)</p> <p>Factory setting PULSE</p>
PULSE VALUE	<p>Prerequisite The function is only available if PULSE was selected in the OPERATION MODE function (→ 91).</p> <p>Description Use this function to define the flow at which a pulse should be output. These pulses can be totaled by an external totalizer and the total flow since measuring started can be recorded in this way.</p> <p>Select the pulse value in such a way that the pulse frequency does not exceed a value of 100 Hz with maximum flow. The appropriate unit is taken from the function UNIT FLOW function (→ 79).</p> <p>User input 5-digit floating-point number</p> <p>Factory setting See the parameter printout provided. The parameter printout is an integral part of these Operating Instructions.</p>

Function description, PULSE/STATUS OUTPUT group	
PULSE WIDTH	<p>Prerequisite The function is only available if PULSE was selected in the OPERATION MODE function (→ 91).</p> <p>Description Use this function to enter the pulse width of the output pulses. When entering the pulse width, select a value that can still be processed by an external totalizer (e.g. mechanical totalizer, PLC, etc.).</p> <p>If the selected pulse width cannot be maintained (interval $P <$ pulse width B entered), a system error message is generated after approx. 5 seconds buffer time/idling time: "#359 RANGE PULSE" (→ 48). The reason for not being able to maintain the pulse width could be that the pulse number or frequency, which result from the pulse value entered (→ 91, PULSE VALUE function) and the current flow, are too big.</p> <p>Pulses are always generated with the pulse width (B) entered in this function. The intervals (P) between the individual pulses are automatically configured. However, they must at least correspond to the pulse width ($B = P$).</p> <div style="text-align: center;">  </div> <p><i>B = Pulse width entered (the illustration applies to positive pulses)</i> <i>P = Intervals between the individual pulses</i></p> <p>User input 5 to 2000 ms</p> <p>Factory setting 20 ms</p>

Function description, PULSE/STATUS OUTPUT group	
OUTPUT SIGNAL	<p>Prerequisite The function is only available if the PULSE option was selected in the OPERATION MODE function (→ 91).</p> <p>Description For adapting the polarity of the pulse signals to the requirements during operation.</p> <p>Options PASSIVE – POSITIVE PASSIVE – NEGATIVE</p> <p>Factory setting PASSIVE – POSITIVE</p> <p>Explanation PASSIVE = power is supplied to the pulse output by means of an external power supply.</p> <p>Configuring the output signal level (POSITIVE or NEGATIVE) determines the quiescent behavior (at zero flow) of the pulse output. The internal transistor is activated as follows:</p> <ul style="list-style-type: none"> ■ If POSITIVE is selected, the internal transistor is activated with a positive signal level ■ If NEGATIVE is selected, the internal transistor is activated with a negative signal level (0 V) <p> Note! The output signal levels of the pulse output depend on the external wiring (see examples).</p> <p>Example for passive output circuit (PASSIVE) If PASSIVE is selected, the pulse output is configured as an open collector.</p>  <p style="text-align: right; font-size: small;">A0001225</p> <p>① Open collector ② External power supply</p> <p> Note! For continuous currents up to 25 mA ($I_{max} = 250 \text{ mA} \div 20 \text{ ms}$).</p> <p>Example for output configuration PASSIVE-POSITIVE Output configuration with an external pull-up resistor. In the quiescent state (at zero flow), the output signal level at the terminals is 0 Volt.</p>  <p style="text-align: right; font-size: small;">A0004687</p> <p>① Open collector ② Pull-up resistor ③ Transistor activation in "POSITIVE" quiescent state (at zero flow) ④ Output signal level in quiescent state (at zero flow)</p> <p>In the operating state (flow present), the output signal level changes from 0 Volt to a positive voltage level.</p>  <p style="text-align: right; font-size: small;">A0001975</p> <p>(Continued on next page)</p>

Function description, PULSE/STATUS OUTPUT group	
OUTPUT SIGNAL (continued)	<p>Example for output configuration PASSIVE-POSITIVE Output configuration with an external pull-down resistor. In the quiescent state (at zero flow), a positive voltage level is measured via the pull-down resistor.</p>  <p>① Open collector ② Pull-up resistor ③ Transistor activation in "POSITIVE" quiescent state (at zero flow) ④ AusgangssiOutput signal level in quiescent state (at zero flow)</p> <p>In the operating status (flow present), the output signal level changes from a positive voltage level to 0 Volt.</p>  <p>Example for output configuration PASSIVE-NEGATIVE Output configuration with an external pull-up resistor. In the quiescent state (at zero flow), the output signal level at the terminals is at a positive voltage level.</p>  <p>① Open collector ② Pull-up resistor ③ Transistor activation in "NEGATIVE" quiescent state (at zero flow) ④ Output signal level in quiescent state (at zero flow)</p> <p>In the operating status (flow present), the output signal level changes from a positive voltage level to 0 Volt.</p> 

Function description, PULSE/STATUS OUTPUT group	
FAILSAFE MODE	<p>Prerequisite This function is only available if PULSE was selected in the OPERATION MODE function (→  91).</p> <p>Description The dictates of safety render it advisable to ensure that the pulse output assumes a predefined state in the event of a fault. Use this function to define this state. The setting you select here affects only the pulse output. It has no effect on other outputs or the display (e.g. totalizers).</p> <p>Options</p> <p>FALLBACK VALUE 0 pulse output.</p> <p>HOLD VALUE Measured value output is based on the last measured value saved before the error occurred.</p> <p>ACTUAL VALUE Measured value output is based on the current flow measurement. The fault is ignored.</p> <p>Factory setting FALLBACK VALUE</p>
ACTUAL PULSE	<p>Prerequisite The function is only available if PULSE was selected in the OPERATION MODE function (→  91).</p> <p>Description The computed actual value of the output frequency appears on the display.</p> <p>Display: 0 to 100 pulse/second</p>
SIMULATION PULSE	<p>Prerequisite The function is only available if PULSE was selected in the OPERATION MODE function (→  91).</p> <p>Description Use this function to simulate the pulse output.</p> <ul style="list-style-type: none"> ■ The notice message #631 "SIM. PULSE" (→  49) indicates that simulation is active. ■ The on/off ratio is 1:1 for both types of simulation. ■ The measuring device continues to measure while simulation is in progress i.e. the measured values are output correctly via the other outputs. <p> Note! The setting is not saved if the power supply fails.</p> <p>Options</p> <p>OFF</p> <p>COUNTDOWN The pulses specified in the VALUE SIMULATION PULSE function (→  96) are output.</p> <p>CONTINUOUSLY Pulses are continuously output with the pulse width specified in the PULSE WIDTH function (→  92). Simulation is started once the CONTINUOUSLY option is confirmed with the  key.</p> <p> Note! Simulation is started by confirming the CONTINUOUSLY option with the  key. If the  key is pressed again afterwards, the prompt "End simulation" (NO/YES) appears. If you choose "NO", simulation remains active and the group selection is called up. The simulation can be switched off again via the SIMULATION PULSE function. If you choose "YES", you end the simulation and the group selection is called up.</p> <p>Factory setting OFF</p>

Function description, PULSE/STATUS OUTPUT group	
VALUE SIMULATION PULSE	<p>Prerequisite The function is only available if COUNTDOWN was selected in the SIMULATION PULSE function (→ 95).</p> <p>Description Use this function to specify the number of pulses (e.g. 50) which are output during the simulation. This value is used to test downstream devices and the measuring device itself. The pulses are output with the pulse width specified in the PULSE WIDTH function (→ 92). The on/off ratio is 1:1. Simulation is started once the specified value is confirmed with the <input type="checkbox"/> key. The display remains at 0 if the specified pulses have been transmitted. Simulation is started by confirming the simulation value with the <input type="checkbox"/> key. If the <input type="checkbox"/> key is pressed again afterwards, the prompt "End simulation" (NO/YES) appears. If you choose "NO", simulation remains active and the group selection is called up. The simulation can be switched off again via the SIMULATION PULSE function. If you choose "YES", you end the simulation and the group selection is called up.</p> <p> Note! The setting is not saved if the power supply fails.</p> <p>User input 0 to 10000</p> <p>Factory setting 0</p>
ASSIGN STATUS	<p>Prerequisite The function is only available if STATUS was selected in the OPERATION MODE function (→ 91).</p> <p>Description Use this function to assign a switching function to the status output.</p> <ul style="list-style-type: none"> ■ The status output displays quiescent current behaviour, in other words the output is closed (transistor conductive) when normal, error-free operation is in progress. ■ Pay particular attention to the illustrations and detailed information on the switching behaviour of the status output (→ 99). ■ If you select OFF, the only function shown in this function group is the ASSIGN STATUS function. <p>Options OFF ON (operation) FAULT MESSAGE NOTICE MESSAGE FAULT MESSAGE or NOTICE MESSAGE LIMIT FLOW LIMIT TOTALIZER</p> <p>Factory setting FAULT MESSAGE</p>
ON-VALUE	<p>Prerequisite This function is only available if LIMIT FLOW or LIMIT TOTALIZER was selected in the ASSIGN STATUS function (→ 96).</p> <p>Description Use this function to assign a value to the switch-on point (status output pulls up). The value can be greater or less than the switch-off point. Only positive values are permitted. The appropriate unit is taken from the UNIT FLOW function (→ 79) or UNIT TOTALIZER function (→ 87).</p> <p>User input 5-digit floating-point number</p> <p>Factory setting Depends on the setting selected in the ASSIGN STATUS function – If the LIMIT VALUE FLOW option is selected: depends on the nominal diameter, fluid and country → 113 – If TOTALIZER LIMIT VALUE was selected: 0</p>

Function description, PULSE/STATUS OUTPUT group	
OFF-VALUE	<p>Prerequisite The function is only available if LIMIT FLOW or LIMIT TOTALIZER was selected in the ASSIGN STATUS function (→ 96).</p> <p>Description Use this function to assign a value to the switch-off point (status output deenergized). The value can be greater or less than the switch-on point. Only positive values are permitted. The appropriate unit is taken from the UNIT FLOW function (→ 79).</p> <p>User input 5-digit floating-point number</p> <p>Factory setting Depends on nominal diameter, fluid and country (→ 113)</p>
TIME CONSTANT	<p>Prerequisite The function is only available if LIMIT FLOW was selected in the ASSIGN STATUS function (→ 96).</p> <p>Description Use this function to select a time constant defining how the measuring signal reacts to severely fluctuating measured variables, either very quickly (low time constant) or with damping (high time constant). The purpose of damping, therefore, is to prevent the status output changing state continuously in response to fluctuations in flow. The reaction time of the function depends on the time specified in the FLOW DAMPING function (→ 106).</p> <p>User input 0 to 100 s</p> <p>Factory setting 0 s</p>
ACTUAL STATUS OUTPUT	<p>Prerequisite The function is only available if STATUS was selected in the OPERATION MODE function (→ 91).</p> <p>Description The current status of the status output appears on the display.</p> <p>Display: NOT CONDUCTIVE CONDUCTIVE</p>
SIMULATION SWITCH POINT	<p>Prerequisite The function is only available if the STATUS option was selected in the OPERATION MODE function (→ 91).</p> <p>Description Use this function to activate simulation of the status output.</p> <ul style="list-style-type: none"> ■ Active simulation is indicated by notice message #641 "SIMULATION STATUS OUTPUT" (→ 49). ■ The measuring device continues to measure while simulation is in progress i.e. the current measured values are output correctly via the other outputs. <p> Note! The setting is not saved if the power supply fails.</p> <p>Options OFF ON</p> <p>Factory setting OFF</p>

Function description, PULSE/STATUS OUTPUT group	
VALUE SIMULATION SWITCH POINT	<p>Prerequisite The function is only available if ON was selected in the SIMULATION SWITCH POINT function (→ 97).</p> <p>Description Use this function to define the switching behaviour of the status output during the simulation. This value is used to test downstream devices and the measuring device itself.</p> <p>You can change the switching behaviour of the status output during the simulation. The prompt "CONDUCTIVE" or "NOT CONDUCTIVE" appears if the <input type="checkbox"/>+ or <input type="checkbox"/>- key is pressed. Select the desired switching behaviour and start the simulation with the <input type="checkbox"/>E key. If the <input type="checkbox"/>E key is pressed again afterwards, the prompt "End simulation" (NO/YES) appears. If you choose "NO", simulation remains active and the group selection is called up. The simulation can be switched off again via the SIMULATION SWITCH POINT function.</p> <p>If you choose "YES", you end the simulation and the group selection is called up.</p> <p> Note! The setting is not saved if the power supply fails.</p> <p>User input NOT CONDUCTIVE CONDUCTIVE</p> <p>Factory setting NOT CONDUCTIVE</p>

11.10 Information on the response of the status output

General information

If you have configured the status output for "LIMIT VALUE" (→ 96, ASSIGN STATUS function) you can specify the required switch points in the ON-VALUE (→ 96) and OFF-VALUE functions (→ 97).

If the measured variable in question reaches these predefined values, the status output switches as shown in the illustrations below.

Status output configured for limit value

The status output switches as soon as the current measured variable undershoots or overshoots a defined switch point.

Application: monitoring flow or process-related boundary conditions.

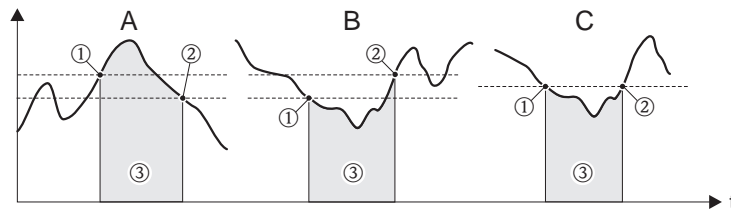



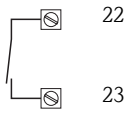
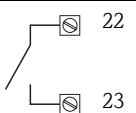
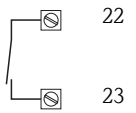
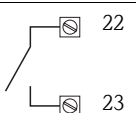
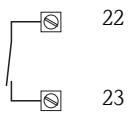
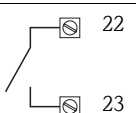

A0001235

- ① $ON \leq SWITCH-OFF POINT$ (maximum safety)
- ② $ON > SWITCH-OFF POINT$ (minimum safety)
- ③ Status output switched off (not conductive)

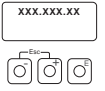
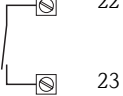
Switching behaviour of the status output

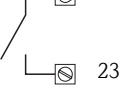
function	Status	Open collector behavior (transistor)
ON (operation)	System in operation	Conductive 
	System not in operation (power supply failed)	Not conductive 
Fault message	System OK	Conductive 
	(System or process error) Fault ▼ failsafe mode of outputs/inputs and totalizers	Not conductive 
Notice message	System OK	Conductive 
	(System or process error) Fault ▼ continuation of operation	Not conductive 

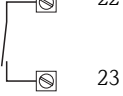
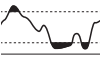
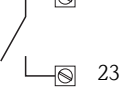
function	Status		Open collector behavior (transistor)	
Fault message or notice message	System OK		Conductive	
	(System or process error) Fault ▼ failsafe mode or Notice ▼ continuation of operation		Not conductive	
Limit value ■ Volume flow ■ Totalizer	Limit value not overshoot or undershot		Conductive	
	Limit value overshoot or undershot		Not conductive	

11.11 COMMUNICATION

Function description, COMMUNICATION group	
TAG NAME	<p>Description Use this function to enter a tag name for the measuring device. You can edit and read this tag name via the local display or the HART protocol</p> <p>User input Max. 8-character text, permitted characters are: A-Z, 0-9, +, -, punctuation marks</p> <p>Factory setting "-----" (no text)</p>
TAG DESCRIPTION	<p>Description Use this function to enter a tag description for the measuring device. You can edit and read this tag description via the local display or the HART protocol.</p> <p>User input Max. 16-character text, permitted characters are: A-Z, 0-9, +, -, punctuation marks</p> <p>Factory setting "-----" (no text)</p>
FIELD BUS ADDRESS	<p>Description Use this function to define an address for the exchange of data with the HART protocol. A constant 4 mA current is applied with addresses 1 to 15.</p> <p>User input 0 to 15</p> <p>Factory setting 0</p>
WRITE PROTECTION	<p>Description Use this function to check whether the measuring device can be write-accessed. Write protection is activated and deactivated by means of a DIP switch on the amplifier board (→ 38).</p> <p>Display: OFF (execution status) = Data exchange possible ON = Data exchange disabled</p>
BURST MODE	<p>Description Use this function to activate cyclic data exchange of the process variables flow and sum to achieve faster communication.</p> <p>Options OFF ON</p> <p>Factory setting OFF</p>
MANUFACTURER ID	<p>Description The manufacturer number in decimal numerical format appears on the display.</p> <p>Display: 17 = (11 hex) for Endress+Hauser</p>
DEVICE ID	<p>Description The instrument number in hexadecimal numerical format appears on the display.</p> <p>Display: 56 = (86 dec) for Prowirl 72</p>

11.12 PROCESS PARAMETER

Function description, PROCESS PARAMETER group	
APPLICATION	<p>Description For specifying the state of aggregation of the fluid.</p> <p>Options GAS/STEAM LIQUID</p> <p>If the option selected in this function is changed, the values in the following functions have to be adapted:</p> <ul style="list-style-type: none"> ■ VALUE 20 mA → 89, ■ PULSE WIDTH → 92, ■ 100% VALUE (line 1) → 85 ■ 100% VALUE (line 2) → 85 <p>If the option selected in the function is changed, you are asked whether the totalizer should be reset to 0. We recommend you confirm this message and reset the totalizer.</p> <p>Factory setting See the parameter printout provided. The parameter printout is an integral part of these Operating Instructions.</p>
OPERATION DENSITY	<p>Prerequisite This function is only available if CALCULATED MASS FLOW or CORRECTED VOLUME FLOW was selected in the MEASURING UNIT TYPE function (→ 78).</p> <p>Description Use this function to enter a fixed value for the density at process conditions. This value is used to calculate the calculated mass flow and the corrected volume flow (see MEASURING UNIT TYPE function → 78).</p> <p>The appropriate unit is taken from the UNIT DENSITY function (→ 80). If the option selected in the function is changed, you are asked whether the totalizer should be reset to 0. We recommend you confirm this message and reset the totalizer.</p> <p>User input 5-digit floating-point number</p> <p>Factory setting See the parameter printout provided. The parameter printout is an integral part of these Operating Instructions.</p>
REFERENCE DENSITY	<p>Prerequisite The function is only available if CORRECTED VOLUME FLOW was selected in the MEASURING UNIT TYPE function (→ 78).</p> <p>Description Use this function to enter a fixed value for the density at reference/standard conditions. This value is used to calculate the corrected volume flow (see MEASURING UNIT TYPE function → 78).</p> <p>The appropriate unit is taken from the UNIT DENSITY function (→ 80). If the option selected in the function is changed, you are asked whether the totalizer should be reset to 0. We recommend you confirm this message and reset the totalizer.</p> <p>User input 5-digit floating-point number</p> <p>Factory setting See the parameter printout provided. The parameter printout is an integral part of these Operating Instructions.</p>

Function description, PROCESS PARAMETER group	
OPERATION TEMPERATURE	<p>Description Use this function to specify a fixed value for the process temperature. The appropriate unit is taken from the UNIT TEMPERATURE function (→ 80).</p> <p> Note! This setting does not change the permitted temperature range of the measuring system. Pay attention to the temperature application limits specified in the product specifications (→ 64).</p> <p>The sensor (measuring pipe and bluff body) expands differently depending on the existing process temperature. This has a proportional effect on the accuracy of the measuring system since the device was calibrated at a fixed calibration temperature of 20 °C (293 K). However, this effect on the current measured value and the internal totalizer can be compensated by entering an average process temperature in this function.</p> <p>If the process temperature is subject to severe changes, we recommend you use a flow computer (e.g. RMC621 or RMS621). These flow computers can compensate the effect on the K-factor by means of temperature compensation. If a flow computer is used, the value of the factory setting (20 °C, 293.15 K, 68 °F, 527.67 R) must be specified in this function.</p> <p>User input 5-digit floating-point number</p> <p>Factory setting 20 °C / 293.15 K / 68 °F / 527.67 R</p>

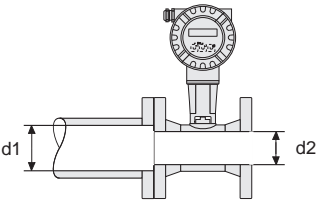
Function description, PROCESS PARAMETER group	
MATING PIPE DIAMETER	<p>Description</p> <p>The device has diameter mismatch correction. This can be activated by entering the actual value of the mating pipe (see Fig., d1) in this function.</p> <p>If the mating pipe (d1) and the measuring pipe (d2) have different diameters, this alters the flow profile. A diameter mismatch can occur if:</p> <ul style="list-style-type: none"> ■ The mating pipe has a different pressure rating to that of the measuring device. ■ The mating pipe has another schedule to that of the measuring device (e.g. 80 instead of 40), for ANSI. ■ The mating pipe is made of another material, in the case of DIN. <p>To correct any resulting shift in the calibration factor, enter the actual value of the mating pipe (d1) in this function.</p> <div style="text-align: center;">  </div> <p style="text-align: right; font-size: small;">A0001982</p> <p><i>Fig. 29: Mating pipe (d1)</i></p> <p>$d1 > d2$ $d1$ = Mating pipe diameter $d2$ = Measuring pipe diameter</p> <ul style="list-style-type: none"> ■ The inlet correction is switched off if 0 is entered in the function. ■ The appropriate unit is taken from the UNIT LENGTH function (→ 81). ■ Mismatches between diameters can only be corrected within the same nominal diameter class (e.g. DN 50/2"). ■ If the internal diameter of the process mating flange is larger than the internal diameter of the Vortex flange, you must reckon with an additional uncertainty of typically 0.1% (of the reading) per 1 mm deviation. ■ If the internal diameter of the process mating flange is smaller than the internal diameter of the Vortex flange, you must reckon with an additional uncertainty of typically 0.2% (of the reading) per 1 mm deviation. ■ The diameter mismatch should only be corrected within the limit values listed below for which test measurements have also been performed. <p>Flange connection: DN 15 (½"): ±20% of the internal diameter DN 25 (1"): ±15% of the internal diameter DN 40 (1½"): ±12% of the internal diameter DN ≥50 (2"): ±10% of the internal diameter</p> <p>Wafer: DN 15 (½"): ±15% of the internal diameter DN 25 (1"): ±12% of the internal diameter DN 40 (1½"): ±9% of the internal diameter DN ≥50 (2"): ±8% of the internal diameter</p> <p>User input 5-digit floating-point number</p> <p>Factory setting 0</p>

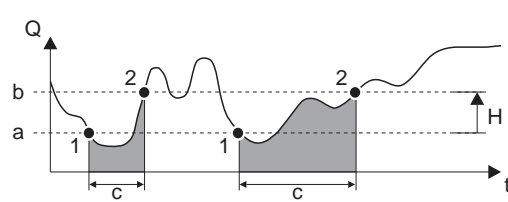

Function description, PROCESS PARAMETER group	
ON-VALUE LOW FLOW CUT OFF	<p>Description Use this function to enter the on-value for low flow cut off. Low flow cut off is switched on if the value entered is not equal to 0. As soon as the low flow cut off is active, an inverted plus sign is shown on the display.</p> <p>The appropriate unit is taken from the UNIT FLOW function (→ 79). The on-value can be set to a value corresponding to a Reynolds number of $Re = 20000$. This has the effect that measurements in the non-linear range are not evaluated. The Reynolds number and the flow (with Reynolds number = 20 000) can be determined using the Endress+Hauser "Applicator" software (→ 46).</p> <p>User input 5-digit floating-point number</p> <p>Factory setting Below the standard measuring range</p>
OFF-VALUE LOW FLOW CUT OFF	<p>Description Use this function to enter the off-value (b) for low flow cut off. Enter the off-value as a positive hysteresis (H) from the on-value (a).</p>  <p><i>Fig. 30: Example for the behavior of low flow cutoff</i></p> <p><i>Q</i> Flow rate [volume/time] <i>t</i> Time <i>a</i> ON-VALUE LOW FLOW CUTOFF = 20 m³/h <i>b</i> OFF-VALUE LOW FLOW CUTOFF = 10% <i>c</i> Low flow cutoff active <i>1</i> Low flow cutoff is switched on at 20 m³/h <i>2</i> Low flow cutoff is switched off at 22 m³/h <i>H</i> Hysteresis</p> <p>User input Integer 0 to 100%</p> <p>Factory setting 50%</p>
VELOCITY WARNING	<p>Description Use this function to activate flow velocity supervision (ON). If the fluid velocity exceeds the value entered in the LIMIT VELOCITY function (→ 105) the device issues the notice message "#421 FLOW RANGE" (→ 50).</p> <p>Options OFF (function switched off) ON</p> <p>Factory setting OFF</p>
LIMIT VELOCITY	<p>Description Enter the maximum allowable flow velocity (limit velocity). By switching on the VELOCITY WARNING function (→ 105), a warning message is output once the limit velocity is overshoot.</p> <p>The unit on the display depends on the UNIT LENGTH (→ 81): m/s; ft/s</p> <p>User input 5-digit floating-point number</p> <p>Factory setting 75 m/s</p>

A0001245

11.13 SYSTEM PARAMETER









Function description, SYSTEM PARAMETER group	
POSITIVE ZERO RETURN	<p>Description Use this function to interrupt evaluation of measured variables. This is necessary when a pipe is being cleaned, for example.</p> <p>The setting acts on all functions and outputs of the measuring device.</p> <p>If positive zero return is active, the notice message "#601 POS.ZERO-RET." is displayed (→  49).</p> <p>Options OFF ON (signal output is set to the value for zero flow)</p> <p>Factory setting OFF</p>
FLOW DAMPING	<p>Description</p> <p>For setting the filter depth. This reduces the sensitivity of the measuring signal to interference peaks e.g. in the event of high solids content, gas bubbles in the fluid, etc. The measuring system reaction time increases with the filter setting.</p> <p>The flow damping acts on the following functions and outputs of the measuring device:</p> <div style="display: flex; justify-content: space-between; align-items: flex-start; margin-top: 20px;"> <div style="text-align: center;"> <p>Function AMPLIFICATION</p> </div> <div style="text-align: center;"> <p>→ Function FLOW DAMPING</p> </div> <div style="text-align: center;"> <p>→ Function DISPLAY DAMPING</p> </div> <div style="text-align: center;"> <p>→ Function TIME CONSTANT</p> </div> <div style="text-align: center;"> <p>→ Function TIME CONSTANT</p> </div> <div style="text-align: center;"> <p>→ Display</p> </div> <div style="text-align: center;"> <p>→ Current output</p> </div> <div style="text-align: center;"> <p>→ Status output</p> </div> </div> <p style="text-align: right; font-size: small; margin-top: 10px;">A0010343-en</p> <p>User input 0 to 100 s</p> <p>Factory setting 1 s</p>

11.14 SENSOR DATA

Function description, SENSOR DATA group	
<p>All sensor data, such as the calibration factor or nominal diameter, are set at the factory.</p> <p> Caution! Under normal circumstances these settings may not be changed because changes affect numerous functions of the entire measuring system, and the accuracy of the measuring system in particular.</p> <p>If you have any questions on these functions contact your Endress+Hauser service organization.</p>	
CALIBRATION DATE	<p>Description The alteration date and time, when the K-FACTOR was changed (e.g. after a re-calibration), appears on the display.</p> <p>Display e.g. 100 P/l (pulse per liter)</p>
K-FACTOR	<p>Description The current calibration factor of the sensor appears on the display.</p> <p>The K-factor is also given on the nameplate, the sensor and the calibration protocol under "K-ct".</p> <p>Display e.g. 100 P/l (pulse per liter)</p>
K-FACTOR COMPENSATED	<p>Description The current compensated calibration factor of the sensor appears on the display. The following are compensated:</p> <ul style="list-style-type: none"> ■ The temperature-dependent expansion of the sensor (→  103). ■ Diameter steps in the inlet of the device (→  104). <p>Display e.g. 102 P/l (pulse per liter)</p>
NOMINAL DIAMETER	<p>The nominal diameter of the sensor appears on the display.</p> <p>Display e.g. DN 25</p>
METER BODY MB	<p>Description The type of meter body (MB) of the sensor appears on the display.</p> <ul style="list-style-type: none"> ■ Use this function to specify the nominal diameter and the sensor type. ■ The meter body MB is also given on the parameter printout and the nameplate. <p>Display e.g. 71</p>
TEMPERATURE COEFFICIENT SENSOR	<p>Description The temperature effect on the calibration factor appears on the display. Due to changes in temperature, the meter body expands differently, depending on the material. The expansion has an effect on the K-factor.</p> <p>Display 4.8800*10⁻⁵ / K (stainless steel) 2.6000*10⁻⁵ / K (Alloy C-22)</p>



Function description, SENSOR DATA group	
AMPLIFICATION	<p>Description</p> <p>Devices are always optimally configured for the process conditions you specified.</p> <p>Under certain process conditions, however, interference signals (e.g. strong vibrations) can be suppressed or the measuring range extended by adjusting the amplification. The amplification is configured as follows:</p> <ul style="list-style-type: none"> ■ A larger value can be entered for the amplification if the fluid is slow-flowing, the density is low and there are minor disturbance influences (e.g. plant vibrations). ■ A smaller value can be entered for the amplification if the fluid is fast-flowing, the density is high and there are strong disturbance influences (e.g. plant vibrations). <p> Note!</p> <p>Incorrectly configured amplification can have the following effects:</p> <ul style="list-style-type: none"> ■ The measuring range is limited in such a way that small flows cannot be recorded or displayed. In this instance, the value for the amplification must be increased. ■ Undesired interference signals are registered by the device which means that a flow is recorded and displayed even if the fluid is at a standstill. In this instance, the value for the amplification must be reduced. <p>Options</p> <p>1 to 5 (1 = smallest amplification, 5= largest amplification)</p> <p>Factory setting</p> <p>3</p>

11.15 SUPERVISION

Function description, SUPERVISION group	
ACTUAL SYSTEM CONDITION	<p>Description The current system status appears on the display.</p> <p>Display SYSTEM OK or The fault/notice message with the highest priority.</p>
PREVIOUS SYSTEM CONDITIONS	<p>Description The last 16 fault and notice messages appear on the display.</p>
ASSIGN SYSTEM ERROR	<p>Description All system errors appear on the display. If you select an individual system error you can change its error category:</p> <ul style="list-style-type: none"> ■ Each individual message can be selected using the  and  key. ■ If the  key is pressed twice, the ERROR CATEGORY function is called up. ■ Use the  key combination or select "CANCEL" (in the system error list) to exit the function. <p>Display List of system errors</p>
ERROR CATEGORY	<p>Description Use this function to define whether a system error triggers a notice message or a fault message. If you select FAULT MESSAGES, all outputs respond to an error in accordance with their defined failsafe mode.</p> <ul style="list-style-type: none"> ■ Press the  key twice to call up the ASSIGN SYSTEM ERROR function (→  109). ■ Use the  key combination to exit the function. <p>Options NOTICE MESSAGE (display only) FAULT MESSAGE (outputs and display)</p>
ALARM DELAY	<p>Description Use this function to enter a time span for which the criteria for an error always have to be satisfied before a fault or notice message is generated. Depending on the setting and the type of error, this suppression acts on the display, the current output and the pulse/status output.</p> <p> Note! If this function is used, fault and notice messages are delayed by the time corresponding to the setting before being forwarded to the higher-level controller (PCS, etc.). Therefore, check in advance whether a delay of this nature could affect the safety requirements of the process. If fault and notice messages may not be suppressed, a value of 0 seconds must be entered here.</p> <p>User input 0 to 100 s (in steps of one second)</p> <p>Factory setting 0 s</p>

Function description, SUPERVISION group	
SYSTEM RESET	<p>Description Use this function to restart (reset) the measuring device.</p> <p>Options</p> <p>NO The device is not restarted.</p> <p>RESTART SYSTEM Restart without disconnecting main power. In doing so, all the data (functions) are accepted unchanged.</p> <p>RESET DELIVERY Restart without disconnecting main power. The saved settings of the delivery status (factory settings) are accepted as a result.</p> <p>Factory setting NO</p>
OPERATION HOURS (pending)	<p>Description The hours of operation of the device appear on the display.</p> <p>Display Depends on the number of hours of operation elapsed: Hours of operation < 10 hours → display format = 0:00:00 (hr:min:sec) Hours of operation 10 to 10 000 hours → display format = 0000:00 (hr:min) Hours of operation > 10 000 hours → display format = 000000 (hr)</p>

11.16 SIMULATION SYSTEM

Function description, SIMULATION SYSTEM group	
SIMULATION FAILSAFE MODE	<p>Description Use this function to set all inputs, outputs and the totalizer to their error-response modes, in order to check whether they respond correctly. During this time, the message #691 "SIMULATION FAILSAFE" appears on the display (→ 49).</p> <p>Options OFF ON</p> <p>Factory setting OFF</p>
SIMULATION MEASURAND	<p>Description Use this function to set all the inputs, outputs and the totalizer to their flow-response modes, in order to check whether they respond correctly. During this time, the message "#692 SIMULATION MEASURAND" appears on the display (→ 49).</p> <p> Note! <ul style="list-style-type: none"> ■ The measuring device can only be used for measuring to a certain extent while the simulation is in progress. ■ The setting is not saved if the power supply fails. </p> <p>Options OFF FLOW</p> <p>Factory setting OFF</p>
VALUE SIMULATION MEASURAND	<p>Prerequisite Function is only available if the SIMULATION MEASURAND function (→ 111) is active.</p> <p>Description Use this function to specify an arbitrary value (e.g. 12 dm³/s) to check downstream devices or the measuring device itself. The appropriate unit is taken from the UNIT FLOW function (→ 79).</p> <p> Note! The setting is not saved if the power supply fails.</p> <p>User input 5-digit floating-point number</p> <p>Factory setting 0</p>

11.17 SENSOR VERSION

Function description, SENSOR VERSION group	
SERIAL NUMBER	Description The serial number of the sensor appears on the display.
SENSOR TYPE	Description The sensor type (e.g. Prowirl F) appears on the display.
SERIAL NUMBER DSC SENSOR	Description The serial number of the DSC sensor appears on the display.

11.18 AMPLIFIER VERSION

Function description, AMPLIFIER VERSION group	
DEVICE SOFTWARE	Description Use this function to display the current device software version.
HARDWARE REVISION NUMBER AMPLIFIER	Description Use this function to view the hardware revision number of the amplifier board.
SOFTWARE REVISION NUMBER AMPLIFIER	Description Use this function to view the software revision number of the amplifier board.
HARDWARE REVISION NUMBER I/O MODULE	Description Use this function to display the hardware revision number of the I/O module.

12 Factory settings

12.1 SI units (not for USA and Canada)

12.1.1 Units of length and temperature

	Unit
Temperature	°C
Length	mm

12.1.2 Language

Country	Language	Country	Language
Australia	English	Norway	Norsk
Belgium	English	Austria	Deutsch
Denmark	English	Poland	Polski
Germany	Deutsch	Portugal	Portugues
England	English	Sweden	Svenska
Finland	Suomi	Switzerland	Deutsch
France	Francais	Singapore	English
The Netherlands	Nederlands	Spain	Espanol
Hong Kong	English	South Africa	English
India	English	Thailand	English
Italy	Italiano	Czechia	Cesky
Luxembourg	Francais	Hungary	English
Malaysia	English	Other countries	English

12.1.3 100% value line 1 and line 2

The factory settings in the table are given in the dm^3/s unit. If another unit is selected in the UNIT FLOW function (→  79), the corresponding value is converted and displayed in the selected unit.

Nominal diameter DN		Flange		Wafer	
DIN [mm]	ANSI [in]	Gas [dm^3/s]	Liquid [dm^3/s]	Gas [dm^3/s]	Liquid [dm^3/s]
15	½"	7.2	1.4	8	2
25	1"	32	4	48	6
40	1½"	80	10	80	16
50	2"	160	16	160	20
80	3"	320	40	400	48
100	4"	560	64	640	80
150	6"	1280	160	1600	160
200	8"	2400	320	–	–
250	10"	4000	480	–	–
300	12"	5600	640	–	–

12.1.4 Unit totalizer

Flow	Unit
Volume flow	m ³
Calculated mass flow	kg
Corrected volume flow	Nm ³

12.1.5 Switch-on point and switch-off point for Prowirl W

The factory settings in the table are given in the dm³/s unit. If another unit is selected in the UNIT FLOW function (→ 79), the corresponding value is converted and displayed in the selected unit.

Nominal diameter DN		Gas		Liquid	
DIN [mm]	ANSI [in]	On-value [dm ³ /s]	Off-value [dm ³ /s]	On-value [dm ³ /s]	Off-value [dm ³ /s]
15	½"	13	10	2.1	1.7
25	1"	49	40	5.9	4.8
40	1½"	110	94	14	11
50	2"	190	150	22	18
80	3"	420	340	50	41
100	4"	710	580	85	70
150	6"	1600	1300	190	160
200	8"	–	–	–	–
250	10"	–	–	–	–
300	12"	–	–	–	–

12.1.6 Switch-on point and switch-off point for Prowirl F

The factory settings in the table are given in the dm³/s unit. If another unit is selected in the UNIT FLOW function (→ 79), the corresponding value is converted and displayed in the selected unit.

Nominal diameter DN		Gas		Liquid	
DIN [mm]	ANSI [in]	On-value [dm ³ /s]	Off-value [dm ³ /s]	On-value [dm ³ /s]	Off-value [dm ³ /s]
15	½"	7.7	6.3	1.5	1.2
25	1"	38	31	4.6	3.8
40	1½"	94	77	11	9.2
50	2"	160	130	19	15
80	3"	350	290	42	35
100	4"	610	500	73	60
150	6"	1400	1100	170	140
200	8"	2700	2200	320	260
250	10"	4200	3400	500	410
300	12"	6000	4900	720	590

12.2 US units (only for USA and Canada)

12.2.1 Units of length and temperature

	Unit
Temperature	°F
Length	inch

12.2.2 Language

	Language
USA	English
Canada	English

12.2.3 100% value line 1 and line 2

The factory settings in the table are given in the US gal/min (GPM) unit. If another unit is selected in the UNIT FLOW function (→  79), the corresponding value is converted and displayed in the selected unit.

Nominal diameter DN		Flange		Wafer	
DIN [mm]	ANSI [inch]	Gas [US gal/min]	Liquid [US gal/min]	Gas [US gal/min]	Liquid [US gal/min]
15	½"	110	22	120	32
25	1"	550	63	760	95
40	1½"	1300	160	1300	250
50	2"	2500	250	2500	310
80	3"	5100	630	6300	760
100	4"	8900	1000	10000	1300
150	6"	20000	2500	25000	2500
200	8"	38000	5100	–	–
250	10"	63000	7600	–	–
300	12"	89000	10000	–	–

12.2.4 Unit totalizer

Flow	Unit
Volume flow	US gal
Calculated mass flow	lb
Corrected volume flow	Sm ³

12.2.5 Switch-on point and switch-off point for Prowirl W

The factory settings in the table are given in the unit US gallons/min. If another unit is selected in the UNIT FLOW function (→  79), the corresponding value is converted and displayed in the selected unit.

Nominal diameter DN		Gas		Liquid	
DIN [mm]	ANSI [inch]	On-value [US Gal/min]	Off-value [US Gal/min]	On-value [US Gal/min]	Off-value [US Gal/min]
15	½"	200	160	34	27
25	1"	780	640	94	77
40	1½"	1800	1500	220	180
50	2"	2900	2400	350	290
80	3"	6600	5400	790	650
100	4"	11 000	9200	1400	1100
150	6"	25 000	21 000	3000	2500
200	8"	–	–	–	–
250	10"	–	–	–	–
300	12"	–	–	–	–

12.2.6 Switch-on point and switch-off point for Prowirl F

The factory settings in the table are given in the unit US gallons/min. If another unit is selected in the UNIT FLOW function (→  79), the corresponding value is converted and displayed in the selected unit.

Nominal diameter DN		Gas		Liquid	
DIN [mm]	ANSI [inch]	On-value [US Gal/min]	Off-value [US Gal/min]	On-value [US Gal/min]	Off-value [US Gal/min]
15	½"	120	100	24	19
25	1"	610	500	73	60
40	1½"	1500	1200	180	150
50	2"	2500	2000	300	240
80	3"	5600	4600	6700	550
100	4"	9700	7900	1200	950
150	6"	22 000	18 000	2600	2200
200	8"	42 000	35 000	5100	4100
250	10"	67 000	54 000	8000	6500
300	12"	95 000	78 000	11 000	9400

Index

Numerics

100% VALUE (fct.)	85
20mA value	89

A

Accessories	44
ACTUAL STATUS OUTPUT (fct.)	97
ACTUAL SYSTEM CONDITION (fct.)	109
Actual value	
ACTUAL CURRENT (fct.)	89
ACTUAL PULSE (fct.)	95
ALARM DELAY (fct.)	109
Ambient temperature	63
AMPLIFICATION (fct.)	108
AMPLIFIER SOFTWARE REVISION NUMBER (fct.)	112
AMPLIFIER VERSION, function group	112
Application	59
APPLICATION (fct.)	102
Applicator (selection and configuration software)	46
Approvals	11
Arbitrary volume unit	
FACTOR ARBITRARY VOLUME UNIT	81
TEXT ARBITRARY VOLUME UNIT (fct.)	81
Assign	
ASSIGN LINE 1 (fct.)	85
ASSIGN LINE 2 (fct.)	85
ASSIGN STATUS (fct.)	96
ASSIGNMENT SYSTEM ERROR (fct.)	109

B

Brief Operating Instructions	2
BURST MODE (fct.)	101

C

Cable entry	62
Degree of protection	26
Technical data	62
Cable specification	62
Cable specification for armored connecting cable	22
Cable specification for standard connecting cable	22
Cable specifications (remote version)	22
CALIBRATION DATE (fct.)	107
CE mark (Declaration of Conformity)	11
Certificates	11
Cleaning	
Exterior cleaning	43
Code	
ACCESS CODE (fct.)	83
ACCESS CODE COUNTER (fct.)	84
Code entry (function matrix)	29
DEFINE PRIVATE CODE (fct.)	83
Commissioning	
After installing a new electronics board	40
Examples of configuration	42
Quick Setup flowchart	41
Switching on the measuring device	39
Commubox FXA195 (electrical connection)	25, 46

Communication	31
COMMUNICATION, function group	101
Connection	
See Electrical connection	21
CONTRAST LCD (fct.)	86
Counter	84
C-Tick mark	11
Current output	
ACTUAL CURRENT (fct.)	89
CURRENT SPAN (fct.)	89
Electrical connection	24
FAILSAFE MODE (fct.)	89
SIMULATION CURRENT (fct.)	90
TIME CONSTANT (fct.)	89
VALUE 20 mA (fct.)	89
VALUE SIMULATION CURRENT (fct.)	90
CURRENT OUTPUT, function group	89
CURRENT SPAN (fct.)	89

D

Damping	
DISPLAY DAMPING (fct.)	86
FLOW DAMPING (fct.)	106
Date/Time	
FORMAT DATE/TIME	81
Declaration of Conformity (CE mark)	11
DEFINE PRIVATE CODE (fct.)	83
Degree of protection	
Mounting information	26
Technical data	64
Density	
OPERATION DENSITY (fct.)	102
REFERENCE DENSITY (fct.)	102
Description of device functions	75
Designated use	7
Device description files	32
Device designation	9
DEVICE ID (fct.)	101
DEVICE SOFTWARE (fct.)	112
Device variables	32
Diameter	
Jump correction	104
MATING PIPE DIAMETER (fct.)	104
Display	
Display and operating elements	27
Rotating the local display	19
Disposal	58
Documentation	72

E

Electrical connection	
Cable specifications (remote version)	22
Commubox FXA191	25
Degree of protection	26
HART handheld terminal	25
Post-connection check (checklist)	26
Remote version	21

Terminal assignment	24
Transmitter	22
Electromagnetic compatibility	64
Electromagnetic compatibility (EMC)	64
Electronics boards	
Installation/removal Ex-d version	56
Non-Ex, Ex-i and Ex-n version	54
Environment	63
ERROR CATEGORY (fct.)	109
Error messages	
Confirming error messages	30
Display	30
System error (device error)	48
Types of error (system and process errors)	30
Types of error message	30
European Pressure Equipment Directive (PED)	71
Ex approval	71
Exterior cleaning	43
F	
FACTOR ARBITRARY VOLUME UNIT (fct.)	81
Failsafe mode	
FAILSAFE MODE current output (fct.)	89
FAILSAFE MODE, pulse output (fct.)	95
FAILSAFE MODE, totalizers (fct.)	88
Inputs/outputs, general	52
SIMULATION FAILSAFE MODE (fct.)	111
FIELDBUS ADDRESS (fct.)	101
FieldCare	31, 46
Fieldcheck (tester and simulator)	46
Flow	
FLOW (fct.)	77
FLOW DAMPING (fct.)	106
Flow direction	14
Limiting flow	17, 66
Flow conditioner	73
FLOW VELOCITY (fct.)	77
Fluid	
Pressure range	65
Temperature range	64
FORMAT (fct.)	85
FORMAT DATE/TIME (fct.)	81
Frequency ranges for air and water	67
Function and system design	59
Function check	39
Function group	
AMPLIFIER VERSION	112
COMMUNICATION	101
CURRENT OUTPUT	89
MEASURED VALUES	77
OPERATION	83
PROCESS PARAMETER	102
PULSE/STATUS OUTPUT	91
QUICK SETUP	82
SENSOR DATA	107
SENSOR VERSION	112
SIMULATION SYSTEM	111
SUPERVISION	109
SYSTEM PARAMETER	106

SYSTEM UNITS	78
TOTALIZER	87
USER INTERFACE	85
Function group, description	28
Function matrix (overview)	75
Function, description	28
Functional safety (SIL)	71
FXA193	46
FXA195	46
G	
Galvanic isolation	61
Group	
See function group	
H	
Hardware revision number	
AMPLIFIER (fct.)	112
I/O MODULE (fct.)	112
HART	
Command classes	31
Command No.	33
commands	33
Communicator Field Xpert	31
Device description files	32
Device status, error messages	37
Device variables	32
Electrical connection	25
Error messages	37
Handheld terminal	25
Modem	25
Process variables	32
Hazardous substances	8
Heat insulation	15
HOME position (operating mode display)	27
I	
Incoming acceptance	12
Inlet and outlet run	63
Inlet runs	16
Input	59
Installation	18, 63
See Installation conditions	
Installation conditions	
Check (checklist)	20
Dimensions	13
Inlet and outlet run	16
Installation point	13
Lengths	18
Orientation (vertical, horizontal)	14
Vibrations	17
Installation instructions	63
Insulation of sensors	15
K	
K-FACTOR (fct.)	107
K-FACTOR COMPENSATED (fct.)	107
L	
LANGUAGE (fct.)	83

LCD CONTRAST (fct.)	86	OPERATION TEMPERATURE (fct.)	103
LIMIT VELOCITY (fct.)	105	OPERATION MODE (fct.)	91
Load	61	Order code	
Local display		Accessories	44
See Display		Sensor remote version	10
Low flow cut off		Transmitter	9
Low flow cut off	61	Ordering information	72
OFF-VALUE LOW FLOW CUTOFF (fct.)	105	Outlet runs	16
ON-VALUE LOW FLOW CUTOFF (fct.)	105	Output signal	60
M		OUTPUT SIGNAL (fct.)	93
MANUFACTURER ID (fct.)	101	Outputs, general	60
Material	69	OVERFLOW (fct.)	87
MEASURED VALUES, function group	77	P	
Measuring		Perforated plate flow conditioner	17
Maximum measured error	62	POSITIVE ZERO RETURN (fct.)	106
Measurand	59	Post-installation check (checklist)	20
Measuring principle	59	Power supply	
Measuring range	59	Power supply failure	62
Measuring system	59	Supply voltage (power supply)	62
Performance characteristics	62	Power supply (supply voltage)	62
Measuring		Pressure	
Measuring system	9	Device approval (PED)	71
MEASURING UNIT TYPE (fct.)	78	Loss	66
METER BODY MB (fct.)	107	PREVIOUS SYSTEM CONDITIONS (fct.)	109
Mounting		Process	64
Sensor (compact version)	18	Process error	
Transmitter (remote version)	20	Description	30
N		Messages	50
Nameplate		Process errors without messages	50
Sensor remote version	10	PROCESS PARAMETER, function group	102
Service	10	Process variables	32
Transmitter/sensor, compact version	9	Programming mode	
NOMINAL DIAMETER (fct.)	107	Disabling	29
O		Enabling	29
Off-value		Pulse output	
OFF-VALUE LOW FLOW CUTOFF (fct.)	105	ACTUAL PULSE (fct.)	95
status output (fct.)	97	FAILSAFE MODE (fct.)	95
On-value		OUTPUT SIGNAL (fct.)	93
status output	96	PULSE VALUE (fct.)	91
Operating		PULSE WIDTH (fct.)	92
OPERATION HOURS (fct.)	110	SIMULATION PULSE (fct.)	95
Operational safety	7	VALUE SIMULATION PULSE	96
Operating conditions		PULSE VALUE (fct.)	91
Environment	63	PULSE WIDTH (fct.)	92
Installation	63	Pulse/status output	
Process	64	Operating mode	91
Operation		PULSE/STATUS OUTPUT, function group	91
Device description files	32	Q	
Display and operating elements	27	Quick Setup Commissioning	
FieldCare	31	Examples of configuration	42
Function matrix	28	Flowchart	41
General notes	29	QUICK SETUP COMMISSIONING (fct.)	82
HART handheld terminal	25	QUICK SETUP, function group	82
Operating programs	31	R	
OPERATION (function group)	83	Reaction time/step response time	63
OPERATION DENSITY (fct.)	102	REFERENCE DENSITY (fct.)	102
		Reference operating conditions	62

Registered trademarks 11
 Remote operation 70
 Repair 8
 Repeatability 62
 Replacing
 Printed circuit boards (installation/removal) 54
 Seals 43
 Reset
 RESET TOTALIZER (fct.) 88
 SYSTEM RESET (fct.) 109
 Returning devices 8

S

Safety
 Icons 8
 Notes 7
 Operating 7
 Seals
 Replacing, replacement seals 43
 SENSOR DATA, (function group) 107
 Sensor transport 12
 SENSOR TYPE (fct.) 112
 SENSOR VERSION, function group 112
 Serial number 9–10
 SERIAL NUMBER DSC-SENSOR (fct.) 112
 SERIAL NUMBER sensor (fct.) 112
 Service interface FXA 193 46
 Service nameplate 10
 Signal on alarm 61
 SIL (functional safety) 7, 71
 Simulation
 SIMULATION CURRENT (fct.) 90
 SIMULATION FAILSAFE MODE (fct.) 111
 SIMULATION MEASURAND (fct.) 111
 SIMULATION PULSE (fct.) 95
 SIMULATION SWITCH POINT (fct.) 97
 SIMULATION MEASURAND (fct.) 111
 SIMULATION SYSTEM, function group 111
 Software
 Amplifier display 39
 Starting measuring operation 39
 Start-up message 39
 Versions (history) 58
 Software version, device 112
 Spare parts 53
 Standards, guidelines 71
 STATUS ACCESS (fct.) 83
 Status output 99
 ACTUAL STATUS OUTPUT (fct.) 97
 ASSIGN STATUS (fct.) 96
 General information 99
 Limit value 99
 OFF-VALUE (fct.) 97
 ON-VALUE (fct.) 96
 SIMULATION SWITCH POINT (fct.) 97
 Switching behaviour 99
 TIME CONSTANT (fct.) 97
 VALUE SIMULATION SWITCH POINT (fct.) 98
 Storage 12

Conditions 12
 Temperature 64
 SUM (fct.) 87
 SUPERVISION, function group 109
 Supplementary Ex documentation 7
 Switch-on point
 ON-VALUE LOW FLOW CUTOFF (fct.) 105
 System
 Error messages 48
 SYSTEM RESET (fct.) 109
 System condition
 Actual 109
 Previous 109
 SYSTEM ERROR ASSIGNMENT (fct.) 109
 SYSTEM PARAMETER, function group 106
 SYSTEM UNITS, function group 78

T

Tag
 TAG DESCRIPTION (fct.) 101
 TAG NAME (fct.) 101
 Technical data at a glance 59
 TEMPERATURE COEFFICIENT SENSOR (fct.) 107
 Temperature ranges
 Ambient temperature 63
 Medium temperature 64
 Storage temperature 64
 Terminal assignment 24
 TEST DISPLAY (fct.) 86
 Time constant
 TIME CONSTANT current output (fct.) 89
 TIME CONSTANT status output (fct.) 97
 Totalizer
 FAILSAFE MODE (fct.) 88
 OVERFLOW (fct.) 87
 RESET TOTALIZER (fct.) 88
 SUM (fct.) 87
 TOTALIZER, function group 87
 UNIT TOTALIZER (fct.) 87
 Transmitter
 Electrical connection 21–22
 Mounting 18
 Mounting the remote version 20
 Rotating the housing 19
 Troubleshooting 47

U

Unit
 TEXT ARBITRARY VOLUME UNIT (fct.) 81
 UNIT DENSITY (fct.) 80
 UNIT FLOW (fct.) 79
 UNIT LENGTH (fct.) 81
 UNIT TEMPERATURE (fct.) 80
 UNIT TOTALIZER (fct.) 87
 USER INTERFACE (function group) 85

V

VALUE 20 mA (fct.) 89
 Value simulation
 VALUE SIMULATION CURRENT (fct.) 90

VALUE SIMULATION MEASURAND (fct.)	111
VALUE SIMULATION PULSE (fct.)	96
VALUE SIMULATION SWITCH POINT, status output (fct.) 98	
VELOCITY WARNING (fct.)	105
Version	
AMPLIFIER VERSION, function group	112
SENSOR VERSION, function group	112
Vibration resistance	64
Vibrations	64
VORTEX FREQUENCY (fct.)	77
W	
Weight	69
Wiring	21
See Electrical connection	
WRITE PROTECTION (fct.)	101

Declaration of Hazardous Material and De-Contamination Erklärung zur Kontamination und Reinigung

RA No.

Please reference the Return Authorization Number (RA#), obtained from Endress+Hauser, on all paperwork and mark the RA# clearly on the outside of the box. If this procedure is not followed, it may result in the refusal of the package at our facility.
Bitte geben Sie die von E+H mitgeteilte Rücklieferungsnummer (RA#) auf allen Lieferpapieren an und vermerken Sie diese auch außen auf der Verpackung. Nichtbeachtung dieser Anweisung führt zur Ablehnung ihrer Lieferung.

Because of legal regulations and for the safety of our employees and operating equipment, we need the "Declaration of Hazardous Material and De-Contamination", with your signature, before your order can be handled. Please make absolutely sure to attach it to the outside of the packaging.

Aufgrund der gesetzlichen Vorschriften und zum Schutz unserer Mitarbeiter und Betriebseinrichtungen, benötigen wir die unterschriebene "Erklärung zur Kontamination und Reinigung", bevor Ihr Auftrag bearbeitet werden kann. Bringen Sie diese unbedingt außen an der Verpackung an.

Type of instrument / sensor

Geräte-/Sensortyp _____

Serial number

Seriennummer _____

Used as SIL device in a Safety Instrumented System / Einsatz als SIL Gerät in Schutzeinrichtungen

Process data / Prozessdaten

Temperature / Temperatur _____ [°F] _____ [°C]

Pressure / Druck _____ [psi] _____ [Pa]

Conductivity / Leitfähigkeit _____ [µS/cm]

Viscosity / Viskosität _____ [cp] _____ [mm²/s]

Medium and warnings

Warnhinweise zum Medium



	Medium / concentration Medium / Konzentration	Identification CAS No.	flammable entzündlich	toxic giftig	corrosive ätzend	harmful/ irritant gesundheits- schädlich/ reizend	other * sonstiges*	harmless unbedenklich
Process medium Medium im Prozess								
Medium for process cleaning Medium zur Prozessreinigung								
Returned part cleaned with Medium zur Endreinigung								

* explosive; oxidising; dangerous for the environment; biological risk; radioactive

* explosiv; brandfördernd; umweltgefährlich; biogefährlich; radioaktiv

Please tick should one of the above be applicable, include safety data sheet and, if necessary, special handling instructions.

Zutreffendes ankreuzen; trifft einer der Warnhinweise zu, Sicherheitsdatenblatt und ggf. spezielle Handhabungsvorschriften beilegen.

Description of failure / Fehlerbeschreibung _____

Company data / Angaben zum Absender

Company / Firma _____	Phone number of contact person / Telefon-Nr. Ansprechpartner: _____
Address / Adresse _____	Fax / E-Mail _____
_____	Your order No. / Ihre Auftragsnr. _____

"We hereby certify that this declaration is filled out truthfully and completely to the best of our knowledge. We further certify that the returned parts have been carefully cleaned. To the best of our knowledge they are free of any residues in dangerous quantities."

"Wir bestätigen, die vorliegende Erklärung nach unserem besten Wissen wahrheitsgetreu und vollständig ausgefüllt zu haben. Wir bestätigen weiter, dass die zurückgesandten Teile sorgfältig gereinigt wurden und nach unserem besten Wissen frei von Rückständen in gefährlicher Menge sind."

(place, date / Ort, Datum)

Name, dept./Abt. (please print / bitte Druckschrift)

Signature / Unterschrift

www.endress.com/worldwide

Endress + Hauser 
People for Process Automation
