

Equipment architecture of the Omnigrad S TC88

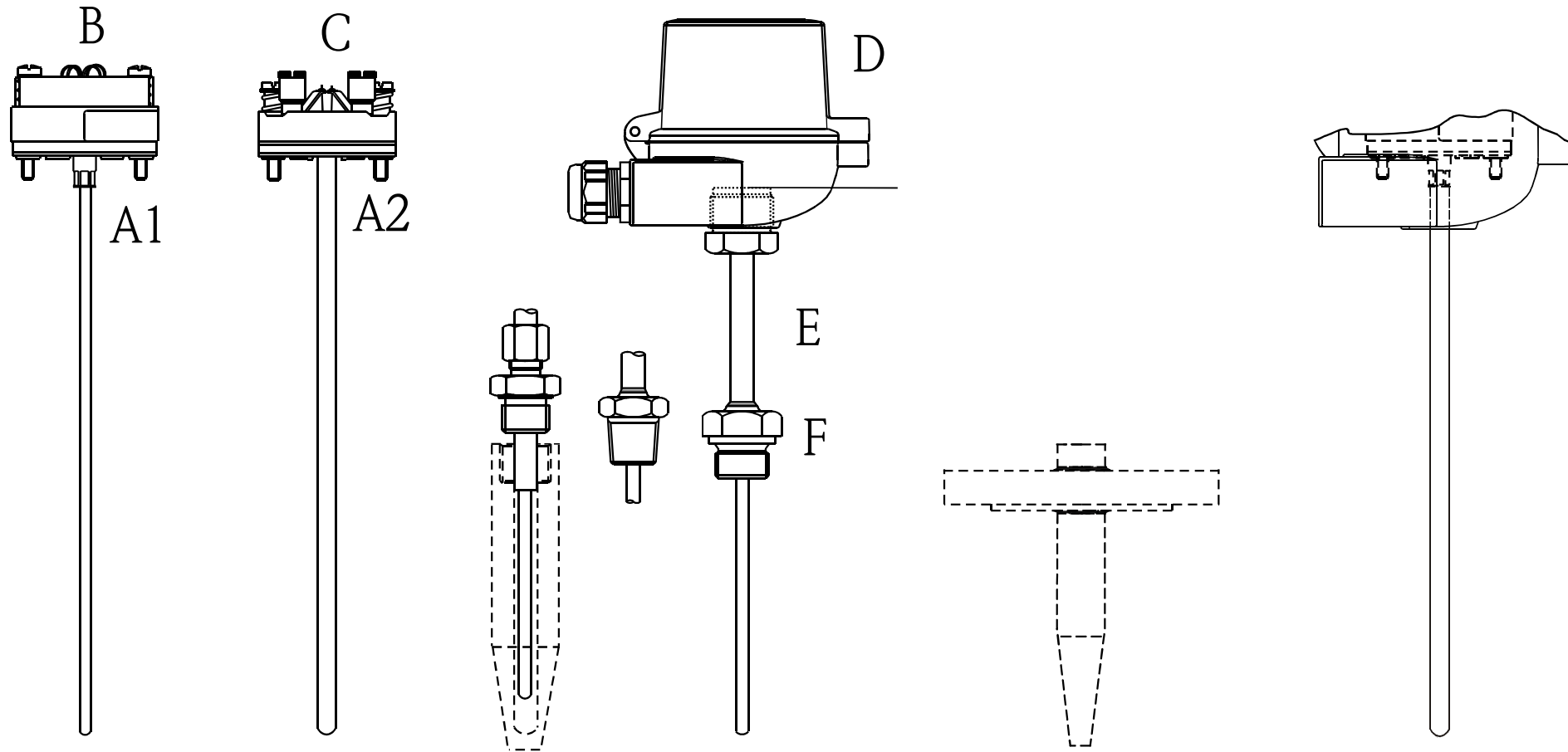

- A1 Insert (\varnothing 3 mm, 0.12 in) with mounted head transmitter, for example
- A2 Insert (\varnothing 6 mm, 0.24 in) with mounted ceramic terminal block, for example
- B Head transmitter
- C Ceramic terminal
- D Terminal head
- E Various tip shapes
- F Process connection