

# Equipment architecture of the Omnigrad M TC15

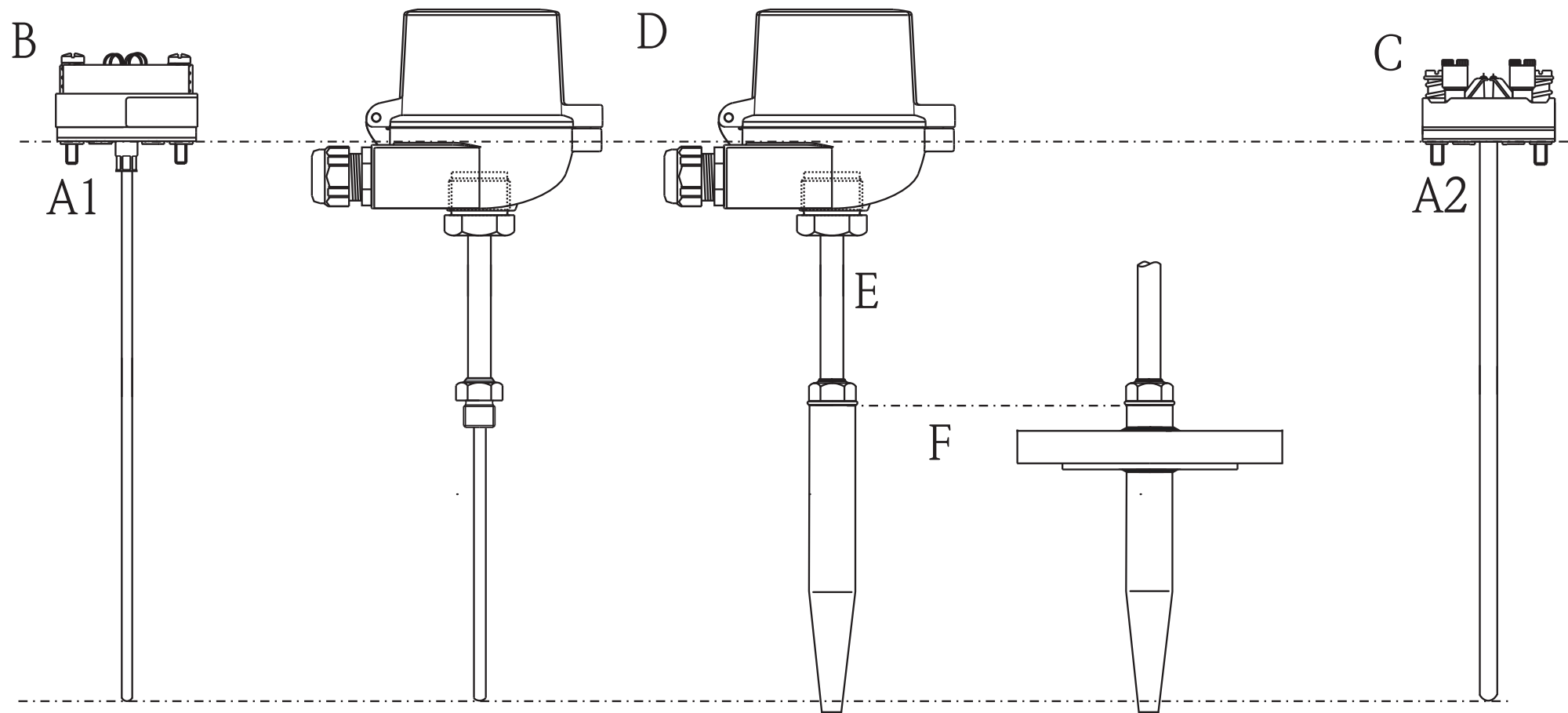

- A1 Insert ( $\varnothing$  3 mm, 0.12 in) with mounted head transmitter, for example
- A2 Insert ( $\varnothing$  6 mm, 0.24 in) with mounted ceramic terminal block, for example
- B Head transmitter
- C Ceramic terminal
- D Terminal head
- E Protection armature
- F Process connection