

Product Overview

A snapshot of Endress+Hauser's product lines

- Level
- Flow
- Pressure
- Temperature
- Data Acquisition
- System Components
- Liquid Analysis
- Advanced Analysis
- Services
- Solutions

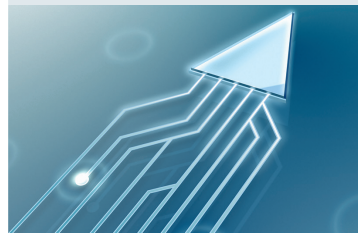
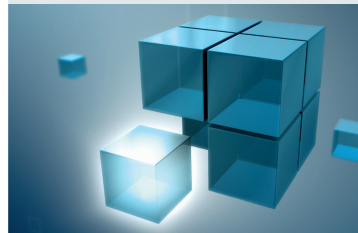
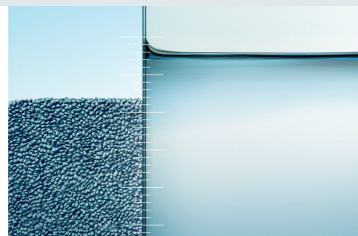

Personal and digital.
My Endress+Hauser.



Fast. Easy. Convenient.

Introducing new possibilities on **Endress.com!**

- Set up an account to shop for devices, spare parts & accessories
- Get easy access to technical information and documentation
- Buy online or request a quote from a sales representative
- Track the status of your quotes and orders
- View both online and offline transactions - all in one place
- Search quickly for products with our Product Finder, or by entering an order code or serial number



Register Today!



Set up your account and
start shopping today!
www.us.endress.com/e-commerce

Endress + Hauser 
People for Process Automation

Product Overview

A snapshot of Endress+Hauser's product lines

Be sure to visit our website, www.us.endress.com, for the latest technical information on all products.

Contact Endress+Hauser at 888-ENDRESS for individual product Technical Information brochures.

Fast. Easy. Convenient. Register now! Decide which products you need, check your transactions online, get access to technical documents, including drawings, and much more!
Register for an account at www.us.endress.com/register

Endress+Hauser USA
2350 Endress Place
Greenwood, IN 46143

© Endress+Hauser USA, 2020

Endress+Hauser reserves the right to change or modify our product appearance and specifications at any time without notice. Though the information provided herein is believed to be accurate, be advised that the information contained herein is NOT a guarantee for satisfactory results.

02.21

Table of contents

Introduction to Endress+Hauser	3	Analysis	
Technologies overview	4	Liquid Analysis	62
Endress+Hauser Product Overview		pH and ORP sensors / holders / transmitters	
Level	19	Conductivity sensors / holders / transmitters	
Vibration		Chlorine sensors / holders / transmitters	
Conductivity		Dissolved oxygen sensors / holders / transmitters	
Capacitance		Turbidity sensors / holders / transmitters	
Radar		Colorimetric analyzers	
Tank Gauging		TOC and Phosphorus	
Guided radar		Nutrient	
Microwave barrier		Process photometers	
Mechanical		Optical sensors and transmitters	
Ultrasonic		Software	
Radiometric (Gamma)		Advanced Analysis	88
Flow	34	Laser-based Raman Spectroscopy	
Electromagnetic		Quench fluorescence	
Coriolis		Tunable diode laser	
Ultrasonic		Sampling systems	
Vortex		Portfolio Overview	
Thermal		Services	102
OEM		Applicator	
Flow monitoring		Commissioning services	
Differential pressure		Plant life cycle (W@M)	
Pressure	49	Technical support	
Gauge/absolute		Repair	
Differential		Repair field service	
Hydrostatic		Calibration services	
Temperature	52	Calibration management	
Transmitters		Maintenance services	
Head transmitters		Support services	
RTD temperature sensors		Process Training University	
Thermocouple temperature sensors		Solutions	104
Compact thermometers		Analytical Solutions	
Data Acquisition and Components	58	Energy Solutions	
Recorders		Flow Management solutions	
Multi-functional components (display / power supply)		Field Network Engineering	
Multi-functional components		Inventory Management solutions	
DIN rail mounting		Plant Asset Management	
Wireless HART		Netilion Digital services	
Field Gateway components		SupplyCare software	
FieldCare software			
Field Xpert communicators			



Click the home button on the bottom of the page to return to the Table of Contents

Trademarks

PEEK is a registered trademark of Victrex
 Liquiphant, Micropilot, Deltatop is a registered trademark of MESTRA AG
 Profibus PA is a registered trademark of The PROFIBUS User Organization
 Tri-Clamp is a registered trademark of Ladish & Co., Inc., Kenosha, USA
 Varivent is a registered trademark of GEA Tuchenhausen
 Bluetooth is a registered trademark of Bluetooth SIG, Inc.
 Soliphant, Solicap, Liquicap, Solimotion, Cerabar, Ceraphant, Deltabar, Deltapilot, Contite, Fieldgate are registered trademarks of Endress+Hauser GmbH+Co. KG, Maulburg, Germany
 FieldCare, W@M, Field Xpert are registered trademarks of Endress+Hauser Process Solutions AG, Reinach, Switzerland
 HART, WirelessHART are registered trademarks of HART Communication Foundation, Austin, USA
 FOUNDATION Fieldbus is a trademark of the Fieldbus Foundation
 Gammapilot, PTU are registered trademarks of Endress+Hauser, Inc. Greenwood, IN
 Promag, Promass, Cubemass, Prowirl, Dosimag, Magphant, Flowphant, Applicator, Heartbeat Technology are registered trademarks of Endress+Hauser Flowtec AG, Reinach, Switzerland
 iTEMP, ITherm, easytemp, Thermophant, EngyCal, Minilog, Memograph are registered trademarks of Endress+Hauser Wetzler GmbH+Co.KG, Nesselwang, Germany
 Memosens, Cleanfit, Memocheck, Orbisint, Oxymax, Stamolys, Liquiline, Mycom, Oxymax, Viomax, Liquistation, Memobase are registered trademarks of Endress+Hauser Conducta GmbH + Co. KG, Gerlingen, Germany
 All other trademarks are the property of their respective owners. All other trademarks are the properties of their respective owners.

Endress+Hauser is a global supplier of process automation solutions. The company develops, manufactures and sells sensors and systems for production and logistics in the process industry. These products acquire, transmit and use process information. The products are excellent in both performance and price; the services are ground-breaking. Both aid customers' competitiveness with a maximum of quality, safety and efficiency. The power of this global company is intensified by its local support to you. This support starts with excellent manufacturing facilities located within the US. ISO 9001 certified manufacturing facilities and ISO/IEC 17025 accredited calibration systems assure Endress+Hauser delivers highly reliable measuring instruments to customers throughout North and South America.

The company continues to expand its industry know-how, and ensures the competence of Sales and Service. A tight network of production and sales companies, together with representatives, gives Endress+Hauser a very strong presence across global markets.

The company owes its good reputation to employees' competence, creativity and commitment. Endress+Hauser behaves responsibly towards the community and environment, and is commercially successful. The financially strong and independent family company stands for continuity, the broadest range in its industry, and active relationships. Endress+Hauser seeks to be its customers' preferred partner throughout the world.

History

Endress+Hauser was founded by Georg H. Endress and Ludwig Hauser in 1953. It all began as a vision - the use of electronics for the remote measurement of level in containers, tanks and silos, on a reliable and accurate basis.

Endress+Hauser products are manufactured at state of the art Product Centers, using the newest manufacturing techniques available, and continuing to update equipment as technology changes. Each Product Center is responsible for a particular measuring technology; level products are designed and built by one Product Center, while flow measuring products are designed and built by another. This unique philosophy allows research and development to focus on a particular measurement technology. At the same time, the various technologies and best practices are shared among the Product Centers, giving rise to new ideas, designs, and products that are unsurpassed by any other measurement manufacturer.

Level measurement at Endress+Hauser has grown from single-point capacitance switches to continuous level measurement. Enhancing the various needs of industry, frequency shift tuning fork level switches from Endress+Hauser have become the standard for basic level switches. For aggressive materials, ultrasonic and radar measurement systems have been developed to meet all the level measurement requirements in industries where non-contact measuring is needed.

As our growth has continued in the field of level measurement, other fields have been added to achieve world-wide leadership. In 1977, Endress+Hauser met the need for more accurate and dependable liquid flow measuring by introducing a line of electromagnetic flowmeters. As with our level instrumentation, the challenge for more accurate flowmeters and various types of in-line connections was met by Endress+Hauser. From the basic magnetic flowmeter to the microprocessor controlled systems of today, Endress+Hauser meets and exceeds the industry standards. As a company grows, so must its product base. Conductive fluids are just one medium of liquids flow. What about steam, gas, and non-conductive fluids? Once again, Endress+Hauser met the challenge by introducing a specialized vortex flowmeter. For industries that require mass flow and volumetric flow measurement, Endress+Hauser offers the Coriolis mass flow measuring system. This is the ultimate in mass flow technology, using straight through flow tubes, and a secondary containment vessel to ensure process safety.

Our commitment to further provide industry with a full line of measurement systems led our research and development engineers into the pressure field. Using our capacitance knowledge and ceramics, Endress+Hauser overcame the limitations inherent to conventional pressure sensors. We now produce ceramic, capacitive pressure measuring cells coupled with hybrid integrated circuits, capable of withstanding over-pressure loads up to 800 times rated pressure. Our sensors provide long-term stability in aggressive environments with various process connections to fit your industrial applications. Endress+Hauser offers systems to measure processes from vacuum to 10,500 psig, differential pressure systems, and hydrostatic pressure systems.

Industrial requirements continue to rise, and so does the need for accurate recording instruments. Endress+Hauser not only provides traditional recorders for which there is still a need, but also recording devices that plot continuous colored traces, print data, record process events, and notify alarm status. Our commitment to perfection allows all that information to be provided simultaneously in stand-alone monitoring units or integrated into your process control system.

Endress+Hauser is committed to the industries we serve. We develop, manufacture and sell sensors, transmitters and systems, which extract information from manufacturing procedures in the processing industry and prepare it for use by process control systems. The physical variables include level, pressure, flow, analytical and temperature, as well as industrial components. Our goal is to continue our commitment to new products and services for our valued customers.

A network of skilled sales and service personnel are located worldwide, ready to provide the customer support required. Local sales and service locations assure there is someone available, in your time zone, to support you with knowledgeable technicians, spare parts inventory and calibration facilities.



Level measurement and control can be found in almost all types of industries; from the food and pharmaceutical industries where hygiene is of paramount importance, to the chemical, oil, gas and petrochemical industries which require robust and reliable instrumentation to suit the hazardous conditions.

Endress+Hauser offers a complete range of sensors and transmitters for virtually all aspects of level measurement. Our experience in all areas of process measurement has led to the development of a product offering that can withstand the most challenging process conditions. Their reliability can be counted on in corrosive and abrasive environments, sanitary applications and general process industries.

Level products

Stable level measurement, a lower total cost of ownership, reduction of inventory loss at the measuring point – areas that you the customer look for in order to lower production cost and provide the highest quality product. Endress+Hauser's dedication to research and development coupled with leading edge technology ensures each instrument manufactured meets the needs of our customers' applications.

By employing specific measurement technologies, Endress+Hauser level products provide measurement solutions in:

- **Vibration:** Level limit switch for use in liquids or solids, using a tuning fork or rod. A piezoelectric drive vibrates the assembly to its resonant frequency which changes state when material is present.
- **Mechanical:** Economical paddle limit switch for applications in dust hazardous areas. Ideal for high or low level indication in powders, granulates, animal feed, cement, etc. When material comes in contact with the paddle, rotation is stopped and a switch point takes place.
- **Capacitance:** Point level or continuous level in liquids or solids for non-conductive materials, based on the dielectric constant of the material.
- **Conductivity:** Level limit switch for multiple point detection in conductive liquids using single or multiple (up to 5) rods or cables.
- **Radar:** Radar level measurement is designed for challenging applications requiring non-contact, continuous measurement. Radar level instruments are ideal for dynamic process applications with rapid level changes or agitator blades involving liquids and slurries. Endress+Hauser uses the pulse time-of-flight principle, where short pulses are emitted towards the material from an antenna. Our newest radar instrument, Levelflex, launches an electrical impulse down a cable or probe to the material surface.
- **Ultrasonics:** Ultrasonic continuous level measurement involves no contact with the measured material, making it ideal for applications in hostile environments. Ultrasonic measurement is versatile and commonly used for continuous non-contact measurement of liquids, slurries and solids. A tank with an ultrasonic system can be emptied and then filled with a different material and the level reading will still be accurate.
- **Radiometric:** Level measurement using gamma radiation for difficult applications, such as high temperatures, high pressures, corrosive materials, toxic chemicals, etc. where non-contact measurement is required. Radiometric measurement from Endress+Hauser provides level limit detection, continuous level, interface measurement and density or concentration.
- **Hydrostatic/differential pressure:** (refer to Pressure)

Basic Level Measurement Technologies

Vibration (liquids) Point level detection using a vibrating fork or. When activated by a bimorph piezoelectric drive electronics, the forks vibrate at their resonant frequency. When material covers the forks, the frequency changes. This change in frequency is monitored, and at an appropriate change in frequency, the switching logic is activated. This technology is used in liquids, slurries, and oils for high level or low level limit control and pump control.

Changes in the amplitude of the tuning fork vibrations are not measured and can be ignored. This provides protection against buildup, gas bubbles and turbulence. Materials with varying density, viscosity, foam, suspended particles and composition changes do not affect the switch point of the tuning fork.

Vibration (solids) The vibrating rod point level switch is used in bulk solids such as animal feed, rice, dye powders, cement, and is available for use in dust incensive hazardous areas.

A piezoelectric drive excites the vibrating rod, the rod's vibrating amplitude changes (the vibration is damped). The electronics compare the actual amplitude with a target value and indicate whether the rod is vibrating freely or covered with the process material.

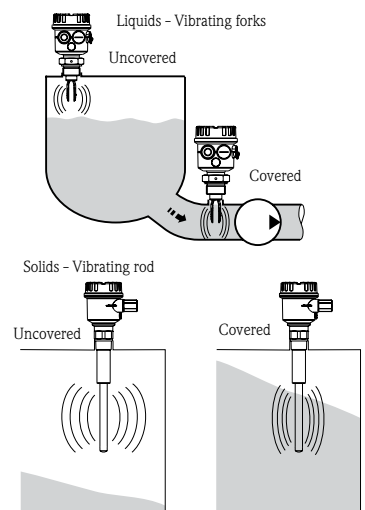

Mechanical A reduction gear and synchronous motor drive the shaft and paddle. If the paddle is stopped by material covering it, the hinged motor moves from the rest position to the switch position. This movement operates two switch contacts – the first is for external level indication and the second switches the power off to the motor. When the material falls away from the paddle, the hinged motor returns to its rest position, the two contacts switch to normal operation, and the paddle starts to rotate. Intermittent loads that operate against or even in the same direction of rotation are evened out by using a slip clutch.

Capacitance Capacitance level measurement systems take advantage of the dielectric constant in all materials to determine changes in level.

A capacitor is no more than a pair of conductive electrodes, or plates, with fixed spacing and a dielectric (process material) between them. In the most common applications, the probe element (a metal rod or cable) serves as the active plate, while the process vessel serves as a ground plate. When “empty space” or air in the vessel is replaced by the process material, the capacitance electronics register the change in capacitance. This change is converted to an electrical signal and used to provide an output from a point or continuous level. Level switches and continuous level measurements can be accomplished with the right probe configuration and electronics.

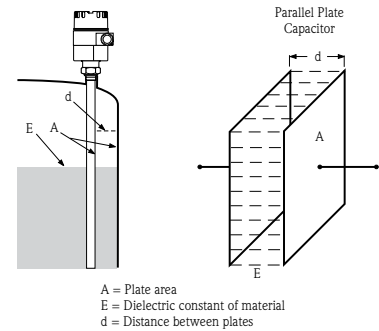

Conductivity An alternating voltage exists between the rod probes in an empty tank. As soon as the conductive liquid in a tank creates a connection between the ground probe rod and, for example, the maximum probe rod, a measurable current flows and the instrument switches. With level limit detection, the instrument switches back as soon as the liquid clears the maximum probe. With two-point control, the Liquipoint does not switch back until the maximum and minimum probe is cleared.

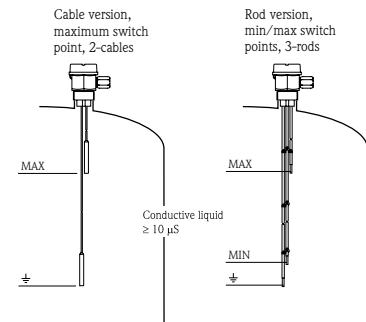

Using alternating voltage prevents corrosion of the probe rods and electrolytic destruction of the product. The material used for the tank walls is not important for measurement because the system is designed as a closed potential-free circuit between the probes and the electronics. There is absolutely no danger from electrical shock if the probes are touched during operation.

Radar, free-space for liquids and solids Endress+Hauser free space radar is used for continuous, non-contact level measurement of liquids, pastes, slurries and solids. The measurement is not affected by changing media, temperature changes, gas blankets or vapors. The free space radar offers maximum reliability due to improved algorithms, small beam angles and uses Heartbeat Technology® for diagnostics. Endress+Hauser offers a wide selection of sending frequencies, 6Ghz & 26Ghz, using pulse technology and 80Ghz using FMCW technology. Communications have been updated to include Bluetooth® for configuration and diagnostic evaluation.

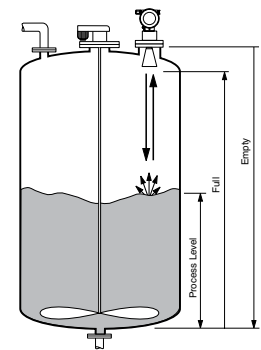

Radar systems from Endress+Hauser are suitable in areas of high temperature or pressure, in the presence of gas vapors, vacuum, turbulence, or dust.

Guided radar Levelflex is a “downward-looking” time-of-flight system, which measures the distance from the probe mounting (top of the tank) to the material level. An electrical impulse is launched and guided down the probe or cable, which acts as a surface wave transmission line. When the surface wave meets a discontinuity in the surrounding medium (a sudden change in dielectric constant), it is partially reflected. The reflected impulse travels back up the cable to the pulse sampler where it is detected and timed.

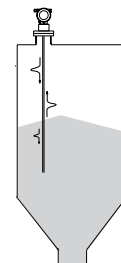

Radar systems from Endress+Hauser operate in a frequency band assigned for industrial, scientific and medical applications. Its low beam power allows safe installation in metallic and nonmetallic vessels, with no risk to humans or the environment. This technology does not require an FCC site license and can be used without restrictions.



Ultrasonic level measurement In ultrasonic level measurement the operating principle is based on the measurement of the travel time of a sound signal transmitted from and received by the same sensor after reflection from the liquid or solids surface. The travel time of a sound pulse is a direct measure of the height of the material in a silo or tank. The distance in air traveled by the pulse in feet is equal to the travel time in seconds multiplied by the speed of sound in feet per second. Signal process techniques, including temperature compensation and rejection of false echoes returned by tank obstructions, are used to maintain the integrity of the level information.

Ultrasonic systems will not work in vacuums.

Gamma In gamma measurement, a radiation source (^{137}Cs or ^{60}Co) is emitted in one direction through the process vessel or pipe and received by the transmitter. The radiation source is enclosed in a shielded container which allows the radiation to be emitted in only one direction and shields the radiation in any other direction. The Gammapiilot M transmitter contains a scintillator, a photomultiplier and the evaluation circuit. Gamma radiation generates light flashes within the scintillator. The photomultiplier converts these flashes into electrical pulses and amplifies them. The pulse rate is a measure of the radiation intensity. Depending on the calibration, the pulse rate is converted to a level, limit, density or concentration signal by the evaluation circuit.

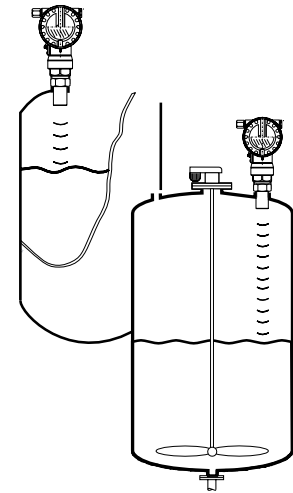

- 1 Point level measurement
- 2 Continuous level measurement
- 3 Interface measurement
- 4 Density or concentration measurement

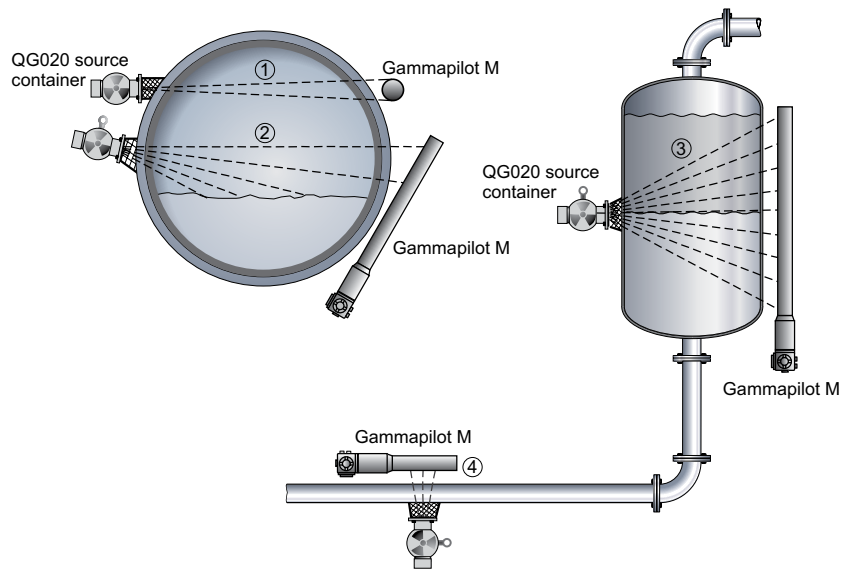

Flow measurement and control can be found in almost all types of industries; from the food and pharmaceutical industries where hygiene is of paramount importance, to the chemical, oil, gas and petrochemical industries which require robust and reliable instrumentation to suit the hazardous conditions.

Endress+Hauser offers a complete range of sensors and transmitters for virtually all aspects of flow measurement. Our experience in all areas of process measurement has led to the development of a product offering that can withstand the most challenging process conditions. Their reliability can be counted on in corrosive and abrasive environments, sanitary applications and general process industries.

Flow products Stable flow measurement, a lower total cost of ownership, reduction of pressure loss at the measuring point - areas that you the customer look for in order to lower production cost and provide the highest quality product. Endress+Hauser's dedication to reasearch and development coupled with leading edge technology ensures each instrutment manufactured meets the needs of our customers' applications.

By employing specific measurement technologies, Endress+Hauser flow products provide measurement solutions in:

- **Electromagnetic:** Proline Promag electromagnetic flowmeter versions are designed to meet the requirements of various industries, ranging from sanitary requirements meeting 3A and EHEDG standards, as well as for use in hazardous areas. Promag sensors are available in sizes from 1/12" to 90", and are suited for water, wastewater, chemical, food, beverage, pharmaceutical and process applications.
- **Coriolis:** Proline Promass Coriolis flowmeters are designed to measure mass flow, volume flow, density, and temperature. The single full-bore Promass I sensor is capable of integral viscosity measurement. Promass sensors are available in sizes from 1/24" up to 16" with dual bent tubes, single bent tube, and single straight tube designs plus rigid secondary containment providing a second line of defense and increased process safety. Promass systems meet the requirements of various industries, ranging from 3A sanitary requirements and EHEDG standards, SIL 2 requirements, and use in hazardous areas. A high temperature sensor (Promass F, up to 660 °F) is available for special applications.
- **Ultrasonic:** Proline Prosonic ultrasonic flowmeters are designed for non-contact flow measurement in difficult applications such as glass reinforced pipe, ductile iron pipe with cement lining or steel pipes with plastic liners. Prosonic flow sensors are available for nominal pipe sizes from 1/2" up to 160". Clamp-on sensors are constructed of stainless steel and rated NEMA 6P and can be completely submerged. Insertion sensors are also available, which once installed, can be replaced without interrupting the process. Prosonic systems are designed for use in water, wastewater, chemical and process industries. A special ultrasonic flowmeter (Prosonic B 200) has been designed specifically for wet biogas applications. Not only can it measure flow, it can also measure temperature and methane content which can be converted directly to available energy (BTU or kJ) in the stream.
- **Thermal:** Proline t-mass thermal mass flow measuring systems are designed for direct mass flow measurement of gases. Two types of sensors are available: in-line flanged for pipes sizes from 1/2" to 4", or insertion sensors for pipe sizes from 3" to 60". Insertion version can be programmed for circular or rectangular ducting installation. On-board software allows the selection of up to 20 pure gases and the creation of mixed gases with a maximum of 8 components (e.g. Biogas)
- **Vortex:** Proline Prowirl vortex flowmeters provide accurate and reliable measurement of flow and temperature for computing mass flow and heat consumption. Ideal for gas, steam and liquids with a process temperature range of -330 °F to +750 °F. With constant pressure, the Prowirl can output the mass flow of superheated steam or the mass and volume flow of other gases. The Prowirl sensor is designed for wafer mounting (1/2" to 6") or ANSI flanged (1/2" to 12") and is ideal for chemical, petrochemical, power and district heating industries and other process applications.
- **Differential Pressure:** Differential pressure flow measurement is based on two well-known technologies; orifice plate and pitot tubes. A primary element (orifice plate or pitot tube) creates a pressure difference inside the pipe, which is a direct measure of volume or mass flow. Differential pressure measurement is ideal for gas, steam and liquids in applications with temperatures from -328 to +1830 °F in pressures up to 6300 psi. Orifice plate systems range in size from 3/8" to 40"; pitot tube systems are ideal in sizes from 1-1/2" up to 472".

Proline Proline stands for a common software electronics structure, an identical operating concept, common servicing concept and even field validation. Each Proline flowmeter is configured in the same manner: quickly and easily guided by simple prompts on the display. Critical data is stored on removable chips allowing for easy exchange of electronics.



Basic Flow Measurement Technologies

Electromagnetic flow measurement Electromagnetic flowmeters measure the volume flow rate of electrically conductive fluids. The measuring sensor consists of a lined pipe, an electromagnetic coil, and corrosion-resistant electrodes (not to all process materials). When the conductive liquid or slurry passes through the magnetic field (produced by the magnetron electronics), it generates a voltage proportional to the average velocity of the material. It is based on Faraday's law of induction: if a conductor moves within a magnetic field, a voltage will be induced therein. Liquid media can be accurately measured with conductivities of $5 \mu\text{S}/\text{cm}$ and above.

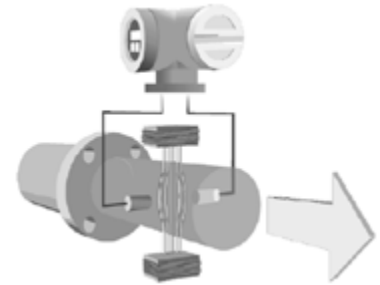

The voltage induced by the flowing fluid is proportional to the flow rate. The measuring electrodes detect the voltage signal which is sent to an amplifier where it is digitized and communicated to the transmitter. The transmitter processes the signals and outputs current and pulse signals which are used for totalizing, pump control, limit values, batch functions, etc.

Coriolis mass flow measurement The measuring principle is based on the controlled generation of Coriolis forces. The sensing meter contains a flow tube(s), which in the absence of flow, the inlet and outlet sections vibrate in phase with each other. When liquid is flowing, inertial (Coriolis) forces cause a phase shift between inlet and outlet sections. Two sensors measure the phase difference, which is directly proportional to flow.

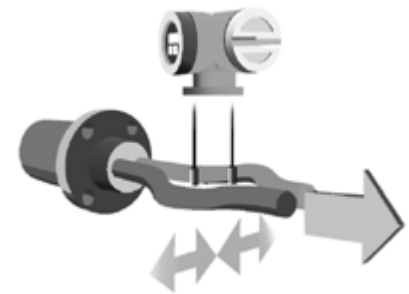

The amplitude of the Coriolis force depends on the moving mass (process material), its velocity in the system, and therefore its mass flow. The flowing material causes the tube(s) to oscillate, acting like a tuning fork. As the mass flow increases, the phase difference also increases. The oscillations of the measuring pipe(s) are determined using electro-dynamic sensors at the inlet and outlet of the measuring tube assembly. The measurement principle operates independent of temperature, pressure, viscosity, conductivity or flow profile.

The Promass I has a full bore, straight-through, single-tube design which operates somewhat differently than the dual-tube design. In order to maintain balance for flawless measurement, a patented Torsion Mode Balanced (TMB) system is used. By exciting an eccentrically located, counter-oscillating pendulum mass, the single tube system provides accurate measurement, even with changing process and ambient conditions.

The Promass measuring system is used wherever mass flow measurement is critical in mixing and batching of raw materials, process control, measurement of quickly changing densities and control of product quality. Coriolis meters can measure mass flow, volumetric flow, density, temperature, and/or viscosity.

Vortex shedding flow measurement The vortex sensor measures flow rate using the Karman Vortex Street principle. As fluid flows past a bluff body, vortices are produced on alternate sides of the body. The frequency at which these vortices are produced (or shed) is directly proportional to the flow rate and is independent of fluid density, viscosity, pressure, or temperature.

The principle function of the flowmeter is threefold: the bluff body disrupts the fluid stream creating vortices, the DSC sensor and front-end electronics detect the shedding vortices and process a pulse signal output signal, the electronics convert the signal to a usable scaled output signal. The DSC (Differential Switched Capacitor) sensor improves the signal-to-noise ratio and eliminates the effects of vibration on the measuring signal.

Vortex pulses acting on the tongue (DSC sensor) mistune the capacitors and this change is detected by the capacitor circuit. The elastic behavior of the carrier rod and tongue are matched by computer design which effectively cancels any pipe vibration acting on the sensor. The carrier rod and tongue move in absolute synchronism regardless of the vibration axis, including rotational vibration. By eliminating any external effects of vibration, only the vortex pulse signals are processed by the electronics.

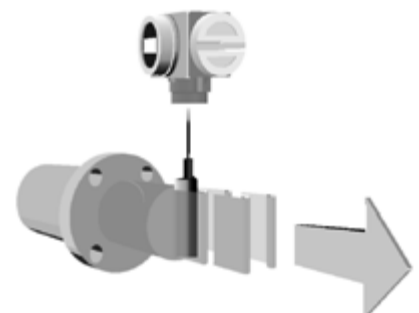

The Prowirl vortex measuring system is ideal for liquids, gases, and steam. Applications for oxygen, nitrogen, cryogenics, and solvents are well within the measuring techniques of the vortex system.



Ultrasonic flow measurement The ultrasonic flow system is a non-intrusive, externally mounted measuring system which uses ultrasonic sound waves to measure the flowing fluid in a pipeline. The Prosonic flow systems operates on the principle of transit time difference. An acoustic signal (ultrasonic) is transmitted from one sensor to another. The time (transit) that the signal requires to arrive at the receiver is then measured. According to physical principles, the signal sent against the direction of flow requires longer to return than the signal in the direction of flow; therefore, the difference in the transit time is directly proportional to the velocity of flow. The transmitter converts the measured values supplied by the sensors into standardized output signals.

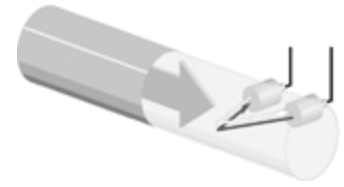

The Prosonic flow sensors (clamp on versions) are mounted directly onto existing piping. Isolating or opening the piping is not required. The system is ideal for bidirectional measurement of pure or slightly dirty liquids. The Prosonic flow system is especially suitable when retrofitting equipment as no interruption of the process is necessary. Endress+Hauser does offer insertion type sensors. Once installed, the sensors can be replaced without interrupting the process.

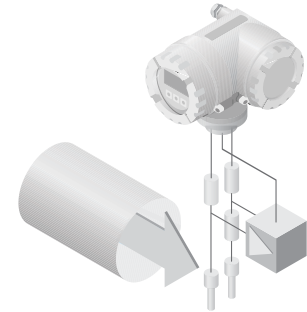

Thermal mass flow measurement The thermal mass flow measuring system is based on a thermal dispersion principle. The thermal principle operates by monitoring the cooling effect of a gas stream as it passes over a heated transducer (PT 100). Gas flowing through the sensing section passes over two PT 100 RTD transducers, one of which is used conventionally as a temperature sensing device, while the other is used as a heater. The temperature sensor monitors the actual process values while the heater is maintained at a constant differential temperature above the actual process temperature by varying the power consumed by the sensor. The greater the mass flow, the greater the cooling effect and power required to maintain the differential temperature. The measured heater power is therefore a measure of the gas mass flowrate.

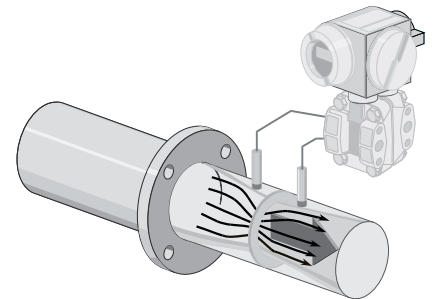

Differential pressure flow measurement Differential pressure flow measurement is based on two well-known technologies; orifice plate and pitot tubes. A primary element (orifice plate or pitot tube) creates a pressure difference inside the pipe, which is a direct measure of volume or mass flow. Two impulse lines carry the differential pressure to the transmitter, where it is converted into the corresponding output signals.

Orifice plates have a circular constriction in the pipe cross-section to create the difference in pressure. Static pressure drops in relation to the associated increase in flow velocity. The difference in pressure upstream and downstream to the orifice is a measure of the flow rate.

Pitot tubes have various pressure-tapping holes to measure total head pressure at the leading end and static pressure only at the trailing end. The corresponding pressure difference is proportional to the flow rate.

Metering in hot-water and cooling systems and metering steam and condensate at very high temperatures in secondary systems remain primary areas of application even today. Pitot tubes are a viable alternative to orifice plates where low pressure losses are required and when flow has to be measured in large diameter pipes (up to several feet). The transmitters in differential-pressure systems can be replaced at any time without the process having to be interrupted.



Pressure

Pressure measurement and control can be found in almost all types of industries; from the food and pharmaceutical industries where hygiene is of paramount importance, to the chemical, oil, gas and petrochemical industries which require robust and reliable instrumentation to suit the hazardous conditions.

Endress+Hauser offers a complete range of sensors and transmitters for virtually all aspects of pressure measurement. Our experience in all areas of process measurement has led to the development of a product offering that can withstand the most challenging process conditions. Their reliability can be counted on in corrosive and abrasive environments, sanitary applications, and even in areas where excessive temperature occurrences threaten operations.

Pressure products Pressure sensors guarantee safety and provide crucial information on the process. Even in level and flow measurement, pressure and differential pressure measuring technology is often used. This makes pressure one of the most important measured variables in process automation, inspiring Endress+Hauser to continuously improve and drive forward the development and production of high-quality pressure measurement. With its extensive portfolio of pressure measuring instruments, Endress+Hauser can offer a pressure transmitter that combines the latest technology with high-grade material for every application and budget.

By employing specific measurement technologies, Endress+Hauser pressure products provide measurement solutions in:

- Gauge pressure
- Absolute pressure
- Differential pressure
- Hydrostatic pressure (level)
- Flow (Differential pressure with Orifice Plate or Pitot Tube)

Pressure Basic Measurement Technologies

Gauge/Absolute pressure measurement Pressure measurement for gauge, absolute, vacuum and compound are based on two technologies; capacitance ceramic sensors (for up to 600 psig) and silicon metallic sensors (for up to 10,500 psig).

Ceramic—The operating principle of the ceramic sensor is based on capacitance technology. As pressure is applied to the ceramic diaphragm, the measuring capacitor deflects by a minimum of less than 0.001 inch. A change in capacitance proportional to pressure is measured between the substrate electrode and the measuring (diaphragm) electrode. The electronics convert this differential capacitance into a usable output signal. The actual measuring range is determined by the thickness of the ceramic diaphragm which, with overload, stops on the substrate without sustaining damage.

Silicon—The silicon sensor incorporates insulated thin film strain gauges. The line pressure deflects the separating diaphragm and the filling fluid transmits the pressure to a resistance bridge. The bridge output voltage, which is proportional to pressure, is then measured and processed.

The silicon sensor offers a wide temperature range, a small and easily compensated temperature coefficient and long-term stability. Its good elasticity properties ensure high reproducibility, low hysteresis and fourfold resistance to overload.

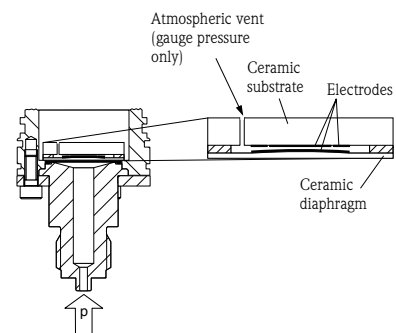

Ceramic measuring cell

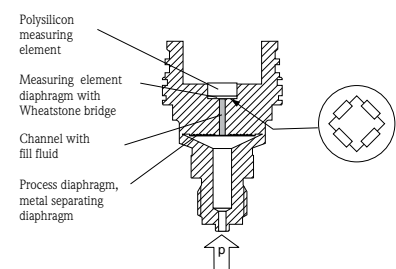

Silicon measuring cell



Differential pressure measurement Differential pressure sensors are available in silicon sensors (for up to 580 psi). The silicon measuring sensor is comprised of a silicon diaphragm which has pressure sensitive thin-film resistors. The differential pressure acting at the isolating diaphragms is transmitted to the measuring element by silicone oil or inert oil. The silicon diaphragm deflects accordingly causing a change in resistance which is measured and processed by the transmitter electronics.

The silicon sensor offers a wide temperature range, a small and easily compensated temperature coefficient and long-term stability. Its good elasticity properties ensure high reproducibility, low hysteresis and fourfold resistance to overload.

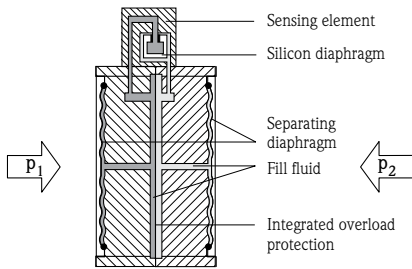

Silicon measuring cell
(4 inH₂O and 12 inH₂O)

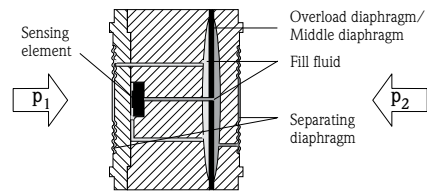

Silicon measuring cell
(40 inH₂O and above)

Hydrostatic pressure measurement Hydrostatic level measurement provides both continuous and limit control of liquids and pastes. Together with an appropriate transmitter, they can be used to determine level, volume, differential pressure, product weight, density and can be integrated into various automation systems.

The weight of a column of liquid generates a hydrostatic pressure. At constant density, the hydrostatic pressure is a function of the height of the liquid only. The atmospheric pressure acts on the measuring cell through a pressure compensation system and thus is self-compensating. An overload substrate protects the measuring cell from pressure peaks to 20 times the nominal rating (maximum 360 psig). This ensures that accuracy remains unaffected. The measuring cells cover a pressure range from 15 inH₂O to 58 psig. Vacuum can be measured to 1.7 psia.

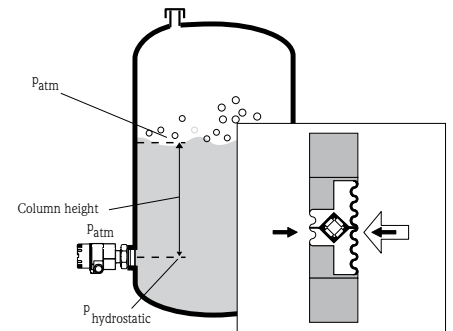

Temperature

Temperature measurement and control can be found in almost all types of industries; from the food and pharmaceutical industries where hygiene is of paramount importance, to the chemical, oil, gas and petrochemical industries which require robust and reliable instrumentation to suit the hazardous conditions.)

Endress+Hauser offers a complete range of sensors and transmitters for virtually all aspects of temperature measurement. Our experience in all areas of process measurement has led to the development of a product offering that can withstand the most challenging process conditions. Their reliability can be counted on in corrosive and abrasive environments, sanitary applications, and even in areas where overpressure or excessive temperature occurrences threaten operations.

Temperature products Endress+Hauser provides a wide range of temperature products, including transmitters and sensors designed to meet the requirements of all industries.

Temperature transmitter family iTEMP® transmitters are an installation-ready solution to improve the functionality of temperature measurement by increasing accuracy and reliability when compared to direct wired sensors. Overall installation costs are lower than with direct wired sensors, since inexpensive two-conductor 4 to 20 mA signal wire can run over long distances – instead of expensive extension or compensation wires for thermocouples.

Each unit can be configured for a variety of sensor inputs: RTD, thermocouple, millivolt or ohm. All iTEMP® transmitters provide long term stability $\leq 0.05\%$ per year. Transmitter types available from Endress+Hauser include:

- Field transmitters
- DIN rail mounted transmitters
- Head transmitters

Temperature sensors Class A Pt100 thermometers are exclusively used in Endress+Hauser sensors. The mechanical variations of sensors, thermowells and housings ensure the highest functionality, even under harsh environmental conditions. Certified and automated welding technologies and the computer controlled calculation and sizing of thermowells to international standards safeguard the practicality of the products. Sensor technologies available include:

- Thermocouple
- RTD

Temperature Basic Measurement Technologies

Of all process variables, temperature is the one with which people have the most personal familiarity. Yet, many of the measurement issues are not clearly understood by the average person. Further, the concepts of temperature and heat are often confused.

Fundamentally, temperature is indicative of the average amount of kinetic energy in a group of molecules. That is, it is a direct indication of the average amount of molecular motion in the studied object. Even the human senses detect temperature changes, and can sense which of two objects has the higher temperature. Yet temperature is not a measure of the amount of heat (or heat energy) contained within an object. An iceberg, although colder than a lit match, contains vastly more heat than a lit match. Heat may be thought of as the sum of all the kinetic energy of all the molecules-in-question. If temperature tells us nothing about the energy contained in an object, what then does temperature tell us?

Our concepts of “colder” and “warmer” are directly related to relative temperatures, and temperature tells us which way heat will flow. When two bodies are in contact, heat (or energy), always moves from a body of higher temperature to a body of lower temperature (except in the case of a “heat pump”). Two simple bodies in contact and left alone, will eventually reach the same temperature.

The expression of a measured value may be in any one of several “temperature scales”, which are describe in units by degrees. The specific unit used is indicated by the “type” of degree stated. All temperature scales seek to create a one-to-one correspondence between the indicated temperature value and a specific level of molecular activity. The most commonly used scales are Celsius (formerly Centigrade) and Fahrenheit. These linear scales have somewhat arbitrary “starting points” for what they consider to be “zero degrees”. In contrast the Kelvin and Rankine scales set zero degrees to correspond to the theoretical “absolute zero” where all molecular motion would cease. These latter scales are a bit more convenient when the goal is to relate a temperature measurement directly to heat content or kinetic energy, since the temperature is directly proportional to both, and requires no offset to the more arbitrary zero points of Celsius and Fahrenheit scales.



What is it, fundamentally, that causes a temperature sensing device (or even your skin) to get a reading of the temperature? At the molecular level, it is the result of the aggregate momentum transferred to the sensing device by all the collisions of moving molecules.

In industrial processes, the measurement of temperature is not only critical for numerous reasons, but it is also the single most common process variable measured.

Although there are several sensor types used to transducer sensed temperature into a measurable and usable electrical signal, the vast majority used are one of two types – the “RTD” (Resistive Temperature Device) or TC (Thermocouple).

Resistive temperature devices capitalize on the fact that the electrical resistance of a material changes as its temperature changes. As their name indicates, RTDs rely on resistance changes in a metal, with the resistance rising more or less linearly with temperature.

When two wires composed of dissimilar metals are joined at both ends and one of the ends is heated, there is a continuous current which flows in the thermoelectric circuit.

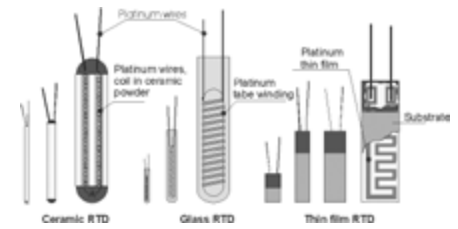

RTD types

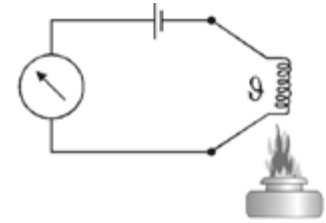

Resistive temperature measurement

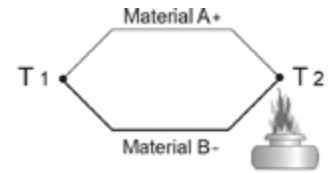

Thermocouple temperature measurement

Data acquisition and system components

Our recorders and components are designed for simple installation and are user friendly. We also pride ourselves on protecting both resources and environment. Easy to read graphic displays combined with power failure secure storage and manipulation monitored measured data archiving guarantees safe traceability of process sequences in all industrial areas. We develop sensors, transmitters and systems that reliably record, transmit and process critical plant information to optimize your process control.

Endress+Hauser offers recorders from simple data collection and display to multi-channel, multi-instrument monitoring and process control. System components are necessary in order ensure that measurements such as energy supply and sensor monitoring comply with international industrial standards and regulations. Our range of system components not only cover these basic requirements, but also increase plant availability via integrated diagnostic functions. They also optimize process by direct front-end control or manage energy usage with tested calculation methods.

The range of system components offered:

- Process displays for both field and panel mounting
- Active barriers and power supplies
- Process transmitters
- Energy managers
- Surge arresters



Water, the most abundant substance on earth is used throughout the industrial world as a critical substance in the manufacturing processes. From the Chemical, Oil, and Gas Industries to the Automotive industry, within the Pulp and Paper Industry to the precise manufacturing environment of a Semiconductor plant, water is there, providing the medium in which many products are made, modified, and/or cleaned.

The purity of our drinking water has increasingly become a matter of public concern. Most drinking water supplies today require special treatment before it can be distributed and utilized. This is to eliminate possible toxic and infectious contaminants and make it safer for human consumption.

Endress+Hauser offers a full line of analytical systems important to different interests and industries. Examples of available technologies and industries include:

pH	Environmental
Oxidation/Reduction (ORP)	Corrosion
Conductivity	Scaling
Chlorine	Disinfecting
Dissolved Oxygen	Power, feed water
Turbidity	Dissolved solids
Optical	Fermentation, emulsions, effluent
Chemical Analysis	Water/Wastewater

Analytical products By employing specific measurement technologies, Endress+Hauser analytical products provide measurement solutions in:

- **pH:** pH is the measurement of hydrogen ion activity. It is measured on a scale of 0 to 14, where zero is extremely acid and 14 is extremely alkaline. The mid point of 7.0 pH is distilled water. It is the most widely used liquid analysis measurement and is found in all industries. Used to determine the degree of acidity or alkalinity of a sample, pH measurement is a number that is directly related to a ratio of H^+ (hydrogen ion) and OH^- (hydroxyl ion) concentrations in a solution.

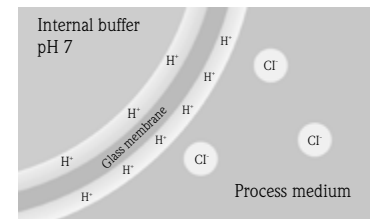

Voltage occurrence with pH measurement with glass electrodes

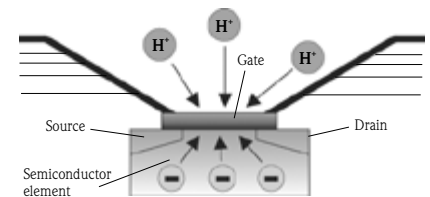

The current between the source and drain of the semiconductor element depends on the charge at the gate and thus directly on the pH value.

Endress +Hauser offers two groups of pH electrodes. CPF compact electrodes (non-glass) which are inserted directly into the process, or CPS glass electrodes which are placed in a separate holder.

pH glass electrodes: The method of pH measurement using glass electrodes is a potentiometric measurement method. Since glass is basically an electric insulator, amplifiers for the pH measurement must have an extremely high input impedance. The measuring effect is based on a pH-sensitive glass membrane, whose surface reacts to the acid content of the solution with a specific voltage. This voltage is then measured relative to a reference element. Most modern pH glass electrodes display high selectivity (low cross-sensitivity to ions other than H^+) over a wide temperature range. A pH sensor achieves the outstanding performance of linear measurement of a material component over a concentration range of 14 (!) exponents.

pH non-glass electrodes: Apart from using a glass membrane, the pH value can also be measured using an ion-selective field-effect transistor (ISFET). It is, in effect, a simple transistor with a source and drain that are separated from the gate by means of an isolator. As with the glass membrane, hydrogen ions from the medium can accumulate on the gate. The resulting positive charge on the outer side of the gate is “mirrored” on the inner side where a negative charge occurs. This makes the semiconductor channel conductive. The “field effect” results from the extent of the conductivity: the higher the pH value of the liquid, the more H^+ ions accumulate on the gate and the more current can measurably flow between the source and drain. In contrast to the glass electrode, there is no ion flow between the fluid and the sensor. “Chemistry” and electrical measurement are kept totally separate. As a result, the sensor material does not change and the need for re-calibration is by no means as frequent as with glass electrodes. Since there is no source layer, ISFETs are also suitable for pH measurement in media with a low proportion of water. Modern ISFET materials are highly selective and follow the Nernst law in closer tolerance limits than glass. The sensor’s extreme robustness comes from embedding the chip in a stable and unbreakable PEEK™ body.



- **ORP:** ORP (Oxidation-reduction Potential) measurements are used to monitor chemical reactions, quantify electron activity or determine the oxidizing or reducing properties of solutions. ORP is related to pH in that it utilizes a similar measuring system, and delivers millivolts, as does pH. ORP is a specialized measurement that can follow the progress of a chemical reaction that involves the loss and gain of electrons (Oxidation or Reduction) between species in solution. ORP only measures in millivolts, whereas pH measurements are related to a scale. ORP electrodes are the same type as pH.
- **Conductivity:** Conductivity is a common measuring technique. The range of conductivity is wide, from the purest water to the high conductivity of acid and alkali concentrations. Conductivity is a straightforward and reliable way to determine the purity of water, or the concentration of an acid or alkali. The principle of conductivity measurement for analysis is defined as the ability of a solution to conduct an electrical current between two electrodes. In a solution, the current flows by ion transport. Therefore, the higher the ion concentration, the more current flow. Chemical compounds which produce conducting solutions are called electrolytes.

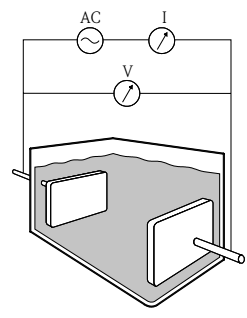

Endress+Hauser offers two basic types of sensors for conductivity measurement. The contacting (conductive) sensor and the electrode less (inductive) sensor.

Conductive sensor: The conductivity of liquids is measured with a measuring system that has two coaxially arranged electrodes like a capacitor. The electric resistance or its reciprocal value, the conductance G , is measured according to Ohm's law. The specific conductivity K is determined using the cell constant k that is dependent on the sensor geometry.

Inductive sensor: In inductive conductivity measurement, a transmitting coil generates a magnetic alternating field that induces an electric voltage in a liquid. The ions present in the liquid enable a current flow which increases with increasing ion concentrations. The current in the liquid generates a magnetic alternating field in the receiving coil. The resulting current in the receiving coil is measured and used to determine the conductivity value. The conductivity serves as a measure of ion concentration.

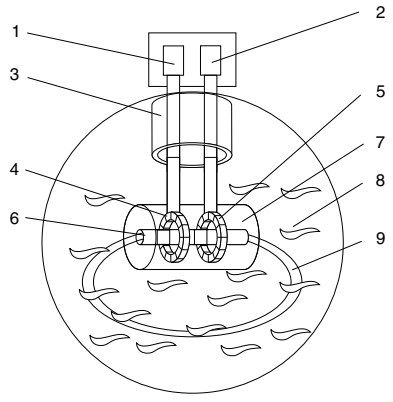

- 1 Oscillator
- 2 Receiver and signal processing
- 3 Cable
- 4 Primary winding
- 5 Secondary winding
- 6 Bore
- 7 Sensor housing
- 8 Process medium
- 9 Induced electric current

- **Chlorine:** Chlorine is used not only in your home to clean and disinfect, but is widely used throughout industry, especially in water/wastewater treatment. Chlorine is a building block for nearly all chemical processes. It plays a vital role in the health of the population and in maintaining a clean and safe environment. As a common last step of water treatment, chlorination takes place, not only to destroy remaining bacteria but also to prevent the growth in the water pipe system which delivers clean water to households and industrial locations.

Chlorine sensors from Endress+Hauser are membrane-capped amperometric sensors. The membrane only allows hypochlorous acid molecules to diffuse through the membrane to react at the electrodes. Detected hypochlorous acid is a proportion of the active chlorine, which acts as a depolarizer at the cathode after diffusion by the membrane.

Total chlorine: Total chlorine is a weaker disinfectant than free chlorine, but lasts much longer. It is normally used in pipe lines, or in areas where it is too costly to maintain a free chlorine level. Total chlorine is the sum of total free chlorine and bound chlorine. Bound chlorine (chloramines) is not measured; its share can be determined numerically by subtracting free chlorine from total chlorine. Bound chlorine is no longer active and has no disinfectant effects. Forms of chlorine that have a disinfecting effect are: elemental chlorine Cl_2 , hypochlorous acid $HOCl$, hypochlorite ions OCl^- , and combinations thereof.

Free chlorine: The free chlorine form is the type that disinfects most effectively, but does not last as long. Sunlight, temperature fluctuations, pH changes and rain weaken the effects, especially in swimming pools or areas exposed to the environment. Hypochlorous acid $HOCl$ proportion depends on the pH value. As pH value increases ($> pH 6$), $HOCl$ dissociates into hypochlorite ions OCl^- and hydrogen ions H^+ . Only OCl^- is left at approximately 9.5 pH, where the disinfectant effect is extremely low. Normally, free chlorine is measured along with pH to maintain the most effective disinfecting properties.

- **Dissolved Oxygen:** Oxygen is one of the basics of life, and is especially important in wastewater treatment. The level of dissolved oxygen determines the life span of micro-organisms in activated sludge basins which break down solids material.



The measurement of dissolved oxygen is also important in lakes, streams, and fish farming, to ensure healthy growth for the food industry. Pharmaceuticals and biotechnology also benefit from the use of measuring oxygen levels in controlled environments for micro-organism growth.

Dissolved oxygen (DO) is the term commonly used in liquid analytical work for the measurement of the amount of oxygen dissolved in a unit volume of water. It is an important indicator of the degree of usefulness of a sample of water for a specific application. The process requirements of a given application determine the level of dissolved oxygen that can be tolerated. The primary application for parts-per-million (ppm) dissolved oxygen systems is measurement and control in aeration basins used in aerobic digesters in wastewater treatment plants. Correct levels of oxygen must be maintained to nourish the bacteria that are used to digest the waste. Endress+Hauser offers a single sensor style for measuring dissolved oxygen. The membrane covered sensor provides a sealed system which measures the oxygen molecules transferred through a gas permeable membrane to the electrodes.

- **Turbidity:** Turbidity is the process of measuring solids content or suspended solids in wastewater, where large amounts of sludge must be handled. Sludge has to be removed in the primary clarifier, recirculated as activated sludge in the biology and separated from the treated water in the secondary clarifier. Most countries have very strict regulations regarding the maximum load of sludge particles in the effluent of the treatment plant. Getting rid of the sludge separated from the water is an important cost factor and will become more costly in the near future.

In order to ensure efficient water treatment, the primary sludge has to be removed. The task is to control a pump or slide valve. Most essential is to make sure that the sludge concentration is at least 1.5 to 2% DS (dry solids). A lower concentration will create tremendous costs in later stages of sludge treatment (e.g. sludge conditioning and de-watering). Endress+Hauser incorporates optical technology which is most suitable for measuring the solids concentration in the sludge pipeline, and can be used easily to switch off the pump at too low concentrations. The 90° scattered light method with a measuring frequency in the near-infrared range of light (880 nm) guarantees a measurement of turbidity value under standardized, comparable conditions. The excitation radiation of an infrared transmitter strikes the medium at a defined beam angle. The different refractive indices of the entrance window and the measuring medium (water) are taken into account. Particles in the medium generate a scattered radiation which strikes the scattered light receiver at a defined angle. The measurement in the medium is constantly adjusted with the values of a reference receiver. For sludge level measurement in the primary clarifier, Endress+Hauser offers ultrasonic systems which provide non-contact continuous measurement.

- **Chemical Analysis:** The reduction and elimination of certain chemicals during the treatment process ensures that clean water is introduced into rivers and lakes from wastewater treatment facilities. CA80 & CA71 Liquid Analyzers from Endress+Hauser are compact, self-contained sampler and analyzer systems which are designed for specific chemicals, such as ammonium, nitrate, phosphate, etc. The measurement is accomplished using photometric technology. A sample is drawn into the analyzer and conditioned. The analyzer sample pump conveys a part of the filtrate to a mixing vessel where a reagent pump adds reagent at a specific ratio. As a result of the reaction, the sample turns a characteristic color. The photometer determines the sample absorption of an emitted light at a specific wavelength. The wavelength is parameter specific. The absorption intensity is proportional to the concentration of the specified parameter in the sample. Additionally, the absorption of a reference light is determined to receive a genuine measuring result. The reference signal is subtracted from the measuring signal to prevent any effects due to turbidity, contamination and ageing of the LEDs. The temperature in the photometer is controlled thermostatically so that the reaction is reproducible and takes place within a short period of time.
- **Advanced Analysis:** Endress+Hauser recently acquired SpectraSensors in 2012 and Kaiser Optical Systems in 2013 to add to their rapidly expanding gas analyzer portfolio. Endress+Hauser now offers TDL and Raman spectroscopy analyzers into the downstream oil & gas markets domestically. Endress+Hauser currently provides gas analysis solutions for LNG, petrochemicals, syngas, refining, and gas processing applications.
- **Tunable Diode Laser Technology:** SpectraSensors analyzers utilize a laser absorption spectroscopy technique to detect and measure the concentration of analyte molecules (H_2O , H_2S , CO_2 , NH_3 , and C_2H_2 , C_2H_4) in process gas streams. This basic technique has been applied to gas measurements since the invention of the laser over 50 years ago. Recent advances in semiconductor lasers have made the development of tunable diode laser analyzers for process gas monitoring applications technologically and economically viable.

SpectraSensors pioneered the use of tunable diode lasers to design analyzers for on-line, real-time measurement of H_2O , H_2S , CO_2 , NH_3 , C_2H_2 , and C_2H_4 in process gas streams. Our expertise in this field is underscored by our extensive portfolio of patents.

The basic design of a TDL analyzer is depicted in the diagram below. The principal components of the analyzer are; an optical head housing the laser with thermo-electric cooler and a solid state detector, the sample cell with a mirror positioned at the end opposite the laser, gas inlet and outlet connections, and temperature and pressure sensors.



A window isolates the laser source and solid state detector components from the process gas inside the sample cell. This design allows measurements to be performed with absolutely no contact between the process gas sample (and any entrained contaminants) and critical analyzer components.

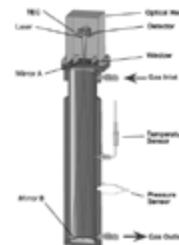

In operation, process gas from a sampling probe is introduced into the sample cell of the analyzer. A tunable diode laser emits a wavelength of near-infrared (NIR) light specific for the target analyte into the sample cell where it passes through the gas and is reflected back by a mirror at the opposite end of the cell to a solid state detector. Analyte molecules present in the gas sample absorb and reduce the intensity of laser light energy in direct proportion to their concentration according to the Lambert-Beer law. The difference in light intensity is measured by the solid state detector and this signal is processed using advanced algorithms to calculate analyte concentration in the process gas.

The path length of the sample cell can be increased to create a multi-pass Herriott cell in which laser light traverses the cell multiple times to increase analyzer sensitivity for trace (sub-ppm) level measurements.

- **Quenched Fluorescence Technology:** Blue LED light is transmitted to the sensor tip causing it to emit “fluorescence”.

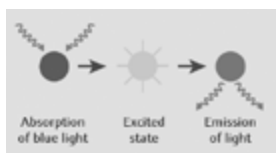

When the sensor tip comes into contact with oxygen, the O₂ molecules absorb energy, preventing the emission.

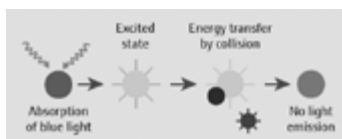

The amount of oxygen is inversely proportional to the intensity and duration of the luminescence.

SpectraSensors OXY5500 Oxygen Analyzer is a compact, stand-alone one-channel meter with an LCD display and built-in data logger. The sensor probe is inserted into the process stream and is connected to the controller by an optical fiber. The analyzer uses an optical method that detects oxygen using a probe that is inserted into the gas stream. The probe can be easily cleaned and has a lifetime measured in years. Calibration of the analyzer is a simple procedure that can be performed in minutes using a binary standard with oxygen in nitrogen. OXY5500 technology is ideally suited for measuring in Natural Gas and Gas Processing applications. The sensor is not affected by even high levels of H₂S or other sulfur species. There is no cross sensitivity to contaminants or other gases in natural gas. The electronics are certified for hazardous area use. Because there is no measurement drift, the accuracy and reliability of the measurements are superior to electrochemical analyzers.

- **Raman Spectroscopy:** When light is scattered from a molecule most photons are elastically scattered. The scattered photons have the same energy (frequency) and therefore, wavelength as the incident photons. However, a small fraction of light (approximately 1 in 10⁷ photons) is scattered at optical frequencies different from, and usually lower than, the frequency of the incident photons. The process leading to this inelastic scatter is termed the Raman effect. Raman scattering can occur with a change in vibrational, rotational or electronic energy of a molecule. Chemists are concerned primarily with the vibrational Raman effect and thus in this tutorial we use the term Raman effect to mean vibrational Raman effect only.

The difference in energy between the incident photon and the Raman scattered photon is equal to the energy of a vibration of the scattering molecule. A plot of intensity of scattered light versus energy difference is a Raman spectrum.

Raman spectroscopy is useful for chemical analysis for several reasons:

- **Specificity:** Because Raman detects fundamental vibrations, Raman bands have a good signal-to-noise ratio and are non-overlapping. This allows a Raman spectrum to be used for everything from “fingerprinting” of samples to constructing complex chemical models of reaction processes.

Analysis of aqueous systems: The IR spectrum of water is strong and relatively complex, making IR inadequate for analysis of aqueous solutions due to heavy interference by the water bands. However, the Raman spectrum of water is weak and unobtrusive, allowing good spectra to be acquired of species in aqueous solution.



Analysis of organic and inorganic chemistries: If a covalent chemical bond exists between chemical species then a unique Raman signature may be produced.

Wide Concentration Range: The measured intensity of a Raman species is directly proportional to the concentration. This allows a Raman analysis to measure a species concentration from a fraction of 1% to 100% without sample dilution.

No Sample Preparation: Unlike most other chemical analysis techniques, Raman requires no special preparation of the sample. In fact, no contact with the sample is needed at all because Raman involves only illuminating a sample with a laser and collecting the scattered photons.

Non-destructive Analysis: Because Raman involves only illuminating a sample, often through a window, with a laser and collecting the scattered photons this makes Raman spectroscopy non-destructive.

Compatible with Common Windows: Can utilize standard sampling containers and windows manufactured of glass, sapphire, transparent polymers, and diamond to measure samples in situ.





Quantitative Raman: Because the intensity of a Raman band is directly proportional to the number of molecules giving rise to the band, then the Raman band can be used to provide a measure of the concentration of a molecule.

Short Measurement Times: A Raman spectrum can, typically, be acquired on a timescale from a fraction of a seconds to several minutes, thus Raman can be used to monitor chemical reactions in "real time."



The Optograf™ is an industry leading turn-key laser-based analyzer that provides quantitative chemical composition measurements using Raman spectroscopy. The design of the Optograf Gas Analyzer incorporates customer requirements for serviceability and hazard-area certification, as well as a compact footprint and minimal utilities consumption.





Vibration



Liquiphant® M					
	FTL41 	FTL51B 	FTL50H (compact, hygienic/sanitary) 	FTL51H (hygienic/sanitary, extended) 	FTL51C (coated extended) 
Application	Liquids	Liquids	Liquids, hygienic	Liquids, hygienic	Liquids, corrosive
Measurement type	Point Level, liquids	Point Level, liquids	Point level, liquids	Point level, liquids	Point level, liquids
Sensor	Frequency shift tuning fork	Frequency shift tuning fork	Frequency shift tuning fork, compact version	Frequency shift tuning fork, extended forks to 115"	Frequency shift tuning fork, compact and extended forks to 115" (to 48" for enamel coating)
Output	FEL42, 3-wire PNP FEL44, relay DPDT FEL48, 2-wire NAMUR	FEL61: AC, load switched via thyristor FEL62: DC-PNP FEL64: DPDT relay FEL68: H-L edge NAMUR with test button FEL67: PFM for separate switching unit FEL60D: Density (with FML621 density computer)	FEL51: AC, load switched via thyristor FEL52: DC-PNP FEL54: DPDT relay FEL55: 8 to 16 mA FEL56: L-H edge NAMUR FEL58: H-L edge NAMUR with test button FEL57: PFM for separate switching unit FEL50A: Profibus PA FEL50D: Density (with FML621 density computer)	FEL51: AC, load switched via thyristor FEL52: DC-PNP FEL54: DPDT relay FEL55: 8 to 16 mA FEL56: L-H edge NAMUR FEL58: H-L edge NAMUR with test button FEL57: PFM for separate switching unit FEL50A: Profibus PA FEL50D: Density (with FML621 density computer)	FEL51: AC, load switched via thyristor FEL52: DC-PNP FEL54: DPDT relay FEL55: 8 to 16 mA FEL56: L-H edge NAMUR FEL58: H-L edge NAMUR with test button FEL57: PFM for separate switching unit FEL50A: Profibus PA FEL50D: Density (with FML621 density computer)
Power supply	FEL42, 10-55 VDC FEL44, relay 19-253 VAC/19-55 VDC FEL48, 2-wire NAMUR	FEL61: 19 to 253 VAC FEL62: 10 to 55 VDC (PNP) FEL64: 19 to 253 VAC, 19 to 55 VDC (relay) or 9-20VDC FEL67,68: NAMUR and PFM, requires separate power supply (e.g. FTL 325N / 325P) FEL60D: powered by FML621 density computer	FEL51: 19 to 253 VAC FEL52: 10 to 55 VDC (PNP) FEL54: 19 to 253 VAC, 19 to 55 VDC (relay) FEL55: 11 to 36 VDC (current) FEL56, 58, 57: NAMUR and PFM, requires separate power supply (e.g. FTL 325N / 325P) FEL50A: 9 to 32 VDC from bus- FEL50D: powered by FML621 density computer	FEL51: 19 to 253 VAC FEL52: 10 to 55 VDC (PNP) FEL54: 19 to 253 VAC, 19 to 55 VDC (relay) FEL55: 11 to 36 VDC (current) FEL56, 58, 57: NAMUR and PFM, requires separate power supply (e.g. FTL 325N / 325P) FEL50A: 9 to 32 VDC from bus- FEL50D: powered by FML621 density computer	FEL51: 19 to 253 VAC FEL52: 10 to 55 VDC (PNP) FEL54: 19 to 253 VAC, 19 to 55 VDC (relay) FEL55: 11 to 36 VDC (current) FEL56, 58, 57: NAMUR and PFM, requires separate power supply (e.g. FTL 325N / 325P) FEL50A: 9 to 32 VDC from bus- FEL50D: powered by FML621 density computer
Ambient temperature	-58 to +158°F	-58 to +158°F	-58 to +158°F	-58 to +158°F	-60 to +158°F
Process temperature	-50 to +150 °C (-58 to +302 °F)	-50 to +150 °C (-58 to +302 °F)	-58 to +302°F	-58 to +302°F	-58 to +450°F
Process pressure	-1 to +40bar (-14.5 to +580psi)	-1 to +100bar (-14.5 to +1450psi)	Maximum 928 psi, threaded connections Flanges: pressure depends on flange selected and process temperature Maximum 230 psi, Tri-Clamp Maximum 145 psi, Varivent® Maximum 600 psi, 1" welded neck	Maximum 928 psi, threaded connections Flanges: pressure depends on flange selected and process temperature Maximum 230 psi, Tri-Clamp Maximum 145 psi, Varivent Maximum 600 psi, 1" welded neck	ECTFE, PFA: -14 to +580 psi Enamel: -14 to +360 psi
Process connections	Threaded: 3/4" NPT, 1" NPT (316L) ASME Flange: 1-4" (316L or C22) Tri-clamp: 1-2" (316L)	Threaded: 3/4" NPT, 1" NPT (316L or C22) ASME Flange: 1-4" (316L or C22) Tri-clamp: 1-2" (316L)	ANSI flanges: 1" to 4" (Class 150, 300), 316L SS Tri-Clamp: 1½", 2", 316L SS 1" flush mount, 316L SS (requires weld neck adapter) Varivent DN 40, 316L SS	ANSI flanges: 1" to 4" (Class 150, 300), 316L SS Tri-Clamp: 1½", 2", 316L SS 1" flush mount, 316L SS (requires weld neck adapter) Varivent DN 40, 316L SS	ANSI flanges: 1" to 3", (Class 150, 300) 316L SS, coated (ECTFE, PFA) ANSI flanges: 2" (Class 150, 300) Alloy C-4, coated (Enamel)
Housings	Polyester (PBT) Aluminum	Compact (welded 316L SS), Polyester (PBT) Aluminum, Dual-compartment Aluminum, 316L SS	Compact (welded 316L SS), Polyester (PBT) Aluminum, Dual-compartment Aluminum, 316L SS	Compact (welded 316L SS), Polyester (PBT) Aluminum, Dual-compartment Aluminum, 316L SS	Polyester (PTB), 316L SS, coated Aluminum, dual-compartment coated aluminum
Maximum viscosity	10,000 CST	10,000 CST	10,000 cSt	10,000 cSt	10,000 cSt
Function indication	LED lights: Green, Yellow, Red (on electronics only)	LED lights: Green, Yellow, Red (on electronics and option Bright Status LED)	Red, yellow, green LEDs (depending on electronics)	Red, yellow, green LEDs (depending on electronics)	Red, yellow, green LEDs (depending on electronics)
Wetted material	316L	316L or C22	316L SS or Alloy C4	316L SS or Alloy C4	316L SS or Alloy C4, coated (ECTFE, PFA, Enamel)
Approvals / certificates	CSA, ATEX	CSA, ATEX, IEC, SIL, HEARTBEAT	FM, CSA, SIL 3, 3-A, FDA compliant materials	FM, CSA, SIL 3, 3-A, FDA compliant materials	FM, CSA, SIL 2, FDA compliant materials







Liquiphant® M		
	FTL50 (compact)	FTL51 (extended)
		
Application	Liquids	Liquids
Measurement type	Point level, liquids	Point level, liquids
Sensor	Frequency shift tuning fork, compact version	Frequency shift tuning fork, extended forks to 115" (optional to 235")
Output	FEL51: AC, load switched via thyristor FEL52: DC-PNP FEL54: DPDT relay FEL55: 8 to 16 mA FEL56: L-H edge NAMUR FEL58: H-L edge NAMUR with test button FEL57: PFM for separate switching unit FEL50A: Profibus® PA FEL50D: Density (with FML621 density computer)	FEL51: AC, load switched via thyristor FEL52: DC-PNP FEL54: DPDT relay FEL55: 8 to 16 mA FEL56: L-H edge NAMUR FEL58: H-L edge NAMUR with test button FEL57: PFM for separate switching unit FEL50A: Profibus PA FEL50D: Density (with FML621 density computer)
Power supply	FEL51: 19 to 253 VAC FEL52: 10 to 55 VDC (PNP) FEL54: 19 to 253 VAC, 19 to 55 VDC (relay) FEL55: 11 to 36 VDC (current) FEL56, 58, 57: NAMUR and PFM, requires separate power supply (e.g. FTL 325N / 325P) FEL50A: 9 to 32 VDC from bus FEL50D: powered by FML621 density computer	FEL51: 19 to 253 VAC FEL52: 10 to 55 VDC (PNP) FEL54: 19 to 253 VAC, 19 to 55 VDC (relay) FEL55: 11 to 36 VDC (current) FEL56, 58, 57: NAMUR and PFM, requires separate power supply (e.g. FTL 325N / 325P) FEL50A: 9 to 32 VDC from bus FEL50D: powered by FML621 density computer
Ambient temperature	-58 to +158°F	-58 to +158°F
Process temperature	-58 to +302°F	-58 to +302°F
Process pressure	Maximum 928 psi, threaded connections Flanges: pressure depends on flange selected and process temperature Maximum 230 psi, Tri-Clamp®	Maximum 1450 psi, threaded connections Flanges: pressure depends on flange selected and process temperature Maximum 230 psi, Tri-Clamp
Process connections	Threaded: ¾" NPT, 1" NPT, 316L SS or Alloy C-22 ANSI flanges: 1" to 4" (Class 150, 300), 316L SS Tri-Clamp: 1½", 2", 316L SS	Threaded: ¾" NPT, 1" NPT, 316L SS or Alloy C-22 ANSI flanges: 1" to 4" (Class 150, 300), 316L SS Tri-Clamp: 1-1/2", 2", 316L SS
Housings	Compact (welded 316L SS), Polyester (PBT) Aluminum, Dual-compartment Aluminum, 316L SS	Compact (welded 316L SS), Polyester (PBT) Aluminum, Dual-compartment Aluminum, 316L SS
Maximum viscosity	10,000 cSt	10,000 cSt
Function indication	Red, yellow, green LEDs (depending on electronics)	Red, yellow, green LEDs (depending on electronics)
Wetted material	316L SS or Alloy C22	316L SS or Alloy C22
Approvals / certificates	FM, CSA, SIL3	FM, CSA, SIL3

Liquiphant S High Temperature		
	FTL70 (compact)	FTL71 (extended)
		
Application	Liquids	Liquids
Measurement type	Point level, liquids	Point level, liquids
Sensor	Frequency shift tuning fork, compact version	Frequency shift tuning fork, extended forks to 115"
Output	FEL51: AC, load switched via thyristor FEL 52: DC-PNP FEL54: DPDT relay FEL55: 8 to 16 mA FEL56: L-H edge NAMUR FEL58: H-L edge NAMUR with test button FEL57: PFM for separate switching unit FEL50A: Profibus PA	
Power supply	FEL51: 19 to 253 VAC FEL52: 10 to 55 VDC (PNP) FEL54: 19 to 253 VAC, 19 to 55 VDC (relay) FEL55: 11 to 36 VDC (current) FEL56, 57, 58: NAMUR and PFM, requires separate power supply (e.g. FTL325N/325P) FEL50A: 9 to 32 VDC from bus	
Ambient temperature	-58 to +158°F	-58 to +158°F
Process temperature	-76 to +540°F	-76 to +540°F
Process pressure	Maximum 1450 psi, threaded connections Flanges: Pressure depends on flange selected and process temperature	
Process connections	Threaded: ¾" NPT, 1" NPT, 316L SS or Alloy C-4 ANSI flanges: 1" to 4" (Class 150, 300, 600) 316L SS RF, optional Alloy C 4 plating	
Housings	Polyester (PBT), Aluminum, Dual-compartment aluminum	
Maximum viscosity	10,000 cSt	10,000 cSt
Function indication	Red, yellow, green LEDs (depending on electronics)	
Wetted material	316L SS or Alloy C4	316L SS or Alloy C4
Approvals/certificates	FM, CSA, SIL 3	FM, CSA, SIL 3





Liquiphant T		
	FTL31	FTL33
		
Application	Liquids	Liquids
Measurement type	Point level, liquids	Point level, liquids
Sensor	Frequency shift tuning fork	Frequency shift tuning fork
Output	AC/DC DC-PNP	AC/DC DC-PNP
Power supply	20 to 253 V AC/ DC, 2-wire, 10 to 35 V DC- PNP, 3-wire	20 to 253 V AC/ DC, 2-wire, 10 to 35 V DC- PNP, 3-wire
Ambient temperature	-40 to 158°F	-40 to 158°F
Process temperature	-40 to 302°F	-40 to 302°F
Process pressure	580 psi	580 psi
Process connections	Threads: G½, G¾, G1, MNPT½, MNPT¾, MNPT1, R¾, R1	Threads: Tri- Clamp 1"-2", Flush mount, G½, G¾, G1, MNPT½, MNPT¾, MNPT1, R½, R¾, R1
Housing		
Maximum viscosity	1 to 10,000 mPas	1 to 10,000 mPas
Function indication	Red and green LEDs	Red and green LEDs
Wetted material	316L SS	316L SS
Approvals/ certificates	WHG, EN10204- 3.1 Material, Final Inspection Report	WHG, EN10204- 3.1 Material, Final Inspection Report

Liquiphant Failsafe	
	FTL825 Nivotester
	
Measuring Principle	Vibration Liquids
Characteristic / Application	Failsafe level transmitter point level. Connection to FTL80/81/85 Permanent self-monitoring, LIVE-signal
Supply / Communication	85 - 253 VAC/DC 20 - 30 VAC/20 - 60 VDC
Ambient temperature	-4°F to +140°F -20°C to +60°C
Output	2x SPST safety contact point level 1x SPST signal contact 1x SPDT fault contact
Certificates / Approvals	ATEX, FM, IECEx Overfill prevention WHG
Specialties	SIL 3 according to IEC61508
Instrumentation	Separate instrumentation

Liquiphant Failsafe			
	FTL80	FTL81	FTL85
			
Measuring Principle	Vibration Liquids	Vibration Liquids	Vibration Liquids
Characteristic / Application	Compact point level switch for MIN and MAX safety applications up to SIL3	Reliable point level switch with extension pipe for MIN and MAX safety applications up to SIL3	Coated point level switch for MIN and MAX
Supply / Communication	2-wire 4 to 20 mA	2-wire 4 to 20 mA	2-wire, 4 to 20 mA
Ambient temperature	-76°F to +160°F	-76°F to +160°F	-58° to +160F
Process temperature	-76°F to +540°F	-76°F to +540°F	-58°F to +300°F
Process pressure absolute / max. overpressure limit	Vacuum to 1450 psi (100 bar)	Vacuum to 1450 psi (100 bar)	Vacuum to 580 psi (40 bar)
Min. density of medium	Density from 0.4 SGU (0.4 g/cm3)	Density from 0.4 SGU (0.4 g/cm3)	Density from 0.4 SGU (0.4 g/cm3)
Main wetted parts	316L, Alloy C	316L, Alloy C	With high corrosion-resistant coating made of enamel, ECTFE and various PFA materials
Process connection	Flange: ASME 1" to 4", DN25 to DN100, JIS 10K to 20K Thread: G3/4, G1, R3/4, R1, MNPT3/4, MNPT1	Flange: ASME 1" to 4", DN25 to DN100, JIS 10K to 20K Thread: G3/4, G1, R3/4, R1, MNPT3/4, MNPT1	Flange: ASME 1" to 4", DN25 to DN100, JIS 10K to 20K
Sensor length	Compact	Extension pipe up to 9.8 ft (3 m)	Extension pipe up to 9.8 ft (3 m)
Output	2-wire 4 to 20 mA	2-wire 4 to 20 mA	2-wire 4 to 20 mA
Certificates / Approvals	ATEX, FM, IECEx Overfill prevention WHG EN10204-3.1 Material NACE	ATEX, FM, IECEx Overfill prevention WHG EN10204-3.1 Material NACE	ATEX, FM, IECEx Overfill prevention WHG EN10204-3.1 Material NACE
Components	Nivotester FTL825, Transmitter	Nivotester FTL825, Transmitter	Nivotester FTL825, Transmitter

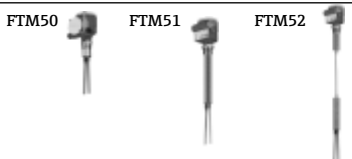



	Soliphant® M	Soliphant T
		
Application	Solids	Solids
Measurement type	Point level, fine-grained bulk solids	Point level, fine or coarse-grained bulk solids
Sensor	Frequency shift tuning fork	Frequency shift vibrating rod
Output (dependent on electronics insert selected)	AC (FEM51) DC-PNP (FEM52) AC/DC, relay output (FEM54) DC, 8/16 mA (FEM55) PFM (FEM57) output to Nivotester switch unit (i.e. FTL325) NAMUR, H-L edge (FEM58)	DC PNP AC/DC, relay output
Power supply	19 to 253 VAC 10 to 55 VDC (PNP) 19 to 253 VAC / 55 VDC 11 to 36 VDC	10 to 45 VDC (PNP) 19 to 253 VAC / 19 to 55 VDC
Ambient temperature	-58 to +158°F, -40 to +158°F (F16 polyester housing)	-40 to +158°F
Housing	Polyester, Aluminum, Dual-compartment aluminum, 316 SS	Polyester, Aluminum
Process temperature	-58 to +302°F	-40 to +302°F
Process pressure	FTM50, 51: -14.5 to 362 psi FTM52: 29 psi	-14.5 to 362 psi
Process connections	Threaded: 1-1/4", 1-1/2" NPT, 304 SS Flange: 2", 3", 4" 150 ANSI, 316 SS 2" Tri-Clamp, 316L SS	Threaded: 1-1/4" or 1-1/2" NPT, 316 SS
Measured detection range	FTM50: dependent on mounting location, 4" fork FTM51: extended tube, 6" up to 13 feet FTM52: extension cable, up to 65 feet	Dependent on mounting location FTM21: extension pipe; 20, 40 or 60 inch
Maximum particle size	0.4"	≤ 0.98"
Function indication	Red and green LEDs	Green and yellow LEDs
Wetted material	Threaded process connection: 316L SS Extension tube: 316L SS Flanges: 316L SS Cable: braided steel, polyurethane coated Fork: 316L SS	316L SS
Approvals/certificates	CE, SIL 2 combination FM/CSA	CE, combination FM/CSA

	FML621 Density Computer
	
Application	Density/concentration
Medium	Liquids
Housing	DIN rail or panel mount
Inputs	Pressure, temperature, FEL50D electronic insert (analog, digital, TC, RTD, mA, mV, V, pulse)
Outputs	4 to 20 mA, relays, pulse
Display / Local operation	160 x 80 dot matrix with rear illumination / 8 soft-key pushbuttons or RS232/RS485
Interface	RS232, RS485, PROFIBUS PA
Operating software	ReadWin 2000
Ambient temperature	-4 to +122°F
Power supply	90 to 250 VAC 20 to 36 VDC, 20 to 28 VAC
Standards/approvals	FM, CSA



NOTE: The FML621 density computer is only available for use with a Liquiphant M specified with the FEL50D electronics. The FDL50D electronics are not interchangeable with any other electronic insert.



Level Limit Switch/Power supply

	Nivotester	
	FTL325P (intrinsically safe signal circuit, Liquiphant/Soliphant®) 	FTL325N (one and three channel amplifier for NAMUR) 
Application	Liquids, solids	Liquids
Measurement type	Point level	Point level
Output	AC/DC, relays	AD/DC, relays
Input	PFM signal	NAMUR L-H edge
Power supply	85 to 253 VAC 20 to 60 VDC	85 to 253 VAC 20 to 60 VDC
Ambient temperature	-4 to +140°F	-4 to +140°F
Mounting	DIN rail	DIN rail
Function indication	Red, green, yellow LEDs	Red, green, yellow LEDs
Operation	Switches	Switches
Housing	Body, Polycarbonate Front cover, polypropylene	Body, Polycarbonate Front cover, polypropylene
Approvals/certificates	CE, FM, CSA, SIL 2	CE, FM, CSA, NAMUR







Conductivity

Liquipoint		
	FTW23 	FTW33 
Measuring Principle	Capacitance	Conductive
Characteristic / Application	For use in storage tanks, mixing vessels and pipes. For water based liquids or media with dielectric constant >20	Compact point level switch for use in pipes and in storage, mixing and process vessels with or without an agitator, active buildup compensation, flush mounting
Supply / Communication	10 to 30 V DC	10 to 30 V DC
Ambient temperature	-40 to 158°F (-40 to 70°C)	-40 to 158°F (-40 to 70°C)
Process temperature	Standard: -4 to +212°F Cleaning: -4 to +275°F for 1h	Standard: -4 to +212°F Cleaning: -4 to 302°F for 1h
Process pressure absolute / max. overpressure limit	Vacuum: 232 psi	0 to 362.5 psi abs / 0 to 25 bar abs
Min. conductivity of medium	>20 DC	1µS/cm
Main wetted parts	Sensor: 316L Sensor isolation: PEEK	Sensor: 316L Sensor isolation: PEEK
Process connection	Thread G1, G1/2, G3/4, M24	Thread G1, G1/2, G3/4, M24
Process connection hygienic	Weld-in adapters, Tri-Clamp, Varivent	Clamp ISO 2852 1 to 1 1/2", 2", DIN11851 Pipe union
Output	DC PNP, IO-Link	DC PNP, IO-Link
Approvals/certificates	EHEDG, 3A, CSA C/US General Purpose	EHEDG, 3A
Specialties	CIP and SIP suitable	CIP and SIP suitable
Application limits	Buildup	Conductive foam is recognized as a liquid
Instrumentation	Compact	Compact
Electronic insert	DC/PNP	DC PNP



Liquipoint T	
	FTW31  FTW32 
Application	Liquids
Measurement type	Multiple point level
Output	AC/DC, relay DC-PNP NAMUR
Measured detection range	FTW31 rod: 4" to 158" FTW32 cable: 10" to 590"
Power supply	20 to 253 VAC/20 to 55 VDC 10.8 to 45 VDC (PNP) NAMUR requires separate power, e.g. FTW325
Ambient temperature	-40 to +160°F NAMUR, -40 to +140°F
Process temperature	-40 to +212°F
Process pressure	-14.5 to 145 psi
Process connection	Threaded: 1-1/2" NPT
Wetted material	Rod probes: 316L SS, PP insulation Cable probes: 316Ti SS, FEP insulation
Function indication	Red, yellow, green LEDs
Housing	Compact: PBT Remote: housing PPS; cover PBT
Approvals/certificates	CE



Capacitance

	Nivector	Minicap		Solicap [®] M	Solicap S
	FTC968 	FTC260 (compact version) 	FTC262 (cable version) 	FTI55 / FTI56 (limit detection switch) 	FTI77 (limit detection switch) 
Application	Powders, granules, pellets	Bulk solids, liquids	Bulk solids	Bulk solids	Bulk solids / high temperature
Measurement type	Point level	Point level	Point level	Point level	Point level
Output	AC DC-PNP	AC/DC, relay DC-PNP	AC/DC, relay DC-PNP	AC - 2 wire (FEI51) DC - PNP (FEI52) 3-12 VDC (FEI53) AC/DC, relay output (FEI54) 8/16 mA (FEI55) PFM (FEI57S) NAMUR H-L Edge (FEI58)	AC - 2 wire (FEI51) DC - PNP (FEI52) 3-12 VDC (FEI53) AC/DC, relay output (FEI54) 8/16 mA (FEI55) PFM (FEI57S) NAMUR H-L Edge (FEI58)
Measured detection range	Dependent on mounting location	Dependent on mounting location	236"	Rod probe: up to 13 ft Cable probe: up to 72 ft	Sword probe: up to 40 inches Cable probe: up to 65 ft
Power supply	21 to 253 VAC 10 to 55 VDC (PNP)	20 to 253 VAC 20 to 55 VDC 10.8 to 45 VDC (PNP)	20 to 253 VAC 20 to 55 VDC 10.8 to 45 VDC (PNP)	FEI52: 10 to 55 VDC FEI53: 14.5 VDC FEI54: 19 to 253 VAC, 50/60 Hz or 19 to 55 VDC FEI55: 11 to 36 VDC FEI57S: 9.5 to 12.5 VDC FEI58: powered by FTL325N or 375N	FEI52: 10 to 55 VDC FEI53: 14.5 VDC FEI54: 19 to 253 VAC, 50/60 Hz or 19 to 55 VDC FEI55: 11 to 36 VDC FEI57S: 9.5 to 12.5 VDC FEI58: powered by FTL325N or 375N
Ambient temperature	-4 to +140°F	-40 to +176°F	-40 to +176°F	-58 to +158°F	-58 to +158°F
Process temperature	-4 to +176°F	-40 to +266°F	-40 to +176°F	-58 to +356°F	-58 to +752°F
Process pressure	-14.5 to 87 psi	-14.5 to 360 psi	-14.5 to 90 psi	-14.5 to 360 psi	-14.5 to 145 psi
Process connections	Threaded: 1"BSPP with two hex lock nuts	Threaded: 1" NPT	Threaded: 1-1/2" NPT	Threaded: 1-1/2" NPT Flange: 2", 3" or 4"	Threaded: 1-1/2" NPT Flange: 2", 3" or 4"
Maximum particle size	0.4"	1.2"	1.2"	N/A	N/A
Function indication	Red LED	Red and green LEDs	Red and green LEDs	Red, green and yellow LEDs	Red, green and yellow LEDs
Wetted material	Blue PC, lock nuts black PA	Probe: Polyphenylene sulphide (FDA listed material)	Cable: steel coated with high density PE Probe: Polyphenylene sulphide (FDA listed material)	Rod, partially insulated: PPS, 316L SS Rod: fully insulated: PE, galv. steel Cable, partially insulated: PTFE, 316L SS Cable, fully insulated: PA, valv. steel	Sword, process connection, inactive length, tensioning weight for cable probe: 316L SS or steel Cable: zinc coated steel or 316L SS
Housing	PC	Polyester	Polyester	Polyester, Aluminum Dual-compartment aluminum, 316 SS	Polyester, Aluminum Dual-compartment aluminum, 316 SS
Approvals/certificates	CE	CE, FM, CSA	CE, FM, CSA	CD, combination FM/CSA, SIL2/SIL3 (with FEI55 insert)	CD, combination FM/CSA, SIL2/SIL3 (with FEI55 insert)



Liquicap® M		
	FTI51 / FTI52 (limit detection switch)	FMI51 / FMI52 (continuous level detection)
		
Application	Liquids	Liquids
Measurement type	Point level	Continuous level
Output	AC 2-wire (FEI51) DC-PNP (FEI52) 3-12 VDC (FEI53) AC/DC, relay output (FEI54) 8/16 mA (FEI55) PFM (FEI57S)	4 to 20 mA HART™ (FEI50H) PFM (FEI57C)
Measured detection range	Rod probe: up to 13 ft / Cable probe: up to 33 ft	Rod probe: up to 13 ft / Cable probe: up to 72 ft
Power supply	FEI51: 19 to 253 VAC FEI52: 10 to 55 VDC FEI53: 14.5 VDC FEI54: 19 to 253 VAC, 50/60 Hz or 19 to 55 VDC FEI55: 11 to 36 VDC FEI57S: 9.5 to 12.5 VDC	FEI50H: 12 to 36 VDC FEI57C: 14.8 VDC
Ambient temperature	-58 to +158°F	-58 to +158°F
Process temperature	-112 to +392°F	-112 to +392°F
Process pressure	-14.5 to 1450 psi	-14.5 to 1450 psi
Process connections	Threaded: 1/2", 3/4", 1", 1-1/2" Flange: 1" to 6" Tri-Clamp: 1", 1-1/2", 2"	Threaded: 1/2", 3/4", 1", 1-1/2" Flange: 1" to 6" Tri-Clamp: 1", 1-1/2", 2"
Maximum particle size	N/A	N/A
Function indication	Red, green, yellow LEDs	Red and green LED, HART, local display
Wetted material	Rod: 316L SS; insulated rod, PFA or PTFE coated 316L SS Cable: 316 SS; insulated cable, PFA or FEP coated 316 SS	Rod: 316L SS; insulated rod, PFA or PTFE coated 316L SS Cable: 316 SS; insulated cable, PFA or FEP coated 316 SS
Housing	Polyester, Aluminum, Dual-compartment aluminum, 316 SS	Polyester, Aluminum, Dual-compartment aluminum, 316 SS
Approvals/certificates	CE, combination FM/CSA, SIL2	CE, combination FM/CSA, SIL2





Liquicap T	
	FMI21
	
Application	Liquids
Measurement type	Capacitance, continuous
Output	4 to 20 mA 0 to 100%
Measured detection range	6" to 98"
Power supply	10 to 30 VDC
Ambient temperature	-40 to +160°F
Process temperature	-40 to +212°F
Process pressure	-14.5 to 145 psi
Process connections	Threaded: 1-1/2" NPT, PPS
Wetted material	Rod probes: 316L SS, optional carbon fiber (CPC) Probe insulation: PP
Function indication	Red and green LEDs, optional display
Housing	PBT-FT Cover PBT Cover with sight glass, PA
Approvals/certificates	CE



Transmitter/Limit Switch

Nivotester		
	FTC325 (intrinsically safe signal circuit)	FTW325 (intrinsically safe signal circuit)
		
Application	Liquids, solids	Liquids
Measurement type	Capacitance, point level	Conductivity, point level
Output	One SPDT, one SPST	Two relays, SPDT
Input	2-wire, PFM, 3-wire analog	NAMUR
Power supply	85 to 253 VAC 20 to 30 VAC / 20 to 60 VDC	85 to 253 VAC 20 to 30 VAC / 20 to 60 VDC
Ambient temperature	-4 to +120°F	-4 to +140°F
Mounting	DIN rail	DIN rail
Function indication	Red, green, yellow LEDs	Red, green, yellow LEDs
Operation	Switches	Switches
Housing	Body, Polycarbonate Front cover, polypropylene	Body, Polycarbonate Front cover, polypropylene
Approvals / certificates	CE, FM, CSA (3-wire, non-hazardous)	CE, FM, CSA, NAMUR







Radar

Micropilot®				
	FMR50	FMR51	FMR52	FMR53
				
Application	Liquids	Liquids	Liquids	Liquids
Measurement type	Radar, non contact, continuous	Radar, non contact, continuous	Radar, non contact, continuous	Radar, non contact, continuous
Max measured range	98 ft, 130 ft enhanced dynamics	131 ft, 230 ft enhanced dynamics	131 ft, 197 ft enhanced dynamics	66 ft
Output	4 to 20mA HART, Profibus, FOUNDATION™ Fieldbus	4 to 20mA HART, Profibus, FOUNDATION™ Fieldbus	4 to 20mA HART, Profibus, FOUNDATION Fieldbus	4 to 20mA HART, Profibus, FOUNDATION Fieldbus
Antenna type	Encapsulated PVDF or PP clad horn antenna	Horn: 1-1/2", 2", 3", 4"	Horn: PTFE disk, 2" and 3"	PFTE Rod antenna
Power supply	16-32 VDC	16-32 VDC	16-32 VDC	16-32 VDC
Ambient temperature	-40 to +176°F	-40 to +176°F	-40 to +176°F	-40 to +176°F
Process temperature	-40 to +266°F	-321 to +842°F	-40 to +392°F	-40 to +302°F
Process connections	G1-1/2, MNPT1-1/2, Flange (3" to 6")	MNPT1-1/2", Flange (2" to 6"), Tri-Clamp	Flange 2" to 6", Tri-Clamp	MNPT1-1/2, Flange (2" to 6")
Wetted material	PVDF, PTFE, Viton, PP, PBT	316L, Alloy C, PTFE, Ceramic	PTFE	PVDF, PTFE
Operation	4 to 20 mA, HART Display (with three buttons) SmartBlue (app) via Bluetooth wireless technology	HART, Profibus, FOUNDATION Fieldbus, Display (with three buttons) SmartBlue (app) via Bluetooth wireless technology	HART, Profibus, FOUNDATION Fieldbus, Display (with three buttons) SmartBlue (app) via Bluetooth wireless technology	HART, Profibus, FOUNDATION Fieldbus, Display (with three buttons) SmartBlue (app) via Bluetooth wireless technology
Housing	PTB Plastic, Dual compartment Aluminum, Dual compartment	316L, Dual compartment Aluminum, Dual compartment	316L, Dual compartment Aluminum, Dual compartment	316L, Dual compartment Aluminum, Dual compartment
Approvals / certificates	ATEX, FM, CSA, CE, SIL	ATEX, FM, CSA, CE, SIL	ATEX, FM, CSA, CE, SIL	ATEX, FM, CSA, CE, SIL

Micropilot			
	FMR54	FMR56	FMR57
			
Application	Liquids	Bulk solids	Bulk solids
Measurement type	Radar, non contact, continuous	Radar, non contact, continuous	Radar, non contact, continuous
Max measured range	66 ft	98 ft	230 ft
Output	4 to 20mA HART, Profibus, FOUNDATION Fieldbus	4 to 20mA HART, Profibus, FOUNDATION Fieldbus	4 to 20mA HART, Profibus, FOUNDATION Fieldbus
Antenna type	Horn: 3", 4", 6", 8", 10"	Horn: PP 3" and 4"	Parabolic 8" and 10", Horn 3" and 4"
Power supply	16-32 VDC	16-32 VDC	16-32 VDC
Ambient temperature	-40 to +176°F	-40 to +176°F	-40 to +176°F
Process temperature	-321 to +752°F	-40 to +176°F	-40 to +752°F
Process connections	Flange(3" to 12")	Flange 3" to 6", Mounting Bracket	MNPT1-1/2, Flange 3" and 4", UNI 8" and 10"
Wetted material	316L	PP, UP	316L, PTFE, PEEK, Polyamid
Operation	HART, Profibus, FOUNDATION Fieldbus, Display (with three buttons) SmartBlue (app) via Bluetooth wireless technology	HART, Profibus, FOUNDATION Fieldbus, Display (with three buttons) SmartBlue (app) via Bluetooth wireless technology	HART, Profibus, FOUNDATION Fieldbus, Display (with three buttons) SmartBlue (app) via Bluetooth wireless technology
Housing	316L, Dual compartment Aluminum, Dual compartment	PTB Plastic, Dual compartment Aluminum, Dual compartment	316L, Dual compartment Aluminum, Dual compartment
Approvals / certificates	ATEX, FM, CSA, CE, SIL	ATEX, FM, CSA, CE, SIL	ATEX, FM, CSA, CE, SIL









Micropilot			
	FMR60	FMR62	FMR67
			
Application	Liquids	Liquids	Bulk solids
Measurement type	Radar, non contact, continuous	Radar, non contact, continuous	Radar, non contact, continuous
Max measured range	164 ft	262 ft	410 ft
Output	4 to 20mA, HART	4 to 20mA, HART	4 to 20mA, HART
Antenna type	PTFE antenna	PEEK, PTFE plated	PTFE, PTFE plated
Power supply	16-35 VDC	16-35 VDC	16-35 VDC
Ambient temperature	-40 to +176°F	-40 to +176°F	-40 to +176°F
Process temperature	-40 to +266°F	-40 to +392°F	-40 to +392°F
Process connections	Thread MNPT 1½"	Thread MNPT 1½", Flanges 2" to 6", Tri-Clamp	Thread MNPT1½", Flanges 3" and 4", Alignment UNI 3" to 10"
Wetted material	316L SS	316L SS	316L SS
Operation	HART, Display (with three buttons) SmartBlue (app) via <i>Bluetooth</i> wireless technology	HART, Display (with three buttons) SmartBlue (app) via <i>Bluetooth</i> wireless technology	HART, Display (with three buttons) SmartBlue (app) via <i>Bluetooth</i> wireless technology
Housing	Plastic, Aluminum	Plastic, Aluminum	Plastic, Aluminum
Approvals / certificates	ATEX, IEC, FM, CSA, CE, SIL	ATEX, FM, CSA, CE, SIL	ATEX, FM, CSA, CE, SIL

Micropilot		
	FMR10	FMR20
		
Application	Continuous/ Liquids	Continuous/Liquids
Measurement type	Radar, non-contact level and flow	Radar, non-contact level and flow
Max measured range	16 ft	66 ft
Output	<ul style="list-style-type: none"> ■ Current output: 4 to 20 mA ■ Digital output (SmartBlue): 0 to 16 ft 	<ul style="list-style-type: none"> ■ Current output: 4 to 20 mA ■ Digital output (HART, SmartBlue): 0 to 66 ft, depending on antenna version
Antenna type	Integral non-metallic horn	Integral non-metallic horn
Specialties	Bluetooth® commissioning, Operation and maintenance via SmartBlue App	Optional Bluetooth® commissioning, Operation and maintenance via SmartBlue App
Supply/Communication	2-wire (4 to 20 mA) <i>Bluetooth</i> ® wireless technology and App	2-wire (HART, 4 to 20 mA), <i>Bluetooth</i> ® wireless technology and App (optional)
Ambient temperature	-40 to +140°F	-40 to +176°F
Process temperature	-40 to +140°F	-40 to +176°F
Process pressure	-14.5 to 43 psi	-14.5 to +43psi
Process connections	Thread: G1", NPT1"; G1 1/2", NPT1 1/2"	Thread: G1", NPT1"; G1 1/2", NPT1 1/2", G2", NPT2", Flange: 3" to 6"
Wetted material	PVDF, PBT	PVDF, PBT
Operation	4 to 20 mA; SmartBlue (app) via <i>Bluetooth</i> wireless technology	HART; DeviceCare; Optional: SmartBlue (app) via <i>Bluetooth</i> wireless technology
Housing	PVDF	PVDF
Approvals / certificates	CSA C/US	ATEX, CSA C/US, IEC Ex



Radar





Micropilot S High Accuracy						
	FMR530	FMR532	FMR533	FMR540	NMR81	NMR84
						
Application	Liquids, custody transfer	Liquids, custody transfer	Liquids, custody transfer	Liquids, custody transfer	Liquids, custody transfer	Liquids, custody transfer
Measurement type	Radar, non-contact, continuous	Radar, non-contact, continuous	Radar, non-contact, continuous	Radar, non-contact, continuous	Radar, non-contact	Radar, non-contact
Max measured range	65 ft	125 ft	131 ft	Horn: 98 ft Parabolic: 131 ft	230 ft	131 ft
Output	4 to 20 mA, HART	4 to 20 mA, HART	4 to 20 mA, HART	4 to 20 mA, HART	4 to 20 mA, HART, Modbus RS485, V1	4 to 20 mA, HART, Modbus RS485, V1
Antenna type	Horn: 3", 4", 6", 8", 10"	Planar: 6", 8", 10" 12"	Parabolic antenna: 20"	Horn: 4" Parabolic: 8", 10"	Drip off, tear drop	Drip-off, planar
Power supply	16 to 32 VDC	16 to 32 VDC	16 to 32 VDC	16 to 36 VDC	85 to 264 VAC	85 to 264 VAC
Ambient temperature	-40 to +176°F	-40 to +176°F	-40 to +176°F	-40 to +176°F	-40 to +140°F	-40 to +140°F
Process temperature	-40 to +392°F	-40 to +302°F	-40 to +392°F	-40 to +392°F	-40 to +392°F	-40 to +392°F
Process pressure	14.5 to 580 psi	14.5 to 362 psi	14.5 to 232 psi	Horn: -14.5 to 232 psi Parabolic: -14.5 to 87 psi	232 psi	362 psi
Process connections	3" to 10" ANSI flange	6" to 12" ANSI flange 6" to 12" Uniflange	6" to 10" ANSI flange 6" Uniflange	4" or 6" ANSI flange 6", 8" or 10" Uniflange	2", 3", 4" flange	4" - 12" flange
Wetted material	PTFE, 316Ti SS	HNBR, 316L SS	PTFE, 316L SS	Horn: PEEK, 316L SS Parabolic: PTFE, 316L SS	316SS, PEEK	316SS PEEK
Operation	HART, VU331 display module, FieldCare software	HART, VU331 display module, FieldCare software	HART, VU331 display module, FieldCare software	HART, VU331 display module, FieldCare software	HART, display module, FieldCare software	HART, display module, FieldCare software
Housing	Aluminum with separate connection compartment	Aluminum with separate connection compartment	Aluminum with separate connection compartment	Aluminum with separate connection compartment	Aluminum or 316L SS	Aluminum or 316L SS
Approvals / certificates	CE, FM, CSA, Nmi, PTB	CE, FM, CSA, Nmi, PTB	CE, FM, CSA, Nmi, PTB	CE, FM, CSA, Nmi, PTB	CE, FM, CSA, Nmi, PTB	CE, FM, CSA, Nmi, PTB

Tank Gauging



Proservo			
	NMS80	NMS81	NMS83
			
Application	Liquids, liquified gases, high accuracy	Liquids, liquified gases, high accuracy	Hygienic liquids, high accuracy
Measurement type	High precision servo	High precision servo	High precision servo
Max measured range	154 ft	154 ft	154 ft
Output	4 to 20 mA, HART, Modbus RS485, V1	4 to 20 mA, HART, Modbus RS485, V1	4 to 20 mA, HART, Modbus RS485, V1
Power supply	85 to 264 VAC	85 to 264 VAC	85 to 264 VAC
Ambient temperature	-40 to +140°F	-40 to +140°F	-40 to +140°F
Process temperature	-328 to +392°F	-328 to +392°F	-328 to +392°F
Process pressure	0 to 87 psi	0 to 362.5 psi	0 to 362.5 psi
Process connections	3", 4", 6"	3", 4", 6"	3", 4", 6"
Wetted material	Carbon Steel, 316L SS	316L SS	316L SS
Operation	HART, display module, FieldCare software	HART, display module, FieldCare software	HART, display module, FieldCare software
Housing	Aluminum or 316L SS	Aluminum or 316L SS	Aluminum or 316L SS
Approvals / certificates	ATEX, CSA, FM	ATEX, CSA, FM	ATEX, CSA, FM

Tank Side Monitoring	
	NRF81
	
Application	System integration
Measurement type	Legacy systems
Output	4 to 20 mA, HART, Modbus RS485, V1
Power supply	85 to 264 VAC
Ambient temperature	-40 to +140°F
Operation	HART, display module, FieldCare software
Housing	Aluminum, 316L SS
Approvals / certificates	CE, FM, CSA, Nmi, PTB





Levelflex (for liquids)					
	FMP50 (Rod/cable probe)	FMP51 / 52 / 54			FMP53 (Rod probe)
					
		FMP51 (rod, cable, coax)	FMP52 (rod, cable)	FMP54 (rod, cable, coax)	
Application	Liquids	Liquids	Liquids, corrosive	Liquids, high temperature/ pressure	Liquids, hygienic
Measurement type	Radar, continuous level	Radar, continuous level/ interface	Radar, continuous level/ interface	Radar, continuous level/ interface	Radar, continuous
Measured range	Liquids: 39 ft Max. rod length, 13 ft Max. cable length, 40 ft	Liquids: 148 ft Max. rod length, 33 ft Max. cable length, 148 ft Max. coax length, 20 ft	Liquids: 148 ft Max. rod length, 13 ft Max. cable length, 148 ft	Liquids: 148 ft Max. rod length, 33 ft Max. cable length, 148 ft Max. coax length, 20 ft	Liquids: maximum 20 ft.
Output	4 to 20 mA, HART; Profibus PA; FOUNDATION Fieldbus	4 to 20 mA, HART; Profibus PA; FOUNDATION Fieldbus	4 to 20 mA, HART; Profibus PA; FOUNDATION Fieldbus	4 to 20 mA, HART; Profibus PA; FOUNDATION Fieldbus	4 to 20 mA, HART; Profibus PA; FOUNDATION Fieldbus
Power supply	HART 2-wire: 11.5 to 35 VDC HART 4-wire: 90 to 253 VAC, 10.4 to 48 VDC Profibus 2-wire: 9 to 32 VDC	HART 2-wire: 11.5 to 35 VDC HART 4-wire: 90 to 253 VAC, 10.4 to 48 VDC Profibus 2-wire: 9 to 32 VDC	HART 2-wire: 11.5 to 35 VDC HART 4-wire: 90 to 253 VAC, 10.4 to 48 VDC Profibus 2-wire: 9 to 32 VDC	HART 2-wire: 11.5 to 35 VDC HART 4-wire: 90 to 253 VAC, 10.4 to 48 VDC Profibus 2-wire: 9 to 32 VDC	HART 2-wire: 11.5 to 35 VDC HART 4-wire: 90 to 253 VAC, 10.4 to 48 VDC Profibus 2-wire: 9 to 32 VDC
Ambient temperature	-40 to +176°F With display: -4 to +158°F	-40 to +176°F With display: -4 to +158°F	-40 to +176°F With display: -4 to +158°F	-40 to +176°F With display: -4 to +158°F	-40 to +176°F With display: -4 to +158°F
Process temperature	-4 to +176°F	-50 to +392°F depending on O-ring material	-50 to +392°F	-321 to +842°F	-4 to +302°F, with FFKM O-ring -4 to +266°F, with EPDM O-ring
Process pressure	Vacuum to 87 psi	Vacuum to 580 psi	Vacuum to 580 psi	Vacuum to 5800 psi	Vacuum to 232 psi
Process connections	¾" NPT	¾", 1½" NPT Flange, 1½" to 8" (150 lb to 300 lb)	1½", 2" 3" Tri-Clamp Flange, 1½", 2", 3", 4" (150 lb to 300 lb)	1½" NPT Flange 2", 3", 4" (300 lb to 1500 lb)	1" to 1½", 2" or 3" Tri-Clamp SMS, DIN and NEMUO Bio process connections
Wetted material	316L, 316 SS	316L SS, PTFE	316L SS, PTFE	316L SS, PTFE	Probe, 316L SS
Operation	4-line LCD with 3 push- buttons, HART, Profibus PA SmartBlue (app) via <i>Bluetooth</i> wireless technology	4-line LCD with 3 push- buttons, HART, Profibus PA SmartBlue (app) via <i>Bluetooth</i> wireless technology	4-line LCD with 3 push- buttons, HART, Profibus PA SmartBlue (app) via <i>Bluetooth</i> wireless technology	4-line LCD with 3 push- buttons, HART, Profibus PA SmartBlue (app) via <i>Bluetooth</i> wireless technology	4-line LCD with 3 push-buttons, HART, Profibus PA SmartBlue (app) via <i>Bluetooth</i> wireless technology
Housing	PTB plastic, dual compartment Aluminum, dual compartment	PTB plastic, dual compartment Aluminum, dual compartment 316L SS, dual compartment	PTB plastic, dual compartment Aluminum, dual compartment 316L SS, dual compartment	PTB plastic, dual compartment Aluminum, dual compartment 316L SS, dual compartment	PTB plastic, dual compartment Aluminum, dual compartment
Approvals/ certificates	CE, FM, CSA, SIL 3	CE, FM, CSA, SIL 3	CE, FM, CSA, SIL 3, 3-A, FDA	CE, FM, CSA, SIL 3	CE, FM, CSA, SIL 3, ASME BPE and USP Class VI, FDA, 3-A

Levelflex	
	FMP55 (Rod/cable, coax) 
Application	Liquids, level and interface
Measurement type	Radar and capacitance, continuous
Measured range	Liquids: 33 ft Max. rod length, 13 ft Max. cable length, 33 ft Max. coax length, 20 ft
Output	4 to 20 mA, HART Profibus PA, FOUNDATION Fieldbus
Power supply	HART 2-wire: 11.5 to 35 VDC HART 4-wire: 90 to 253 VAC, 10.4 to 48 VDC Profibus 2-wire: 9 to 32 VDC
Ambient temperature	-40 to +176°F
Process temperature	-58 to +392°F
Process pressure	-14.5 to 580 psi
Process connections	1½" to 6", 150 lb ANSI RF flange, PTFE coated 1" to 4" 300 lb ANSI RF flange, PTFE coated
Wetted material	316L, SS
Operation	4-line LCD with 3 push-buttons, HART, Profibus PA Remote operation via HART, FieldCare SmartBlue (app) via <i>Bluetooth</i> wireless technology
Housing	PTB plastic, dual compartment; Aluminum, dual compartment; 316L SS, dual compartment
Approvals/ certificates	CE, FM, CSA, SIL 3

Levelflex (for solids)		
	FMP56 (cable) 	FMP57 (rod, cable) 
Application	Solids, level	Solids, level
Measurement type	Radar, continuous	
Measured range	Solids, 40 ft Max cable length, 40 ft	Solids, 40 ft Max. rod length, 13 ft Max. cable length, 148 ft
Output	4 to 20 mA, HART, Profibus PA, FOUNDATION Fieldbus	
Power supply	HART 2-wire: 11.5 to 35 VDC; Profibus 2-wire: 9 to 32 VDC HART 4-wire: 90 to 253 VAC, 10.4 to 48 VDC	
Ambient temperature	-40 to +176°F; With display: -4 to +158°F	
Process temperature	-22 to +248°F, with FKM O-ring -40 to +248°F, with EPDM O-ring	-22 to +302°F, with FKM O-ring -40 to +248°F, with EPDM O-ring 23 to 365°F, with FFKM O-ring
Process pressure	-14.5 to 232 psi	
Process connections	¾" NPT	1½" NPT Flange, 1½" to 8" (150 lb ANSI)
Wetted material	316L SS	
Operation	4-line LCD with 3 pushbuttons, HART, Profibus PA SmartBlue (app) via <i>Bluetooth</i> wireless technology	
Housing	PTB plastic, dual compartment; Aluminum, dual compartment; 316L SS, dual compartment	
Approvals/ certificates	CE, FM, CSA, SIL 3	





Microwave barrier

Soliwave M FQR56 / FDR56		
	FQR56 Emitter	FDR56 Receiver
		
Application	Wood chips, wood dust or flour; plaster, cement, ash; paper or cardboard shred, gravel, sand, dried powders in general, bags and boxes	
Measurement type	Non-contact microwave	
Output	Relay SPDT, 4 to 20 mA, Solid State Relay	
Measured detection range	328 ft	
Power supply	85 to 253 VAC 20 to 60 VDC/20 to 30 VAC	
Ambient temperature	-40 to +158°F	
Process temperature	-40 to +158°F	
Process pressure	Non-contact installation: any within installation 7.2 psi to 99 psi	
Process connections	1½" R, 1½" NPT	
Housing	Polyester or 316 SS	
Approvals/Certificates	CSA, ATEX, IECEx	

Mechanical





Nivotester FTR325 Switch Amplifier	
	FTR325 Single channel amplifier 
Application	Single channel switch amplifier for the Soliwave microwave barrier system. Used for level detection of solids or control and counting of packaged goods
Input	Open collector output from Soliwave
Output	SPDT relay and SPST alarm signal output relay
Power supply	85 to 253 VAC, 50/60 Hz 20 to 60 VDC / 20 to 30 VAC, 50/60 Hz
Ambient temperature	-4 to +140°F
Mounting	DIN rail
Housing	Polycarbonate
Approvals/Certificates	CE

Solimotion® Flow Indicator	
	FTR20 
Application	Flow indicator, bulk solids
Measurement type	Microwave barrier
Output	Relay SPST Analog 4 to 20 mA Solid State relay
Measured detection range	65 ft (20 m)
Power supply	85 - 253 VAC or 20 - 60 VDC Solid State 30 VAC or 30 VDC
Ambient temperature	-40 to +158°F
Process temperature	-40 to +158°F
Process pressure	7.2 to 98.6 psia
Process connections	Thread R 1½" (EN 10226) NPT 1½" (ANSI/ASME B1.20.1)
Housing	Polyester or Stainless Steel
Approvals/Certificates	CSA, ATEX, IECEx

	Soliswitch	Silopilot
	FTE31 	FMM50 
Application	Solids	Continuous, solids
Measurement type	Paddle switch	Electromechanical (Yo-Yo)
Output	Binary, SPDT relay	0/4 to 20 mA
Measured detection range	FTE rod: 4" to 23" FTE cable: up to 78"	229 ft
Power supply	110 VAC 230 VAC 20 to 28 VDC	180 to 253 VAC, 50/60 HZ or 90 to 127 VAC, 50/60 HZ
Ambient temperature	-4 to +140°F	-40 to +158°F
Process temperature	-4 to +180°F	-4 to +446°F
Process pressure	7 to 26 psi	11.6 to 43.5 psi
Maximum particle size	2"	N/A
Process connections	Threaded: 1¼" NPT Valox 553 (PBT) or 316L SS	Flange, 4"
Wetted material	Rod and paddle: 316L SS Cable extensions: 316Ti SS	SS, Alu/Steel
Function indication	N/A	Plain text display
Housing	PBT	Aluminum Aluminum coated
Approvals/Certificates	CE, FM, CSA	ATEX







Ultrasonic



Prosonic M					
	FMU 40	FMU 41	FMU 42	FMU 43	FMU 44
					
Application	Solids, liquids	Solids, liquids	Solids, liquids	Solids, liquids	Solids, liquids
Measurement type	Ultrasonic, continuous, non-contact	Ultrasonic, continuous, non-contact	Ultrasonic, continuous, non-contact	Ultrasonic, continuous, non-contact	Ultrasonic, continuous, non-contact
Maximum measured range	Solids: 6 ft Liquids: 16 ft	Solids: 12 ft Liquids: 26 ft	Solids: 16 ft Liquids: 33 ft	Solids: 23 ft Liquids: 50 ft	Solids: 33 ft Liquids: 65 ft
Output	4 to 20 mA, HART, Profibus, Foundation Fieldbus	4 to 20 mA, HART, Profibus, Foundation Fieldbus	4 to 20 mA, HART, Profibus, Foundation Fieldbus	4 to 20 mA, HART, Profibus, Foundation Fieldbus	4 to 20 mA, HART, Profibus, Foundation Fieldbus
Power supply	HART 2-wire, 4-20 mA loop HART 4-wire, 10.5 to 32 VDC HART 4-wire, 90 to 253 VAC 2-wire Profibus 2-wire Foundation Fieldbus	HART 2-wire, 4-20 mA loop HART 4-wire, 10.5 to 32 VDC HART 4-wire, 90 to 250 VAC 2-wire Profibus 2-wire Foundation Fieldbus	HART 2-wire, 4-20 mA loop HART 4-wire, 10.5 to 32 VDC HART 4-wire, 90 to 250 VAC 2-wire Profibus 2-wire Foundation Fieldbus	HART 4-wire, 10.5 to 32 VDC HART 4-wire, 90 to 250 VAC 2-wire Profibus 2-wire Foundation Fieldbus	HART 2-wire, 4-20 mA HART 4-wire, 10.5 to 32 VDC HART 4-wire, 90 to 250 VAC 2-wire Profibus 2-wire Foundation Fieldbus
Ambient temperature	-40 to +176°F	-40 to +176°F	-40 to +176°F	-40 to +176°F	-40 to +176°F
Process temperature	-40 to +176°F	-40 to +176°F	-40 to +176°F	-40 to +176°F	-40 to +176°F
Process pressure	10 to 44 psi	10 to 44 psi	10 to 36 psi	10 to 36 psi	10 to 36 psi
Grain size	Min. 0.16"	Min. 0.16"	Min. 0.16"	Min. 0.16"	Min. 0.16"
Process connections	1-1/2" NPT	2" NPT	3" or 4" universal flange FAU 20 mounting bracket	4" universal with slip-on flange	4" or 6" universal flange, 8" ANSI FAU 20 mounting bracket
Wetted material	PVDF	PVDF	PVDF	UP and 316 Ti SS	PP, PVDF and 316L SS
Operation	HART, VU 331 display module, ToF Tool software	HART, VU 331 display module, ToF Tool software	HART, VU 331 display module, ToF Tool software	HART, VU 331 display module, ToF Tool software	HART, VU 331 display module, ToF Tool software
Housing	Aluminum, Aluminum with separate connection compartment	Aluminum, Aluminum with separate connection compartment	Aluminum, Aluminum with separate connection compartment	Aluminum	Aluminum, Aluminum with separate connection compartment
Approvals / certificates	CE, FM, CSA	CE, FM, CSA	CE, FM, CSA	CE, FM, CSA	CE, FM, CSA



Prosonic T	
	FMU30
	
Application	Liquids, pastes, coarse bulk solids
Measurement type	Ultrasonic, continuous, non-contact for level, flow, or volume
Maximum measured range	1-1/2" sensor: Liquids, 16 ft; solids 6 ft 2" sensor: Liquids 26 ft; solids 11 ft
Output	4 to 20 mA
Power supply	14 to 35 VDC
Ambient temperature	-4 to +140°F
Process temperature	-4 to +140°F
Process pressure	10 to 43 psi
Process connections	1-1/2" NPT or 2" NPT UNI flange: 2", 3", 4"
Wetted material	Sensor, PP; matching layer, EPDM
Operation	LCD display, 3 pushbuttons
Housing	PBT
Approvals / certificates	CE, CSA general purpose

NOTE:
FMU30 replaces the FTU230
and FTU231







Prosonic S Sensors (for Prosonic S Transmitter)				
	FDU 90	FDU 91	FDU 91 F	FDU 92
				
Application	Liquids, solids	Liquids, solids	Liquids, solids, hygienic	Liquids, solids
Measurement type	Ultrasonic, continuous, non-contact	Ultrasonic, continuous, non-contact	Ultrasonic, continuous, non-contact	Ultrasonic, continuous, non-contact
Measured range	Liquids: 10 ft Solids: 4 ft	Liquids: 33 ft Solids: 16 ft	Liquids: 33 ft Solids: 16 ft	Liquids: 65 ft Solids: 33 ft
Output	Analog signal to transmitter	Analog signal to transmitter	Analog signal to transmitter	Analog signal to transmitter
Power supply	FMU 90 Prosonic transmitter	FMU 90 Prosonic transmitter	FMU 90 Prosonic transmitter	FMU 90 Prosonic transmitter
Process temperature	-40 to +176°F	-40 to +176°F	-40 to +221°F (up to 275°F for 30 min)	-40 to +203°F
Process pressure	10 to 58 psi	10 to 58 psi	10 to 58 psi	10 to 58 psi
Process connections	1" NPT	1" NPT	1" NPT, slip-on flange, Tri-clamp	1" NPT
Housing / wetted material	PVDF	PVDF	316L SS	PVDF
Ingress protection	NEMA 6P	NEMA 6P	NEMA 6P	NEMA 6P
Approvals / certificates	CE, FM, CSA	CE, FM, CSA	CE, FM, CSA, 3-A	CE, FM, CSA

Prosonic S Sensors (for Prosonic S Transmitter), continued		
	FDU 93	FDU 95
		
Application	Liquids, solids	Solids
Measurement type	Ultrasonic, continuous, non-contact	Ultrasonic, continuous, non-contact
Measured range	Liquids: 82 ft, solids: 50 ft	Solids: 148 ft
Output	Analog signal to transmitter	Analog signal to transmitter
Power supply	FMU 90 Prosonic transmitter	FMU 90 Prosonic transmitter
Process temperature	-40 to +203°F	-40 to +176°F (optional to 302°F)
Process pressure	10 to 43 psi	10 to 22 psi
Process connections	1" NPT	1" NPT
Housing / wetted material	UP, Al/PTFE	UP/PE (optional UP/VA)
Ingress protection	NEMA 6P	NEMA 6P
Approvals / certificates	CE, FM, CSA	CE, FM, CSA

Prosonic S Transmitter		
	FMU 90	FMU 95
		
Application	Level, flow, pump control, liquids or solids	Level control for silo or tank farms
Measurement type	Ultrasonic, continuous, non-contact	Ultrasonic, continuous, non-contact
Measured range	Dependent on FDU sensor (see sensors above)	Dependent on FDU sensor (see sensors above)
Input	From 1 or 2 FDU 90 series sensors	Up to 5 or 10 FDU 90 series sensors
Output	0/4 to 20 mA, HART, Profibus DP, up to 3 totalizers and up to 3 resettable counters. Up to 6 SPDT relays	Profibus DP
Power supply	90 to 253 VAC, 50/60 Hz 10.5 to 32 VDC	90 to 253 VAC, 50/60 Hz 10.5 to 32 VDC
Ambient temperature	-40 to +140°F	-40 to +140°F
Mounting	Wall mount field enclosure, panel mount, 19" rack mount	Wall mount field enclosure, panel mount, 19" rack mount
Housing	Field housing, PC; DIN rail housing, PBT	Field housing, PC; DIN rail housing, PBT
Operation	HART, Profibus-DP 6-line plain text LCD, 3 push button keys, indicator LEDs	Profibus-DP, or FieldCare programming 6-line plain text LCD, 3 push button keys, indicator LEDs
Approvals / certificates	CE, CSA general purpose	CE, CSA general purpose





Radiometric (Gamma)

Radiometric source container				
	FQG60 	FQG61/ FQG62 	FQG63 	FQG66 
Application	Solids, Liquids, Suspensions, Sludge	Solids, liquids, suspensions, sludge	Solids, Liquids, Suspensions, Sludge	Solids, liquids, suspensions, sludge
Measurement Type	Non-contact radioactive measurement for continuous level, limit or density	Non-contact radioactive measurement for continuous level, limit or density	Non-contact radioactive measurement for continuous level, limit or density	Non-contact radioactive measurement for continuous level, limit or density
Radiation angle of emission	20° or 40°	5°, 20° or 40°		20° or 40°
Width of emission channel	6°	6°		6°
Shield Material	Lead	Lead	Lead	Lead
Source Material	¹³⁷ Cs or ⁶⁰ Co	¹³⁷ Cs or ⁶⁰ Co	¹³⁷ Cs or ⁶⁰ Co	¹³⁷ Cs or ⁶⁰ Co
Container Weight	39.69 lbs	FQG61 manual: 88 lbs pneumatic: 110 lbs FQG62 manual: 192 lbs pneumatic: 215 lbs	194 lbs	959 lbs
Ambient temperature	-40°F to +248°F	-40°F to +392°F -4°F to +176°F with pneumatic actuator	-62°F to +392°F	-67°F to +212°F
Mounting	Mounting kit	Flange, 150 lb ANSI, 4" steel or stainless steel	Flange, 150 lb ANSI, 4"	Steel or stainless steel mounting plate
Housing	316L	Steel, 304 SS, optional 316Ti SS	316L	316 SS
ON / OFF switching	Manual, padlock for security	Manual, padlock for security Pneumatic, padlock for security	Manual, padlock for security	Manual, padlock for security
Approvals / certificates	CE, FM, CSA, SIL2/3 (for level limit)	PTB report, CNSC, NRC	CE, FM, CSA, SIL2/3 (for level limit)	PTB report

Radiometric measurement transmitter	
	Gammapirot® FMG50 
Application	Solids, liquids, suspensions, sludge
Measurement type	Non-contact radioactive measurement for continuous level, limit, density, concentration
Measured range	Up to 9.8 ft with a single FMG50
Output	4 to 20 mA with HART
Power supply	14 to 35 VDC
Ambient temperature	-40 to +170°F
Mounting	FHG51 mounting kit
Housing	Terminal head, aluminum or 316L SS; detector pipe, 316L SS
Weight	26 up to 62 lbs
Approvals / certificates	CE, CSA C/US, SIL 2/3

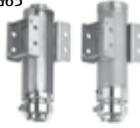
Radiometric measurement sensor and transmitter	
	Gammapirot M FTG20 
Application	Solids, Liquids, Suspensions, Sludge
Measurement type	Non-contact radioactive measurement for limit or density
Output	Relay, 8/16 mA (passive) or 4 to 20 mA output
Power supply	11 to 36 VDC, 11 to 30 VDC (Ex ia), 19 to 55 VDC or 19 to 253 VAC (50 to 60 Hz)
Ambient temperature	-40 to +158°F (-40 to +70°C) Aluminum housing, -40 to +158°F (-40 to +70°C) 316L housing, 32 to +248°F (0 to +120°C) with 316L and water cooling
Mounting	Mounting Set
Weight	17 lbs
Approvals / certificates	CE, FM, CSA, SIL2/3 (for level limit)

Gamma modulator	
	FHG65 
Application	Suppresses background and extraneous radiation from the FMG60 Gammapirot
Power supply	18 to 36 VDC
Ambient temperature	-4 to +140°F without water cooling, 32 to 248°F with water cooling, at the terminal housing, maximum 167°F
Mounting	Mounted to source container FQG61 or FQG62
Housing	304SS Water jacket, 316L SS and 304 SS
Weight	Without water jacket, 40 lbs With empty water jacket, 46 lbs With water jacket full, 55 lbs
Approvals / certificates	CE, FM, CSA





Synchronizer	
	FHG66 
Application	Used to synchronize two or three FHG65 modulators
Output	Floating changeover contact
Function indication	LEDs indicate operation, faults and error assignment
Power supply	18 to 36 VDC
Ambient temperature	-4 to +140°F
Mounting	DIN rail
Housing	Polycarbonate
Weight	0.3 lbs
Approvals / certificates	CE



Flow Products available from Endress+Hauser

Electromagnetic

FLOW

Sensors		Diameter	Measuring range	Pressure	Temperature (process)	
Electromagnetic (EMF) Proline	Promag® D Water/Waste water		1 to 4"	0 to 33 ft/s 0 to 1,250 gal/min	Cl 150 PN 16 JIS 10K	0 to +140°F
	Promag W Water/Waste water		1 to 120"	0 to 33 ft/s 0 to 900,690 gal/min	Cl 150 to 300, PN 6 to 40 JIS 10 to 20K, AWWA Class D AS Table E, PN 16	-4 to +194°F
	Promag P Chemical/Process applications		½ to 24"	0 to 33 ft/s 0 to 42,267 gal/min	Cl 150 to 300, PN 10 to 40 JIS 10 to 20K AS Table E, PN 16	-40 to +356°F
	Promag H Hygiene		½ to 6"	0 to 33 ft/s 0 to 2,650 gal/min	Cl 150, PN 16 to 40 JIS 10 to 20K	-4 to +302°F
	Promag S Inhomogeneous fluids High solid content		½ to 24"	0 to 33 ft/s 0 to 42,267 gal/min	Cl 150 to 300, PN 10 to 40 JIS 10 to 20K AS Table E, PN 16	-40 to +356°F

Transmitters	Combinable with	Housing	Display/Operation	Temperature (Ambient)	Power supply
100 Compact design	Sensor P, H	Compact SS Compact Alu Ultra Compact SS	Optional no-button display Operation via web server, FieldCare/DeviceCare or HART	-40 to +140°F	DC 20 to 30 V
200 Two-wire	Sensor P, H	Compact Alu	Four-line LCD/Push buttons or Touch control Operation via FieldCare/DeviceCare	-40 to +140°F	Two-wire DC 18 to 30 V
300 Compact Universal use	Sensor P, H	Aluminum Hygienic SS	Four-line, backlit LCD/Touch control. Operation via web server, WLAN, and various operating tools (FieldCare, HART handheld, etc.)	-40 to +140°F	AC 100 to 230 V, DC 24 V (Zone 1, Div. 1) AC/DC 24 to 230 V (Zone 2, Div. 2, Non-Ex)
400 Water Waste water	Sensor D, L, W	Compact/Remote Polycarbonate	Four-line, backlit LCD/Touch control Operation via FieldCare/DeviceCare or web-server	-4 to +122°F	AC 90 to 264 V (47 to 63 Hz) AC 18 to 30 V (44 to 66 Hz) DC 18 to 30 V
500 Remote Universal use	Sensor P, H, W	Aluminum, poly-carbonate, SS die-cast	Four-line, backlit LCD/Touch control. Operation via web server, WLAN, and various operating tools (FieldCare, HART handheld, etc.)	-40 to +140°F Optional: -58 to +140°F	AC 100 to 230 V, DC 24 V (Zone 1, Div. 1) AC/DC 24 to 230 V (Zone 2, Div. 2, Non-Ex)
10 Basic	Sensor D, L, W, P, H	Compact Alu Remote Alu	Two-line LCD/Push buttons Operation via FieldCare/DeviceCare	-4 to +140°F	AC 85 to 250 V (45 to 65 Hz) AC 20 to 28 V (45 to 65 Hz) DC 11 to 40 V
55 Special applications	Sensor S, H	Compact SS Compact Alu Remote Alu	Four-line, backlit LCD/Touch control Operation via FieldCare/DeviceCare	-4 to +122°F Optional: -40 to +122°F	AC 20 to 260 V (45 to 65 Hz) DC 20 to 64 V
800 Battery-powered	Sensor W	Compact/Remote Polycarbonate	Eight-line LCD/Push buttons Operation via Config 5800 or GSM and GPSR	-4 to +140°F	Battery operation: DC 3.6 V Mains: AC 100 to 240 V (44 to 66 Hz), DC 12 to 60 V

*50/53 transmitters phased out. Spare parts available until 12/31/2024.
*50D sensor phased out 10/1/16. 50L sensor phased out 10/1/17.
*51P / 51W sensor phased out 10/1/17. 53L sensor phased out 10/1/17.













Materials (wetted parts)	Process connection	Protection	Approval/Certification	Measuring uncertainty ¹⁾ (best possible "accuracy")
Polyamid liner	Wafer: EN (DIN), ASME, JIS	NEMA 4X (IP67)	Drinking water	Liquids: ±0.5%
PTFE liner Hard rubber liner Polyurethane liner	Lap-joint flange (DN ≤ 300): EN (DIN), ASME; Welded flange (DN ≥ 350): EN (DIN), ASME, AWWA, AS	NEMA 4X/6P (IP67/IP68)	Drinking water; custody transfer; marine approvals; PED, CRN; certified corrosion resistance (EN ISO 12944)	Liquids: ±0.2%
PFA liner PTFE liner	Flange: EN (DIN), ASME, JIS, AS	NEMA 4X/6P (IP67/IP68)	Drinking water; custody transfer; marine approvals; PED, CRN	Liquids: ±0.2%
PFA liner	Flange: EN (DIN), ASME, JIS; external thread, internal thread, weld connection, clamp connection, couplings	NEMA 4X (IP67)	3A, EHEDG, FDA; marine approvals; PED, CRN	Liquids: ±0.2%
PTFE, PFA, Polyurethane liner Natural rubber liner Hard rubber liner	Flange: EN (DIN), ASME, JIS, AS	NEMA 4X/6P (IP67/IP68)	PED, CRN	Liquids: ±0.2%

Galvanic isolation	Inputs	Outputs	Communication	Ex approvals	Protection
Inputs/Outputs/ Power supply	-	4-20 mA, pulse/frequency/switch output	HART, integrated web server and service interface via RJ45 Ethernet PROFIBUS DP, PROFINET® Modbus RS485, EtherNet/IP™	ATEX, IECEx, cCSAus	NEMA 4X (IP66 and IP67) Optional: IP69 (exceeds NEMA 4X PW12)
Inputs/Outputs	-	4-20 mA, pulse/frequency/switch output	HART, FOUNDATION Fieldbus PROFIBUS PA	ATEX, IECEx, cCSAus	NEMA 4X (IP66 and IP67)
Inputs/Outputs/ Power supply	Status input, current input (4-20 mA); Optional: freely configurable I/Os	4-20 mA, pulse/frequency/switch output, relays; Optional: freely configurable I/Os	HART, PROFIBUS PA, Modbus RS485, FOUNDATION Fieldbus, EtherNet/IP, PROFINET	cCSAus, ATEX, NEPSI, INMETRO, EAC, etc.	Type 4X (IP66/67) Optional: IP69 (stainless steel)
Inputs/Outputs/ Power supply	Status input	0/4-20 mA, pulse/frequency/switch output	HART, integrated web server and service interface via RJ45 Ethernet EtherNet/IP, Modbus RS485 PROFIBUS DP	cCSAus (Cl. I Div. 2)	NEMA 4X (IP66 and IP67)
Inputs/Outputs/ Power supply	Status input, current input (4-20 mA); Optional: freely configurable I/Os	Max. 4 outputs ("digital" version): 4-20 mA, pulse/frequency/switch output, relays; Optional: freely configurable I/Os	HART, PROFIBUS PA, Modbus RS485, FOUNDATION Fieldbus, EtherNet/IP, PROFINET	cCSAus, ATEX, NEPSI, INMETRO, EAC, etc.	Type 4X (IP66/67) Optional: IP69K (stainless steel)
Inputs/Outputs/ Power supply	-	4-20 mA, pulse/switch output	HART	FM, CSA Div. 2	NEMA 4X (IP67)
Inputs/Outputs/ Power supply	Status input, current input 4-20 mA	0/4-20 mA, pulse/frequency (10 kHz, active/passive), relays, switch output	HART, PROFIBUS DP, PROFIBUS PA FOUNDATION Fieldbus	FM, CSA Div. 2, IECEx Zone 2	NEMA 4X (IP67)
Inputs/Outputs/ Power supply	Status input	Pulse/switch output	4-band GSM/GPRS modem for data transmission via e-mail or SMS	-	NEMA 4X (IP67)

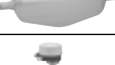

Coriolis

Sensors

		Diameter	Measuring range	Pressure	Temperature (process)	
Coriolis Proline	Promass® F Universal flowmeter		3/8 to 10" HT: 1", 2", 3"	0 to 80,840 lb/min	CI 150 to 600 PN 16 to 100 JIS 10 to 63K	-58 to +302°F Optional: -58 to +464°F HT: -58 to +662°F
	Promass A Low flow rates		1/24 to 1/8"	0 to 16.5 lb/min	CI 150 to 600 PN 16 to 400 JIS 10 to 63K	-58 to +401°F
	Promass I Hygiene, viscosity		3/8 to 3"	0 to 6,600 lb/min	CI 150 to 600 PN 40 to 100 JIS 10 to 63K	-58 to +302°F
	Promass H Chemically aggressive fluids		3/8 to 2"	0 to 2,570 lb/min	CI 150 to 300 PN 40 JIS 10 to 20K	-58 to +401°F (Zr) -58 to +302°F (Ta)
	Promass E Basic applications		3/8 to 3"	0 to 6,600 lb/min	CI 150 to 600 PN 40 to 100 JIS 10 to 63K	-40 to +302°F
	Promass S Food & Beverages		3/8 to 2"	0 to 2,570 lb/min	CI 150 to 300 PN 40 to 63 JIS 10 to 40K	-58 to +302°F
	Promass P Life Sciences Industries (Pharma, biotechnology)		3/8 to 2"	0 to 2,570 lb/min	CI 150 to 300 PN 40 to 63 JIS 20 to 40K	-58 to +302°F Optional: -58 to +401°F
	Promass Q Challenging applications Fiscal metering		1 to 4"	0 to 20,210 lb/min	CI 150 to 600 PN 16 to 100 JIS 10 to 63K	-58 to +401°F Opt: -320.8 to +302°F (low-temperature version)
	Promass G High pressures		3/8 to 1"	0 to 661 lb/min	5,080 psi	-58 to +302°F
	Promass O High pressures Oil and gas industry		3 to 10"	0 to 80,840 lb/min	CI 900, CI 1500 PN 160, PN 250	-40 to +401°F
	Promass X High flow rates Oil and gas industry		12 to 16"	0 to 150,649 lb/min	CI 150 to 600 PN 10 to 100	-58 to +356°F
	Cubemass C Low flow rates Compact design		1/24 to 1/4"	0 to 37 lb/min	2,320/5,800 psig	-58 to +401°F

Transmitters

	Combinable with	Housing	Display/Operation	Temperature (Ambient)	Power supply
100 Compact design	Sensor A, F, G, H, I, E, S, P, C, O, X	Compact SS Compact Alu Ultra compact SS	Optional no-button display Operation via web server, FieldCare/DeviceCare or HART	-40 to +140°F	DC 20 to 30 V
200 Two-wire	Sensor E, F	Compact Alu Compact SS	Four-line LCD/Push buttons or Touch control Operation via FieldCare/DeviceCare	-4 to +140°F	Two-wire DC 18 to 30 V
300 Compact Universal use	Sensor F, E, A, I, Q, S, P, H, O, X Cubemass C	Aluminum SS die-cast Hygienic SS	Four-line, backlit LCD/Touch control. Operation via web server, WLAN, and various operating tools (FieldCare, HART handheld, etc.)	-40 to +140°F Optional: -58 to +140°F	AC 100 to 230 V, DC 24 V (Zone 1, Div. 1) AC/DC 24 to 230 V (Zone 2, Div. 2, Non-Ex)
500 Remote Universal use	Sensor F, E, A, I, Q, S, P, H, O, X Cubemass C	Aluminum, polycarbonate, SS die-cast	Four-line, backlit LCD/Touch control. Operation via web server, WLAN, and various operating tools (FieldCare, HART handheld, etc.)	-40 to +140°F Optional: -76 to +140°F	AC 100 to 230 V, DC 24 V (Zone 1, Div. 1) AC/DC 24 to 230 V (Zone 2, Div. 2, Non-Ex)
40 Basic	Sensor E	Compact Alu	Two-line, backlit LCD Operation via HART or FieldCare/DeviceCare	-4 to +140°F Optional: -40 to +140°F	AC 85 to 260 V (45 to 65 Hz) AC 20 to 55 V (45 to 65 Hz) DC 16 to 62 V

*80/83/84 transmitters are in phase out. Spare parts available until 12/31/2024.











Materials (wetted parts)	Process connection	Protection	Approval/Certification	Measuring uncertainty ¹⁾ (best possible „accuracy“)
Measuring tube: 904L (1.4539), 316/316L (1.4404), Alloy C-22 (2.4602); Connection: 316/316L (1.4404), Alloy C-22 (2.4602)	Flange: EN (DIN), ASME, JIS Tri-Clamp, couplings, lap joint flanges, VCO	NEMA 4X (IP67)	SIL 2/3; 3A, EHEDG; PED, CRN, AD 2000; marine approvals	Liquids: ±0.10% (±0.05% PremiumCal) Gases: ±0.35%
Measuring tube: 904L (1.4539), Alloy C-22 (2.4602); Connection: 904L (1.4539), Alloy C-22 (2.4602), 316/316L (1.4404)	Tri-Clamp, VCO	NEMA 4X (IP67)	SIL 2; 3A, EHEDG; PED, CRN	Liquids: ±0.10% Gases: ±0.50%
Measuring tube: Titanium grade 9 Connection: Titanium grade 2	Flange: EN (DIN), ASME, JIS Tri-Clamp, couplings	NEMA 4X (IP67)	SIL 2; 3A, EHEDG; PED, CRN	Liquids: ±0.10% Gases: ±0.50%
Measuring tube: Zirconium 702/R 60702, Tantalum 2.5W; Connection: Tantalum, Zirconium 702/R 60702	Flange: EN (DIN), ASME, JIS	NEMA 4X (IP67)	SIL 2; PED, CRN	Liquids: ±0.10% Gases: ±0.50%
Measuring tube: 904L (1.4539) Connection: 316/316L (1.4404)	Flange: EN (DIN), ASME, JIS Tri-Clamp, couplings, VCO	NEMA 4X (IP67)	SIL 2; 3A; PED, CRN; marine approvals	Liquids: ±0.15% (Optional: ±0.10%) Gases: ±0.75%
Measuring tube: 316L (1.4539) Connection: 316L (1.4435), 316/316L (1.4404)	Flange: EN (DIN), ASME, JIS Tri-Clamp, couplings	NEMA 4X (IP67)	SIL 2; 3A, EHEDG, FDA; PED, CRN	Liquids: ±0.10% Gases: ±0.50%
Measuring tube: 316L (1.4435) Connection: 316L (1.4435), 316/316L (1.4404)	Flange: EN (DIN), ASME, JIS Hygienic clamps, couplings and flanges	NEMA 4X (IP67)	3A, EHEDG, FDA; ASME BPE, ISPE; SIL 2; PED, CRN	Liquids: ±0.10% Gases: ±0.50%
Measuring tube: 316/316L (1.4404) Connection: 316/316L (1.4404)	Flange: ASME, JIS, EN (DIN)	Type 4X (IP66/67)	Custody transfer; SIL 2/3; PED, CRN; NACE MR0175/MR0103	Liquid: ±0.10% (±0.05% PremiumCal) Gas: ±0.35%
Measuring tube: 316L (1.4435) Connection: 316/316L (1.4404)	Cylindrical internal thread BSPP (G)	Type 4X (IP66/67)	CRN	Liquid: ±0.15% Gas: ±0.75%
Measuring tube: 25Cr duplex (1.4410) Connection: 25Cr duplex (1.4410)	Flange: EN (DIN), ASME	NEMA 4X (IP67)	Custody transfer; SIL 2; PED, CRN, AD 2000; Materials conforms to NORSOK M-630, NACE MR175/MR103	Liquids: ±0.10% (±0.05% PremiumCal) Gases: ±0.35%
Measuring tube: 316/316L (1.4404) Connection: 316/316L (1.4404)	Flange: EN (DIN), ASME	NEMA 4X (IP67)	Custody transfer; marine approvals; PED, CRN; Materials conforms to NORSOK M-630, NACE MR175/MR103	Liquids: ±0.10% (±0.05% PremiumCal) Gases: ±0.35%
Measuring tube: 904L (1.4539) Connection: 904L (1.4539), 316/316L (1.4404)	VCO	NEMA 4X (IP67)	SIL 2/3; CRN	Liquid: ±0.10% Gas: ±0.50%

Galvanic isolation	Inputs	Outputs	Communication	Ex approvals	Protection
Inputs/Outputs/ Power supply	-	4-20 mA, pulse/frequency/switch output	HART, integrated web server and service interface via RJ45 Ethernet PROFIBUS DP, PROFINET® Modbus RS485, EtherNet/IP™	ATEX, IECEx, cCSAus (Modbus only)	NEMA 4X (IP66 and IP67) Optional: IP69 (exceeds NEMA 4X PW12)
Inputs/Outputs	-	4-20 mA, pulse/frequency/switch output	HART, FOUNDATION Fieldbus PROFIBUS PA	ATEX, IECEx, cCSAus	NEMA 4X (IP66 and IP67)
Inputs/Outputs/ Power supply	Status input, current input (4-20 mA); Optional: freely configurable I/Os	4-20 mA, pulse/frequency/switch output, relays; Optional: freely configurable I/Os	HART, PROFIBUS PA, Modbus RS485, FOUNDATION Fieldbus, EtherNet/IP, PROFINET	cCSAus, ATEX, NEPSI, INMETRO, EAC, etc.	IP66/67 (Type 4X) Optional: IP69 (stainless steel)
Inputs/Outputs/ Power supply	Status input, current input (4-20 mA); Option: freely configurable I/Os	Max. 4 outputs ("digital" version); 4-20 mA, pulse/frequency/switch output, relays; Optional: freely configurable I/Os	HART, PROFIBUS PA, Modbus RS485, FOUNDATION Fieldbus, EtherNet/IP, PROFINET	cCSAus, ATEX, NEPSI, INMETRO, EAC, etc.	IP66/67 (Type 4X) Optional: IP69 (stainless steel)
Inputs/Outputs/ Power supply	Status input	0/4-20 mA, frequency/switch output	HART	ATEX, IECEx, FM, CSA, TIIS, NEPSI	NEMA 4X (IP67)



Ultrasonic

FLOW

Sensors		Diameter	Measuring range	Pressure	Temperature (process)	
Ultrasonic Proline	Prosonic Flow W Clamp-on sensor Standard applications		½ to 160"	0 to 50 ft/s 0 to 2,987,656 gal/min	No limit Non-invasive	-4 to +176 °F Optional: 32 to 266 °F
	Prosonic Flow W Insertion sensor Standard applications		8 to 160"	0 to 50 ft/s 0 to 2,987,656 gal/min	232 psig	-4 to +176 °F
	Prosonic Flow E Bidirectional measuring Utilities applications		2" to 6"	0.02 to 16.4 ft/s 0 to 1680 gal/min	CI 150 PN 40	17.8 to 302 °F
	Prosonic Flow P Clamp-on sensor Process applications		½ to 160"	0 to 50 ft/s 0 to 2,987,656 gal/min	No limit Non-invasive	-40 to +176 °F Optional: 32 to 338 °F
	Prosonic Flow F Inline sensor Chemical industry		1 to 12"	0 to 33 ft/s 0 to 10,567 gal/min	CI 300 PN 40	-40 to +302 °F Optional: -40 to +392 °F
	Prosonic Flow B Methane/Biogas measurement		2 to 8"	0 to 98 ft/s	159 psia	32 to 176 °F
	Prosonic Flow C Inline sensor Water/Waste water		12 to 78"	0 to 33 ft/sec 0 to 484,315 gal/min	CI 150 PN 16	-4 to +140 °F
	Prosonic Flow G Natural/process gas measurement		1 to 12"	1 to 130 ft/sec	CI 600	-60 to +320 °F

Transmitters	Combinable with	Housing	Display/Operation	Temperature (Ambient)	Power supply
91 Basic	Sensor W	Remote Alu	Two-line LCD/Push buttons Operation via FieldCare/DeviceCare	-4 to +140°F	AC 85 to 250 V (45 to 65 Hz) AC 20 to 28 V (45 to 65 Hz) DC 11 to 40 V
93 High-end	Sensor W, P, C	Remote Alu	Four-line, backlit LCD/Touch control Operation via FieldCare/DeviceCare	-4 to +140°F Optional: -40 to +140°F	AC 85 to 260 V (45 to 65 Hz) AC 20 to 55 V (45 to 65 Hz) DC 16 to 62 V
93 T Portable	Sensor P	Portable Plastic	Four-line, backlit LCD/Touch control Operation via FieldCare/DeviceCare	0 to +140°F	Rechargeable battery + charger: AC 100 to 240 V (47 to 63 Hz)
92 Inline	Sensor F	Compact Alu Remote Alu	Two-line LCD/Push buttons Operation via FieldCare/DeviceCare	Compact: -40 to +140°F Remote: -40 to +176°F	Two-wire DC 12 to 35 V
100 Bidirectional	Sensor E	Compact SS	Four-line backlit LCD available (no local operation) Operation via web browser and operating tools possible	-4 to +140°F	DC 19.2 to 28.8 V
200 Two-wire	Sensor B	Compact Alu Compact SS	Four-line LCD/Push buttons or Touch control Operation via FieldCare/DeviceCare	-40 to +140°F	Two-wire DC 18 to 30 V
300 Compact universal use	Sensor G	Aluminum, SS die-cast	Four-line, backlit LCD/Touch control. Operation via web server, WLAN, and various operating tools (FieldCare, HART handheld, etc.)	-40 to +140°F Optional: -58 to +140°F	AC 100 to 230 V, DC 24V (Zone 1, Div. 1) AC/DC 24 to 230 V (Zone 2, Div. 2, Non-Ex)
500 Compact universal use	Sensor G	Aluminum, polycarbonate	Four-line, backlit LCD/Touch control. Operation via web server, WLAN, and various operating tools (FieldCare, HART handheld, etc.)	-40 to +140°F Optional: -58 to +140°F	AC 100 to 230 V, DC 24V (Zone 1, Div. 1) AC/DC 24 to 230 V (Zone 2, Div. 2, Non-Ex)







Materials (wetted parts)	Process connection	Protection	Approval/Certification	Measuring uncertainty ¹⁾ (best possible "accuracy")
Not wetted (Clamp-on sensor)	Clamp-on sensor	NEMA 4X/6P (IP67/IP68)	Marine approvals	Liquids: <2.0% (onsite) ±0.5% (under reference conditions)
316L (1.4404)	Welding connector	NEMA 6P (IP68)	-	Liquids: <2.0% (onsite) ±0.5% (under reference conditions)
<ul style="list-style-type: none"> ■ Measuring tube: 1.4301 (F304) ■ Process Connection: 1.4571; 1.4404 (F316L); 1.0038 (S235JR); 1.4306 (F304L); 1.4307 (F304L); A105 	Flange: EN, ASME	NEMA 4X (IP66/67)	PED	±0.5% (under reference conditions)
Not wetted (Clamp-on sensor)	Clamp-on sensor	NEMA 4X/6P (IP67/IP68)	Marine approvals	Liquids: <2.0% (onsite) ±0.5% (under reference conditions)
CF3M/316/316L A105/A106/316/316L	Flange: EN (DIN), ASME, JIS	NEMA 4X/6P (IP67/IP68)	Marine approvals; PED, CRN, AD 2000; NACE MR175/MR103	Liquids: ±0.5% (2 or 3 beams) ±0.3% (4 beams)
316L (1.4404)	Flange: EN (DIN), ASME	NEMA 4X (IP66/67)	PED	Gases: ±1.5% Methane content: ±2.0% o.f.s
Carbon steel, epoxy coated	Flange: EN (DIN), ASME, AWWA	NEMA 6P (IP68)	Drinking water	Liquids: ±0.5%

Galvanic isolation	Inputs	Outputs	Communication	Ex approvals	Protection
Inputs/Outputs/ Power supply	-	0/4-20 mA, pulse/switch output	HART	FM, CSA Div. 2	NEMA 4X (IP67)
Inputs/Outputs/ Power supply	Status input, current input 4-20 mA	0/4-20 mA, pulse/frequency (10 kHz, active/passive), relays, switch output	HART, PROFIBUS DP, PROFIBUS PA, FOUNDATION Fieldbus	ATEX, IECEx, FM, CSA, TIIS, NEPSI	NEMA 4X (IP67)
Inputs/Outputs/ Power supply	Current input 4-20 mA	Data logger	-	-	-
Inputs/Outputs	-	4-20 mA, pulse/switch output	HART, PFM, PROFIBUS PA, FOUNDATION Fieldbus	ATEX, IECEx, FM, CSA, TIIS, NEPSI	NEMA 4X (IP67)
Inputs/Outputs/ Power supply	-	4-20 mA HART, pulse/frequency/switch output (passive)	HART	-	NEMA 4X (IP66/67)
Inputs/Outputs	-	4-20 mA pulse frequency/ switch output	HART	ATEX, IECEx, cCSAus	NEMA 4X (IP66/67)
Inputs/Outputs/ Power supply	Status input, current input (4-20 mA); Option: freely configurable I/Os	4-20 mA, pulse/frequency/switch output, relays; Optional: freely configurable I/Os	HART, Modbus RS485	cCSAus, ATEX, NEPSI, INMETRO, EAC, etc.	IP66/67 (Type 4X)
Inputs/Outputs/ Power supply	Status input, current input (4-20 mA); Option: freely configurable I/Os	4-20 mA, pulse/frequency/switch output, relays; Optional: freely configurable I/Os	HART, Modbus RS485	cCSAus, ATEX, NEPSI, INMETRO, EAC, etc.	IP66/67 (Type 4X)



Sensors

			Diameter	Measuring range	Pressure	Temperature (process)
Vortex Proline	Prowirl® F Flanged version		½ to 12"	Liquid: 0.09 to 1,420 ft³/min Steam, gas: 1.18 to 18,932 ft³/min	Cl 150 to 600 PN 10 to 250 JIS 10 to 40K	-328 to +752°F Optional: -328 to +842°F
	Prowirl D Wafer version		½ to 6"	Liquid: 0.09 to 368 ft³/min Steam, gas: 1.18 to 4,910 ft³/min	Cl 150 to 300 PN 10 to 40 JIS 10 to 20K	-328 to +752°F Optional: -328 to +842°F
	Prowirl R For low flows		1 to 10"	Liquid: 0.15 to 321 ft³/min Steam, gas: 2.12 to 4,274 ft³/min	Cl 150 to 300 PN 10 to 40 JIS 10 to 20K	-328 to +752°F Optional: -328 to +842°F
	Prowirl O High pressures		½ to 12"	Liquid: 0.09 to 321 ft³/min Steam, gas: 1.18 to 4,274 ft³/min	Cl 900 to 1500 PN 63 to 250 JIS 40K	-328 to +752°F Optional: -328 to +842°F
	Prowirl C Carbon steel		2 to 6"	Liquid: 0.58 to 321 ft³/min Gas: 8.12 to 4,274 ft³/min	Cl 600 to 900	-40 to 752°F

Transmitters





	Combinable with	Housing	Display/Operation	Temperature (Ambient)	Power supply
200 Standard	Sensor D, F, R, O, C	Compact Alu Compact SS	Four-line LCD/Push buttons or Touch Control Operation via FieldCare/DeviceCare Four-line/Illuminated	Compact: -40 to +176°F Remote: -40 to +185°F Optional: from -58°	Two-wire DC12 to 35V

Materials (wetted parts)	Process connection	Protection	Approval/Certification	Measuring uncertainty ¹⁾ (best possible „accuracy“)
Meter body: CF3M (1.4404), Alloy C-22 (2.4602) DSC sensor: 316L (1.4435), Inconel 718, Alloy C-22 (2.4602), Titanium Gr. 5	Flange: EN (DIN), ASME, JIS Optional: with integrated line size reduction	NEMA 4X (IP67)	Marine approvals; PED, CRN; SIL 1 (Prowirl 73), SIL 2 (Prowirl 72); degreased acc. to BS-IEC-60877:1999	Liquids: ±0.75% Vol. Gases/steam: ±1.0% Vol.
Meter body: CF3M (1.4404) DSC sensor: 316L (1.4435), Alloy C-22 (2.4602)	Wafer: EN (DIN), ASME, JIS	NEMA 4X (IP67)	Marine approvals; PED, CRN, AD 2000; SIL 1 (Prowirl 73), SIL 2 (Prowirl 72); degreased acc. to BS-IEC-60877:1999	Liquids: ±0.75% vol; ±1.0% mass Steam/Gas: ±1.0% vol; ±1.7% mass
Meter body: CF3M (1.4408) DSC sensor: 316/316L (1.4435) Connection: F316/F316L (1.4404)	Flange: EN (DIN), ASME, JIS	NEMA 4X (IP66/67)	3.1 material; NAMUR; SIL 2/3; PED, CRN, AD2000; degreased acc. to BSIEC-60877:1999; NACE MR0175/MR0103; welding test acc. to ISO 15614-1	Liquids: ±0.75% vol; ±0.85% mass Steam/Gas: ±1.0% vol; ±1.7% mass
Meter body: CF3M (1.4408), 1.4571 DSC sensor: UNS N07718, Alloy 718, Titanium Grade 5; Connection: 1.4408 CF3M, (1.4571), F316/F316L	Flange: EN (DIN), ASME, JIS	NEMA 4X (IP66/67)	3.1 material; NAMUR; SIL 2/3; PED, CRN, AD2000; degreased acc. to BSIEC-60877:1999; NACE MR0175/MR0103; welding test acc. to ISO 15614-1	Liquids: ±0.75% vol; ±0.85% mass Steam/Gas: ±1.0% vol; ±1.7% mass
Meter body: Carbon Steel DSC sensor: Alloy 718	Flange: ASME	NEMA 4X (IP67)	IS, XP, NI, SIL, CRN, NACE MR0175, 3.1 Material, EN10204-2.1, EN10204-2.2	Liquids: ±0.75% vol; ±0.85% mass Steam/Gas: ±1.0% vol; ±1.7% mass

Galvanic isolation	Inputs	Outputs	Communication	Ex approvals	Protection
Inputs/Outputs	Current input 4-20 mA	4-20 mA, pulse/frequency/switch output	HART, PROFIBUS PA, FOUNDATION Fieldbus	ATEX, IECEx, cCSAus, NEPSI, IMMETRO, TIIS (in prep)	NEMA 4X (IP66/67)



Sensors

			Diameter	Measuring range	Pressure	Temperature (process)
Thermal Proline	t-mass A Flanges/External threads Basic applications		½ to 2"	Gas and process condition dependent	-7.25 to 580 psig	-40 to +212°F
	t-mass B Insertion sensor Basic applications		3 to 60"	Gas and process condition dependent	-7.25 to 290 psig	-40 to +212°F
	t-mass T Insertion sensor Liquid monitoring		1½ to 40"	1 to 62,200 gal/min	580 psig	-4 to +212°F SIP: 266°F
	t-mass F Flanged version High-End		1/2 to 4"	Gas and process condition dependent	CL 150 to 300 PN 16 to 40	-40 to +356°F
	t-mass I Insertion sensor High-End		3 to 60"	Gas and process condition dependent	290 psig	-40 to +356°F

Transmitters







	Combinable with	Housing	Display/Operation	Temperature (Ambient)	Power supply
150 Basic	Sensor A, B, T	Compact Alu	Four-line LCD/Push buttons Operation via FieldCare/DeviceCare, HART or service interface (CDI)	-40 to +140°F	DC 18 to 30 V
300 Compact universal use	Sensor F, I	Aluminum	Four-line, backlit LCD/Touch control. Operation via web server, WLAN, and various operating tools (FieldCare, HART handheld, etc.)	-40 to +140°F Optional: -58 to +140°F	AC 100 to 230 V, DC 24V (Zone 1, Div. 1) AC/DC 24 to 230 V (Zone 2, Div. 2, Non-Ex)
500 Compact universal use	Sensor F, I	Aluminum, polycarbonate	Four-line, backlit LCD/Touch control. Operation via web server, WLAN, and various operating tools (FieldCare, HART handheld, etc.)	-40 to +140°F Optional: -58 to +140°F	AC 100 to 230 V, DC 24V (Zone 1, Div. 1) AC/DC 24 to 230 V (Zone 2, Div. 2, Non-Ex)



Materials (wetted parts)	Process connection	Protection	Approval/Certification	Measuring uncertainty ¹⁾ (best possible „accuracy“)
316L (1.4404)	Lap-joint flange, flange: EN (DIN), ASME R external thread (EN) NPT external thread (ASME)	NEMA 4X (IP66 and IP67)	PED	Gases: ±3% o.r. (15 to 100% o.f.s.) ±0.45% o.f.s. (1 to 15% o.f.s.)
316L (1.4404)	Thread: G1A, G¾A 1" NPT, ¾" NPT	NEMA 4X (IP66 and IP67)	PED	Gases: ±3% o.r. (15 to 100% o.f.s.) ±0.45% o.f.s. (1 to 15% o.f.s.)
316/316L (1.4404) Alloy C22	Standard: G¾" A, ¾" NPT Hygienic: Tri-Clamp, DIN 11851, DIN 11864-1 Form A	NEMA 4X (IP66/67)	3.1 material; CRN; 3A, EHEDG	Liquid: ±5% o.f.s.
316L (1.4404) Alloy C-22	Flange: EN (DIN), ASME, JIS	NEMA 4X/6P (IP67/IP68)	PED, NACE, degreased acc. To IEC/TR 60877 and BOC 50000810-4	Gases: ±1.0% o.r. (10 to 100% o.f.s.) ±0.10% o.f.s. (1 to 10% o.f.s.)
316L (1.4404) Alloy C-22	Thread: ¾" NPT, 1" NPT, G¾" G1"	NEMA 4X/6P (IP67/IP68)	PED, NACE, degreased acc. To IEC/TR 60877 and BOC 50000810-4	Gases: ±1.0% o.r. (10 to 100% o.f.s.) ±0.10% o.f.s. (1 to 10% o.f.s.)

Galvanic isolation	Inputs	Outputs	Communication	Ex approvals	Protection
Outputs/ Power supply	-	0/4-20 mA, pulse/frequency/ switch output	HART	cCSAus (Cl. I Div. 2)	NEMA 4X (IP66 and IP67)
Inputs/Outputs/ Power supply	Status input, current input (4-20 mA); Option: freely configurable I/O's	4-20 mA, pulse/frequency/switch output, relays; Optional: freely configurable I/O's	HART, Modbus RS485	cCSAus, ATEX, NEPSI, INMETRO, EAC, etc.	IP66/67 (Type 4X)
Inputs/Outputs/ Power supply	Status input, current input (4-20 mA); Option: freely configurable I/O's	4-20 mA, pulse/frequency/switch output, relays; Optional: freely configurable I/O's	HART, Modbus RS485	cCSAus, ATEX, NEPSI, INMETRO, EAC, etc.	IP66/67 (Type 4X)



Sensors		Diameter	Measuring range	Pressure	Temperature (process)	
EMF	Dosimag® Filling/bottling Conductive liquids		DN 4 (3/32"), 8 (5/16"), 15 (1/2"), 25 (1")	0.033 to 33 ft/s 0 to 26.4 gpm	232 psi	-4 to +266°F
	Dosimass Filling/bottling Liquids		3/8", 1/2", 1"	0 to 660 lbs/min	580 psi	-40 to +257°F
Coriolis	CNGmass Compressed Natural Gas Fueling		3/8", 1/2", 1"	0 to 330 lb/min	max. 5,080 psi	-58 to +257°F
	CNGmass DCI Compressed Natural Gas Fueling		3/8", 1/2", 1"	0 to 330 lb/min	max. 5,080 psi	-58 to +302°F
	LPGmass Liquified Petroleum Gas Fueling		3/8", 1/2", 1", 1 1/2"	0 to 1,650 lb/min	Cl 150 to 300 PN 40 JIS 10 to 63K	-40 to +257°F
	LNGmass Liquified Natural Gas Fueling		3/8", 1/2", 1"	0 to 660 lb/min	Cl 300 PN 40	-320 to +257°F





Transmitters	Housing	Display/Operation	Temperature (Ambient)	Power supply
Dosimag Compact version	Compact SS	Operation via FieldCare/DeviceCare	-4 to +140°F	DC 20 to 30 V
Dosimass Compact version	Compact SS	Operation via FieldCare/DeviceCare	-4 to +140°F	DC 20 to 30 V
CNGmass Compact version Custody transfer	Compact Alu	Operation via FieldCare/DeviceCare	-40 to +140°F	AC 20 to 28 V DC 10 to 30 V
CNGmass DCI Compact/remote version Custody transfer	Compact SS Compact Alu Remote Alu	Four-line, backlit LCD/Touch control Operation via FieldCare/DeviceCare	-40 to +140°F	AC 85 to 260 V (45 to 65 Hz) AC 20 to 55 V (45 to 65 Hz) DC 16 to 62 V
LPGmass Compact version Custody transfer	Compact Alu	Operation via FieldCare/DeviceCare	-40 to +140°F	AC 20 to 28 V DC 10 to 30 V
LNGmass Compact version	Compact Alu	Operation via FieldCare/DeviceCare	-40 to +140°F	DC 20 to 30 V



Materials (wetted parts)	Process connection	Protection	Approval/Certification	Measuring uncertainty ¹⁾ (best possible "accuracy")
PFA liner	Tri-Clamp, weld connection	NEMA 4X (IP67)	3A, EHEDG, FDA; PED, CRN, METAS	±0.5% Optional: ±0.25%
904L (1.4539) 316L (1.4404)	Tri-Clamp, couplings	NEMA 4X (IP67)	3A; PED, CRN	±0.15%
316L (1.4404) 316L (1.4435)	Internal thread: G½" (DN 8), G¾" (DN 15) G1" (DN 25)	NEMA 4X (IP67)	Custody transfer; PED, CRN, NTEP, PTB, METAS	±0.5% (per fill cycle)
316L (1.4404) 316L (1.4435)	Internal thread: G½" (DN 8), G¾" (DN 15) G1" (DN 25)	NEMA 4X (IP67)	Custody transfer; PED, CRN, NTEP, PTB, METAS	±0.5% (per fill cycle)
904L (1.4539) 316L (1.4404)	Flange: EN (DIN), ASME, JIS; VCO	NEMA 4X (IP67)	Suitable for system approval acc. to OIML R117-1 (2004/22/EG [MID], Appendix MI-005); PED, NTEP, MC, NMI	±0.2%
904L (1.4539) 316/316L (1.4404)	Flange: EN (DIN), ASME	NEMA 4X (IP66/67)	3.1 material, CRN, NTEP, NMI	±0.15% o.r. under reference conditions (for mass and volume flow)

Galvanic isolation	Inputs	Outputs	Communication	Ex approvals	Protection
Inputs/Outputs/Power supply	-	Pulse, switch output	Modbus RS485	-	NEMA 4X (IP67)
Inputs/Outputs/Power supply	-	Pulse, switch output	Modbus RS485	ATEX II 3G	NEMA 4X (IP67)
Inputs/Outputs/Power supply	-	Pulse/frequency, switch output	Modbus RS485	ATEX, IECEx, FM, CSA, NEPSI	NEMA 4X (IP67)
Inputs/Outputs/Power supply	Status input	0/4-20 mA, pulse/frequency (10 kHz, active/passive), 2 × pulse (90°/180°), relays, switch output	HART, Modbus RS485	ATEX, CEC, NEC, TIIS, NEPSI	NEMA 4X (IP67)
Inputs/Outputs/Power supply	-	Pulse/frequency, switch output	Modbus RS485	ATEX, IECEx, FM, CSA, NEPSI	NEMA 4X (IP67)
Outputs/Power supply	-	Modbus RS485	Modbus RS485	ATEX, IECEx, cCSAus, NEPSI, INMETRO (Ex ia)	NEMA 4X (IP66/67)



Sensors			Diameter	Measuring range	Pressure	Temperature (process)
EMF	Picomag Smart Conductive liquids		½ to 2"	up to 198 gal/min	232 psi	14 to 158°F
	Magphant® Limit switch/Trend display Conductive liquids		½ to 78"	0 to 248,982 gal/min	232 psia	-4 to +248°F
Thermal	Flowphant® DTT31 Standard applications Liquids		ANSI NPT ¼ and ½"	0.1 to 9.84 ft/sec Relative value between 0 to 100%	Up to 1,450 psi	-4 to +185°F
	Flowphant DTT35 Hygienic applications Liquids		Tri-Clamp 1" - 1½", 2" Varivent F, N DIN 11851 APV-Inline	0.1 to 9.84 ft/sec Relative value between 0 to 100%	Max. 1,450 psig all except conical metal (232 psig)	-4 to +185°F



Transmitters	Housing	Display/Operation	Temperature (Ambient)	Power supply
Picomag Compact version	Compact SS	Integrated display, operation via SmartBlue app	14 to 140°F	18 to 30V DC
Magphant Compact version	Compact Alu	LED	-4 to +140°F	DC 20 to 30 V
Flowphant DTT31 Compact version	Compact SS	One-line, backlit LCD Color change on faults, LED for status indication/Push buttons	-40 to +185°F	DC 18 to 30 V (reverse polarity protection)
Flowphant DTT35 Compact hygienic version	Compact SS	One-line, backlit LCD Color change on faults, LED for status indication/Push buttons	-40 to +185°F	DC 18 to 30 V (reverse polarity protection)





Materials (wetted parts)	Process connection	Protection	Approval/Certification	Measuring uncertainty ¹⁾ (best possible "accuracy")
PEEK, AISI 316L, FKM	Standard: external thread (G½", G¾", G1", G2") Optional: adapter sets for internal (G) and external (R, NPT) threads, Tri-Clamp, Victaulic	IP65/67	UL-listed (UL _{US}) Drinking water approvals (in preparation)	±0.8%
PVDF	Weld nipple	NEMA 4X (IP66)	Marine approvals	±2.0%
AISI 316L	Weld nipple, compression fitting, threaded connection: ASME, ISO	IP65	Marine approvals	±2.0 to 10% (depending on measuring range)
AISI 316L	Clamp ISO 2852, APV inline, Varivent, Conical metal-metal G¾", dairy thread (DIN 11851)	IP65	3A; marine approvals	±2.0 to 10% (depending on measuring range)



Inputs	Outputs	Communication	Ex approvals	Protection
Status	Current (4 to 20mA) Pulse Switch Voltage (2 to 10V)	IO-Link	-	IP 65/67
-	4-20 mA, relays	-	FM, CSA Div. 2	NEMA 4X (IP66)
-	1 × or 2 × PNP switch outputs Optional 1 × PNP switch outputs and 1 × 4-20 mA output (active)	Programmable via PC (ReadWin 2000 and FieldCare/DeviceCare)	-	IP65
-	1 × or 2 × PNP switch outputs Optional 1 × PNP switch outputs and 1 × 4-20 mA output (active)	Programmable via PC (ReadWin 2000 and FieldCare/DeviceCare)	-	IP65







Differential Pressure Flow Measurement

Flow measurement, Differential Pressure		
	Primary Element, Orifice plate	Primary Element, Pitot tube
		
Basic application	Gas, steam and liquids	Gas, steam and liquids
Nominal pipe size	3/8" to 40" depending on version	2" to 21 ft
Measuring range	Fluid dependent	Fluid dependent
Sensor type	Sharp edge orifice Bidirectional orifice Quarter circle nozzle orifice Conical inlet orifice Segmental orifice	Pitot tube
Process temperature	-328 to +1830°F	-328 to +1830°F
Process pressure	Up to 6300 psi	Up to 6300 psi
Process connections	ANSI Class 150, 300, 600, 900, 1500, 2500; 316L SS, C22.8 or A105 CS	ANSI Class 150, 300, 600, 1500; 316Ti SS Weld nipple, cutting ring, threaded; 316Ti SS
Transmitter	Deltabar S PMD75, Deltabar M PMO55	Deltabar S PMD75, Deltabar M PMO55
Output	4 to 20 mA HART, Profibus and FOUNDATION Fieldbus	4 to 20 mA HART, Profibus and FOUNDATION Fieldbus
Ambient temperature	-40 to +185°F, transmitter	-40 to +185°F, transmitter
Power supply	11.5 to 45 VDC; Profibus and FOUNDATION Fieldbus, 9 to 32 VDC	11.5 to 45 VDC; Profibus and FOUNDATION Fieldbus, 9 to 32 VDC
Display / User interface	4-line LCD / Push buttons	4-line LCD / Push buttons
Approvals / certificates	FM, CSA, NACE, SIL	FM, CSA, NACE, SIL

	Cerabar® T			
	PMC11/PMC21	PMP11	PMP21	PMP23
				
Application	Process pressure	Process Pressure	Process Pressure	Hygienic Pressure
Measuring range	PMC11: 6 to 600 psi (gauge/absolute) PMC21: 1.5 to 600 psi (gauge/absolute)	-15 to 600 psig	-15 to 6000 psig, 0 to 6000 psia	-15 to 600 psig, 0 to 600 psia
Pressure sensor	Ceramic	Metallic	Metallic	Metallic
Output	4 to 20 mA	4-20 mA, 0-10 VDC	4-20 mA	4-20 mA
Process temperature	-13 to 185°F (PMC11) -13 to 212°F (PMC21)	-13 to 185°F (-25 to 85°C)	-40 to 212°F (-40 to 100°C)	14 to 212°F, -10 to 100°C, (275°F/135°C for 1 hour)
Power supply	11 to 30 VDC	11-30 VDC	12-30 VDC	12-30 VDC
Process connections	Threaded	Threaded	Threaded	Mini-clamp, Tri-clamp, threaded
Approvals / certificates		CSA C/US/FM/ ATEX Ex	CSA C/US/FM/ ATEX Ex	CSA C/US/FM/ ATEX/IEC Ex

	Ceraphant T		
	PTC31B	PTP31B	PTP33B
			
Application	Process pressure	Process pressure	Process pressure
Measuring range	1.5 to 600 psi (gauge/ absolute)	6 to 6000 psi (gauge/ absolute)	6 to 600 psi (gauge/ absolute)
Pressure sensor	Ceramic	Metallic	Metallic
Output	One PNP switch output Two PNP switch outputs PNP switch output with 4 to 20 mA (active)	PNP switch + 4-20 mA, PNP switch, 2xPNP switch	PNP switch + 4-20 mA, PNP switch, 2xPNP switch
Process temperature	-13 to +212°F	-40 to +212°F	14 to 212°F, 225°F for 1 hour max
Power supply	12 to 30 VDC	12 to 30 VDC	12 to 30 VDC
Process connections	Threaded	Threaded	Threaded, Clamp, Tri-clamp, Varivent, universal adapter
Approvals / certificates	UL	CSA C/US/CUS, DNVGL, ABS	CSA C/US/CUS, EHEDG, 3A





	Cerabar M	
	PMCS1 B	PMP51
		
Application	Process pressure, level (gauge and absolute)	Process pressure, level (gauge and absolute)
Measuring range	-15 to 600 psi	-15 to 6000 psi
Pressure sensor	Ceramic	Metallic with diaphragm seal
Output	4 to 20 mA / HART	4 to 20 mA / HART
Communication	Bluetooth	Bluetooth
Ambient temperature	-40 to +185°F without display, -4 to +158°F with display	-40 to +185°F without display, -4 to +158°F with display
Power supply	11.5 to 45 VDC, 11.5 to 30 VDC for intrinsically safe unit	11.5 to 45 VDC, 11.5 to 30 VDC for intrinsically safe unit
Process temperature	-40 to +212°F -40 to +266°F for hygienic process connections +302°F for max. of 60 min (for hygienic)	-40 to +257°F (internal diaphragms) -40 to +218°F (flush-mounted diaphragms) -40 to +266°F (hygienic connections max 302°F for 30 min.) -94 to +752°F depending on seal and fill oil
Process connections	Threaded, ANSI flange	Threaded, ANSI flange
Approvals / certificates	CSA C/US, NSF 61, 3A, SIL	CSA C/US, NSF 61, 3A, SIL

	Cerabar S	
	PMC71 B	PMP71 B
		
Application	Process pressure, level	Process pressure, level
Measuring range	-15 to 600 psi	-15 to 10,500 psi
Pressure sensor	Ceramic	Metallic with diaphragm seal
Output	4 to 20 mA / HART	4 to 20 mA / HART
Communication	Bluetooth, Heartbeat	Bluetooth, Heartbeat
Process temperature	-13 to +257°F -4 to +302°F	-40 to +257°F (internal) -40 to +212°F (flush mount) -94°F to +752°F depending upon diaphragm seal/fill fluid
Power supply	10.5 to 45 VDC	10.5 to 45 VDC
Process connections	Threaded, ANSI flange	Threaded, ANSI flange
Approvals / certificates	SIL, CSA C/US, NSF 61	SIL, /CSA C/US, NSF 61







Differential



	Deltabar M
	PMD55 
Application	Differential pressure, level, flow
Span (adjustable)	0.15 to 600 psi
Pressure sensor	Metallic
Output	4 to 20 mA HART Profibus PA FOUNDATION Fieldbus
Ambient temperature	-40 to +185°F
Process temperature	-40 to +185°F
Process temperature range, seals	FKM Viton: -4 to +185°F PTFE: -40 to +185°F NBR: -4 to +185°F EPDM: -40 to +185°F
Power supply	11.5 to 45 VDC
Process connections	Oval flange, 1/4-18 NPT, 3 16L SS or C22.8
Approvals/certificates	FM/CSA C/US, SIL, 3A

	Deltabar S				
	PMD75	FMD71	FMD72	FMD77	FMD78
					
Application	Differential pressure, level, flow	Differential pressure, level	Differential pressure, level	Level	Differential pressure, level
Span (adjustable)	4 inH ₂ O to 600 psi		12 inH ₂ O to 150 psi	40 inH ₂ O to 240 psi	40 inH ₂ O to 600 psi
Pressure sensor	Metallic	Ceramic	Metallic	Metallic	Metallic
Output	4 to 20 mA HART Profibus PA FOUNDATION Fieldbus	4 to 20 mA HART	4 to 20 mA HART	4 to 20 mA HART Profibus PA FOUNDATION Fieldbus	4 to 20 mA HART Profibus PA FOUNDATION Fieldbus
Process temperature	-40 to +248°F	-13 to 302°F	-40 to +257°F (Consult factory for temperatures above 257 °F)	-40 to +660°F	-40 to +660°F
Power supply	10.5 to 45 VDC 9 to 32 VDC (Profibus, FF)	12 to 45 VDC	12 to 45 VDC	10.5 to 45 VDC 9 to 32 VDC (Profibus, FF)	10.5 to 45 VDC 9 to 32 VDC (Profibus, FF)
Process connections	Threaded	Threaded ANSI flange	Threaded ANSI flange	Threaded ANSI flange	Threaded ANSI flange Tri-Clamp Varivent
Approvals/certificates	SIL, FM/CSA C/US	FM/CSA C/US	FM/CSA C/US	SIL, FM/CSA C/US	SIL, FM/CSA C/US, 3A



Hydrostatic

	Deltapilot® M			
	FMB50 	FMB51 	FMB52 	FMB53 
Application	Hydrostatic level/pressure Food, pharmaceutical, chemical	Hydrostatic level/pressure Food, pharmaceutical, chemical	Hydrostatic level/pressure Food, pharmaceutical, chemical	Hydrostatic level/pressure water, wastewater
Measuring range	-15 to 150 psi	-15 to 150 psi	-15 to 150 psi	-15 to 150 psi
Pressure sensor	CONTITE	CONTITE	CONTITE	CONTITE
Output	4 to 20 mA / HART Profibus PA FOUNDATION Fieldbus	4 to 20 mA / HART Profibus PA FOUNDATION Fieldbus	4 to 20 mA / HART Profibus PA FOUNDATION Fieldbus	4 to 20 mA / HART Profibus PA FOUNDATION Fieldbus
Process temperature	14 to 212°F	14 to 185°F	14 to 158°F with PE cable 14 to 176°F with FEP cable	14 to 158°F with PE cable 14 to 176°F with FEP cable
Power supply	11.5 to 45 VDC IS versions, 11.5 to 30 VDC	11.5 to 45 VDC IS versions, 11.5 to 30 VDC	11.5 to 45 VDC IS versions, 11.5 to 30 VDC	11.5 to 45 VDC IS versions, 11.5 to 30 VDC
Process connections	Threaded ANSI flange Flush-mounted hygienic	Threaded ANSI flange	Threaded ANSI flange	Remote electronics, suspension clamp for sensor
Approvals/ certificates	FM, CSA C/US, 3-A, NSF 61, SIL	FM, CSA C/US, NSF 61, SIL	FM, CSA C/US, NSF 61, SIL	FM, CSA C/US, NSF 61, SIL

	Deltapilot S	Waterpilot
	FMB70 	FMX21  A B C
Application	Hydrostatic level, hygienic	Hydrostatic level
Measurement range	40 to 4,000 inH ₂ O (1.5 to 150 psi)	1.5 to 300 psi (3 to 600 ftH ₂ O)
Pressure sensor	CONTITE	Ceramic
Output	4 to 20 mA / HART Profibus PA FOUNDATION Fieldbus	4 to 20 mA / HART
Process temperature	14 to 212°F (up to 275°F for 30 minutes)	14 to 158°F (salt water version, 32 to 122°F)
Power supply	10.5 to 45 VDC (10.5 to 30 VDC for intrinsically safe units) 9 to 32 VDC (Profibus, FOUNDATION Fieldbus)	10.5 to 35 VDC Intrinsically safe, 10.5 to 30 VDC
Process connections	Universal mounting adapters, NPT, Tri-clamp, ANSI flange, Varivent	Mounting clamp, Threaded mount
Approvals / certificates	FM, CSA C/US, 3-A, SIL, NSF 61	FM, CSA C/US, NSF61

FMB70 pressure transmitter
replaces DB50S transmitter









A - Standard 0.87 version
B - Heavy duty 1.66 version
C - Salt water 1.15 version











Temperature Products available from Endress+Hauser

iTEMP® Temperature Transmitters

www.us.endress.com/temperature

	Field mounted						Field housing	DIN rail	Head mounted
	TMT142B (Single input) 	TMT162 (Dual input, dual-compartment housing) 	TMT121* 	TMT122* 	TMT127* 	TMT128* 	TMT71 	TMT72 	TMT82 
RTD input	Pt100, Pt200, Pt500, Pt1000 Ni100, Ni500, Ni1000	Pt100, Pt500, Pt1000 Ni100, Ni500, Ni1000	Pt100, Pt500, Pt1000 Ni100, Ni500, Ni1000	Pt100, Pt500, Pt1000 Ni100, Ni500, Ni1000	Pt100	No	Pt50, Pt100, Pt200, Pt500, Pt1000, Ni100, Ni120, Cu50, Cu100	Pt50, Pt100, Pt200, Pt500, Pt1000, Ni100, Ni120, Cu50, Cu100	Pt50, Pt100, Pt200, Pt500, Pt1000, Ni100, Ni120, Cu50
TC input	B, C, D, R, S, E, J, K, L, N, T, U	B, C, D, R, S, E, J, K, L, N, T, U	B, C, D, R, S, E, J, K, L, N, T, U	B, C, D, R, S, E, J, K, L, N, T, U	No	J, K, N, R, S, T	A, B, C, D, E, K, L, N, R, S, T, U	A, B, C, D, E, K, L, N, R, S, T, U	B, C, D, R, S, E, J, K, L, N, T, U
Ohms input	10 to 2000 W	10 to 2000 Ω	10 to 2000 Ω	10 to 2000 Ω	No	No	10 to 2000 Ω	10 to 2000 Ω	10 to 400 Ω, or 10 to 2000 Ω
mV input	-20 to 100 mV	-20 to 100 mV	-10 to 100 mV	-10 to 75 mV	No	No	-20 to 100 mV	-20 to 100 mV	-20 to 100 mV
Output	HART, 4 to 20 mA, 20 to 4 mA	HART, 4 to 20 mA/20 to 4 mA Profibus PA FOUNDATION Fieldbus	4 to 20 mA 20 to 4 mA	HART, 4 to 20 mA 20 to 4 mA	4 to 20 mA	4 to 20 mA	4 to 20 mA 20 to 4 mA	HART, 4 to 20 mA 20 to 4 mA	HART, 4 to 20 mA or 20 to 4 mA
Ambient temperature	-40 to 185°F	-40 to 185°F	-40 to 185°F	-40 to +185°F	-40 to +185°F	-40 to +185°F	-40 to +185°F	-40 to +185°F	-40 to +185°F
Power supply	11 to 40 VDC (8 to 40 VDC without display)	11 to 40 VDC (8 to 40 VDC without display)	12 to 35 VDC	12 to 35 VDC	12 to 35 VDC	12 to 35 VDC	Head 10 to 36 VDC DIN 11 to 36 VDC	Head 10 to 36 VDC DIN 11 to 36 VDC	11 to 42 VDC
Optional display	Yes	Yes	No	No	No	No	Yes	Yes	No
Approvals/certificates	FM, CSA, CE, UL, ATEX	FM, CSA, SIL 2, UL, CE, ATEX	FM, CSA, UL, CE, ATEX	FM, CSA, UL, CE, ATEX	FM, CSA, UL, CE, ATEX	FM, CSA, UL, CE, ATEX	CSA, CE, ATEX, IEC, NEPSI	CSA, CE, ATEX, IEC, NEPSI	FM, CSA, UL, CE, ATEX, SIL 2/SIL 3 (according to IEC 61508:2010)



* Replaced by the TMT71/72/82 which have the DIN Rail option included



	Head transmitters								
	TMT180 	TMT181** 	TMT187 	TMT188 	TMT182** 	TMT80 	TMT84 (dual input) 	TMT85 (dual input) 	TMT82 (dual input) 
RTD input	Pt100	Pt100, Pt500, Pt1000 Ni100, Ni500, Ni1000	Pt100	No	Pt100, Pt500, Pt1000 Ni100, Ni500, Ni1000	Pt100, Pt1000	Pt50, Pt100, Pt200, Pt500, Pt1000, Ni100, Ni120, Ni1000, Cu10, Cu50, Cu100	Pt50, Pt100, Pt200, Pt500, Pt1000, Ni100, Ni120, Ni1000, Cu10, Cu50, Cu100	Pt50, Pt100, Pt200, Pt500, Pt1000, Ni100, Ni120, Cu50
TC input	No	B, C, D, R, S, E, J, K, L, N, T, U	No	B, C, D, R, S, E, J, K, L, N, T, U	B, C, D, R, S, E, J, K, L, N, T, U	B, K, N, R, S	B, C, D, R, S, E, J, K, L, N, T, U	B, C, D, R, S, E, J, K, L, N, T, U	B, C, D, R, S, E, J, K, L, N, T, U
Ohms input	No	10 to 2000 Ω	No	No	10 to 2000 Ω	No	10 to 400 Ω, or 10 to 2000 Ω	10 to 400 Ω, or 10 to 2000 Ω	10 to 400 Ω, or 10 to 2000 Ω
mV input	No	-10 to 100 mV	No	No	-10 to 75 mV	No	-20 to 100 mV -5 to 30 mV	-20 to 100 mV	-20 to 100 mV
Output	4 to 20 mA 20 to 4 mA	4 to 20 mA 20 to 4 mA	4 to 20 mA	4 to 20 mA	HART, 4 to 20 mA 20 to 4 mA	4 to 20 mA	Profibus PA	FOUNDATION™ Fieldbus	HART, 4 to 20 mA or 20 to 4 mA
Ambient temperature	-40 to 185°F	-40 to 185°F	-40 to 185°F	-40 to +185°F	-40 to +185°F	-40 to +185°F	-40 to +185°F	-40 to +185°F	-40 to +185°F
Power supply	10 to 35 VDC	8 to 35 VDC	8 to 35 VDC	8 to 35 VDC	11.5 to 35 VDC	8 to 35 VDC	9 to 32 VDC	9 to 32 VDC	11 to 42 VDC
Optional display	No	No	No	No	No	No	No	No	Yes
Approvals/certificates	UL, CSA, CE	FM, CSA, UL, CE, ATEX	FM, CSA, UL, CE, ATEX	FM, CSA, UL, CE, ATEX	FM, CSA, UL, CE, ATEX	CE	FM, CSA, UL, CE, ATEX	FM, CSA, UL, CE, ATEX	FM, CSA, UL, CE, ATEX, SIL 2/SIL 3 (according to IEC 61508:2010)

**Phasing out





Temperature

RTD temperature sensors		
	TH11	TH12
		
Application	Process industry	Process industry
Measurement probe	Pt100	Pt100
Measuring range	-58 to +392°F / -328 to +1112°F	-58 to +392°F / -328 to +1112°F
Process connection	1/2" NPT, 316 SS 1/8" NPT compression, 316 SS 1/4" NPT compression, 316 SS	1/8" NPT compression, 316 SS 1/4" NPT compression, 316 SS
Output	Dependent on electronics, all iTEMP transmitters compatible	Dependent on electronics, all iTEMP transmitters compatible
Connection head	Aluminum, NEMA 4X Polypropylene, FDA, compliant, NEMA 4X	Aluminum, NEMA 4X Polypropylene, FDA, compliant, NEMA 4X
Ambient temperature	With head-mounted transmitter: -40 to +185°F Without head-mounted transmitter: Aluminum, -40 to +302°F Polypropylene, -40 to +185°F	With head-mounted transmitter: -40 to +185°F Without head-mounted transmitter: Aluminum, -40 to +302°F Polypropylene, -40 to +185°F
Minimum immersion	1", high temperature sensor 3/4", low temperature sensor	1-1/4", high temperature sensor 3/4", low temperature sensor
Immersion length	4", 6", 9", 12" 2" to 96", specified in 1/2" increments	6", 12", 18", 24" 2" to 96", specified in 1/2" increments
Approvals / certificates	Based on transmitter type used	Based on transmitter type used



RTD temperature sensors in Thermowells			
	TH13	TH14	TH15
			
Application	Process industry	Process industry	Process industry
Measurement probe	Pt100	Pt100	Pt100
Measuring range	-58 to +392°F / -328 to +1112°F	-58 to +392°F / -328 to +1112°F	-58 to +392°F / -328 to +1112°F
Process connection	1/2" NPT, 316 SS 3/4" NPT, 316 SS 1" NPT, 316 SS Socket weld, 3/4", 1", 316L SS Weld-in, 3/4", 1", 316L SS	1" ANSI flange, 316 SS 1-1/2" ANSI flange, 316 SS 2" ANSI flange, 316 SS	1/2" NPT, 316 SS+ Hex nipple or Nipple-Union-Nipple (NUN)
Output	Dependent on electronics, all iTEMP transmitters compatible	Dependent on electronics, all iTEMP transmitters compatible	Dependent on electronics, all iTEMP transmitters compatible
Connection head	Aluminum, NEMA 4X Polypropylene, FDA, compliant, NEMA 4X	Aluminum, NEMA 4X Polypropylene, FDA, compliant, NEMA 4X	Aluminum, NEMA 4X Polypropylene, FDA, compliant, NEMA 4X
Ambient temperature	With head-mounted transmitter: -40 to +185°F Without head-mounted transmitter: Aluminum, -40 to +300°F Polypropylene, -40 to +185°F SS, -40 to +300°F without display	With head-mounted transmitter: -40 to +185°F Without head-mounted transmitter: Aluminum, -40 to +300°F Polypropylene, -40 to +185°F SS, -40 to +300°F without display	With head-mounted transmitter: -40 to +185°F Without head-mounted transmitter: Aluminum, -40 to +300°F Polypropylene, -40 to +185°F SS, -40 to +300°F without display
Minimum immersion	Tapered thermowell: 4-1/2" Stepped thermowell: 2-1/2" Straight thermowell: 4" Weld-in thermowell: 4-1/2"	Tapered thermowell: 4-1/2" Stepped thermowell: 2-1/2" Straight thermowell: 4" Weld-in thermowell: 4-1/2"	Without thermowell: High temperature, 1-1/4" Low temperature, 3/4"
Immersion length	2-1/2", 4-1/2", 7-1/2", 10-1/2", 13-1/2", 16-1/2", 22-1/2" 2" to 24", specified in 1/2" increments	2", 4", 7", 10", 13", 16", 22" 2" to 24", specified in 1/2" increments	4", 6", 9", 12", 14" 4" to 30", specified in 1/2" increments
Approvals / certificates	Based on transmitter type used	Based on transmitter type used	Based on transmitter type used









RTD temperature sensors in Thermowells, Explosion Proof

	T13 	T14 	T15 
Application	Petrochemical, refineries	Petrochemical, refineries	Petrochemical, refineries
Measurement probe	Pt100	Pt100	Pt100
Measuring range	-58 to +392°F / -328 to +1112°F	-58 to +392°F / -328 to +1112°F	-58 to +392°F / -328 to +1112°F
Process connection	½" NPT, 316 SS ¾" NPT, 316 SS 1" NPT, 316 SS Socket weld, ¾", 1", 316LSS Weld-in, ¾", 1", 316LSS	1" ANSI flange, 316 SS 1½" ANSI flange, 316 SS 2" ANSI flange, 316 SS	½" NPT, 316 SS+ Hex nipple, 316 SS ½" NPT 316SS+ Nipple-Union-Nipple, 316 SS
Output	Dependent on electronics, iTEMP transmitters compatible	Dependent on electronics, iTEMP transmitters compatible	Dependent on electronics, iTEMP transmitters compatible
Connection head	Aluminum, NEMA 4X 316L SS, NEMA 4X	Aluminum, NEMA 4X 316L SS, NEMA 4X	Aluminum, NEMA 4X 316L SS, NEMA 4X
Ambient temperature	With head-mounted transmitter: -40 to +185°F Without head-mounted transmitter: Aluminum or SS, -50 to +212°F Field transmitter: With display, -40 to +158°F Without, -40 to +185°F	With head-mounted transmitter: -40 to +185°F Without head-mounted transmitter: Aluminum or SS, -50 to +212°F Field transmitter: With display, -40 to +158°F Without, -40 to +185°F	With head-mounted transmitter: -40 to +185°F Without head-mounted transmitter: Aluminum or SS, -50 to +212°F Field transmitter: With display, -40 to +158°F Without, -40 to +185°F
Minimum immersion	Tapered thermowell: 4½" Stepped thermowell: 2½" Straight thermowell: 4" Weld-in thermowell: 4½"	Tapered thermowell: 4½" Stepped thermowell: 2½" Straight thermowell: 4" Weld-in thermowell: 4½"	Without thermowell: High temperature, 1¼" Low temperature, ¾"
Immersion length	2½", 4½", 7½", 10½", 13½", 16½", 22½" ½" to 22½", specified in ½" increments	2", 4", 7", 10" 13", 16", 22" ½" to 22", specified in ½" increments	4", 6", 9", 12" 4" to 100", specified in ½" increments
Approvals / certificates	FM, CSA	FM, CSA	FM, CSA



Omnigrad M RTD temperature sensors



	TR10 	TR11 
Application	Process industry	Process industry
Measurement probe	Pt100	Pt100
Measuring range	-328 to +1112°F	-58 to +392°F / -328 to +1112°F
Process connection	½" NPT: 316L SS, Alloy C276 ¾" NPT: 316L SS	½" NPT: 316L SS, Alloy C276 ¾" NPT: 316L SS
Neck tube	3" to 6"	Without
Process pressure range	Up to 1088 psi	Up to 1088 psi
Output	Dependent on electronics, all iTEMP transmitters compatible: 4 to 20 mA, HART, Profibus PA, FOUNDATION Fieldbus	Dependent on electronics, all iTEMP transmitters compatible: 4 to 20 mA, HART, Profibus PA, FOUNDATION Fieldbus
Terminal head	Aluminum, Polyamide, 316L SS	Aluminum, Polyamide, 316L SS
Ambient temperature	With head-mounted transmitter: -40 to +185°F Without head-mounted transmitter: Aluminum, -40 to +300°F Polyamide, -40 to +248°F 316L SS, -40 to +212°F With head mounted transmitter and display: -4 to +158°F	With head-mounted transmitter: -40 to +185°F Without head-mounted transmitter: Aluminum, -40 to +300°F Polyamide, -40 to +248°F 316L SS, -40 to +212°F With head mounted transmitter and display: -4 to +158°F
Maximum length	394"	394"
Protection tube, welded	Outer diameter: 0.35", 0.43" or 0.47"	Outer diameter: 0.35", 0.43" or 0.47"
Tip shape	Reduced, straight, tapered	Reduced, straight, tapered
Approvals / certificates	Based on transmitter type used	Based on transmitter type used



Thermocouple (TC) temperature sensors

Thermocouple (TC) temperature sensors				Thermocouple (TC) temperature sensors in Thermowells		
	TH51 	TH52 	TH56 	TH53 	TH54 	TH55 
Application	Process industry	Process industry	Process industry	Process industry	Process industry	Process industry
Measurement probe	TC type: J, K, E, N, or T	TC type: J, K, E, N, or T	TC type: J, K, E, N, or T	TC type: J, K, E, N, or T	TC type: J, K, E, N, or T	TC type: J, K, E, N, or T
Measuring range	-454 to +2500°F	-454 to +2500°F	-454 to +2500°F	-454 to +2500°F	-454 to +2500°F	-454 to +2500°F
Process connection	½" NPT, 316 SS 1/8" NPT compression 316 SS ¼" NPT compression 316 SS	1/8" NPT compression 316 SS ¼" NPT compression 316 SS	1/8" NPT compression 316 SS ¼" NPT compression 316 SS	½" NPT, 316 SS ¾" NPT, 316 SS 1" NPT, 316 SS Socket weld, ¾", 316 SS Weld-in, 1", 316SS	1" ANSI flange, 316 SS 1½" ANSI flange, 316 SS 2" ANSI flange, 316 SS	½" NPT, 316 SS + Hex nipple, 316 SS ½" NPT 316 SS + Nipple-Union-Nipple, 316 SS
Output	Dependent on electronics, iTEMP transmitter compatible	Dependent on electronics, iTEMP transmitter compatible	Dependent on electronics, iTEMP transmitter compatible	Dependent on electronics, iTEMP transmitter compatible	Dependent on electronics, iTEMP transmitter compatible	Dependent on electronics, iTEMP transmitter compatible
Connection head	Aluminum and Polypropylene, NEMA 4X	Cable with connector	Cable with connector	Aluminum and Polypropylene, NEMA 4X	Aluminum and Polypropylene, NEMA 4X	Aluminum and Polypropylene, NEMA 4X
Ambient temperature	With head-mounted transmitter: -40 to +185°F Without head-mounted transmitter: Aluminum -40 to +302°F Polypropylene, -40 to +185°F	Dependent on connector type, Standard, up to +350°F High temperature, up to +800°F	Dependent on connector type, Standard, up to +350°F High temperature, up to +800°F	With head-mounted transmitter: -40 to +185°F Without head-mounted transmitter: Aluminum -40 to +302°F Polypropylene, -40 to +185°F	With head-mounted transmitter: -40 to +185°F Without head-mounted transmitter: Aluminum -40 to +302°F Polypropylene, -40 to +185°F	With head-mounted transmitter: -40 to +185°F Without head-mounted transmitter: Aluminum -40 to +302°F Polypropylene, -40 to +185°F
Minimum immersion	10 x OD of sensor sheath, nominal	10 x OD of sensor sheath, nominal	10 x OD of sensor sheath, nominal	Tapered thermowell, 4½" Stepped thermowell, 2½"	Tapered thermowell, 4½" Stepped thermowell, 2½"	4"
Immersion length	6", 12", 18", 24" 2" to 96", specified in ½" increments	12", 18", 24", 48", 72", 96" 2" to 96", specified in ½" increments	4", 6", 9", 12" 4" to 100", specified in ½" increments	2½", 4½", 7½", 10½", 13½", 16½", 22½" 2 to 24", specified in ½" increments	2", 4", 7", 10" 2" to 24" specified in ½" increments	4", 6", 9", 12", 14" 4" to 30" specified in ½" increments
Approvals / certificates	Based on transmitter type used	Based on transmitter type used	Based on transmitter type used	Based on transmitter type used	Based on transmitter type used	Based on transmitter type used



Thermocouple (TC) temperature sensors in Thermowells, Explosion Proof			
	T53	T54	T55
			
Application	Chemical, petrochemicals	Chemical, petrochemicals	Chemical, petrochemicals
Measurement probe	TC type: J, K, E, N, or T	TC type: J, K, E, N, or T	TC type: J, K, E, N, or T
Measuring range	-454 to +2500°F	-454 to +2500°F	-454 to +2500°F
Process connection	½" NPT, 316 SS ¾" NPT, 316 SS 1" NPT, 316 SS Socket weld, ¾", 316 SS Weld-in, 1", 316 SS	1" ANSI flange, 316 SS 1½" ANSI flange, 316 SS 2" ANSI flange, 316 SS	½" NPT, 316 SS + Hex nipple, 316 SS ½" NPT 316 SS + Nipple-Union-Nipple, 316 SS
Output	Dependent on electronics, iTEMP transmitter compatible	Dependent on electronics, iTEMP transmitter compatible	Dependent on electronics, iTEMP transmitter compatible
Connection head	Aluminum and 316L SS, NEMA 4X	Aluminum and 316L SS, NEMA 4X	Aluminum and 316L SS, NEMA 4X
Ambient temperature	With head-mounted transmitter: -40 to +185°F Without head-mounted transmitter: Aluminum, SS -58 to +212°F Field transmitter: -40 to +185°F w/o display -40 to +158°F w display	With head-mounted transmitter: -40 to +185°F Without head-mounted transmitter: Aluminum, SS -58 to +212°F Field transmitter: -40 to +185°F w/o display -40 to +158°F w display	With head-mounted transmitter: -40 to +185°F Without head-mounted transmitter: Aluminum, SS -58 to +212°F Field transmitter: -40 to +185°F w/o display -40 to +158°F w display
Minimum immersion	With thermowell: Tapered, 4½" Stepped, 2½" ¾" straight, 4" Weld-in, 4½"	With thermowell: Tapered, 4½" Stepped, 2½" ¾" straight, 4" Weld-in, 4½"	Without thermowell: 2½"
Immersion length	2½", 4½", 7½", 10½", 13½", 16½", 22½" 2 to 18", specified in ½" increments	2", 4", 7", 10", 13", 16", 22" 2" to 18" specified in ½" increments	4", 6", 9", 12" 4" to 100" specified in ½" increments
Approvals / certificates	FM, CSA	FM, CSA	FM, CSA







iTHERM® modular RTD thermometer		
	TM40x	TM41x
		
Application	Hygienic and aseptic	Hygienic and aseptic
Insert	Not replaceable	Replaceable
Sensor	Standard thin film 1x Pt100	Standard thin film 1x Pt100 1x Pt100 iTHERM QuickSens 1x Pt100 iTHERM StrongSens 1x or 2x Pt100 wirewound
Measuring range	-58 to +392°F	PT100: -328 to +1,112°F StrongSens: -58 to +932°F QuickSens: -58 to +392°F
Process connection	Compression fitting, Tri-Clamp, Microclamp, Clamp connections acc. to ISO2852, Ingold, G3/4" Liquiphant, G1" Liquiphant, Varivent, SMS1147, Screwed pipe joint acc. to DIN 11851	Compression fitting, Weld-in adapter, Clamp connections acc. to ISO2852, Screwed pipe joint acc. to DIN 11851, Aseptic screwed pipe joint acc. to DIN 11864-1, Metallic sealing system, Thread acc. to ISO228 for Liquiphant adapter, APV Inline, Varivent, Ingold, SMS1147, Neumo Biocontrol, T- and corner pieces
Output	4 to 20 mA, HART	4 to 20 mA, HART, PROFIBUS PA, FOUNDATION Fieldbus
Ambient temperature	-40 to +185°F	With head xmitter: -40 to +185°F With xmitter and display: -4 to +158°F QuickNeck: -58 to +284°F
Approvals / certificates	3-A, EHEDG, ASME BPE, FDA, TSE Certificate of Suitability	3-A, EHEDG, ASME BPE, FDA, TSE Certificate of Suitability, ATEX/IECEx



easytemp™ Compact RTD transmitter		
	TMR31	TMR35
		
Application	General industry	Hygienic
Measurement probe	Pt100 (Class A)	Pt100 (Class A)
Measuring range	-58 to +302°F (w/o neck) -58 to +392°F (w/neck)	-58 to +302°F (w/o neck) -58 to +392°F (w/neck)
Process connection	¼" and ½" NPT; 316L Compression fitting, 316L (Metric sizes also available)	1", 1½", 2" Tri-Clamp (Metric sizes also available)
Output	Std: Pt100, Class A 4-wire Optional: 4 to 20 mA or 20 to 4 mA	Std: Pt100, Class A 4-wire Optional: 4 to 20 mA or 20 to 4 mA
Power supply	10 to 35 VDC	10 to 35 VDC
Ambient temperature	-40 to +185°F	-40 to +185°F
Immersion length	1.6 to 23.6"	1.6 to 23.6"
Approvals / certificates	UL, CE	UL, CE, 3A

Thermophant® T temperature switch	
	TTR31
	
Application	Process control
Measurement probe	Pt100
Measuring range	-58 to +302°F
Process connection	¼" and ½" NPT
Output	One PNP switch output Two PNP switch outputs PNP switch output with 4 to 20 mA (active)
Power supply	12 to 30 VDC
Ambient temperature	-40 to +185°F
Approvals / certificates	UL

iTHERM CompactLine	
	TM311
	
Application	Hygienic and general industry
Measurement probe	Pt100 (Class A)
Measuring range	-58-392°F
Process Connection	compression fitting, thread, weld-in adapter, Tri-clamp, threaded pipe joint, aseptic threaded pipe joint, Varivent
Output	IO-Link, 4-20mA, switch or Pt100 4-wire
Power supply	10 to 30 VDC
Ambient temperature	-40 to 185F
Immersion length	1.5 to 24"
Approvals/certificates	3A, EHEDG, ASME BPE, FDA



iTHERM® MultiSens										
	Flex TMS01 		Flex TMS02 		Linear TMS11 	Linear TMS12 	Slim TMS21 		Bundle TMS31 	Customized engineered solution
Type of thermowell	Direct contact	Individual	Direct contact	Individual	Primary	Primary	Annealed tube	Annealed tube with flexible part	Stainless steel flexible rope	PVC coated flexible hose
Response time	■■■■■	■■■■■	■■■■■	■■■■■	■■■■■	■■■■■	■■■■■	■■■■■	■■■■■	■■■■■
Diagnostics capabilities	-	-	Advanced	Advanced	Basic	Advanced	-	-	-	-
Individually replaceable sensors	Yes	Yes	Yes, optional	Yes	Yes	Yes	-	-	-	-
Layout / bendability	■■■■■	■■■■■	■■■■■	■■■■■	N.A.	N.A.	■■■■■	■■■■■	■■■■■	■■■■■
Max. number of points	48	48	52	48	16	12	59	59	20	On request
Profile	linear or 3D	linear or 3D	linear or 3D	linear or 3D	linear	linear	linear	linear	linear	linear
Max. pressure in bar (psi)	100 (1,450)	100 (1,450)	200 (2,900)	200 (2,900)	240 (3,481)	240 (3,481)	90 (1,305)	90 (1,305)	40 (580)	40 (580)
Oil & Gas application fit	■■■■■	■■■■■	■■■■■	■■■■■	■■■■■	■■■■■	■■■■■	■■■■■	■■■■■	Silos and storage tanks
Chemical application fit	■■■■■	■■■■■	■■■■■	■■■■■	■■■■■	■■■■■	■■■■■	■■■■■	■■■■■	

Trustsens sensors	
TM371 	TM372 
Application	Food & Beverage, Life Science
Special features	Self-calibration at 118°C (24°F)
Design Basis	Metric Dimensions (millimeters) Available in 316L and 1.4435 (low Delta ferrite) Spring loading in housing or direct immersion available
Thermowell connection	Imperial Dimensions (inches) Available in 316L Spring loading in housing
Thermowell connection	G3/8 Cap Nut G1/4 male thread for compression fitting QuickNeck M24 female thread G3/8 female thread
Thermowell connection	1/2" NPT male thread QuickNeck QuickNeck with 1/2" NPT male thread
Housings	Compact Housing with M12 plug (with or without LED indication)
Type	Single element: Standard thin-film (mineral insulated)
Vibration Resistance	3 g
Response time	Depending on configuration. Refer to TI document for details.
Process Connections	Clamp according to ISO 2852, sanitary connection acc. to DIN 11851, aseptic pipe union acc. to DIN 11864-1, thread acc. to ISO 228 for Liquiphant® adaptor, metallic sealing system, weld-in adapter, APV-Inline, Varivent®, Ingold connection, SMS 1147, compression fitting; Neumo Biocontrol; T- and corner pieces according to DIN 11865
Process Connections	Tri-Clamp, Clamp according to ISO 2852, cylindrical weld-in (NPS), thread acc. to ISO 228 for Liquiphant adaptor, Varivent®, T- and corner pieces according to DIN 11865
Finish Ra	0.76 µm (30 µin) 0.38 µm (15 µin) Optional: 0.38 µm (15 µin) with electropolish
Output	4-20 mA; HART
Range	TF: -40°C to 160°C (-40°F to 320°F)
Approvals	CSA C/US GP
Certificates / Conformity	3-A, EHEDG, ASME BPE, FDA, TSE Certificate of Suitability, CRN on thermowell



New possibilities, new experiences

PERSONAL + DIGITAL

Complete e-commerce functionality
now on Endress.com



Products. Services. Solutions. New possibilities.

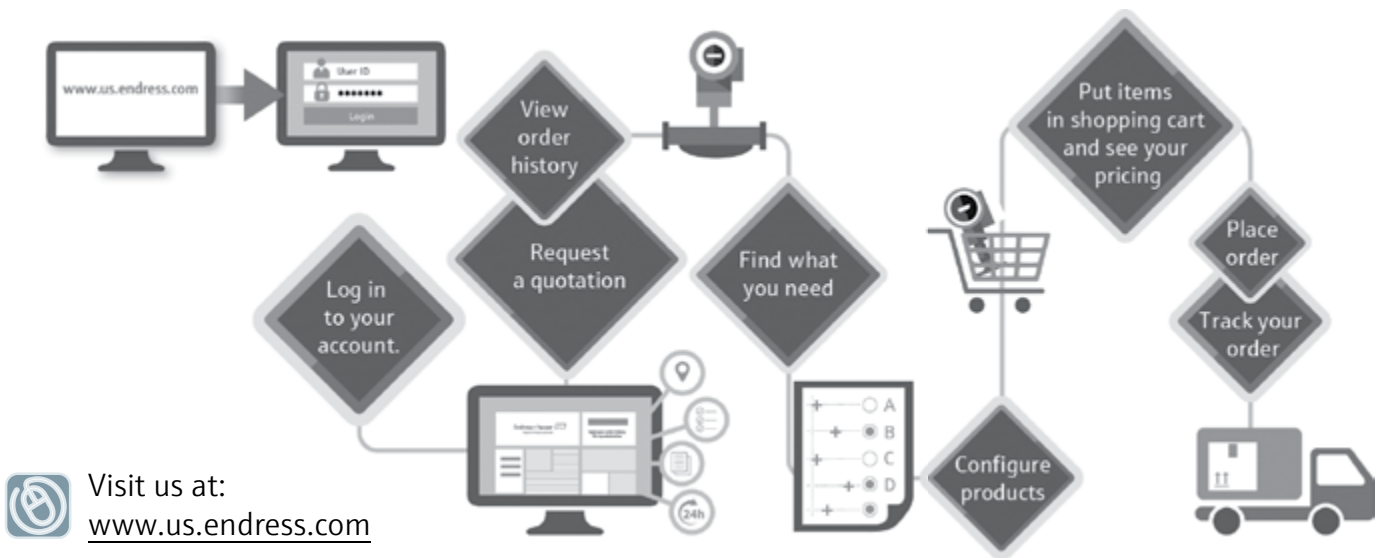

- Set up an account to shop for devices, spare parts & accessories
- Get easy access to technical information and documentation
- Buy online or request a quote from a sales representative
- Track the status of your quotes and orders
- View both online and offline transactions - all in one place
- Search quickly for products with our Product Finder, or by entering an order code or serial number







Visit us at:
www.us.endress.com



Endress+Hauser USA
Tel: 317-535-7138
1-888-363-7377



Endress+Hauser 
People for Process Automation

Recorders		
	Memograph® M RSG45 	Ecograph® T RSG35 
Recorder type	Graphic data manager, paperless, record, visualize, analyze and communicate	Universal data manager, record, visualize, monitor and communicate
Application	Process monitoring / control	Process monitoring / control
Input	Up to 20 universal or HART, 6 to 14 digital, 8 mathematics channels, Profibus	Up to 12 analog, 6 digital
Input types	V, mV, mA, RTD, TC, frequency, pulse, Profibus DP	V, mV, mA, RTD, TC, frequency, pulse
Setpoint control	1 alarm relay, 5 NO relays for limit values, optional digital card with 6 NO relays	1 alarm relay, 5 NO relays for limit values
Plot or memory storage	Internal memory 256 MB, SD card or USB stick	Internal, 128 MB Flash, External, SD card and USB stick
Interface	Integrated WEB server, Profibus, Modbus, USB, TCP/IP, OPC, Ethernet, RS232/485	USB port, Ethernet, RS232/RS485, Integrated web server, Modbus
Display type	7" TFT display, multicolor	5.7" TFT multicolor
Ambient temperature	14 to 122°F	14 to 122°F
Power supply	100 to 230 VAC 24 V AC/DC	100 to 230 VAC 24 V AC/DC
Approvals / certificates	CE, UL, FDA 21, CFR 11, ATEX Ex p	CSA, GP, CE, UL





Multi-functional components				
	RIA452 	RIA45 	RIA46 	RIA15 
Component function	Digital display, Pump control	Digital display, process display and control unit	Digital display, process display and control unit, field mounted	Loop powered digital display/ Process display
Input	Analog, digital	Analog, 1 or 2	Analog, 1 or 2	Analog, Digital
Input types	V, mA, RTD, TC, digital	V, mA, resistance, RTD, TC	V, mA, resistance, RTD, TC	4 to 20 mA + HART
Relay outputs/number	4 or 8 SPDT	2 SPDT (optional)	2 SPDT (optional)	N/A
Type of outputs	Relay, analog (U, I), pulse	Relay, 1 or 2 analog, digital status	Relay, 1 or 2 analog, digital status	N/A
Loop power to transmitter	24 V, 250 mA	24 to 230 VAC / VDC	24 to 230 VAC / VDC	N/A
Interface	RS232, ReadWin software, USB-box	FieldCare/DeviceCare software, 3 pushbuttons, USB	FieldCare/DeviceCare software, 3 pushbuttons, USB	3 pushbuttons
Display type	7-digit LCD, bar graph, status and digital input LEDs, limit value flags (1 to 8) 9 x 77 dot matrix	5-digit backlit LCD, dot matrix for text/ bar graph, limit value indicators, channel display, status LEDs	5-digit backlit LCD, dot matrix for text/ bar graph, limit value indicators, channel display, status LEDs	5-digit backlit LCD, bargraph and limit value indicators
Ambient temperature	-4 to +140°F	-4 to +140°F	-40 to +122°F	-40 to +140°F
Power supply	90 to 250 VAC, 20 to 36 VDC, 20 to 28 VAC	24 to 230 V AC/DC	24 to 230 V AC/DC	Loop powered, 4 to 20 mA
Approvals / certificates	CE, FM, CSA, ATEX, TIIS	CE, FM, CSA, UL, ATEX	CE, FM, CSA, UL, ATEX	FM, CSA, ATEX, IEC Ex, GL





Loop powered field indicator		
	RIA14 	RIA16 
Component function	Loop powered field indicator with explosion proof enclosure	Loop powered field indicator in field mounted housing
Input	4 to 20 mA	4 to 20 mA
Types of outputs	Open collector	Open collector
Display measuring range	-19999 to +99999	-19999 to +99999
Loop power to transmitter	4 to 20 mA	4 to 20 mA
Interface	3 push buttons, remote via FieldCare/ DeviceCare PC operating software	3 push buttons, remote via FieldCare/ DeviceCare PC operating software
Display type	5-digit backlit LCD, 0.8" height, trend bargraph in 10% increments	5-digit backlit LCD, 1.02" height, trend bargraph in 10% increments
Ambient temperature	-40 to +176°F	-40 to +176°F
Power supply	Loop-powered, 4 to 20 mA	Loop-powered, 4 to 20 mA
Approvals / certificates	CE, FM, CSA, UL, ATEX	CE, FM, CSA, UL, ATEX

Field indicator, FOUNDATION Fieldbus		
	RID14 	RID16 
Component function	Digital indicator	Digital indicator
Input	8-channel	8-channel
Display measuring range	-9999 to +99999	-9999 to +99999
Communication	FOUNDATION Fieldbus, Profibus PA	FOUNDATION Fieldbus, Profibus PA
Display type	5-digit backlit LCD, 0.8" height, trend bargraph in 10% increments, over/ under range, units	5-digit backlit LCD, 1.02" height, trend bargraph in 10% increments, over/ under range, units
Housing	Field mounted wall or pipe, aluminum (optional SS)	Field or panel mounted, plastic (aluminum optional)
Ambient temperature	-40 to +176°F	-40 to +176°F
Power supply	9 to 32 VDC, via fieldbus	9 to 32 VDC, via fieldbus
Approvals / certificates	CE, FM, CSA, UL, ATEX	CE, FM, CSA, UL, ATEX



Note: RIA14 and RIA16 replace the RIA261 and RIA141

Multi-functional components (DIN rail mounting)				
	RNS221 	RN221N 	RMA42 	RTA421 
Component function	Power supply for 2-wire systems	Power supply, active barrier for 2-wire systems	Digital process transmitter and control unit for monitoring analog measured values	Limit alarm switch with power supply for monitoring current or voltage signals
Input	N/A	1 analog	1 or 2 universal	1 analog
Input types	N/A	4 to 20 mA	V, mA, RTD, TC, resistance	V, mA
Relay outputs/number	N/A	N/A	2 SPDT	2 SPDT
Types of outputs	N/A	4 to 20	1 or 2: 0/4 to 20 mA, voltage 1 linearization table, 32 points Mathematics functions Open collector output	N/A
Loop power to transmitter	2 channels, 24 V, 30 mA	24 VDC, 22 mA	24 VDC, 22 mA	24 VDC, 30 mA
Interface	HART	HART	3 push buttons, USB, , HART, FieldCare/ DeviceCare	3 push buttons
Display type	3 LEDs	1 LED	5-digit backlit LCD, alarm markers, bar graph, LED relay indicators	LCD, 4-digit
Ambient temperature	-4 to +140°F	-4 to +122°F	-4 to +140°F	-4 to +158°F
Power supply	20 to 250 VAC/VDC	20 to 250 VAC/VDC	24 to 230 VAC/VDC	196 to 250 VAC, 50/60 Hz 98 to 126 VAC, 50/60 Hz 20 to 250 VDC/AC, 50/60 Hz
Approvals / certificates	CE	CE, FM, CSA, ATEX	CE, FM, CSA, ATEX, NEPSI, UL	CE



Safety barrier, DIN rail mount	
	RB223 
Component function	Loop-powered barrier for separation of 4 to 20 mA signal circuits, one or two channel
Input	0/4 to 22 mA or specified accuracy 0 to 40 mA operating range
Output	0/4 to 22 mA for specified accuracy 0 to 40 mA operating range (max. current depends on load)
Power supply	Loop-powered, 0/4 to 20 mA
Ambient temperature	-4 to +140°F
Interface	HART communication, bi-directional
Mounting	Standard top-hat DIN rail
Housing	Plastic PC, UL, 940
Approvals / certificates	CE, FM, CSA, UL, SIL 3, ATEX

Power supply Easy Analog	
	RNB130 
Component function	Primary switched-mode power supply
Input	100 to 240 VAC
Output	24 VDC
Power supply	85 to 264 VAC
Ambient temperature	-13 to +158°F
Display element	DC OK LED, green
Mounting	Standard top-hat DIN rail
Housing	Polyamide PA
Approvals / certificates	CE





BTU / Steam manager		
	EngyCal [®] RH33 BTU meter 	EngyCal RS33 Steam calculator 
Basic application	Custody transfer BTU meter heat/cold given off by liquids	Steam calculator for recording and billing steam mass and energy
Measuring range	Water: 32 to 662°F Water/glycol (0 to 60% glycol): -40 to +662°F Liquids: -328 to +1112°F	Steam: 32 to 1112°F Pressure: 0 to 14,500 psi
Calculation standards	IAPWS-IF 97, NAMUR NE21, NE43	IAPWS-IF 97, NAMUR NE21, NE43
Measurement/calculation	500 ms interval	500 ms interval
Housing	Wall/pipe mounting, panel or top-hat rail	Wall/pipe mounting, panel or top-hat rail
Inputs	2 Current/pulse, 2 Current/RTD 2 digital (activate tariff counter)	2 Current/pulse, 2 Current/RTD 2 digital (activate tariff counter)
Outputs	0/4 to 20 mA, pulse, 2 relays, 2 digital (open collector), 24 VDC	0/4 to 20 mA, pulse, 2 relays, 2 digital (open collector), 24 VDC
Display/Local operation	160 x 80 dot matrix with rear illumination, 3 soft-key pushbuttons, USB for configuration, 2 LED indicators	160 x 80 dot matrix with rear illumination, 3 soft-key pushbuttons, USB for configuration, 2 LED indicators
Interface	USB, Ethernet TCP/IP, RS485, Modbus TCP, Modbus RTU, M-Bus Internal data logging and logbook	USB, Ethernet TCP/IP, RS485, Modbus TCP, Modbus RTU, M-Bus Internal data logging and logbook
Operating software	Field Data Manager, FieldCare Device Setup	Field Data Manager, FieldCare Device Setup
Ambient temperature	-4 to +140°F	-4 to +140°F
Power supply	100 to 230 VAC, 24V AC/DC	100 to 230 VAC, 24 V AC/DC
Standards/approvals	OILM R75, MID (EN1434 water/liquids), UL, CE, CSA GP	OILM R75, CE, UL, CSA GP



Batch controller	
	RA33 
Basic application	Batching and dosing of liquids, mass and volume flow
Function	Filling and dosing
Housing	Wall/pipe mounting, panel or top-hat rail
Inputs	0/4 to 20 mA / pulse for flow, 1 RTD 0/4 to 20 mA, pulse/frequency, 0/4 to 20 mA density
Outputs	0/4 to 20 mA or voltage pulse, 2 relay outputs, 2 digital (open collector, optional), 24 VDC transmitter power supply
Power supply	100 to 230 VAC 24 VAC / DC
Display / local operation	160 x 80 dot matrix with rear illumination, three operation push buttons, 14 function buttons for batch operation or via Field- Care/DeviceCare
Interface	USB (with CDI protocol, Ethernet TCP/IP, RS485, RS232 printer interface (optional), Modbus TCP, Modbus RTU
Operating software	Field Data Manager software Ms20, Field- Care/DeviceCare Device Setup
Ambient temperature	-4 to +140°F
Standards / approvals	CE, UL, CSA GP

WirelessHART [®]		
	SWA70 	SWG70 Fieldgate 
Application	Battery powered interface module connecting HART and 4 to 20 mA devices to a WirelessHART network	Gateway device for WirelessHART networks. Converts and stores wireless device data in a format compatible with other systems, host applications such as HMI / SCADA tools.
Input	One point to point HART device, one point to point 4 to 20 mA device or up to 4 externally powered HART devices operating in multidrop mode	WirelessHART communication interface
Output	WirelessHART communication interface	Ethernet (10 BASE-T/10 BASE TX), RS485 serial
Transmission range	Outdoor, 820 ft (250 m) Indoor, 165 ft (50 m)	Outdoor, 820 ft (250 m) Indoor, 165 ft (50 m)
Power supply	Long life lithium thionylchloride battery pack, 5 to 7.2 VDC	20 to 30 VDC
Battery life	5 to 7 years dependent on update rate, instrument type and environmental conditions	N/A
Ambient temperature	-40 to +176°F (temperature below -22°F, battery pack capacity decreases rapidly)	-4 to +140°F
Antenna	Omnidirectional dipole, adjustable in vertical plane	Omnidirectional dipole, adjustable in vertical plane, optional remote antenna
Approvals / certificates	CE, FM, CSA, FCC Part 15.247	CE, FCC CFR 47 Part 15, ATEX











Profibus FieldGate	
	Fieldgate SFG500 
Application	Intelligent Ethernet/PROFIBUS gateway providing parallel access to PROFIBUS networks, monitoring of PROFIBUS and HART device status
Input	Profibus listener, master class 2 and HART support via Profibus
Outputs	LAN port access point for client software based FDT/DTM technology
Interface	Embedded Web Server and second LAN port providing service access
Power	18 to 36 VDC
Ambient temperature	+32°F to 140°F
Mounting	panel, DIN rail
Housing	Aluminium alloy
Protection	IP 20; NEMA Type 1
Approvals / certificates	CE Mark CE to EN/IEC 61131-2: 2007

FieldCare

<p>FieldCare is a state-of-the-art configuration software for configuration out of a central location. There is no need to spend a lot of time in the field anymore.</p> <p>You can either remotely access your devices from your maintenance station or prepare the configuration changes in advance and transfer them point-to-point fast and easily.</p> <p>Your benefits</p> <ul style="list-style-type: none"> ■ One tool to access all field devices regardless of FDT or EDD technology ■ All major communication protocols supported ■ Fast commissioning and device replacement ■ Open for 3rd party drivers and hardware ■ Performs device configuration management when combined with life cycle management ■ Diagnosis of devices according to NAMUR NE 107

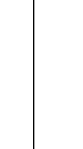



Field Communicators			
	Field Xpert SMT50	Field Xpert SMT70	Field Xpert SMT77
			
Application	Field Instrument Configurator, Rugged Industrial PC tablet with FDT/ DTM technology software and Microsoft Windows 10 OS for Non-Ex	Field Instrument Configurator, Rugged Industrial PC tablet with FDT/ DTM technology software and Microsoft Windows 10 OS for Ex-Zone 2 C1D2	Field Instrument Configurator, Rugged Industrial PC tablet with FDT/ DTM technology software and Microsoft Windows 10 OS for Ex-Zone 1 C1D1
User Interface	12.2" multi-touch, high resolution display	11.6" multi-touch, high resolution display	10.1" multi-touch, high resolution display
CPU/ memory	Intel® Sky Lake Core™ m3-7Y30, 4 GB RAM / 128 GB SSD	Intel® Core i5™ 2.7 GHz, 8 GB RAM / 256 GB SSD	Intel® N3710™ 1.6 GHz, 8 GB DDR3L / 128 GB SSD
Camera(s)	2/5MP cameras	2/5MP cameras	2/5MP cameras
Additional Interface	3 USB, Bluetooth 4.2, WiFi, WWAN LTE/ GPS, Ethernet RJ-45	2 USB, Bluetooth 5.0, WiFi, WWAN LTE 4G/ GPS	1 USB, Bluetooth 4.1, WiFi, WWAN LTE/ GPS
Battery	8 hours battery lifetime, Hot Swap 6,300mAh battery	7-14 hours battery life-time, Hot Swap 3,950/ 7,800mAh battery	3-5 hours battery lifetime, Hot Swap 4,200mAh battery
Weight	3.3 lbs	2.6 lbs	5.1 lbs
Ambient Temperature	-4 to 131 °F	14 to 131 °F	-4 to 122 °F
Protection	IP65, MIL-STD-810G	IP65, MIL-STD-810G	IP65
Certificates	-	NEC/CEC Class 1, Div. 2, Group A-D T4	UL Class I, Division 1, Groups A, B, C and D
Approvals	CE, FCC, IC	CE, FCC, IC	CE, FCC, IC





Analysis: pH and ORP



pH and pH Memosens Sensors									
									
Application	Process/ environment	Municipal water	Food/ biotechnology	Process/hygienic	Pharmaceutical, biotechnology, hygienic/sterile	Process/chemical	Process/environment	Process/environment	Process/environment
Parameter	pH	pH	pH	pH	pH	pH	pH	pH	pH
Material	Glass	Glass	Glass	Glass	Glass	Glass	PEEK, FFKM (Perfluoroelastomer)	PEEK, FFKM (Perfluoroelastomer)	PEEK, FFKM (Perfluoroelastomer)
Measuring range	0 to 14 pH	1 to 12 pH	0 to 14 pH	0 to 14 pH	1 to 12 pH	0 to 14 pH	0 to 14 pH	0 to 14 pH	0 to 14 pH
Temperature	32 to 275°F	32 to 176°F	5 to 275°F	32 to 275°F	32 to 284°F	32 to 230°F	5 to 275 °F	5 to 275 °F	5 to 275 °F
Temperature sensor	Pt100/Pt1000, NTC (11D)	Pt100/NTC 30K thermistor (31D)	Pt100/Pt1000, NTC (41D)	Pt100/Pt1000	NTC 30K thermistor	Pt100/Pt1000, NTC (91D)	Pt1000	Pt1000	Pt1000
Process pressure	87 or 232 psi	15 to 60 psi	145 psi	190 psi	14.5 to 101.5 psi	190 psi	160 psi (11 bar) Abs.	160 psi (11 bar) Abs.	160 psi (11 bar) Abs.
Reference junction	PTFE	Ceramic	Ceramic	Ceramic	Ceramic	Open	Ceramic	Ceramic	Open aperture
Reference	Gel	Gel	Liquid	Gel	Gel	Solid gel	Liquid	Gel	Solid gel
Lengths (mm)	120/225/ 360/425	120	120/225/ 360/425	120/225/ 360/425	120/225/ 360/425	120/225/ 360/425	120/225/360	120/225/360	120/225/360
Sensor cable	CPK9, CYK10 (11D) , CYK20	CPK9, CYK10 (31D) , CYK20	CPK9, CYK10 (41D) , CYK20	CPK9, CYK10 (71D) , CYK20	CYK10 , CYK20	CPK9, CYK10 (91D)	CYK10 , CYK20	CYK10 , CYK20	CYK10 , CYK20
Approvals / certificates	FM/CSA IS NI; CL I, Div. 1, Group A-D	Non-hazardous	FM/CSA IS NI; CL I, Div. 1, Group A-D	FM/CSA IS NI; CL I, Div. 1, Group A-D, 3A, biocompatible	CE Mark. FM/ CSA IS NI; CL I, Div. 1, Group A-D; IECEX, ATEX Biocompatibility: ISO 10993- 5:2009, USP <87>, USP <88> Class VI	FM/CSA IS NI; CL I, Div. 1, Group A-D	CE, 3-A, FDA, EHEDG, ASME BPE-2018, EC No. 1935/2004, Biocompatible USP<87>, USP<88>	CE, 3-A, FDA, EHEDG, ASME BPE-2018, EC No. 1935/2004, Biocompatible USP<87>, USP<88>	CE





ORP and ORP Memosens Sensors				pH Sensors	
	Memosens CPS12D or Orbisint CPS12/13	Memosens CPS42D or Ceraliquid CPS42/43	Memosens CPS72D or Ceragel CPS72	Orbitex CPS21	CPS64
					
Application	Process/environment	Food/biotechnology	Process/hygienic	Water/wastewater	Process/environment
Parameter	ORP	ORP	ORP	pH	pH
Material	Glass	Glass	Glass	Glass	Glass
Measuring range	-1500 to 1500 mV	-1500 to 1500 mV	-1500 to 1500 mV	2 to 12 pH	0 to 14 pH
Temperature	5 to 275°F	5 to 275°F	5 to 275°F	32 to 140°F	5 to 265°F
Temperature sensor	NTC (12D)	NTC (42D)	NTC 30K Thermistor (72D)	Pt100	N/A
Process pressure	232 psi	145 psi	160 psi	87 psi	217 psi
Reference junction	PTFE	Ceramic	Ceramic	Open ring junction	N/A
Reference	Gel	KCl liquid	Gel	Gel	CPS13/CPS43 Ref sensor
Lengths (mm)	120/225/360	120/225/425	120/225/360	120/150	120/425
Sensor cable	CPK9, CYK10 (12D)	CPK9, CYK10 (42D)	CPK9, CYK10 (72D)	CPK9	CPK9
Approvals / certificates	FM/CSA IS NI; CL I, Div. 1, Group A-D (12D)	FM/CSA IS NI; CL I, Div. 1, Group A-D (42D)	FM/CSA IS NI; CL I, Div. 1, Group A-D	General purpose	General purpose









Combined pH/ORP Memosens Sensors			
	Memosens CPS16D 	Memosens CPS76D 	Memosens CPS96D 
Application	Process/environmental	Process/hygienic	Process/chemical
Parameter	pH/ORP	pH/ORP	pH/ORP
Material	Glass	Glass	Glass
Measuring range	0-14pH, -1500 to +1500mV (ORP)	0-14pH, -1500 to +1500mV (ORP)	0-14pH, -1500 to +1500mV (ORP)
Temperature	32 to 275°F	32 to 280°F	32 to 230°F
Temperature sensor	NTC 30KΩ	NTC 30KΩ	NTC 30KΩ
Process pressure	230 psi	190 psi	190 psi
Reference junction	PTFE	Ceramic	Open
Reference	Gel	Gel	Gel
Lengths (mm)	120/225/360/425	120/225/360/425	120/225/360/425
Sensor cable	CYK10, CYK20	CYK10, CYK20	CYK10, CYK20
Approvals / certificates	FM/CSA IS NI; CL I, Div. 1, Group A-D	FM/CSA IS NI; CL I, Div. 1, Group A-D	FM/CSA IS NI; CL I, Div. 1, Group A-D





pH / ORP Sensors		
	Memosens CPF81D/82D or Orbipac W CPF81/82 	Purisys CPF201 
Application	Water/wastewater	Pure and ultrapure water
Parameter	pH / ORP	pH
Material	PPS / Glass	316L SS / Glass
Measuring range	0 to 14 pH / -1500 to +1500 mV	0 to 14 pH
Temperature	32 to 230°F	32 to 165°F
Temperature sensor	Pt100	Pt100/Pt1000
Process pressure	50 psi	50 psi
Reference junction	PTFE	PTFE
Reference	Gel	Gel
Lengths (mm)	12.5/23/58.5	N/A
Sensor cable	Fixed cable, CPK9, CYK10 (81D/82D)	CPK9
Approvals / certificates	General purpose	General purpose

pH / Enamel Coated Sensor	
	Ceramax CPS341D Memosens 
Application	Water, active ingredient prep, fermentation, biotechnology, food/beverage
Parameter	pH, temperature
Material	Porcelain enamel metal substrate (PEMS)
Measuring range	-2 to 14 pH (0 to 10 pH linear range); 32 to 280°F measuring range
Temperature	32 to 280°F
Temperature sensor	NTC 30KΩ
Process pressure	0 to 87 psi
Reference junction	Ceramic
Reference	Ag/AgCl with 3 M KCl and inhibitor
Lengths (mm)	120
Sensor cable	CYK10
Approvals / certificates	General purpose

pH / Memosens Lab	
	Memosens CPL51E 
Application	Grab sample lab measurement and portable field measurements
Parameter	pH, temperature
Material	Glass and polymer
Measuring range	0 to 14 pH
Temperature	32 to 176 °F
Temperature sensor	Pt1000
Process pressure	Ambient
Reference junction	Open
Reference	Gel
Lengths (mm)	120
Sensor cable	CYK10, CYK20
Approvals / certificates	General purpose







pH / ORP Holder Assemblies						
	Dipfit W CPA510	Dipfit W CPA111	Dipfit P CPA140	Flowfit P CPA240	Flowfit W CPA250	Flowfit CYA21
						
Application	Water, wastewater, process	Water, wastewater, process	Process	Process	Water	Water/Utilities
Description	Single installation point for 120 mm, bayonet style holder	3 installation points for 120 mm electrodes, bayonet style holder	3 installation points for 120 mm electrodes, bayonet style holder	3 installation points for 120 mm electrodes	3 installation points for 120 mm electrodes	Compact flowthrough
Area of use	Open tank, channel, closed tank	Open tank, channel, closed tank	Closed tank	Piping or bypass	Piping or bypass	Bypass or branch
Process connection	DN 50 (2") oval flange, 316 SS hanging bracket, DN 50 (2") flange	Suspended, lap joint flange or adjustable flange	3" Class 150 ANSI flange	1" Class 150 ANSI flange	G1 or 1" NPT	6 mm OD open tube
Material	PVC, PVDF	Polypropylene	PVDF or 316L SS	PVDF or 316L SS	Polypropylene	316L SS
Maximum pressure	87 psi	60 psi	90 or 145 psi	120 or 145 psi	87 psi	232 psi
Maximum temperature	+122°F	+180°F	+250 or +300°F	+250 or +300°F	+180°F	158°F
Immersion depth	20 to 118 inches	20 to 118 inches	20 to 100 inches	N/A	N/A	N/A
Sensor connection thread	Pg 13.5	3 x Pg 13.5	3 x Pg 13.5	3 x Pg 13.5	3 x Pg 13.5	PG 13.5 or NPT 1/2"
Certificates	N/A	N/A	3.1.B EN 10204	3.1.B EN 10204	N/A	N/A
Associated cleaning systems	Cleaning can be accomplished without electrode removal	Integrated spray cleaning CPR31 or external spray CPR30	Integrated spray cleaning CPR31	Spray cleaning connection G 1/2	Spray cleaning connection with CPR3	N/A



pH / ORP Holder Assemblies					
	Unifit CPA842	Ecofit CPA640	Cleanfit® W CPA450	Cleanfit CPA871	Cleanfit CPA875
					
Application	Food, beverage and life sciences	Chemical, process	Water, wastewater, process	Water, wastewater, chemical	Life sciences, food & beverage
Description	Process assembly for 12 mm (PG 13.5) sensors such as pH, pH ISFET and oxygen sensors	Single installation point, 12 mm dia. glass electrodes, 120 mm	Manual operation, 120 mm electrode	Manual or pneumatic, can be fully automated with Cleanfit® Control CYC25	Manual or pneumatic, can be fully automated with Cleanfit Control CYC25
Area of use	Tank or pipe	Process connection adapter for various electrodes	Open tank or closed tank and piping	Tank or piping	Tank or piping
Process connection	DN25 standard, DN25 B. Braun, Clamp 1.5" short, Clamp 1.5" long, Clamp 2" long, Clamp 1.5" angled 15 degrees, DN50 Dairy, Varivent flange N (DN40 to 125)	½" NPT, ¾" NPT, 1" NPT	1¼" NPT or 1-1/4" Class 150 ANSI flange	Tri-Clamp 2", 2.5" ANSI 2" 150 lbs ANSI 3" 150 lbs NPT 1.5" male G 1 1/4 Thread, Internal	Tri-Clamp 1½", 2", 2½" Aseptic clampable 1", screw-in 2", grooved flange 2" Neumo Bioconnect Dairy coupling 2", 2½" Thread G 1¼ Varivent flange
Material	316L SS, Alloy C22, PVDF or PEEK	PVDF, 316 Ti SS	316L SS, Alloy C4, titanium	316L SS, Alloy C22, titanium, PEEK, PVDF, conductive PVDF	316L SS, Alloy C22, titanium, PEEK
Maximum pressure	232 psi	150 psi	60 psi	116 or 232 psi	116 or 232 psi
Maximum temperature	+280°F	+70°F (+285°F, SS version)	+265°F	+14 to +284°F (158° PVDF)	+14 to +284°F
Immersion depth	1.16" to 3.25" (fitting dependent)	1", 2", 3.4"	Up to 28 inches	1.35 inch - 5.30 inch	1.07" to 3.15"
Sensor connection thread	PG13.5	Pg 13.5	Pg 13.5	PG 13.5	PG 13.5
Certificates	EHEDG, ASME BPE, FDA, 3-A	N/A	3.1.B EN 10204	Directive 94/9/EC (ATEX), CE/PED	FDA, EHEDG, Directive 94/9/EC (ATEX), CE/PED, EC VO 1935/2004, Pharmaceuticals Coc, USP Class VI,
Associated cleaning systems	N/A	N/A	Rinse chamber connection G 1/4	Rinse chamber connection. Cleanfit Control CYC25 for GP areas	Rinse chamber connection. Cleanfit Control CYC25 for GP areas





pH / ORP Holder Assemblies

	Cleanfit P CPA472D	Cleanfit P CPA473	Cleanfit P CPA474	Cleanfit P CPA477
				
Application	Chemical, power, process	Water, wastewater, process	Water, wastewater, process	Chemical, wastewater
Description	Manual or pneumatic, can be fully automated with CPC30/310	Manual or pneumatic, can be fully automated with CPC30/310	Manual or pneumatic, can be fully automated with CPC30/310	Pneumatic with pneumatic or electric limit switches
Area of use	Tank or piping (min. 4" diameter)	Tank or piping (min. 3" diameter)	Tank or piping (min. 3" diameter)	Tank or piping (min. 3" diameter)
Process connection	2" Class 150 ANSI flange	2" Class 150 ANSI	2" Class 150 ANSI	Slotted nut Rd 65 x1/6
Material	PVDF, PEEK, 316L SS, Hastelloy C4, Titanium	316L SS	Polypropylene, PVDF, PEEK	316L SS
Maximum pressure	60 or 145 psi	60, 90, or 145 psi	60, 90, or 145 psi	87 psi
Maximum temperature	+32 to +284°F	+180 or +285°F	+180 or +265°F	+40 to +194°F
Immersion depth	5.8 to 11.2 inches	2.4 to 9.3 inches	2.8 to 8.1 inches	4.7 inches
Sensor connection thread	Pg 13.5	Pg 13.5	3/4" NPT (CPF 81/82)	Pg 13.5
Certificates	3.1.B EN 10204	3.1.B EN 10204	N/A	N/A
Associated cleaning systems	Integrated rinse chamber with connection, 1/4" NPT	Integrated rinse chamber with connection, 1/4" NPT	Integrated rinse chamber with connection, 1/4" NPT	Integrated rinse chamber with connection, 1/4" NPT, 1/2" NPT

Modular Holder Assemblies



	Flexdip CYH112	Flexdip CYA112
		
Application	Water and wastewater	Water and wastewater
Description	Single installation point, flexible holder system: for floor, wall or rail mounting	Standard immersion pipe, chain immersion pipe or floater immersion pipe
Area of use	Basins, open channels, open tanks, process vats	Basins, open channels, open tanks, process vats
Sensor installation	Cantilever arm with chain, fixed immersion pipe, free swinging or float-lever version for varying levels	Various sensor connection threads or chain mount adapter. Straight or 45° angle mounting
Compatible sensor holder assemblies	Flexdip CYA112, Dipfit W CLA111, Dipfit W CPA111	Flexdip CYH112
Material	Stainless steel or plastic	Stainless steel or PVC
Ambient temperature	-4 to +140°F	-4 to +140°F
Main pipe height	20", 40", 71"	Lengths vary depending on application
Cantilever arm length	20", 40", 59"	N/A



pH / ORP Transmitters			
	Liquiline® CM442/CM444/CM448 Digital Memosens Field Transmitter 	Liquiline CM442R/CM444R/CM448R Digital Memosens DIN Rail-mount Transmitter 	Liquiline CM42 
Application	Water/wastewater, power, chemical, process industries	Water/wastewater, power, chemical, process industries	Chemical, pharmaceutical, food, water
Measurement type	Universal , multi-parameter transmitter for all Memosens and Memosens protocol sensors, including pH, ORP, conductivity, dissolved oxygen, turbidity/TSS, ammonium, nitrate, SAC/UV254, free chlorine	Universal , multi-parameter transmitter for all Memosens and Memosens protocol sensors, including pH, ORP, conductivity, dissolved oxygen, turbidity/TSS, ammonium, nitrate, SAC/UV254, free chlorine	2-wire transmitter for pH, ORP, conductivity, dissolved oxygen, concentration
Measurement range	Dependent on connected sensor type	Dependent on connected sensor type	pH: -2 to +16 pH ORP: -1500 to +1500 mV Temperature: Pt100, Pt1000, NTC 30K -10 to +300°F
Outputs	Up to eight 0/4 to 20 mA outputs, up to four relays (SPDT), Digital fieldbuses (HART, Profibus, ProfiNet, Modbus (TCP/485) or EtherNet/IP) and discrete outputs.	Up to eight 0/4 to 20 mA outputs, up to four relays (SPDT), Digital fieldbuses (HART, Profibus, ProfiNet, Modbus (TCP/485) or EtherNet/IP) and discrete outputs.	1 x 4 to 20 mA + HART, 2 x 4 to 20 mA + HART Automatic clean and calibration functions
Inputs	From one up to eight digital Memosens sensors, optional analog inputs and discrete inputs.	From one up to eight digital Memosens sensors, optional analog inputs and discrete inputs.	Glass iFET, digital (Memosens®) sensors
Power supply	24 VAC (CM442 only), 50/60 Hz 24 VDC 100-240 VAC, 50/60 Hz	24 VAC (CM442R only), 50/60 Hz 24 VDC (CM444R and CM448R with external DIN-rail power supply) 100-240 VAC, 50/60 Hz (CM444R and CM448R with external DIN-rail power supply)	12.5 to 30 VDC; Profibus or fieldbus 9 to 32 VDC (non-hazardous) or 9 to 17.5 VDC (hazardous)
Ambient temperature	CM442: 0 to 140°F CM444 and CM448: 0 to 120°F	CM442: 32 to 140°F CM444 and CM448: 32 to 120°F External display: 0 to 140°F	-20 to +175°F
Mounting	Wall or pipe	DIN-rail electronics, panel-mount remote display	Wall, pipe, panel mount
Operation	Local interface via LCD display, menu-driven soft keys, and navigator knob. Optional IP addressable webserver. Optional HART, Profibus, ProfiNet, EtherNet/IP™, Modbus digital. Integrates with FieldCare/DeviceCare, Field Data Manager and W@M asset management.	Optional panel-mount remote interface via LCD display, menu-driven soft keys, and navigator knob. Optional IP addressable webserver. Optional HART, Profibus, ProfiNet, EtherNet/IP, Modbus digital. Integrates with FieldCare/DeviceCare, Field Data Manager and W@M asset management.	Via soft keys, LCD display, and navigator; HART, Profibus PA and FOUNDATION Fieldbus
Housing	Polycarbonate housing, IP66/67, NEMA 4X	Remote display: IP66, NEMA 4x when properly mounted.	Polycarbonate plastic housing or 304 SS housing
Approvals / certificates	CE mark CM442 only: FM and CSA: Class 1, Div 2 CM444 and CM448: CSA C/US NI Cl. I, Div. 2, GP A-D	CE mark CM442R, CM444R and CM448R: General purpose	CE, FM, CSA

pH / ORP Transmitters	
	Liquiline To Go CYM290/291 
Application	Chemical, Food, Pharmaceutical, Water, Wastewater
Measurement type	pH, ORP, conductivity, oxygen
Measurement range	Sensor dependent
Output	Display
Sensor input	One Memosens sensor
Additional inputs	Micro USB; 2 temp sensors; CYM290: DIN 19 262 for analog pH, CYM291: M12 Memosens cable
Power	Batteries, 4 AA Alkaline, NiMH rechargeable or 1 Li-ion rechargeable
Ambient temperature	CYM290: +14 to +130°F (-10 to +55°C) CYM291: +14 to +104°F (-10 to +40°C) T3 Duracell MN1500 +14 to +122°F (-10 to +50°C) T4 Energizer E91, Powser one 4106 and Panasonic Pro Power LR6
Operation	Local interface via display, keypad, 2 context-dependent soft keys
Housing	PA12 GF30 + TPE
Protection	IP66/67
Approvals / certificates	CE Mark, CYM290: General Purpose CYM291: Ex approvals; IECEx, ATEX

pH / ORP Handheld	
	Liquiline Mobile CML18 
Application	Laboratories in life science, water, wastewater, chemical, food/beverage
Measurement type	pH, ORP, conductivity, dissolved oxygen
Measurement range	Sensor dependent
Outputs	Display, Bluetooth
Sensor input	Memosens receptacle or M12 cable
Additional inputs	None
Power	Inductive charger (qi qualified)
Ambient temperature	14 to 140°F
Mounting	Handheld or sensor mounted
Operation	Display and two soft keys
Housing	Polycarbonate
Protection	IP66
Approvals / certificates	47 CFR 15.247

pH / ORP Transmitters		
	Liquiline CM82 Digital Memosens Compact Transmitter 	Liquiline CM72 Digital Memosens Compact Transmitter 
Application	Process, industrial	Process, industrial
Measurement type	Memosens pH, ORP, conductive conductivity, dissolved oxygen	Memosens pH, ORP, conductive conductivity, dissolved oxygen
Measurement range	Dependent on connected sensor type	pH: 2-14 (fixed) ORP: 1500 to +1500 mV (fixed) Conductivity: 0 to 20µs/cm, 500µs/cm, 20 ms/cm or 500 ms/cm Oxygen: 0 to 200µg/l or 20 mg/l
Output	4-20 mA (loop powered); HART	4-20 mA (loop powered)
Input	None	None
Power supply	12.6 to 30 VDC (alarm current >20mA) 14 to 30 VDC (alarm current <4 mA)	12.6 to 30 VDC (alarm current >20mA) 14 to 30 VDC (alarm current <4 mA)
Ambient temperature	0 to 185 °F (-20 to 85 °C)	0 to 185 °F (-20 to 85 °C)
Mounting	Sensor mounted	Sensor mounted
Operation	Bluetooth interface (optional)	Fixed output
Housing	PEEK; NEMA 6, IP76/68	PEEK; NEMA 6, IP76/68
Approvals / certificates	CSA C/US General Purpose	CSA C/US General Purpose





Automatic Cleaning	
	Cleaning solution injector CYR10B 
Application	Chemical, water, wastewater
Measurement type	Various
System capabilities	Cleaning, rinsing
System components *	Sensor, electrode holder assembly, program controller, CYR10 injector, spray nozzle
Basic functions	Delivery of rinse water and cleaning solution, externally controlled using Cleanfit Control CYC25
Power supply	110, 230 VAC 24 VDC
Ambient temperature	+23 to +104°F
Mounting	Wall mount
Programming	Liquiline CM44x transmitter with Cleanfit Control CYC25
Housing	CYR10: PVC
Approvals / certificates	General purpose

* Electrode, electrode holder, spray nozzles are purchased separately

pH Buffers	
	pH calibration buffers CPY20-#### 
Application	pH probe calibration/verification
Measurement Type	pH
Values	2.00, 4.00, 7.00, 9.00, 9.22, 10.00, 12.00
Quantities	20x18 ml for 4.00 and 7.00 buffers 250 ml, 1000 ml, 5000 ml
Approvals / certificates	NIST and PTB traceable

Memosens	
	
Application	Food and beverage, chemical, water, wastewater, process industries
Description	Digital transmission of pH signals via cable using contactless inductive connection. Current calibration data is stored in sensor head.
Area of use	Used with CPS11D, 71D, 91D, CPS441D, 471D, and 491D Memosens pH electrodes and connects to CPM153, Liquiline CM42, CPM223/253 transmitters via CYK10 cable
Electrode connection	Twist-lock plug-in connector, water tight
Material	Sensor plug-in: PPS-40GF Cable coupling: PEEK
Process temperature	Depending on sensor, max. +275°F
Process pressure	Depending on sensor, operated up to a safety pressure of 725 psi at +275°F
Certificates	Data cable CYK 10: FM, CSA

Automatic Cleaning	
	Cleanfit Control CYC25 
Application	Chemical, Food, Pharmaceutical, Water, Wastewater, Power
Measurement Type	pH, ORP, conductivity, oxygen
System Capabilities	Pneumatic retractor control, sensor cleaning and rinsing
System Components*	Liquiline CM44x transmitter, Cleanfit Control CYC25, pneumatic retractable assembly (with electric position switches), CYR10 injector (optional)
Basic Functions	Sensor insertion and retraction, cleaning and rinsing control programmed for daily or weekly operation.
Power Supply	24 VDC ±10%
Ambient Temperature	+10 to +113°F (-10 to +45°C)
Mounting	Wall mount or pole mount
Programming	Liquiline CM44x transmitter with relay outputs
Housing	Polycarbonate, IP66/67, NEMA 4X
Protection	IP64
Approvals / certificates	CE Mark









Digital to Analog Converter	
	CYM18 Converter 
Application	Life Sciences, benchtop fermentation measurement
Measurement type	pH, dissolved oxygen
Measurement range	Sensor dependent
Outputs	pH: M12 4-pin, mV signal according to Nerst equation Oxygen: T82 socket, 0-60 mA with 60 nA at 100% saturation
Sensor input	Memosens M12 for pH and dissolved oxygen
Additional inputs	None
Power	USB power supply, 5 V DC
Ambient temperature	23 to 122°F
Mounting	Tabletop
Housing	Aluminum
Approvals / certificates	General purpose



Memocheck® *	
	Memocheck CYP02E Memocheck Sim CYP03D 
Application	Test tools for measuring points with Memosens to simulate digital signal transmission
Area of use	Checking all parameters of pH, ORP, conductivity, dissolved oxygen, chlorine, turbidity, nitrate; Connects to any transmitter with Memosens technology.
Transmitter connection	CYK10 data cable, twist-lock memosens coupling
Material	CYP02E: PET (white plastic), PPS GF 40 (blue plastic) CYP03D: ABS (UL 94 HB)
Power supply	CYP03D only: 3 AA 1.5 V batteries
Ambient temperature	CYP02E: 5 to 158°F CYP03D: 0 to 122°F
Approvals / certificates	CYP02E: FM/CSA IS NI Cl. I, Div. 1&2, GP A-D CYP03D: CSA IS NI Cl. I, Div. 1&2, GP A-D



* Depending on order code selection, the Memocheck system can be used for ORP, conductivity, chlorine, dissolved oxygen, turbidity, and nitrate. Contact Endress+Hauser for details.



Analysis: Conductivity

Conductivity Sensors								
	Condumax W CLS12	Condumax W CLS13	Memosens CLS15D or Condumax W CLS15	Memosens CLS16D or Condumax H CLS16	Condumax W CLS19 Compact	Memosens CLS21D or Condumax W CLS21	Condumax W CLS30	Memosens CLS82D
								
Application	Industrial, water	Industrial high temperature	Pure, ultrapure water	Pure, ultrapure water	Pure, ultrapure water	Water, wastewater	Industrial water	Life Sciences, Biopharmaceutical, Food/beverage, Industrial
Parameter	Conductivity	Conductivity	Conductivity	Conductivity	Conductivity	Conductivity	Conductivity	4-pole conductivity
Material	316L SS	316 Ti SS	316L SS	316L SS	316Ti SS	Graphite	Graphite / titanium	Ceramic, platinum, stainless steel
Measuring range	0.04 to 20 µS/cm 0.1 to 200 µS/cm	0.04 to 20 µS/cm 0.1 to 200 µS/cm	0.04 to 20 µS/cm 0.1 to 200 µS/cm	0.04 to 500 µS/cm	0.04 to 20 µS/cm 0.1 to 200 µS/cm	10 µS/cm to 20 mS/cm	0.1 mS/cm to 200 mS/cm	1 µS/cm to 500 mS/cm
Temperature	-22 to +320°F	-4 to +482°F	Threaded: -4 to +212°F Tri-Clamp: -4 to +266°F -4 to +248°F CLS15D	23 to 248°F 23 to 266°F, CLS16D	14 to 140°F	-4 to +275°F	-4 to +257°F, PTFE -4 to +194°F, PP	23 to 248°F
Temperature sensor	Integrated Pt100	Integrated Pt100	Integrated Pt100, NTC (CLS15D)	Integrated Pt100/1000, NTC (CLS16D)	Integrated Pt100	Integrated Pt100, NTC (CLS21D)	Integrated Pt100/PTC	Integrated Pt1000
Process pressure	580 psi (up to 212°F) 174 psi (up to 302°F)	580 psi	174 psi at 68°F	174 psi at 68°F	87 psi	232 psi at 68°F	87 psi (PTFE) 232 psi (PP)	247 psi at 68°F 131 psi at 248°F
Insertion depth	Minimum 2"	Minimum 2"	Minimum 1.26"	Minimum 0.79"	Minimum 1.38"	Minimum 0.63"	Minimum 2.5"	4.72", minimum 0.59" to wall
Process connection	1" NPT (316 Ti SS)	1" NPT (316 Ti SS)	Fixed cable: ½" NPT (PES), 1½" Tri-Clamp (316L SS) Connector: ¾" NPT (PES), 1½" Tri-Clamp (316L SS)	1", 1½", 2" Tri-Clamp (316L SS), 2 to 5" Varivent	½" NPT (PES)	¾" NPT (PES) 1" NPT (PES) 2" Tri-clamp" (PES or SS)	1" NPT (316 Ti SS, PES) ¾" NPT (PES)	Tri-clamp: 1½", 2" NEUMO Biocontrol D25 Thread: G1 or NPT1 DN25 standard PG 13.5 Varivent N DN40-DN125 Varivent F DN25
Sensor cable	CYK71	CYK71	CYK71, CYK10 (CLS15D)	CPK9, CYK10 (CLS16D)	CYK71	CYK71, CYK10 (CLS21D)	CYK71	CYK10
Approvals / certificates	FM (when used with CLM431, CLM153 and Liquiline® M CM42 transmitters)	FM (when used with CLM431, CLM153 and Liquiline® M CM42 transmitters)	FM/CSA IS/NI Cl. I, Div. 1&2, GP A-D	FM/CSA IS/NI Cl. I, Div. 1&2, GP A-D	General purpose	FM/CSA IS/NI Cl. I, Div. 1&2, GP A-D	FM (when used with CLM431 and CLM153 transmitters)	FM/CSA IS/NI Cl. I, Div. 1&2, GP A-D

Conductivity Sensors			
	CLS50D with Memosens communications or Indumax P CLS50	Indumax H CLS52	CLS54D with Memosens communications or Indumax H CLS54
			
Application	Chemical, process	Food, beverage, pharmaceutical	Food, beverage, pharmaceutical
Parameter	Conductivity	Conductivity	Conductivity
Material	PFA/PEEK	PEEK	Virgin PEEK
Measuring range	2 µS/cm to 2000 mS/cm	10 µS/cm to 2000 mS/cm	100 µS/cm to 2000 mS/cm
Temperature	-4 to +356°F	23 to 257°F	14 to 257°F
Temperature sensor	Integrated Pt100	Integrated Pt100	Integrated Pt1000
Process pressure	290 psi (without flange) 232 psi (with flange)	232 psi	232 psi 174 psi (CLS54D)
Insertion depth	Sensor head must be completely submerged	Minimum 1.3"	Sensor head must be completely submerged
Process connection	1" NPT (PEEK) 2" Class 150 ANSI (PVDF) 2" Class 150 ANSI (316L SS)	2" Tri-Clamp 2" Perlick Varivent	2" Tri-Clamp Varivent NEUMO BioControl D50
Sensor cable	Fixed cable, CYK10 (CLS50D)	CLK5 fixed cable	CLK5 fixed cable, CYK10 (CLS54D)
Approvals / certificates	FM/CSA IS/NI Cl. I, Div. 1&2, GP A-D	General purpose	General purpose, 3A, EHEDG, FDA, USP class VI, FM (when used with Liquiline M CM42)



Conductivity Holder Assemblies		
	Dipfit W CLA111	Dipfit P CLA140
		
Application	Water, wastewater, process	Chemical, wastewater, process
Description	Single installation point, CLS21 or CLS50 electrode, immersion holder	Single installation point for CLS50 electrode, immersion holder, bayonet style
Area of use	Open channels, basins, tanks	Open tank, channel, closed tank
Process connection	Adjustable flange, suspension bracket, mounting bracket	3" Class 150 ANSI flange
Material	Polypropylene	316L SS, PVDF
Maximum pressure	Non-pressurized systems	145 psi
Maximum temperature	176°F	302°F
Immersion depth	3 to 10 ft	1.5 to 7.5 ft
Sensor connection thread	G1, G¾	G¾
Certificates	N/A	N/A
Associated cleaning systems	External spray cleaning (CLR30 spray head)	N/A





Conductivity Transmitters

	Smartec CLD18 	Smartec S CLD132 	Smartec S CLD134 
Application	Food, beverage, pharmaceutical and biotech	Chemical, beverage, water	Food, beverage, pharmaceutical and biotech
Measurement type	Inductive conductivity, 4-wire electronics	Inductive conductivity 4-wire transmitter	Inductive conductivity 4-wire transmitter
Measurement range	Conductivity: 200 μ S/cm to 1000 mS/cm Temperature: 14 to 266°F	Conductivity: 0 μ S/cm to 2000 mS/cm Temperature: 14 to 302°F	Conductivity: 100 μ S/cm to 2000 mS/cm Concentration: 0 to 30% Temperature: -31 to +482°F
Output	Two: 0/4-20 mA One: Alarm; Open collector	0/4 to 20 mA, HART, Profibus	0/4 to 20 mA, HART, Profibus, temperature
Input	Binary for measurement range switching	0/4 to 20 mA 10 to 50 V digital (inputs 1 and 2)	0/4 to 20 mA 10 to 50 V digital (inputs 1 and 2), Pt1000 switchable to Pt100
Power supply	24 VDC, 3 W	100/115/230 VAC 24 VAC/VDC	100/115/230 VAC 24 VAC/VDC
Ambient temperature	-4 to +140°F	-13 to +158°F	32 to +131°F
Mounting	Compact: direct via conductivity probe	Compact: direct via CLS52 sensor Remote: Wall, pipe	Compact: direct via CLS54 sensor Remote: Wall, pipe
Operation	Via interface buttons and LCD display	Via push buttons and LCD display, HART or Profibus PA/DP	Via push buttons and LCD display, HART or Profibus PA/DP
Housing	Stainless steel or plastic	304 SS	304 SS
Approvals / certificates	General purpose; CE, 3A, FDA	General purpose	General purpose, 3A, EHEDG, FDA, USP class VI

Conductivity Transmitters

	Liquiline CM442/CM444/CM448 Digital Memosens Field Transmitter 	Liquiline CM442R/CM444R/CM448R Digital Memosens DIN Rail-mount Transmitter 	Liquiline M CM42 
Application	Water/wastewater, power, chemical, process industries	Water/wastewater, power, chemical, process industries	Chemical, pharmaceutical, food, water
Measurement type	Universal, multi-parameter transmitter for all Memosens® and Memosens protocol sensors, including pH, ORP, conductivity, dissolved oxygen, turbidity/TSS, ammonium, nitrate, SAC/UC254, free chlorine	Universal, multi-parameter transmitter for all Memosens® and Memosens protocol sensors, including pH, ORP, conductivity, dissolved oxygen, turbidity/TSS, ammonium, nitrate, SAC/UC254, free chlorine	2-wire transmitter for pH, ORP, conductivity, dissolved oxygen, concentration
Measurement range	Dependent on connected sensor type	Dependent on connected sensor type	Conductivity: 0.1 μ S/k to 20 mS/k Resistivity: 10 M Ω /k to 50 Ω /k Concentration: 0 to 30% Temperature: Pt100, Pt1000
Outputs	Up to eight 0/4 to 20 mA outputs, up to four relays (SPDT), Digital fieldbuses (HART, Profibus, ProfiNet, Modbus (TCP/485) or EtherNet/IP), and discrete outputs.	Up to eight 0/4 to 20 mA outputs, up to four relays (SPDT), Digital fieldbuses (HART, Profibus, ProfiNet, Modbus (TCP/485) or EtherNet/IP), and discrete outputs.	1 x 4 to 20 mA + HART, 2 x 4 to 20 mA + HART Automatic clean and calibration functions
Inputs	From one up to eight digital Memosens sensors, optional analog input and discrete inputs.	From one up to eight digital Memosens sensors, optional analog input and discrete inputs.	Analog sensors, two and four electrode, conductivity (inductive and resistive), concentration
Power supply	24 VAC (CM442 only), 50/60 Hz 24 VDC 100-240 VAC, 50/60 Hz	24 VAC (CM442R only), 50/60 Hz 24 VDC (CM444R and CM448R with external DIN-rail power supply) 100-240 VAC, 50/60 Hz (CM444R and CM448R with external DIN-rail power supply)	12.5 to 30 VDC; Profibus or fieldbus 9 to 32 VDC, (non-hazardous) or 9 to 17.5 VDC (hazardous)
Ambient temperature	CM442: 0 to 140°F CM444 and CM448: 0 to 120°F	CM442: 32 to 140° F CM444 and CM448: 32 to 120°F External display: 0 to 140°F	-20 to +175°F
Mounting	Wall or pipe	DIN-rail electronics, panel-mount remote display	Wall, pipe, panel mount
Operation	Local interface via LCD display, menu-driven soft keys, and navigator knob. Optional IP addressable webserver. Optional HART, Profibus, EtherNet/IP, Modbus digital. Integrates with FieldCare/DeviceCare, Field Data Manager and W@M asset management.	Optional panel-mount remote interface via LCD display, menu-driven soft keys, and navigator knob. Optional IP addressable webserver. Optional HART, Profibus, ProfiNet, EtherNet/IP, Modbus digital. Integrates with FieldCare/DeviceCare, Field Data Manager and W@M asset management.	Via soft keys, LCD display, and navigator; HART, Profibus PA and FOUNDATION Fieldbus
Housing	Polycarbonate housing. IP66/67, NEMA 4X	Remote display: IP66, NEMA 4x when properly mounted.	Polycarbonate plastic housing or 304 SS housing
Approvals / certificates	CE mark CM442 only: FM and CSA; Class 1, Div 2 CM444 and CM448: CSA C/US NI Cl. I, Div. 2, GP A-D	CE mark CM442R, CM444R and CM448R: General purpose	CE, FM, CSA



Conductivity Transmitters		
	Liquiline CM82 Digital Memosens Compact Transmitter	Liquiline CM72 Digital Memosens Compact Transmitter
		
Application	Process, industrial	Process, industrial
Measurement type	Memosens pH, ORP, conductive conductivity, dissolved oxygen	Memosens pH, ORP, conductive conductivity, dissolved oxygen
Measurement range	Dependent on connected sensor type	pH: 2-14 (fixed) ORP: 1500 to +1500 mV (fixed) Conductivity: 0 to 20µs/cm, 500µs/cm, 20 ms/cm or 500 ms/cm Oxygen: 0 to 200µg/l or 20 mg/l
Output	4-20 mA (loop powered); HART	4-20 mA (loop powered)
Input	None	None
Power supply	12.6 to 30 VDC (alarm current >20mA) 14 to 30 VDC (alarm current <4 mA)	12.6 to 30 VDC (alarm current >20mA) 14 to 30 VDC (alarm current <4 mA)
Ambient temperature	0 to 185 °F (-20 to 85 °C)	0 to 185 °F (-20 to 85 °C)
Mounting	Sensor mounted	Sensor mounted
Operation	Bluetooth interface (optional)	Fixed output
Housing	PEEK; NEMA 6, IP76/68	PEEK; NEMA 6, IP76/68
Approvals / certificates	CSA C/US General Purpose	CSA C/US General Purpose





Conductivity Handheld	
	Liquiline Mobile CML18
	
Application	Laboratories in life science, water, wastewater, chemical, food/beverage
Measurement type	pH, ORP, conductivity, dissolved oxygen
Measurement range	Sensor dependent
Outputs	Display, Bluetooth
Sensor input	Memosens receptacle or M12 cable
Additional inputs	None
Power	Inductive charger (qi qualified)
Ambient temperature	14 to 140°F
Mounting	Handheld or sensor mounted
Operation	Display and two soft keys
Housing	Polycarbonate
Protection	IP66
Approvals / certificates	47 CFR 15.247



Conductivity Calibration	
	Conductivity calibration Conductal CLY421
	
Application	Pharmaceutical, food, ultrapure water
Measurement type	Conductivity calibration
Measurement range	Up to 20 µS/cm or MΩ, adjustable
Reference electrode	CLS15D
Reference transmitter	CM42
Power supply	115 VAC
Fluid temperature range	32 to 212°F
Pressure maximum	87 psi (flow assembly)
Minimum flow	0.13 GPM (flow assembly)
Approvals / certificates	ASTM 5391-93



Conductivity Calibration Solutions	
	Precision calibration solution CLY11
	
Application	Field calibration for conductivity electrodes
Measurement type	Conductivity
Calibration solution (at 76°F)	CLY11-A (50081902): 74.0 µS/cm CLY11-B (50081903): 149.6.0 µS/cm CLY11-C (50081904): 1.406 mS/cm CLY11-D (50081905): 12.64 mS/cm CLY11-E (50081906): 107.00 mS/cm
Storage temperature	14 to 122°F
Approvals / certificates	Traceable to : ASTM 5391-93





Analysis: Disinfection



Disinfection Sensors				
	Chlorine dioxide Memosens CCS50D 	Free chlorine Memosens CCS51D 	Total chlorine Memosens CCS120D 	Free Bromine Memosens CCS55D 
Application	Drinking and process waters	Drinking and process water	Wastewater and process water	Sea water and utilities
Parameter	Chlorine dioxide (ClO ₂)	Free Chlorine (HOCl)	Total Chlorine	Free Bromine (HOBr)
Material	PVC, PVDF, FKM (Viton)	PVC, PVDF, FKM (Viton)	PVC, PPE membrane	PVC, PVDF, FKM (Viton)
Measuring range	0 to 5 mg/l (ppm) 0 to 20 mg/l (ppm) 0 to 200 mg/l (ppm)	0 to 5 mg/l (ppm) 0 to 20 mg/l (ppm) 0 to 200 mg/l (ppm)	0.1 to 10 mg/L (0.1ppm)	0 to 5 mg/l (ppm) 0 to 20 mg/l (ppm) 0 to 200 mg/l (ppm)
Temperature	0 to 55 °C (32 to 130 °F)	0 to 55 °C (32 to 130 °F),	5 to 45 °C (41 to 113 °F)	0 to 55 °C (32 to 130 °F)
pH value range	0 to 14	4 to 9	5.5 to 9.5	5 to 10
Maximum back pressure	14.5 psi (1 bar)	14.5 psi (1 bar)	14.5 psi (1 bar)	14.5 psi (1 bar)
Installation	CCA151 Flowfit, CYA112 Flexdip	CCA250 Flowfit	CCA250 Flowfit, CYA112 Flexdip	CCA151, CCA250 or CYA112 Flexdip
Sensor cable	CYK10 Memosens	CYK10 Memosens	CYK10 Memosens	CYK10 Memosens
Transmitter	CM44x(R)	CM44x(R)	CM44x(R)	CM44x(R)
Approvals / certificates	CSA C/US NI Cl. I, Div. 2, GP A-D	CSA C/US NI Cl. I, Div. 2, GP A-D	CSA C/US NI Cl. I, Div. 2, GP A-D	CSA C/US NI Cl. I, Div. 2, GP A-D

Disinfection Flow Holder Assemblies		
	Flowfit CCA250 	Flowfit CCA151 
Application	Drinking, process water	Drinking, process water
Description	Flow assembly designed to hold one chlorine sensor and up to two pg 13.5 sensors.	Flow assembly designed to hold one chlorine sensor.
Material	Plexiglass (PMMA), PVC, 316 SS	Plexiglass (PMMA)
Maximum pressure	14 psi	58 psi
Maximum temperature	113° F	0 to 60 °C (32 to 140 °F)
Measured water flow	7 to 30 gal/hr, adjustable	1.3 gal/hr (5 l/h)
Sensor connection	One internal thread connection for CCS series disinfection sensor. Two PG 13.5 for pH and/or ORP electrodes (120 mm only)	One internal thread connection for CCS series disinfection sensor

Modular Holder Assemblies		
	Flexdip CYH112 	Flexdip CYA112 
Application	Water and wastewater	Water and wastewater
Description	Single installation point, flexible holder system: for floor, wall or rail mounting	Standard immersion pipe, chain immersion pipe or floater immersion pipe
Area of use	Basins, open channels, open tanks, process vats	Basins, open channels, open tanks, process vats
Sensor installation	Cantilever arm with chain, fixed immersion pipe, free swinging or float-lever version for varying levels	Various sensor connection threads or chain mount adapter. Straight or 45° angle mounting
Compatible sensor holder assemblies	Flexdip CYA112, Dipfit W CLA111, Dipfit W CPA111	Flexdip CYH112
Material	Stainless steel or PVC	Stainless steel or PVC
Ambient temperature	-4 to +140°F	-4 to +140°F
Main pipe height	20", 40", 71"	Lengths vary depending on application
Cantilever arm length	20", 40", 59"	N/A







Disinfection Transmitters		
	Liquiline CM442/CM444/CM448 Digital Memosens Transmitter 	Liquiline CM442R/CM444R/CM448R Digital Memosens DIN Rail-mount Transmitter 
Application	Water/wastewater, power, chemical, process industries	Water/wastewater, power, chemical, process industries
Measurement type	Memosens® transmitter for pH, ORP, conductivity, dissolved oxygen, turbidity, nitrate, chlorine	Universal , multi-parameter transmitter for all Memosens® and Memosens protocol sensors, including pH, ORP, conductivity, dissolved oxygen, turbidity/TSS, ammonium, nitrate, SAC/UC254, free chlorine
Measurement range	Dependent on sensor type	Dependent on connected sensor type
Outputs	Up to eight 0/4 to 20 mA outputs, up to four relays (SPDT), Digital fieldbuses (HART, Profibus, ProfiNet, Modbus (TCP/485) or EtherNet/IP), and discrete outputs.	Up to eight 0/4 to 20 mA outputs, up to four relays (SPDT), Digital fieldbuses (HART, Profibus, ProfiNet, Modbus (TCP/485) or EtherNet/IP), and discrete outputs.
Inputs	From one up to eight digital Memosens sensors, optional analog input and discrete inputs.	From one up to eight digital Memosens sensors, optional analog input and discrete inputs.
Power supply	24 VAC (CM442 only), 50/60 Hz 24 VDC 100-240 VAC, 50/60 Hz	24 VAC (CM442R only), 50/60 Hz 24 VDC (CM444R and CM448R with external DIN-rail power supply) 100-240 VAC, 50/60 Hz (CM444R and CM448R with external DIN-rail power supply)
Ambient temperature	-4 to +140°F	CM442: 32 to 140° F, CM444 and CM448: 32 to 120°F, External display: 0 to 140°F
Mounting	Wall, pipe, panel mount	DIN-rail electronics, panel-mount remote display
Operation	Optional panel-mount remote interface via LCD display, menu-driven soft keys, and navigator knob. Optional IP addressable webserver. Optional HART, Profibus, ProfiNet, EtherNet/IP, Modbus digital. Integrates with FieldCare/DeviceCare, Field Data Manager and W@M asset management.	Optional panel-mount remote interface via LCD display, menu-driven soft keys, and navigator knob. Optional IP addressable webserver. Optional HART, Profibus, ProfiNet, EtherNet/IP, Modbus digital. Integrates with FieldCare/DeviceCare, Field Data Manager and W@M asset management.
Housing	Polycarbonate plastic housing	Remote display: IP66, NEMA 4x when properly mounted.
Approvals / certificates	CE Mark CM442: FM/CSA; Cl. I, Div. 2 GP A-D CM444 and CM448: CSA C/US NI Cl. I, Div. 2 GP A-D	CE mark CM442R, CM444R and CM448R: General pupose

Disinfection Analysis Systems			
	Free Chlorine Systems	Total Chlorine Systems	Expansion Panel
	71367911, 71367912, 71502871, 71337195, 71337196, 71502872, 71452648, 71454792 	71464226, 71464231, 71502873 	71464233 
Application	Free chlorine analysis with pH compensation	Total Chlorine analysis	Flow and holder assembly for adding disinfection sensors to an existing disinfection analysis system with a CM444 transmitter.
Measurement Type	Amperometric Chlorine	Amperometric Chlorine	Sensor(s) and cables ordered separately
Measuring Range	0 to 5 mmp (mg/l) 0 to 20 ppm (mg/l) 0 to 200 ppm (mg/l)	0.1 to 10 ppm (mg/l)	Sensor dependent
Flow cell	CCA250, plexiglass	CCA250, plexiglass	CCA250, plexiglass
Operating Pressure	Controlled to 15 psi with lead-free regulator	Controlled to 15 psi with lead-free regulator	Controlled to 15 psi with lead-free regulator
Transmitter	Liquiline CM442 or CM444	Liquiline CM442 or CM444	None. Sensors connect to existing disinfection system with CM444 transmitter
Outputs	With CM442: Two 0/4-20 mA outputs, alarm relay and two discrete outputs. With CM444: Up to eight 0/4-20 mA outputs, alarm relay, up to four relay outputs (SPDT), Digital fieldbuses (HART, Profibus DP, ProfiNet, Modbus (485 or TCP) or EtherNet/IP, discrete outputs.	With CM442: Two 0/4-20 mA outputs, alarm relay and two discrete outputs. With CM444: Up to eight 0/4-20 mA outputs, alarm relay, up to four relay outputs (SPDT), Digital fieldbuses (HART, Profibus DP, ProfiNet, Modbus (485 or TCP) or EtherNet/IP, discrete outputs.	
Inputs	CM442: Memosens CCS51D free chlorine sensor and Memosens CPS13D pH CM444: Memosens CCS51D free chlorine and Memosens CPS13D pH and up to six additional sensors.	CM442: Memosens CCS120D total chlorine sensor. CM444: Memosens CCS120D total chlorine sensor to seven additional sensors.	
Power Supply	120-240 VAC, 50-60 Hz	120-240 VAC, 50-60 Hz	
Display/Local Interface	Liquiline CM442 or CM444	Liquiline CM442 or CM444	
Ambient Temperature	CM442: 0-140 °F CM444: 0-120 °F	CM442: 0-140 °F CM444: 0-120 °F	
Mounting	Wall mountable stainless steel panel	Wall mountable stainless steel panel	Wall mountable stainless steel panel
Operation	Local interface via LCD display, menu-driven soft keys and navigator knob. Optional IP addressable webserver. Optional HART, Profibus DP, ProfiNet, Modbus (TCP or 485) or EtherNet/IP. Integrates with Fieldcare/DeviceCare, Field Data Manager and W@M asset management.	Local interface via LCD display, menu-driven soft keys and navigator knob. Optional IP addressable webserver. Optional HART, Profibus DP, ProfiNet, Modbus (TCP or 485) or EtherNet/IP. Integrates with Fieldcare/DeviceCare, Field Data Manager and W@M asset management.	
Housing (transmitter)	Polycarbonate housing, IP66/67, Nema 4X	Polycarbonate housing, IP66/67, Nema 4X	
Approvals/Certification	Transmitters: CE marked CM442 and CM444: CSA C/US General purpose System: EPA compliant to Method 334.0	Transmitters: CE marked, CM442 and CM444: CSA C/US General purpose System: EPA compliant to Method 334.0	







Analysis: Dissolved Oxygen

Dissolved Oxygen Sensors		
	Memosens COS81D 	Memosens COS22D or Oxymax® COS22 
Application	Life Sciences, Biopharmaceutical, Food/beverage, Industrial	Food and beverage, life sciences, power
Parameter	Dissolved oxygen, Oxygen, Temperature	Sterilizable amperometric dissolved oxygen
Material	316L SS, FKM (fluoroelastomer), EPDM (Ethylene Propylene Diene Monomer), Silicon	316L SS, Silicone membrane cap (FDA), PTFE, steel mesh
Measuring range	U-Cap: 4 µg/L to 30 mg/L; 4 ppb to 30 ppm; 0.1 to 700 hPa; 0.05 to 330% saturation C-Cap: 4 µg/L to 26 mg/L; 4 ppb to 26 ppm; 0.1 to 600 hPa; 0.05 to 285% saturation.	0 to 100 ppb (trace version only) 0.01 to 60 mg/L 0 to 600% saturation 0 to 1200 hPa 0 to 25 Vol% (gaseous oxygen)
Temperature sensor	Integrated Pt1000	Integrated NTC
Ambient temperature	23 to 212 °F (-5 to 100 °C)	-5 to +135°C (23 to 175°F)
Process temperature	32 to 140 °F (0 to 60 °C) C cap 32 to 175 °F (0 to 80 °C) U cap	-5 to +135°C (23 to 175°F)
Process pressure	0 to 190 psi (0.02 to 13 bar) absolute	12 bar (174 psi)
Shaft length	120 mm, 220 mm	120, 225, 360, 420 mm
Process connection	PG 13.5 thread	PG 13.5 thread
Sensor cable	CYK10 Memosens	COK21 (COS22), CYK10 (22D)
Transmitter	Liquiline CM42, CM442/CM444/CM448, CM442R/CM444R/CM448R	COS22: Liquisys M COM223F/COM253F COS22D: Liquiline® CM42, CM442/444/448 and CM442R/444R/448R
Approvals / certificates	CSA C/US IS NI Cl. I, Div. 1&2, GP A-D	FM/CSA IS NI Cl. I, Div. 1&2, GP A-D

Dissolved Oxygen Sensors		
	COS61D digital sensor with Memosens communications or Oxymax W COS61 (Optical sensor) 	Oxymax W COS51D Digital sensor with Memosens communications 
Application	Water, wastewater, fish farming	Water, wastewater, fish farming
Parameter	Optical (luminescence/fluorescence) dissolved oxygen	Amperometric dissolved oxygen
Material	316 Ti SS, POM, Silicon (fluorescence layer)	POM
Measuring range	0 to 20 ppm 0 to 200% saturation 0 to 400 hPa	0.01 to 100 ppm 0.00 to 100% saturation 0 to 2000 hPa
Temperature sensor	Integrated NTC	Integrated NTC
Ambient temperature	-20 to +60°C (0 to 140°F)	-5 to +50°C (20 to 120°F)
Process temperature	-5 to +60°C (20 to 140°F)	-5 to +50°C (20 to 120°F)
Process pressure	0 to 10 bar (145 psi)	0 to 10 bar (145 psi)
Shaft length	N/A	N/A
Process connection	COS61: G1" thread COS61D: Combination ¾" MNPT and G1" thread	Combination ¾" MNPT and G1" thread
Sensor cable	COS61: Fixed cable or TOP68 with CYK71 cable COS61D: Fixed cable	CYK10
Transmitter	COS61: Liquisys M COM223/253 COS61D: Liquiline CM442/444/448 and CM442R/444R/448R	Liquiline CM42, CM442/444/448 and CM442R/444R/448R
Approvals / certificates	CSA C/US GP	FM/CSA IS/NI Cl. I, Div. 1&2, GP A-D





Dissolved Oxygen and Multi Parameter Transmitters			
	Liquiline CM442/CM444/CM448 Digital Memosens Field Transmitter 	Liquiline CM442R/CM444R/CM448R Digital Memosens DIN Rail-mount Transmitter 	Liquiline CM42 
Application	Water/wastewater, power, chemical, process industries	Water/wastewater, power, chemical, process industries	Chemical, pharmaceutical, food, water
Measurement type	Universal , multi-parameter transmitter for all Memosens and Memosens protocol sensors, including pH, ORP, conductivity, dissolved oxygen, turbidity/TSS, ammonium, nitrate, SAC/UC254, free chlorine	Universal , multi-parameter transmitter for all Memosens® and Memosens protocol sensors, including pH, ORP, conductivity, dissolved oxygen, turbidity/TSS, ammonium, nitrate, SAC/UC254, free chlorine	2-wire transmitter for pH, ORP, conductivity, dissolved oxygen, concentration
Measurement range	Dependent on connected sensor type	Dependent on connected sensor type	0.0 to 100.0 ppm, 0 to 1000% saturation, 0 to 2000 hPa Temperature: -10 to +300°F
Outputs	Up to eight 0/4 to 20 mA outputs, up to four relays (SPDT), Digital fieldbuses (HART, Profibus, ProfiNet, Modbus (TCP/485), or EtherNet/IP) and discrete outputs.	Up to eight 0/4 to 20 mA outputs, up to four relays (SPDT), Digital fieldbuses (HART, Profibus, ProfiNet, Modbus (TCP/485), EtherNet/IP) and discrete outputs.	1 x 4 to 20 mA + HART, 2 x 4 to 20 mA + HART, Profibus PA, FOUNDATION Fieldbus
Inputs	From one up to eight digital Memosens sensors, optional analog input and discrete inputs.	From one up to eight digital Memosens sensors, optional analog input and discrete inputs.	Digital sensor: All Memosens sensors and Memosens technology inductive conductivity sensors Analog sensors: pH, differential pH, ISFET pH, ORP, two and four electrode conductivity/resistivity, and inductive conductivity/concentration
Power supply	24 VAC (CM442 only), 50/60 Hz 24 VDC 100-240 VAC, 50/60 Hz	24 VAC (CM442R only), 50/60 Hz 24 VDC (CM444R and CM448R with external DIN-rail power supply) 100-240 VAC, 50/60 Hz (CM444R and CM448R with external DIN-rail power supply)	12.5 to 30 VDC, Profibus or fieldbus 9 to 32 VDC (non-hazardous) or 9 to 17.5 VDC (hazardous)
Ambient temperature	CM442: 0 to 140°F CM444 and CM448: 0 to 120°F	CM442: 32 to 140°F CM444 and CM448: 32 to 120°F External display: 0 to 140°F	-20 to +175°F
Mounting	Wall or pipe	DIN-rail electronics, panel-mount remote display	Wall, pipe, panel mount
Operation	Local interface via LCD display, menu-driven soft keys, and navigator knob. Optional IP addressable webserver. Optional HART, Profibus, ProfiNet, EtherNet/IP, Modbus digital. Integrates with FieldCare/DeviceCare, Field Data Manager and W@M asset management.	Optional panel-mount remote interface via LCD display, menu-driven soft keys, and navigator knob. Optional IP addressable webserver. Optional HART, Profibus, ProfiNet, EtherNet/IP, Modbus digital. Integrates with FieldCare/DeviceCare, Field Data Manager and W@M asset management.	Via soft keys, LCD display, and navigator HART, Profibus PA, and FOUNDATION Fieldbus
Housing	Polycarbonate housing, IP66/67, NEMA 4X	Remote display: IP66, NEMA 4x when properly mounted.	Polycarbonate plastic housing or 304 SS housing
Approvals / certificates	CE mark CM442 only: FM and CSA; Class 1, Div 2 CM444 and CM448: CSA C/US NI Cl. I, Div. 2 GP A-D	CE mark CM442R, CM444R and CM448R: General purpose	CE, FM, CSA



Dissolved Oxygen Transmitters		
	Liquiline CM82 Digital Memosens Compact Transmitter 	Liquiline CM72 Digital Memosens Compact Transmitter 
Application	Process, industrial	Process, industrial
Measurement type	Memosens pH, ORP, conductive conductivity, dissolved oxygen	Memosens pH, ORP, conductive conductivity, dissolved oxygen
Measurement range	Dependent on connected sensor type	pH: 2-14 (fixed) ORP: 1500 to +1500 mV (fixed) Conductivity: 0 to 20µs/cm, 500µs/cm, 20 ms/cm or 500 ms/cm Oxygen: 0 to 200µg/l or 20 mg/l
Output	4-20 mA (loop powered); HART	4-20 mA (loop powered)
Input	None	None
Power supply	12.6 to 30 VDC (alarm current >20mA) 14 to 30 VDC (alarm current <4 mA)	12.6 to 30 VDC (alarm current >20mA) 14 to 30 VDC (alarm current <4 mA)
Ambient temperature	0 to 185 °F (-20 to 85 °C)	0 to 185 °F (-20 to 85 °C)
Mounting	Sensor mounted	Sensor mounted
Operation	Bluetooth interface (optional)	Fixed output
Housing	PEEK, NEMA 6, IP76/68	PEEK, NEMA 6, IP76/68
Approvals / certificates	CSA C/US General Purpose	CSA C/US General Purpose

Dissolved Oxygen Handheld	
	Liquiline Mobile CML18 
Application	Laboratories in life science, water, wastewater, chemical, food/beverage
Measurement type	pH, ORP, conductivity, dissolved oxygen
Measurement range	Sensor dependent
Outputs	Display, Bluetooth
Sensor input	Memosens receptacle or M12 cable
Additional inputs	None
Power	Inductive charger (qi qualified)
Ambient temperature	14 to 140°F
Mounting	Handheld or sensor mounted
Operation	Display and two soft keys
Housing	Polycarbonate
Protection	IP66
Approvals / certificates	47 CFR 15.247

Digital to Analog Converter	
	CYM18 Converter 
Application	Life Sciences, benchtop fermentation measurement
Measurement type	pH, dissolved oxygen
Measurement range	Sensor dependent
Outputs	pH: M12 4-pin, mV signal according to Nerst equation Oxygen: T82 socket, 0-60 mA with 60 nA at 100% saturation
Sensor input	Memosens M12 for pH and dissolved oxygen
Additional inputs	None
Power	USB power supply, 5 V DC
Ambient temperature	23 to 122°F
Mounting	Tabletop
Housing	Aluminum
Approvals / certificates	General purpose





Dissolved Oxygen Holder Assemblies			
	Flowfit W COA250	Flowfit CYA251	Cleanfit COA451
			
Application	Water, wastewater	Process, wastewater	Water, wastewater
Description	Flow assembly designed for bypass system, for dissolved oxygen sensor COS51D or COS61D	Flow assembly for nitrate/SAC (CAS51D), turbidity (CUS51D), dissolved oxygen (COS51D, COS61D)	Manually operated SS holder assembly with ball valve and rinse connections, designed to hold COS31 or COS41
Material	PVC	PVC, EPDM (seals)	316L SS
Maximum pressure	87 psi at 68°F	87 psi at 68°F	145 psi (29 psi for manual operation)
Maximum temperature	122°F	32 to 120°F	32 to 122°F
Flow rate	26 to 260 gal/hr	53 gal/hr for oxygen, 26.5 for turbidity and UV nitrate	N/A, must be constant flow
Sensor connection	Threaded mounting sleeve with union nut	Compression fitting	Internal, with sensor external threads
Holder installation	Bypass line	Inline or bypass line: G1 1/4 external thread, PVC ANSI Flange, PVC DN20, PVC DN25 hose barb, PVC Rp 3/4" female thread, PVC NPT 3/4" female thread, PVC	Weld neck, 2" Class 150 ANSI flange

Modular Holder Assemblies		
	Flexdip CYH112	Flexdip CYA112
		
Application	Water and wastewater	Water and wastewater
Description	Single installation point, flexible holder system: for floor, wall or rail mounting	Standard immersion pipe, chain immersion pipe or floater immersion pipe
Area of use	Basins, open channels, open tanks, process vats	Basins, open channels, open tanks, process vats
Sensor installation	Cantilever arm with chain, fixed immersion pipe, free swinging or float-lever version for varying levels	Various sensor connection threads or chain mount adapter. Straight or 45° angle mounting
Compatible sensor holder assemblies	Flexdip CYA112, Dipfit W CLA111, Dipfit W CPA111	Flexdip CYH112
Material	Stainless steel or PVC	Stainless steel or PVC
Ambient temperature	-4 to +140°F	-4 to +140°F
Main pipe height	20", 40", 71"	Lengths vary depending on application
Cantilever arm length	20", 40", 59"	N/A





NOTE: Other holder assemblies are available, refer to pH holder information for CPA240, CPA450, CPA442.



Analysis: Turbidity



Turbidity Sensors			
	Turbimax CUS50D with Memosens communications	Turbimax CUS51D with Memosens communications	Turbimax CUS52D with Memosens communications
			
Application	Wastewater, industrial	Water, wastewater	Water, wastewater
Parameter	Turbidity and Total Suspended Solids (TSS)	Turbidity and Total Suspended Solids (TSS)	Turbidity, temperature
Measurement method	Light attenuation/absorption	90° and 135° back-scatter, 4-beam pulsed light, 860 nm LED	90°F scattered light, 860 nm (Infrared)
Material	316Ti SS or PPS; PTFE optical sensor head	316L SS, sapphire optical window	316L SS or PEEK /PPS, sapphire optical window
Measuring range	Absorbance: 0.00 to 5.00 Au or 0.000 to 10.000 OD Turbidity: 40 to 4,000 FAU Solids: 0 to 25 g/L (sludge)	C1 version – Turbidity: 0 to 4000 FNU Solids content: 0 to 4 g/l D1 version – Turbidity: 0 to 4000 FNU Solids: 0 to 300 g/L, 0 to 30%	0.000 to 4000 FNU
Temperature sensor	Integrated NTC	N/A	Integrated NTC
Ambient temperature	-4 to 140 °F	-4 to +140°F	-4 to 185°F
Process temperature	-4 to 185 °F	23 to 120°F	316L SS: -4 to 185 °F; Plastic: -4 to 140 °F
Process pressure	0.5 to 4.5 bar (7.3 to 65.3 psia)	0.5 to 10 bar (7 to 145 psia)	316L SS: 7.3 to 134 psi; Plastic: 7.3 to 87 psi
Process connection	Combination 3/4" MNPT and G1" thread 2" Tri-clamp (depends on sensor version)	Combination 3/4" MNPT and G1" thread	Combination 3/4" MNPT and G1" thread 2" clamp (depends on sensor version)
Installation type	Submersible, optional accessories available for flow through and insertion installations	Submersible, optional accessories available for flow through and insertion installations	Submersible, optional accessories available for flow through and insertion installations
Sensor cable	Fixed	Fixed	Fixed
Transmitter	Liquiline® CM442/444/448 or CM442R/444R/448R	Liquiline® CM442/444/448 or CM442R/444R/448R	Liquiline® CM442/444/448 or CM442R/444R/448R

Sludge Level Sensor	
	Turbimax CUS71D with Memosens communications
Application	Water, wastewater
Parameter	Submersed Ultrasonic Interface Level Sensor (with or without wiper)
Measurement method	Ultrasonic
Material	ABS and epoxy plastic, rubber wiper
Measuring range	1.0 to 32 ft 0 to 50 NTU
Process temperature	34 to 122°F
Process pressure	0 to 87 psi
Process connection	Combination 3/4" MNPT and G1" thread
Immersion depth	Submersible
Sensor cable	Fixed
Transmitter	Liquiline CM442/444/448 or CM442R/444R/448R

Turbidity Holder Assemblies					
	Flowfit W CUA120/250	Flowfit CUA252	Flowfit CUA262	Flowfit CYA251	Cleanfit CUA451
					
Application	Water, wastewater	Drinking water, process	Drinking water, process	Process, wastewater	Water, wastewater
Description	Flow assembly designed for bypass system, for turbidity sensor CUS31 or CUS41 and one CUR3 cleaner spray head	Flow assembly for CUS52D turbidity sensor	Flow assembly for CUS52D turbidity sensor	Flow assembly for nitrate/SAC (CAS51D), turbidity (CUS51D), dissolved oxygen (COS51D, COS61D)	Manually operated SS holder assembly with ball valve and rinse connections, designed to hold CUS31, CUS41, or CUS65
Material	PVC	Polyethylene, stainless steel	Stainless steel	PVC, EPDM (seals)	316L SS
Maximum pressure	90 psi at 77°F, 15 psi at 122°F	87 psi	87 psi	87 psi at 68°F	145 psi (29 psi for manual operation)
Temperature	122°F	32 to 140°F	32 to 185°F	32 to 120°F	32 to 122°F
Flow rate	Constant	2.6 to 26.4 gal/hr (recommended: 15.8 gal/hr)	None specified	53 gal/hr for oxygen, 26.5 for turbidity and UV nitrate	Constant flow
Sensor connection	Threaded mounting sleeve with union nut	2" Tri-clamp fitting	2" Tri-clamp fitting	Compression fitting	Internal, with sensor external threads
Holder installation	Bypass line	Inline or bypass line: G1 1/4" external thread Rp 3/4" female thread NPT 3/4" female thread D25, PVC D25 hose barb, PVC D12 (3/8" ID tube) hose barb, PVC 2" ANSI flange (Plastic)	Welded, 4" stainless steel pipe	Inline or bypass line: G1 1/4" external thread, PVC 1" ANSI Flange, PVC DN20, PVC DN25 hose barb, PVC Rp 3/4" female thread, PVC NPT 3/4" female thread, PVC	Weld neck, 2" Class 150 ANSI flange





Multi-Parameter Memosens Technology

	Liquiline CM442/CM444/CM448 Digital Memosens Field Transmitter	Liquiline CM442R/CM444R/CM448R Digital Memosens DIN Rail-mount Transmitter
		
Application	Water/wastewater, power, chemical, process industries	Water/wastewater, power, chemical, process industries
Measurement type	Universal , multi-parameter transmitter for all Memosens and Memosens protocol sensors, including pH, ORP, conductivity, dissolved oxygen, turbidity/TSS, ammonium, nitrate, SAC/UC254, free chlorine	Universal , multi-parameter transmitter for all Memosens and Memosens protocol sensors, including pH, ORP, conductivity, dissolved oxygen, turbidity/TSS, ammonium, nitrate, SAC/UC254, free chlorine
Measurement range	Dependent on connected sensor type	Dependent on connected sensor type
Outputs	Up to eight 0/4 to 20 mA outputs, up to four relays (SPDT), Digital fieldbuses (HART, Profibus, ProfiNet, Modbus (TCP/485) or EtherNet/IP), and discrete outputs.	Up to eight 0/4 to 20 mA outputs, up to four relays (SPDT), Digital fieldbuses (HART, Profibus, ProfiNet, Modbus (TCP/485) or EtherNet/IP), and discrete outputs.
Inputs	From one up to eight digital Memosens sensors, optional analog input and discrete inputs.	From one up to eight digital Memosens sensors, optional analog input and discrete inputs.
Power supply	24 VAC (CM442 only), 50/60 Hz 24 VDC 100-240 VAC, 50/60 Hz	24 VAC (CM442R only), 50/60 Hz 24 VDC (CM444R and CM448R with external DIN-rail power supply) 100-240 VAC, 50/60 Hz (CM444R and CM448R with external DIN-rail power supply)
Ambient temperature	CM442: 0 to 140°F CM444 and CM448: 0 to 120°F	CM442: 32 to 140°F CM444 and CM448: 32 to 120°F External display: 0 to 140°F
Mounting	Wall or pipe	DIN-rail electronics, panel-mount remote display
Operation	Local interface via LCD display, menu-driven soft keys, and navigator knob. Optional IP addressable webserver. Optional HART, Profibus, ProfiNet, EtherNet/IP, Modbus digital. Integrates with FieldCare/DeviceCare, Field Data Manager and W@M asset management.	Optional panel-mount remote interface via LCD display, menu-driven soft keys, and navigator knob. Optional IP addressable webserver. Optional HART, Profibus, ProfiNet, EtherNet/IP, Modbus digital. Integrates with FieldCare/DeviceCare, Field Data Manager and W@M asset management.
Housing	Polycarbonate housing, IP66/67, NEMA 4X	Remote display: IP66, NEMA 4x when properly mounted.
Approvals / certificates	CE mark CM442 only: FM and CSA; Class 1, Div 2 CM444 and CM448: CSA C/US NI Cl. I, Div. 2 GP A-D	CE mark CM442R, CM444R and CM448R: General purpose









Turbidity Meter	
	<p>Turbimax CUE25/26</p> 
Application	Water, process water, wastewater (handheld field measurement)
Parameter	Turbidity
Measurement method	90° scattered light CUE25, IR light, 860 nm CUE26, white light per US EPA 180.1
Measuring range	0.01 to 1100 NTU
Output	N/A
Power supply	4 AAA alkaline batteries
Ambient temperature	32 to 122°F
Process pressure	N/A
Sample holder	Glass cuvette
Operation	Four keys, LCD
Communication	N/A
Approvals	CE

Modular Holder Assemblies		
	Flexdip CYH112	Flexdip CYA112
		
Application	Water and wastewater	Water and wastewater
Description	Single installation point, flexible holder system: for floor, wall or rail mounting	Standard immersion pipe, chain immersion pipe or float immersion pipe
Area of use	Basins, open channels, open tanks, process vats	Basins, open channels, open tanks, process vats
Sensor installation	Cantilever arm with chain, fixed immersion pipe, free swinging or float-lever version for varying levels	Various sensor connection threads or chain mount adapter. Straight or 45° angle mounting
Compatible sensor holder assemblies	Flexdip CYA112, Dipfit W CLA111, Dipfit W CPA111	Flexdip CYH112
Material	Stainless steel or PVC	Stainless steel or PVC
Ambient temperature	-4 to +140°F	-4 to +140°F
Main pipe height	20", 40", 71"	Lengths vary depending on application
Cantilever arm length	20", 40", 59"	N/A









Analysis: Colorimetric Analyzers

Analyzer systems

	Liquiline System CA80 AL Aluminum	Liquiline System CA80 AM Ammonium	Liquiline System CA80 CR Chromate	Liquiline System CA80 FE Iron	Liquiline System CA80 NO Nitrite	Liquiline System CA80 PH Orthophosphate	Liquiline System CA80 TP Total Phosphorous
							
Applications	Drinking water, wastewater	Wastewater treatment	Industrial water	Drinking water	Water, wastewater treatment	Wastewater treatment	Municipal and industrial wastewater
Measurement type	Colorimetric: Pyrocatechol violet method	Colorimetric: Indophenol blue method	Colorimetric: Diphenylcarbazide method.	Colorimetric: Ferrozine method	Colorimetric: Naphthylamine method	Colorimetric: Molybdenum blue or Molybdate vanadate yellow method	Digestion and colorimetric: Molybdenum Blue
Parameter	Al (ppb, µg/L)	NH ₄ - N (ppm)	Cr (VI), CrO ₄ (mg/L, µg/L, ppm, ppb)	Fe (ppm, mg/L, ppb, µg/L)	NO ₂ , NO ₂ - N (µg/L, ppm)	PO ₄ - P (ppm)	Total Phosphorus (ppm, mg/L)
Measuring ranges	15 to 1,000 ppb (µg/L)	0.05 to 20 ppm (mg/L) 0.5 to 50 ppm (mg/L) 1 to 100 ppm (mg/L)	0.03 to 2.5 ppm (mg/L) 0.2 to 5.0 ppm (mg/L)*	0.05 to 2.5 ppm (mg/L) 0.1 to 5 ppm (mg/L)	10 to 500 µg/L 0.1 to 1.0 ppm (mg/L) 0.2 to 3.0 ppm (mg/L)	0.05 to 2.5 ppm (mg/L) (blue method) 0.05 to 10 ppm (mg/L) (blue method) 0.5 to 20 ppm (mg/L) (yellow method) 0.5 to 50 ppm (mg/L) (yellow method)	0.05 to 10 ppm (mg/L) 0.5 to 50 ppm (mg/L) (With optional dilution module)
Outputs	<ul style="list-style-type: none"> ■ Up to six 0/4-40 mA (two standard) or, ■ Profibus DP, Modbus 485, Modbus TCP or EtherNet/IP (optional) ■ Webserver (optional) ■ Up to 4 relays (optional) 	Standard: Two 0/4-20 mA Optional: <ul style="list-style-type: none"> ■ Up to four additional 0/4-20 mA ■ Profibus DP, Modbus 485, Modbus TCP or EtherNet/IP ■ Webserver ■ Up to 4 relays 	Standard: Two 0/4-20 mA Optional: <ul style="list-style-type: none"> ■ Up to four additional 0/4-20 mA ■ Profibus DP, Modbus 485, Modbus TCP or EtherNet/IP ■ Webserver ■ Up to 4 relays 	Standard: Two 0/4-20 mA Optional: <ul style="list-style-type: none"> ■ Up to four additional 0/4-20 mA ■ Profibus DP, Modbus 485, Modbus TCP or EtherNet/IP ■ Webserver ■ Up to 4 relays 	Standard: Two 0/4-20 mA Optional: <ul style="list-style-type: none"> ■ Up to four additional 0/4-20 mA ■ Profibus DP, Modbus 485, Modbus TCP or EtherNet/IP ■ Webserver ■ Up to 4 relays 	Standard: Two 0/4-20 mA Optional: <ul style="list-style-type: none"> ■ Up to four additional 0/4-20 mA ■ Profibus DP, Modbus 485, Modbus TCP or EtherNet/IP ■ Webserver ■ Up to 4 relays 	Standard: Two 0/4-20 mA Optional: <ul style="list-style-type: none"> ■ Up to four additional 0/4-20 mA ■ Profibus DP, Modbus 485, Modbus TCP or EtherNet/IP ■ Webserver ■ Up to 4 relays
Inputs	<ul style="list-style-type: none"> ■ Up to four Memosens sensors (optional) ■ Two analog inputs (optional) 	<ul style="list-style-type: none"> ■ Up to four Memosens sensors (optional) ■ Two analog inputs (optional) 	<ul style="list-style-type: none"> ■ Up to four Memosens sensors (optional) ■ Two analog inputs (optional) 	<ul style="list-style-type: none"> ■ Up to four Memosens sensors (optional) ■ Two analog inputs (optional) 	<ul style="list-style-type: none"> ■ Up to four Memosens sensors (optional) ■ Two analog inputs (optional) 	<ul style="list-style-type: none"> ■ Up to four Memosens sensors (optional) ■ Two analog inputs (optional) 	<ul style="list-style-type: none"> ■ Up to four Memosens sensors (optional) ■ Two analog inputs (optional)
Power supply	24 VDC or 100 to 240 VAC	24 VDC or 100 to 240 VAC	24 VDC or 100 to 240 VAC	24 VDC or 100 to 240 VAC	24 VDC or 100 to 240 VAC	24 VDC or 100 to 240 VAC	100 to 240 VAC
Ambient temperature	41 to 104 °F (5 to 40 °C)	41 to 104 °F (5 to 40 °C)	41 to 104 °F (5 to 40 °C)	41 to 104 °F (5 to 40 °C)	41 to 104 °F (5 to 40 °C)	41 to 104 °F (5 to 40 °C)	41 to 104 °F (5 to 40 °C)
Operation	Liquiline Transmitter. Back light transfective display. Push button with navigator knob	Liquiline Transmitter. Back light transfective display. Push button with navigator knob	Liquiline Transmitter. Back light transfective display. Push button with navigator knob	Liquiline Transmitter. Back light transfective display. Push button with navigator knob	Liquiline Transmitter. Back light transfective display. Push button with navigator knob	Liquiline Transmitter. Back light transfective display. Push button with navigator knob	Liquiline Transmitter. Back light transfective display. Push button with navigator knob
Housing	Amorphous thermoplastic alloy (ASA-Polycarbonate) or stainless steel	Amorphous thermoplastic alloy (ASA-Polycarbonate) or stainless steel	Amorphous thermoplastic alloy (ASA-Polycarbonate) or stainless steel	Amorphous thermoplastic alloy (ASA-Polycarbonate) or stainless steel	Amorphous thermoplastic alloy (ASA-Polycarbonate) or stainless steel	Amorphous thermoplastic alloy (ASA-Polycarbonate) or stainless steel	Amorphous thermoplastic alloy (ASA-Polycarbonate) or stainless steel
Approvals/certificates	Non-hazardous, CE Marked, CSA C/US General Purpose	Non-hazardous, CE Marked	Non-hazardous, CE Marked	Non-hazardous, CE Marked, CSA C/US General Purpose	Non-hazardous, CE Marked	Non-hazardous, CE Marked	Non-hazardous, CE Marked



Analyzer systems			
	Liquiline System CA80 HA Hardness 	Liquiline System CA80 SI Silica 	CA76 NA Sodium 
Applications	Process waters, drinking water	Industrial water; boiler feed; condensate	Steam, water, condensate
Measurement Type	Colorimetric: Phthalein purple complex method	Colorimetric: Heteropoly blue method	Potentiometric NA Ion specific electrode
Parameter	CaCO ₃ (mg/l, µg/L, ppm, ppb)	SiO ₂ (mg/L, µg/L, ppm, ppb)	Na (µg/L, ppb)
Measuring Ranges	0 to 80 mg/l (ppm)	0.5 to 200 ppb (µg/L) 50 to 5000 ppb (µg/L)	0.1 to 2000 µg/l (ppb) 0.1 to 9999 µg/l (ppb)
Outputs	<ul style="list-style-type: none"> ■ Up to six 0/4- 40 mA ■ HART, Profibus DP, Modbus 485, Modbus TCP, Ethernet/IP, Webservice (optional) ■ Up to 4 relays (optional) ■ Up to 4 discrete outputs (optional) 	<ul style="list-style-type: none"> ■ Up to six 0/4- 40 mA ■ HART, Profibus DP, Modbus 485, Modbus TCP, Ethernet/IP, Webservice (optional) ■ Up to 4 relays (optional) ■ Up to 4 discrete (optional) 	<ul style="list-style-type: none"> ■ Up to six 0/4- 40 mA ■ Two relays - alarms/warnings
Inputs	<ul style="list-style-type: none"> ■ Up to four Memosens sensors (optional) ■ Two analog inputs (optional) ■ Up to 4 discrete inputs (optional) 	<ul style="list-style-type: none"> ■ Up to four Memosens sensors (optional) ■ Two analog inputs (optional) ■ Up to 4 discrete inputs (optional) 	None
Power Supply	24 VDC or 100 to 240 VAC	24 VDC or 100 to 240 VAC	100 to 240 VAC
Ambient Temperature	41 to 104 °F (5 to 40 °C)	41 to 104 °F (5 to 40 °C)	41 to 104 °F (5 to 40 °C)
Operation	Liquiline Transmitter. Back light transfective display. Push button with navigator knob.	Liquiline Transmitter. Back light transfective display. Push button with navigator knob.	Local display with six button interface.
Housing	Amorphous thermoplastic alloy (ASA-Polycarbonate) or stainless steel	Amorphous thermoplastic alloy (ASA-Polycarbonate) or stainless steel	IP 65 Electronics housing, with open system components
Approvals/Certificates	CSA C/US General Purpose, CE Marked	CSA C/US General Purpose, CE Marked	CE Marked

Analyzer sample preparation systems			
	Liquiline System CAT810 Sample preparation system 	Liquiline System CAT820 Sample preparation system 	Liquiline System CAT860 Sample preparation system 
Applications	Wastewater Treatment; outlet low solids.	Wastewater Treatment; sludge.	Wastewater Treatment; inlet with fat or oils present.
Filter type	50 µm stainless sieve filter.	0.1 µm ceramic filter	0.1 µm ceramic filter
Back flush	Compressed air or water	Compressed air.	Cleaning solution and compressed air.
Filtrate delivery method	Back pressure in filter system to deliver adequate flow to analyzer.	Pump delivery controlled by CA80 analyzer or internal control timer.	Pump delivery controlled by CA80 analyzer or internal control timer.
Filtrate quantity	Back pressure dependent.	5.5 to 16.5 ml/min (CA80 analyzer control) 4.7 to 11 ml/min (timer control)	5.5 to 16.5 ml/min (CA80 analyzer control) 4.7 to 11 ml/min (timer control)
Process Pressure	22 to 58 psi (1.5 to 4.0 bar)	Atmospheric	Atmospheric
Ambient Temperature	39 to 104°F (4 to 40°C)	Unheated: 41 to 122 °F (5 to 50 °C) Heated: -4 to 122 °F (-20 to 50 °C)	Unheated: 41 to 122°F (5 to 50°C) Heated: -4 to 122°F (-20 to 50°C)
Degree of protection	IP 65	IP66/67	IP55
Power Supply	115/230 VAC for timer version	115/230 VAC with hose heater	115/230 VAC with hose heater
Sample distance	N/A	Filter to pump: <ul style="list-style-type: none"> ■ 9.8 ft (3 m), 6.4 ft (5 M) Pump to analyzer: <ul style="list-style-type: none"> ■ 6.6 ft (2 m), 16.4 ft (5 m), 32.8 ft (10 m), 49.2 ft (15 m), 65.6 ft (20 m), 98.4 ft (30 m) 	*Filter to pump: <ul style="list-style-type: none"> ■ 9.8 ft (3 m), 6.4 ft (5 M) Pump to analyzer: <ul style="list-style-type: none"> ■ 6.6 ft (2 m), 16.4 ft (5 m), 32.8 ft (10 m), 49.2 ft (15 m), 65.6 ft (20 m), 98.4 ft (30 m)
Mounting	Wall, mounting plate, or analyzer stand	Pole or wall	Wall or analyzer stand



Analysis: TOC

Analyzer, TOC	
	<p>CA72 TOC</p> <div style="text-align: center;">  </div>
Application	Industrial and municipal wastewater treatment
Analyzer function	Continuous TOC measurement
Analyzer type	Catalytic, high temperature oxidation
Measurement range	2 to 50,000 mg/l TOC
Detection limit	2 mg/l TOC with IR detector 500 ppm
Response time	7 minutes
Output	0/4 to 20 mA selectable Dry contact relay for high, low limit and slope Dry contact relay fault signal
Power supply	0 to 230 VAC
Display/local operation	16 line, 40 characters, backlit LCD graphics display 21 key operation, RS232C for data output
Data presentation	6-hour graphic (14 day scrollable); current value with 5-digit resolution
Monitoring	Warning logs, malfunctions, limit value alarms and calibration for previous 4 weeks, leakage alerts, defective probe, general errors for measuring cell, dilution water failure
Data storage	14 days in RAM; 90 days with diskette drive
Ambient temperature	40 to 104°F
Sample handling	Bypass sampler with prep and self-cleaning coarse filter
Sample flow rate	0.1 to 35 GPM depending on sample bypass system



Analysis: Nutrient

Wastewater nitrate, ammonium, etc	
	<p>ISEmax CAS40D with Memosens</p> <div style="text-align: center;">  </div>
Application	Wastewater
Measurement type	Ion-selective electrode system
Input	Ammonium, nitrate, potassium, chloride, pH
Measurement range	0.1 to 1000 mg/l NH ₄ ⁻ -N 0.1 to 1000 mg/l NO ₃ ⁻ -N 1 to 1000 mg/l potassium 1 to 1000 mg/l chloride
Ambient temperature	-4 to +120°F
Process temperature	36 to 100°F, max 6 psi
Sensor	PVC, glass, polyethylene (wetted parts dependent on electrodes used), O-rings EPDM
Sensor cable	328 feet maximum
Sensor power supply	Liquiline® CM442 transmitter
Sensor mounting	Upright post with boom (CYH112 / CYA112)
Approvals /certificates	CE, Non-hazardous



Photometric nitrate sensor	
	<p>Viomax® CAS51D with Memosens</p> <div style="text-align: center;">  </div>
Application	Wastewater
Parameter	Nitrate or SAC
Material	316L SS, quartz glass, EPDM O-rings
Measuring range	NO ₂ ⁻ -N: 0.1 to 50 mg/l; Clear water and activated sludge NO ₃ ⁻ -N: 0.01 to 20 mg/l; Clear water SAC: 0.1 to 50 l/m (COD 0.15 to 75 mg/l, TOC: 0.06 to 30 mg/l); Clear water SAC: 0.5 to 250 l/m (COD: 0.75 to 370 mg/l, TOC: 0.3 to 150 mg/l) Clear water, treated water SAC: 1.5 to 700 l/m (COD 2.5 to 1000 mg/l; TOC: 0.9 to 410 mg/l) Organic load at inlet, industrial
Ambient temperature	-4 to +140°F
Process temperature	41 to 120°F
Process pressure	7 to 145 psia
Insertion depth	Cuvette gap, must be submerged
Process connection	¾" NPT, G1
Sensor cable	Fixed, Memosens, maximum 328 ft
Power	Provided by Liquiline CM442
Approvals	Non-hazardous







Water/Wastewater Transmitters

Water/Wastewater Transmitters		
	Liquiline CM442/CM444/CM448 Digital Memosens Field Transmitter 	Liquiline CM442R/CM444R/CM448R Digital Memosens DIN Rail-mount Transmitter 
Application	Water/wastewater, power, chemical, process industries	Water/wastewater, power, chemical, process industries
Measurement type	Universal , multi-parameter transmitter for all Memosens and Memosens protocol sensors, including pH, ORP, conductivity, dissolved oxygen, turbidity/TSS, ammonium, nitrate, SAC/UC254, free chlorine	Universal , multi-parameter transmitter for all Memosens and Memosens protocol sensors, including pH, ORP, conductivity, dissolved oxygen, turbidity/TSS, ammonium, nitrate, SAC/UC254, free chlorine
Measurement range	Dependent on connected sensor type	Dependent on connected sensor type
Outputs	Up to eight 0/4 to 20 mA outputs, up to four relays (SPDT), Digital fieldbuses (HART, Profibus, ProfiNet, Modbus (TCP/485) or EtherNet/IP), and discrete outputs.	Up to eight 0/4 to 20 mA outputs, up to four relays (SPDT), Digital fieldbuses (HART, Profibus, ProfiNet, Modbus (TCP/485) or EtherNet/IP), and discrete outputs.
Inputs	From one up to eight digital Memosens sensors, optional analog input and discrete inputs.	From one up to eight digital Memosens sensors, optional analog input and discrete inputs.
Power supply	24 VAC (CM442 only), 50/60 Hz 24 VDC 100-240 VAC, 50/60 Hz	24 VAC (CM442R only), 50/60 Hz 24 VDC (CM444R and CM448R with external DIN-rail power supply) 100-240 VAC, 50/60 Hz (CM444R and CM448R with external DIN-rail power supply)
Ambient temperature	CM442: 0 to 140°F CM444 and CM448: 0 to 120°F	CM442: 32 to 140°F CM444 and CM448: 32 to 120°F External display: 0 to 140°F
Mounting	Wall or pipe	DIN-rail electronics, panel-mount remote display
Operation	Local interface via LCD display, menu-driven soft keys, and navigator knob. Optional IP addressable webserver. Optional HART, Profibus, ProfiNet, EtherNet/IP, Modbus digital. Integrates with FieldCare/DeviceCare, Field Data Manager and W@M asset management.	Optional panel-mount remote interface via LCD display, menu-driven soft keys, and navigator knob. Optional IP addressable webserver. Optional HART, Profibus, ProfiNet, EtherNet/IP, Modbus digital. Integrates with FieldCare/DeviceCare, Field Data Manager and W@M asset management.
Housing	Polycarbonate housing. IP66/67, NEMA 4X	Remote display: IP66, NEMA 4x when properly mounted.
Approvals / certificates	CE mark CM442 only: FM and CSA; Class 1, Div 2 CM444 and CM448: CSA C/US NI Cl. I, Div. 2 GP A-D	CE mark CM442R, CM444R and CM448R: General pupose





Modular Holder Assemblies		
	Flexdip CVH112	Flexdip CYA112
		
Application	Water and wastewater	Water and wastewater
Description	Single installation point, flexible holder system: for floor, wall or rail mounting	Standard immersion pipe, chain immersion pipe or float immersion pipe
Area of use	Basins, open channels, open tanks, process vats	Basins, open channels, open tanks, process vats
Sensor installation	Cantilever arm with chain, fixed immersion pipe, free swinging or float-lever version for varying levels	Various sensor connection threads or chain mount adapter. Straight or 45° angle mounting
Compatible sensor holder assemblies	Flexdip CYA112, Dipfit W CLA111, Dipfit W CPA111, ISEmax CAS40D	Flexdip CVH112
Material	Stainless steel and plastic	Stainless steel and PVC
Ambient temperature	-4 to +140°F	-4 to +140°F
Main pipe height	20", 40", 71"	Lengths vary depending on application
Cantilever arm length	20", 40", 59"	N/A

Holder Assemblies		
	Flowfit CYA251	71110000
		
Application	Process, wastewater	Clean water
Description	Flow assembly for nitrate/SAC (CAS51D), turbidity (CUS51D), dissolved oxygen (COS51D, COS61D)	Flow assembly for UV Nitrate (CAS51D)
Material	PVC, EPDM (seals)	PVC
Maximum pressure	87 psi at 68°F	
Temperature	32 to 120°F	
Flow rate	53 gal/hr for oxygen, 26.5 for turbidity and UV nitrate	
Sensor connection	Compression fitting	Compression, o-rings
Holder installation	Inline or bypass line: G1¼ external thread, PVC 1" ANSI Flange, PVC DN20, PVC DN25 hose barb, PVC Rp 3/4" female thread, PVC NPT 3/4" female thread, PVC	Wall mount with 6 mm OD hose connection



Water/Wastewater Sampler Systems		
	Liquistation CSF34 Stationary sampler	Liquiport CSP44 Portable sampler
		
Application	Water/Wastewater	Water/Wastewater
Online measurement available with sampler	Nitrate, Conductivity, Oxygen, pH/ORP, Turbidity	Nitrate, Conductivity, Oxygen, pH/ORP, Turbidity
Input	2 analog input, 0/4 to 20 mA 2 binary inputs (passive), 12 to 30 V 1 or 2 digital inputs (Memosens protocol)	2 analog input, 0/4 to 20 mA 2 binary inputs (passive), 12 to 30 V 1 or 2 digital inputs (Memosens protocol)
Temperature input	Pt1000, -20 to +160°F measuring range	Pt1000, 20 to +160°F measuring range
Measurement range	-20 to +160°F	Dependent on connected sensor
Output	2 Binary Outputs Standars, 2 Binary Outputs optional Open Collector, max 30 V, 200 mA Depending on the version selected: 1 x 0/4-20 mA, active, selectable with HART 2 x 0/4-20 mA active 4 x 0/4-20 mA active 6 x 0/4-20 mA active Profibus DP MODBUS 485 Ethernet and Modbus TCP	2 binary, open collector, 30V, 200 mA 2 x 0/4 to 20 mA (optional)
Power supply	100 to 240 VAC 24 VDC	24 VDC, 7.2 Ah lead-acid battery Charger, 90 to 265 VAC
Ambient temperature	-4 to +100°F with temperature control unit 32 to 100°F without temperature control unit	32 to 100°F
Process temperature	36 to 122°F	36 to 122°F
Process pressure	Unpressurized, open channel (unpressurized sampling) Maximum 11.6 psi piping (pressurized sampling) Maximum 87 psi with Sampling Assembly Model CSA240	Unpressurized
Sampling method	Vacuum pump Peristaltic pump	Peristaltic pump
Suction line	Plastic PVC or EPDM, maximum 26 foot suction height	Plastic PVC or EPDM, maximum 26 foot suction height
Sample containers	Various sizes and combinations available from 1 liter (24 containers) to 60 liter (1 container), containers made of PE or glass depending on application	Various sizes and combinations available from 1 liter (24 containers) to 20 liter (1 container), containers made of PE or glass depending on application
Transmitter	Liquiline CM442	Liquiline CM442
Operation	Via 4 soft keys, LCD display and navigator	Via 4 soft keys, LCD display and navigator
Software	Field Data Manager, FieldCare/DeviceCare	Field Data Manager, FieldCare/DeviceCare
Approvals / certificates	CE	CE



Analysis: Process Photometers

Concentration and Color Sensors		
	Model OUSAF21 Flow through optical	Model OUSAF22 Flow through optical
		
Transmitter type	Liquiline CM44P	Liquiline CM44P
Application	Potable water	Potable water
Sensor type	Low level color	Dual beam color
Measurement wave-length	390 to 1100 nm	390 to 1100 nm
Path length	100 to 250 mm	0.5 to 100 mm
Lamp	4 watt incandescent, rated for FM Class I, Div. 1, Grps. B, C, D	4 watt incandescent, rated for FM Class I, Div. 1, Grps. B, C, D
Output	Low level current	Low level current
Window material	Pyrex, fire polished quartz, or sapphire	Pyrex, fire polished quartz, or sapphir
Maximum temperature	194°F; with PEEK isolators, 266°F	194°F; with PEEK isolators, 266°F
Maximum pressure	500 psig dependent on material, line size and process connection	3000 psig dependent on material, line size and process connection
Process connection	¾" FNPT	Tri-Clamp, flange, FNPT
Sensor material	316 SS	316 SS

Cell Density Sensor	
	OUSBT66 Optical insertion
	
Transmitter type	Liquiline CM44P
Application	Bacterial fermentation, mammalian cell culture
Sensor type	Optical insertion probe
Measurement wave-length	Broadband NIR absorption, 880 nm
Measurement range	0 to 4 AU, 0 to 8 OD (depending on optical path length)
Path length	5, 10 or 20 mm
Lamp	4 watt incandescent
Output	Low level current
Window material	Sapphire
Detector type	Solid state silicon photodetector
Process temperature	32 to 158°F, up to 275°F when lamp is switched off
Maximum pressure	150 psig
Process connection	Threaded, PG13.5
Sensor material	316L SS
Sensor length	120 mm, 225 mm, 360 mm



Phase Separation, Chromatography Sensors			
	OUSAF44 Flow through UV	OUSAF45 Flow through UV	OUSAF46 Flow through UV, dual channel
			
Transmitter type	Liquiline CM44P	Liquiline CM44P	Liquiline CM44P
Application	Phase separation, Chromatography	Phase separation, Chromatography	Phase separation, Chromatography
Sensor type	Spectral absorbance in UV range	Spectral absorbance in UV range	Spectral absorbance in UV range
Measurement wavelength	254 to 365 nm	204, 214 or 226 nm	254 to 365 nm
Path length	0.5 to 100 mm	0.5 to 45 nm, up to 500 nm	0.5 to 100 mm
Lamp	Low pressure mercury vapor, 4 watt FM Class I, Div. 1, Grps. B, C, D	Low voltage 4 watt incandescent FM Class I, Div. 1, Grps. B, C, D	Low pressure mercury vapor, 4 watt FM Class I, Div. 1, Grps. B, C, D
Detector type	UV enhanced silicone detector	Silicone detector	UV enhanced silicone detector
Output	Low level current	Low level current	Low level current
Window material	Fire polished quartz or sapphire	Pyrex®, Lexan®, fire polished quartz, or sapphire	Fire polished quartz or sapphire
Maximum temperature	194°F continuous; with PEEK isolators, 266°F	194°F continuous; 266°F for two hours	194°F continuous; with PEEK isolators, 266°F
Maximum pressure	3000 psig dependent on material, line size and process connection	3000 psig dependent on material, line size and process connection	3000 psig dependent on material, line size and process connection
Process connection	FNPT, Tri-Clamp, 150/300 lb flange	Tri-Clamp, 150/300 lb flange, FNPT	Tri-Clamp, 150/300 lb flange, FNPT
Sensor material	316L SS	316L SS	316L SS

	Turbidity Sensor
	Model OUSTF10 Flow through scattered light
	
Transmitter type	Liquiline CM44P
Application	Emulsions and immiscible fluids
Sensor type	Low turbidity scattered light
Measurement wave-length	Broadband VIS/NIR or NIR only; up to 200 ppm
Path length	40 mm
Lamp	4 watt incandescent, rated for FM Class I, Div. 1, Grps. B, C, D
Output	Low level current
Window material	Pyrex®, fire polished quartz, or sapphire
Maximum temperature	194°F continuous
Maximum pressure	400 psig dependent on material, line size and process connection
Process connection	FNPT, Tri-Clamp, 150/300 lb flange
Sensor material	316 SS





Dairy Milk and Mining Solids Sensor	
	OUSAF11 Submersible optical 
Transmitter type	Liquiline CM44P
Application	Dairy milk, mining solids
Sensor type	Submersible color optical
Measurement range	0 to 30% TSS
Path length	5 or 10 mm
Lamp	Long life incandescent, 5 VDC
Detector type	Solid state detector
Output	Low level current
Window material	Teflon® optical head
Maximum temperature	32 to 194°F
Process connection	¾" FNPT
Sensor material	316L SS Teflon® head

Suspended Solids and Interface Sensor	
	OUSAF12 Flow through optical 
Transmitter type	Liquiline CM44P
Application	Solids concentration (absorbance)
Sensor type	Flow through color optical
Measurement range	200 to 10,000 ppm
Path length	0.5 to 50 mm, up to 500 mm
Lamp	Low voltage 4 watt incandescent FM Class I, Div. 1, Grps. B, C, D
Detector type	Silicone detector
Output	Low level current
Window material	Pyrex®, Lexan®, fire polished quartz, or sapphire
Maximum temperature	194°F continuous, 266°F for two hours
Maximum pressure	1500 psig dependent on material, line size and process connection
Process connection	Tri-Clamp, 150/300 lb flange, FNPT
Sensor material	316L SS

Process Photometer Transmitter		
	Liquiline CM44P Digital Field Transmitter for Process Photometers and Memosens sensors 	Liquiline CM44P Digital DIN Rail-mount Transmitter for Process Photometers and Memosens sensors 
Application	Chemical, Food, Pharmaceutical	Chemical, Food, Pharmaceutical
Measurement type	Multi-parameter transmitter for process photometers and Memosens protocol sensors including pH, ORP, conductivity, dissolved oxygen, turbidity/TSS, ammonium, nitrate, SAC and free chlorine	Multi-parameter transmitter for process photometers and Memosens protocol sensors including pH, ORP, conductivity, dissolved oxygen, turbidity/TSS, ammonium, nitrate, SAC and free chlorine
Measuring range	Dependent on connected sensor type	Dependent on connected sensor type
Outputs	Up to eight 0/4-20 mA outputs, up to four relays (SPDT), discrete outputs, digital fieldbuses (HART, Profibus, Modbus (TCP/485), EtherNet/IP, ProfiNet	Up to eight 0/4-20 mA outputs, up to four relays (SPDT), discrete outputs, digital fieldbuses (HART, Profibus, Modbus (TCP/485), EtherNet/IP, ProfiNet
Input	Up to two process photometers and four Memosens sensors, analog inputs, and discrete inputs	Up to two process photometers and four Memosens sensors, analog inputs, and discrete inputs
Power supply	24 VDC 100-240 VAC, 50/60 Hz	24 VDC 100-240 VAC, 50/60 Hz
Ambient temperature	0 to 120°F	Electronics: 32 to 120°F External Display: 0 to 140°F
Mounting	Wall mount or pole mount	DIN-rail electronics, panel-mount remote display
Operation	Local interface via LCD display, menu-driven soft keys, and navigator knob. Optional IP addressable webserver. Optional HART, Profibus, ProfiNet, EtherNet/IP, Modbus digital.	Optional panel-mount remote interface via LCD display, menu-driven soft keys, and navigator knob. Optional IP addressable webserver. Optional HART, Profibus, ProfiNet, EtherNet/IP, Modbus digital.
Housing	Polycarbonate, IP66/67, NEMA 4X	Remote display: IP66, NEMA 4X when sealed to panel with gasket
Approvals/Certificates	CE Mark, CSA C/US NI Cl. I, Div. 2 GP A-D	CE Mark, General Purpose



Flow Assembly		
	OUA260 	CYA680 
Application	Flow assembly for certain OUSAF sensors for the measurement of UV and NIR absorption, color and turbidity	Holder for one or two 120 mm, PG13.5 sensors
Sensor types	OUSAF44/45/46/10/12/22 and OUSTF10	pH, 4-pole conductivity, dissolved oxygen
Optical path lengths	0.5 mm to 90 mm	N/A
Line sizes	¼" to 4"	0.25", 0.5", 0.75", 1", 1.5", 2"
Optical window materials	Pyrex, quartz, sapphire	N/A
Materials	316L SS, titanium, Hastelloy, PEEK, Kynar	316L SS
O-rings/sealing material	Viton, silicone, EPDM, Kalrez	EPDM, Kalrez, Viton
Process connections	Tri-Clamp, 150 lb/300 lb ANSI RF flanges, NPT female, Swagelock BVCO, Swagelock tube, tube stub	Tri-clamp
Process temperature	32 to 266°F (insure compatible with process temperature of selected sensor)	Sensor specific
Process pressure	Up to 1450 psi depending on material, line size and process connection	Sensor specific

Analysis: Software

Multichannel, multiparameter PC software for Memosens sensors	
	Memobase® Plus 
Functions	<ul style="list-style-type: none"> ▪ Measure ▪ Calibrate ▪ Document
Multiparameter and multichannel	<ul style="list-style-type: none"> ▪ Up to 4 parallel measurements of pH, DO, Chlorine, Conductivity ▪ Enable use of same sensors as in process ▪ Store single measurement or data-logging over time ▪ Export to PDF or Excel
Calibration	<ul style="list-style-type: none"> ▪ Controlled conditions (higher measuring accuracy, precise calibration results, better sensor evaluation) ▪ Sensors are calibrated with user defined templates (increased control of sensors that re-enter the process) ▪ Better process safety (calibration procedures can be defined down to TAG and sensor identity)
Complete documentation	<ul style="list-style-type: none"> ▪ Lifetime history for all sensors used ▪ Measurement and calibration reports (sensor and reference solution management, FDA conformant user management, sensor performance values) ▪ Calibration history (traceability of sensors, evaluation of sensor performance) ▪ Local or central database (high data safety and security, using central database enables multiuser access)



Advanced Analysis - Laser-based Raman Spectroscopy

Optograf Analyzer Systems

			
Industry	Fertilizer	Bulk Gas Suppliers	Refining
Process Plants	Ammonia	HyCO Plants	H2 Production
Measurement Parameters	Carbon Number, BTU, Composition/CH ₄ , Composition/CO, Composition/CO ₂ , Composition/H ₂ /N ₂ , H ₂ /N ₂ Ratio, Composition/Impurities, CH ₄ Impurities	Carbon Number, BTU, Composition/CH ₄ , Composition/CO, Composition/CO ₂ , Composition/H ₂ /N ₂ , CH ₄ Leakage	Carbon Number, BTU, Composition/CH ₄ , Composition/CO, Composition/CO ₂ , Composition/H ₂ /N ₂ , CH ₄ Leakage
Measurement Ranges	Percentage Level - 0.1 - 100% vol	Percentage Level - 0.1-100% vol	Percentage Level - 0.1-100% vol
Fiber Optic Cable Length	15-150 meters	15-150 meters	15-150 meters
Communication	Serial: RS485, Modbus TCP/IP	Serial: RS485, Modbus TCP/IP	Serial: RS485, Modbus TCP/IP
Power Supply	100-240VAC, 50-60 Hz	100-240VAC, 50-60 Hz	100-240VAC, 50-60 Hz
Ambient Temperature	-20 to 50°C	-20 to 50°C	-20 to 50°C
Operation/User Interface	Touch-screen color LCD display	Touch-screen color LCD display	Touch-screen color LCD display
Housing	Painted steel or optional 316 Stainless Steel, NEMA4 (or IP65)	Painted steel or optional 316 Stainless Steel, NEMA4 (or IP65)	Painted steel or optional 316 Stainless Steel, NEMA4 (or IP65)
Dimensions	18.0" w x 32.85" h x 10.00" d (45.72 cm w x 83.44 cm h x 25.4 cm d)	18.0" w x 32.85" h x 10.00" d (45.72 cm w x 83.44 cm h x 25.4 cm d)	18.0" w x 32.85" h x 10.00" d (45.72 cm w x 83.44 cm h x 25.4 cm d)
Certifications/Approvals	CSA: Class 1 Div 2 Groups B C D T4,	CSA: Class 1 Div 2 Groups B C D T4,	CSA: Class 1 Div 2 Groups B C D T4,

Sample Preparation Systems for Optograf

	OptoAST Sample Interface
	
Typical Dimensions (Conventional)	36.0 x 21.0 x 13.5 in (915 x 535 x 345 mm) WxHxD
Typical Dimensions (NeSSI)	24.0 x 21.0 x 13.5 in (610 x 535 x 345 mm) WxHxD
Weight	Conventional: 60 lbs(27 kg); NeSSI: 50 lbs(22 kg)
Maximum Pressure Rating for Components	800 psig
Optional Heater Maximum Wattage	500 W
Optional Upper Temperature Control Limit	140°F (60°C)
Certification/Approvals	C1D1 Groups B, C, D

Sample Preparation Systems for Optograf

	OptoDRS Sample Interface
	
Typical Dimensions (Conventional)	36.5 x 41.0 x 13.5 in (915 x 1257 x 345 mm) WxHxD
Typical Dimensions (NeSSI)	24.0 x 41.0 x 13.5 in (610 x 1257 x 345 mm) WxHxD
Typical Weight	Conventional: 90 lbs(41 kg); NeSSI: 80 lbs(36 kg)
Flange Sizes	2" to 8" (others available upon request)
Vortex Cooler Instrument Air Consumption	15 or 25 SCFM
Vortex Cooler Instrument Air Pressure	100 psig (6.9 barg)
Condenser Type	Tube-in-tube
Process Temperature Maximum	355°F (179.4°C) (higher temperatures available upon request)
Certification/Approvals	C1D1 Groups B, C, D
Sample Preparation Systems for Optograf	
	OptoDRS Temperature Controller
Dimensions	14.81 x 14.81 x 9.13 in (413 x 413 x 232 mm) WxHxD
Weight	50 lbs(23 kg)
Certification/Approvals	C1D1 Groups B, C, D



Syngas SNG	Methanol	LNG	
SNG	Methanol Plant	LNG/Peak Shaver Plant	
Composition/CH ₄ , Composition/H ₂ /CO/CO ₂ , Composition/CH ₄ /H ₂ /CO/CO ₂ , Composition/CH ₄ /H ₂ /CO ₂ /N ₂	Carbon Number, BTU, Composition/CH ₄ , Composition/H ₂ /CO/CO ₂ , Composition	Refrigerants, BTU in Blending, BTU in Gasification, BTU in Marine Bunkering, BTU in LNG Truck Loading, BTU in Export and Import of LNG	
Percentage Level - 0.1–100% vol	Percentage Level - 0.1–100% vol	Percentage Level - 0.1–100% vol	
15–150 meters	15–150 meters	15–250 meters	
Serial: RS485, Modbus TCP/IP	Serial: RS485, Modbus TCP/IP	Serial: RS485, Modbus TCP/IP	
100–240VAC, 50–60 Hz	100–240VAC, 50–60 Hz	100 –240VAC, 50–60 Hz	
-20 to 50°C	-20 to 50°C	-20 to 50°C	
Touch-screen color LCD display	Touch-screen color LCD display	Touch-screen color LCD display	
Painted steel or optional 316 Stainless Steel, NEMA4 (or IP65)	Painted steel or optional 316 Stainless Steel, NEMA4 (or IP65)	Painted steel or optional 316 Stainless Steel, NEMA4 (or IP65)	
18.0" w x 32.85" h x 10.00" d (45.72 cm w x 83.44 cm h x 25.4 cm d)	18.0" w x 32.85" h x 10.00" d (45.72 cm w x 83.44 cm h x 25.4 cm d)	18.0" w x 32.85" h x 10.00" d (45.72 cm w x 83.44 cm h x 25.4 cm d)	
CSA: Class 1 Div 2 Groups B C D T4,	CSA: Class 1 Div 2 Groups B C D T4,	CSA: Class 1 Div 2 Groups B C D T4,	

Sample Preparation Systems for Optograf	
	AirHead™ Gas Sampling Probe 
Temperature for probe head	-40 to + 150°C
Temperature for fiber optic cable	-40 to + 80°C
Maximum Pressure at probe tip	1000 PSI
Process Interface	1" Swagelok Cross-T Probe Flow-Cell, ½" NPT, 1" compression, Other NeSS™ (custom)
Certification/Approvals	Ex ia IIB+H2 T4, Class I Zone 0 AEx ia IIB+H2 T4, Class I Division 1 Groups B, C and D T4

Sample Preparation Systems for Optograf	
	Pilot™ Probe for LNG 
Temperature:	Window, at Tip: -196 to 150°C, At probe head: -196 to 150°C, At Cable: up to 80°C
Thermal Shock:	Can Withstand 0 –100°C
pH Range:	-1 to 15
Relative Humidity:	Up to 95%, Non-condensing
Pressure Range:	Up to 3000 PSI at tip
Standard Probe Lengths:	Up to 15 ft. (4.6 m) – diameter dependent
Probe Diameter:	1" Pipe (1.3" actual), 2" Pipe (2.37" actual)
Flange Mount (option):	Up to 12" Diameter (ANSI & DIN)
Flange Type:	Blind ANSI B 16.5 or Blank DIN 2527
Body Material:	316 Stainless Steel
Window Material:	High-purity Sapphire
Window Seal:	Compression Bonded
Cable Enclosure Material:	Anodized Aluminum
Certification/Approvals	Ex ia IIB+H2 T4, Class I Zone 0 AEx ia IIB+H2 T4, Class I Division 1 Groups B, C and D T4



Advanced Analysis - Raman

Raman Laboratory	
	RXN 2 
Application	Laboratories in life science and chemical
Measurement type	Fundamental Analysis with modeling required
Measurement range	Probe and application dependent
Outputs	Display, OPC, Modbus
Sensor input	Optical probes specific to liquids and solids
Additional inputs	None
Power	110-240V, 50-60 Hz
Ambient temperature	15- 30 degrees C
Mounting	Bench top or wheeled cart
Operation	Runtime software
Housing	Polycarbonate
Protection	General Purpose
Approvals / certificates	Atex



Raman Process	
	RXN 4 
Application	Production plants in life science and chemical.
Measurement type	Fundamental Analysis with modeling required
Measurement range	Probe and application dependent
Outputs	Display, OPC, Modbus
Sensor input	Optical probes specific to liquids and solids
Additional inputs	None
Power	110-240V, 50-60 Hz
Ambient temperature	0-35 degrees C
Mounting	19 inch rack
Operation	Runtime software
Housing	Metal
Protection	General Purpose. NEMA 4X
Approvals / certificates	Atex

Advanced Analysis - Quench Fluorescence



Oxygen Analyzer	
	OXY5500 
Applications	Natural Gas Production, Natural Gas Processing, and Vapor Recovery Units
Measurement Parameters	Oxygen
Measurement Ranges	0-1000ppmv, 0-5%, 0-50%
Communication	Fieldbus: RS-232C, RS-485, & Ethernet 10/100 with Modbus, USB 2.0 Works With Service Software Only
Inputs	One 4-20 mA input (sample pressure)
Outputs	Two 4-20 mA, Relays: Two 250 mA max load (Concentration and Fault Alarms)
Power Supply	85-260 VAC 50/60 Hz or 18-30 VDC
Ambient Temperature	-20 to 50°C (-4° to 122°F)
Controller to Probe Cable Length	0.7m standard (2.5m and 5.0m - optional)
Sample Probe Construction	316 Stainless Steel
Operation/User Interface	LCD Display with Keypad
Housing	NEMA Type 4X and IP65 Rated, 304 and 316 (optional) Stainless Steel
Dimensions	280 x 230 x 114 mm (11 x 9 x 4.5 inches) H x W x D, (not including Sample Conditioning System)
Approvals/Certificates	CSA: Class I, Division 2, Groups A B C D, T4

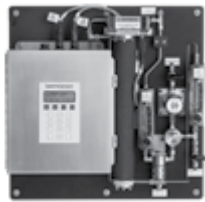



Advanced Analysis - Tunable Diode Laser Technology

TDL Analyzers			
	SS500 - Class I, Div 2 	SS500 - Class I, Div 1 	SS500e 
Target Components	H ₂ O in Natural Gas	H ₂ O in Natural Gas	H ₂ O in Natural Gas
Measurement Performance	Refer to Application Notes (AN 10101 for H ₂ O)	Refer to Application Notes (AN 10101 for H ₂ O)	Refer to Application Notes (AN 10101 for H ₂ O)
Environmental Temperature Range	-20° to 50° C (-4° to 122° F)	-20° to 50° C (-4° to 122° F)	-20° to 50° C (-4° to 122° F); -10° to 60° C (15° to 140° F) - optional
Sample Cell Pressure Range	700-1400 mbara	700-1400 mbara	700 - 1400 mbara , 700 - 1700 mbara - optional
Sample Cell Temperature Range	-20° to 50° C (-4° to 122° F)	-20° to 50° C (-4° to 122° F)	-20° to 50° C (-4° to 122° F); -10° to 60° C (15° to 140° F) - optional
Maximum Cell Pressure	70kPag (10 PSIG)	70kPag (10 PSIG)	70 kPag (10 PSIG)
Voltage	100-240 VAC, 50-60 Hz; 9-16 VDC OR 18-32 VDC - optional	100-240 VAC, 50-60 Hz; 9-16 VDC OR 18-32 VDC - optional	100-240 VAC, 50-60 HZ; 18-24 VDC - optional
Max Current	1 amp maximum @ 120 VAC; 1.6A @ 24VDC, 3.2A @ 12 VDC	1 amp maximum @ 120 VAC; 1.6A @ 24VDC, 3.2A @ 12 VDC	1 amp maximum @ 120 VAC , 1.6A @ 24 VDC (Heated); 2 amps maximum @ 120 VAC (unheated)
Communication	Analog: 1 or 2 4-20mA Isolated, 1200 ohms @ 24 VDC max load; Serial: RS232C, Protocol: Modbus Gould RTU or Daniel RTU or ASCII	Analog: 1 or 2 4-20mA Isolated, 1200 ohms @ 24 VDC max load; Serial: RS232C, Protocol: Modbus Gould RTU or Daniel RTU or ASCII	Analog: Two 4-20mA Isolated, 1200 ohms @ 24 VDC max load; Serial: RS232C - standard, RS485 and Ethernet - optional; Protocol: Modbus Gould RTU or Daniel RTU or ASCII
Alarms	2, General Fault and Concentration Alarms via Modbus and Analog Output(s)	2, General Fault and Concentration Alarms via Modbus and Analog Output(s)	2, General Fault and Concentration/Assignable Alarm
LCD Display	Concentration, Cell Pressure and Temperature & Diagnostics	Concentration, Cell Pressure and Temperature & Diagnostics	Concentration, Cell Pressure and Temperature & Diagnostics
Enclosure Type	NEMA 3R - 304 Stainless Steel	NEMA 4, 7, 9 - Cast Aluminum	NEMA 4X Stainless Steel Enclosures
Dimensions	444 mm H x 376 mm W x 135 mm D; (17.5 H x 14.8 W x 5.8 D inches)	565 mm H x 413 mm W x 222 mm D; (22.25 H x 16.25 W x 8.75 D inches)	973 mm H x 406 mm W x 229 mm D (38.3 H x 16 W x 9 D inches)
Approximate Weight	11.5 kg (25 lbs)	46.8 kg (103 lbs)	34 kg (75 lbs)
Sample Cell Dimensions	438 mm H x 108 mm W; (17.3 H x 4.3 W inches)	438 mm H x 108 mm W; (17.3 H x 4.3 W inches)	438 mm H x 108 mm W (17.3 H x 4.3 W inches)
Sample Cell Construction	316L Series Polished Stainless Steel	316L Series Polished Stainless Steel	316L Series Polished Stainless Steel
Number of Sample Cells	1	1	1
Certification/Approval	CSA Class I, Div 2, Groups A,B,C, and D, Temp Code T3C	CSA Class I, Div 1, Groups B, C and D, Temp Code T4	CSA Class I, Div 2, Groups B,C, and D, Temp Code T3C (T3 with Heaters); Directives EN61010-1 & EN61326-1

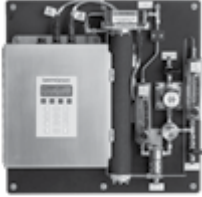



TDL Analyzers			
	SS1000 	SS2000e 	SS2000 - Class I, Div 2 
Target Components	H ₂ O in Natural Gas	H ₂ O or CO ₂ in natural gas	H ₂ O or CO ₂ in natural gas
Measurement Performance	Refer to Application Notes (AN 10101 for H ₂ O)	Refer to Application Notes (AN 10101 for H ₂ O) (AN 10303 for CO ₂)	Refer to Application Notes (AN 10101 for H ₂ O) (AN 10303 for CO ₂)
Environmental Temperature Range	-20° to 50° C (-4° to 122° F)	-20° to 50° C (-4° to 122° F); -10° to 60° C (15° to 140° F) - optional	-20° to 50° C (-4° to 122° F)
Sample Cell Pressure Range	700-1400 mbara	700 - 1400 mbara , 700-1700 mbara - optional	700-1400 mbara
Sample Cell Temperature Range	-20° to 50° C (-4° to 122° F)	-20° to 50° C (-4° to 122° F); -10° to 60° C (15° to 140° F) - optional	-20° to 50° C (-4° to 122° F)
Maximum Cell Pressure	70kPag (10 PSIG)	70 kPag (10 PSIG)	70kPag (10 PSIG)
Voltage	100-240 VAC, 50-60 Hz - standard; 12-Volt, Sealed Lead-Acid Battery; Approx. 8 hours usage time per charge	100-240 VAC, 50-60 HZ; 18-24 VDC - optional	100-240 VAC, 50-60 Hz; 9-16 VDC OR 18-32 VDC - optional
Max Current	0.5A @ 120 VAC during recharging	1 amp maximum @ 120 VAC , 1.6A @ 24 VDC (Heated); 2 amps maximum @ 120 VAC (unheated)	1 amp maximum @ 120 VAC; 1.6A @ 24VDC, 3.2A @ 12 VDC
Communication	RS232C - all parameters	Analog: Two 4-20mA Isolated, 1200 ohms @ 24 VDC max load; Serial: RS232C - standard, RS485 and Ethernet - optional; Protocol: Modbus Gould RTU or Daniel RTU or ASCII	Analog: 1 or 2 4-20mA Isolated, 1200 ohms @ 24 VDC max load; Serial: RS232C, Protocol: Modbus Gould RTU or Daniel RTU or ASCII
Alarms	None	2, General Fault and Concentration/Assignable Alarm	2, General Fault and Concentration Alarms via Modbus and Analog Output(s)
LCD Display	Concentration, Cell Pressure and Temperature & Diagnostics	Concentration, Cell Pressure and Temperature & Diagnostics	Concentration, Cell Pressure and Temperature & Diagnostics
Enclosure Type	N/A	NEMA 4X Stainless Steel Enclosures	NEMA 3R - 304 Stainless Steel
Dimensions	Nominal 200 mm H x 175 mm W x 450 mm D (8 x 7 x 18 inches)	973 mm H x 406 mm W x 229 mm D (38.3 H x 16 W x 9 D inches)	444 mm H x 376 mm W x 135 mm D; (17.5 H x 14.8 W x 5.8 D inches)
Approximate Weight	6.8 kg (15 lbs)	34 kg (75 lbs)	11.5 kg (25 lbs)
Sample Cell Dimensions	438 mm H x 108 mm W (17¼ H x 4¼ W inches)	438 mm H x 108 mm W (17.3 H x 4.3 W inches)	438 mm H x 108 mm W; (17.3 H x 4.3 W inches)
Sample Cell Construction	316L Series Polished Stainless Steel	316L Series Polished Stainless Steel	316L Series Polished Stainless Steel
Number of Sample Cells	1	1	1
Certification/Approval	Non-Hazardous (certified) locations - General Purpose	CSA Class I, Div 2, Groups B,C, and D, Temp Code T3C (T3 with Heaters); Directives EN61010-1 & EN61326-1	CSA Class I, Div 2, Groups A,B,C, and D, Temp Code T3C



	SS2000 - Class I, Div 1 	SS3000 	SS3000e 
	H ₂ O or CO ₂ in natural gas	H ₂ O/CO ₂ in Natural Gas	H ₂ O/CO ₂ in Natural Gas
	Refer to Application Notes (AN 10101 for H ₂ O) (AN 10303 for CO ₂)	Refer to Application Notes (AN 10101 for H ₂ O) (AN 10303 for CO ₂)	Refer to Application Notes (AN 10101 for H ₂ O) (AN 10303 for CO ₂)
	-20° to 50° C (-4° to 122° F)	-20° to 50° C (-4° to 122° F)	-20° to 50° C (-4° to 122° F); -10° to 60° C (15° to 140° F) - optional
	700-1400 mbara	700-1400 mbara	700 - 1400 mbara , 700 - 1700 mbara - optional
	-20° to 50° C (-4° to 122° F)	-20° to 50° C (-4° to 122° F)	-20° to 50° C (-4° to 122° F); -10° to 60° C (15° to 140° F) - optional
	70kPag (10 PSIG)	70kPag (10 PSIG)	70 kPag (10 PSIG)
	100-240 VAC, 50-60 Hz; 9-16 VDC OR 18-32 VDC - optional	100-240 VAC, 50-60 Hz; 9-16 VDC OR 18-32 VDC - optional	100-240 VAC, 50-60 HZ; 18-24 VDC - optional
	1 amp maximum @ 120 VAC; 1.6A @ 24VDC, 3.2A @ 12 VDC	1 amp maximum @ 120 VAC; 1.6A @ 24VDC, 3.2A @ 12 VDC	1 amp maximum @ 120 VAC , 1.6A @ 24 VDC (Heated); 2 amps maximum @ 120 VAC (unheated)
	Analog: 1 or 2 4-20mA Isolated, 1200 ohms @ 24 VDC max load; Serial: RS232C, Protocol: Modbus Gould RTU or Daniel RTU or ASCII	Analog: 1 or 2 4-20mA Isolated, 1200 ohms @ 24 VDC max load; Serial: RS232C, Protocol: Modbus Gould RTU or Daniel RTU or ASCII	Analog: Two 4-20mA Isolated, 1200 ohms @ 24 VDC max load; Serial: RS232C - standard, RS485 and Ethernet - optional; Protocol: Modbus Gould RTU or Daniel RTU or ASCII
	2, General Fault and Concentration Alarms via Modbus and Analog Output(s)	Four General Fault and Concentration Alarms via Modbus and Analog Output(s)	2, General Fault and Concentration/Assignable Alarm
	Concentration, Cell Pressure and Temperature & Diagnostics	Concentration, Cell Pressure and Temperature & Diagnostics	Concentration, Cell Pressure and Temperature & Diagnostics
	NEMA 4, 7, 9 - Cast Aluminum	NEMA 3R - 304 Stainless Steel	NEMA 4X Stainless Steel Enclosures
	565 mm H x 413 mm W x 222 mm D; (22.25 H x 16.25 W x 8.75 D inches)	444 mm H x 376 mm W x 135 mm D (17.5 H x 14.8 W x 5.8 D inches)	1074 mm H x 508 mm W x 279 mm D (42.3 H x 20 W x 11 D inches)
	46.8 kg (103 lbs)	11.5 kg (25 lbs)	45 kg (100 lbs)
	438 mm H x 108 mm W; (17.3 H x 4.3 W inches)	438 mm H x 108 mm W (17.3 H x 4.3 W inches)	438 mm H x 108 mm W (17.3 H x 4.3 W inches)
	316L Series Polished Stainless Steel	316L Series Polished Stainless Steel	316L Series Polished Stainless Steel
	1	2	2
	CSA Class I, Div 1, Groups B, C and D, Temp Code T4	CSA Class I, Div 2, Groups A,B,C, and D, Temp Code T3C	CSA Class I, Div 2, Groups B,C, and D, Temp Code T3C (T3 with Heaters); Directives EN61010-1 & EN61326-1







TDL Analyzers		
	2-Pack & 3-Pack 	SS2100 
Target Components	H ₂ S and H ₂ O or H ₂ S and CO ₂ in Natural Gas (2-Pack); H ₂ S and H ₂ O and CO ₂ in Natural Gas (3-Pack)	H ₂ O, H ₂ S, CO ₂ , NH ₃ , C ₂ H ₂ , C ₂ H ₄ (Ranges from low ppmv to %)
Measurement Performance	Refer to Application Notes (AN 10902 for H ₂ S) (AN 10101 for H ₂ O) (AN 10303 for CO ₂)	Refer to application notes for application specific performance information
Environmental Temperature Range	-20° to 50° C (-4° to 122° F); -10° to 60° C (15° to 140° F) - optional	-20°C to +50°C (-4° to 122°F), -10°C to +60°C (14° to 140°F)-optional
Sample Cell Pressure Range	800-1200 mbar or 950-1700 mbar - optional	Typically 800-1200 mbara or 950-1700 mbara* - optional
Sample Cell Temperature Range	-20° to 50° C (-4° to 122° F); -10° to 60° C (15° to 140° F) - optional	-20°C to +50°C (-4° to 122°F), -10°C to +60°C (14° to 140°F)-optional
Maximum Cell Pressure	70 kPag (10 PSIG)	70 kPag (10 PSIG)
Voltage	120 or 240 VAC ±10%, 50-60 Hz, 314W max (3 total power connections) - standard; 18-24 VDC, 3.2A max (2 power connections + 200W AC heater power) - optional	120 or 240 VAC ±10%, 50-60 Hz, 260W (2 power connections)-standard; 18-24VDC
Max Current	3A max @ 120 VAC, 1.5A max @ 240 VAC Hz	1.6A max + 200W AC heater power - optional
Communication	4 isolated 4-20mA Analog Output, 1200 ohms @ 24 VDC max (concentration only), Channel 1 (H ₂ S) - RS232 (all parameters) and Ethernet Channel 2 & 3 (H ₂ O and/or CO ₂) - RS232 (all parameters) or Ethernet; Modbus Gould RTU or Daniel RTU	Two Isolated 4-20mA Analog Output, 1200 ohms @ 24 VDC max; RS232C and Ethernet; 250VAC, 3A NO Contact, 1.5A NC Contact 24VDC, 1A NO and NC Contact; Modbus Gould RTU or Daniel RTU or ASCII; Detector Power (Optics Health), Spectrum Reference Comparison and Peak Tracking (Spectrum Quality), Cell Pressure and Temperature (Overall System Health)
Alarms	Channel 1 (H ₂ S) - concentration alarm, general fault, validation fail, validation 1 active, validation 2 active; Channel 2 & 3 (H ₂ O + CO ₂) - general fault and hi/low concentration alarm per channel	Digital Outputs - Qty 5: Concentration Alarm, General Fault, Validation Fail, Validation 1 Active, Validation 2 Active - Digital Inputs - Qty 2: Flow Alarm, Validation Request
LCD Display	Concentration, Cell Pressure, and Temperature & Diagnostics	Concentration, Cell Pressure and Temperature & Diagnostics
Enclosure Type	Built with NEMA 4X 304 or 316L Stainless Steel enclosure	Built with NEMA 4X 304 or 316L Stainless Steel enclosure
Dimensions	1300-1500 H x 600-920 W x 300-450 D mm; (51 H x 24-36 W x 17 D inches) with Sample System	1300-1500 H x 600-920 W x 300-450 D mm; (51 H x 24-36 W x 17 D inches) with Sample System
Approximate Weight	204-227 kg (450-500 lbs) - with crate	204-227 kg (450-500 lbs) - with crate
Sample Cell Dimensions	N/A	N/A
Sample Cell Construction	316L Series Polished Stainless Steel	316L Series Polished Stainless Steel
Number of Sample Cells	2 or 3; Depends on Requirements	1
Certification/Approval	CSA Class I, Div 2, Groups B, C & D, T3 with heater, IP66; FCC Meets FCC Part 15, Subpart B, Sections 15.107 & 15.109; EMC EN/IEC 61326-1	CSA Class I, Div 2, Groups B, C & D, T3 with heater, IP66; FCC Meets FCC Part 15, Subpart B, Sections 15.107 & 15.109; EMC EN/IEC 61326-1

TDLAS Gas Analyzer	
	J22 
Measurement Data	
Target component	H ₂ O in Natural Gas
Principle of measurement	Tunable Diode Laser Absorption Spectroscopy (TDLAS)
Measurement ranges	0-500 to 0-6000 ppmv (0-24 to 0-284 lb/mmscf)
Repeatability	±1 ppmv or ±1% of reading (whichever is greater)
Accuracy	±2 ppmv plus 2% of reading (whichever is greater)
Electrical & Communications	
Controller display	4-line backlit display with touch control
Controller operation	Configuration via display or web servers
Controller housing materials	Coated copper-free aluminum
Outputs & communication	I/O 1: Modbus RTU over RS485; I/O 2 & 3: (freely selectable): analog (4-20 mA) or digital outputs I/O 2 & 3: Choose from configurable analog/status outputs or relay outputs
Power supply	Controller: 24 VDC ±20% or 100-240 VAC ±10%, 50/60 Hz, 10W Optional Heater: 100-240 VAC ±10%, 50/60 Hz, 80W
Sample Conditioning System	
Panel and enclosure materials	Sample Panel: Anodized aluminum Sample Conditioning Enclosure: 304 Stainless Steel
Inlet pressure range	140-310 kPa (20-45 psi)
Sample cell operating pressure range	800-1200 mbara (atmosphere) or 800-1700 mbara (flare)
Flow rate	0.5-1.0 slpm (1-2 scfh)
Ingress protection	IP66, Type 4X
Wetted materials including sample measurement cell	316L Stainless Steel, FKM O-Rings
Sample conditioning components	Includes verification port and options for filtration, pressure regulation, flowmeters, and safety purge
Certifications and Marks	Class 1, Div 1 & Class 1 Zone 1



Advanced Analysis - Sampling Systems

SE600 Series Sample Extraction Systems			
	SE620 	SE622 	SE640 
Type	Probe with Separate Regulator, GHR Single stage regulator	Probe with Separate Regulator, Vaporizing Regulator	Probe with Vaporizing Regulator and no filtering
Filtration	Membrane Separator at tip of probe	Membrane Separator at tip of probe	None
Phase	Gas	Gas	Liquid
Typical Applications	Upstream Rich Natural Gas with Heavier Hydrocarbons, Demethanized Natural Gas, X/Y Grade Gases	Upstream Rich Natural Gas with Heavier Hydrocarbons, Demethanized Natural Gas, X/Y Grade Gases	Light NGL's, Ethane, E/P Streams, Propane, Demethanized Natural Gas
Contaminant Level	Medium or High	Medium or High	Medium
Process Pressure	<3750 psig	<3750 psig	<3750 psig
Power: 110-265 VAC Heater Block	Up to 80 Watts	Up to 150 watts	Up to 200 watts
Power: 24 VDC Heater Block	Up to 25 watts	Not Available	Not Available
Certification/Approval	CSA Class I, Div 1, or ATEX Zone 1	CSA Class I, Div 1, or ATEX Zone 1	CSA Class I, Div 1, or ATEX Zone 1

	SC401 
Power	120 VAC/240 VAC/24 VDC
Heating Components	80 watt self-limiting block heater
Sample Gas Temperature Maintained	37°C (98°F)
Cabinet Construction	Hot-pressed glass fiber reinforced polyester
Certification	Designed for Class I, Div 1 Termination Enclosure with Termination Kit for Pony

Heated Sample Conditioning	
	P53 
Max Allowable Operating Pressure	3750 psig (241 BAR) @ 16°C (60°F)
Regulator	Single-stage MHR or Multi-stage MJTR
Wetted Parts	316 Stainless Steel
Power	120 VAC/240 VAC/24 VDC
Cabinet Construction	Hot-pressed Glass Fiber Reinforced Polyester (GRP) or Stainless
Certification	Designed for Class I, Div 1, Group D

Sample Tubing Bundles			
Materials		Performance Data	
Wetted Materials	316/316L SS: seamless tubing (ASTM A-213, A-269, A1016) or O'Brien Electropolished Tubing with or without SilcoTek SilcoNert 2000 lining (TrueTube EPS)	Low Ambient Design Temperature	-29°C (-20°F) with 40 kph (25 MPH) wind
Self Regulating Heat Tracer	32 Watt/m (10 Watt/ft)	High Ambient Design Temperature	40°C (104°F) with 16 kph (10 MPH) wind
Power Cable (optional)	3 conductor, 12 gauge, 90°C (194°F) rated tray cable	Process Designed Maintained Temperature	49°C at -29°C (120°F at -20°F)
Jacket	O'Brien SV47 proprietary thermoplastic formulation with UV resistance that exceeds standard PVC	Operating Voltage	120 VAC, 208 VAC, 240 VAC
Sample Tubing	6mm x 1mm, 1/4 x 0.035 in or 1/2 x 0.035 in wall	Maximum Inlet Temperature	121°C (250°F)
Tubing Bundles (Diameter O.D.)	Approximately 3.3 to 3.6 cm (1.3 to 1.4 in) without power cable; Approximately 3.6 to 4.8 cm (1.4 to 1.9 in) with power cable	Minimum Bend Radius	20 cm (8 in)
Sample Tubing Lengths	15 to 76 m (50 to 250 ft)	Heat Loss at Low Ambient	23 Watt/m (7 Watt/ft)
Certification/Approval	FM; CSA Class I, Div 1 or Div 2, CSA Div 1; IEC; ATEX Zone 1 and 2	Certification/Approval	FM; CSA Class I, Div 1 or Div 2, CSA Div 1; IEC; ATEX Zone 1 and 2



Advanced Analysis - SS500 Simple Sample System

Ideal Application Component Range		
Component	Abbreviation	Natural Gas Range (Table 1 & Table 2)
Methane	C ₁	50-100%
Ethane	C ₂	0-20%
Propane	C ₃	0-15%
Butanes	C ₄	0-5%
Pentanes	C ₅	0-2%
Hexanes and Heavier	C ₆ +	0-2%
Carbon Dioxide	CO ₂	0-20%
Nitrogen and other Inerts	N ₂	0-20%





SS500 Simple Sample System	
Target Component	Measures H ₂ O in natural gas steams (Table 1 & Table 2)
Performance	Refer to application notes (AN 10101 for H ₂ O)
Principle of Measurement	Tunable Diode Laser Absorption Spectroscopy (TDLAS)
Measurement Range	H ₂ O range 0.25-100 lb./MMSCF (5-2110 ppmv)
Environmental Temperature	-20° to 50° C (-4° to 122° F)
Sample Cell Pressure Range	700-1400 mbara (10.1-20.3 PSIA)
Sample Cell Temperature Range	-20° to 50° C (-4° to 122° F)
Maximum Cell Pressure	70 kPag (10 PSIG)
Voltage	100-240 VAC, 50-60 Hz, 9-16 VDC OR 18-32 VDC -- optional
Max Current	1 amp maximum @ 120 VAC, 1.6 A @ 24 VDC, 3.2 A @ 12 VDC
Communication	Analog: 1 or 2 4-20mA Isolated, 1200 ohms @ 24 VDC max load Serial: RS232C, Protocol: Modbus Gould RTU or Daniel RTU or ASCII
Alarms	2, general fault and concentration alarms via Modbus and analog output(s)
LCD Display	Concentration, cell pressure and temperature, and diagnostics
Area Classification	CSA Class I, Div 2, Groups A,B,C, and D, Temp Code T3C
Electronics with Sample Cell Dimensions	437 mm H x 422 mm W x 184.2 mm D (17.2 x 16.6 x 7.25 in.)
Sample Cell Dimensions	437 mm x 108 mm (H x W) (17.2 x 4.3 in.)

Advanced Analysis - TDL Sampling Systems

Probes used alongside ACES Sampling System

Genie 750 Direct Drive Probe	
	
Maximum Pressure Rating	NPT: 3,750 psig (258.6 barg) Unibody flanged: Dependent upon flange ANSI classification
Temperature Ranges	Type 6 membranes: -35°F (-37°C) to 185°F (85°C) Type 7 membrane: Up to 300°F (149°C)* *Actual limit depends on sealing material chosen. Refer to Temperature Range Comparison Chart
Maximum Recommended Flow Rate Results in approx. 2 PSI pressure differential. For higher flow rates, contact the factory.	Type 6 Best Rejection: 1.6 LPM (3.4 CFH)* Type 7 Highest Temps: 3.4 LPM (7.1 CFH)* *Actual conditions
Port Sizes	1/4" female NPT outlet
Probe Lengths For other lengths contact the factory.	L: 8", 12", 18", 24", 36", 48"
Process Connection Requirements	3/4", 1" or 1.5" NPT full opening threaded or flanged valve Ball, gate and double block and bleed valves are all suitable for use as long as their inner diameter is not less than 3/4". 1" NPT or larger process connection required for seal welding.
Wetted Materials For exotic materials of construction or SilcoTek coatings, contact the factory.	Machined parts: 316/316L stainless steel /NACE compliant and Kevlar® threaded bushing. All other metal parts: stainless steel / NACE compliant. Sealing material: User defined Membrane: Inert. Other materials available on request.

Genie 760 Drive	
	
Maximum Pressure Rating	NPT: 3,750 psig (258.6 barg) Unibody flanged: ANSI classification specific
Temperature Ranges	-40 °F (-40 °C) to 300 °F (149 °C) Actual limit depends on sealing material chosen. Refer to Temperature Range Comparison Chart.
Port Sizes	Outlet: 1/4" FNPT or 1/8" tube for LVAuxiliary: 1/8" female NPT (plugged from factory)
Probe Lengths For other lengths contact the factory.	L: 8", 12", 18", 24", 36", 48"
Process Connection Requirements	3/4", 1" or 1.5" NPT full opening threaded or flanged valve Ball, gate and double block and bleed valves are all suitable for use as long as their inner diameter is not less than 3/4". 1" NPT or larger process connection required for seal welding.
Wetted Materials For exotic materials of construction or SilcoTek coatings, contact the factory.	Machined parts: 316/316L stainless steel /NACE compliant and Kevlar® threaded bushing. All other metal parts: stainless steel / NACE compliant. Sealing material: User defined Membrane: Inert. Other materials available on request.

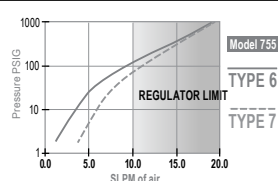
Genie 755 Direct Drive Probe	
	
Maximum Pressure Rating	NPT: 3,750 psig (258.6 barg) Unibody flanged: Dependent upon flange ANSI classification
Temperature Ranges	Type 6 membranes: -35°F (-37°C) to 185°F (85°C) Type 7 membrane: Up to 300°F (149°C)* *Actual limit depends on sealing material chosen. Refer to Temperature Range Comparison Chart.
Port Sizes	Outlet: 1/4" female NPT Auxiliary: 1/8" female NPT (plugged from factory)
Probe Lengths	L: 8", 12", 18", 24", 36", 48" A: ~ 20", 24", 30", 36", 48", 60"
Outlet Pressure Range psig (barg)	0-10 (0-0.7), 0-25 (0-1.7), 0-50 (0-3.4), 0-100 (0-6.9), 0-250 (0-17.2), 0-500 (0-35.4)
Process Connection Requirements	3/4", 1" or 1.5" NPT full opening threaded or flanged valve Ball, gate and double block and bleed valves are all suitable for use as long as their inner diameter is not less than 3/4". 1" NPT or larger process connection required for seal welding.
Wetted Materials	Machined parts: 316/316L stainless steel /NACE compliant & Kevlar® threaded bushing All other metal parts: stainless steel / NACE compliant Sealing material: User defined Regulator seat material: PFA Membrane: inert
Maximum Recommended Flow Rate Dependant on source pressure. See chart.	



Portfolio Overview

The purpose of the probe and sample bundle portfolio is to provide the equipment, ancillary to the analyzer provided by the PC, to enable the measurement. This is true of extractive measurements only. In-situ measurements, like that made by the RXN/Optograf in LNG are not applicable to this portfolio.

The purpose of the sample probes is to extract a sample in an optimal way. Each sample probe was selected for a range of applications/conditions. The sample probes are provided by A+ Corporation and Valtronics. They can be grouped into two categories: insertion, and fixed. Most of the probes used have a hydrophobic membrane for the rejection of liquids.

Insertion probes can be inserted into live, pressurized process while fixed probes cannot. All of the ACES systems utilize insertion probes. While the ACES systems use insertion probes, the insertion depth is not adjustable. The probe must be fully inserted for the enclosure to be installed around the probe assembly. When the direct-drive insertion probes are utilized without the ACES enclosure, they are insertion depth adjustable.



Fixed probes cannot be inserted into live process and must be installed when the process is isolated or during a shut-down. The Pony systems by Valtronics utilize the Genie from A+ which include a "foot-valve" which allows the membrane in the probe tip to be serviced while the process is live. These probes are still considered fixed however they can be serviced when the process is live (just not installed).



The purpose of the sample bundle is to transport a heated sample from the sample probe to the sample conditioning system. The tube type and heater cable wattage must be appropriate for the application. EP (electropolished tubing) should be used for differential H₂S measurements and non-differential H₂O measurements. Standard 316SS tubing may be used for any CO₂ application, % level H₂S, and Acetylene. EPS (electropolished, Silconert 2000 coated) must be used for any differential H₂O and NH₃ applications. 10 watt per foot heater cable will be suitable for virtually all applications not

in arctic conditions or high temperature saturated samples, for higher temp requirements or below -40 deg C ambient locations, 15 watt cables are available. 5 watt per foot cables are also available for high ambient temperature locations.

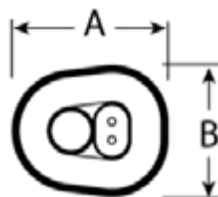

This is an electric tracing to be bundle. The maximum continuous or intermittent temperature is determined by the electric tracer below.

A: 1.3"
B: 1.2"

For installation convenience the outer jacket is printed with length markings every six feet.

The **end termination** kit is used to seal the heater cable at the *probe end* of the sample bundle. This is required for all tubing bundles. This is assuming that power will be supplied to the bundle at the sample system and not at the probe. If power is applied at the probe end of the bundle, then the end termination will be at the sample system end of the bundle (this is rarely done).



T210-ET End termination

End termination kit for use with any wattage model B, N, J and P tracers. FM approved, CSA certified and ATEX approved for use in hazardous areas.

Minimum installation temperature: -58°F/-50°C

Minimum service temperature: -60°F/-50°C

Approvals: FM Class I, II, III Div. 2, Groups A,B,C,D,E,F,G

CSA Class I, II, III Div. 2, Groups A,B,C,D,E,F,G,

ATEX II 2G Ex e II, II 2D Ex tD A21 IP66

The **power connection** kit is used for connecting power to the sample system end of the bundle. This may or may not be required for every installation but if it's not purchased then the customer will have to provide some other method of making this termination.



T210-PC Power Connection

Power connection kit with junction box for all B, J, JN, JB, N and P tracers. FM approved and CSA certified and for use in hazardous locations.

Minimum installation temperature: -40°F/-40°C

Minimum surface temperature: -75°F/-60°C

Approvals: FM Class I, II, III Div. 2, Groups A,B,C,D,E,F,G

CSA Class I, II, III Div. 2, Groups A,B,C,D,E,F,G



The **enclosure entry seal** should not be required often. One comes installed on the sample system and on the ACES probe enclosure.



TPKES-4 Enclosure Entry Seal

Heat shrink enclosure entry seal for bundles between 0.75"/28 mm and 1.6"/40 mm and panel thickness from 0"/0 mm to 0.5"/12 mm.

Probe Selection Guidelines

1. **71495432, 71495434, and 71495435**
ACES system that utilize the Genie 750 Direct Drive probe with different probe tube lengths (12", 18", and 24" respectively).
 - intended for saturated gas streams with no free liquid present and above ambient dew point,
 - membrane tip for free liquid rejection and Viton Elastomers,
 - not suitable for streams with % level aromatics present (Viton elastomers must be replaced with Kalrez),
 - 3/4" NPT process connection
 - 80 watt 120VAC heater,
 - CSA division 1 compliant, not certified.
 - Heat Trace Entry-seal Boot
2. **71495436, 71495437, and 71495438**
Genie 755 Direct Drive probe of different probe tube lengths (12", 18", and 24" respectively).
 - intended for superheated or saturated gas streams with no free liquid present under normal conditions and below ambient dew point,
 - membrane tip for free liquid rejection and Viton Elastomers,
 - not suitable for streams with % level aromatics present (Viton must be replaced with Kalrez),
 - 3/4" NPT process connection
3. **71495433**
ACES system that uses a Genie 760 Direct Drive probe with different probe tube lengths.
 - Intended for liquid streams that require at-tap vaporization,
 - no membrane tip,
 - HNBR elastomers,
 - 3/4" NPT process connection,
 - 12" long probe tube.
4. **71495439, 71495440, 71495441**
ACES system that uses a Genie 760 Direct Drive probe with different probe tube lengths (12", 18", and 24" respectively).
 - Intended for liquid streams that require at-tap vaporization,
 - no membrane tip,
 - not suitable for streams with % level aromatics present (Viton elastomers must be replaced with Kalrez),
 - 3/4" process connection
5. **71495442, 71495443, 71495444**
ACES system that uses a Low Volume Trace Genie 760 Direct Drive probe with different probe tube lengths (12", 18", and 24" respectively).
 - Intended for vapor phase Trace H₂O and O₂ (0–100ppm) streams that require no at-tap vaporization,
 - no membrane tip,
 - suitable for streams with % level aromatics present (uses Kalrez Elastomers),
 - 3/4" NPT process connection
6. **71495597, 71495598, 71495599, 71495600, 71495601, 71495602**
Mustang Pony enclosure with A+ Genie GPR probe with regulator and different probe tube lengths and process connection sizes (71495597 through 71495599 4", 7", 9" long tube and 3/4" NPT connection, 71495600 through 71495602 are 4", 7", 9" long tube and 1" NPT process connection). From an application perspective, these probes are interchangeable with the 750 ACES probes (71495432, 71495434, 71495435). They are shorter in length and not insertion probes. These may be preferred by some customers who don't like the idea of inserting a probe into high pressure or the potential for leaks with packing glands that the direct drive probes use.



Direct Drive Probe Spare Parts and Adders

- 1. 71495445**
Replacement Viton packing gland for Direct Drive probe.
- 2. 71495447**
Replacement membrane assembly for Direct Drive probes.
- 3. 71495448**
Speedwrench used for insertion and retraction of Direct Drive probes.
- 4. 71495449, 71495450, 71495451, 71495452, 71495453, 71495454**
A+ Genie GPR probe with regulator and different probe tube lengths and process connection sizes (71495449 through 71495441 4", 7", 9" long tube and 3/4" connection, 71495452 through 71495454 are 4", 7", 9" long tube and 1" process connection). From an application perspective, these probes are interchangeable with the 755 probes (71495436, 71495437, 71495438). They are shorter in length and not insertion probes. These may be preferred by some customers who don't like the idea of inserting a probe into high pressure or the potential for leaks with packing glands that the direct drive probes use.
- 5. 71495455**
This is an adder for A+ products used to purchase MTRs for the probe only (not regulator, tubing, or fittings).
- 6. 71495455**
This is an adder for A+ products used to purchase MTRs for the probe and regulator only (not tubing, or fittings).
- 7. 71495457**
This is an adder for A+ products used to purchase a Certificate of Conformance. This is a self-declaration stating what the product(s) purchased conform to.
- 8. 71495458**
This is an adder for A+ products stating the origin of the materials used in the manufacturing of the purchased product(s).
- 9. 71495459**
This is a crate fee adder that must be added for each ACES product purchased.



Table of Application and Recommended Probes

SpectraSensors Application	Recommended Probe(s)
10101 – H ₂ O in Natural Gas	71495436, 71495437, 71495438, 71495449, 71495450, 71495451, 71495452, 71495453, 71495454
10303 – CO ₂ in Natural Gas	71495436, 71495437, 71495438, 71495449, 71495450, 71495451, 71495452, 71495453, 71495454
10902 – H ₂ S in Natural Gas	71495436, 71495437, 71495438, 71495449, 71495450, 71495451, 71495452, 71495453, 71495454
11810 – O ₂ in Natural Gas (for ranges 1000ppm or greater)	71495436, 71495437, 71495438, 71495449, 71495450, 71495451, 71495452, 71495453, 71495454
H ₂ O/H ₂ S in H ₂ Recycle (23101, 23201, 23202, 20402)	71495436, 71495437, 71495438, 71495449, 71495450, 71495451, 71495452, 71495453, 71495454 TSP Fixed probe will often be required due to downstream industry requirements.
23302 – H ₂ S in Flare Gas	TSP only – velocity of flow during flaring event is too high for standard probes (>200 ft/second)
27301 – H ₂ O Alkylation Feedstock	Liquid - TSP if sold with Trace analyzer If sold with non-Trace analyzer - 71495439, 71495440, 71495441
27401 – H ₂ O n-Butane feed Gas	Liquid - TSP only
23501 – H ₂ O in Propane/Propylene Product	71495439, 71495440, 71495441
65201 – H ₂ O in Instrument Air	71495436, 71495437, 71495438, 71495449, 71495450, 71495451, 71495452, 71495453, 71495454
33602 – H ₂ S in Amine Scrubber Outlet	71495436, 71495437, 71495438, 71495449, 71495450, 71495451, 71495452, 71495453, 71495454
33701 – H ₂ O – Desiccant Dryer Outlet	71495442, 71495443, 71495444
33802 – H ₂ S – NGL Residue Gas Product Purity	71495436, 71495437, 71495438, 71495449, 71495450, 71495451, 71495452, 71495453, 71495454
33901 – H ₂ O – NGL Residue Gas Product Purity	71495442, 71495443, 71495444
34002 – H ₂ S Raw Gas Feed / Produced Gas	71495436, 71495437, 71495438, 71495449, 71495450, 71495451, 71495452, 71495453, 71495454
34103 – CO ₂ Raw Gas Feed / Produced Gas	71495436, 71495437, 71495438, 71495449, 71495450, 71495451, 71495452, 71495453, 71495454
36103 – CO ₂ Amine Outlet	71495436, 71495437, 71495438, 71495449, 71495450, 71495451, 71495452, 71495453, 71495454
36602 – H ₂ S Acid Gas	TSP only
35001,35101,35201,35301 – H ₂ O - NGL Fractionation	71495436, 71495437, 71495438, 71495449, 71495450, 71495451, 71495452, 71495453, 71495454
35003,35103,35203 – CO ₂ - NGL Fractionation	71495436, 71495437, 71495438, 71495449, 71495450, 71495451, 71495452, 71495453, 71495454
35002,35102,35202,35302 – H ₂ S – NGL Fractionation	71495436, 71495437, 71495438, 71495449, 71495450, 71495451, 71495452, 71495453, 71495454
34602 – H ₂ S Solid Scavenger Outlet	71495436, 71495437, 71495438, 71495449, 71495450, 71495451, 71495452, 71495453, 71495454
44201 – H ₂ O LNG Desiccant Dryer	71495442, 71495443, 71495444 TSP Fixed probe will often be required due to industry requirements.
44401 – H ₂ O – Receiving Terminal	71495442, 71495443, 71495444 TSP Fixed probe will often be required due to industry requirements.
44303 – CO ₂ – LNG Amine Unit	71495436, 71495437, 71495438, 71495449, 71495450, 71495451, 71495452, 71495453, 71495454
44302 – H ₂ S – LNG Amine Unit	71495436, 71495437, 71495438, 71495449, 71495450, 71495451, 71495452, 71495453, 71495454
54611 – C ₂ H ₂ Back End Converter – Mid Bed	TSP Fixed probe will likely be required due to industry requirements.
54711 – C ₂ H ₂ Back End Converter – Outlet	TSP Fixed probe will likely be required due to industry requirements.
54911 – C ₂ H ₂ Ethylene Product	TSP Fixed probe will likely be required due to industry requirements.
55101 – H ₂ O Ethylene Product	TSP Fixed probe will likely be required due to industry requirements.
55101 – H ₂ O Propylene Product	TSP Fixed probe will likely be required due to industry requirements.
55113 – NH ₃ in Pure Propylene	TSP Fixed probe will likely be required due to industry requirements.
54801 – H ₂ O Crack Gas Dryer Outlet	71495442, 71495443, 71495444 TSP Fixed probe will often be required due to industry requirements.
56203 – CO ₂ in Steam Cracker / Caustic Tower Inlet	71495436, 71495437, 71495438, 71495449, 71495450, 71495451, 71495452, 71495453, 71495454 TSP Fixed probe will often be required due to industry requirements.
56902 – H ₂ S in Steam Cracker / Caustic Tower Inlet	71495436, 71495437, 71495438, 71495449, 71495450, 71495451, 71495452, 71495453, 71495454 TSP Fixed probe will often be required due to industry requirements.
55202 – H ₂ S in UOP C3 Oleflex Reactor Effluent	71495436, 71495437, 71495438, 71495449, 71495450, 71495451, 71495452, 71495453, 71495454 TSP Fixed probe will often be required due to industry requirements.
57901 – H ₂ O in UNIPOL PE Ethylene Feed	71495442, 71495443, 71495444 TSP Fixed probe will often be required due to industry requirements.
58001 – H ₂ O in Polyethylene Feed	71495442, 71495443, 71495444 TSP Fixed probe will often be required due to industry requirements.
55913 – NH ₃ in Ethylene Product	71495442, 71495443, 71495444 TSP Fixed probe will often be required due to industry requirements.
65803 – CO ₂ – Coal Liquefaction / Benfield Outlet	71495436, 71495437, 71495438, 71495449, 71495450, 71495451, 71495452, 71495453, 71495454 TSP Fixed probe will often be required due to industry requirements.



-Add when a tube bundle would be recommended.





- Define more clearly cutoff criteria for aromatics (BTEx) and CO₂/H₂S





Services

www.us.endress.com/services

	
<p>Applicator is a convenient tool for selection and sizing of the appropriate measuring instrument. Simply enter your parameters and Applicator will determine a reliable selection of suitable devices. Visit www.us.endress.com/applicator</p>	<p>W@M® - Life Cycle Management is an open and flexible information platform with on-site tools and services supporting you along the life cycle. Availability of instrument data 24 hours a day 365 days a year. Visit www.us.endress.com/wam</p>

Commissioning services	Technical support	Repair	Field Service
			
<p>Endress+Hauser service technicians perform the setup of the instruments according to defined Standard Operating Procedures (SOP) - this ensures constant performance quality. They are trained to application-specific regulatory requirements. Our teams use special tools designed to ensure quick and efficient commissioning of instruments and confirm the function of the device. Visit www.us.endress.com/commissioning-services</p>	<p>We will support you throughout the entire product lifecycle, be it in troubleshooting, emergency spares, calibration or straightforward advice. Visit www.us.endress.com/support Technical support videos also available at www.us.endress.com/howto. See below.</p>	<p>We offer technical checks, preventative maintenance, and repair followed by functional or even metrological tests as well as calibration in our local or accredited laboratories. Visit www.us.endress.com/services</p>	<p>Our dedicated team of troubleshooters are always on hand in emergencies for fast and efficient diagnosis and repair. Visit www.us.endress.com/services</p>

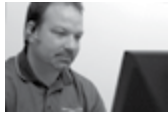
Calibration services	Calibration Management	Maintenance services	Support services
			
<p>From regular checking to validation and calibration generations, Endress+Hauser delivers cost-effective services that covers all your critical measuring points. All of our calibration laboratories and primary facilities are traceable to national and international standards. On-site calibration is available and is performed by our highly trained staff. Calibration services can include adjustment, repair or replacement of the equipment. Calibration labs and on-site calibrations are accredited to ISO 17025. Visit www.us.endress.com/calibration-usa</p>	<p>Ensure continuous product quality with Calibration Management (calibration cycles, schedules for performing calibration, coordination of personnel and certified calibration equipment). Visit www.us.endress.com/services</p>	<p>Endress+Hauser offers a range of maintenance services that includes several levels of support (Preventative, Extended, Total) allowing increased control of your maintenance budget. Visit www.us.endress.com/maintenance_services</p>	<p>Support Services is a portfolio of services dedicated to support you remotely by phone and email, in order to keep your Endress+Hauser installed base, software, and/or automated solutions running smoothly over time. Visit www.us.endress.com/services</p>



 YouTube Technical Support videos
www.us.endress.com/howto







PTU® (Process Training University)
(now includes End User Academy)





60 years of instrument and industry experience built it into training that helps our customers get the hands-on experience and knowledge they need. Our training packages are not merely limited to classroom and laboratory experiences, but have been broadened to include on-line training (End User Academy) and on-site training as well. We can even help you design a blended approach. Classroom and laboratory courses are held at one of our many Process Training Unit (PTU) locations across the country. Visit www.us.endress.com/training





Analytical Solutions	Energy Solutions
	
<p>Complete turnkey solutions for your analytical measuring requirements</p> <ul style="list-style-type: none"> ■ Monitoring stations ranging from panels over cabinets to completely equipped containers for water and wastewater applications and steam-water circuits ■ Automation solutions ranging from aeration control or phosphate dosing in wastewater treatment plants to fully automated measuring, cleaning and calibration systems for pH and ORP sensors in the chemical and life sciences industries 	<p>Reduce your energy costs from measured value to energy usage</p> <ul style="list-style-type: none"> ■ Smart scale energy solutions for <ul style="list-style-type: none"> - heating systems - cooling systems - compressed air systems - steam systems - electrical systems - waste water treatment ■ Smart scale energy solutions connectivity and integration ■ Energy consulting services

Tank and Terminal Management Solutions	Fluid Management Solutions	Field Network Engineering
		
<p>Solutions for custody transfer, inventory control and business administration. Endress+Hauser solutions include: design, production, installation, servicing of instrumentation, data acquisition, and business process integration</p>	<p>Endress+Hauser provides turnkey Fluid Management Solutions to suit your high accuracy requirements during the loading and offloading, bunkering as well as batching processes</p>	<p>Reduce risk and capital expenditure with your partner in digital communication. Endress+Hauser offers a complete set of services to design, engineer, install, commission and maintain a network solution, taking responsibility for the overall performance of the solution.</p>

Inventory Management Solutions	Plant Asset Management
	
<p>Comprehensive solutions that incorporate a full range of measurement devices and communication systems for data collection and transmission along with inventory management software and value added services. Providing complete inventory visibility 24 hours a day, 7 days a week, anywhere in the world via our intuitive web interface.</p>	<p>Supports you in optimizing your installed base in the commissioning and operation phase. Our comprehensive portfolio supports you with instruments, solutions and services. We provide valuable asset information over the entire life cycle.</p>

Hand Gauge Chambers

<p>For your Automatic Tank Gauging applications, a hand gauge chamber offers the benefits of easy access for pulling samples. No need to interrupt your ATG</p>

Netilion	SupplyCare
	
<p>Netilion is an IIoT platform combining digital services and system components to improve the lifecycle and asset management, maintenance, and support of instruments and analyzers. Netilion enables users to keep track of their installed base, documentation and data management, and instruments' performance and health status. Netilion's digital services available today are Scanner, Analytics, Health, Library, Value and Inventory.</p> <p>Netilion Scanner is a free smartphone app that guides the user in capturing field instrument asset data, while utilizing QR code or RFID tag. It can store images and instrument location, criticality and accessibility information. Netilion system components such as field gates and edge devices can be used to upload installed base information and create lists of the instruments, without having to interact with the control system.</p> <p>Analytics can be used to create a digital twin of the system and analyzed with the help of dashboards to initiate proactive maintenance measures for critical instruments or swap out discontinued instruments. Netilion Library helps users organize working files and documents. It is a file sharing and data management service for the complete life cycle of an instrument.</p> <p>Netilion Health visualizes the diagnostic data provided by an instrument and receives instructions to address the issue. This improves the ability to respond in cases where maintenance or service is required.</p> <p>Netilion Value is a digital service that collects process data from the field and makes them accessible anytime and anywhere. It displays the values in various features such as the dashboard, history, tracking map, and more. Netilion Inventory with Micropilot FWR30 is a very straightforward and cost-effective way to start into basic Inventory Monitoring.</p>	<p>SupplyCare is a web-based information system for remote monitoring of tank and silo inventory at multiple site locations. Current measurement values of on-site assets can be accessed via fieldgates company-wide in the Intranet or worldwide via public telephone networks and the Internet. SupplyCare software for the collection and processing of data can either be installed on your premises or hosted by Endress+Hauser. Conventional web browsers allow information to be called up by authorized materials administration and logistics personnel – at any time and from any workplace. Secure access via the Internet can be provided for external partners and service providers. As an alternative or supplementary option, measured data can be integrated into existing systems at logistics, enterprise and management levels.</p>

Personal and digital.
My Endress+Hauser.



Fast. Easy. Convenient.

Introducing new possibilities on **Endress.com!**

- Set up an account to shop for devices, spare parts & accessories
- Get easy access to technical information and documentation
- Buy online or request a quote from a sales representative
- Track the status of your quotes and orders
- View both online and offline transactions - all in one place
- Search quickly for products with our Product Finder, or by entering an order code or serial number



Register Today!



Set up your account and
start shopping today!
www.us.endress.com/e-commerce

Endress + Hauser



People for Process Automation

www.addresses.endress.com



EC00009Z/24/EN/2.1.21
(05.21)
©Endress+Hauser, Inc. 2021