



Level



Pressure



Flow



Temperature



Liquid  
Analysis



Registration



Systems  
Components



Services



Solutions

## Description of Instrument Functions

# Prosonic T FMU30

## Ultrasonic Level Measurement

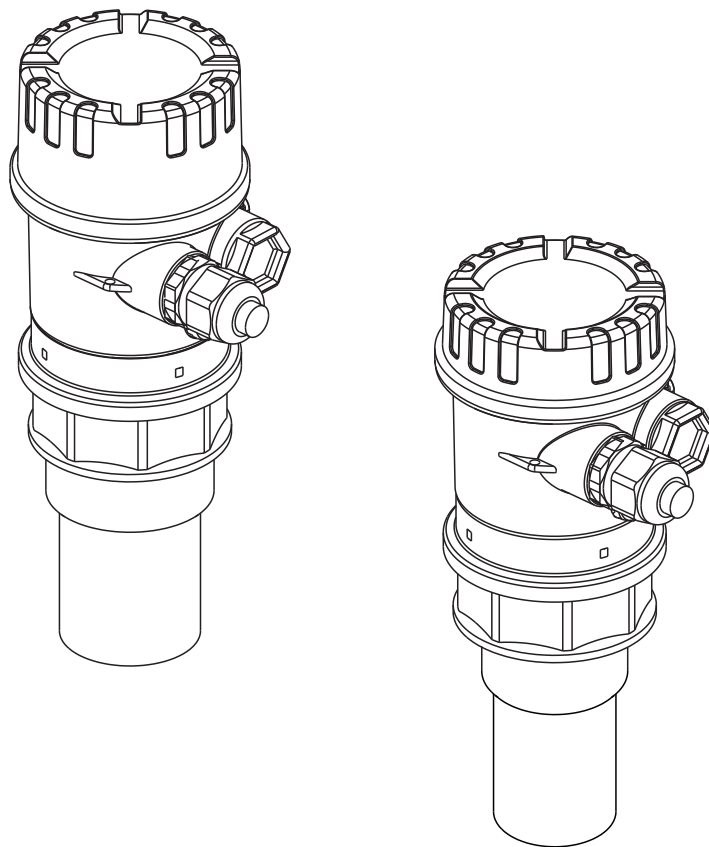

# Short instructions

KA290F/00/A2/12.09  
71106912

## Prosonic T - Quick Setup

⊕ and ⊖ : increase contrast  
⊖ and ⊕ : decrease contrast

000 measured value									008 dist./ meas value
Group selection									
00 basic setup	002 tank shape	003 medium property	004 process cond.	005 empty calibr.	006 full calibr.	008 dist./ meas value	051 check distance	052 range of mapping	053 start mapping
01 safety settings	- dome ceiling - horizontal cyl. - bypass ...	- unknown liquid - > 4 mm (> 0.16 in) - < 4 mm (< 0.16 in)	- standard calm surface - add. agitator ...	input E (see sketch)	input F (see sketch)	D and L are displayed (see sketch)	- ok - too small - too big - unknown - manual	confirm suggestion or specify range	
03 temperature									
04 linearisation									
05 extended calibr.									
06 output									
0E Envelope curve	0E1 plot settings	0E2 recording curve							
09 display	092 language	...							
0A diagnostics	0A0 present error	0A1 previous error	...						
0C system parameter	0C0 tag no.	...							
			0A3 reset 333	0A4 unlock parameter 100	...				

BD: blocking distance  
SD: safety distance

71106912

## Contents of the operating instructions

This operating instructions contain all functions off the Prosonic T FMU30 operating menu. Information on mounting, wiring, trouble shooting and maintenance can be found in the document BA00387F/00/EN. These documents can be found on the CD-ROM "Device Descriptions + Documentation".

## Table of contents

<b>1</b>	<b>Notes on use</b> . . . . .	<b>5</b>	<b>8</b>	<b>Function group "output" (06)</b> . . . . .	<b>47</b>
1.1	Using the table of contents to locate a function description . . . . .	5	8.1	Function "thres. main val." (062) . . . . .	47
1.2	Using the graphic of the function menu to locate a function description . . . . .	5	8.2	Function "curr. output mode" (063) . . . . .	47
1.3	Using the index of the function menu to locate a function description . . . . .	5	8.3	Function "fixed cur. value" (064) . . . . .	48
<b>2</b>	<b>Function menu</b> . . . . .	<b>13</b>	8.5	Function "simulation value" (066) . . . . .	50
<b>3</b>	<b>Function group "basic setup" (00)</b> . . .	<b>15</b>	8.6	Function "output current" (067) . . . . .	50
3.1	Function "measured value" (000) . . . . .	15	8.7	Function "4mA-value" (068) . . . . .	50
3.2	Function "tank shape" (002) . . . . .	15	8.8	Function "20mA-value" (069) . . . . .	50
3.4	Function "process cond." (004) . . . . .	16	<b>9</b>	<b>Function group "Envelope curve" (0E)</b>	<b>51</b>
3.6	Function "blocking dist." (059) . . . . .	18	9.1	Function "plot settings" (0E1) . . . . .	51
3.8	Display (008) . . . . .	19	9.2	Function "recording curve" (0E2) . . . . .	51
3.10	Function "range of mapping" (052) . . . . .	21	<b>10</b>	<b>Function group "display" (09)</b> . . . . .	<b>55</b>
3.11	Funktion "start mapping" (053) . . . . .	21	10.1	Function "language" (092) . . . . .	55
<b>4</b>	<b>Function group "safety settings" (01).</b>	<b>23</b>	10.2	Function "back to home" (093) . . . . .	55
4.1	Function "output on alarm" (010) . . . . .	23	10.4	Function "no.of decimals" (095) . . . . .	56
4.2	Function "output on alarm" (011) . . . . .	24	10.5	Function "sep. character" (096) . . . . .	56
4.4	Function "ramp %span/min" (013) . . . . .	26	10.6	Function "display test" (097) . . . . .	56
4.5	Function "delay time" (014) . . . . .	26	<b>11</b>	<b>Function group "diagnostics" (0A)</b> . . .	<b>57</b>
4.7	Function "in safety dist." (016) . . . . .	27	11.2	Function "previous error" (0A1) . . . . .	58
<b>5</b>	<b>Function group "temperature" (03) ..</b>	<b>31</b>	11.3	Function "clear last error" (0A2) . . . . .	58
5.1	Function "measured temp." (030) . . . . .	31	11.6	Function "measured dist." (0A5) . . . . .	61
5.2	Function "max. temp. limit" (031) . . . . .	31	11.7	Function "measured level" (0A6) . . . . .	61
5.3	Function "max. meas. temp." (032) . . . . .	31	11.8	Function "detection window" (0A7) . . . . .	62
5.5	Function "defect temp. sens." (034) . . . . .	32	<b>12</b>	<b>Function group "system parameters" (0C)</b>	<b>65</b>
<b>6</b>	<b>Function group "linearisation" (04) ..</b>	<b>33</b>	12.1	Function "tag no." (0C0) . . . . .	65
6.1	Function "level/ullage" (040) . . . . .	33	12.2	Function "protocol+sw-no." (0C2) . . . . .	65
6.5	Function "input level" (044) . . . . .	39	12.3	Function "serial no." (0C4) . . . . .	65
6.7	Function "max. scale" (046) . . . . .	40	12.5	Function "temperature unit" (0C6) . . . . .	66
6.8	Function "diameter vessel" (047) . . . . .	40	<b>13</b>	<b>Function group "service" (0D).</b> . . . . .	<b>69</b>
<b>7</b>	<b>Function group "extended calibr." (05).</b>	<b>41</b>	<b>14</b>	<b>Signal evaluation</b> . . . . .	<b>71</b>
7.1	Function "selection" (050) . . . . .	41	14.1	Envelope curve . . . . .	71
7.2	Function "check distance" (051) . . . . .	41	<b>15</b>	<b>Trouble shooting</b> . . . . .	<b>75</b>
7.3	Function "range of mapping" (052) . . . . .	42	15.1	System error messages . . . . .	75
7.4	Function "start mapping" (053) . . . . .	42	<b>Index function menu</b> . . . . .	<b>79</b>	
7.5	Function "pres. map dist." (054) . . . . .	43			
7.7	Function "echo quality" (056) . . . . .	44			
7.8	Function "offset" (057) . . . . .	45			
7.9	Function "output damping" (058) . . . . .	45			
7.10	Function "blocking dist." (059) . . . . .	45			



# 1 Notes on use

You have various options for accessing the descriptions of instrument functions or how to enter parameters.

## 1.1 Using the table of contents to locate a function description

All the functions are listed in the table of contents sorted by function group (e.g. basic setup, safety settings, etc.). You can access a more detailed description of a function by using a page reference / link.

The table of contents is on →  3.

## 1.2 Using the graphic of the function menu to locate a function description

This guides you step by step from the highest level, the function groups, to the exact function description you require.

All the available function groups and instrument functions are listed in the table (→  79). Select your required function group or function. You can access an exact description of the function group or function by using a page reference.

## 1.3 Using the index of the function menu to locate a function description

To simplify navigation within the function menu, each function has a position which is shown in the display. You can access each function via a page reference in the function menu index (→  79) which lists all the function names alphabetically and numerically.

## 1.4 General structure of the operating menu

The operating menu is made up of two levels:

■ **Function groups (00, 01, 03, ..., 0A, 0C):**

The individual operating Selection of the instrument are split up roughly into different function groups. The function groups that are available include, e.g.: **"basic setup"**, **"safety settings"**, **"output"**, **"display"**, etc.

■ **Functions (001, 002, 003, ..., 0A6, 0C8):**

Each function group consists of one or more functions. The functions perform the actual operation or parameterisation of the instrument. Numerical values can be entered here and parameters can be selected and saved. The available functions of the **"basic setup (00)"** function group include, e.g.: **"tank shape (002)"**, **"medium property (003)"**, **"process cond. (004)"**, **"empty calibr. (005)"**, etc.

If, for example, the application of the instrument is to be changed, carry out the following procedure:

1. Select the **"basic setup (00)"** function group.
2. Select the **"tank shape (002)"** function (where the existing tank shape is selected).

### 1.4.1 Identifying the functions

For easy orientation within the function menus, for each function a position is shown on the display.

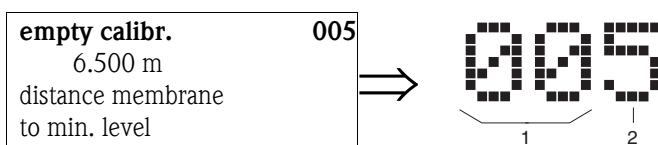

- 1 Function group  
2 Function

The first two digits identify the function group:

- **basic setup** 00
- **safety settings** 01
- **temperature** 03
- ...

The third digit numbers the individual functions within the function group:

- **basic setup** 00 →
- **tank shape** 002
- **medium property** 003
- **process cond.** 004
- ...

Hereafter the position is always given in brackets (e.g. **"tank shape" (002)**) after the described function.

## 1.5 Display and operating elements

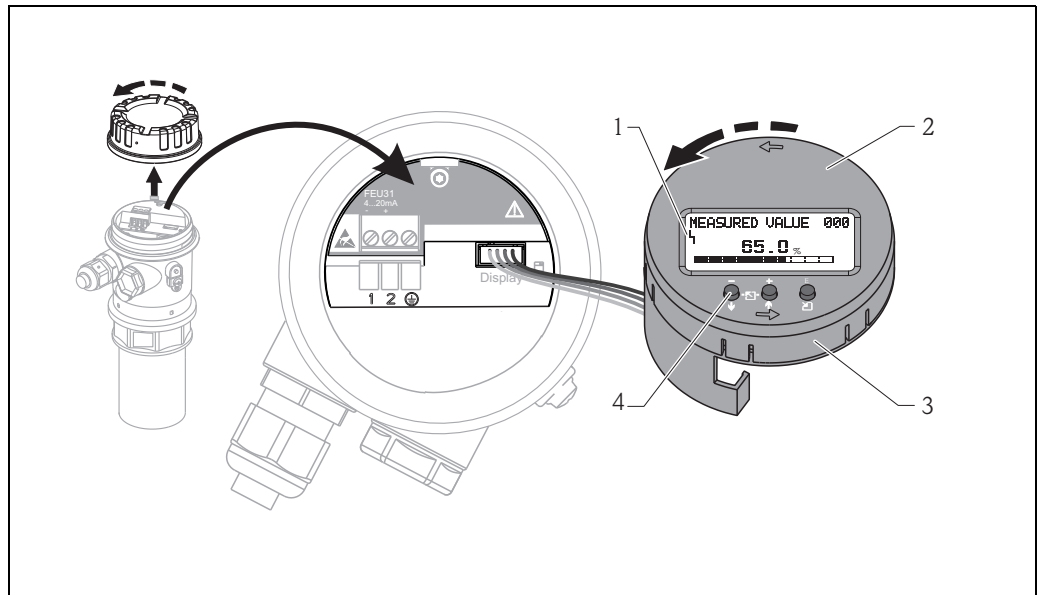

**1:** Display symbol **2:** Display (rotatable) **3:** Plug-in module **4:** Function keys

## 1.5.1 Display

### Liquid crystal display (LCD):

Four lines with 20 characters each. Display contrast adjustable through key combination.

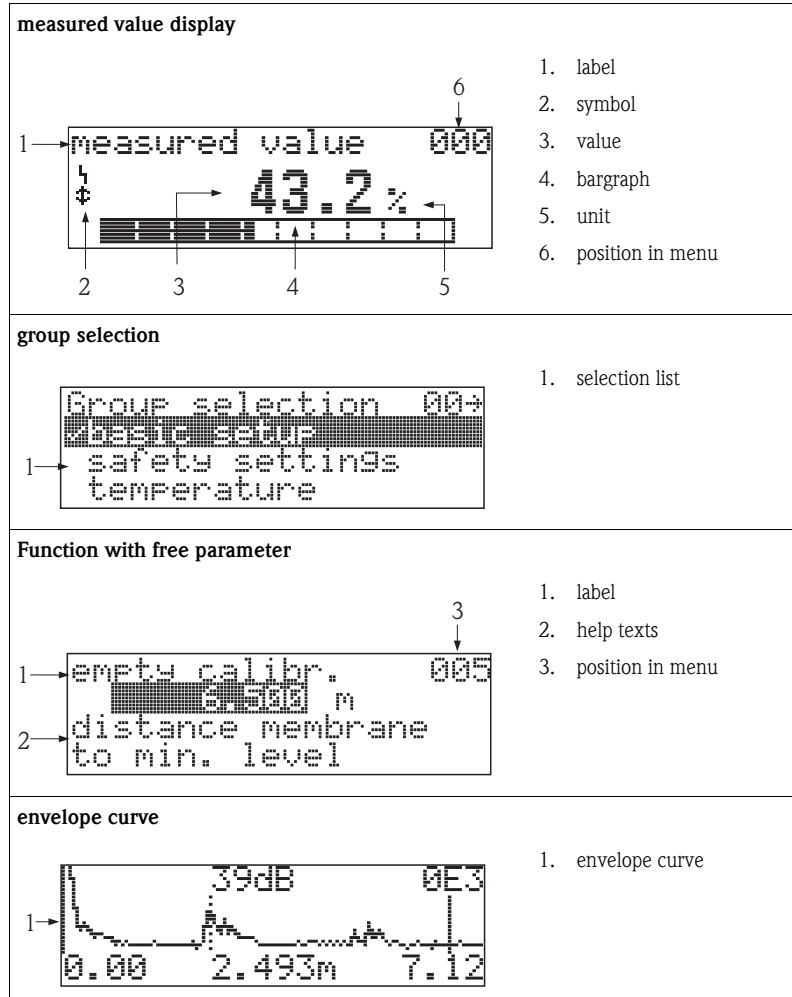



In the measured value display, the bargraph corresponds to the output.

The bargraph is segmented in 10 bars. Each completely filled bar represents a change of 10% of the adjusted span.



### 1.5.2 Display symbols







The following table describes the symbols that appear on the liquid crystal display:

Symbols	Meaning
	<b>ALARM_SYMBOL</b> This alarm symbol appears when the instrument is in an alarm state. If the symbol flashes, this indicates a warning.
	<b>LOCK_SYMBOL</b> This lock symbol appears when the instrument is locked, i.e. if no input is possible.

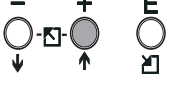
### 1.5.3 Key assignment

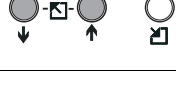
The operating elements are located inside the housing and are accessible for operation by opening the lid of the housing.

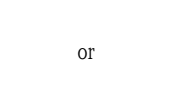
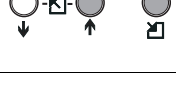
#### Function of the keys

(The keys to press are displayed in grey.)	
	Navigate upwards in the selection list Edit numeric value within a function
	Navigate downwards in the selection list Edit numeric value within a function
	Navigate to the left within a function group
	Navigate to the right within a function group, confirmation.
 or 	Contrast settings of the LCD
	Hardware lock / unlock After a hardware lock, an operation of the instrument via display or communication is not possible! The hardware can only be unlocked via the display. An unlock parameter must be entered to do so.

## 1.5.4 Operation

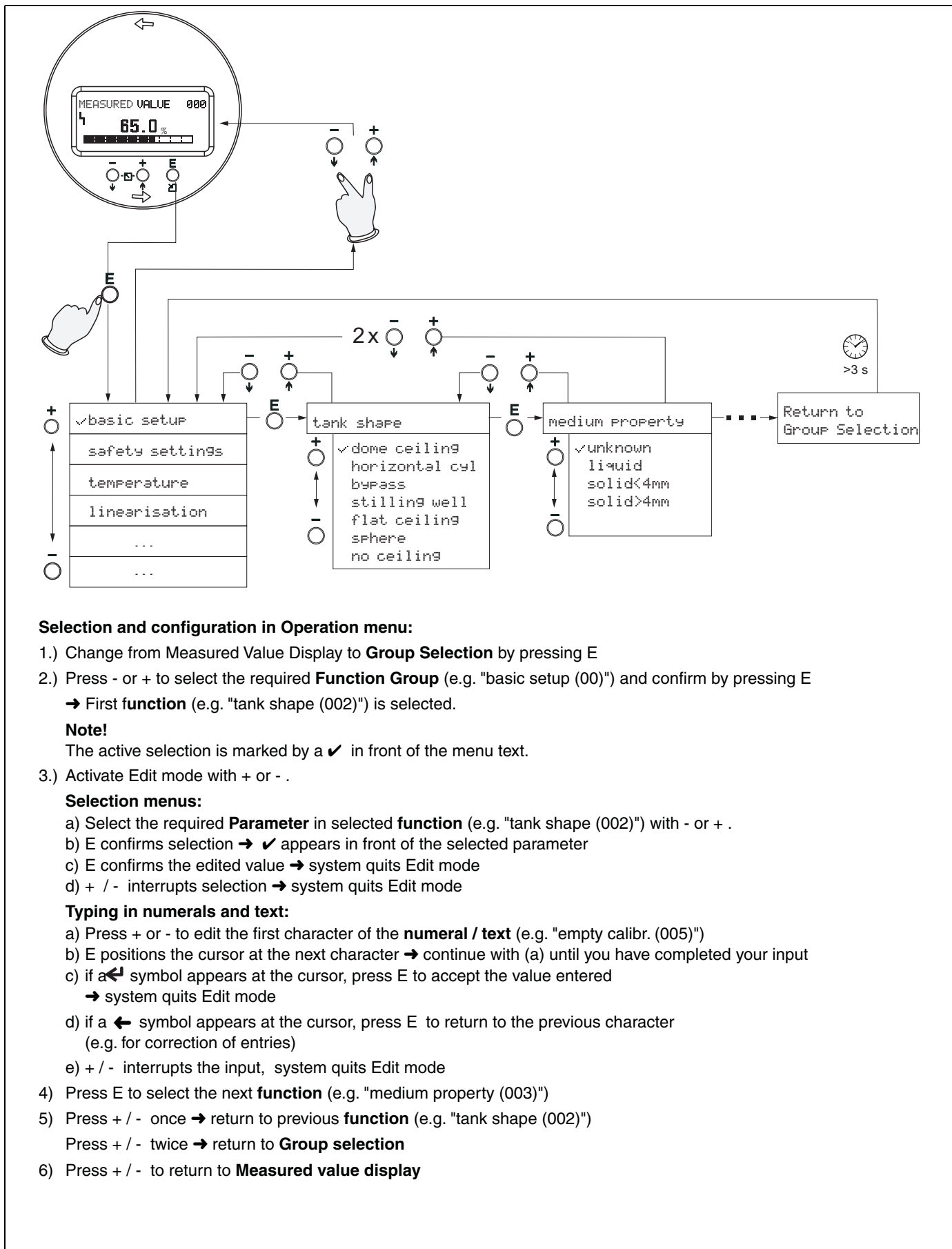

## 1.6 Commissioning

### 1.6.1 Switching on the measuring device

When the instrument is switched on for the first time, the following messages appear on the display.

Then the following appear for approximately five seconds:

- Device type
- Software version

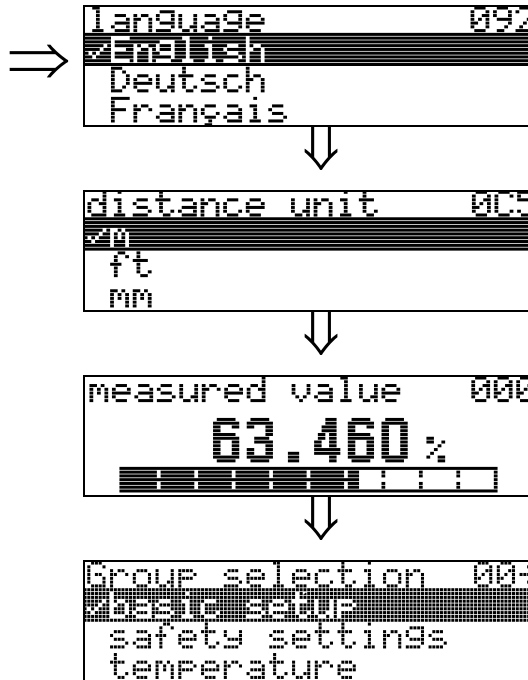
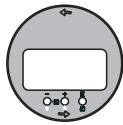

After 5 s or after you have pressed E the following message appears

Select the language  
 (this message appears the first time the instrument is switched on)

Select the basic unit  
 (this message appears the first time the instrument is switched on)

The current measured value is displayed

After E is pressed, you reach the group selection.

This selection enables you to perform the basic setup



## 2 Function menu

Function group	Function	Description
<b>basic setup 00</b> (→ 15) ↓	measured value 000 →	→ 15
	tank shape 002 →	→ 15
	medium property 003 →	→ 16
	process cond. 004 →	→ 16
	empty calibr. 005 →	→ 18
	blocking dist. 059 →	→ 18
	full calibr. 006 →	→ 19
	display 008 →	→ 19
	check distance 051 →	→ 20
	range of mapping 052 →	→ 21
	start mapping 053 →	→ 21
	display 008 →	→ 22
	<b>safety settings 01</b> (→ 23) ↓	output on alarm 010 →
output on alarm 011 →		→ 24
outp. echo loss 012 →		→ 25
ramp %span/min 013 →		→ 26
delay time 014 →		→ 26
safety distance 015 →		→ 27
in safety dist. 016 →		→ 27
ackn. alarm 017 →		→ 29
<b>temperature 03</b> (→ 31) ↓	measured temp. 030 →	→ 31
	max. temp. limit 031 →	→ 31
	max. meas. temp. 032 →	→ 31
	react high temp. 033 →	→ 32
	defect temp. sens. 034 →	→ 32
<b>linearisation 04</b> (→ 33) ↓	level/ullage 040 →	→ 33
	linearisation 041 →	→ 34
	customer unit 042 →	→ 38
	table no. 043 →	→ 39
	input level 044 →	→ 39
	input volume 045 →	→ 40
	max. scale 046 →	→ 40
	diameter vessel 047 →	→ 40
<b>extended calibr. 05</b> (→ 41) ↓	selection 050 →	→ 41
	check distance 051 →	→ 41
	range of mapping 052 →	→ 42
	start mapping 053 →	→ 42
	pres. map dist. 054 →	→ 43
	cust. tank map 055 →	→ 44
	echo quality 056 →	→ 44
	offset 057 →	→ 45
	output damping 058 →	→ 45
	blocking dist. 059 →	→ 45

Function group	Function	Description
<b>output</b> <b>06</b> (see → 47) ↓	thres. main val.      062	→ → 47
	current output mode      063	→ → 47
	fixed cur. value      064	→ → 48
	simulation      065	→ → 49
	simulation value      066	→ → 50
	output current      067	→ → 50
	4 mA value      068	→ → 50
	20 mA value      069	→ → 50
<b>envelope</b> <b>0E</b> (→ 51) ↓	plot settings      0E1	→ → 51
	recording curve      0E2	→ → 51
	envelope curve display      0E3	→ → 52
<b>display</b> <b>09</b> (see → 55) ↓	language      092	→ → 55
	back to home      093	→ → 55
	format display      094	→ → 56
	no.of decimals      095	→ → 56
	sep. character      096	→ → 56
	display test      097	→ → 56
	<b>diagnostics</b> <b>0A</b> (see → 57) ↓	present error      0A0
previous error      0A1		→ → 58
clear last error      0A2		→ → 58
reset      0A3		→ → 59
unlock parameter      0A4		→ → 60
measured dist.      0A5		→ → 61
measured level      0A6		→ → 61
detection window      0A7		→ → 62
application par.      0A8		→ → 63
<b>system parameter</b> <b>0C</b> (see → 65) ↓	tag no.      0C0	→ → 65
	protocol+sw-no.      0C2	→ → 65
	serial no.      0C4	→ → 65
	distance unit      0C5	→ → 66
	temperature unit      0C6	→ → 66
	download mode      0C8	→ → 67
	<b>service</b> <b>D00</b>	service level      D00

### 3 Function group "basic setup" (00)

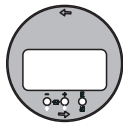

```

Group selection 000
basic setup
safety settings
temperature
  
```

#### 3.1 Function "measured value" (000)

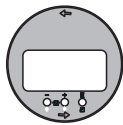

```

measured value 000
 63.460 %
  
```

This function displays the current measured value in the selected unit (see "customer unit" (042) function). The number of places after decimal point can be selected in the "no.of decimals" (095) function.

#### 3.2 Function "tank shape" (002)

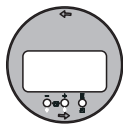

```

tank shape 002
dome ceiling
horizontal cyl
bypass
  
```

This function is used to select the tank shape.

#### Selection

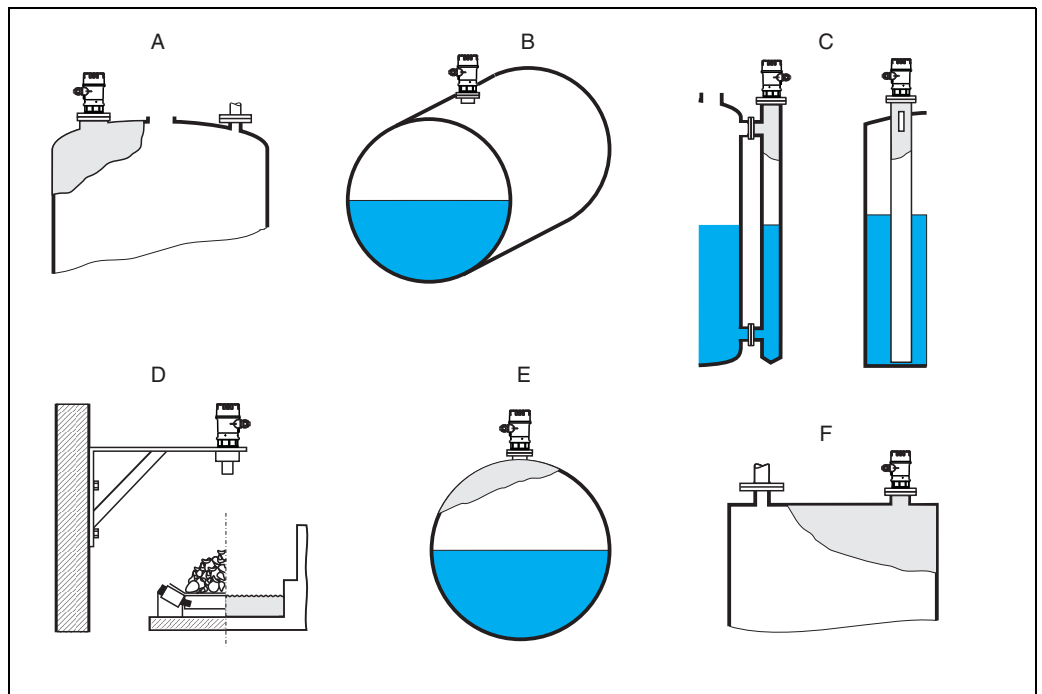

- A dome ceiling
- B horizontal cyl.
- C bypass, stilling well/ultrasonic guide pipe
- D no ceiling, e.g. dumps, open levels, chanel, weirs
- E sphere
- F flat ceiling

### 3.3 Function "medium property" (003)

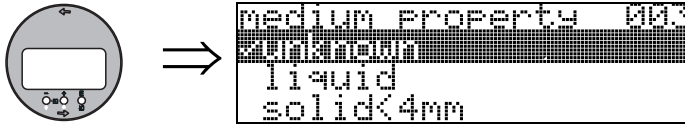

This function is used to set the medium properties:

- **unknown** (e.g. pasty media such as greases, creams, gels etc.)
- liquid
- solid, grain size < 4mm, (fine)
- solid, grain size > 4mm, (coarse)

### 3.4 Function "process cond." (004)

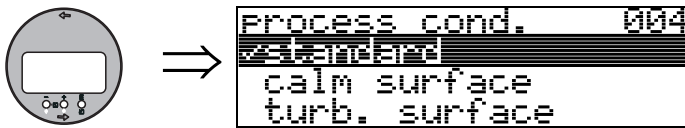

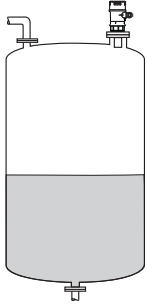
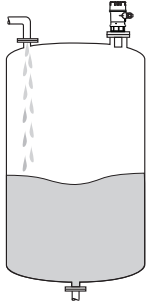

This function is used to select the process conditions.

**Selection:**

standard liquids	calm surface	turb. surface
For all fluid applications which do not fit in any of the following groups.	Storage tanks with immersion tube or bottom filling	Storage / accumulation tanks with uneven surface due to free filling, mixing nozzles or small bottom stirrers
		
The filters and output damping are set to average values.	The averaging filters and output damping are set to large values. -> Stable measured value -> Accurate measurement -> Slow reaction time	Special filters for stabilising the input signal are activated. -> Stable measured value -> Medium reaction time

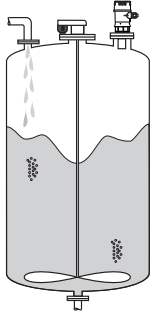
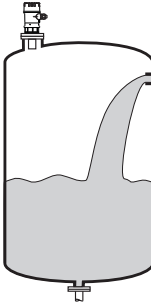
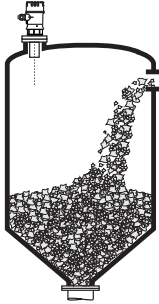

add. agitator	fast change	standard solid
Moving surfaces (poss. with vortex formation) due to agitators	Rapid level change, particularly in small tanks	For all bulk solids applications which do not fit in any of the following groups.
		
Special filters for stabilising the input signal are set to large values. -> Stable measured value -> Medium reaction time	The averaging filters are set to small values. -> Rapid reaction time -> Possibly unstable measured value	The filter and output damping are set to average values.

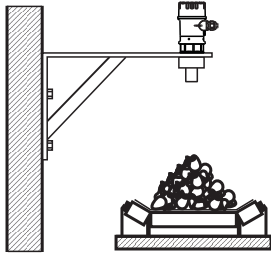
solid dusty	conveyor belt	Test: no filter
Dusty bulk solids	Bulk solids with rapid level change	All the filters can be switched off for purposes of service and diagnosis.
		
The filters are set to detect even relatively weak signals.	The averaging filters are set to small values. -> Rapid reaction time -> Possibly unstable measured value	All filters off

### 3.5 Function "empty calibr." (005)

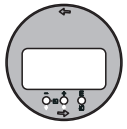

```
empty calibr. 005  
[██████████] m  
distance membrane  
to min. level
```

This function is used to enter the distance from the sensor membrane (reference point of the measurement) to the minimum level (=zero).

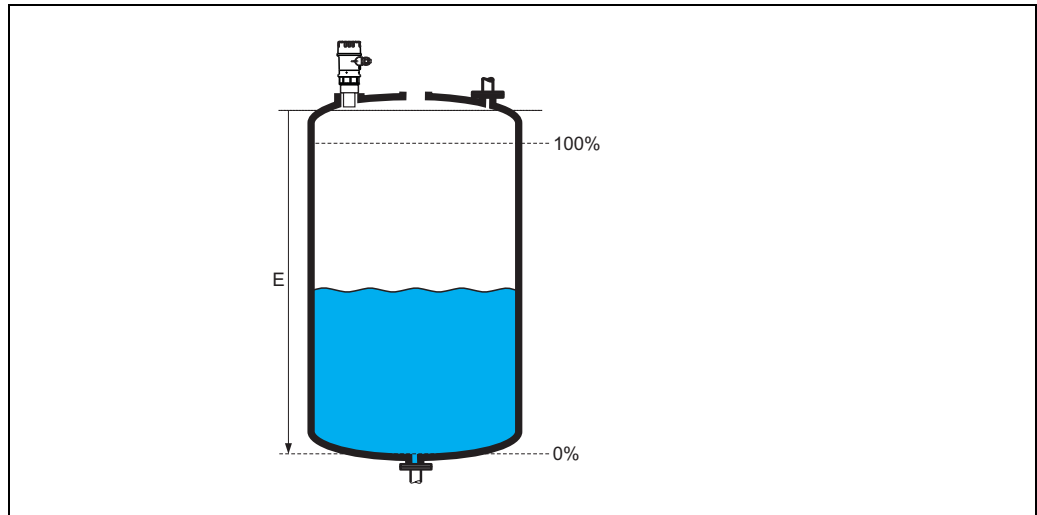

*E: empty calibration*



Caution!

For dish bottoms or conical outlets, the zero point should be no lower than the point at which the radar beam hits the bottom of the tank.

### 3.6 Function "blocking dist." (059)

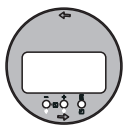

```
blocking dist. 059  
[██████████] m  
BD=blocking dist.
```

In this function the blocking distance is displayed. Level echoes within the blocking distance can not be detected by the Instrument. Make sure that the maximum level will never run into the blocking distance.

### 3.7 Function "full calibr." (006)

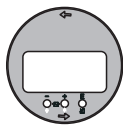

```
full calibr. 006
██████████ 4.750 m
span
max: empty - BD
```

This function is used to enter the distance from the minimum level to the maximum level (=span).

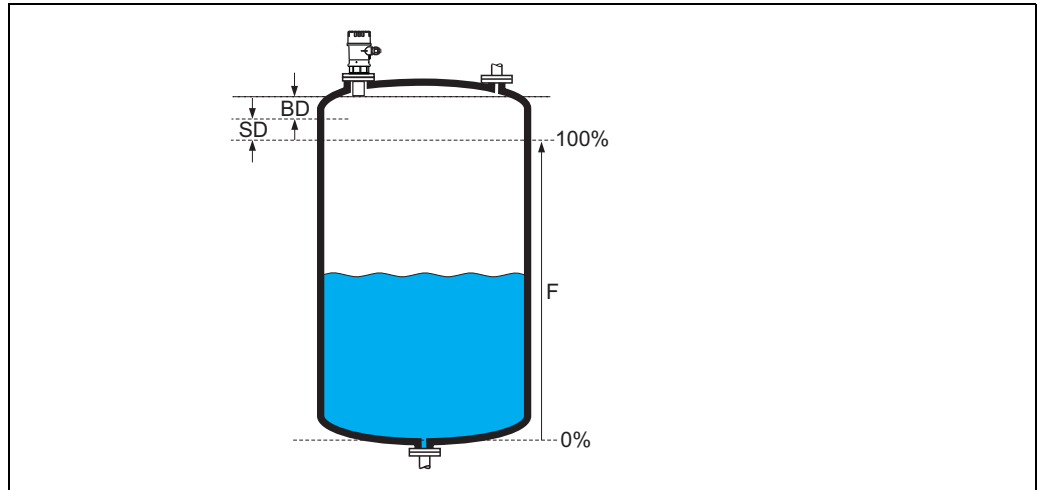

*F: full calibration (span); BD: blocking distance; SD: safety distance*

Caution!

The maximum level may not project into the blocking distance (BD). If the blocking distance is compromised, it may cause device malfunction.

After basic calibration, enter a safety distance (SD) in the "**safety distance**" (015) function. If the level is within this safety distance, the instrument signals a warning or an alarm, depending on your selection in the "**in safety distance**" (016) function.

### 3.8 Display (008)

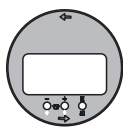

```
dist./meas.value 008
dist. 2.463 m
meas.v. 63.422 %
```

The **distance** measured from the sensor membrane to the product surface and the **level** calculated with the aid of the empty calibration are displayed. Check whether the values correspond to the actual level or the actual distance. The following cases can occur:

- Distance correct – level correct -> continue with the next function, "**check distance**" (051)
- Distance correct – level incorrect -> Check "**empty calibr.**" (005)
- Distance incorrect – level incorrect -> continue with the next function, "**check distance**" (051)

### 3.9 Function "check distance" (051)

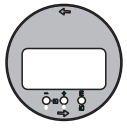

```

check distance 051
dist. unknown
manual
distance = ok
    
```

This function triggers the mapping of interference echoes. To do so, the measured distance must be compared with the actual distance to the product surface. The following options are available for selection:

**Selection:**

- distance = ok
- dist. too small
- dist. too big
- **dist. unknown**
- manual

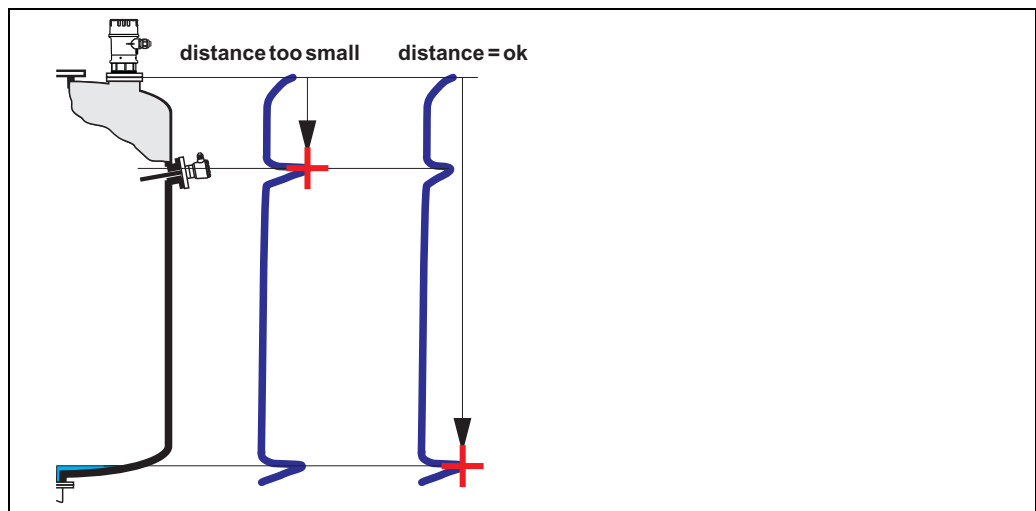

**distance = ok**

- mapping is carried out up to the currently measured echo
- The range to be suppressed is suggested in the "**range of mapping (052)**" function. Anyway, it is wise to carry out a mapping even in this case.

**dist. too small**

- At the moment, an interference is being evaluated
- Therefore, a mapping is carried out including the presently measured echoes
- The range to be suppressed is suggested in the "**range of mapping (052)**" function

**dist. too big**

- This error cannot be remedied by interference echo mapping
- Check the application parameters (002), (003), (004) and "**empty calibr.**" (005)

**dist. unknown**

If the actual distance is not known, no mapping can be carried out.

**manual**

A mapping is also possible by manual entry of the range to be suppressed. This entry is made in the "**range of mapping (052)**" function.



**Caution!**

The range of mapping must end 0.3 m (1 ft) before the echo of the actual level. For an empty tank, do not enter E, but E - 0.3 m.

### 3.10 Function "range of mapping" (052)

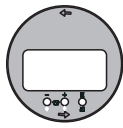

```
range of mapping 052
██████████ 0.000 m
input of
mapping range
```

This function displays the suggested range of mapping. The reference point is always the sensor membrane. This value can be edited by the operator.  
For manual mapping, the default value is: 0 m.

### 3.11 Funktion "start mapping" (053)

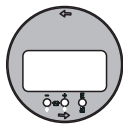

```
start mapping 053
zoff
on
```

This function is used to start the interference echo mapping up to the distance given in "**range of mapping**" (052).

**Selection:**

- **off:** no mapping is carried out
- **on:** mapping is started



**Note!**

If a mapping already exists, it is overwritten up to the distance specified in "**range of mapping**" (052). Beyond this value the existing mapping remains unchanged.

### 3.12 Display (008)

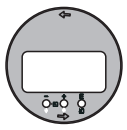

```
dist./meas.value 008
dist.      2.463 m
meas.v.    63.422 %
```

The distance measured from the reference point to the product surface and the level calculated with the aid of the empty alignment are displayed again. Check whether the values correspond to the actual level or the actual distance. The following cases can occur:

- Distance correct – level correct → basic setup completed
- Distance incorrect – level incorrect → a further interference echo mapping must be carried out "**check distance**" (051).
- Distance correct – level incorrect → check "**empty calibr.**" (005)

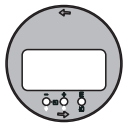

```
Return to
Group Selection
```



After 3 s, the following message appears

```
Group selection 009
basic setup
safety settings
temperature
```



Note!

After the basic setup, an evaluation of the measurement with the aid of the envelope curve ("**display**" (09) function group) is recommended.

## 4 Function group "safety settings" (01)

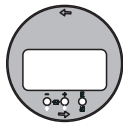

```

Group selection 013
-----
temperature
linearisation
  
```

### 4.1 Function "output on alarm" (010)

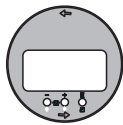

```

output on alarm 010
-----
MIN (<=3.6mA)
✓MAX (22mA)
hold
  
```

This function is used to select the reaction of the device on an alarm.

#### Selection:

- MIN ( $\leq 3.6\text{mA}$ )
- **MAX (22mA)**
- hold
- user specific

#### MIN ( $\leq 3.6\text{ mA}$ )

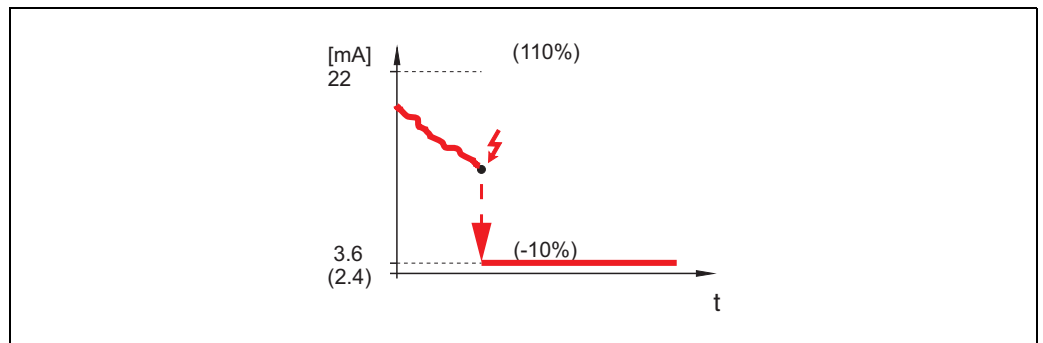

If the instrument is in alarm state, the output changes as follows:

- MIN-Alarm 3.6 mA

#### MAX (22mA)

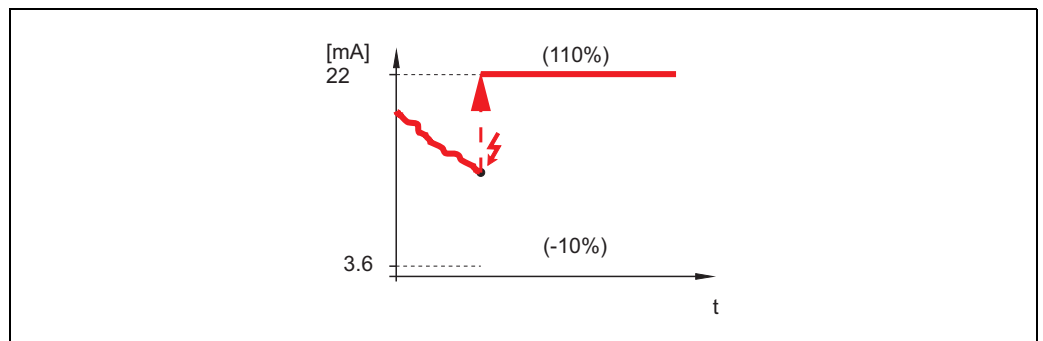

If the instrument is in alarm state, the output changes as follows:

- MAX-Alarm 22 mA

**hold**

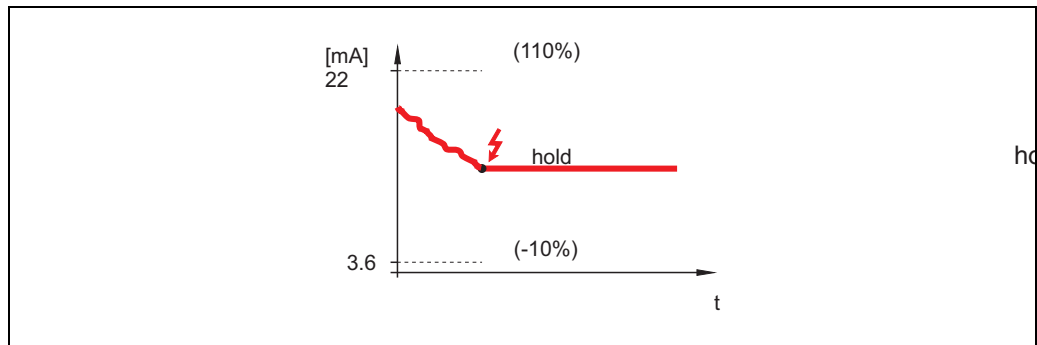

If the instrument is in alarm state, the last measured value is held.

**user specific**

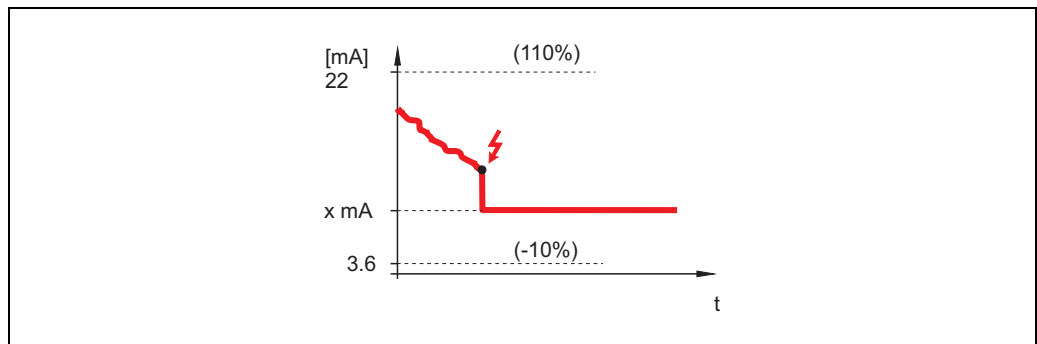

If the instrument is in an alarm state, the output is set to the value configured in "output on alarm" (011) (x mA).

**4.2 Function "output on alarm" (011)**

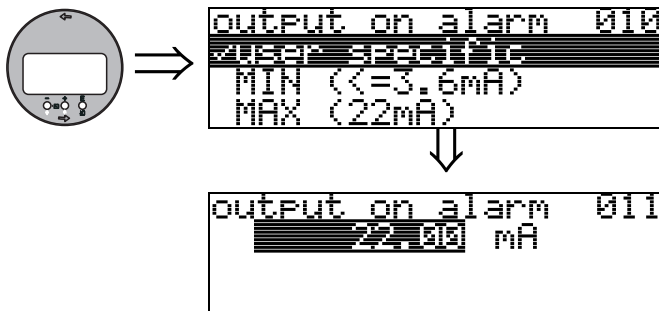

The current (in mA) which will be output in case of an alarm. This function is active when you selected "user specific" in the "output on alarm" (010) function.



### 4.3 Function "outp. echo loss" (012)

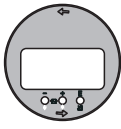

```

outp. echo loss 012
hold
ramp %/min
alarm
  
```

Use this function to set the output response on echo loss.

#### Selection:

- alarm
- hold
- ramp %/min

#### alarm

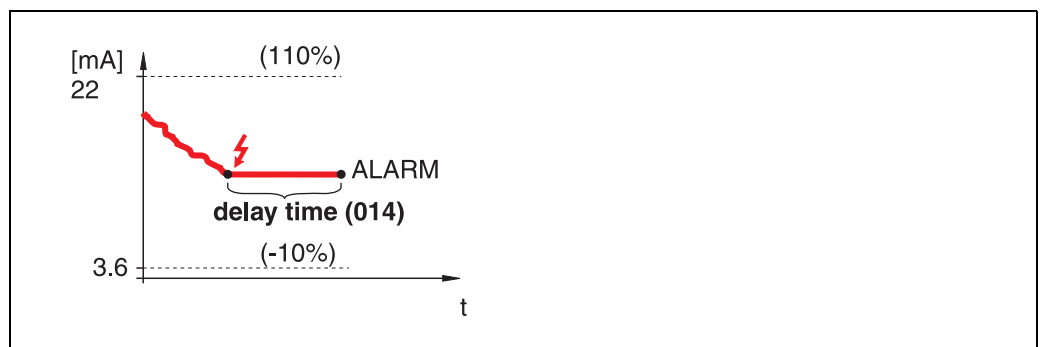

On echo loss, the instrument switches to alarm state after an adjustable "**delay time**" (014). The output response depends on the configuration set in "**output on alarm**" (010).

#### hold

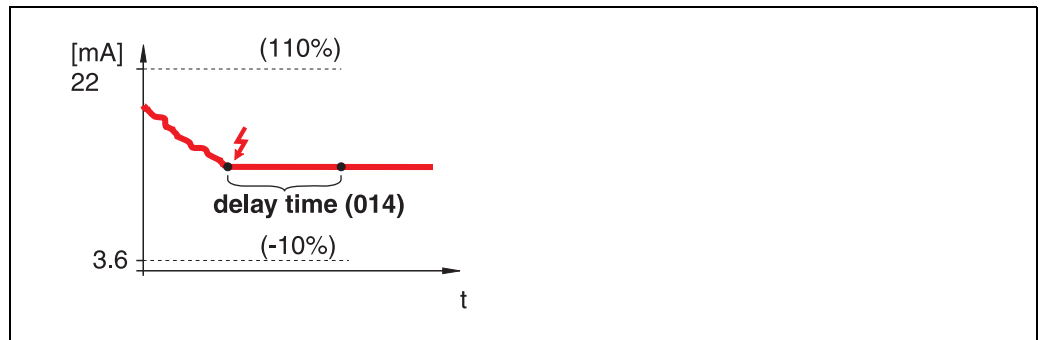

On echo loss, a warning is generated after a definable "**delay time**" (014). Output is held.

ramp %/min

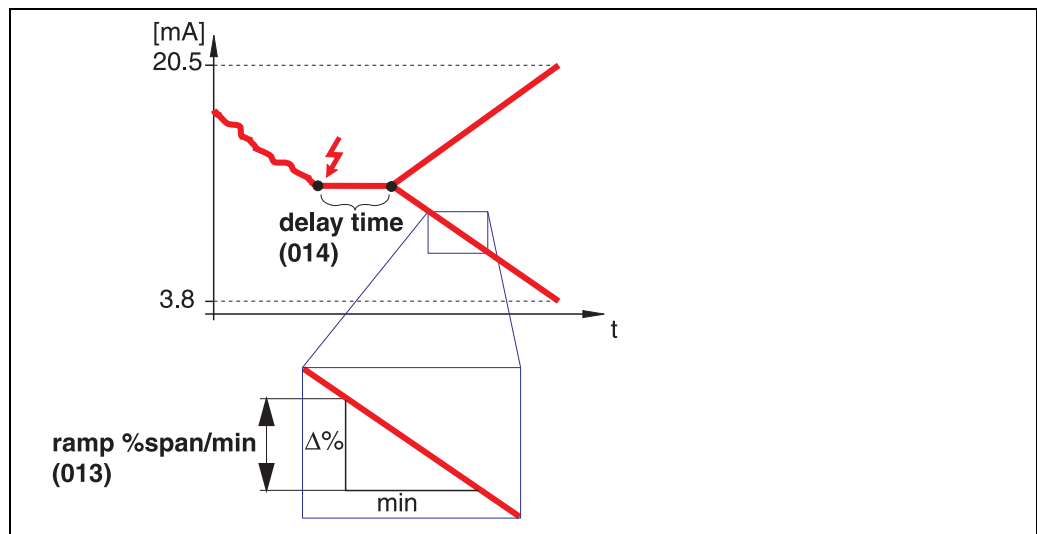

On echo loss, a warning is generated after a definable "delay time" (014). The output is changed towards 0% or 100% depending on the slope defined in "ramp %span/min" (013).

#### 4.4 Function "ramp %span/min" (013)

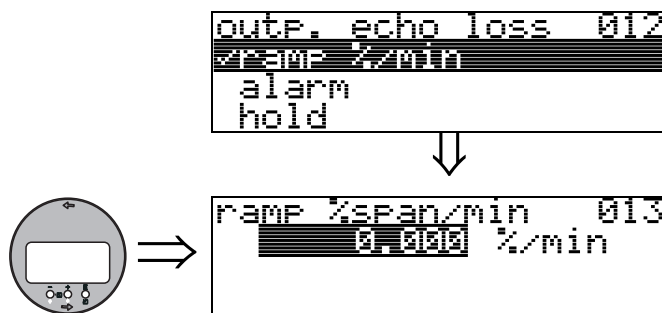

Ramp slope which defines the output value on echo loss. This value is used if "ramp %span/min" is selected in "outp. echo loss" (012). The slope is given in % of the measuring range per minute.

#### 4.5 Function "delay time" (014)



Use this function to enter the delay time (Default = 60 s) after which a warning is generated on echo loss, or after which the instrument switches to alarm state.

## 4.6 Function "safety distance" (015)

A configurable safety distance is placed before the "**blocking dist.**" (059) (→ 45). This distance warns you that any further level increase would make the measurement invalid, because the blocking distance would be compromised.

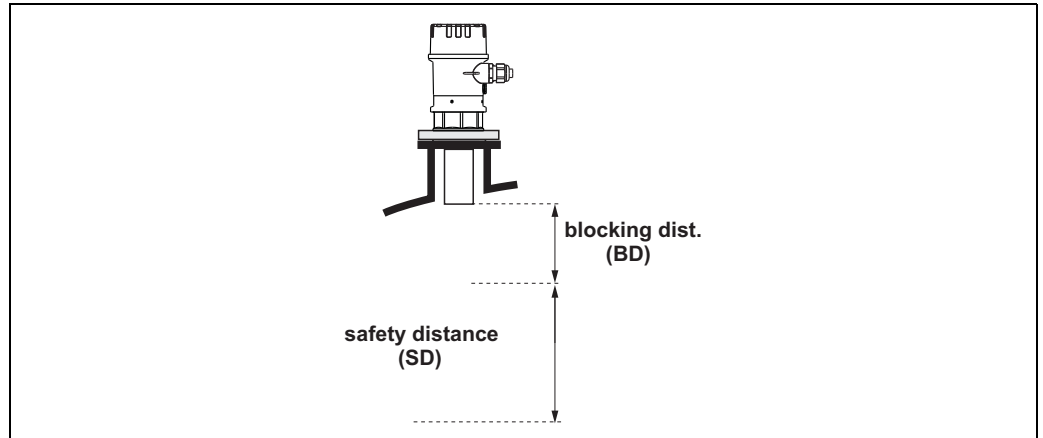

Enter the size of the safety distance here. The default value is: 0.1 m (0.32 ft).

## 4.7 Function "in safety dist." (016)



This function defines the response when the level enters the safety distance .

### Selection:

- alarm
- **warning**
- self holding

### alarm

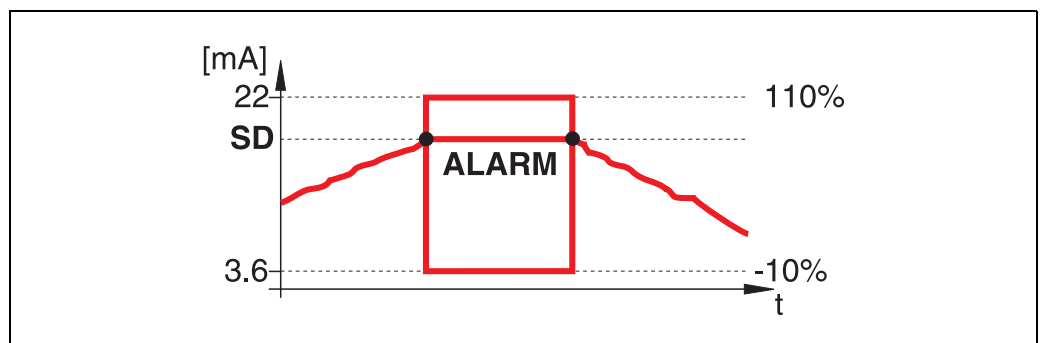

Instrument enters the defined alarm state ("**output on alarm**" (011)). The alarm message **E651** - "**level in safety distance - risk of overspill**" is displayed.

If the level drops out of the safety distance, the alarm warning disappears and the instrument starts to measure again.

**warning**

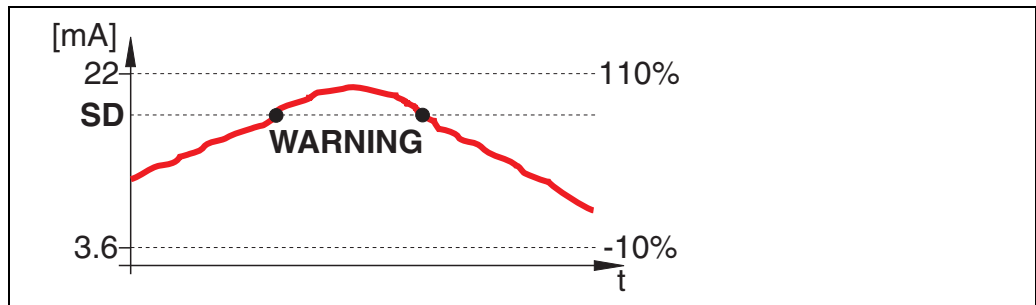

Instrument displays a warning **E651** - "level in safety distance - risk of overspill", but continues to measure. If the level leaves the safety distance, the warning disappears.

**self holding**

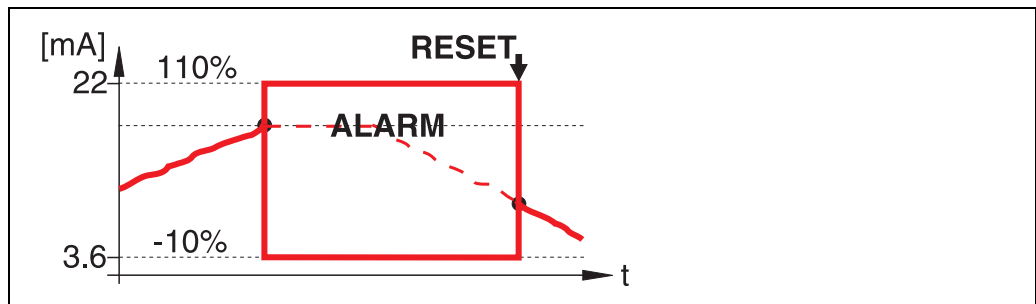

Instrument switches to defined alarm state ("output on alarm" (011)). The alarm message **E651** - "level in safety distance - risk of overspill" is displayed. If the level leaves the safety distance, the measurement continues only after a reset of the self holding (function: "ackn. alarm" (017)).

## 4.8 Function "ackn. alarm" (017)



This function acknowledges an alarm in case of **"self holding"**.

### Selection:

- no
- yes

### no

The alarm is not acknowledged.

### yes

Acknowledgement takes place.



After 3 s, the following message appears



## 5 Function group "temperature" (03)

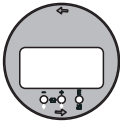

```
Group selection 033  
temperature  
linearisation  
extended calibr.
```

### 5.1 Function "measured temp." (030)

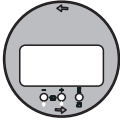

```
measured temp. 030  
72.9 F
```

In this function the temperature at the sensor is displayed. The temperature unit is determined by the function "temperature unit" (0C6).

### 5.2 Function "max. temp. limit" (031)

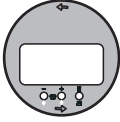

```
max. temp. limit 031  
140.0 F
```

In this function the maximum permitted temperature of the sensor is displayed. The temperature unit is determined by the function "temperature unit" (0C6). If this temperature is exceeded, the sensor may become damaged.

### 5.3 Function "max. meas. temp." (032)

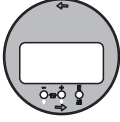

```
max. meas. temp 032  
76.2 F
```

In this function the maximum temperature, which has ever been measured at the sensor, is displayed. The temperature unit is determined by the function "temperature unit" (0C6). This function is not influenced by a reset of the parameters.

## 5.4 Function "react high temp." (033)

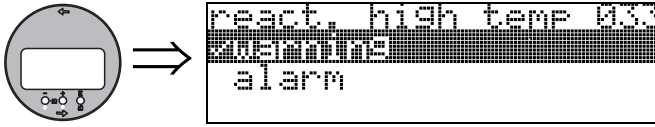

In this function you determine, how the instrument will react if the maximum permitted temperature of the sensor is exceeded.

You may choose one of the following options:

### **Warning**

The instrument continues measuring. An error message is displayed.

### **Alarm**

The current output adopts the value defined in the function "**output on alarm**" (010). Additionally an error message is displayed.

## 5.5 Function "defect temp. sens." (034)



In this function you determine, how the instrument will react, if the maximum permitted temperature of the sensor is exceeded.

You may choose one of the following options:

### **Alarm**

The current output adopts the value defined in the function "**output on alarm**" (010). Additionally an error message is displayed.

### **Warning**

The instrument continues measuring. An error message is displayed.



## 6 Function group "linearisation" (04)

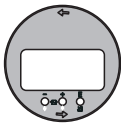

```

Group selection 04→
/linearisation
extended calibr.
output
  
```

### 6.1 Function "level/ullage" (040)

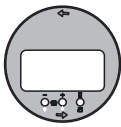

```

level/ullage 040
/level CU
level DU
ullage CU
  
```

#### Selection:

- level CU
- level DU
- ullage CU
- ullage DU

#### level CU

Level in customer units. The measured value can be linearised.  
The "**linearisation**" (041) default value is set to a linear 0...100%.

#### level DU

Level in the selected "**distance unit**" (0C5).

#### ullage CU

Ullage in customer units. The value can be linearised.  
The "**linearisation**" (041) default value is set to a linear 0...100%.

#### ullage DU

Ullage in the selected "**distance unit**" (0C5).



#### Note!

Reference point for the ullage is "full calibr." (=span).

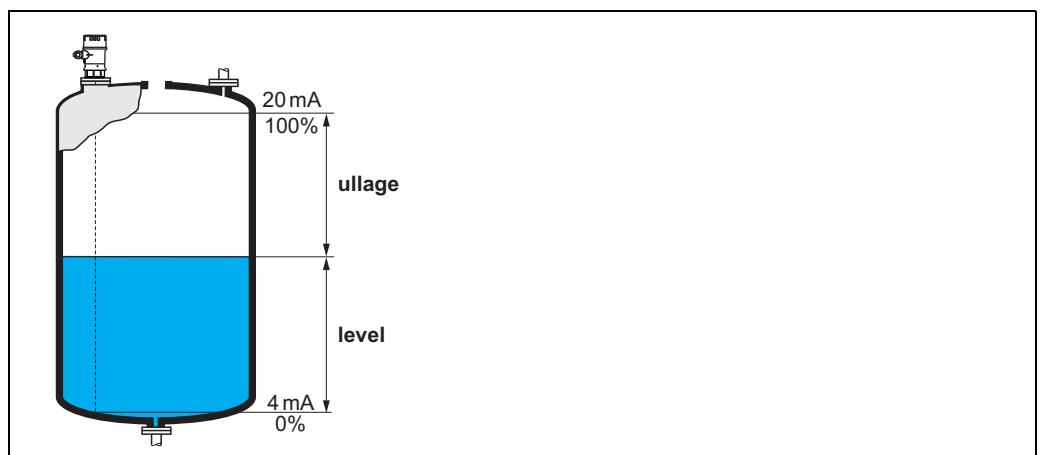

## 6.2 Function "linearisation" (041)

Linearisation defines the ratio of level to container volume or product weight and allows a measurement in customer units, e.g. metres, hectolitres etc. The measured value in (000) is then displayed in the selected unit.



This function is used to select the linearisation modes.

### Selection:

- linear
- horizontal cyl
- manual
- semi-automatic
- table on
- clear table

### linear

The tank is linear e.g. a cylindrical vertical tank. You can measure in customer units by entering a maximum volume/weight.

You can select the "**customer unit**" (042). Define the volume value corresponding to the calibration in "**max. scale**" (046). This value corresponds to an output of 100% (= 20 mA).

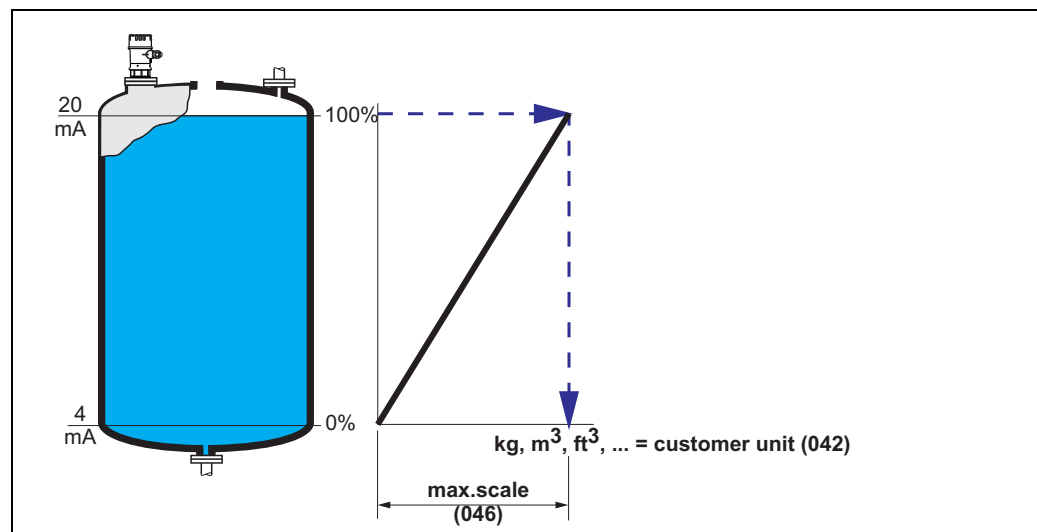

**horizontal cyl**

The volume, mass etc. are calculated automatically in cylindrical horizontal tanks by entering the "diameter vessel" (047), the "customer unit" (042) and the "max. scale" (046). The "max. scale" (046) corresponds to an output of 100% (= 20 mA).

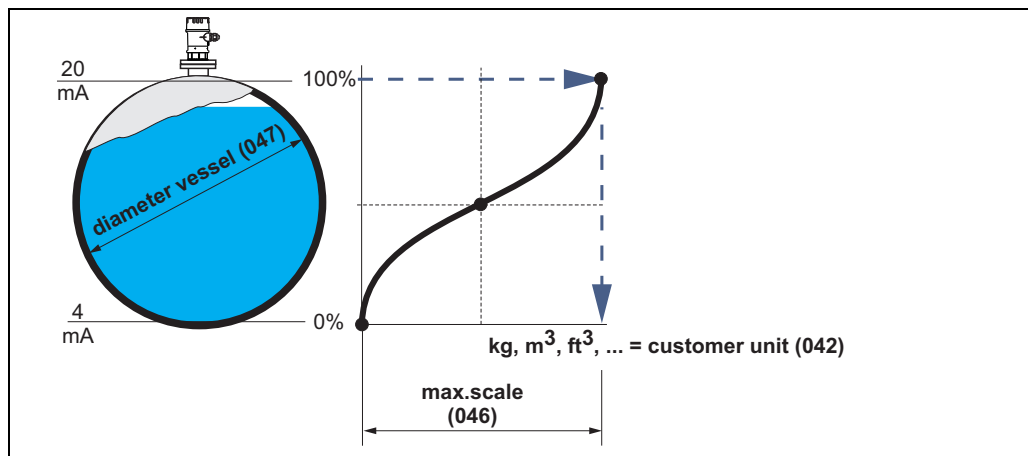
**manual**

If the level is not proportional to the volume or weight within the set measuring range, you can enter a linearisation table in order to measure in customer units. The requirements are as follows:

- The 32 (max.) value pairs for the linearisation curve points are known.
- The level values must be given in ascending order. The curve is monotonously increasing.
- The level heights for the first and last points on the linearisation curve correspond to empty and full calibration respectively.
- The linearisation takes place in the basic setup unit ("distance unit" (0C5)).

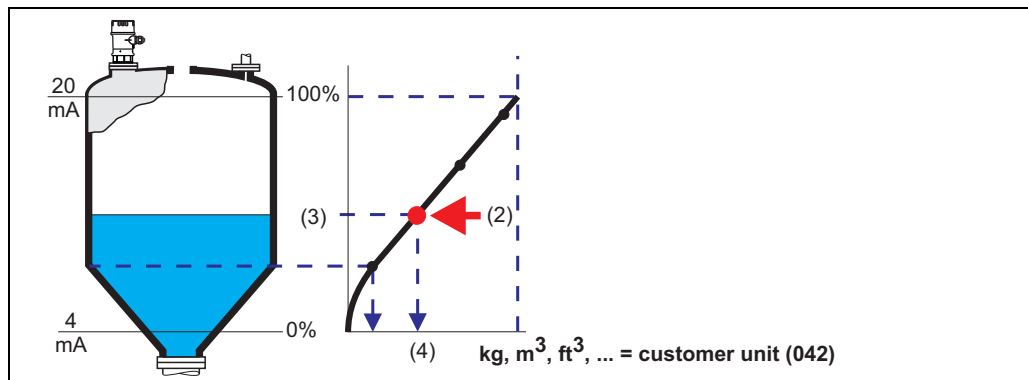

Each point (2) in the table is described by a value pair: level (3) and, for example, volume (4). The last value pair defines the 100% output (= 20 mA).

**Note!**

The manual linearisation mode can also be used for flow measurements. To do this, simply enter the respective flow level (instead of the volume) into the table. You can find the appropriate flow values in the Q/h table of your channel or weir.

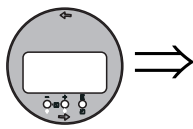

```

linearisation 041
manual
semi-automatic
table on
    
```

```

linearisation 043
Tab.no. 1
Level 0.000m
Volume 0.000%
    
```

Select the table point (Point 1).

```

linearisation 044
Tab.no. 1
Level 0.000m
Volume 0.000%
    
```

Enter the level belonging to Point 1.

```

linearisation 045
Tab.no. 1
Level 0.000m
Volume 0.000%
    
```

Enter the corresponding volume.

```

next point 045
yes
no
    
```

Enter a further table point?

```

linearisation 043
Tab.no. 2
Level 0.000m
Volume 0.000%
    
```

Next table point.

Continue until "next point" (045) is answered with no.



Note!

- After making entries into the table, activate it with "table on".  
The 100% value (=20 mA) is defined by the last point in the table.
- Before confirming 0.00 m as the level or 0.00% as the volume, activate the Edit mode with + or -.

Entries can be made into the linearisation table in FieldCare using the table editor.  
You can also display the contents graphically.

**semi-automatic**

The tank is filled in stages when the linearisation curve is entered semi-automatically. The instrument automatically detects the level and the corresponding volume/weight has to be entered. The procedure is similar to manual table entry, where the level value for each table point is given automatically by the instrument.



Note!

If the tank is emptied (out litres), pay attention to the following points:

- The number of points must be known in advance.
- The first table number = (32 - number of points).
- Entries in "**Tab. no.**" (**043**) are made in reverse order (last entry = 1).

**table on**

An entered linearisation table only becomes effective when activated.

**clear table**

Before making entries into the linearisation table, any existing tables must be deleted. The linearisation mode automatically switches to linear.



Note!

A linearisation table can be deactivated by selecting "**linear**" or "**horizontal cyl**" (or the "**level/ullage**" (**040**) function = "**level DU**", "**ullage DU**"). It is not deleted and can be reactivated at any time by selecting "**table on**".

### 6.3 Function "customer unit" (042)

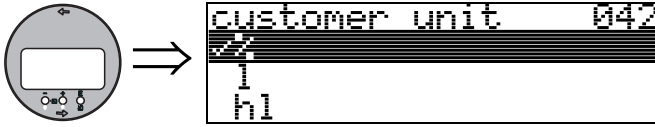

You can select the customer unit with this function.

**Selection:**

- %
- Volume: l, hl, m3, dm3, cm3, ft3, usgal, i gal
- Weight: kg, t, lb, ton
- Length: m, ft, mm, inch
- Flow: l/s, l/min, l/h, m3/s, m3/min, m3/h, ft3/s, gal/s, gal/m, gal/hr, mgal/d, igal/s, igal/min, igal/h

**Dependence**

The units of the following parameters are changed:

- measured value (000)
- input volume (045)
- max. scale (046)
- simulation value (066)

## 6.4 Function "table no." (043)

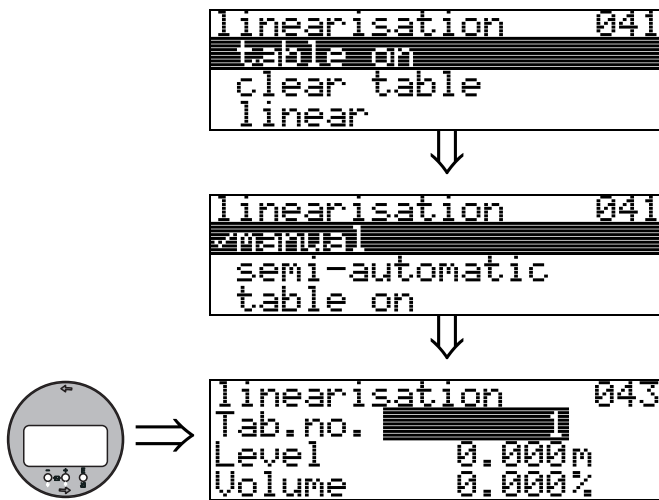

Position of the value pair in the linearisation table.

### Dependence

Updates "input level" (044) , "input volume" (045).

## 6.5 Function "input level" (044)

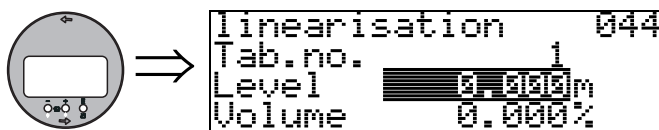

You can enter the level for each point of the linearisation curve with this function. When the linearisation curve is entered semi-automatically, the instrument detects the level automatically.

### User input:

Level in "distance unit" (0C5).

## 6.6 Function "input volume" (045)

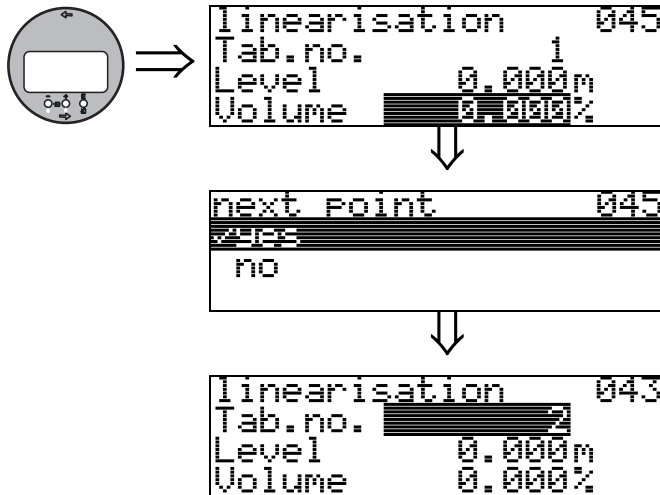

Specify the volume for each point of the linearisation curve with this function.

### User input:

Volume in "customer unit" (042).

## 6.7 Function "max. scale" (046)



You can enter the end value of the measuring range with this function. This input is necessary if you selected "linear" or "horizontal cyl" in the "linearisation" (041) function.

## 6.8 Function "diameter vessel" (047)

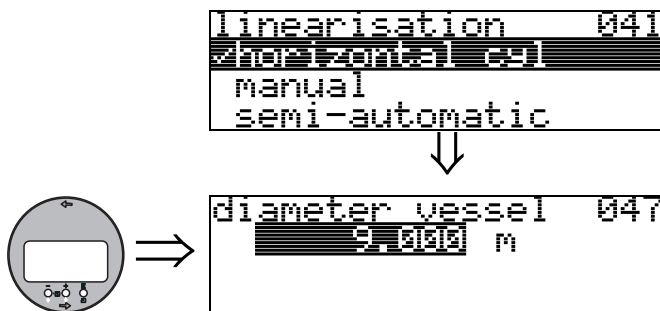

Enter the tank diameter with this function. This entry is necessary if you selected "horizontal cyl" in the "linearisation" (041) function.



## 7 Function group "extended calibr." (05)



### 7.1 Function "selection" (050)



Select the function of the extended calibration.

#### Selection:

- **common**  
leads to the functions "echo quality" (056), "offset" (057), "output damping" (058) and "blocking distance" (059)
- **mapping**  
leads to the functions for an interference echo suppression (tank map): (051) ... (053)
- **extended map**  
leads to the functions "pres. map. dist." (054) and "cust. tank map" (055)

### 7.2 Function "check distance" (051)

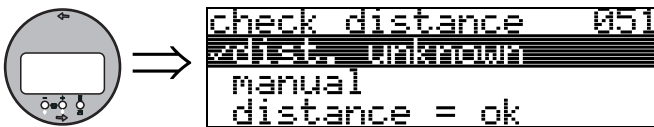

This function triggers the mapping of interference echoes. To do so, the measured distance must be compared with the actual distance to the product surface. The following options are available for selection:

#### Selection:

- distance = ok
- dist. too small
- dist. too big
- **dist. unknown**
- manual

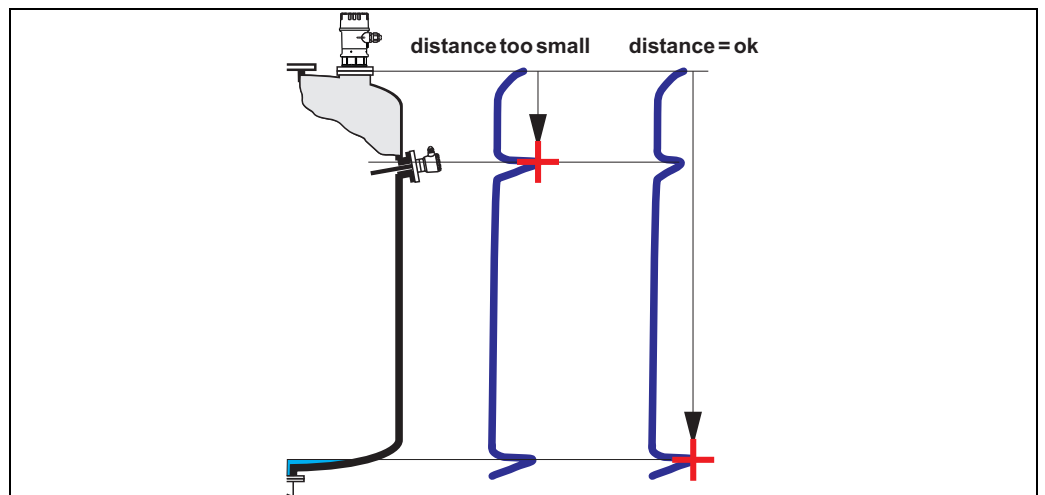

**distance = ok**

- mapping is carried out up to the currently measured echo
  - The range to be suppressed is suggested in the "**range of mapping (052)**" function
- Anyway, it is wise to carry out a mapping even in this case.

**dist. too small**

- At the moment, an interference is being evaluated
- Therefore, a mapping is carried out including the presently measured echoes
- The range to be suppressed is suggested in the "**range of mapping (052)**" function

**dist. too big**

- This error cannot be remedied by interference echo mapping
- Check the application parameters (002), (003), (004) and "**empty calibr.**" (005)

**dist. unknown**

If the actual distance is not known, no mapping can be carried out.

**manual**

A mapping is also possible by manual entry of the range to be suppressed. This entry is made in the "**range of mapping (052)**" function.



**Caution!**

The range of mapping must end 0.3 m (1 ft) before the echo of the actual level. For an empty tank, do not enter E, but E – 0.3 m.

### 7.3 Function "range of mapping" (052)

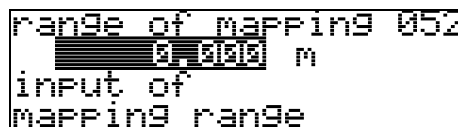
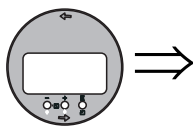

This function displays the suggested range of mapping. The reference point is always the sensor membrane. This value can be edited by the operator. For manual mapping, the default value is: 0 m.

### 7.4 Function "start mapping" (053)

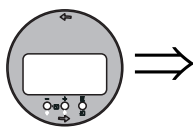

This function is used to start the interference echo mapping up to the distance given in "**range of mapping**" (052).

**Selection:**

- **off:** no mapping is carried out
- **on:** mapping is started



**Caution!**

If a mapping already exists, it is overwritten up to the distance specified in "**range of mapping**" (052). Beyond this value the existing mapping remains unchanged.

## 7.5 Function "pres. map dist." (054)

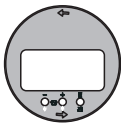

```
Pres. map dist. 054  
0.000 m
```

Displays the distance up to which a mapping has been recorded.  
A value of 0 indicates that no mapping was recorded so far.

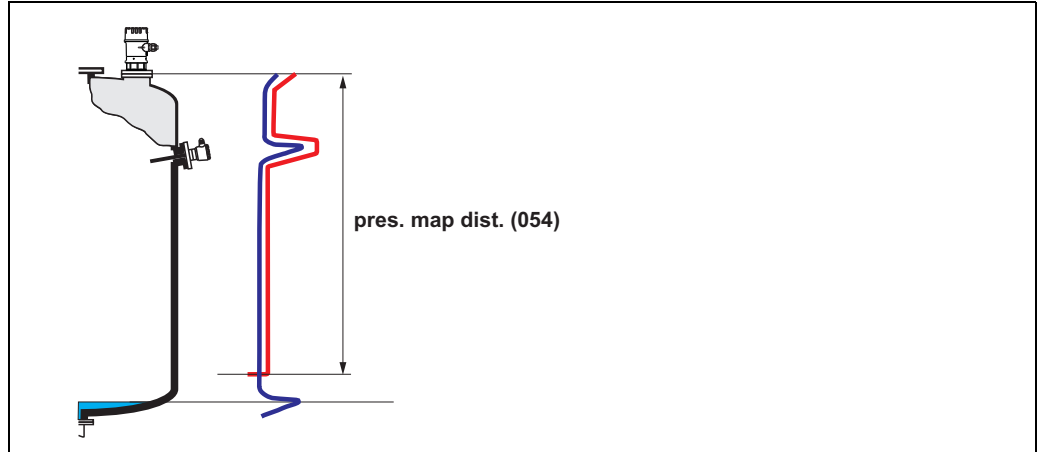

## 7.6 Function "cust. tank map" (055)

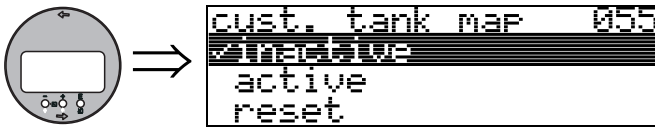

This function displays the evaluation mode using the customer tank map.

### Selection:

- inactive
- active
- reset

### inactive

No tank mapping has been recorded, or map is switched off. Evaluation is only using FAC (→ 73).

### active

Evaluation is using the customer tank map (→ 72).

### reset

Deletes the complete tank map.

## 7.7 Function "echo quality" (056)

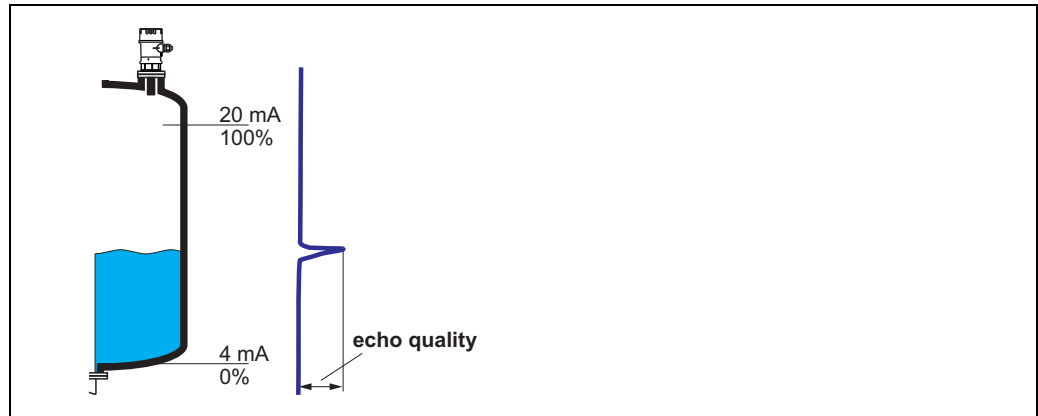
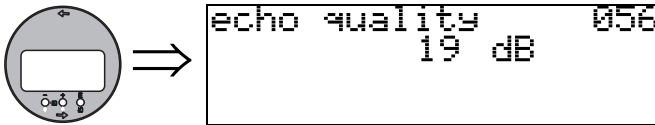

The echo quality is the benchmark for measurement reliability. It describes the amount of reflected energy and depends primarily on the following conditions:

- Surface characteristics (waves, foam etc.)
- Distance between sensor and product

Low values increase the probability that the echo is lost through a change in measurement conditions, e.g. turbulent surface, foam, large measuring distance.

## 7.8 Function "offset" (057)

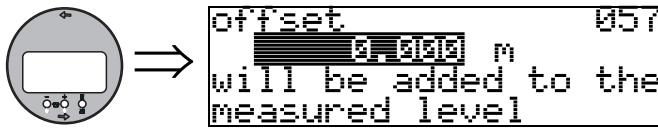

This function corrects the measured level by a constant value. The entered value is added to the measured level.

## 7.9 Function "output damping" (058)



Influences the time an output requires to react to a sudden level jump (63% of steady state). A high value attenuates, for example, the influences of rapid changes on the measured variable.

### User input:

0...255 s

The default value depends on the selected application parameters "**tank shape**" (002), "**medium property**" (003) and "**process cond.**" (004).

## 7.10 Function "blocking dist." (059)



In this function the blocking distance is displayed. Level echoes within the blocking distance can not be detected by the instrument. Make sure that the maximum level will never run into the blocking distance.

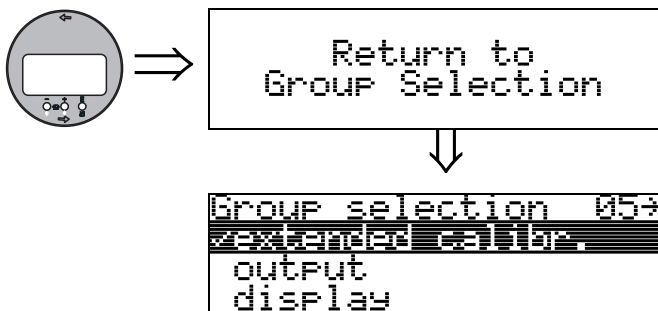

After 3 s, the following message appears



## 8 Function group "output" (06)

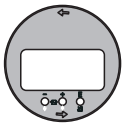

```
Group selection 06
<output
display
diagnostics
```

### 8.1 Function "thres. main val." (062)

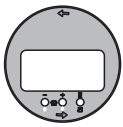

```
low output limit 062
<on
off
```

The output of negative level values can be suppressed with this function.

#### Selection:

- **off**: minimum output -10% (3.8 mA)
- **on**: minimum output 0% (4 mA)

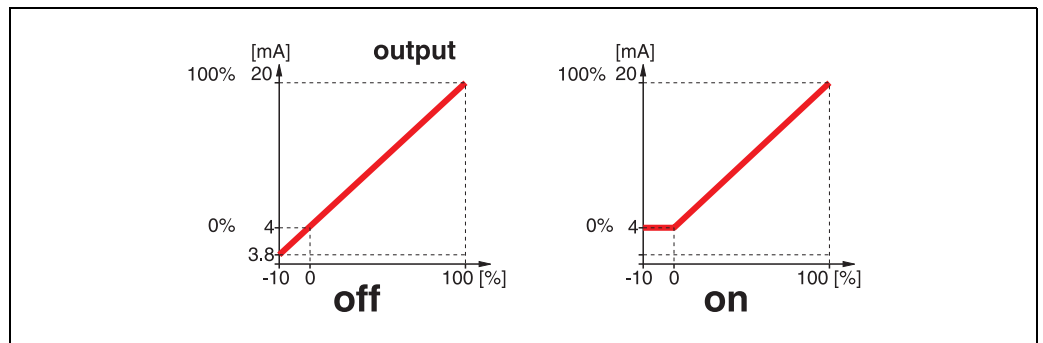

### 8.2 Function "curr. output mode" (063)

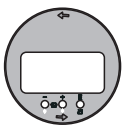

```
curr. output mode 063
<standard
curr. turn down
fixed current
```

In this function you specify the mode of the current output.  
You may choose one of the following options:

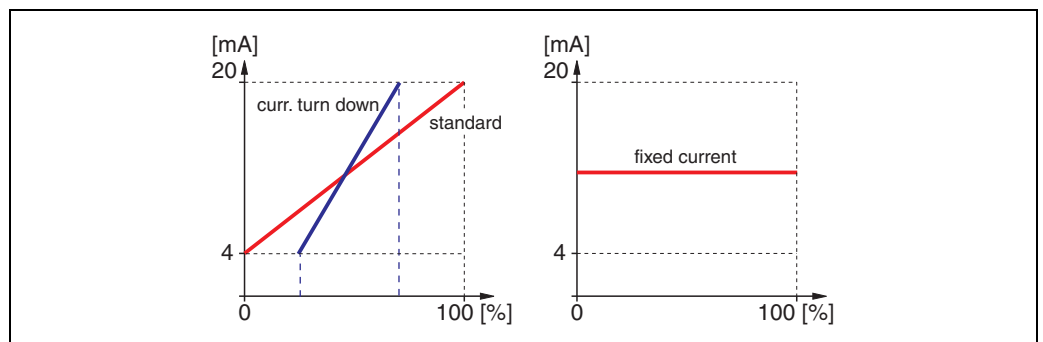

**standard**

The total measuring range (0 ... 100%) will be mapped to the current intervall (4 ... 20 mA).

**curr. turn down**

Only a part of the measuring range will be mapped to the current intervall (4 ... 20 mA).

Use the functions "**4-mA-value**" (068) and "**20-mA-value**" (069) to define the concerning range.

**fixed current**

The current is fixed. The value of the current is defined in the "**fixed current**" (064) function.

### 8.3 Function "fixed cur. value" (064)



Set the fixed current value with this function. This entry is necessary when you have switched on the "**fixed current**" (063) function.

**User input:**

3,8...20,5 mA



## 8.4 Function "simulation" (065)



If necessary, linearisation, the output signal and the current output can be tested with the simulation function. You have the following simulation options:

### Selection:

- **sim. off**
- sim. level
- sim. volume
- sim. current

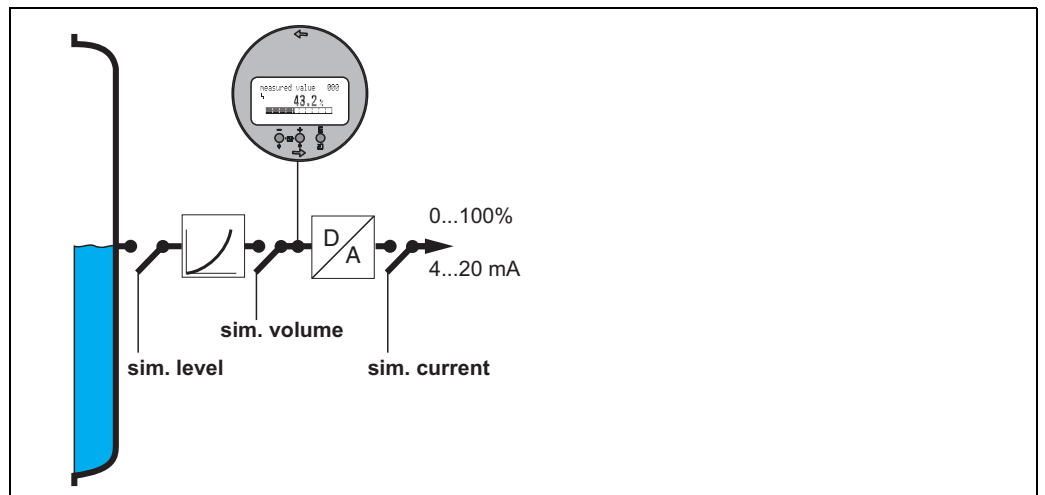

### **sim. off**

Simulation is switched off.

### **sim. level**

Enter the level value in "**simulation value**" (066).

The functions

- measured value (000)
- measured level (0A6)
- output current" (067)

follow the entered values.

### **sim. volume**

Enter the volume value in "**simulation value**" (066).

The functions

- measured value (000)
- output current" (067)

follow the entered values.

### **sim. current**

Enter the current value in "**simulation value**" (066).

The function

- output current" (067)

follows the entered values.

### 8.5 Function "simulation value" (066)

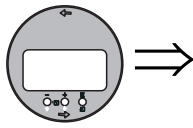

```
simulation value 066
2.54 m
```

After selecting the **"sim. level"** option in the **"simulation" (065)** function, the following message appears in the display: you can enter the level.

```
simulation value 066
28.16 %
```

After selecting the **"sim. volume"** option in the **"simulation" (065)** function, the following message appears in the display: you can enter the volume.

```
simulation value 066
8.00 mA
```

After selecting the **"sim. current"** option in the **"simulation" (065)** function, the following message appears in the display: Enter the output current.

### 8.6 Function "output current" (067)

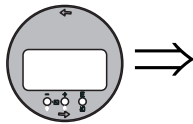

```
output current 067
4.00 mA
```

Displays the output current in mA.

### 8.7 Function "4mA-value" (068)

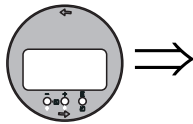

```
4mA value 068
10.00 %
```

In this function specify the level (or volume, weight, flow resp.), at which the output current should be 4 mA. This value will be used if you choose the option "curr. turn down" in the **"current output mode" (063)** function.

### 8.8 Function "20mA-value" (069)

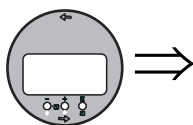

```
20mA value 069
20.00 %
```

In this function specify the level (or volume, weight, flow resp.), at which the output current should be 20 mA. This value will be used if you choose the option "curr. turn down" in the **"current output mode" (063)** function.

## 9 Function group "Envelope curve" (0E)

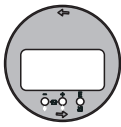

```
Group selection 0E2
/envelope curve
display
diagnostics
```

### 9.1 Function "plot settings" (0E1)

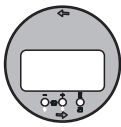

```
Plot settings 0E1
/envelope curve
env.curve+FAC
env.curve+cust.map
```

Here select which information is displayed in the LCD:

- **envelope curve**
- env.curve+FAC (on FAC see → [73](#))
- env.curve+cust.map (i.e. customer tank map is also displayed, see → [72](#))

### 9.2 Function "recording curve" (0E2)

This function defines whether the envelope curve is read as a

- **single curve**
- or
- cyclic.

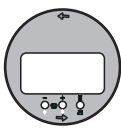

```
recording curve 0E2
/single curve
cyclic
```



Note!

If the cyclical envelope curve is active in the display, the measured variable is refreshed in a slower cycle time. It is therefore recommended to exit the envelope curve display after optimising the measuring point.

### 9.3 Function "envelope curve display" (0E3)

The envelope curve is displayed in this function. You can use it to obtain the following information:

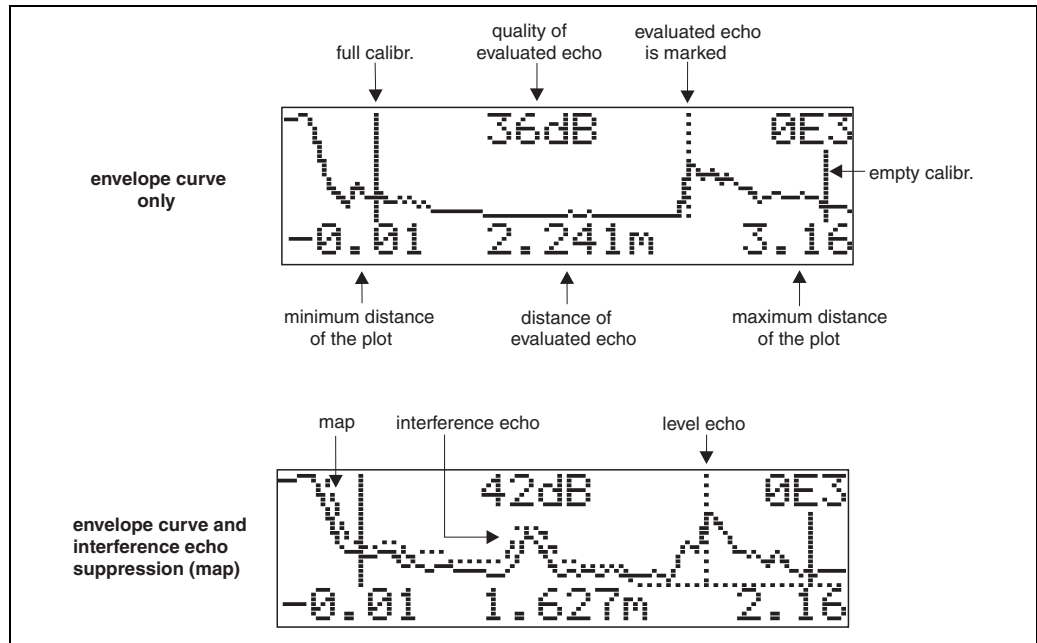

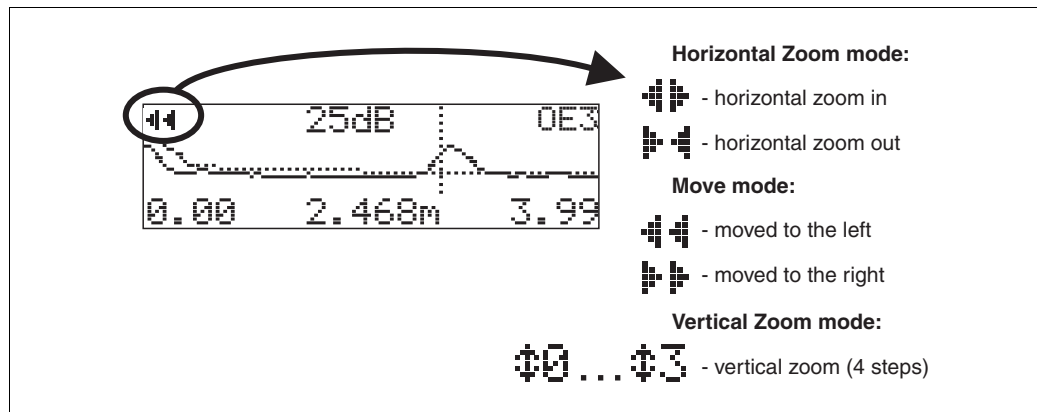

#### Navigating in the envelope curve display

Using navigation, the envelope curve can be scaled horizontally and vertically and shifted to the left or the right. The active navigation mode is indicated by a symbol in the top left hand corner of the display.





**Horizontal Zoom mode**

Firstly, go into the envelope curve display (see → 33). Then press + or - to switch to the envelope curve navigation. You are then in Horizontal Zoom mode. Either  or  is displayed.

You now have the following options:

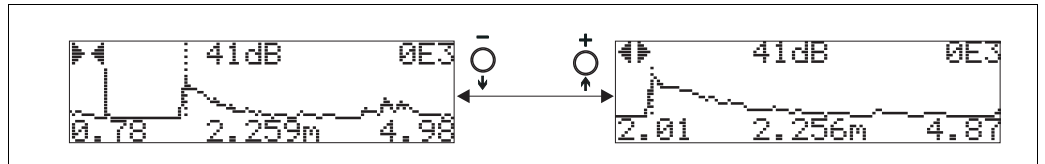
- + increases the horizontal scale.
- - reduces the horizontal scale.

**Move mode**

Then press E to switch to Move mode. Either  or  is displayed.

You now have the following options:

- + shifts the curve to the right.
- - shifts the curve to the left.

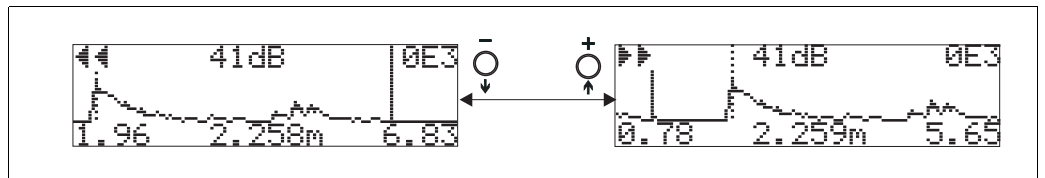
**Vertical Zoom mode**

Press E once more to switch to Vertical Zoom mode. 1 is displayed.

You now have the following options:

- + increases the vertical scale.
- - reduces the vertical scale.

The display icon shows the current zoom factor (0 to 3).

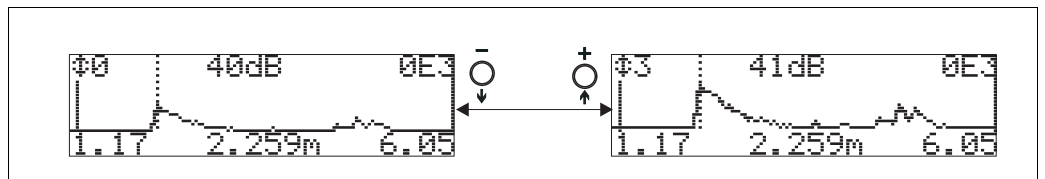
**Exiting the navigation**

- Press E again to run through the different modes of the envelope curve navigation.
- Press + and - to exit the navigation. The set increases and shifts are retained. Only when you reactivate the "recording curve" (OE2) function does the instrument use the standard display again.



## 10 Function group "display" (09)

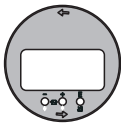

```

Group selection 09*
display
diagnostics
system parameters
  
```

### 10.1 Function "language" (092)

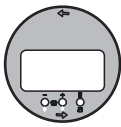

```

language 092
English
Deutsch
Français
  
```

Selects the display language.

#### Selection:

- English
- Deutsch
- Français
- Español
- Italiano
- Nederlands
- Japanese

#### Dependence

All texts are changed.

### 10.2 Function "back to home" (093)

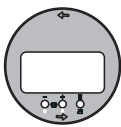

```

back to home 093
9999 s
  
```

If no entry is made using the display during the specified time period, the display returns to the measured value display.

9999 s means that there is no return.

#### User input:

3...9999 s



Caution!

This function is not visualised in FieldCare!

### 10.3 Function "format display" (094)



Selects the display format.

**Selection:**

- decimal
- 1/16"

**decimal**

The measured value is given in decimal form in the display (e.g. 10.70%).

**1/16"**

The measured value is given in the display in this format (e.g. 5'05-14/16").  
This option is only possible for "**distance unit**" (0C5) - "ft" and "in"!

### 10.4 Function "no.of decimals" (095)



**Selection:**

- x
- x.x
- x.xx
- x.xxx

### 10.5 Function "sep. character" (096)



**Selection:**

- .
- ,

. The decimal place is separated by a point.  
, The decimal place is separated by a comma.

### 10.6 Function "display test" (097)



All display pixels are switched on. If the whole LCD is dark, it is working correctly.



## 11 Function group "diagnostics" (0A)

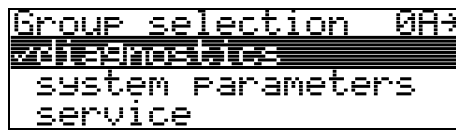
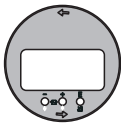

In the "**diagnostics**" function group, you can display and confirm error messages.

### Type of error

Errors that occur during commissioning or measuring are displayed immediately on the local display. If two or more system or process errors occur, the error with the highest priority is the one shown on the display.

The measuring system distinguishes between two types of error:

- **A (Alarm):**

Instrument goes into a defined state (e.g. MAX)

Indicated by a constant  symbol.

(For a description of the codes, →  76)

- **W (Warning):**

Instrument continue measuring, error message is displayed.

Indicated by a flashing  symbol.

(For a description of the codes, →  76)

- **E (Alarm / Warning):**

Configurable (e.g. loss of echo, level within the safety distance)

Indicated by a constant/flashing  symbol.

(For a description of the codes, →  76)

### 11.1 Function "present error" (0A0)



The present error is shown using this function.

### 11.2 Function "previous error" (0A1)



The last error presented is shown with this function.

### 11.3 Function "clear last error" (0A2)



**Selection:**

- keep
- erase



**Caution!**

This function can be performed on the display only!

## 11.4 Function "reset" (0A3)



### Caution!

A reset sets the instrument back to the factory settings. This can lead to an impairment of the measurement. Generally, you should perform a basic setup again following a reset.

A reset is only necessary:

- if the instrument no longer functions
- if the instrument must be moved from one measuring point to another
- if the instrument is being de-installed /put into storage/installed

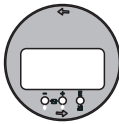

```

reset                                0A3
██████████
for reset code
see manual
  
```

### Entry ("reset" (0A3)):

- 333 = customer parameters

### 333 = reset customer parameters

This reset is recommended whenever an instrument with an unknown 'history' is to be used in an application:

- The Micropilot is reset to the default values.
- The customer specific tank map is not deleted.
- A linearisation is switched to "**linear**" although the table values are retained. The table can be reactivated in the "**linearisation**" (04) function group.

List of functions that are affected by a reset:

- |                         |                          |
|-------------------------|--------------------------|
| ■ tank shape (002)      | ■ customer unit (042)    |
| ■ empty calibr. (005)   | ■ diameter vessel (047)  |
| ■ full calibr. (006)    | ■ range of mapping (052) |
| ■ output on alarm (010) | ■ pres. Map dist (054)   |
| ■ output on alarm (011) | ■ offset (057)           |
| ■ outp. echo loss (012) | ■ low output limit (062) |
| ■ ramp %span/min (013)  | ■ fixed current (063)    |
| ■ delay time (014)      | ■ fixed cur. value (064) |
| ■ safety distance (015) | ■ simulation (065)       |
| ■ in safety dist. (016) | ■ simulation value (066) |
| ■ level/ullage (040)    | ■ format display (094)   |
| ■ linearisation (041)   | ■ distance unit (0C5)    |
|                         | ■ download mode (0C8)    |

The tank map can also be reset in the "**cust. tank map**" (055) function of the "**extended calibr.**" (05) function group.

This reset is recommended whenever an instrument with an unknown 'history' is to be used in an application or if a faulty mapping was started:

- The tank map is deleted. The mapping must be recommenced.

## 11.5 Function "unlock parameter" (0A4)

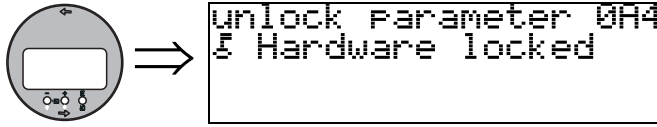

Set-up can be locked and unlocked with this function.

### 11.5.1 Locking of the configuration mode

The Micropilot can be protected in two ways against unauthorised changing of instrument data, numerical values or factory settings:

#### "unlock parameter" (0A4):

A value  $\langle \rangle$  100 (e.g. 99) must be entered in "unlock parameter" (0A4) in the "diagnostics" (0A) function group. The lock is shown on the display by the  symbol and can be released again either via the display or by communication.

#### Hardware lock:

The instrument is locked by pressing the **+** and **-** and **E** keys at the same time.

The lock is shown on the display by the  symbol and can **only** be unlocked again via the display by pressing the **+** and **-** and **E** keys at the same time again. It is **not** possible to unlock the hardware by communication.

All parameters can be displayed even if the instrument is locked.

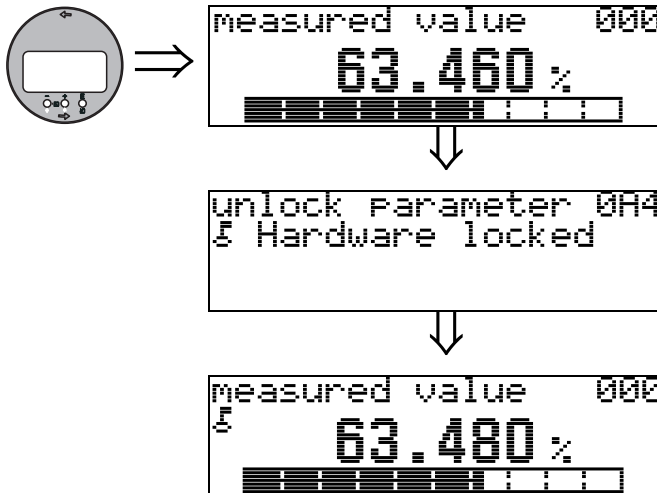

+ and - and E press simultaneous

The LOCK\_SYMBOL appears on the LCD.

### 11.5.2 Unlocking of configuration mode

If an attempt is made to change parameters when the instrument is locked, the user is automatically requested to unlock the instrument:

#### "unlock parameter" (0A4):

By entering the unlock parameter **100** the instrument is released for operation.

#### Hardware-Verriegelung:

After pressing the **+** and **-** and **E** keys at the same time, the user is asked to enter the unlock parameter: **100**

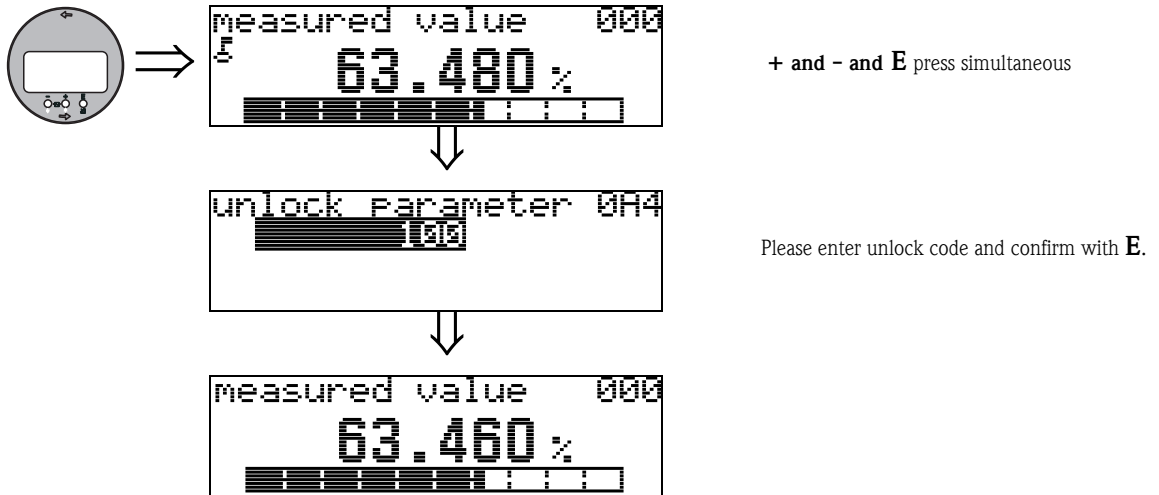

#### Caution!

Changing certain parameters such as all sensor characteristics, for example, influences numerous functions of the entire measuring system, particularly measuring accuracy. There is no need to change these parameters under normal circumstances and consequently, they are protected by a special code known only to the Endress+Hauser service organization. Please contact Endress+Hauser if you have any questions.

### 11.6 Function "measured dist." (0A5)

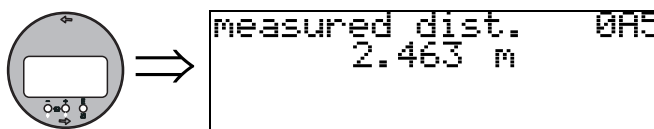

Display of measured distance in the selected "distance unit" (0C5).

### 11.7 Function "measured level" (0A6)

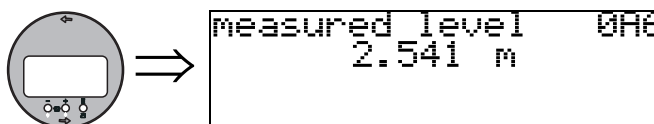

Display of measured level in the selected "distance unit" (0C5).

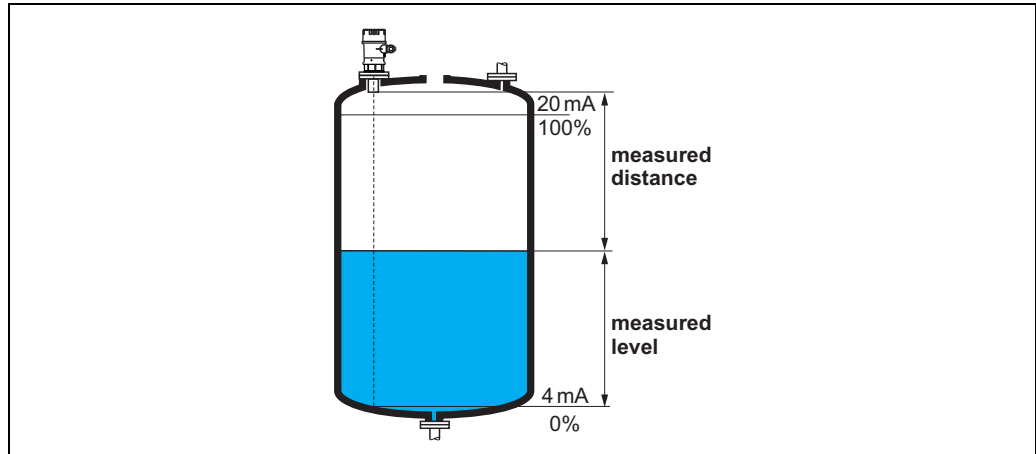

### 11.8 Function "detection window" (0A7)



Is used to switch the detection window on and off and to reset an existing detection window. If this function is switched on, a window is defined surrounding the current level echo (typical width: 1 to 2.5 m (3.3 - 8.2 ft); depending on the application parameters). The window always moves together with a rising a falling echo. Echos beyond the limits of the window are ignored for a certain time.

**Selection:**

- off
- on
- reset

After selection of this option, the current window is reset, the level echo is looked for in the complete measuring range and a new window is defined surrounding the current level echo.

## 11.9 Function "application par." (0A8)

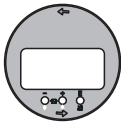

```
application par. 0A8
✓not modified
modified
```

Displays whether or not one of the settings dependent on the **"tank shape" (002)**, **"medium property" (003)** and **"process cond." (004)** application parameters has been changed or not.

If, for example, the **"output damping" (058)** is changed, the **"application par."** shows **"modified"**.

### Display:

- not modified
- modified

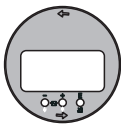

```
Return to
Group Selection
```



```
Group selection 0A8
diagnostics
system parameters
service
```

After 3 s, the following message appears





## 12 Function group "system parameters" (0C)



### 12.1 Function "tag no." (0C0)



You can define the tag number with this function.

**User input:**

- 16 alphanumeric characters

### 12.2 Function "protocol+sw-no." (0C2)

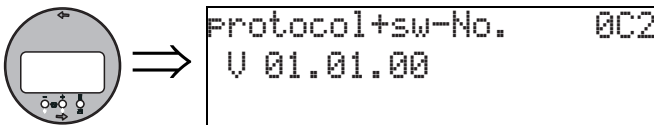

This function shows the protocol and the hardware and software version: Vxx.yy.zz.prot.

**Display:**

xx: hw-version

yy: sw-version

zz: sw-revision

### 12.3 Function "serial no." (0C4)



This function displays the instrument serial number.

## 12.4 Function "distance unit" (0C5)

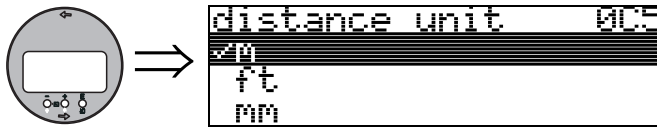

You can select the basic distance unit with this function.

### Selection:

- m
- ft
- mm
- inch

### Dependence

m, mm: **"format display" (094)** can only be **"decimal"**.

The units are changed for the following parameters:

- empty calibr. (005)
- full calibr. (006)
- safety distance (015)
- input level (044)
- diameter vessel (047)
- range of mapping (052)
- cust. tank map (055)
- offset (057)
- simulation value (066)
- measured dist. (0A5)
- measured level(0A6)

## 12.5 Function "temperature unit" (0C6)



In this function you select the temperature unit.

### Selection:

- °C
- °F

The unit is changed for the following functions

- Function **"measured temp." (030)**
- Function **"max. temp. limit" (031)**
- Function **"max. meas. temp" (032)**

## 12.6 Function "download mode" (0C8)

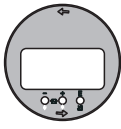

```
download mode 0C8
parameter only
param+cust.map
mapping only
```

This parameter defines which values are written to the instrument during a FieldCare configuration download.

### Selection:

- parameter only
- param+cust.map
- mapping only



### Note!

This parameter must not be described explicitly in FieldCare. The various possibilities can be selected from the download dialog.

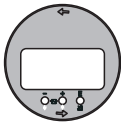

```
Return to
Group Selection
```



```
Group selection 0C8
system parameters
service
basic setup
```

After 3 s, the following message appears



## **13 Function group "service" (0D)**

This function group is reserved for service purposes only.



## 14 Signal evaluation

### 14.1 Envelope curve

The echo of an ultrasonic impulse does not only contain the desired echo from the product surface, but also interference echoes (e.g. from tank fittings or multiple reflections). In order to identify these echoes one plots the logarithmic amplitude of the echo versus the time-of-flight of the ultrasonic impulse. This plot is called **envelope curve**.

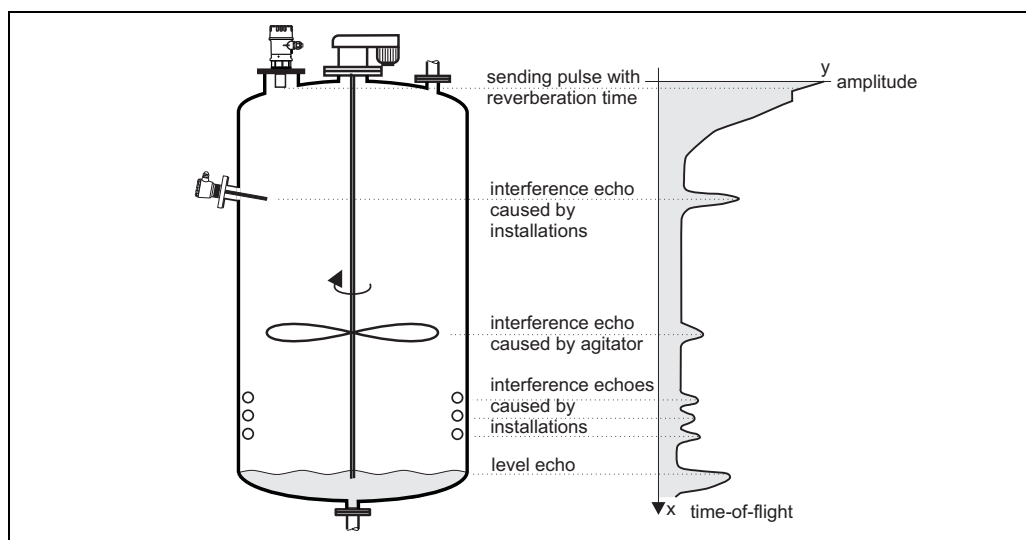

The envelope curve can be displayed in the **"envelope curve" (OE)** function group (see Page 52).

In the FieldCare the envelope curve may also be displayed in the "envelope" menu:

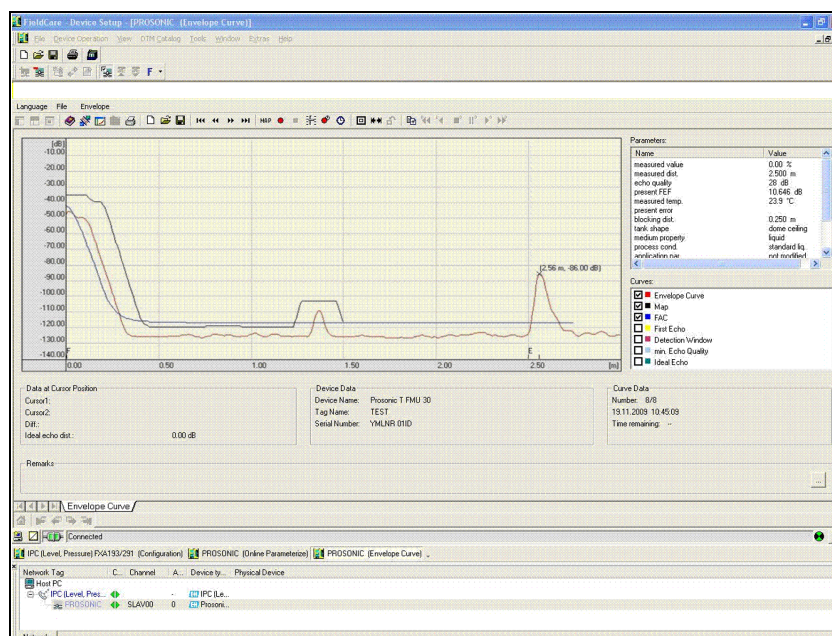

## 14.2 Interference echo suppression (tank mapping)

The interference echo suppression of the instrument makes sure that interference echoes are not interpreted as the level echo by fault.

In order to carry out the interference echo suppression one must record a time-of-flight dependent threshold (**TDT**), which is also called the **tank map**.

All maxima of the envelope curve which are situated below the TDT are discarded by the signal evaluation procedures.

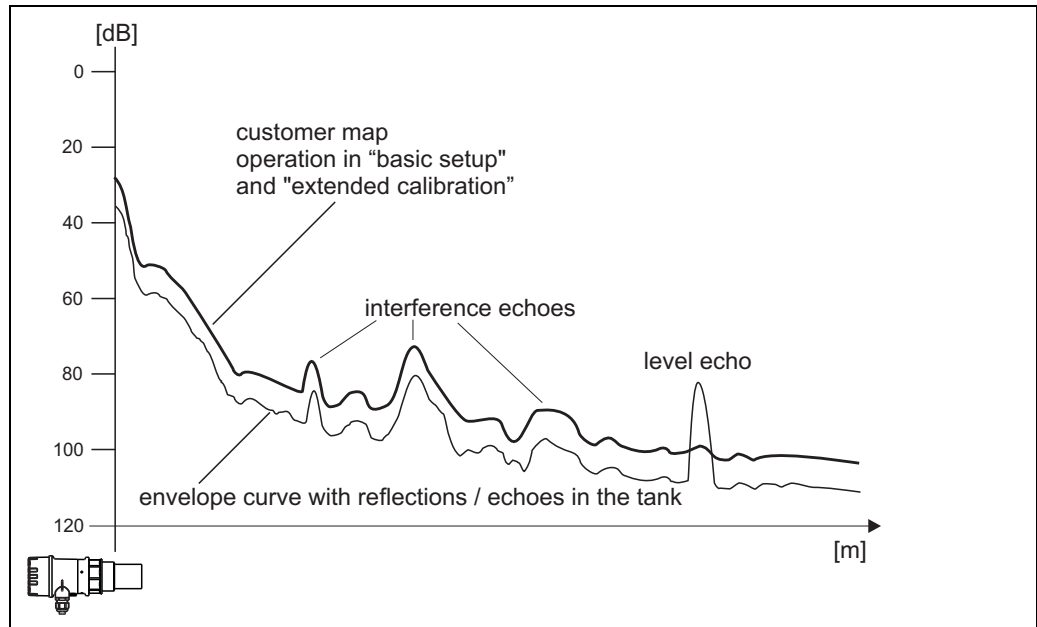

It is recommended to record the tank map when the vessel is as possible empty. Then, the map will include all echoes except the level echo.

But even, if it is not possible to empty the vessel during the commissioning of the instrument, you should perform the map. In this case it is recommended to repeat the record of the mapping at a later time - when the vessel is as possible empty.

The tank map is recorded in the function group "**extended calibration**" (05). Select the option "mapping" in the "**selection**" (050) function.



### 14.3 Floating Average Curve (FAC)

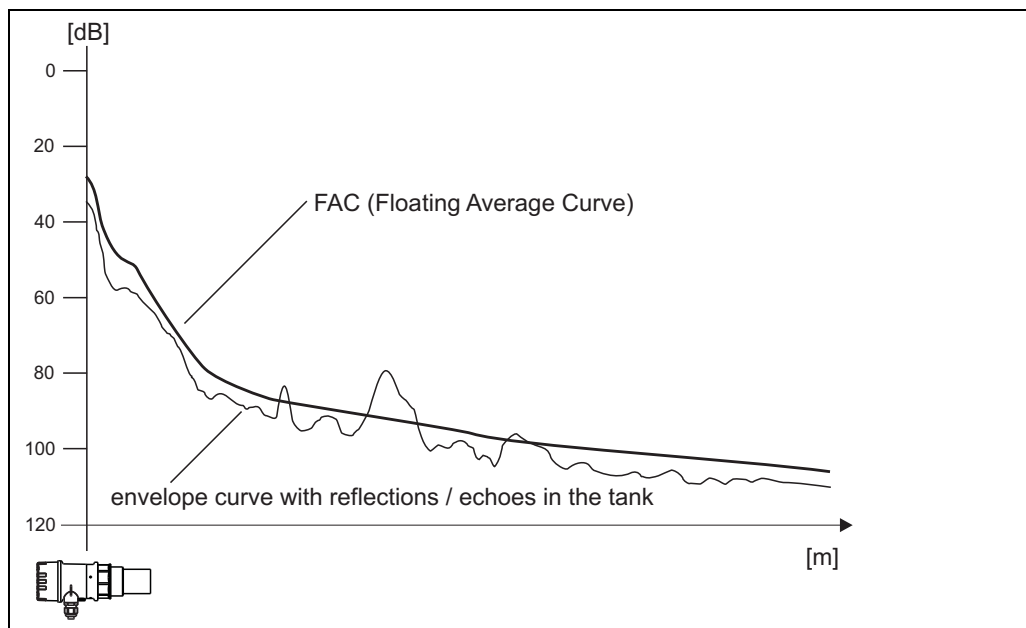

The function of the Floating Average Curve (FAC) is similar to the interference echo suppression. The main difference is, that the tank map is recorded only once whilst the FAC adjusts itself continuously to the changing measuring conditions.

By this procedure changes of the interference echoes (e.g. by build-up) can be compensated for.

In contrast to the tank map, the FAC can only register small interference echoes.

The FAC is always used in the signal evaluation, even if the tank map has been deactivated.

In the envelope curve, the maximum with the largest distance to the FAC is interpreted as the level echo.



## 15 Trouble shooting

### 15.1 System error messages

#### Current error



Errors which the instrument detects during commissioning or operation are displayed:

- In the **"measured value" (000)** function
- In the **"diagnostics" (0A)** function group in the **"present error" (0A0) function** (only the highest priority error is displayed; in the case of multiple errors, you can scroll between the different error messages by pressing **+ or -**.)

#### Last error

The last error is displayed in the **"diagnostics" (0A)** function group in the **"previous error" (0A1) function**. This display can be deleted in the **"clear last error" (0A2) function**.

#### Types of errors

Type of error	Symbol	Meaning
Alarm (A)	 Continuous	The output signal assumes a value which can be set using the "output on alarm" <b>(010)</b> function: <ul style="list-style-type: none"> <li>■ MAX: 110%, 22mA</li> <li>■ MIN: -10%, 3.8mA</li> <li>■ Hold: last value is on hold</li> <li>■ User-specific value</li> </ul>
Warning (W)	 Flashing	The device continues measurement. An error message is displayed.
Alarm/Warning (E)	You can define whether the error should behave as an alarm or as a warning.	

## Error codes



Code	Error description (on the display)	Action
A101 A102 A110 A152 A160	checksum error	Reset; If alarm still present after reset, replace electronics
W103	initialising	If the message does not disappear after several seconds, replace the electronics
A106	downloading	Wait Message disappears after load sequence
A111 A113 A114 A115 A121 A125 A155 A164 A171	electronics defect	Reset; Check system for EMC, improve as necessary If alarm still present after reset, replace electronics
A116	download error	Check connection Restart download
W153	initialising	Wait a few seconds; if error is still displayed, switch the power off and on again
A231	sensor defect	Check connection, if necessary replace HF module or electronics
A281	interruption temperature sensor	Exchange sensor
A502	Sensor type not detected	Exchange sensor and/or electronics
A521	new sensor type detected	Reset
W511	no factory calibration	Carry out factory calibration
W512	recording of mapping	Alarm disappears after a few seconds
W601	linearisation curve not monotone	Correct table (enter monotonously increasing table)
W611	less than 2 linearisation points	Enter additional value pairs
W621	simulation on	Switch simulation mode off ["output" (06) function group, "simulation" (065) function]
E641	no usable echo	Check basic calibration (see Page 26)
E651	level in safety distance - risk of overspill	Error disappears when the level leaves the safety distance. Possibly reset the lock. ["safety settings" (01) function group, "ackn. alarm" (017) function]
A661	Sensor overtemperature	
A671	Linearisation incomplete	Activate linearisation table
W681	current out of range	Carry out basic calibration; check linearisation
W691	Filling noise detected, level ramp is active	

## 15.2 Application errors

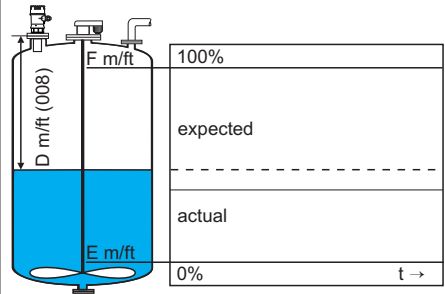
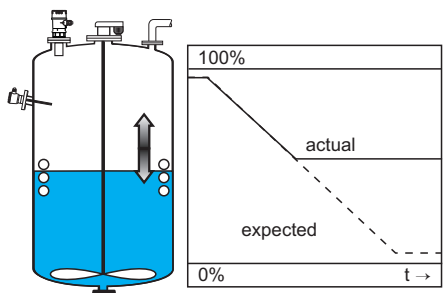
Error	Output	Possible cause	Elimination
<b>A warning or alarm is present.</b>	Depending on the configuration	See Error Codes table (Page 76)	1. See Error Codes table (Page 76)
<b>Measured value (00) is incorrect</b>		Measured distance (008) OK?	yes → 1. Check empty calibration (005) and full calibration (006). 2. Check linearisation: → level/ullage (040) → max. scale(046) → diameter vessel(047) → Check table
		no ↓ Measurement in bypass or stilling well?	yes → 1. In tank shape(002) is bypass or stilling well selected?
		no ↓ An interference echo might be under evaluation.	yes → 1. Carry out interference echo suppression → basic setup
<b>No change in measured value on filling/emptying</b>		Interference echoes from fixings, nozzles or build-up on sensor membrane	1. Carry out interference echo suppression → basic setup 2. Clean sensor if necessary 3. If necessary, select better installation position. 4. If necessary due to wide interference echoes, set function "detection window" (0A7) to "off".

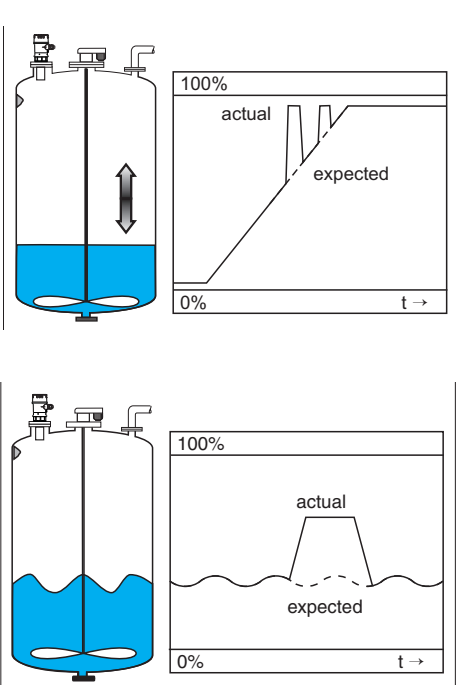
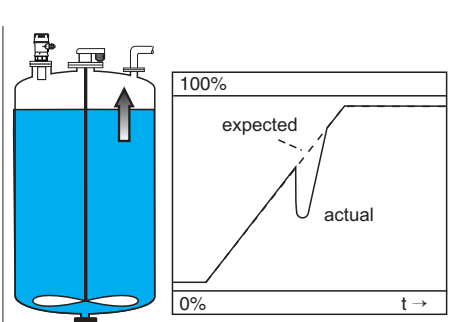
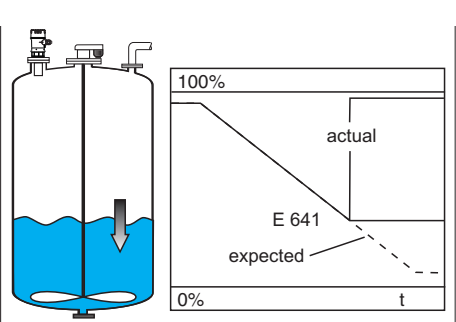
Error	Output	Possible cause	Elimination
<p>With an uneven surface (e.g. filling, emptying, running agitator) the measured value may jump sporadically to higher levels</p>		<p>Signal is weakened by uneven surface — periodically interference echos, e.g. from internals, are stronger</p>	<ol style="list-style-type: none"> <li>1. Carry out interference echo suppression → basic setup</li> <li>2. Set the process cond. (004) to "calm surface" or "add. agitator"</li> <li>3. Increase output damping (058)</li> <li>4. If necessary, select a different installation position and/or a larger sensor</li> </ol>
<p>On filling/emptying the measured value drops</p>		<p>Multiple echos</p>	<p>yes →</p> <ol style="list-style-type: none"> <li>1. Check tank shape (002), e.g. "dome ceiling" or "horizontal cyl."</li> <li>2. In the blocking distance range (059) there is no echo evaluation</li> <li>3. If possible, do not select a central installation position</li> <li>4. Possible user stilling well/echo guide pipe</li> </ol>
<p>E 641 (echo loss)</p>		<p>Level echo is too weak. Possible causes:</p> <ul style="list-style-type: none"> <li>■ Uneven surface through filling/emptying</li> <li>■ Active agitator</li> <li>■ Foam</li> <li>■ Sensor not aligned parallel to product surface</li> </ul>	<p>yes →</p> <ol style="list-style-type: none"> <li>1. Check application parameters (002), (003) and (004)</li> <li>2. If necessary, select a different installation position and/or a larger sensor</li> <li>3. Align the sensor parallel to the product surface (particularly for bulk solids applications)</li> </ol>

## Index function menu

### Function group

00 = basic setup	15
01 = safety settings	23
03 = temperature	31
04 = linearisation	33
05 = extended calibr.	41
06 = output	47
09 = display	55
0A = diagnostics	57
0C = system parameter	65
0E = envelope curve	51

### Function

000 = measured value.	15
002 = tank shape	15
003 = medium property	16
004 = process cond.	16
005 = empty calibr.	18
006 = full calibr.	19
008 = display	19
010 = output on alarm	23
011 = output on alarm	24
012 = outp. echo loss	25
013 = ramp %span/min	26
014 = delay time.	26
015 = safety distance.	27
016 = in safety dist.	27
017 = ackn. alarm.	29
030 = measured temperature	31
031 = max. temp. limit	31
032 = max. meas. temp.	31
033 = react. high temp	32
034 = defect temp. sens.	32
040 = level/ullage	33
041 = linearisation	34
042 = customer unit	38
043 = table no.	39
044 = input level	39
045 = input volume	40
046 = max. scale.	40
047 = diameter vessel	40
050 = selection	41

051 = check distance.	41
052 = range of mapping.	42
053 = start mapping	42
054 = pres. map dist.	43
055 = cust. tank map.	44
056 = echo quality	44
057 = offset.	45
058 = output damping.	45
059 = blocking dist.	45
062 = thres. main val.	47
063 = fixed current	48
064 = fixed cur. value	48
065 = simulation.	49
066 = simulation value	50
067 = output current.	50
092 = language	55
093 = back to home	55
094 = format display	56
095 = no.of decimals.	56
096 = sep. character	56
097 = display test	56
0A0 = present error.	58
0A1 = previous error	58
0A2 = clear last error.	58
0A3 = reset	59
0A4 = unlock parameter	60
0A5 = measured dist.	61
0A6 = measured level	61
0A7 = detection window.	62
0A8 = application par.	63
0C0 = tag no.	65
0C2 = protocol+sw-no.	65
0C4 = serial no.	65
0C5 = distance unit.	66
0C6 = temperature unit.	66
0C8 = download mode	67
0E1 = plot settings.	51
0E2 = recording curve	51
0E3 = envelope curve	52
D00 = service level	69

[www.endress.com/worldwide](http://www.endress.com/worldwide)

---

**Endress+Hauser** 

People for Process Automation

---

BA00388F/00/EN/14.14  
71244274  
FM10

